

FCC Test Report

Report No.: RFBEFM-WTW-P23080329

FCC ID: ARS-BGT60LTR11

Test Model: NN86G23

Received Date: 2023/8/15

Test Date: 2023/9/12 ~ 2023/11/17

Issued Date: 2023/11/17

Applicant: TOP VICTORY ELECTRONICS (TAIWAN) CO., LTD.

Address: 10F, No.230, Liancheng Rd., Zhonghe City, Taipei County23553, Taiwan

Issued By: Bureau Veritas Consumer Products Services (H.K.) Ltd., Taoyuan Branch
Lin Kou Laboratories

Lab Address: No. 47-2, 14th Ling, Chia Pau Vil., Lin Kou Dist., New Taipei City, Taiwan

Test Location (1): No. 19, Hwa Ya 2nd Rd., Wen Hwa Vil., Kwei Shan Dist., Taoyuan City
33383, Taiwan

FCC Registration /

Designation Number (1): 788550 / TW0003

Test Location (2): No. 70, Wenming Rd., Guishan Dist., Taoyuan City 333, Taiwan (R.O.C.)

FCC Registration /

Designation Number (2): 281270 / TW0032



This report is governed by, and incorporates by reference, the Conditions of Testing as posted at the date of issuance of this report at <http://www.bureauveritas.com/home/about-us/our-business/cps/about-us/terms-conditions/> and is intended for your exclusive use. Any copying or replication of this report to or for any other person or entity, or use of our name or trademark, is permitted only with our prior written permission. This report sets forth our findings solely with respect to the test samples identified herein. The results set forth in this report are not indicative or representative of the quality or characteristics of the lot from which a test sample was taken or any similar or identical product unless specifically and expressly noted. Our report includes all of the tests requested by you and the results thereof based upon the information that you provided to us. Measurement uncertainty is only provided upon request for accredited tests. Statements of conformity are based on simple acceptance criteria without taking measurement uncertainty into account, unless otherwise requested in writing. You have 60 days from date of issuance of this report to notify us of any material error or omission caused by our negligence or if you require measurement uncertainty; provided, however, that such notice shall be in writing and shall specifically address the issue you wish to raise. A failure to raise such issue within the prescribed time shall constitute your unqualified acceptance of the completeness of this report, the tests conducted and the correctness of the report contents.

Table of Contents

Release Control Record	4
1 Certificate of Conformity	5
2 Summary of Test Results	6
2.1 Measurement Uncertainty.....	6
2.2 Modification Record.....	6
3 General Information	7
3.1 General Description of EUT.....	7
3.2 Description of Test Modes.....	7
3.2.1 Test Mode Applicability and Tested Channel Detail.....	8
3.3 Description of Support Units.....	10
3.3.1 Configuration of System under Test.....	10
3.4 General Description of Applied Standards.....	11
4 Test Types and Results	12
4.1 Radiated Emission Measurement.....	12
4.1.1 Limits of Radiated Emission Measurement.....	12
4.1.2 Test Instruments.....	13
4.1.3 Test Procedures.....	15
4.1.4 Deviation from Test Standard.....	16
4.1.5 Test Setup.....	17
4.1.6 EUT Operating Conditions.....	18
4.1.7 Test Results.....	19
4.2 Conducted Emission Measurement.....	29
4.2.1 Limits of Conducted Emission Measurement.....	29
4.2.2 Test Instruments.....	29
4.2.3 Test Procedures.....	30
4.2.4 Deviation from Test Standard.....	30
4.2.5 Test Setup.....	30
4.2.6 EUT Operating Conditions.....	30
4.2.7 Test Results.....	31
4.3 6dB Bandwidth Measurement.....	33
4.3.1 Limits of 6dB Bandwidth Measurement.....	33
4.3.2 Test Setup.....	33
4.3.3 Test Instruments.....	33
4.3.4 Test Procedure.....	34
4.3.5 Deviation from Test Standard.....	34
4.3.6 EUT Operating Conditions.....	34
4.3.7 Test Result.....	35
4.4 Occupied Bandwidth Measurement.....	36
4.4.1 Limits of Occupied Bandwidth Measurement.....	36
4.4.2 Test Setup.....	36
4.4.3 Test Instruments.....	36
4.4.4 Test Procedure.....	37
4.4.5 Deviation from Test Standard.....	37
4.4.6 EUT Operating Conditions.....	37
4.4.7 Test Result.....	38
4.5 Output Power Measurement.....	39
4.5.1 Limits of Output Power Measurement.....	39
4.5.2 Test Setup.....	39
4.5.3 Test Instruments.....	39
4.5.4 Test Procedures.....	40
4.5.5 Deviation from Test Standard.....	40
4.5.6 EUT Operating Conditions.....	40
4.5.7 Test Results.....	41

4.6	Frequency Stability Measurement	42
4.6.1	Limits of Frequency Stability Measurement	42
4.6.2	Test Setup.....	42
4.6.3	Test Instruments	43
4.6.4	Test Procedure	43
4.6.5	Deviation from Test Standard	43
4.6.6	EUT Operating Condition	43
4.6.7	Test Results	44
5	Pictures of Test Arrangements.....	45
	Appendix – Information of the Testing Laboratories	46

Release Control Record

Issue No.	Description	Date Issued
RFBEFM-WTW-P23080329	Original release.	2023/11/17

1 Certificate of Conformity

Product: IWB

Brand: NodesNow

Test Model: NN86G23

Sample Status: Engineering sample

Applicant: TOP VICTORY ELECTRONICS (TAIWAN) CO., LTD.

Test Date: 2023/9/12 ~ 2023/11/17

Standards: 47 CFR FCC Part 15, Subpart C (Section 15.255)
ANSI C63.10-2020

The above equipment has been tested by **Bureau Veritas Consumer Products Services (H.K.) Ltd., Taoyuan Branch**, and found compliance with the requirement of the above standards. The test record, data evaluation & Equipment Under Test (EUT) configurations represented herein are true and accurate accounts of the measurements of the sample's RF characteristics under the conditions specified in this report.

Prepared by :  , **Date:** 2023/11/17
Polly Chien / Specialist

Approved by :  , **Date:** 2023/11/17
Jeremy Lin / Project Engineer

2 Summary of Test Results

47 CFR FCC Part 15, Subpart C (Section 15.255)			
FCC Clause	Test Item	Result	Remarks
15.207	AC Power Conducted Emission	Pass	Meet the requirement of limit. Minimum passing margin is -12.95 dB at 6.07400 MHz.
15.255(e)	6dB Bandwidth	-	Reference only.
15.255(c)(2)(v)	Occupied Bandwidth	Pass	Meet the requirement of limit
15.255 (c)(2)(v)	Output Power	Pass	Meet the requirement of limit.
15.255(d) 15.205 15.209	Spurious Emissions	Pass	Meet the requirement of limit. Minimum passing margin is -0.1 dB at 589.69 MHz.
15.255(f)	Frequency Stability	Pass	Meet the requirement of limit.

Note: Determining compliance based on the results of the compliance measurement, not taking into account measurement instrumentation uncertainty.

2.1 Measurement Uncertainty

Where relevant, the following measurement uncertainty levels have been estimated for tests performed on the EUT as specified in CISPR 16-4-2:

Measurement	Frequency	Expanded Uncertainty
		(k=2) (\pm)
Conducted Emissions at mains ports	150kHz ~ 30MHz	2.79 dB
Radiated Emissions	9kHz ~ 30MHz	3.04 dB
	30MHz ~ 200MHz	3.59 dB
	200MHz ~ 1000MHz	3.60 dB
	1GHz ~ 18GHz	2.29 dB
	18GHz ~ 40GHz	2.29 dB
	40GHz ~ 66GHz	4.59 dB
	66GHz ~ 100GHz	5.37 dB
	Above 100GHz	5.40 dB

2.2 Modification Record

There were no modifications required for compliance.

3 General Information

3.1 General Description of EUT

Product	IWB
Brand	NodesNow
Test Model	NN86G23
Status of EUT	Engineering sample
Power Supply Method	100-240Vac, 8A, 50-60Hz
Modulation Type	OOK
Modulation Technology	Digital
Operating Frequency	61.1 GHz
Output Power (EIRP)	61.1 GHz: 5.26dBm (PK)
Antenna Type	Refer to Note
Antenna Connector	Refer to Note
Accessory Device	3m non-shielded power cable w/o core
Data Cable Supplied	NA

Note:

1. The following module can be chosen to be configured in the End-product.

Product	Brand Name	Model No. / Specification	
Radar sensor module	TPV	BGT60LTR11AIP	61 ~ 61.5 GHz

2. The antennas type and connector type, please refer to the following table:

Antenna type	Frequency Range (GHz)	Antenna Net Gain (dBi)	Connector Type
On chip patch	61 ~ 61.5	5	NA

*Detail antenna specification please refer to antenna datasheet and/or antenna measurement report.

3. The above EUT information is declared by manufacturer and for more detailed features description, please refer to the manufacturer's specifications or user's manual.

3.2 Description of Test Modes

1 channel is provided for EUT.

Channel's Number	1
Frequency (GHz)	61.10

3.2.1 Test Mode Applicability and Tested Channel Detail

EUT CONFIGURE MODE	APPLICABLE TO							DESCRIPTION
	PLC	BW	OBW	OP	FS	RE < 1G	RE ≥ 1G	
-	√	√	√	√	√	√	√	-

Where **PLC**: Power Line Conducted Emission **BW**: 6dB Bandwidth
OBW: Occupied bandwidth **OP**: Output Power
FS: Frequency Stability **RE < 1G**: Radiated Emission below 1GHz
RE ≥ 1G: Radiated Emission above 1GHz

Note: The EUT was positioned on the X-plane during testing.

Power Line Conducted Emission Test:

- Pre-Scan has been conducted to determine the worst-case mode from all possible combinations between available modulations, data rates and antenna ports (if EUT with antenna diversity architecture).
- Following channel(s) was (were) selected for the final test as listed below.

AVAILABLE CHANNEL	TESTED CHANNEL	MODULATION TECHNOLOGY	MODULATION TYPE
1	1	Digital	OOK

6dB Bandwidth Test:

- Pre-Scan has been conducted to determine the worst-case mode from all possible combinations between available modulations, data rates and antenna ports (if EUT with antenna diversity architecture).
- Following channel(s) was (were) selected for the final test as listed below.

AVAILABLE CHANNEL	TESTED CHANNEL	MODULATION TECHNOLOGY	MODULATION TYPE
1	1	Digital	OOK

Occupied Bandwidth Test:

- Pre-Scan has been conducted to determine the worst-case mode from all possible combinations between available modulations, data rates and antenna ports (if EUT with antenna diversity architecture).
- Following channel(s) was (were) selected for the final test as listed below.

AVAILABLE CHANNEL	TESTED CHANNEL	MODULATION TECHNOLOGY	MODULATION TYPE
1	1	Digital	OOK

Output Power Measurement:

- Pre-Scan has been conducted to determine the worst-case mode from all possible combinations between available modulations, data rates and antenna ports (if EUT with antenna diversity architecture).
- Following channel(s) was (were) selected for the final test as listed below.

AVAILABLE CHANNEL	TESTED CHANNEL	MODULATION TECHNOLOGY	MODULATION TYPE
1	1	Digital	OOK

Frequency Stability Test:

Following channel(s) was (were) selected for the final test as listed below.

AVAILABLE CHANNEL	TESTED CHANNEL	MODULATION TECHNOLOGY	MODULATION TYPE
1	1	Digital	OOK

Radiated Emission Test (Below 1GHz):

Pre-Scan has been conducted to determine the worst-case mode from all possible combinations between available modulations, data rates and antenna ports (if EUT with antenna diversity architecture).

Following channel(s) was (were) selected for the final test as listed below.

AVAILABLE CHANNEL	TESTED CHANNEL	MODULATION TECHNOLOGY	MODULATION TYPE
1	1	Digital	OOK

Radiated Emission Test (Above 1GHz):

Pre-Scan has been conducted to determine the worst-case mode from all possible combinations between available modulations, data rates and antenna ports (if EUT with antenna diversity architecture).

Following channel(s) was (were) selected for the final test as listed below.

AVAILABLE CHANNEL	TESTED CHANNEL	MODULATION TECHNOLOGY	MODULATION TYPE
1	1	Digital	OOK

Test Condition:

APPLICABLE TO	ENVIRONMENTAL CONDITIONS	INPUT POWER	TESTED BY
PLC	23 deg. C, 67 %RH	120Vac, 60Hz	Vincent Chen
BW	25 deg. C, 60 %RH	120Vac, 60Hz	Wade Huang
OBW	25 deg. C, 60 %RH	120Vac, 60Hz	Wade Huang
OP	25 deg. C, 60 %RH	120Vac, 60Hz	Wade Huang
FS	25 deg. C, 60 %RH	120Vac, 60Hz	Wade Huang
RE<1G	23 deg. C, 67 %RH	120Vac, 60Hz	Tim Chen
RE≥1G	22 deg. C, 67 %RH	120Vac, 60Hz	Wade Huang

3.3 Description of Support Units

The EUT has been tested as an independent unit together with other necessary accessories or support units. The following support units or accessories were used to form a representative test configuration during the tests.

ID	Product	Brand	Model No.	Serial No.	FCC ID	Remarks
A.	Monitor	Dell	A14S2421HSXmTW	CN-01KFWF-WSL00-24C-714B	NA	Provided by Lab
B.	Blue-Ray Player	SONY	BDP-S360	1005850	NA	Provided by Lab
C.	Earphone	PHILIPS	SBC HL150	NA	NA	Provided by Lab
D.	Microphone	Labtec	LVA7313	NA	NA	Provided by Lab
E.	Load	BV-ADT	NA	NA	NA	Provided by Lab

Note:

- All power cords of the above support units are non-shielded (1.8m).

ID	Descriptions	Qty.	Length (m)	Shielding (Yes/No)	Cores (Qty.)	Remarks
1.	HDMI Cable	1	3	Y	0	Supplied by applicant
2.	HDMI Cable	1	1.8	Y	0	Provided by Lab
3.	Earphone Cable	1	1.5	N	0	Provided by Lab
4.	Auto Cable	1	2	N	0	Provided by Lab
5.	RJ 45 Cable	1	1.5	N	0	Provided by Lab
6.	Power Cable	1	3	N	0	Accessory of EUT

3.3.1 Configuration of System under Test

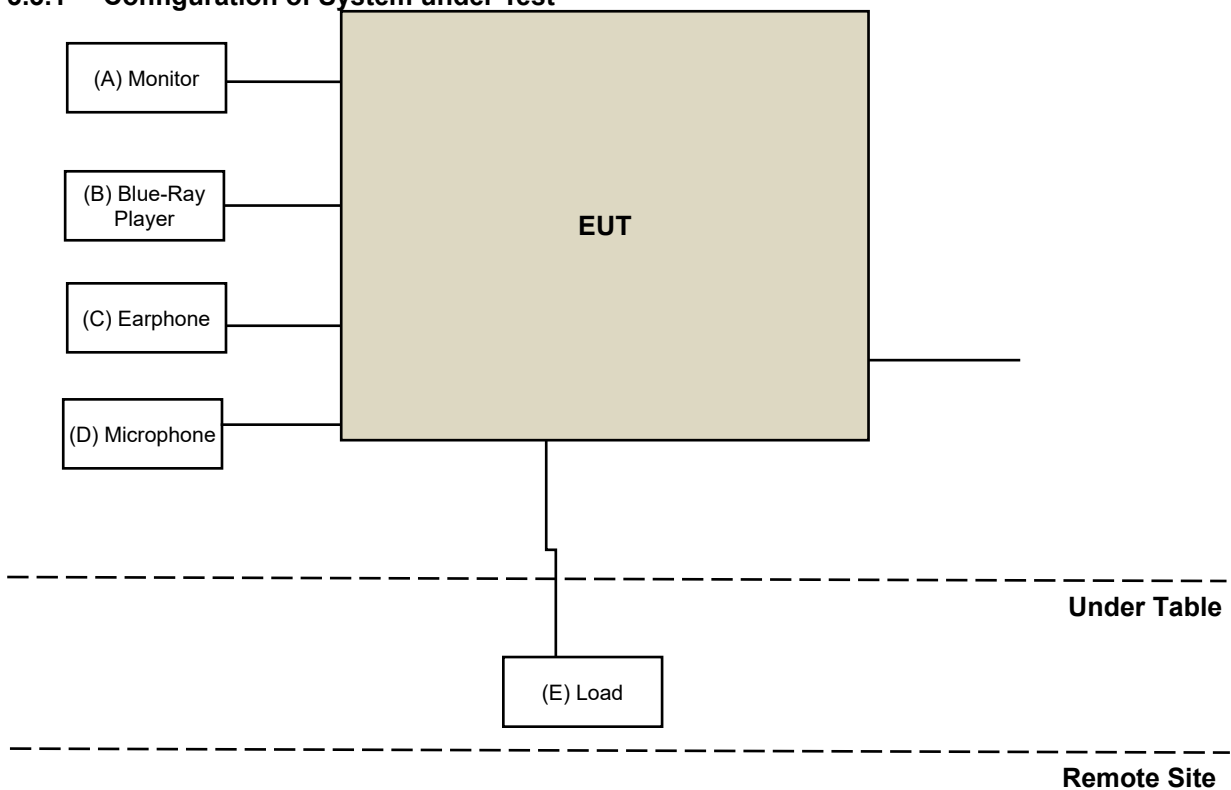

3.4 General Description of Applied Standards

The EUT is a RF Product. According to the specifications of the manufacturer, it must comply with the requirements of the following standards:

FCC Part 15, Subpart C (15.255)

ANSI C63.10-2020

All test items have been performed and recorded as per the above standards.

4 Test Types and Results

4.1 Radiated Emission Measurement

4.1.1 Limits of Radiated Emission Measurement

Spurious Emission	
Frequency Range	Limitation
Radiated emissions below 40GHz	Part 15.209
Between 40GHz and 200GHz	90pW/cm ² (at 3 meter)

Note: The levels of the spurious emissions shall not exceed the level of the fundamental emission.

Emissions radiated outside of the specified bands, shall be according to the general radiated limits in 15.209 as following:

Frequencies (MHz)	Field strength (microvolts/meter)	Measurement distance (meters)
0.009-0.490	2400/F(kHz)	300
0.490-1.705	24000/F(kHz)	30
1.705-30.0	30	30
30-88	100	3
88-216	150	3
216-960	200	3
Above 960	500	3

Note:

1. The lower limit shall apply at the transition frequencies.
2. Emission level (dBuV/m) = 20 log Emission level (uV/m).
3. As shown in 15.35(b), for frequencies above 1000MHz, the field strength limits are based on average detector, however, the peak field strength of any emission shall not exceed the maximum permitted average limits, specified above by more than 20dB under any condition of modulation.
4. Section 15.205 restricted bands of operation shall compliance with the limits in Section 15.209.

4.1.2 Test Instruments

For Below 40GHz and Frequency Stability

Description & Manufacturer	Model No.	Serial No.	Cal. Date	Cal. Due
Test Receiver Rohde & Schwarz	ESR3	102579	Jul. 04, 2023	Jul. 03, 2024
Spectrum Analyzer KEYSIGHT	N9020B	MY60110462	Mar. 07, 2023	Mar. 06, 2024
BILOG Antenna SCHWARZBECK	VULB9168	9168-995	Oct. 16, 2023	Oct. 15, 2024
			Oct. 20, 2022	Oct. 19, 2023
HORN Antenna SCHWARZBECK	BBHA 9120 D	9120D-404	Nov. 13, 2022	Nov. 12, 2023
HORN Antenna SCHWARZBECK	BBHA 9170	995	Nov. 13, 2022	Nov. 12, 2023
Loop Antenna EMCI	EM-6879	269	Sep. 23, 2023	Sep. 22, 2024
Preamplifier EMCI	EMC330N	980783	Jan. 16, 2023	Jan. 15, 2024
Preamplifier EMCI	EMC118A45SE	980810	Dec. 29, 2022	Dec. 28, 2023
Preamplifier EMCI	EMC184045SE	980787	Jan. 16, 2023	Jan. 15, 2024
RF signal cable EMCI	EMC104-SM-SM-(9000+2000+1000)	201230+ 201242+ 210101	Jan. 16, 2023	Jan. 15, 2024
RF signal cable EMCI	EMCCFD400-NM-NM-(9000+300+500)	201252+ 201250+ 201245	Jan. 16, 2023	Jan. 15, 2024
RF signal cable EMCI	EMC101G-KM-KM-(5000+3000+2000)	201261+201258+ 201249	Jan. 16, 2023	Jan. 15, 2024
Software BV CPS	ADT_Radiated_V7.6.15.9.5	NA	NA	NA
Turn Table Max-Full	MFT-151SS-0.5T	NA	NA	NA
Turn Table Controller Max-Full	MF-7802BS	MF780208675	NA	NA
Antenna Tower KaiTuo	NA	NA	NA	NA
Antenna Tower Controller KaiTuo	KT-2000	NA	NA	NA
Boresight Antenna Fixture	FBA-01	FBA-SIP01	NA	NA
Temperature & Humidity Chamber Terchy	MHU-225AU	920842	Jun. 17, 2023	Jun. 16, 2024
Digital Storage Oscilloscope Keysight	DSO-X 6004A	MY55190202	Jun. 20, 2023	Jun. 19, 2024

- Note: 1. The calibration interval of the above test instruments is 12 months and the calibrations are traceable to NML/ROC and NIST/USA.
 2. The test was performed in WM Chamber 7.
 3. Test date: Oct. 03 ~ Oct. 31, 2023

For Above 40GHz:

Description & Manufacturer	Model No.	Serial No.	Cal. Date	Cal. Due
Spectrum Analyzer Keysight	N9030A	MY55330160	Feb. 07, 2023	Feb. 06, 2024
OXE89 Horn Antenna (33~55GHz) QuinStar	QWH-UCRR00	QWH-QPRR00-2	Apr. 25, 2023	Apr. 24, 2024
Conical Horn Antenna (50~75GHz) Keysight	WR15CH-Conical	RCH015RL-2	Apr. 25, 2023	Apr. 24, 2024
Conical Horn Antenna (75~110GHz) Keysight	WR10CH-Conical	RCH010RL-2	Apr. 25, 2023	Apr. 24, 2024
Conical Horn Antenna (110~170GHz) Keysight	WR6.5CH-Conical	RCH06RL-1	Apr. 25, 2023	Apr. 24, 2024
N9029AV15-DC9 - 50-75 GHz VDI Standard Downconverter with 9VDC supply Keysight	SA Extension WR15	SAX 381	Apr. 25, 2023	Apr. 24, 2024
N9029AV10-DC9 - 75-110 GHz VDI Standard Downconverter with 9VDC supply Keysight	SA Extension WR10	SAX 378	Apr. 25, 2023	Apr. 24, 2024
N9029AV06-DC9 - 110-170 GHz VDI Standard Downconverter with 9VDC supply Keysight	SA Extension WR6.5	SAX 377	Apr. 25, 2023	Apr. 24, 2024
Millimeter-Wave Signal Generator Frequency Extension Module (50~75 GHz) Keysight	E8257DV15	SGX 050	NA	NA
Millimeter-Wave Signal Generator Frequency Extension Module (75~110 GHz) Keysight	E8257DV10	SGX 069	NA	NA
Millimeter-Wave Signal Generator Frequency Extension Module (110~170 GHz) Keysight	E8257DV06-DC9	SGX 223	Apr. 25, 2023	Apr. 24, 2024
Millimeter-Wave Signal Generator Frequency Extension Module (140~220 GHz)	VDIWR5.1SGX	PSGX 007	Apr. 25, 2023	Apr. 24, 2024
PSG analog signal generator Keysight	E8257D	MY53401987	Jan. 11, 2023	Jan. 10, 2024
Antenna Tower & Turn Table CT	NA	NA	NA	NA
*Power Meter VDI	PM5	431V	Apr. 25, 2023	Apr. 24, 2024
*Extension Module_up converter VDI	E8257DV05	SGX644	Feb. 11, 2021	Feb. 10, 2024
*Extension Module_up converter VDI	E8257DV03	SGX643	Feb. 11, 2021	Feb. 10, 2024
*Power Meter VDI	PM5B	571V	Feb. 11, 2021	Feb. 10, 2024

Note:

1. The calibration interval of the above test instruments is 12 months and the calibrations are traceable to NML/ROC and NIST/USA.
2. *The calibration interval of the above test instruments is 36 months and the calibrations are traceable to NML/ROC and NIST/USA.
3. The test was performed in WM Chamber 7.
4. Test date: Oct. 30, 2023

4.1.3 Test Procedures

For Radiated emission below 30MHz

- a. The EUT was placed on the top of a rotating table 0.8 meters above the ground at a 3 meter chamber room. The table was rotated 360 degrees to determine the position of the highest radiation.
- b. The EUT was set 3 meters away from the interference-receiving antenna, which was mounted on the top of a variable-height antenna tower.
- c. Parallel, perpendicular, and ground-parallel orientations of the antenna are set to make the measurement.
- d. For each suspected emission, the EUT was arranged to its worst case and the rotatable table was turned from 0 degrees to 360 degrees to find the maximum reading.
- e. The test-receiver system was set to Quasi-Peak Detect Function and Specified Bandwidth with Maximum Hold Mode.

Note:

1. The resolution bandwidth and video bandwidth of test receiver/spectrum analyzer is 9kHz at frequency below 30MHz.

For Radiated emission 30MHz to 40GHz

- a. The EUT was placed on the top of a rotating table 0.8 meters (for 30MHz ~ 1GHz) / 1.5 meters (for above 1GHz) above the ground at 3 meter chamber room for test. The table was rotated 360 degrees to determine the position of the highest radiation.
- b. The EUT was set 3 meters away from the interference-receiving antenna, which was mounted on the top of a variable-height antenna tower.
- c. The height of antenna is varied from one meter to four meters above the ground to determine the maximum value of the field strength. Both horizontal and vertical polarizations of the antenna are set to make the measurement.
- d. For each suspected emission, the EUT was arranged to its worst case and then the antenna was tuned to heights from 1 meter to 4 meters and the rotatable table was turned from 0 degrees to 360 degrees to find the maximum reading.
- e. The test-receiver system was set to quasi-peak detect function and specified bandwidth with maximum hold mode when the test frequency is below 1 GHz.
- f. The test-receiver system was set to peak and average detects function and specified bandwidth with maximum hold mode when the test frequency is above 1 GHz. If the peak reading value also meets average limit, measurement with the average detector is unnecessary.

Note:

1. The resolution bandwidth and video bandwidth of test receiver/spectrum analyzer is 120kHz for Quasi-peak detection (QP) at frequency below 1GHz.
2. The resolution bandwidth of test receiver/spectrum analyzer is 1 MHz and the video bandwidth is 3 MHz for Peak detection (PK) and Average detection (AV) at frequency above 1GHz.
3. All modes of operation were investigated and the worst-case emissions are reported.

For Radiated emission above 40GHz

- a. Connect the test antenna covering the appropriate frequency range to a spectrum analyzer via an external mixer to the spectrum analyzer.
- b. Set spectrum analyzer RBW = 1 MHz, VBW = 3 MHz, average detector.
- c. Calculate the distance to the far field boundary and determine the maximum measurement distance.
- d. Perform an exploratory search for emissions and determine the approximate direction at which each observed emission emanates from the EUT.
- e. Exploratory measurements be made at a closer distance than the validated maximum measurement distance.
- f. Perform a final measurement; begin with the test antenna at the approximate position where the maximum level occurred during the exploratory scan.
- g. Slowly scan the test antenna around this position, slowly vary the test antenna polarization by rotating through at least 0° to 180°, and slowly vary the orientation of the test antenna to find the final position, polarization, and orientation at which the maximum level of the emission is observed.
- h. Record the measured reading with the test antenna fixed at this maximized position, polarization, and orientation. Record the measurement distance.
- i. Calculate the maximum field strength of the emission at the measurement distance and the adjusted/corrected power at the output of the test antenna.
- j. Calculate the EIRP from the measured field strength and then convert to the linear.
- k. Calculate the power density at the distance specified by the limit from the field strength at the distance specified by the limit.
- l. Repeat the preceding sequence for every emission observed in the frequency band under investigation.

4.1.4 Deviation from Test Standard

No deviation.

4.1.5 Test Setup

For Radiated emission below 30MHz

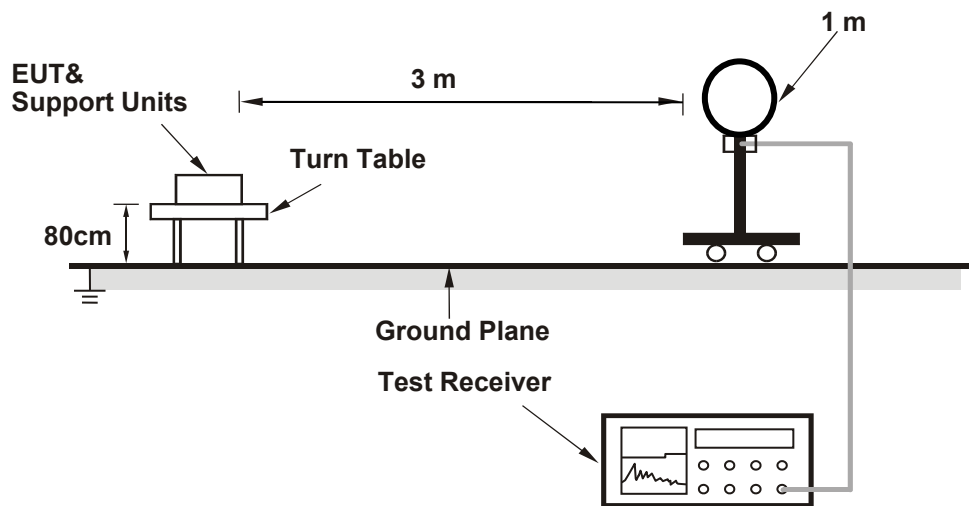

For Radiated emission 30MHz to 1GHz

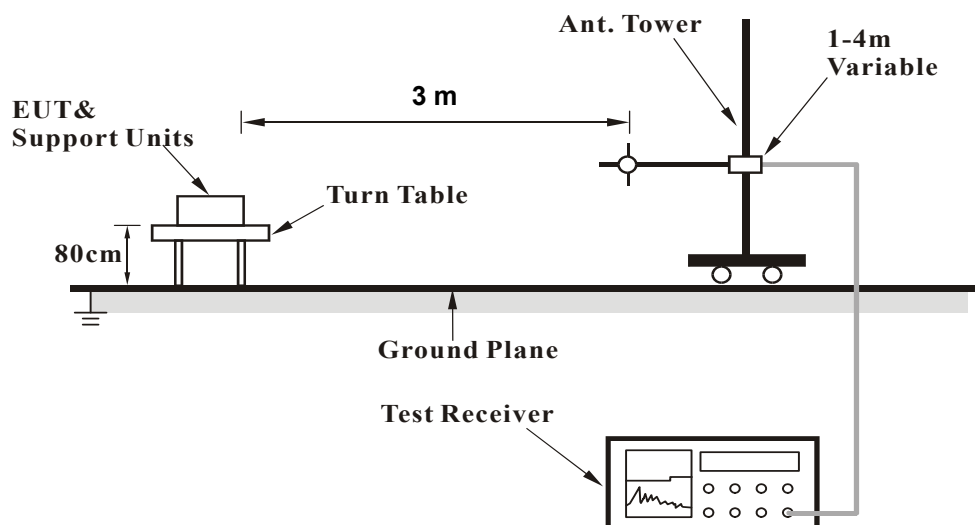

For Radiated emission 1GHz to 50GHz

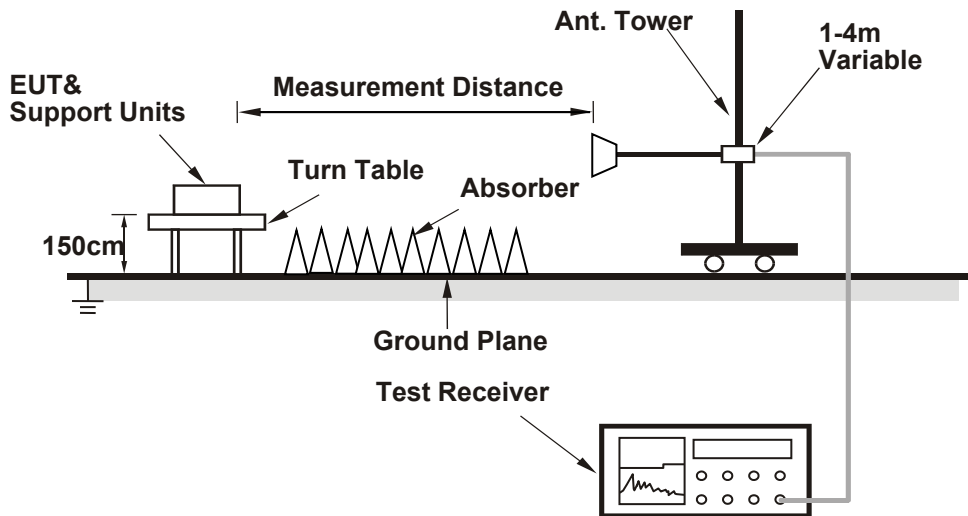

For Radiated emission above 50GHz

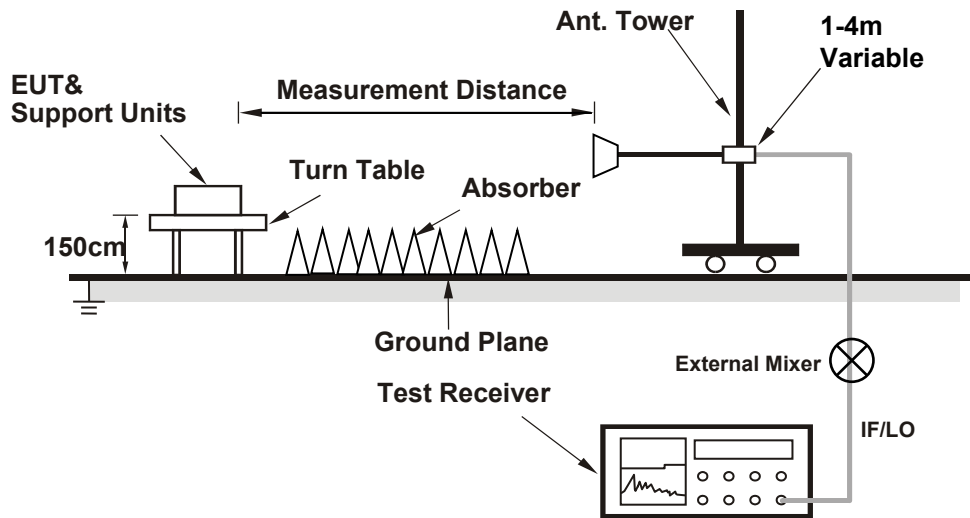

For the actual test configuration, please refer to the attached file (Test Setup Photo).

4.1.6 EUT Operating Conditions

- a. Placed the EUT on the testing table.
- b. The EUT is connected to the simulator at low, middle and high frequency channel individually.

4.1.7 Test Results

Above 1GHz Data:
For 1~18 GHz

Channel	CH 1 : 61.10 GHz		
Frequency Range	1GHz ~ 18GHz	Detector Function	Peak (PK) Average (AV)

Antenna Polarity & Test Distance : Horizontal at 3 m								
No	Frequency (MHz)	Emission Level (dBuV/m)	Limit (dBuV/m)	Margin (dB)	Antenna Height (m)	Table Angle (Degree)	Raw Value (dBuV)	Correction Factor (dB/m)
1	17779.00	43.4 AV	54.0	-10.6	1.67 H	57	43.3	0.1
2	17780.00	53.8 PK	74.0	-20.2	1.67 H	57	53.7	0.1

Remarks:

1. Emission Level(dBuV/m) = Raw Value(dBuV) + Correction Factor(dB/m)
2. Correction Factor(dB/m) = Antenna Factor(dB/m) + Cable Factor(dB) – Pre-Amplifier Factor(dB)
3. Margin value = Emission Level – Limit value
4. The other emission levels were very low against the limit.

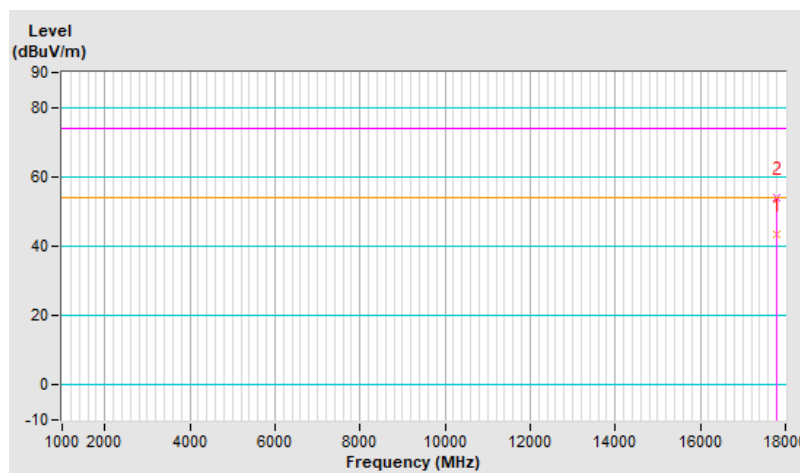

Channel	CH 1 : 61.10 GHz		
Frequency Range	1GHz ~ 18GHz	Detector Function	Peak (PK) Average (AV)

Antenna Polarity & Test Distance : Vertical at 3 m								
No	Frequency (MHz)	Emission Level (dBuV/m)	Limit (dBuV/m)	Margin (dB)	Antenna Height (m)	Table Angle (Degree)	Raw Value (dBuV)	Correction Factor (dB/m)
1	17779.00	43.3 AV	54.0	-10.7	1.46 V	150	43.2	0.1
2	17780.00	54.5 PK	74.0	-19.5	1.46 V	150	54.4	0.1

Remarks:

1. Emission Level(dBuV/m) = Raw Value(dBuV) + Correction Factor(dB/m)
2. Correction Factor(dB/m) = Antenna Factor(dB/m) + Cable Factor(dB) – Pre-Amplifier Factor(dB)
3. Margin value = Emission Level – Limit value
4. The other emission levels were very low against the limit.

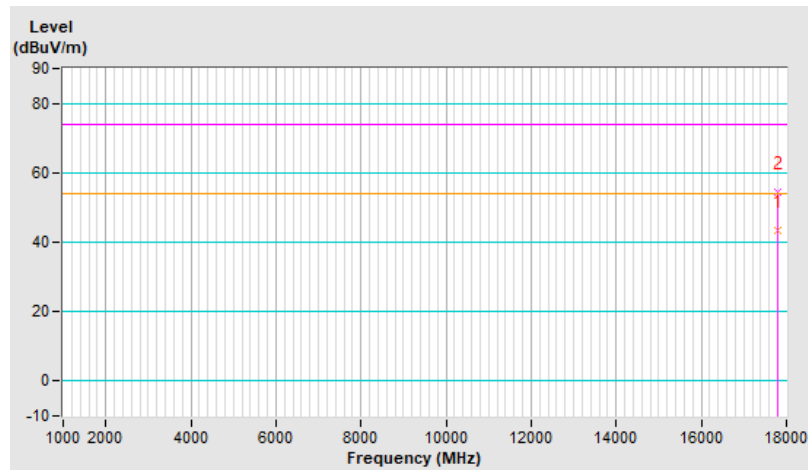

For 18~40 GHz

Channel	CH 1 : 61.10 GHz		
Frequency Range	18GHz ~ 40GHz	Detector Function	Peak (PK) Average (AV)

Antenna Polarity & Test Distance : Horizontal at 3 m								
No	Frequency (MHz)	Emission Level (dBuV/m)	Limit (dBuV/m)	Margin (dB)	Antenna Height (m)	Table Angle (Degree)	Raw Value (dBuV)	Correction Factor (dB/m)
1	37888.00	47.1 PK	74.0	-26.9	1.55 H	150	47.7	-0.6
2	37888.00	37.6 AV	54.0	-16.4	1.55 H	150	38.2	-0.6

Remarks:

1. Emission Level(dBuV/m) = Raw Value(dBuV) + Correction Factor(dB/m)
2. Correction Factor(dB/m) = Antenna Factor(dB/m) + Cable Factor(dB) – Pre-Amplifier Factor(dB)
3. Margin value = Emission Level – Limit value
4. The other emission levels were very low against the limit.

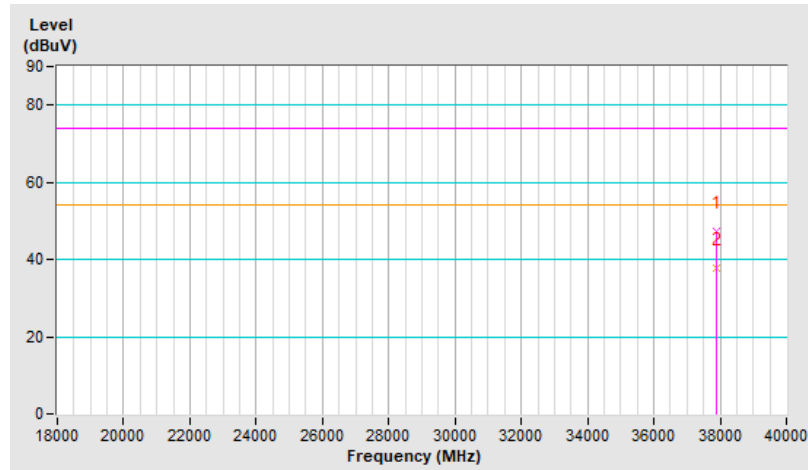

Channel	CH 1 : 61.10 GHz		
Frequency Range	18GHz ~ 40GHz	Detector Function	Peak (PK) Average (AV)

Antenna Polarity & Test Distance : Vertical at 3 m								
No	Frequency (MHz)	Emission Level (dBuV/m)	Limit (dBuV/m)	Margin (dB)	Antenna Height (m)	Table Angle (Degree)	Raw Value (dBuV)	Correction Factor (dB/m)
1	37888.00	48.0 PK	74.0	-26.0	1.66 V	33	48.6	-0.6
2	37888.00	38.1 AV	54.0	-15.9	1.66 V	33	38.7	-0.6

Remarks:

1. Emission Level(dBuV/m) = Raw Value(dBuV) + Correction Factor(dB/m)
2. Correction Factor(dB/m) = Antenna Factor(dB/m) + Cable Factor(dB) – Pre-Amplifier Factor(dB)
3. Margin value = Emission Level – Limit value
4. The other emission levels were very low against the limit.

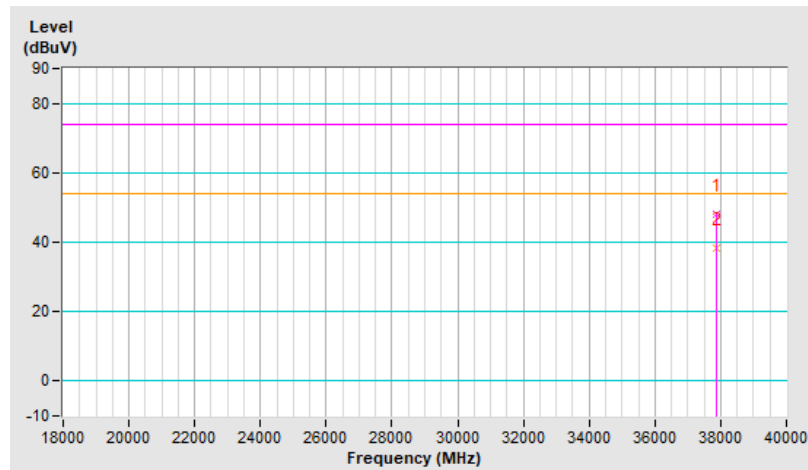

For above 40 GHz

Channel	CH 1 : 61.10 GHz		
Frequency Range	40GHz ~ 200GHz	Detector Function	Average (AV)

Antenna Polarity: Horizontal									
No.	Frequency (GHz)	Power (dBm)	Gain of test Antenna (dBi)	E _{Meas} (dB μ V/m)	EIRP Level (dBm/MHz)	Power Density (pW/cm ²)	Power Density Limit (pW/cm ²)	Margin (pW/cm ²)	PASS/ FAIL
1	49.21	-94.36	22.50	54.24	-50.46	0.01	90.00	-89.99	PASS
2	55.09	-79.12	21.50	71.46	-33.24	0.42	90.00	-89.58	PASS
3	74.04	-79.83	21.50	73.32	-31.38	0.64	90.00	-89.36	PASS
4	102.25	-100.24	21.60	55.61	-49.09	0.01	90.00	-89.99	PASS
5	169.83	-95.32	22.00	64.54	-40.16	0.09	90.00	-89.91	PASS
6	195.10	-78.16	21.30	83.60	-21.10	6.87	90.00	-83.13	PASS
Antenna Polarity : Vertical									
No.	Frequency (GHz)	Power (dBm)	Gain of test Antenna (dBi)	E _{Meas} (dB μ V/m)	EIRP Level (dBm/MHz)	Power Density (pW/cm ²)	Power Density Limit (pW/cm ²)	Margin (pW/cm ²)	PASS/ FAIL
1	49.24	-93.84	22.50	54.76	-49.94	0.01	90.00	-89.99	PASS
2	55.18	-78.92	21.50	71.67	-33.03	0.44	90.00	-89.56	PASS
3	74.20	-79.13	21.50	74.04	-30.66	0.76	90.00	-89.24	PASS
4	102.40	-100.21	21.60	55.65	-49.05	0.01	90.00	-89.99	PASS
5	169.76	-94.85	22.00	65.00	-39.70	0.10	90.00	-89.91	PASS
6	195.20	-77.62	21.30	84.15	-20.55	7.79	90.00	-82.22	PASS

Remarks:

1. The measured power level is converted to EIRP using the equation:

Follow ANSI 63.10 section 9.4 Equations to calculate and extrapolate field strength

$$E_{Meas} \text{ (dB}\mu\text{V/m)} = 126.8 - 20\log(\lambda) + P - G$$

where:

E_{Meas} is the field strength of the emission at the measurement distance, in dB μ V/m

P is the power measured at the output of the test antenna, in dBm

λ is the wavelength of the emission under investigation [300/fMHz], in m

G is the gain of the test antenna, in dBi

Follow ANSI 63.10 section 9.5 Equations to calculate EIRP

$$\text{EIRP Level (dBm/MHz)} = E_{Meas} \text{ (dB}\mu\text{V/m)} + 20 \cdot \log(d_{Meas}) - 104.7$$

E_{Meas} is the field strength of the emission at the measurement distance, in dB μ V/m

d_{Meas} is the measurement distance, in m

Measurements made at 1 meter distance.

2. Power density formula as follows

Follow ANSI 63.10 section 9.6 Equations to calculate power density

$$PD = EIRP_{Linear} / 4 \pi d^2$$

PD is the power density at the distance specified by the limit, in W/m²

EIRP_{Linear} is the equivalent isotropically radiated power, in watts

d is the 1m distance.

3. The far-field boundary is given in ANSI 63.10 section 9.1 as:

$$R \text{ far field} = (2 * L^2) / \lambda$$

L is the Largest Antenna Dimension of measurement antenna, including the reflector

λ is the wavelength

Frequency (GHz)	L (m)	Lambda (m)	R (Far Field) (m)
40	0.03	0.0075	0.240
50	0.03	0.0060	0.300

Frequency (GHz)	L (m)	Lambda (m)	R (Far Field) (m)
50	0.025	0.0060	0.208
75	0.025	0.0040	0.313

Frequency (GHz)	L (m)	Lambda (m)	R (Far Field) (m)
75	0.018	0.0040	0.162
110	0.018	0.0027	0.238

Frequency (GHz)	L (m)	Lambda (m)	R (Far Field) (m)
110	0.012	0.0027	0.106
170	0.012	0.0018	0.163

Frequency (GHz)	L (m)	Lambda (m)	R (Far Field) (m)
170	0.008	0.0018	0.073
260	0.008	0.0012	0.111

Below 1GHz Data:

TX / RX Mode

Channel	CH 1 : 61.10 GHz		
Frequency Range	9kHz ~ 1GHz	Detector Function	Quasi-Peak (QP)

Antenna Polarity & Test Distance : Horizontal at 3 m

No	Frequency (MHz)	Emission Level (dBuV/m)	Limit (dBuV/m)	Margin (dB)	Antenna Height (m)	Table Angle (Degree)	Raw Value (dBuV)	Correction Factor (dB/m)
1	49.40	28.9 QP	40.0	-11.1	1.01 H	2	41.4	-12.5
2	294.81	33.4 QP	46.0	-12.6	2.01 H	231	45.6	-12.2
3	491.72	41.0 QP	46.0	-5.0	1.01 H	178	48.3	-7.3
4	589.69	45.9 QP	46.0	-0.1	2.01 H	119	51.2	-5.3
5	639.16	44.9 QP	46.0	-1.1	2.01 H	247	49.0	-4.1
6	687.66	45.0 QP	46.0	-1.0	2.01 H	247	48.5	-3.5
7	786.60	40.7 QP	46.0	-5.3	1.01 H	256	41.6	-0.9
8	934.04	40.0 QP	46.0	-6.0	1.01 H	116	40.5	-0.5

Remarks:

1. Emission Level(dBuV/m) = Raw Value(dBuV) + Correction Factor(dB/m)
2. Correction Factor(dB/m) = Antenna Factor(dB/m) + Cable Factor(dB) – Pre-Amplifier Factor(dB)
3. Margin value = Emission Level – Limit value
4. The other emission levels were very low against the limit of frequency range 30MHz~1000MHz.
5. The frequency range 9 kHz ~ 30 MHz: all emissions are more than 20 dB below the limit, therefore do not be recorded in this report.

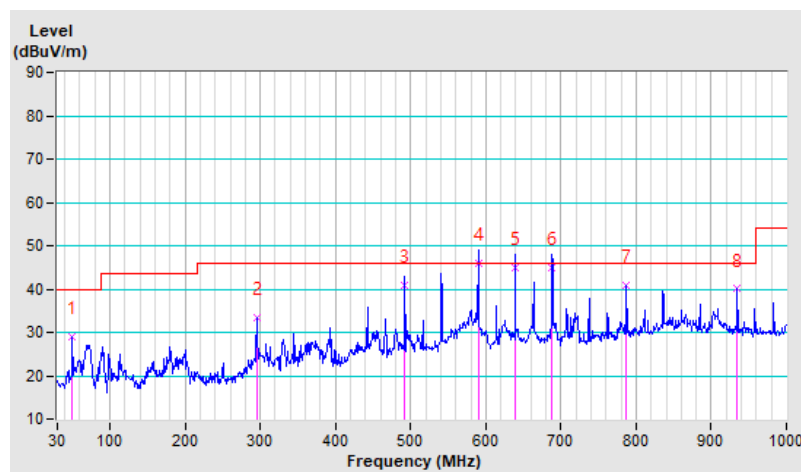

Channel	CH 1 : 61.10 GHz		
Frequency Range	9kHz ~ 1GHz	Detector Function	Quasi-Peak (QP)

Antenna Polarity & Test Distance : Vertical at 3 m								
No	Frequency (MHz)	Emission Level (dBuV/m)	Limit (dBuV/m)	Margin (dB)	Antenna Height (m)	Table Angle (Degree)	Raw Value (dBuV)	Correction Factor (dB/m)
1	49.40	39.8 QP	40.0	-0.2	1.00 V	179	52.3	-12.5
2	491.72	45.6 QP	46.0	-0.4	1.00 V	150	52.9	-7.3
*3	589.69	47.8 QP	46.0	1.8	1.00 V	144	53.1	-5.3
*4	639.16	48.1 QP	46.0	2.1	1.00 V	227	52.2	-4.1
*5	687.66	47.6 QP	46.0	1.6	1.00 V	136	51.1	-3.5
6	835.10	40.0 QP	46.0	-6.0	1.00 V	309	40.9	-0.9

Remarks:

1. Emission Level(dBuV/m) = Raw Value(dBuV) + Correction Factor(dB/m)
 2. Correction Factor(dB/m) = Antenna Factor(dB/m) + Cable Factor(dB) – Pre-Amplifier Factor(dB)
 3. Margin value = Emission Level – Limit value
 4. The other emission levels were very low against the limit of frequency range 30MHz~1000MHz.
 5. The frequency range 9 kHz ~ 30 MHz: all emissions are more than 20 dB below the limit, therefore do not be recorded in this report.
- * Spurious Emissions were evaluated with RF module off to determine whether failing results were originating from the RF module (See RF module off Mode data). After verification, frequencies denoted by the * which include emissions that are failing have been identified as coming from unintentional emission signal brought out by the power supply. Unintentional emissions are found compliant in SDoC test report no. FDBEFM-WTW-P23080697 for Class A digital devices.

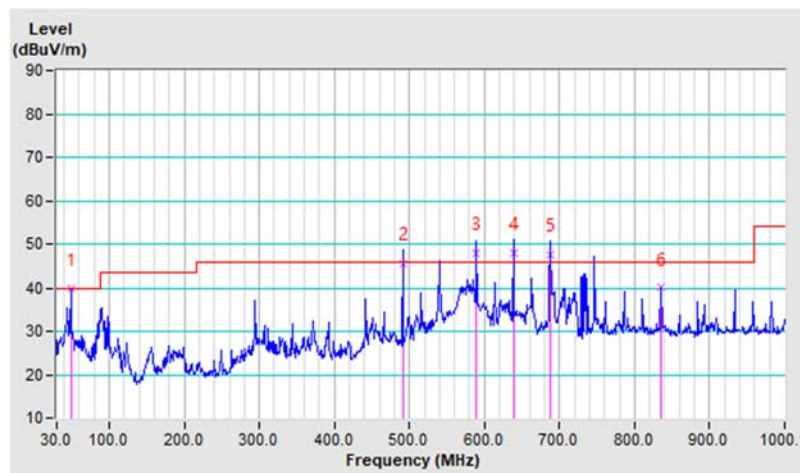

Module off Mode

Channel	CH 1 : 61.10 GHz		
Frequency Range	9kHz ~ 1GHz	Detector Function	Quasi-Peak (QP)

Antenna Polarity & Test Distance : Horizontal at 3 m								
No	Frequency (MHz)	Emission Level (dBuV/m)	Limit (dBuV/m)	Margin (dB)	Antenna Height (m)	Table Angle (Degree)	Raw Value (dBuV)	Correction Factor (dB/m)
1	68.80	27.0 QP	40.0	-13.0	2.01 H	18	122.2	-95.2
2	294.81	31.4 QP	46.0	-14.6	2.00 H	244	126.6	-95.2
3	491.72	41.1 QP	46.0	-4.9	1.00 H	182	136.3	-95.2
4	589.69	45.2 QP	46.0	-0.8	2.01 H	119	140.4	-95.2
5	639.16	44.1 QP	46.0	-1.9	2.01 H	247	139.3	-95.2
6	688.07	44.8 QP	46.0	-1.2	2.00 H	250	140.0	-95.2
7	785.56	40.7 QP	46.0	-5.3	1.00 H	255	135.9	-95.2
8	933.40	40.1 QP	46.0	-5.9	1.00 H	120	135.3	-95.2

Remarks:

1. Emission Level(dBuV/m) = Raw Value(dBuV) + Correction Factor(dB/m)
2. Correction Factor(dB/m) = Antenna Factor(dB/m) + Cable Factor(dB) – Pre-Amplifier Factor(dB)
3. Margin value = Emission Level – Limit value
4. The other emission levels were very low against the limit of frequency range 30MHz~1000MHz.
5. The frequency range 9 kHz ~ 30 MHz: all emissions are more than 20 dB below the limit, therefore do not be recorded in this report.

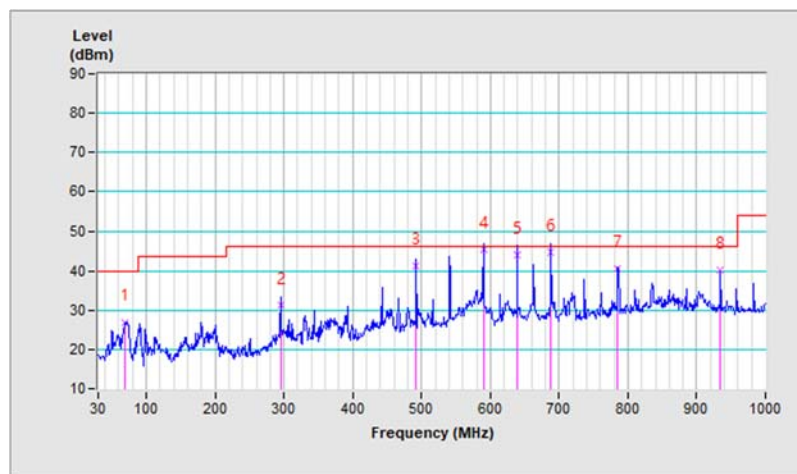

Channel	CH 1 : 61.10 GHz		
Frequency Range	9kHz ~ 1GHz	Detector Function	Quasi-Peak (QP)

Antenna Polarity & Test Distance : Vertical at 3 m								
No	Frequency (MHz)	Emission Level (dBuV/m)	Limit (dBuV/m)	Margin (dB)	Antenna Height (m)	Table Angle (Degree)	Raw Value (dBuV)	Correction Factor (dB/m)
1	44.55	38.4 QP	40.0	-1.6	1.00 V	147	9.7	28.7
2	490.97	45.5 QP	46.0	-0.5	1.00 V	149	52.0	-6.5
*3	589.27	47.8 QP	46.0	1.8	1.00 V	149	54.3	-6.5
*4	639.06	47.9 QP	46.0	1.9	1.00 V	230	54.4	-6.5
*5	687.57	47.4 QP	46.0	1.4	1.00 V	133	53.9	-6.5
6	835.01	39.8 QP	46.0	-6.2	1.00 V	310	46.3	-6.5

Remarks:

1. Emission Level(dBuV/m) = Raw Value(dBuV) + Correction Factor(dB/m)
 2. Correction Factor(dB/m) = Antenna Factor(dB/m) + Cable Factor(dB) – Pre-Amplifier Factor(dB)
 3. Margin value = Emission Level – Limit value
 4. The other emission levels were very low against the limit of frequency range 30MHz~1000MHz.
 5. The frequency range 9 kHz ~ 30 MHz: all emissions are more than 20 dB below the limit, therefore do not be recorded in this report.
- * Spurious Emissions were evaluated with RF module off to determine whether failing results were originating from the RF module (See RF module off Mode data). After verification, frequencies denoted by the * which include emissions that are failing have been identified as coming from unintentional emission signal brought out by the power supply. Unintentional emissions are found compliant in SDoC test report no. FDBEFM-WTW-P23080697 for Class A digital devices.

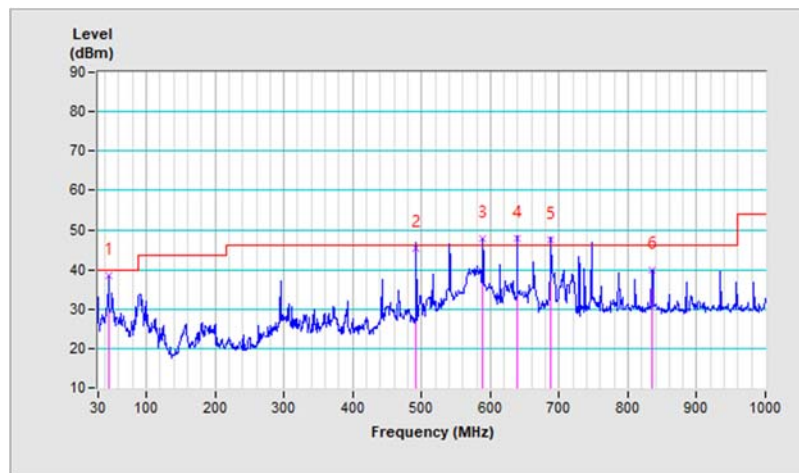

4.2 Conducted Emission Measurement

4.2.1 Limits of Conducted Emission Measurement

Frequency (MHz)	Conducted Limit (dBuV)	
	Quasi-peak	Average
0.15 - 0.5	66 - 56	56 - 46
0.50 - 5.0	56	46
5.0 - 30.0	60	50

Note: 1. The lower limit shall apply at the transition frequencies.

2. The limit decreases in line with the logarithm of the frequency in the range of 0.15 to 0.50MHz.

4.2.2 Test Instruments

Description & Manufacturer	Model No.	Serial No.	Cal. Date	Cal. Due
Test Receiver ROHDE & SCHWARZ	ESR3	102412	Dec. 21, 2022	Dec. 20, 2024
RF signal cable (with 10dB PAD) Woken	5D-FB	Cable-cond2-01	Sep. 02, 2023	Sep. 01, 2024
LISN/AMN ROHDE & SCHWARZ (EUT)	ESH2-Z5	100100	Mar. 07, 2023	Mar. 06, 2024
LISN/AMN ROHDE & SCHWARZ (Peripheral)	ENV216	101196	May 22, 2023	May 21, 2024
Software ADT	BV ADT_Cond_ V7.3.7.4	NA	NA	NA

Note: 1. The calibration interval of the above test instruments is 12 months and the calibrations are traceable to NML/ROC and NIST/USA.

2. The test was performed in HwaYa Shielded Room 2 (Conduction 2).

3. The VCCI Site Registration No. is C-12047.

4. Tested date: Oct. 31, 2023

4.2.3 Test Procedures

- The EUT was placed 0.4 meters from the conducting wall of the shielded room with EUT being connected to the power mains through a line impedance stabilization network (LISN). Other support units were connected to the power mains through another LISN. The two LISNs provide 50 ohm/ 50uH of coupling impedance for the measuring instrument.
- Both lines of the power mains connected to the EUT were checked for maximum conducted interference.
- The frequency range from 150kHz to 30MHz was searched. Emission levels under (Limit - 20dB) was not recorded.

Note: The resolution bandwidth and video bandwidth of test receiver is 9kHz for quasi-peak detection (QP) and average detection (AV) at frequency 0.15MHz-30MHz.

4.2.4 Deviation from Test Standard

No deviation.

4.2.5 Test Setup

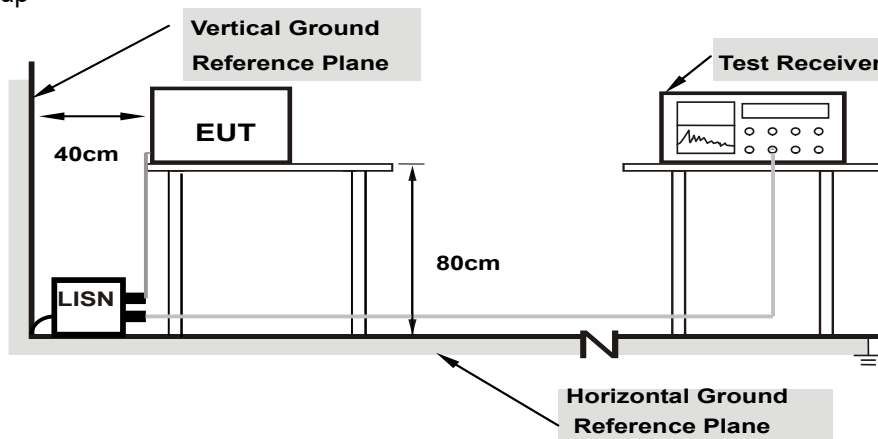

Note: 1.Support units were connected to second LISN.

For the actual test configuration, please refer to the attached file (Test Setup Photo).

4.2.6 EUT Operating Conditions

Same as 4.1.6.

4.2.7 Test Results

Channel	CH 1 : 61.10 GHz		
Frequency Range	150kHz ~ 30MHz	Detector Function & Bandwidth	Quasi-Peak (QP) / Average (AV), 9kHz

Phase Of Power : Line (L)										
No	Frequency (MHz)	Correction Factor (dB)	Reading Value (dBuV)		Emission Level (dBuV)		Limit (dBuV)		Margin (dB)	
			Q.P.	AV.	Q.P.	AV.	Q.P.	AV.	Q.P.	AV.
1	0.15000	10.32	36.02	20.29	46.34	30.61	66.00	56.00	-19.66	-25.39
2	0.21400	10.35	29.79	19.42	40.14	29.77	63.05	53.05	-22.91	-23.28
3	1.07346	10.43	21.19	9.41	31.62	19.84	56.00	46.00	-24.38	-26.16
4	1.65796	10.42	19.66	7.41	30.08	17.83	56.00	46.00	-25.92	-28.17
5	6.07400	10.54	29.59	26.51	40.13	37.05	60.00	50.00	-19.87	-12.95
6	19.77000	10.75	29.33	20.49	40.08	31.24	60.00	50.00	-19.92	-18.76

Remarks:

1. Q.P. and AV. are abbreviations of quasi-peak and average individually.
2. The emission levels of other frequencies were very low against the limit.
3. Margin value = Emission level – Limit value
4. Correction factor = Insertion loss + Cable loss
5. Emission Level = Correction Factor + Reading Value

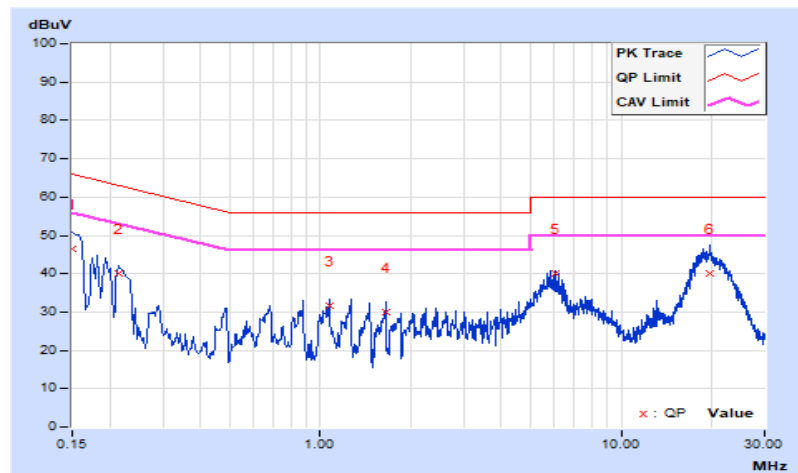

Channel	CH 1 : 61.10 GHz		
Frequency Range	150kHz ~ 30MHz	Detector Function & Bandwidth	Quasi-Peak (QP) / Average (AV), 9kHz

Phase Of Power : Neutral (N)										
No	Frequency (MHz)	Correction Factor (dB)	Reading Value (dBuV)		Emission Level (dBuV)		Limit (dBuV)		Margin (dB)	
			Q.P.	AV.	Q.P.	AV.	Q.P.	AV.	Q.P.	AV.
1	0.19000	10.35	29.47	11.46	39.82	21.81	64.04	54.04	-24.22	-32.23
2	0.21000	10.36	28.52	9.41	38.88	19.77	63.21	53.21	-24.33	-33.44
3	1.26600	10.45	18.60	6.19	29.05	16.64	56.00	46.00	-26.95	-29.36
4	2.81800	10.48	13.09	2.66	23.57	13.14	56.00	46.00	-32.43	-32.86
5	5.80600	10.58	27.94	24.44	38.52	35.02	60.00	50.00	-21.48	-14.98
6	19.27800	10.90	28.73	19.95	39.63	30.85	60.00	50.00	-20.37	-19.15

Remarks:

1. Q.P. and AV. are abbreviations of quasi-peak and average individually.
2. The emission levels of other frequencies were very low against the limit.
3. Margin value = Emission level – Limit value
4. Correction factor = Insertion loss + Cable loss
5. Emission Level = Correction Factor + Reading Value

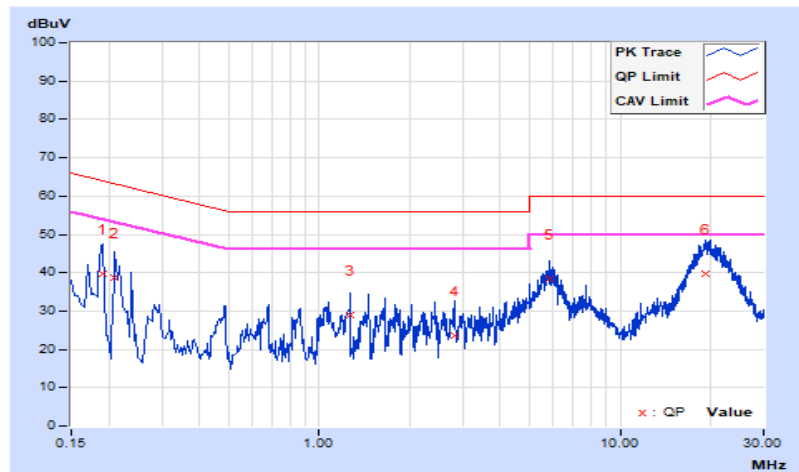

4.3 6dB Bandwidth Measurement

4.3.1 Limits of 6dB Bandwidth Measurement

None: For reporting purposes only.

4.3.2 Test Setup

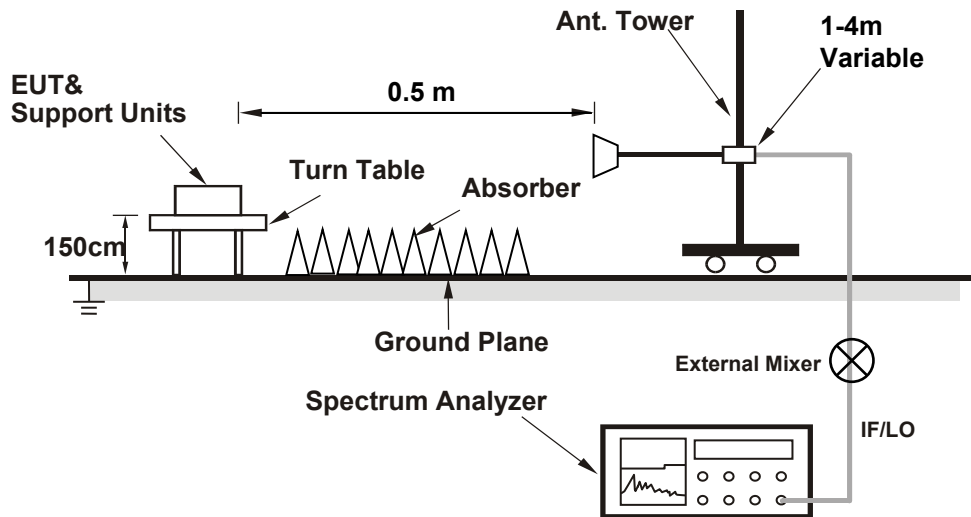

4.3.3 Test Instruments

Description & Manufacturer	Model No.	Serial No.	Cal. Date	Cal. Due
Spectrum Analyzer Agilent	N9010A	MY52220314	Dec. 09, 2022	Dec. 08, 2023
Spectrum Analyzer (50~110GHz) Keysight	V3050A	US60360159	Feb. 07, 2023	Feb. 06, 2024
Conical Horn Antenna (50~75GHz) Keysight	WR15CH-Conical	RCH015RL-2	Apr. 25, 2023	Apr. 24, 2024
DC Power Supply TOPWARD	6306A	727263	NA	NA
Temperature & Humidity Chamber TERCHY	HRM-120RF	931022	Dec. 27, 2022	Dec. 26, 2023

Note:

- The calibration interval of the above test instruments is 12 months and the calibrations are traceable to NML/ROC and NIST/USA.
- Tested date: Sep. 12, 2023

4.3.4 Test Procedure

- a. Set resolution bandwidth (RBW) = 100kHz
- b. Set the video bandwidth (VBW) $\geq 3 \times$ RBW, Detector = Peak.
- c. Trace mode = max hold.
- d. Sweep = auto couple.
- e. Measure the maximum width of the emission that is constrained by the frequencies associated with the two amplitude points (upper and lower) that are attenuated by 6 dB relative to the maximum level measured in the fundamental emission

4.3.5 Deviation from Test Standard

No deviation.

4.3.6 EUT Operating Conditions

Same as 4.1.6.

4.3.7 Test Result

Channel	Frequency (GHz)	6dB Bandwidth (MHz)
1	61.10	1.010

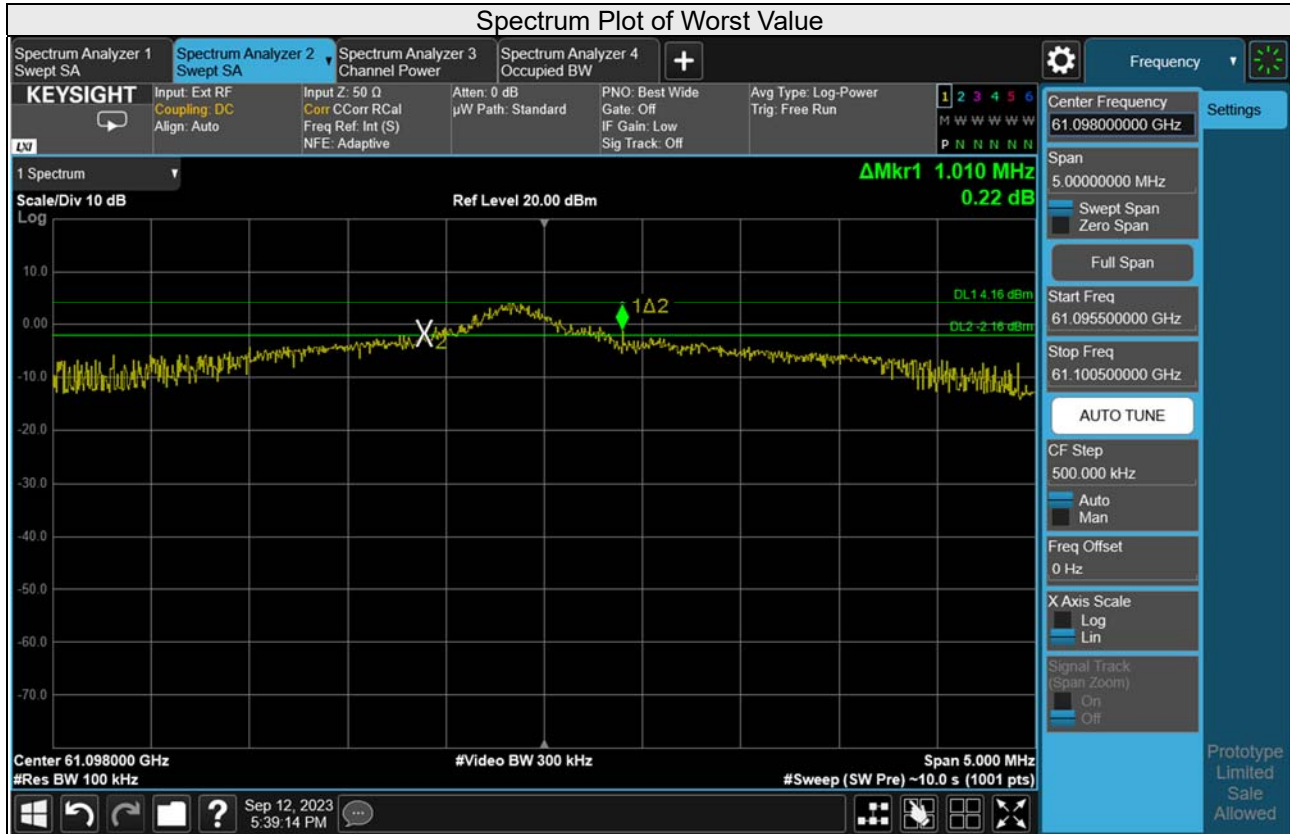

4.4 Occupied Bandwidth Measurement

4.4.1 Limits of Occupied Bandwidth Measurement

15.255 (c)(2)(v)

61.0-61.5 GHz: For field disturbance sensors/radars that occupy 500 MHz bandwidth or less that are contained wholly within the frequency band 61.0-61.5 GHz.

4.4.2 Test Setup

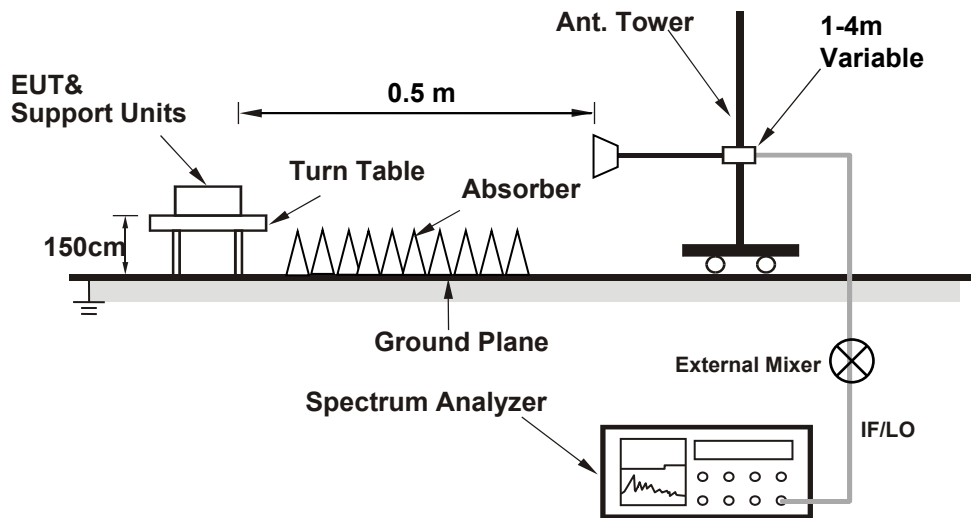

4.4.3 Test Instruments

Description & Manufacturer	Model No.	Serial No.	Cal. Date	Cal. Due
Spectrum Analyzer Agilent	N9010A	MY52220314	Dec. 09, 2022	Dec. 08, 2023
Spectrum Analyzer (50~110GHz) Keysight	V3050A	US60360159	Feb. 07, 2023	Feb. 06, 2024
Conical Horn Antenna (50~75GHz) Keysight	WR15CH-Conical	RCH015RL-2	Apr. 25, 2023	Apr. 24, 2024
DC Power Supply TOPWARD	6306A	727263	NA	NA
Temperature & Humidity Chamber TERCHY	HRM-120RF	931022	Dec. 27, 2022	Dec. 26, 2023

Note:

1. The calibration interval of the above test instruments is 12 months and the calibrations are traceable to NML/ROC and NIST/USA.
2. Tested date: Nov. 17, 2023

4.4.4 Test Procedure

1. Set Span=1.5 times the OBW
2. Set RBW = 1~5% of the OBW, or minimum of 1MHz if the this is not possible due to a large OBW.
3. Set the VBW approximately 3 x RBW.
4. Detector = Peak.
5. Trace mode = max hold.
6. The EUT shall be transmitting at its maximum data rate, Allow the trace to stabilize.

4.4.5 Deviation from Test Standard

No deviation.

4.4.6 EUT Operating Conditions

Same as 4.1.6.

4.4.7 Test Result

Channel	Frequency (GHz)	Occupied Bandwidth (MHz)	Pass/Fail
1	61.10	7.7357	Pass

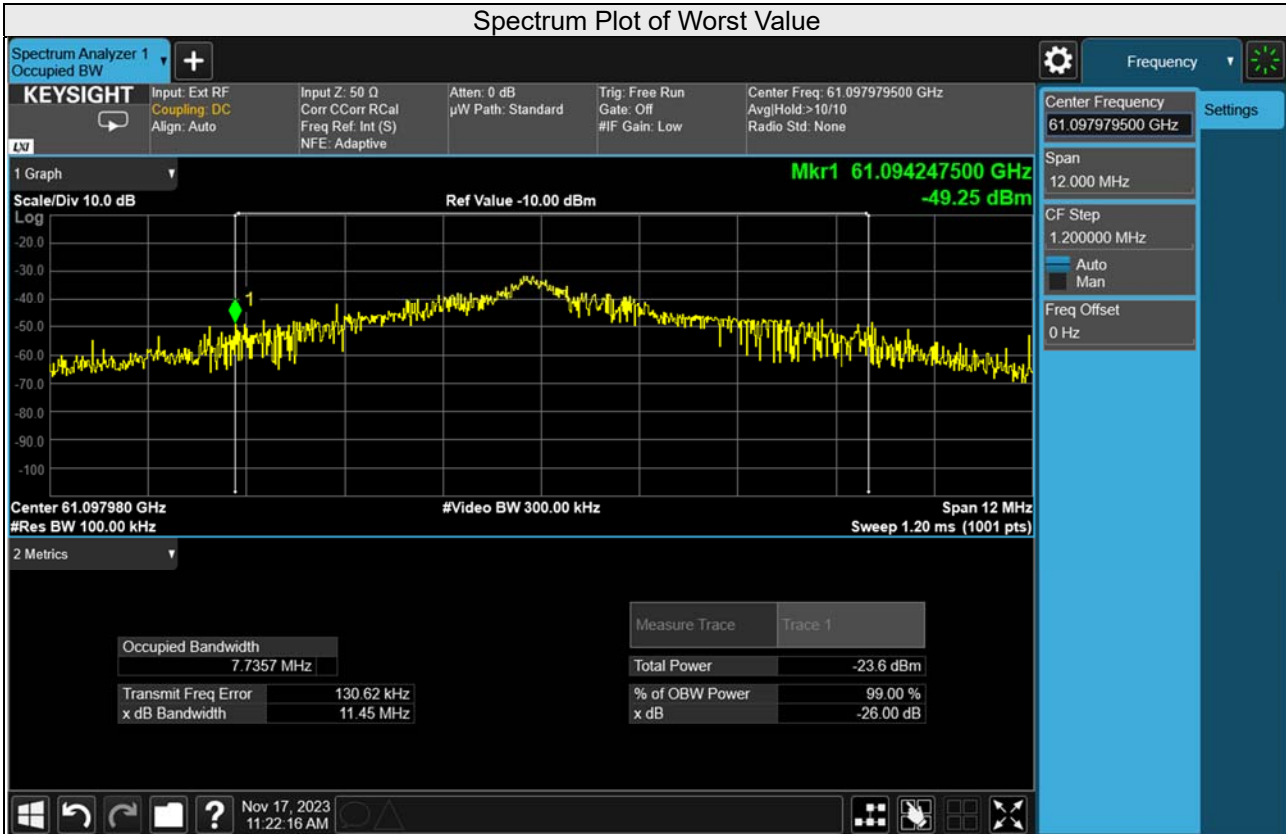

4.5 Output Power Measurement

4.5.1 Limits of Output Power Measurement

15.255 (c)(2)(v)

61.0-61.5 GHz: For field disturbance sensors/radars that occupy 500 MHz bandwidth or less that are contained wholly within the frequency band 61.0-61.5 GHz, the average power of any emission, measured during the transmit interval, shall not exceed 40 dBm, and the peak power of any emission shall not exceed 43 dBm. In addition, the average power of any emission outside of the 61.0-61.5 GHz band, measured during the transmit interval, but still within the 57-71 GHz band, shall not exceed 10 dBm, and the peak power of any emission shall not exceed 13 dBm.

4.5.2 Test Setup

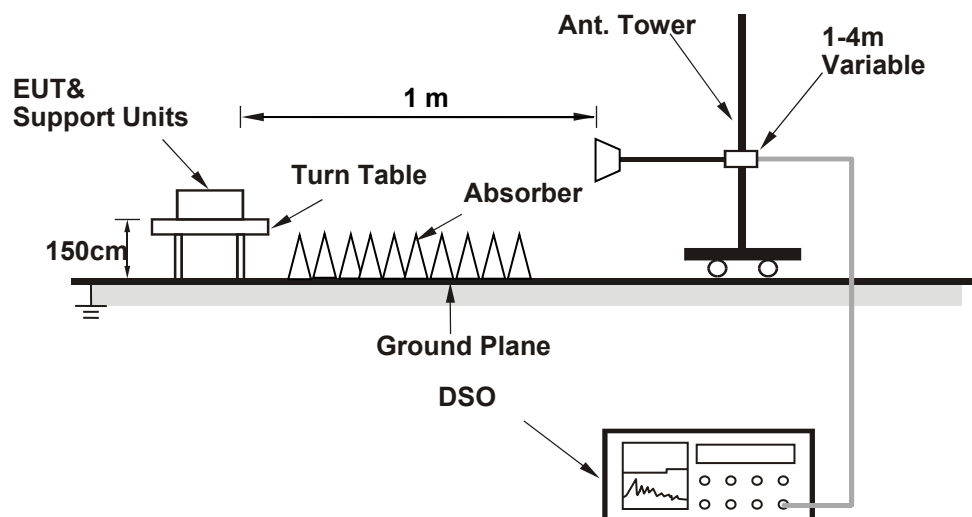

4.5.3 Test Instruments

Same as Item 4.1.2.

4.5.4 Test Procedures

- a. Place the EUT in a continuous transmission mode.
- b. For radiated emission measurements, attach a test receive antenna for the fundamental frequency band to the RF input of an RF detector or a downconverter with an RF detector at the output.
- c. Connect the video output of the detector to the 50 ohm input of the DSO.
- d. Place the test receive antenna in the main beam of the EUT at a distance which will provide a signal within the operating range of the RF detector.
- e. Set the sampling rate of the DSO to the required value. Adjust the memory depth, the triggering and the sweep speed to obtain a display which is representative of the signal considering the type of modulation.
- f. For radiated emission measurements, calculate the distance to the far field boundary of the fundamental emission using following equation

$$R \text{ far field} = (2 * L^2) / \lambda$$

Where:

L is the Largest Antenna Dimension of either the EUT antenna or measurement antenna, including the reflector

λ is the wavelength

Frequency (GHz)	L (m)	Lambda (m)	R (Far Field) (m)
61.10	0.007	0.00491	0.02

*Measurements made at 1 meter distance.

- g. Perform radiated emission measurements to keep maximize the received signal from the EUT in the far field.
- h. Record the average and peak from the DSO and the measurement distance.
- i. Disconnect the EUT from the RF input port of the instrumentation system.
- j. Connect a mm-wave source to the RF input port of the instrumentation system via a waveguide variable attenuator. The mm-wave source is unmodulated.
- k. Using substitution measurement.
- l. Measure and note the power.

4.5.5 Deviation from Test Standard

No deviation.

4.5.6 EUT Operating Conditions

Same as 4.1.6.

4.5.7 Test Results

For Output Power (EIRP)

Antenna Polarity : Horizontal								
No.	Frequency (GHz)	DSO Value (mV)	Power (dBm)	Gain of Test Antenna (dBi)	E _{Meas} (dB μ V/m)	EIRP Level (dBm)	EIRP Limit (dBm)	Pass/Fail
1	61.10	5.12	-54.06	21.50	97.42	-7.28 PK	43.00	PASS
2	61.10	0.48	-79.92	21.50	71.56	-33.14 AV	40.00	PASS
3	60.25	0.51	-76.51	21.50	74.85	-29.85 PK	13.00	PASS
4	60.25	0.37	-87.43	21.50	63.93	-40.77 AV	10.00	PASS
5	70.77	0.43	-77.56	21.50	75.19	-29.51 PK	13.00	PASS
6	70.77	0.46	-85.13	21.50	67.62	-37.08 AV	10.00	PASS
Antenna Polarity : Vertical								
No.	Frequency (GHz)	DSO Value (mV)	Power (dBm)	Gain of Test Antenna (dBi)	E _{Meas} (dB μ V/m)	EIRP Level (dBm)	EIRP Limit (dBm)	Pass/Fail
1	61.10	16.85	-41.52	21.50	109.96	5.26 PK	43.00	PASS
2	61.10	0.65	-66.95	21.50	84.53	-20.17 AV	40.00	PASS
3	60.62	0.52	-76.02	21.50	75.39	-29.31 PK	13.00	PASS
4	60.62	0.51	-87.13	21.50	64.28	-40.42 AV	10.00	PASS
5	70.36	0.42	-77.12	21.50	75.58	-29.12 PK	13.00	PASS
6	70.36	0.44	-87.32	21.50	65.38	-39.32 AV	10.00	PASS

Note:

1. The measured power level is converted to EIRP using the equation:

Follow ANSI 63.10 section 9.4 Equations to calculate and extrapolate field strength

$$E_{Meas} \text{ (dB}\mu\text{V/m)} = 126.8 - 20\log(\lambda) + P - G$$

where:

E_{Meas} is the field strength of the emission at the measurement distance, in dB μ V/m

P is the power measured at the output of the test antenna, in dBm

λ is the wavelength of the emission under investigation [300/fMHz], in m

G is the gain of the test antenna, in dBi

Follow ANSI 63.10 section 9.5 Equations to calculate EIRP

$$\text{EIRP Level (dBm/MHz)} = E_{Meas} \text{ (dB}\mu\text{V/m)} + 20 \cdot \log(d_{Meas}) - 104.7$$

where:

EIRP is the equivalent isotropically radiated power, in dBm

E_{Meas} is the field strength of the emission at the measurement distance, in dB μ V/m

d_{Meas} is the measurement distance, in m

Measurements made at 1 meter distance.

4.6 Frequency Stability Measurement

4.6.1 Limits of Frequency Stability Measurement

15.255(f) Fundamental emissions must be contained within the frequency bands specified in this section during all conditions of operation.

4.6.2 Test Setup

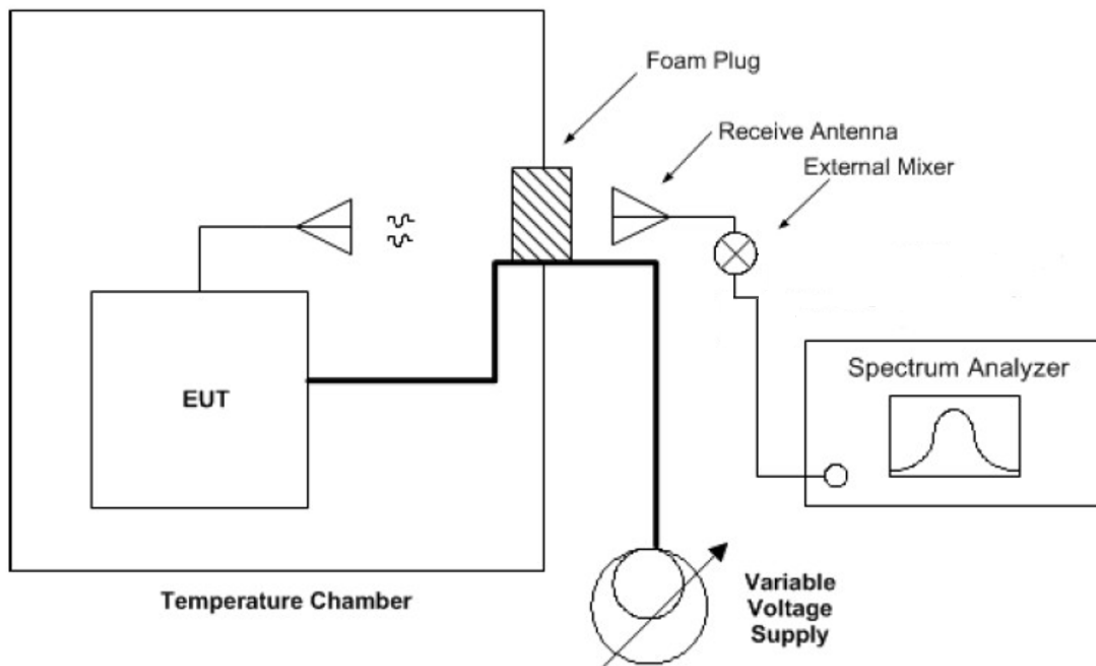

4.6.3 Test Instruments

Same as Item 4.2.3.

4.6.4 Test Procedure

- a. Arrange EUT and test equipment as above setup configuration.
- b. With the EUT at ambient temperature and voltage source set to the EUT nominal operating voltage (100%), record the spectrum mask of the EUT emission on the spectrum analyzer.
- c. Vary EUT power supply between 85% and 115% of nominal, and record the frequency excursion of the EUT emission mask.
- d. Set the power supply to 100% nominal setting, and raise EUT operating temperature to 50 °C. Record the frequency excursion of the EUT emission mask.
- e. Repeat step d) at each 10 °C increment down to -20 °C

4.6.5 Deviation from Test Standard

No deviation.

4.6.6 EUT Operating Condition

Same as 4.1.6.

4.6.7 Test Results

Frequency Stability Versus Temperature									
Operating Frequency: 61100 MHz									
Temp. (°C)	Power Supply (Vac)	0 Minute		2 Minutes		5 Minutes		10 Minutes	
		Measured Frequency (MHz)	Test Result	Measured Frequency (MHz)	Test Result	Measured Frequency (MHz)	Test Result	Measured Frequency (MHz)	Test Result
50	120	61100.0759	Pass	61100.0698	Pass	61100.1044	Pass	61100.1066	Pass
40	120	61099.8529	Pass	61099.8593	Pass	61099.8688	Pass	61099.8564	Pass
30	120	61099.8757	Pass	61099.8764	Pass	61099.8744	Pass	61099.8803	Pass
20	120	61100.2787	Pass	61100.2747	Pass	61100.3104	Pass	61100.3256	Pass
10	120	61100.2122	Pass	61100.2165	Pass	61100.2197	Pass	61100.2099	Pass
0	120	61100.1071	Pass	61100.0984	Pass	61100.0797	Pass	61100.0584	Pass
-10	120	61099.8047	Pass	61099.7771	Pass	61099.7825	Pass	61099.7988	Pass
-20	120	61099.9165	Pass	61099.9323	Pass	61099.9622	Pass	61099.9624	Pass

Frequency Stability Versus Voltage									
Operating Frequency: 61100 MHz									
Temp. (°C)	Power Supply (Vac)	0 Minute		2 Minutes		5 Minutes		10 Minutes	
		Measured Frequency (MHz)	Test Result	Measured Frequency (MHz)	Test Result	Measured Frequency (MHz)	Test Result	Measured Frequency (MHz)	Test Result
20	138	61100.2425	Pass	61100.2572	Pass	61100.2292	Pass	61100.2523	Pass
	120	61100.2787	Pass	61100.2747	Pass	61100.3104	Pass	61100.3256	Pass
	102	61100.2379	Pass	61100.1978	Pass	61100.2283	Pass	61100.1981	Pass

5 Pictures of Test Arrangements

Please refer to the attached file (Test Setup Photo).

Appendix – Information of the Testing Laboratories

We, Bureau Veritas Consumer Products Services (H.K.) Ltd., Taoyuan Branch, were founded in 1988 to provide our best service in EMC, Radio, Telecom and Safety consultation. Our laboratories are FCC recognized accredited test firms and accredited according to ISO/IEC 17025.

If you have any comments, please feel free to contact us at the following:

Lin Kou EMC/RF Lab

Tel: 886-2-26052180

Fax: 886-2-26051924

Hsin Chu EMC/RF/Telecom Lab

Tel: 886-3-6668565

Fax: 886-3-6668323

Hwa Ya EMC/RF/Safety Lab

Tel: 886-3-3183232

Fax: 886-3-3270892

Email: service.adt@tw.bureauveritas.com

Web Site: <http://ee.bureauveritas.com.tw>

The address and road map of all our labs can be found in our web site also.

--- END ---