

REVISION HISTORY			
REV	DESCRIPTION	CO#	DATE
A	INITIAL RELEASE	02215	XXXXX

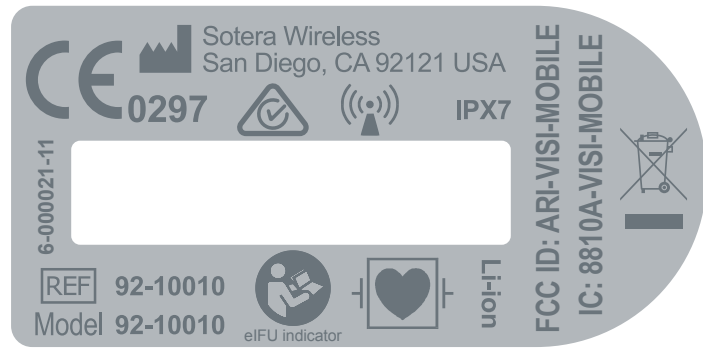

SCALE: 2=1



SCALE: 1=1

CCB STAMP
NOT FOR PRODUCTION
FOR QUOTATION ONLY
 27 APR 2012 1 LC

8. IDENTIFY PACKAGING WITH THIS DOCUMENT NUMBER, QUANTITY, MANUFACTURING LOT NUMBER.
7. COLOR(S) SHOWN ARE APPROXIMATIONS ONLY.
6. DASHED LINES AND REGISTRATION MARKS ARE FOR REFERENCE ONLY, DO NOT PRINT.
5. NOMINAL OVERALL THICKNESS: 0.05mm - 0.235mm (.002" - .0095") WITHOUT LINER.
4. ADHESIVE: 3M 467MP, 0.06mm (.0025") NOMINAL THICKNESS.
3. WINDOW TEXT CLEAR.
2. COLOR: AS SPECIFIED.
1. MATERIAL: SABIC INNOVATIVE PLASTICS, LEXAN FR83, 0.05mm - 0.175mm (.002"- .007") THICK, POST-CURE PER MFG'S RECOMENDATIONS.

NOTES: UNLESS OTHERWISE SPECIFIED.

TOLERANCE (UNLESS OTHERWISE SPECIFIED) DIMENSIONS ARE IN MILLIMETERS X = ±1.27 .X = ±.25 .XX = ±.13 ANGLES = ±1°	Sotera WIRELESS SOTERA WIRELESS, INC. 10020 Huennekens St. San Diego, CA 92121		
	TITLE: LABEL, IDENTIFICATION, WT		
PROPRIETARY AND CONFIDENTIAL THE INFORMATION CONTAINED IN THIS DRAWING IS THE SOLE PROPERTY OF SOTERA WIRELESS, INC. ANY REPRO- DUCATION IN PART OR AS A WHOLE WITHOUT THE WRITTEN PERMISSION OF SOTERA WIRELESS, INC. IS PROHIBITED.	SIZE B	DWG. NO. 6-000021-11	REV A
DRAWN BY F.JACQUEZ	DATE 3/20/2014	SCALE: 1:1	SHEET 1 OF 3

D

C

B

A

D

C

B

A

8

7

6

5

4

3

2

1

8

7

6







5

4

3

2

1



 Sotera Wireless
 San Diego, CA 92121 USA
 0297
 

 IPX7
 6-000021-11

 REF 92-10010
 Model 92-10010
 
 eIFU indicator
 
 Lion
 FCC ID: ARI-VISI-MOBILE
 IC: 8810A-VISI-MOBILE

EVERYTHING SHOWN TO THE LEFT IN BLACK
TO APPEAR IN THE FOLLOWING COLOR:



SCALE: 2=1



EVERYTHING SHOWN TO THE LEFT IN BLACK
TO APPEAR IN THE FOLLOWING COLOR:



CCB STAMP
 NOT FOR PRODUCTION
 FOR QUOTATION ONLY
 27 APR 2012 1 LC

SCALE: 2=1

SIZE	DWG. NO.	REV
B	6-000021-11	A
SCALE: 1:1		SHEET 2 OF 3

D

C

B

A

8

7

6

5

4

3

2

1

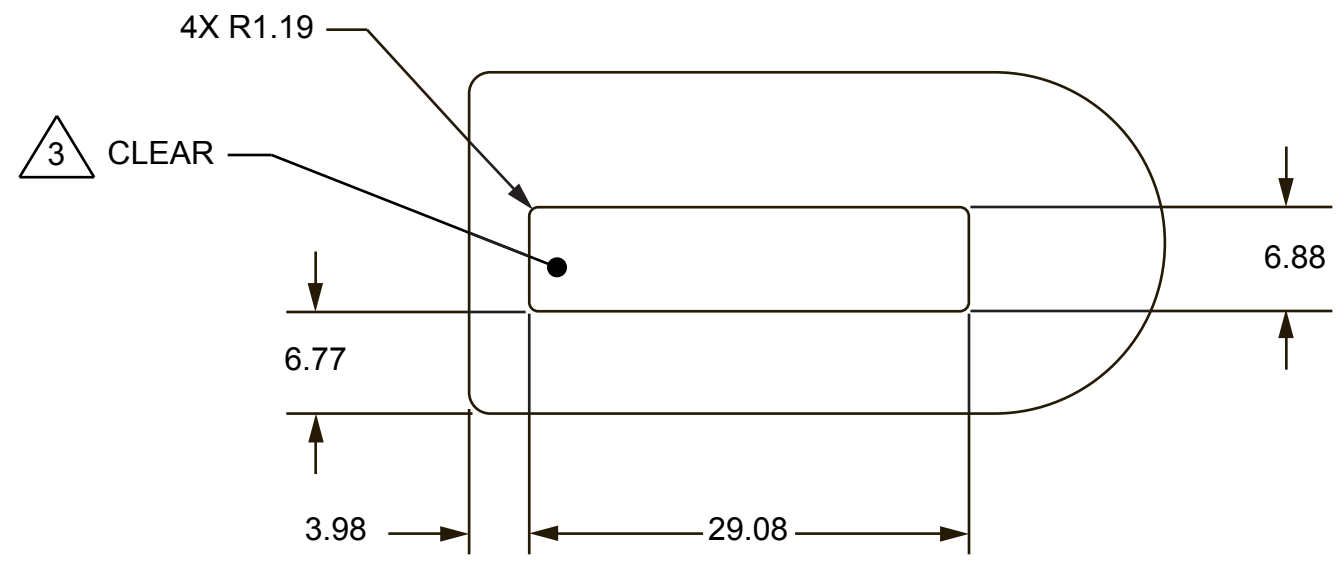

SCALE: 2=1

D

C

B

A

8

7

6

5

4

3

2

1

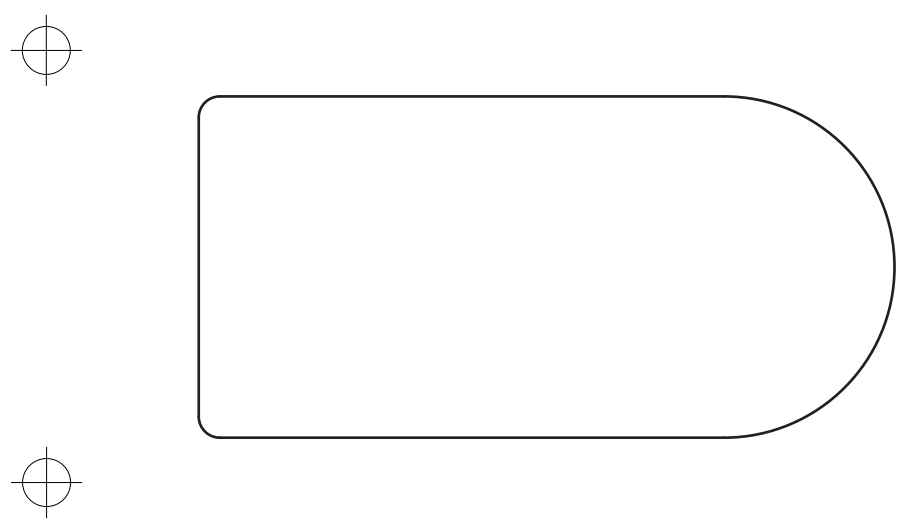

SCALE: 2=1

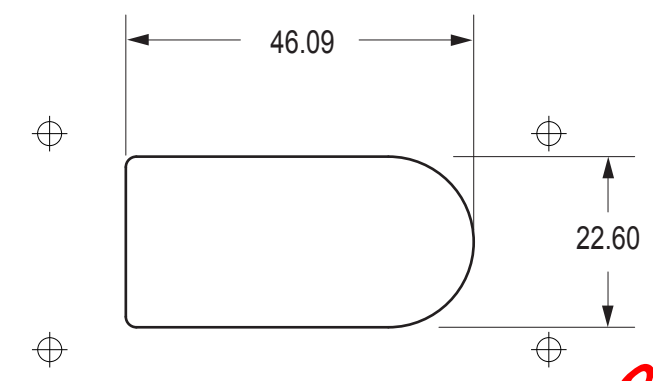

SCALE: 1=1

DIE CUTTING

CCB STAMP
 NOT FOR PRODUCTION
 FOR QUOTATION ONLY
 27 APR 2012 1 LC

SIZE	DWG. NO.	REV
B	6-000021-11	A
SCALE: 1:1		SHEET 3 OF 3