



DATE: 18 May 2016

**I.T.L. (PRODUCT TESTING) LTD.
FCC/IC Radio Test Report
for
Telrad Networks Ltd.**

Equipment under test:

CPE

CPE8000-PRO-1D-3.x

Tested by: _____

M. Zohar

Approved by: _____

For: D. Shidlowsky

This report must not be reproduced, except in full, without the written permission of I.T.L. (Product Testing) Ltd.

This report relates only to items tested.



Measurement/Technical Report for Telrad Networks Ltd.

CPE

CPE8000-PRO-1D-3.x

FCC ID: ARA-CPE8KPRO3XA

IC: 899A-CPE8KPRO3XA

This report concerns:	Original Certification: X Class II change: Class I change:
Equipment type:	FCC: TNB Licensed Non-Broadcast Station Transmitter IC: Wireless Broadband Access (3650-3700 MHz) Unrestricted Contention Protocols
Standards used:	FCC, Part 90, Subpart Z FCC, Part 2 RSS-197, Issue 1, February, 2010 RSS-GEN, Issue 4, November, 2014 SRSP-303.65, Issue 2, June 2010

Measurement procedure used is ANSI C63.10- 2013
Substitution Method used as in ANSI/TIA-603-C: 2004

Application for Certification prepared by:	Applicant for this device: (different from "prepared by")
Ronit Pinchuck	Klara Milman
ITL (Product Testing) Ltd.	Telrad Networks Ltd.
1 Bat Sheva Street	1 Batsheva St., P.O.B 6118
Lod 711600	Lod 711600
Israel	Israel
e-mail rpinchuck@itl.co.il	Tel: +972-73-246-7651 Fax: +972-73-246-7504 e-mail: Klara.Milman@telrad.com



TABLE OF CONTENTS

1.	GENERAL INFORMATION	5
1.1	Administrative Information	5
1.2	Abbreviations and Symbols	6
1.3	List of Accreditations	7
1.4	Product Description	8
1.5	Test Methodology	8
1.6	Test Facility	8
1.7	Measurement Uncertainty	8
2.	SYSTEM TEST CONFIGURATION	9
2.1	Justification	9
2.2	Product Data	9
2.3	EUT Exercise Software	9
2.4	Special Accessories	9
2.5	Equipment Modifications	9
2.6	Configuration of Tested System	10
3.	TEST SET-UP PHOTOS	11
4.	CHANNEL BANDWIDTH	15
4.1	Test Specification	15
4.2	Test Procedure	15
4.3	Limit	15
4.4	Test Results	15
4.5	Test Equipment Used; Occupied Bandwidth	35
5.	TRANSMITTER FREQUENCY STABILITY	36
5.1	Test Specification	36
5.2	Test Procedure	36
5.3	Limit	36
5.4	Test Results	37
5.5	Test Instruments Used; Frequency Stability	45
6.	TRANSMITTER OUTPUT POWER AND EQUIVALENT ISOTROPICALLY RADIATED POWER (E.I.R.P.)	46
6.1	Test Specification	46
6.2	Test Procedure	46
6.3	FCC Limit	46
6.4	IC Limit	46
6.5	Test Results	47
6.6	Test Equipment Used; Transmitter Output Power and EIRP	90
7.	EMISSION MASKS	91
7.1	Test Specification	91
7.2	Test Procedure	91
7.3	Limit	91
7.4	Test Results	91
7.5	Test Equipment Used; Transmitter Output Power and EIRP	110
8.	CONDUCTED TRANSMITTER UNWANTED EMISSIONS	111
8.1	Test Specification	111
8.2	Test Procedure	111
8.3	Limit	111
8.4	Test Results	111
8.5	Test Equipment Used; Conducted Unwanted Emissions	172
9.	RADIATED UNWANTED EMISSIONS	173
9.1	Test Specification	173
9.2	Test Procedure	173
9.3	Limit	174
9.4	Test Results	174
9.5	Test Instrumentation Used; Spurious Radiated Emission	176



10.	RECEIVER SPURIOUS EMISSIONS	177
10.1	Test Specification	177
10.2	Test Procedure	177
10.3	Limit	177
10.4	Test Results.....	177
10.5	Test Instrumentation Used; Receiver Spurious Emissions	180
11.	ANTENNA GAIN/INFORMATION	181
12.	APPENDIX A - CORRECTION FACTORS	182
12.1	Correction factors for CABLE	182
12.2	Correction factors for Log Periodic Antenna	183
12.3	Correction factors for Biconical Antenna.....	184
12.4	Correction factors for ACTIVE LOOP ANTENNA	185
12.5	Correction factors for Horn ANTENNA.....	186
12.6	Correction factors for Horn Antenna	187
12.7	Correction factors for Horn Antenna Ka Band.....	188



1. General Information

1.1 Administrative Information

Manufacturer: Telrad Networks Ltd.

Manufacturer's Address: 1 Batsheva St.
P.O.B. 6118
Lod 711600
Israel
Tel: +972-73-246-7651
Fax: +972-73-246-7504

Manufacturer's Representative: Klara Milman

Equipment Under Test (E.U.T): CPE

Equipment Product No.: CPE8000-PRO-1D-3.x

Serial Number No.: Not designated

HVIN: CPE8000PRO3XA

Date of Receipt of E.U.T: 14.02.2016

Start of Test: 23.02.2016

End of Test: 20.03.2016

Test Laboratory Location: I.T.L (Product Testing) Ltd.
1 Batsheva St,
Lod, Israel 7116002

Test Specifications: FCC Part 90, Subpart Z
FCC Part 2
RSS-197, Issue 1: 2010
RSS-GEN, Issue 4: 2014
SRSP-303.65, Issue 2: 2010



1.2 **Abbreviations and Symbols**

The following abbreviations and symbols are applicable to this test report:

A/m	ampere per meter
AC	alternating current
AM	amplitude modulation
AMN	Artificial Mains Network
ARA	Antenna Research Associates
Aux	auxiliary
Avg	average
CBW	channel bandwidth
CDN	coupling-decoupling network
cm	centimeter
dB	decibel
dBm	decibel referred to one milliwatt
db μ V	decibel referred to one microvolt
db μ V/m	decibel referred to one microvolt per meter
DC	direct current
EFT/B	electrical fast transient/burst
EMC	electromagnetic compatibility
ESD	electrostatic discharge
E.U.T.	equipment under test
GHz	gigahertz
HP	Hewlett Packard
Hz	Hertz
kHz	kilohertz
kV	kilovolt
LED	light emitting diode
LISN	line impedance stabilization network
m	meter
mHn	millihenry
MHz	megahertz
msec	millisecond
N/A	not applicable
per	period
QP	quasi-peak
PC	personal computer
RF	radio frequency
RE	radiated emission
sec	second
V	volt
V/m	volt per meter
VRMS	volts root mean square



1.3 List of Accreditations

The EMC laboratory of I.T.L. is accredited by the following bodies:

1. The American Association for Laboratory Accreditation (A2LA) (U.S.A.), Certificate No. 1152.01.
2. The Federal Communications Commission (FCC) (U.S.A.), FCC Designation Number IL1005.
3. The Israel Ministry of the Environment (Israel), Registration No. 1104/01.
4. The Voluntary Control Council for Interference by Information Technology Equipment (VCCI) (Japan), Registration Numbers: C-3006, R-2729, T-1877, G-245.
5. Industry Canada (Canada), IC File No.: 46405-4025; Site No. IC 4025A-1, IC 4025A-2.



1.4 Product Description

The E.U.T. is a high performance 4G LTE outdoor CPE product designed to enable quick LTE fixed data service deployment to the remote customers. It provides high data throughput and networking features to end users who need both bandwidth and quality service in the remote area.

1.5 Test Methodology

Conducted and radiated testing were performed according to the procedures in ANSI C63.10: 2013, FCC Part 90, Subpart Z, RSS-197, Issue 1: 2010, RSS-Gen, Issue 4: 2014 and SRSP-303.65, Issue 2: 2010. Radiated testing was performed at an antenna to EUT distance of 3 meters.

1.6 Test Facility

Radiated emissions tests were performed at I.T.L.'s testing facility in Lod, Israel. I.T.L.'s EMC Laboratory is accredited by A2LA, certificate No. 1152.01 and its FCC Designation Number is IL1005.

1.7 Measurement Uncertainty

Conducted Emission (CISPR 11, EN 55011, CISPR 22, EN 55022, ANSI C63.4)

0.15 – 30 MHz:

Expanded Uncertainty (95% Confidence, K=2):

± 3.44 dB

Radiated Emission (CISPR 11, EN 55011, CISPR 22, EN 55022, ANSI C63.4) for open site 30-1000MHz:

Expanded Uncertainty (95% Confidence, K=2):

± 4.96 dB

2. System Test Configuration

2.1 Justification

All measurements was performed conducted except for radiated spurious emissions which was performed with the E.U.T in the installation position.

2.2 Product Data

EUT	CPE8000-PRO-1D-3.X
Working voltage	115 AC via POE
Mode of operation	TRANSCIEVER CPE
Modulations	QPSK, 16QAM, 64QAM
Operation Frequency Range	3650.0-3700.0 MHz
Antenna Gain	15.0dBi
Modulation BW	5MHz, 10MHz, 15MHz, 20MHz

2.3 EUT Exercise Software

CPE8000 V2.1 PACK7 (ver360) software was used.

2.4 Special Accessories

No special accessories were needed in order to achieve compliance.

2.5 Equipment Modifications

No modifications were necessary in order to achieve compliance.

2.6 Configuration of Tested System

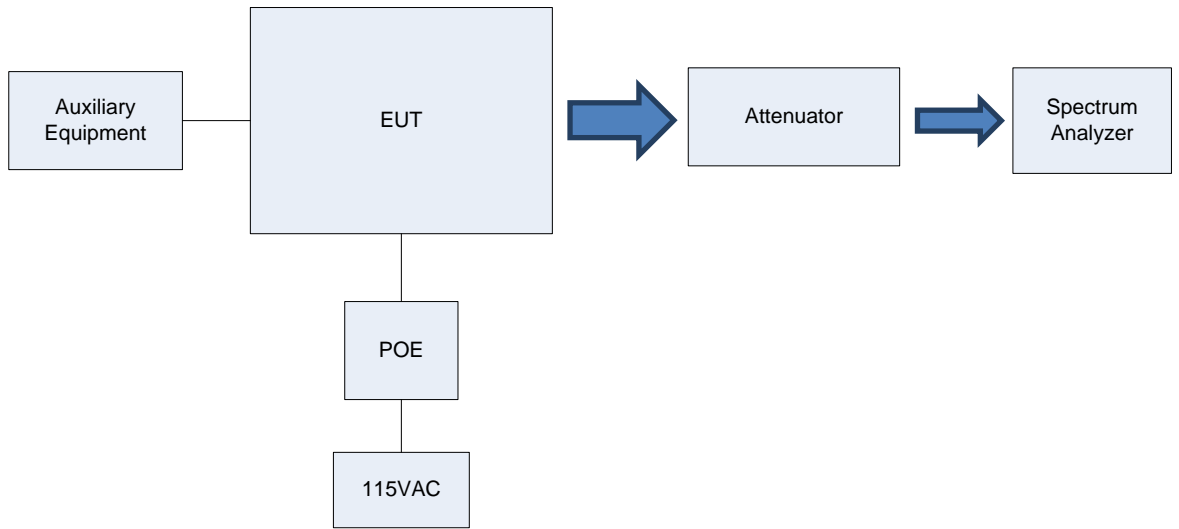

Figure 1. Conducted Emission From Antenna Ports Test Set-up

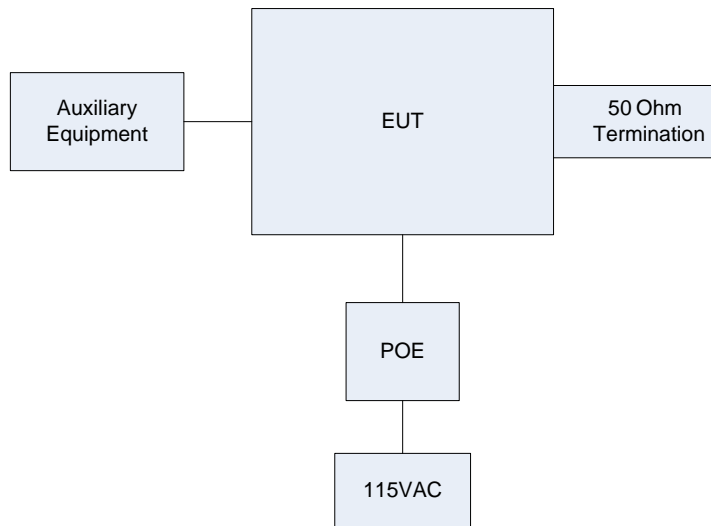

Figure 2. Radiated Emission Test Set-Up

3. Test Set-up Photos

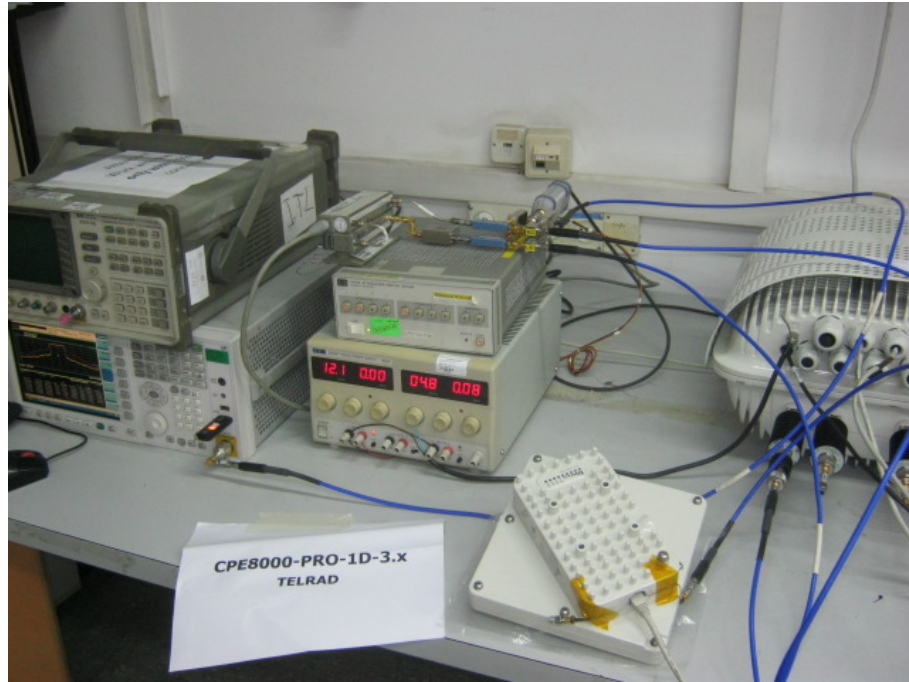

Figure 3. Conducted Emission From Antenna Port Tests

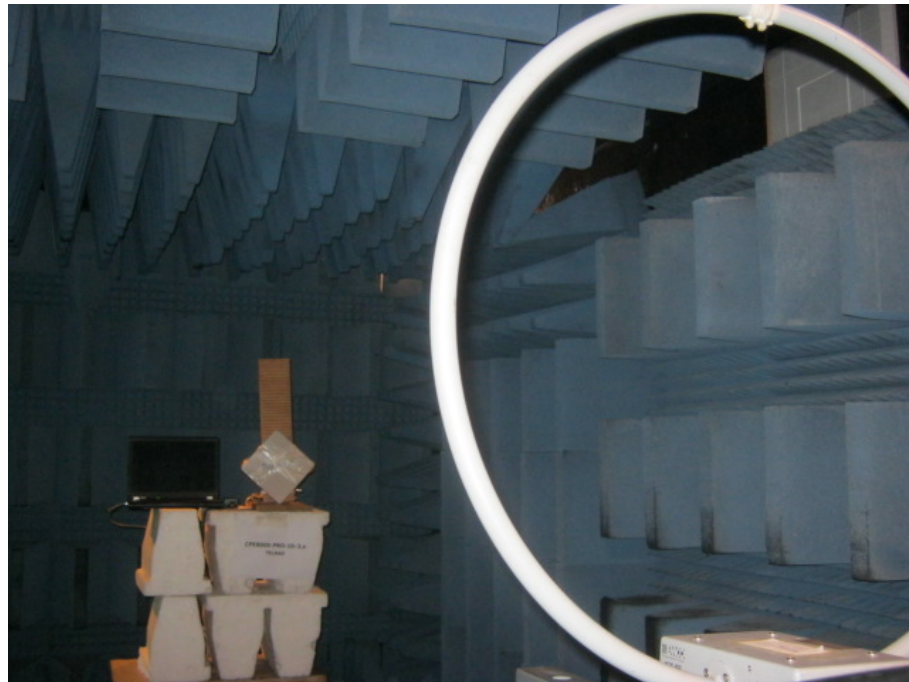

Figure 4. Radiated Emission Test



Figure 5. Radiated Emission Test



Figure 6. Radiated Emission Test

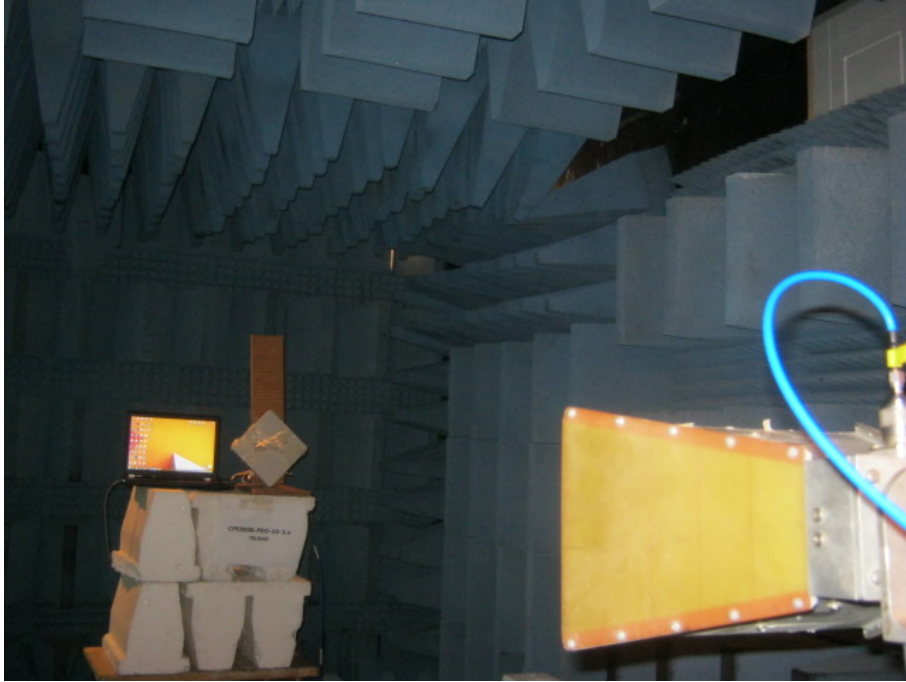

Figure 7. Radiated Emission Test



Figure 8. Radiated Emission Test



Figure 9. Radiated Emission Test

4. Channel Bandwidth

4.1 Test Specification

RSS 197, Issue 1:2010, Section 5.2

FCC, Part 2, Section 2.1049

4.2 Test Procedure

The E.U.T. was set to the applicable test frequency with OFDMA modulations and 5MHz, 10MHz, 15MHz and 20MHz CBW.

The E.U.T. antenna terminal was connected to the Spectrum Analyzer through an external attenuator, an appropriate coaxial cable, coupler, and DC block, (total loss=-35.2 dB). The spectrum analyzer was set to proper resolution B.W. The occupied bandwidth, that is the frequency bandwidth such that, below its lower and above its upper frequency limit, the mean powers radiated are each equal to 0.5% of the total mean power radiated by a given emission.

4.3 Limit

The channel bandwidth shall be equal or greater than 1 MHz.

4.4 Test Results

JUDGEMENT: Passed

See additional information in *Figure 14* to *Figure 49*.

Operating Frequency (MHz)	Modulation	Reading (MHz)	Limit (MHz)
3652.5	64QAM	3.6	≥1.0
	16QAM	3.6	≥1.0
	QPSK	3.6	≥1.0
3675.0	64QAM	3.6	≥1.0
	16QAM	3.6	≥1.0
	QPSK	3.6	≥1.0
3697.5	64QAM	3.6	≥1.0
	16QAM	3.6	≥1.0
	QPSK	3.6	≥1.0

Figure 10. Occupied Bandwidth Test Results 5 MHz, CBW

Operating Frequency	Modulation	Reading	Limit
(MHz)		(MHz)	(MHz)
3655.0	64QAM	8.6	≥ 1.0
	16QAM	8.6	≥ 1.0
	QPSK	8.6	≥ 1.0
3675.0	64QAM	8.6	≥ 1.0
	16QAM	8.6	≥ 1.0
	QPSK	8.6	≥ 1.0
3695.0	64QAM	8.6	≥ 1.0
	16QAM	8.6	≥ 1.0
	QPSK	8.6	≥ 1.0

Figure 11. Occupied Bandwidth Test Results 10 MHz, CBW

Operating Frequency	Modulation	Reading	limit
(MHz)		(MHz)	(MHz)
3657.5	64QAM	12.9	≥ 1.0
	16QAM	12.9	≥ 1.0
	QPSK	12.9	≥ 1.0
3675.0	64QAM	12.9	≥ 1.0
	16QAM	12.9	≥ 1.0
	QPSK	12.9	≥ 1.0
3692.5	64QAM	12.9	≥ 1.0
	16QAM	12.9	≥ 1.0
	QPSK	12.9	≥ 1.0

Figure 12. Occupied Bandwidth Test Results 15 MHz, CBW

Operating Frequency	Modulation	Reading	limit
(MHz)		(MHz)	(MHz)
3660.0	64QAM	17.2	≥ 1.0
	16QAM	17.2	≥ 1.0
	QPSK	17.2	≥ 1.0
3675.0	64QAM	17.2	≥ 1.0
	16QAM	17.2	≥ 1.0
	QPSK	17.2	≥ 1.0
3690.0	64QAM	17.3	≥ 1.0
	16QAM	17.2	≥ 1.0
	QPSK	17.2	≥ 1.0

Figure 13. Occupied Bandwidth Test Results 20 MHz, CBW

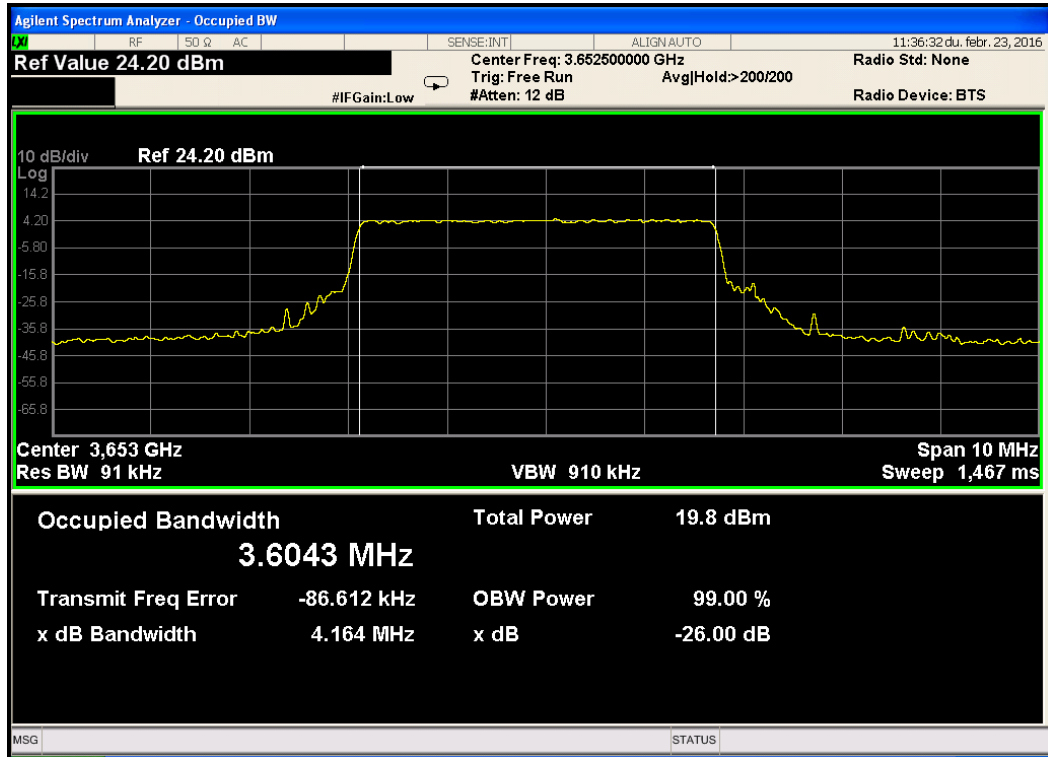

Figure 14. 5MHz CBW – Operating Frequency 3652.5MHz, 64QAM

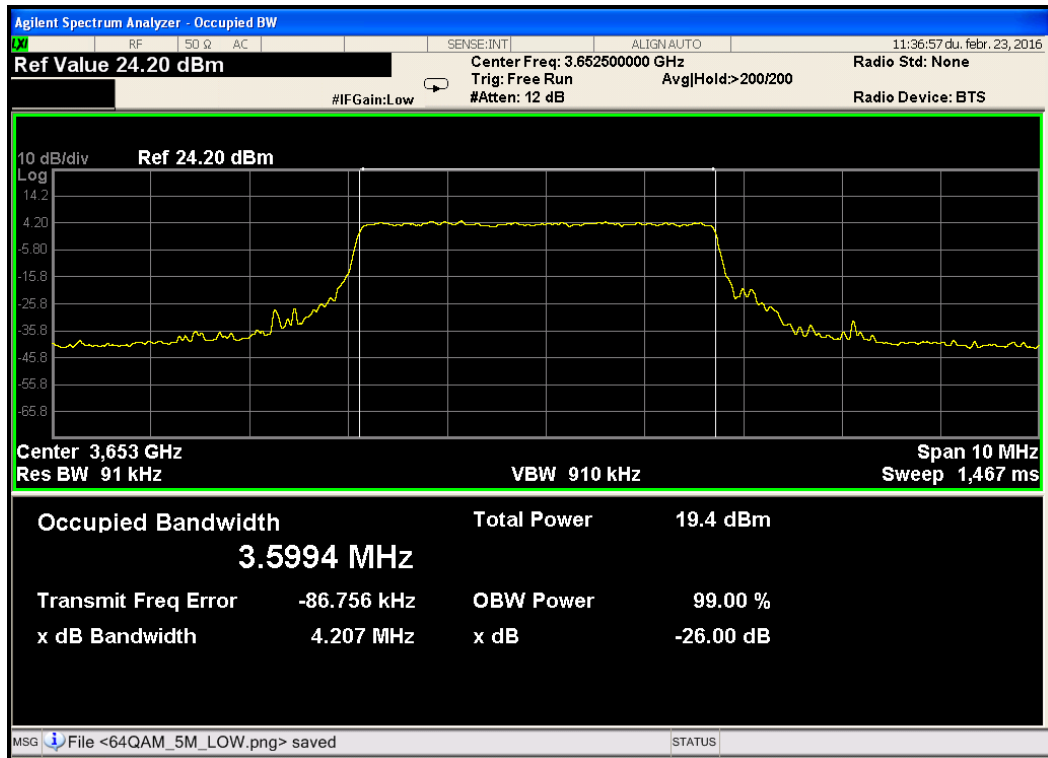

Figure 15. 5MHz CBW – Operating Frequency 3652.5MHz, 16QAM

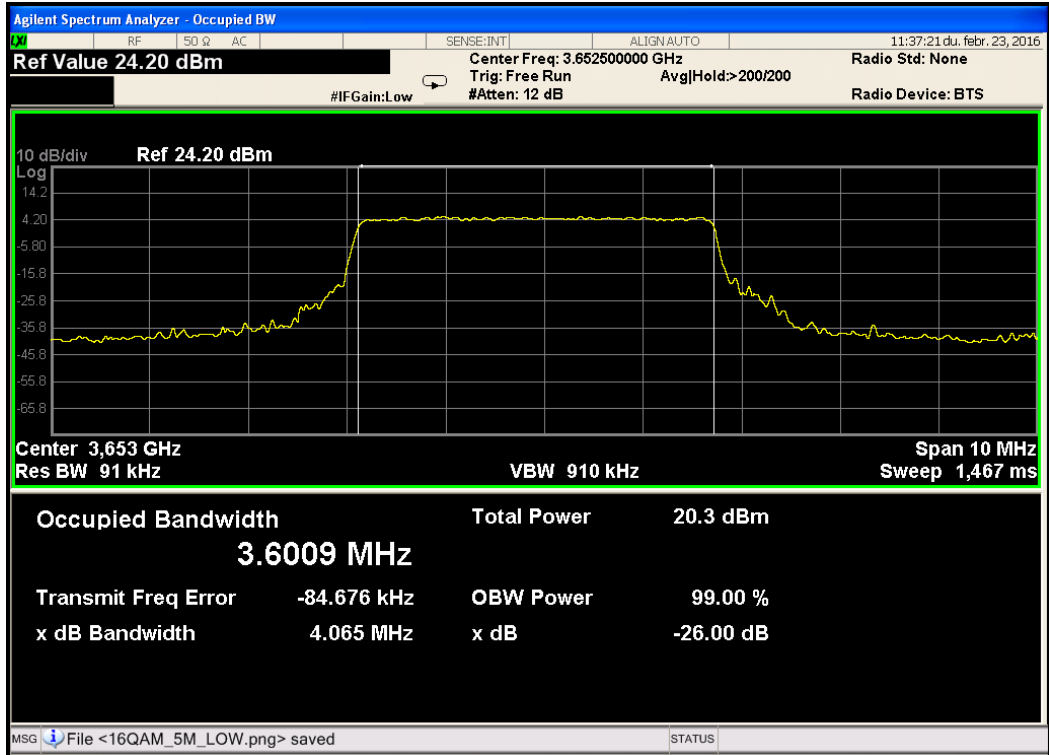

Figure 16. 5MHz CBW – Operating Frequency 3652.5MHz, QPSK

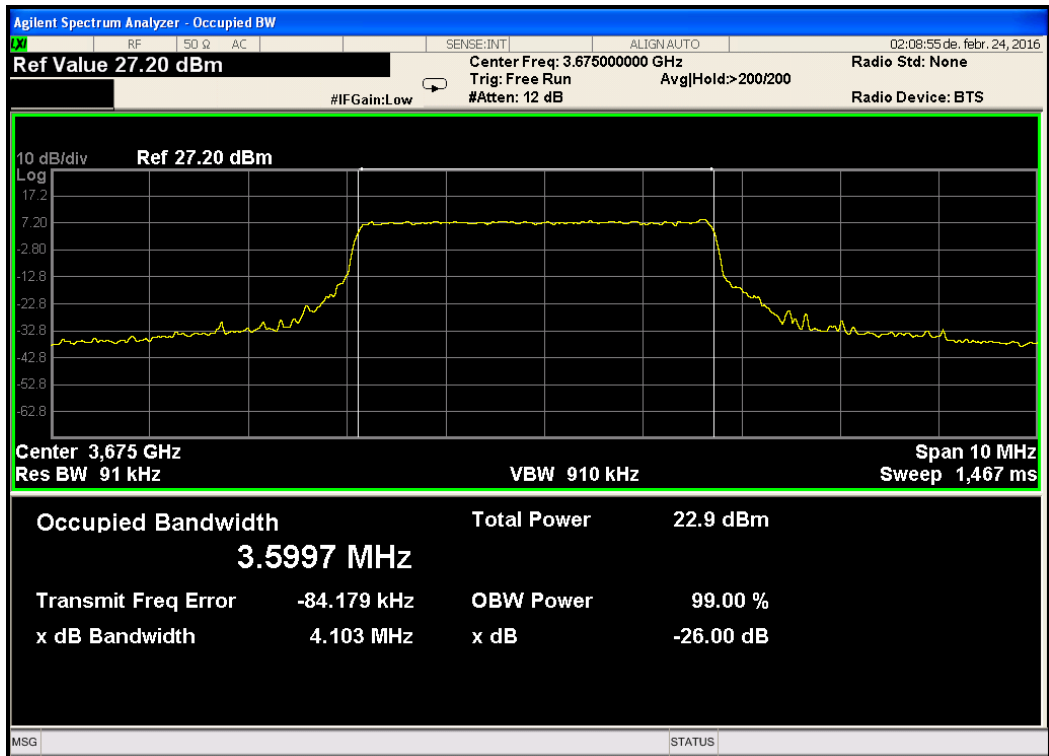

Figure 17. 5MHz CBW – Operating Frequency 3675.0MHz, 64QAM

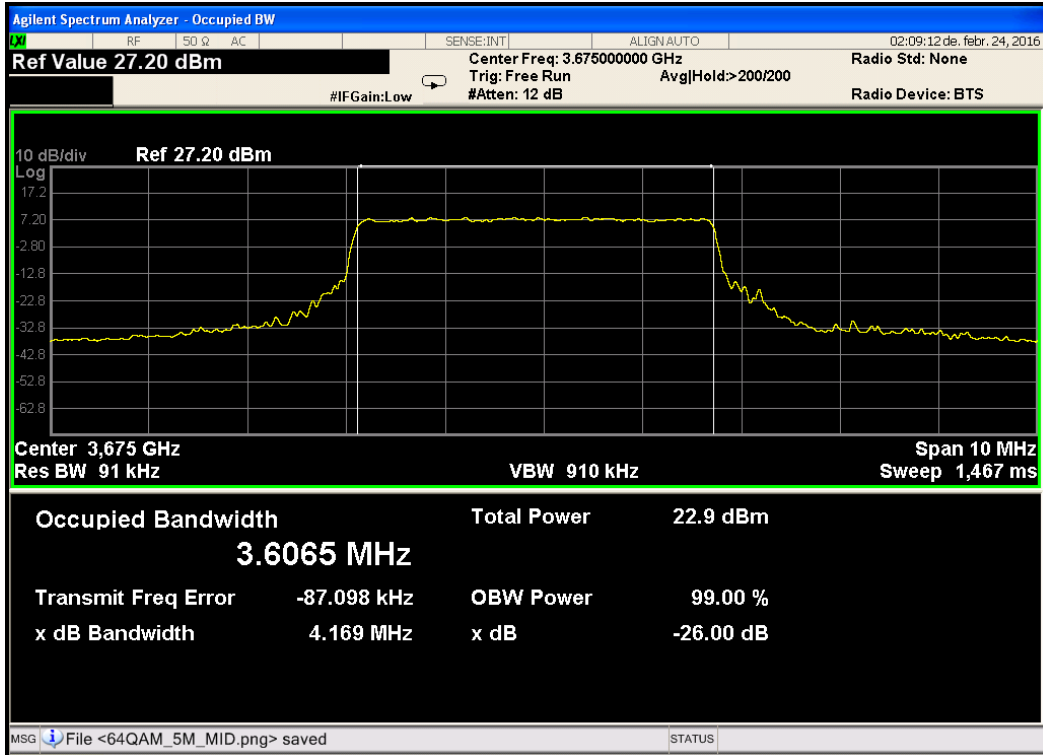

Figure 18. 5MHz CBW – Operating Frequency 3675.0MHz, 16QAM

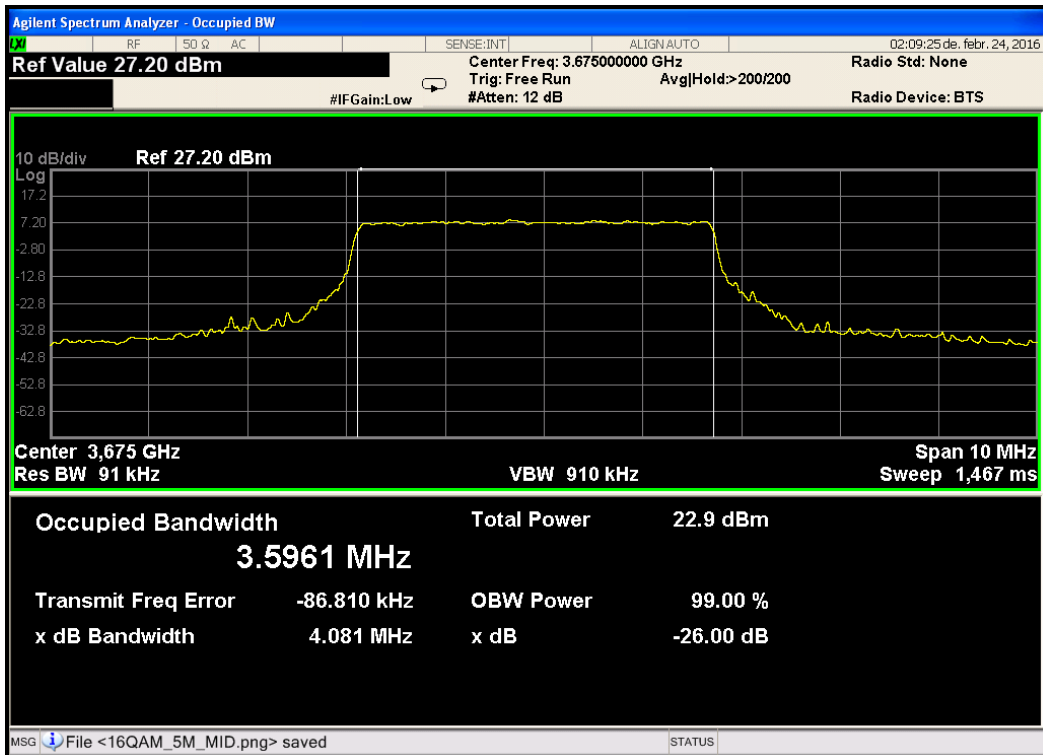

Figure 19. 5MHz CBW – Operating Frequency 3675.0MHz, QPSK

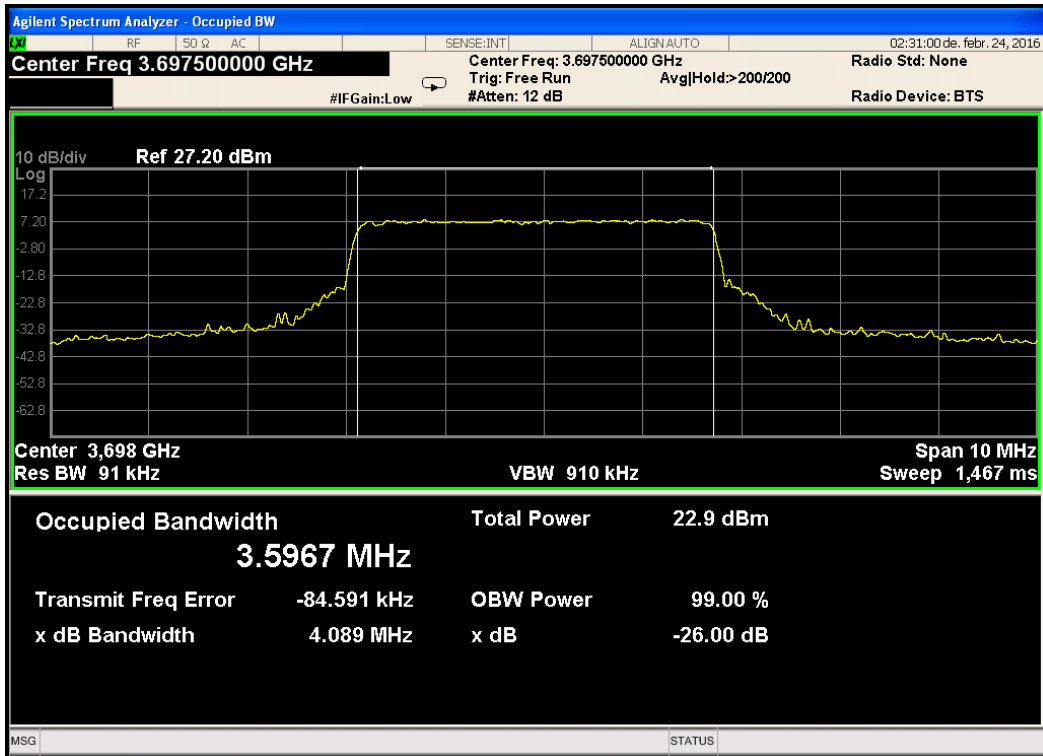

Figure 20. 5MHz CBW – Operating Frequency 3697.5MHz, 64QAM

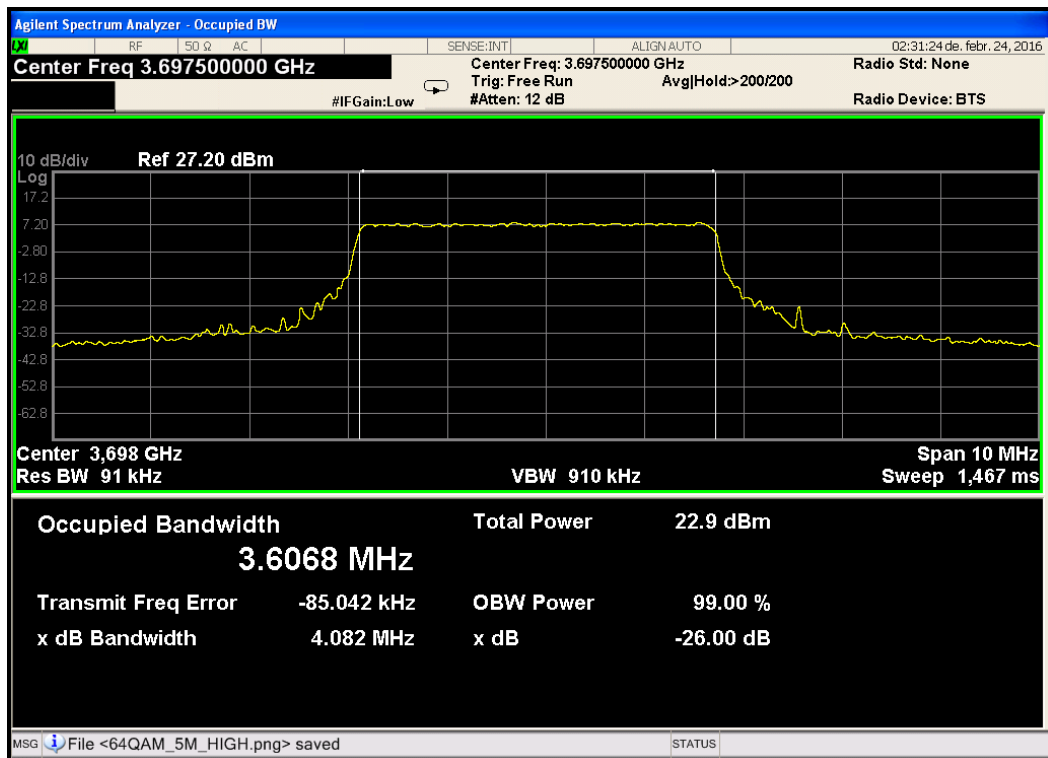

Figure 21. 5MHz CBW – Operating Frequency 3697.5MHz, 16QAM

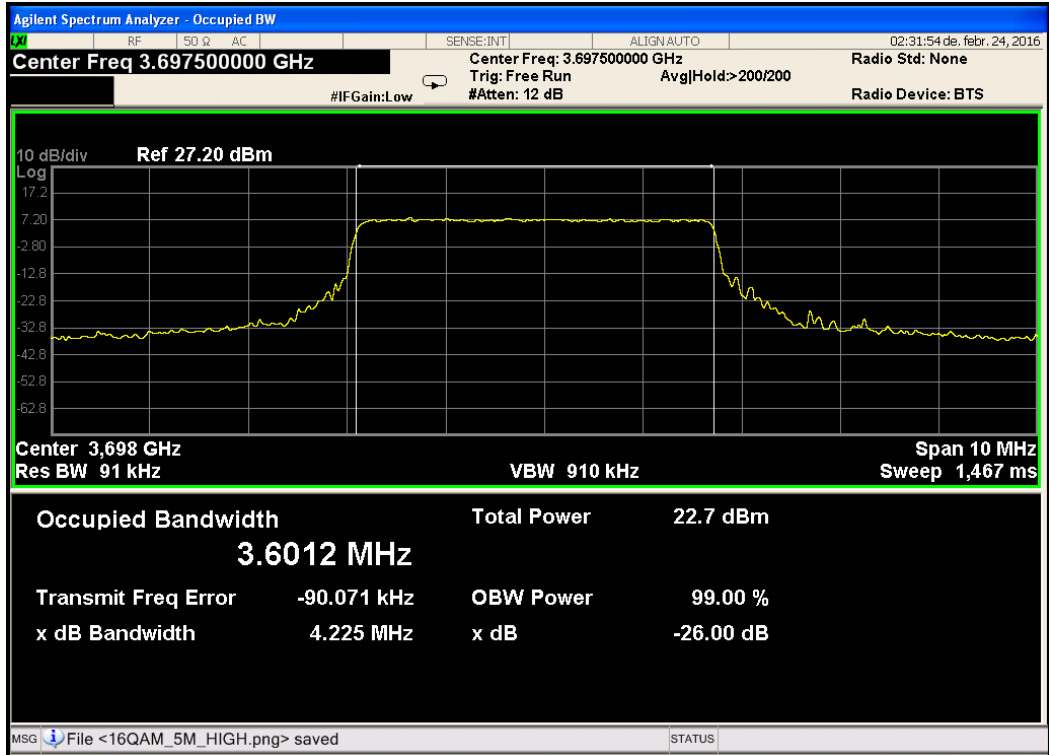

Figure 22. 5MHz CBW – Operating Frequency 3697.5MHz, QPSK

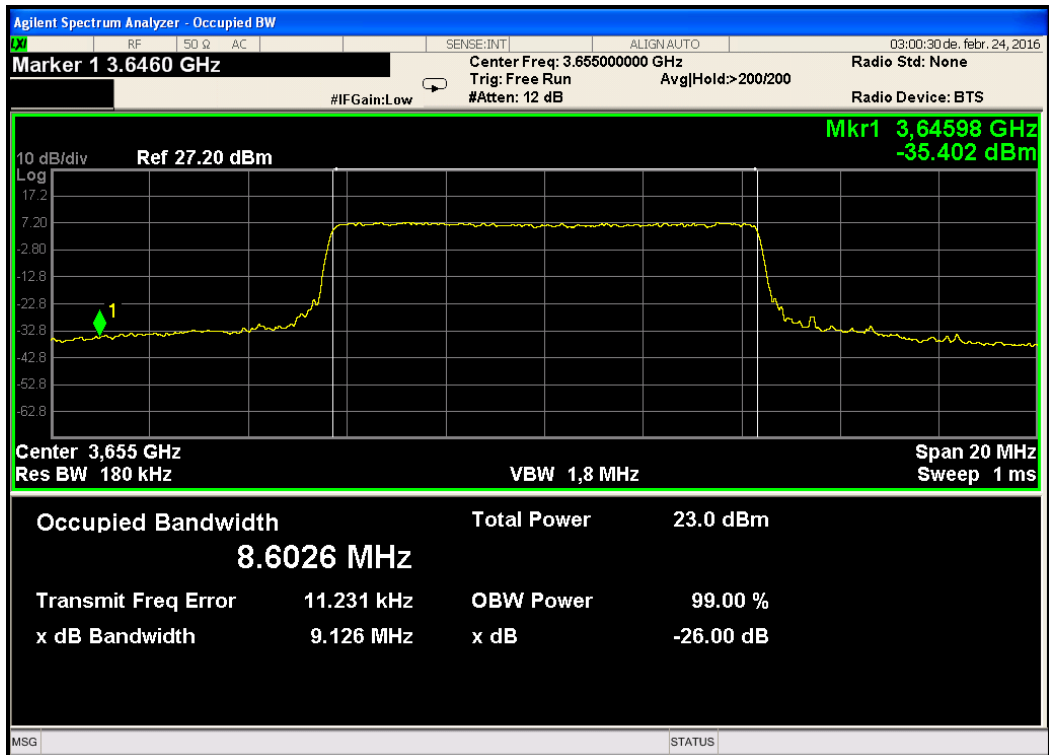

Figure 23. 10MHz CBW – Operating Frequency 3655.0MHz, 64QAM

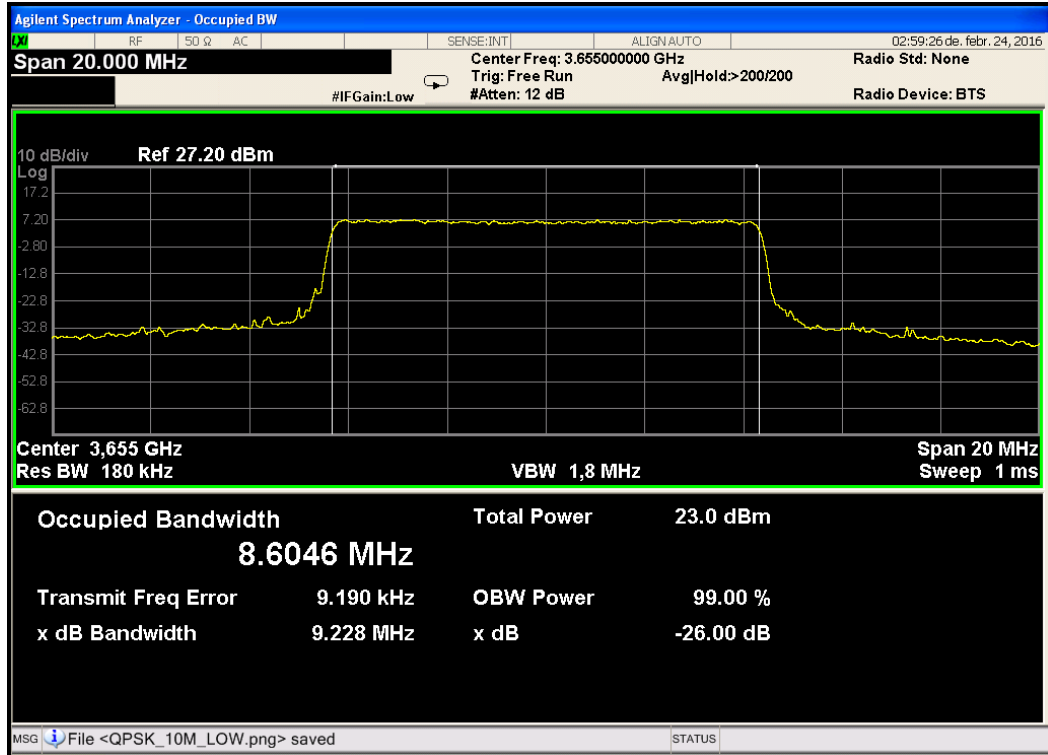

Figure 24. 10MHz CBW – Operating Frequency 3655.0MHz, 16QAM

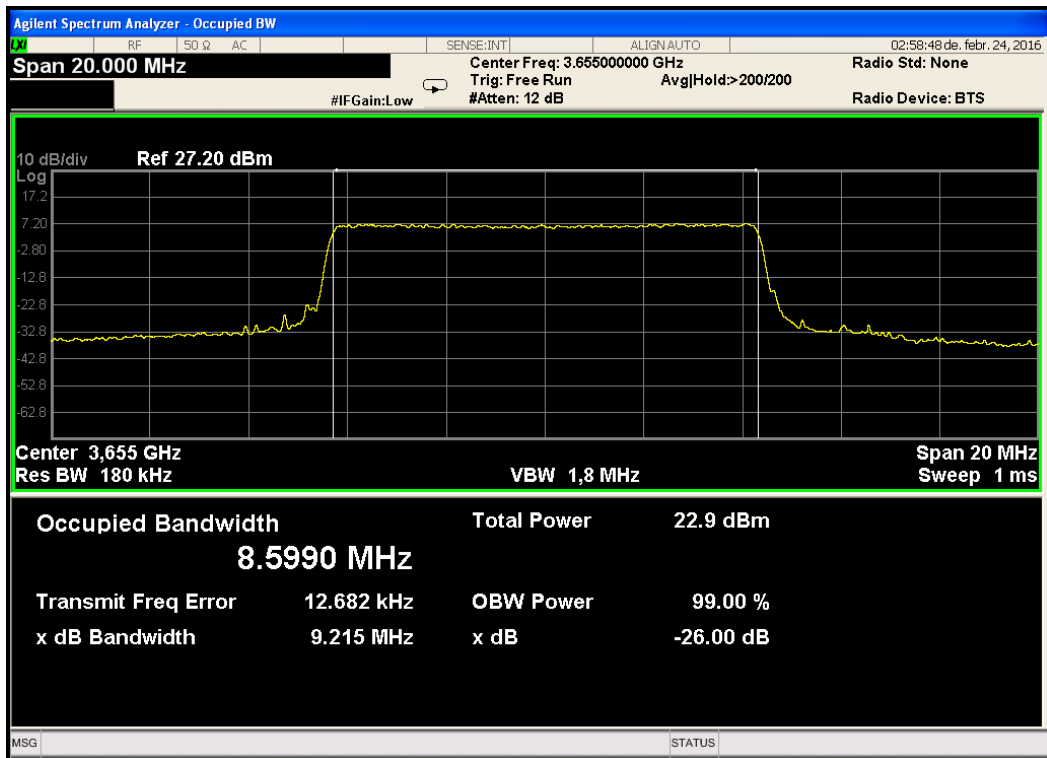

Figure 25. 10MHz CBW – Operating Frequency 3655.0MHz, QPSK

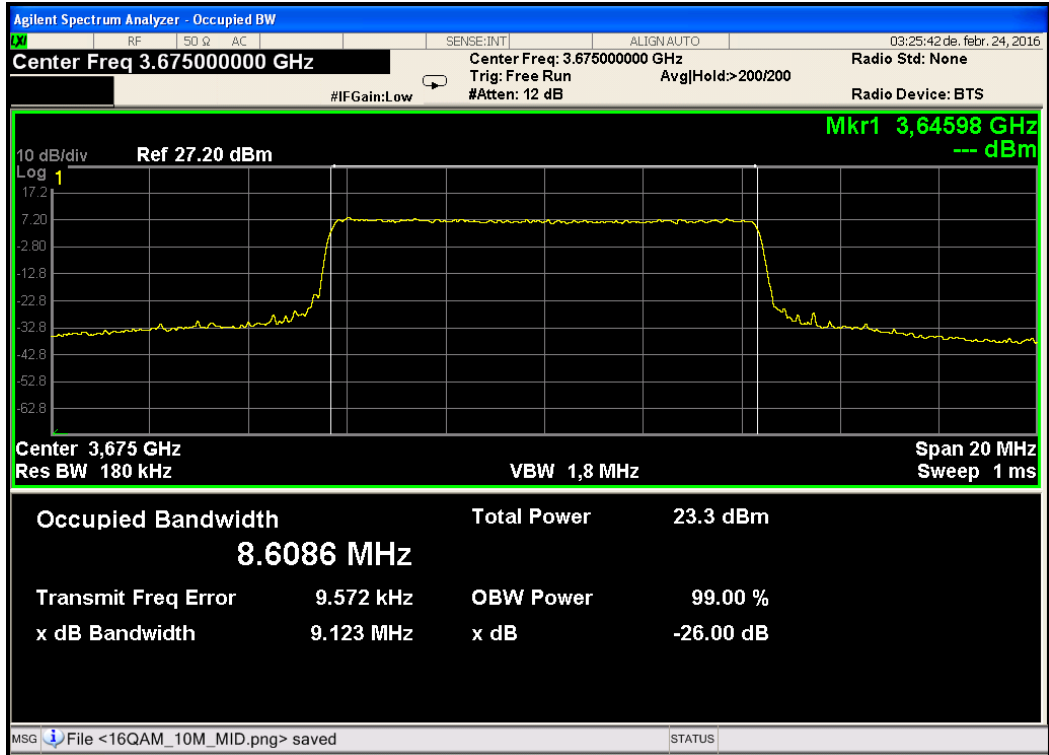

Figure 26. 10MHz CBW – Operating Frequency 3675.0MHz, 64QAM

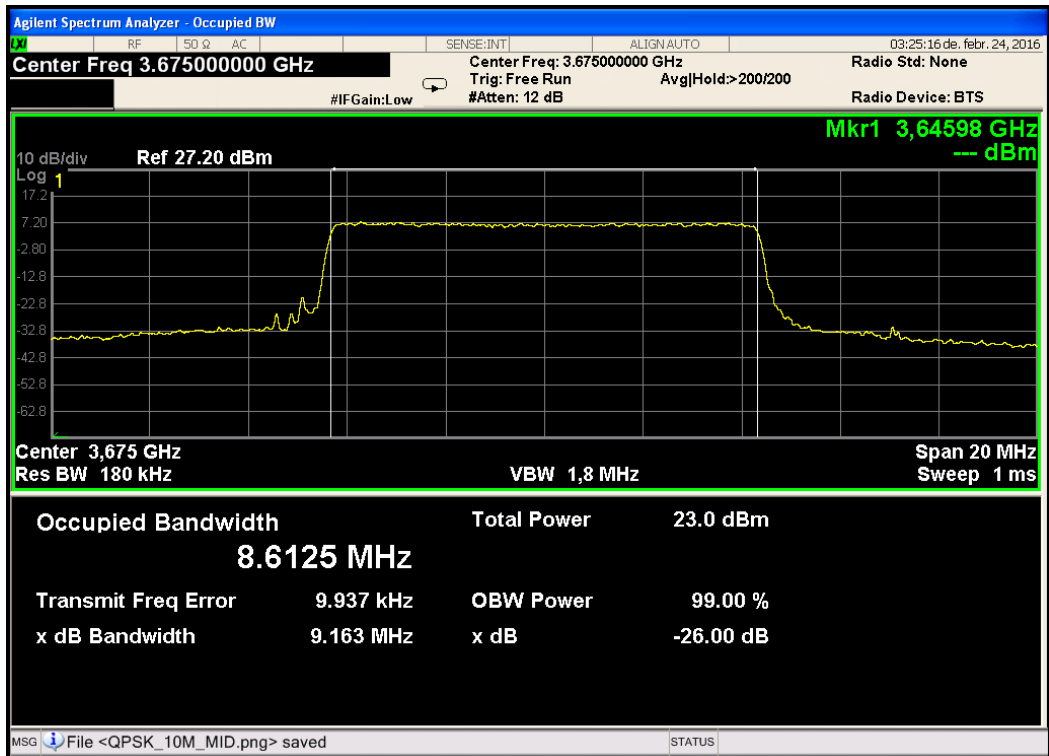

Figure 27. 10MHz CBW – Operating Frequency 3675.0MHz, 16QAM

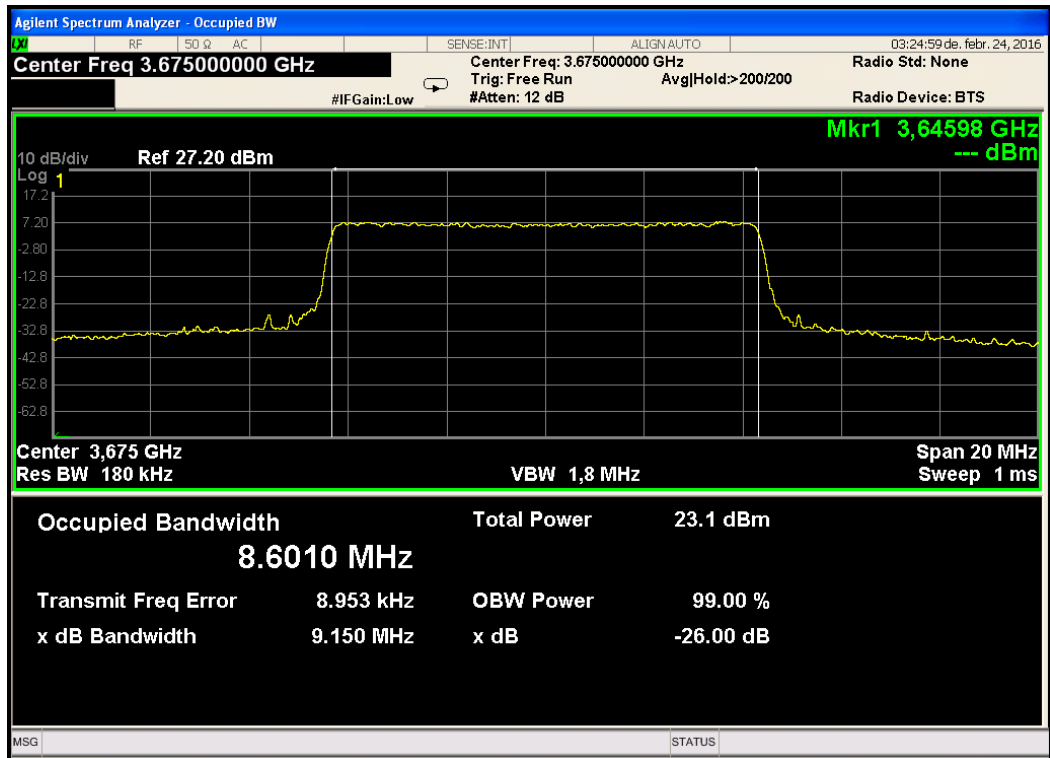

Figure 28. 10MHz CBW – Operating Frequency 3675.0MHz, QPSK

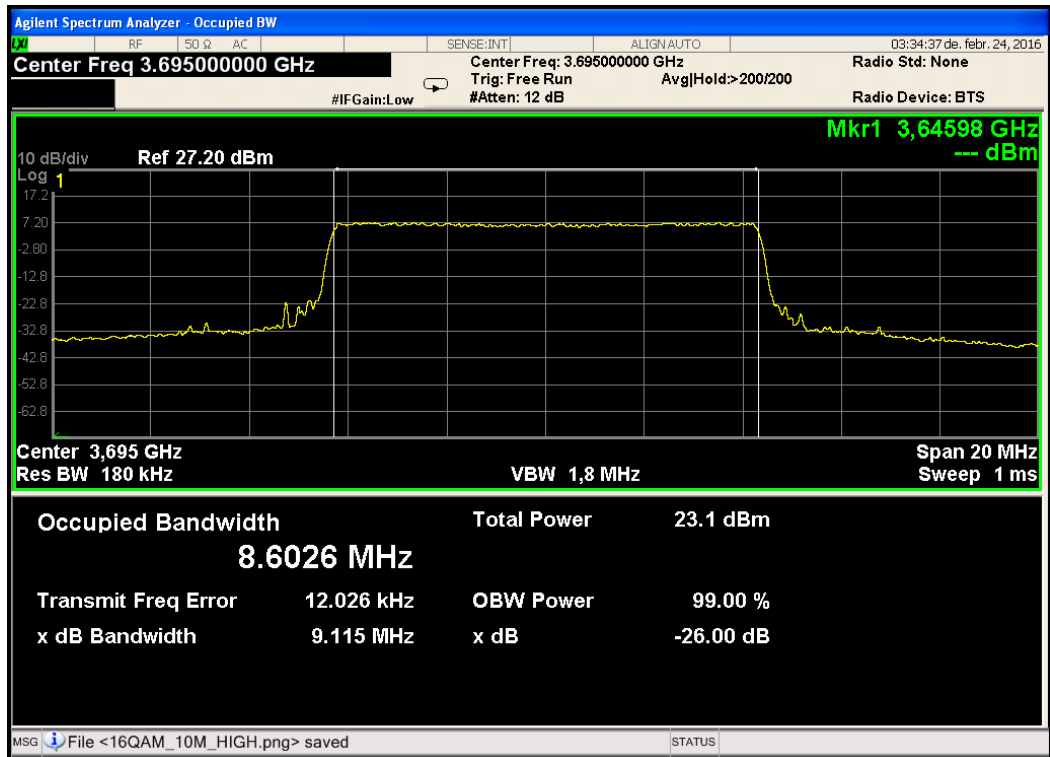

Figure 29. 10MHz CBW – Operating Frequency 3695.0MHz, 64QAM

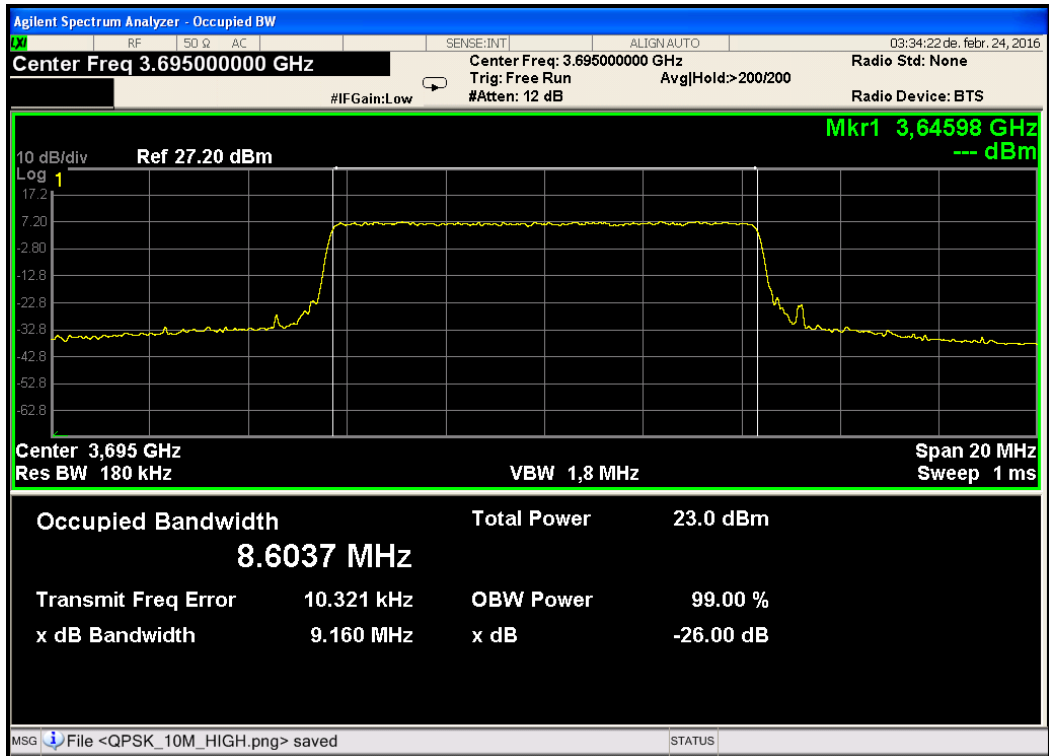

Figure 30. 10MHz CBW – Operating Frequency 3695.0MHz, 16QAM

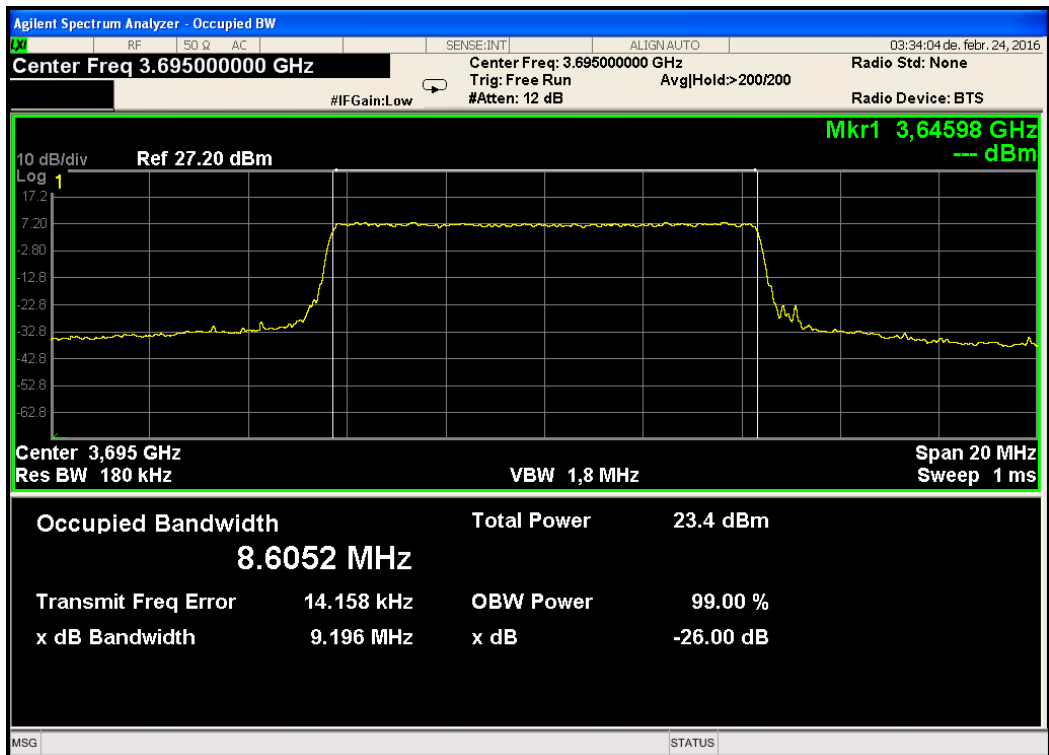

Figure 31. 10MHz CBW – Operating Frequency 3695.0MHz, QPSK

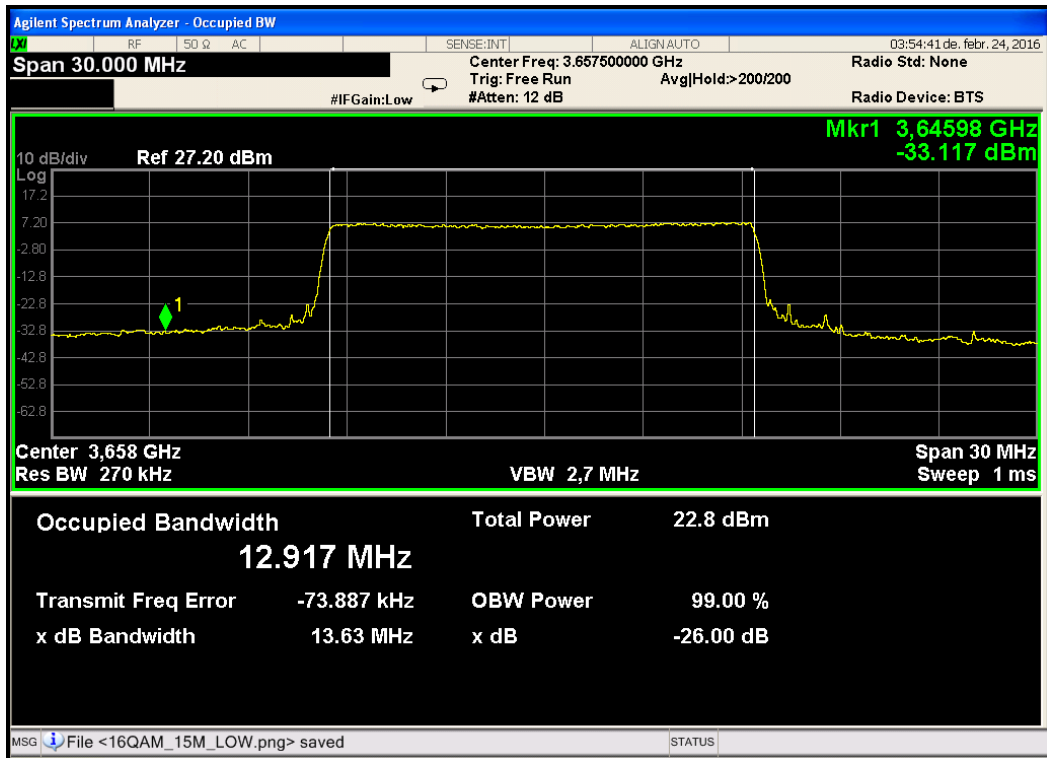

Figure 32. 15MHz CBW – Operating Frequency 3657.5MHz, 64QAM

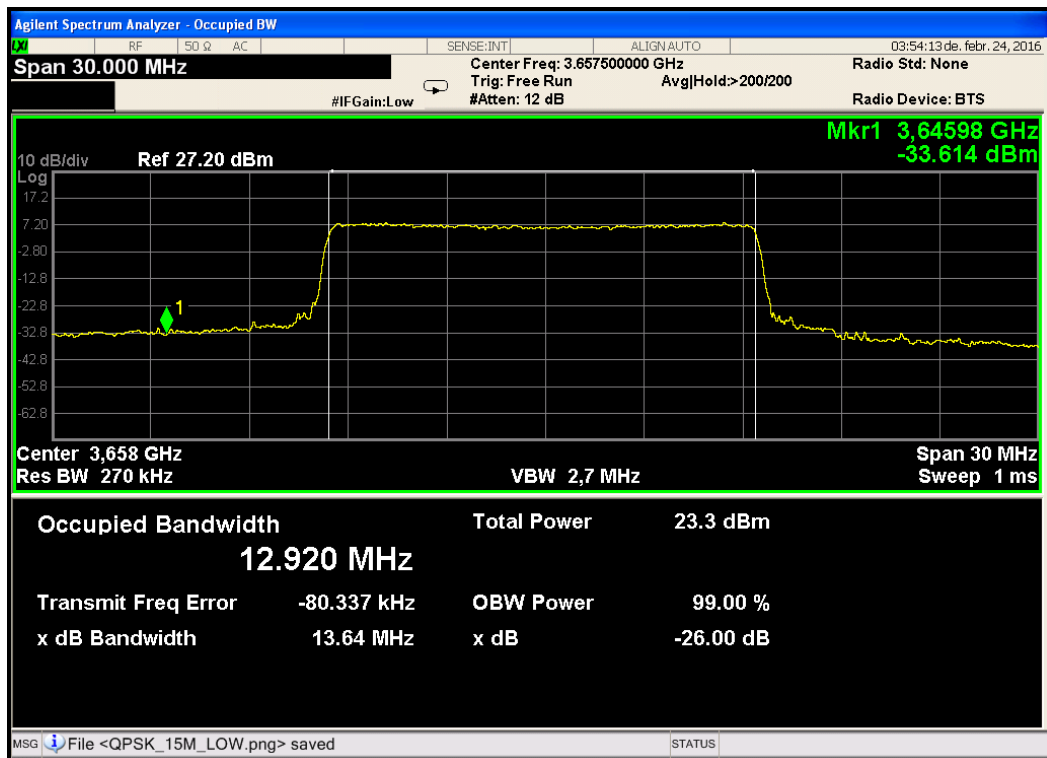

Figure 33. 15MHz CBW – Operating Frequency 3657.5MHz, 16QAM

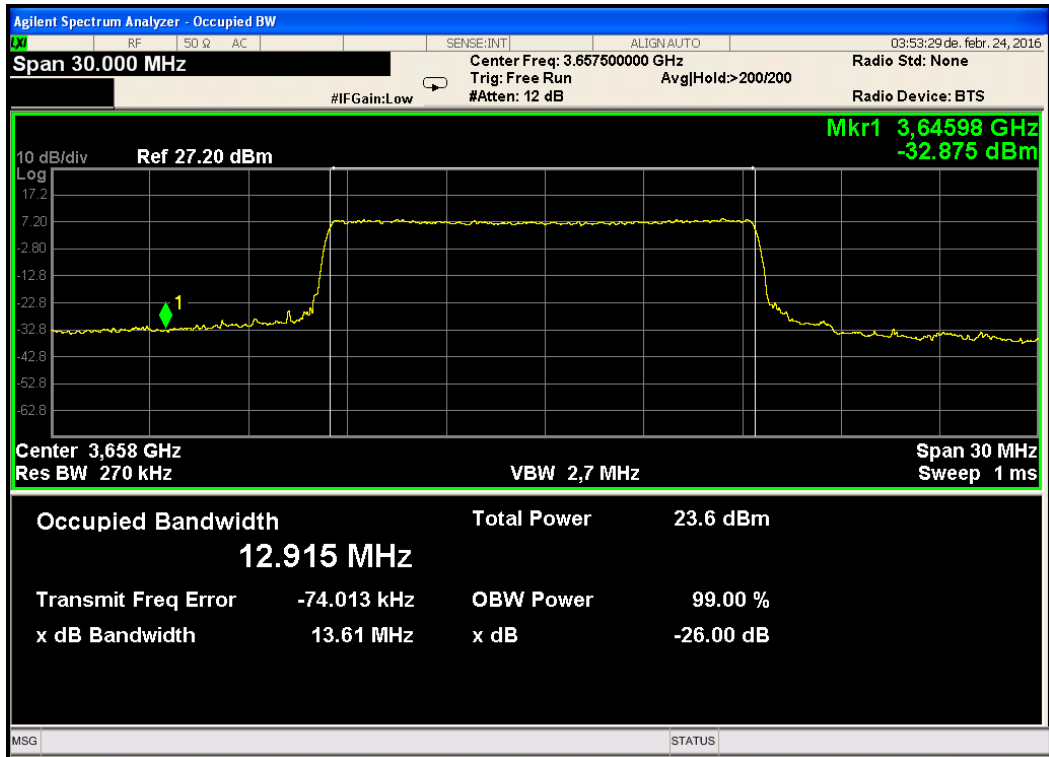

Figure 34. 15MHz CBW – Operating Frequency 3657.5MHz, QPSK

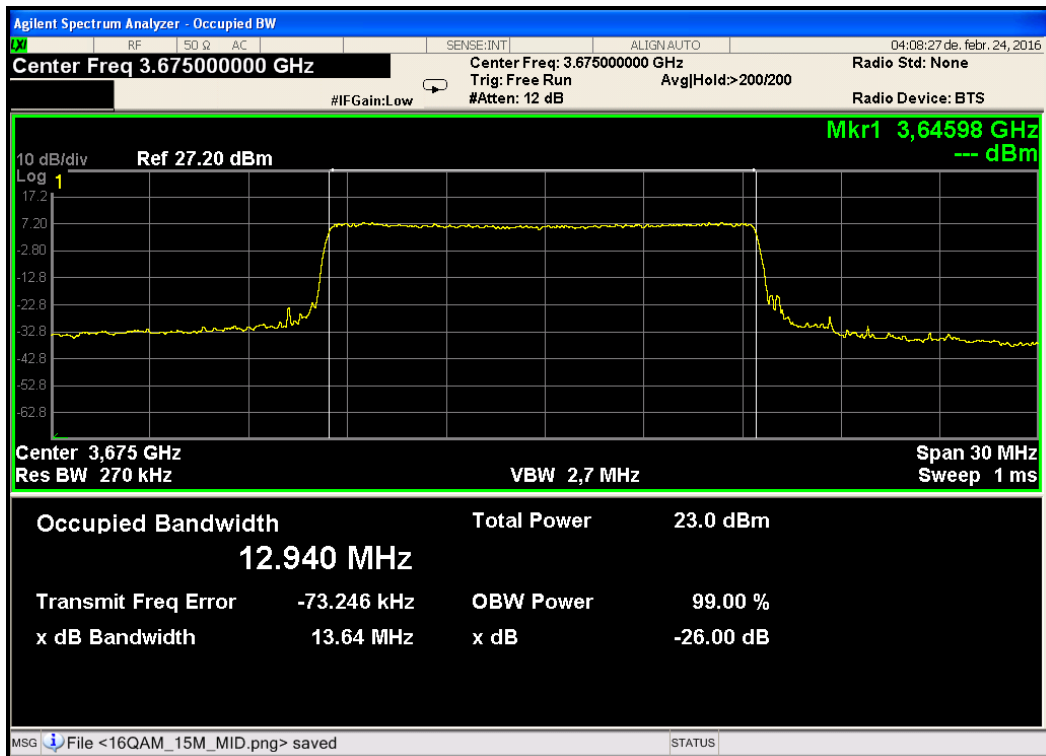

Figure 35. 15MHz CBW – Operating Frequency 3675.0MHz, 64QAM

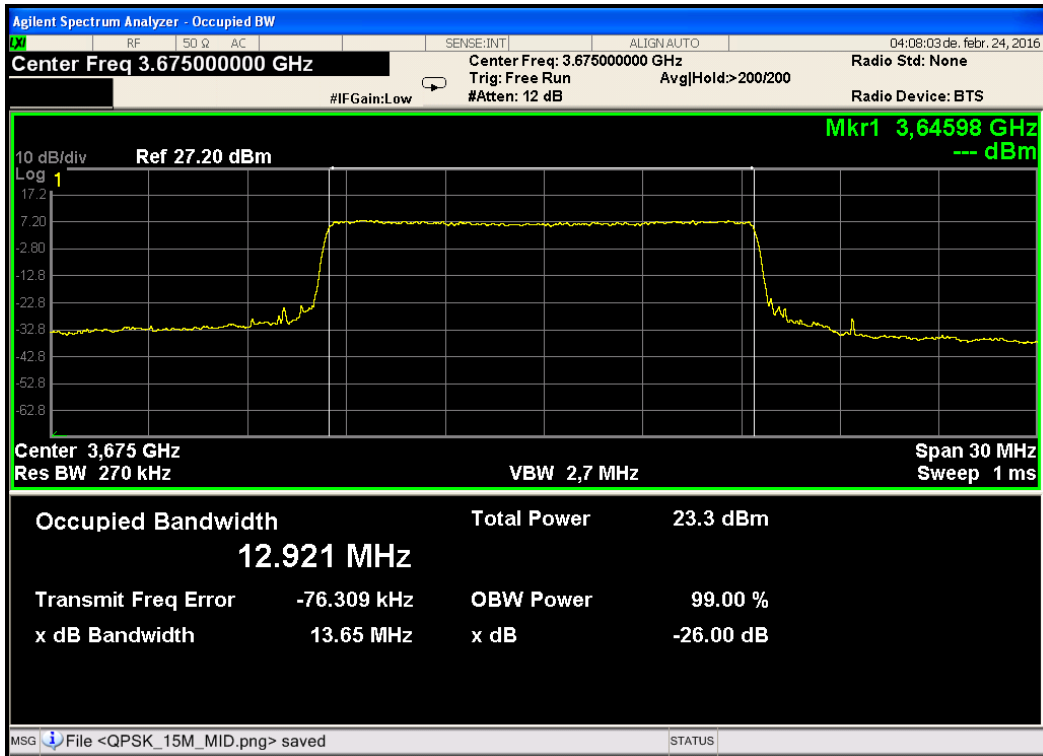

Figure 36. 15MHz CBW – Operating Frequency 3675.0MHz, 16QAM

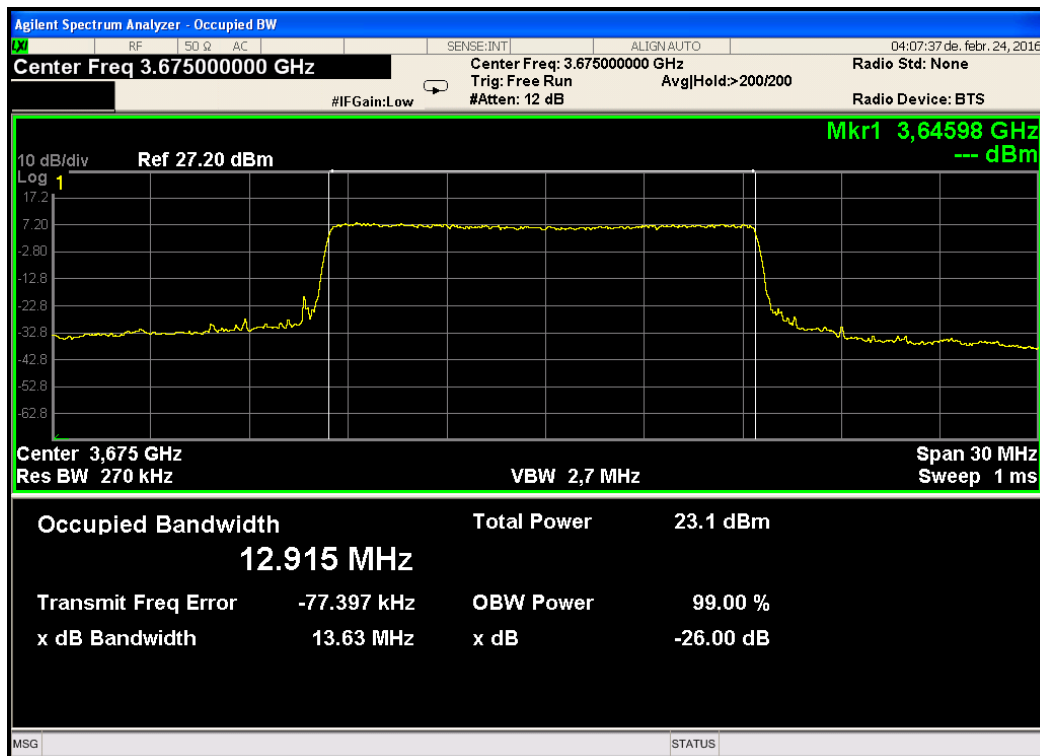

Figure 37. 15MHz CBW – Operating Frequency 3675.0MHz, QPSK

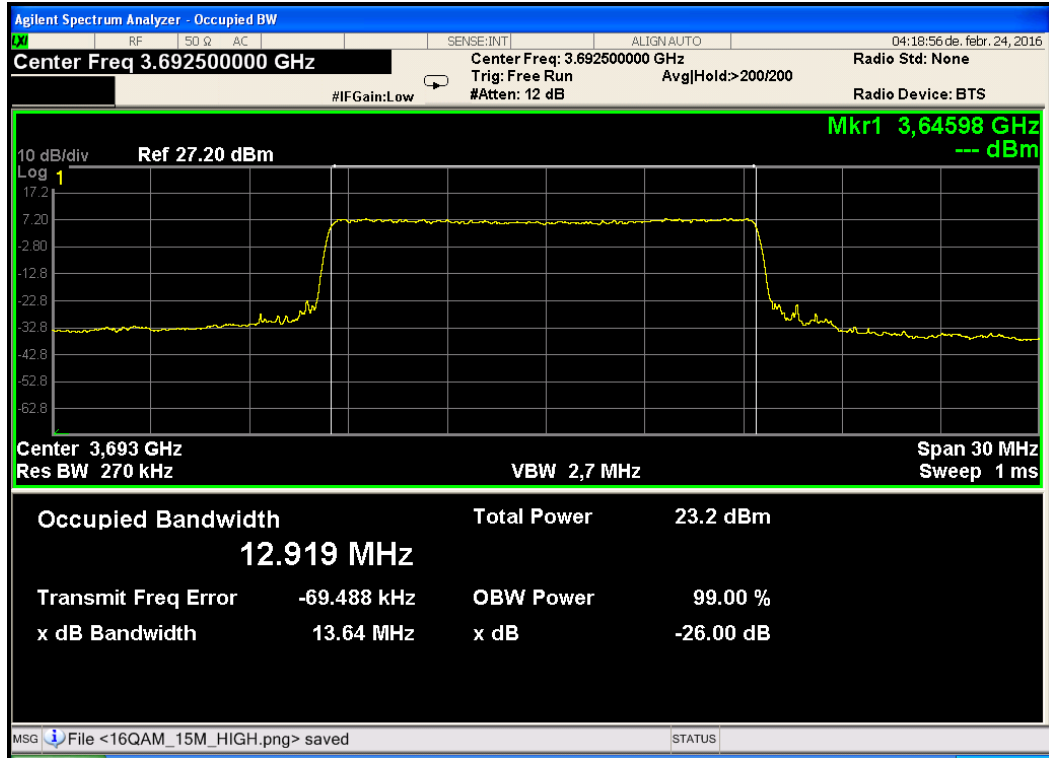

Figure 38. 15MHz CBW – Operating Frequency 3692.5MHz, 64QAM

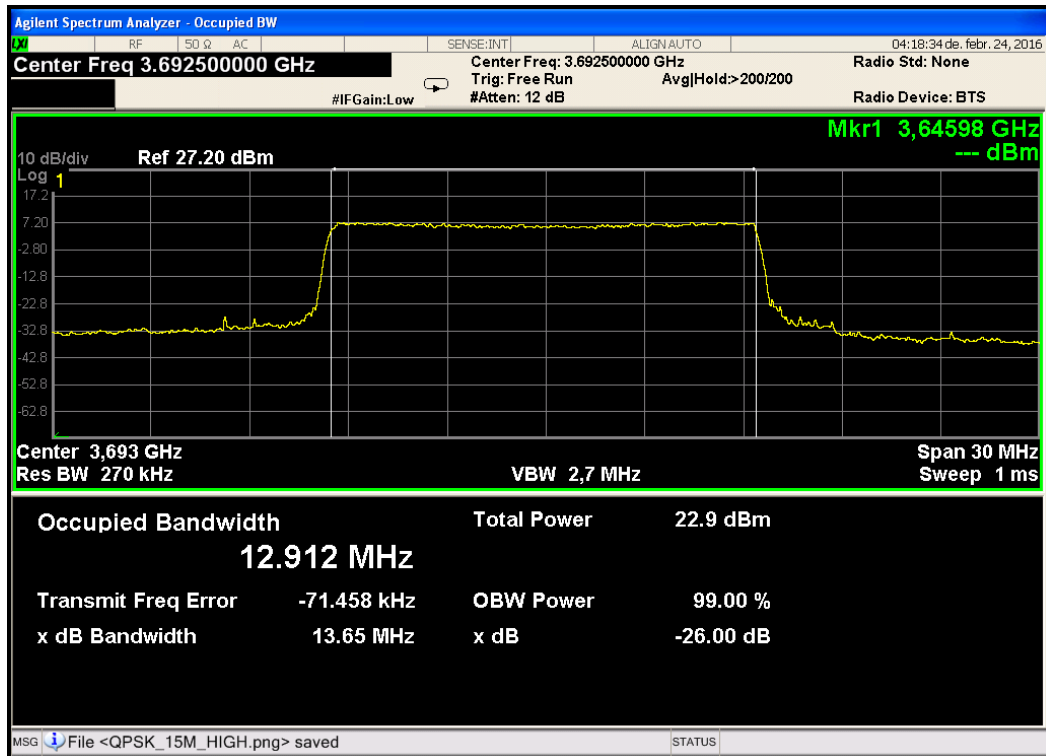

Figure 39. 15MHz CBW – Operating Frequency 3692.5MHz, 16QAM

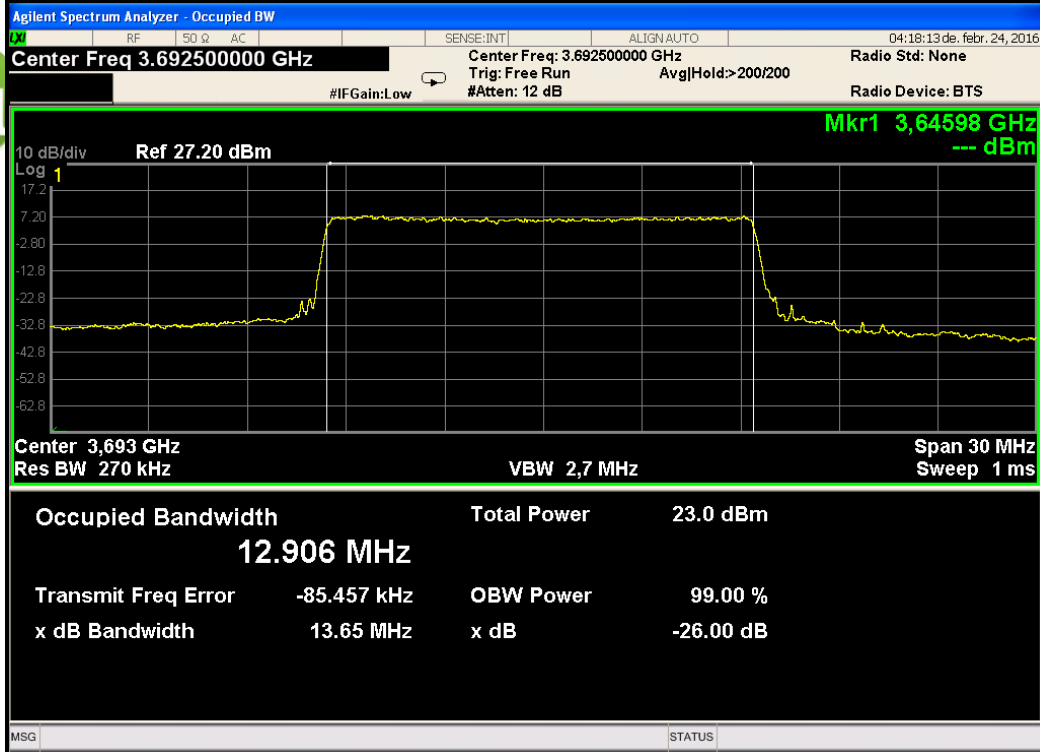

Figure 40. 15MHz CBW – Operating Frequency 3692.5MHz, QPSK

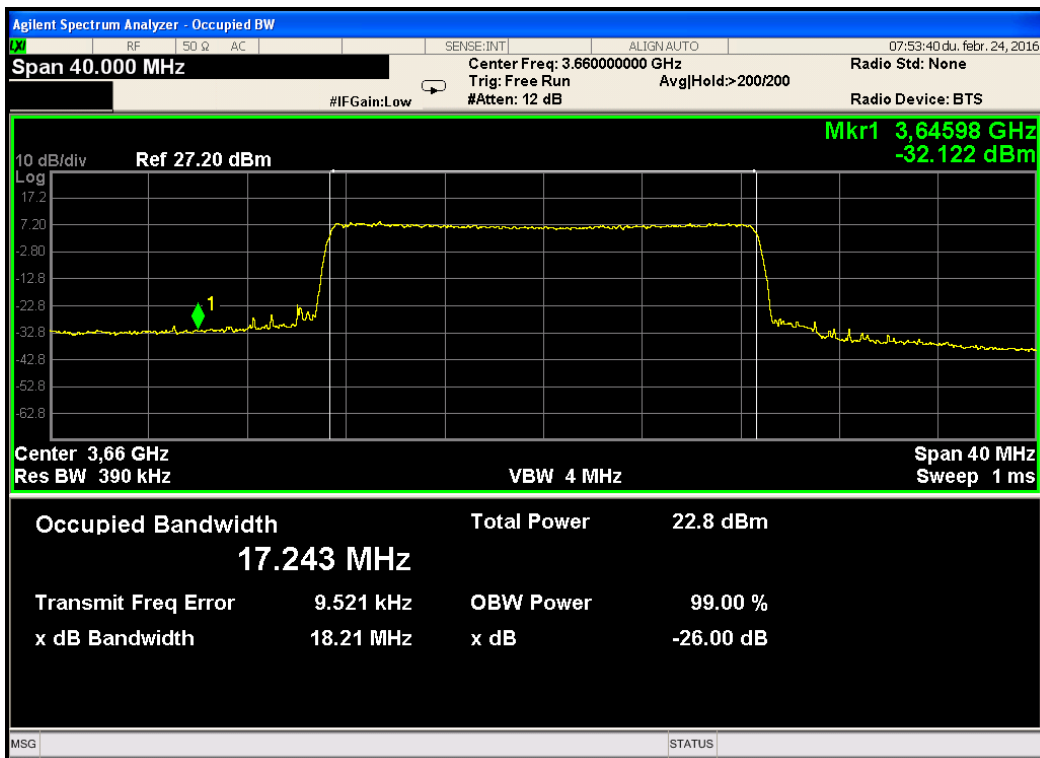

Figure 41. 20MHz CBW – Operating Frequency 3660.0MHz, 64QAM

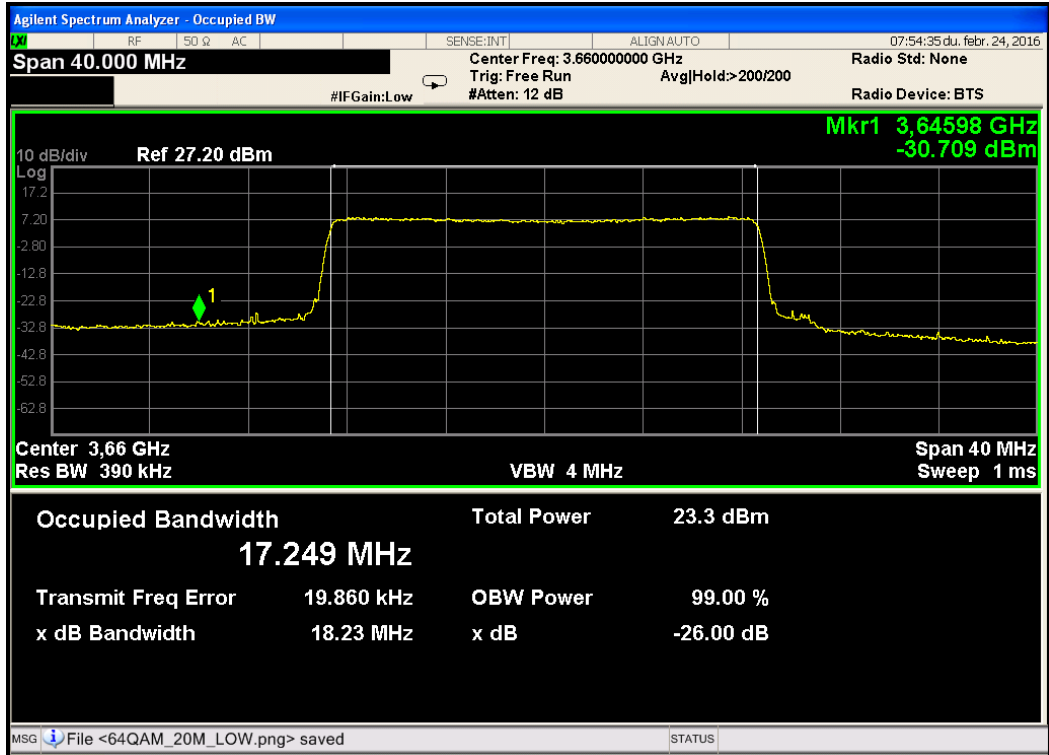

Figure 42. 20MHz CBW – Operating Frequency 3660.0MHz, 16QAM

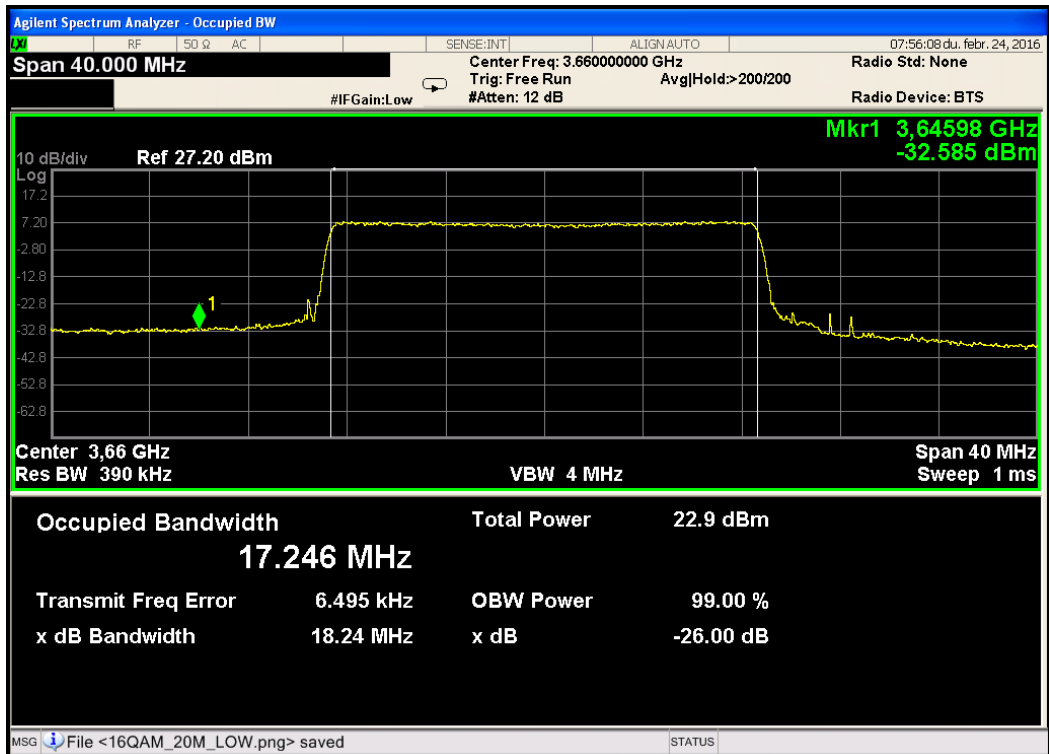

Figure 43. 20MHz CBW – Operating Frequency 3660.0MHz, QPSK

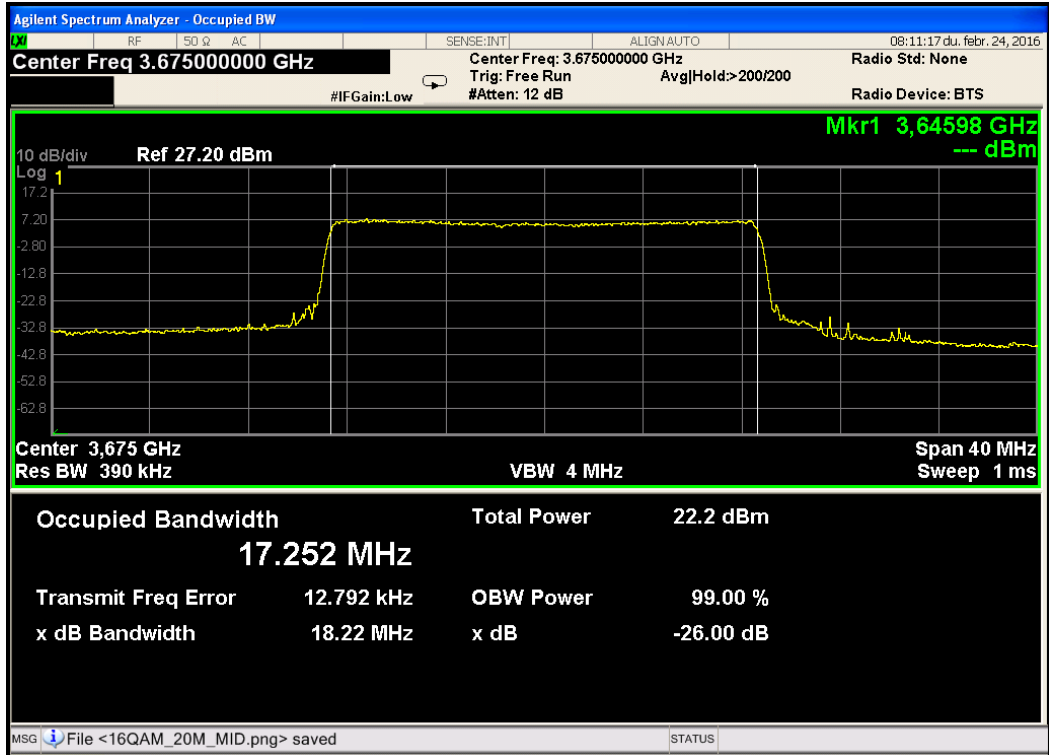

Figure 44. 20MHz CBW – Operating Frequency 3675.0MHz, 64QAM

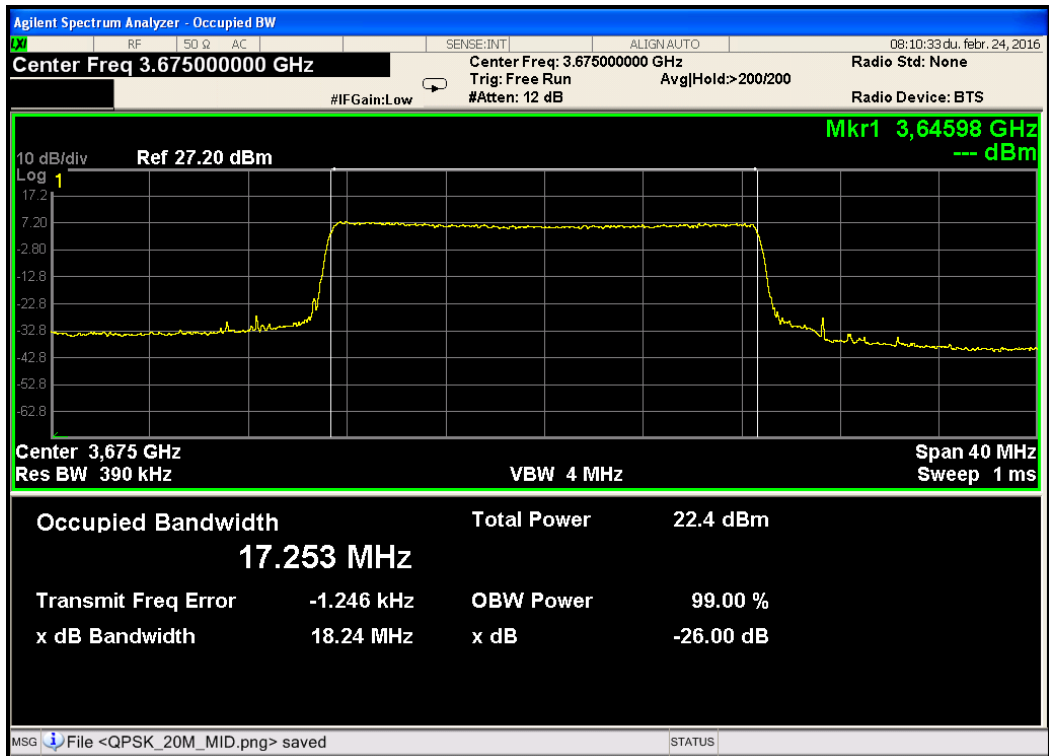

Figure 45. 20MHz CBW – Operating Frequency 3675.0MHz, 16QAM

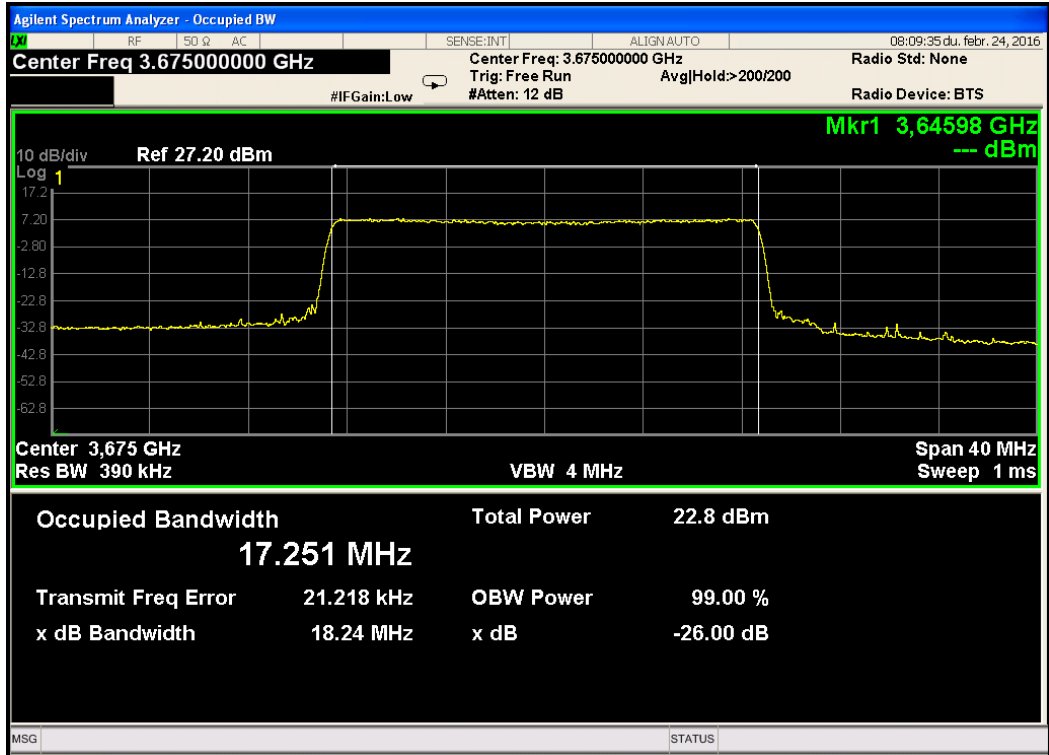

Figure 46. 20MHz CBW – Operating Frequency 3675.0MHz, QPSK

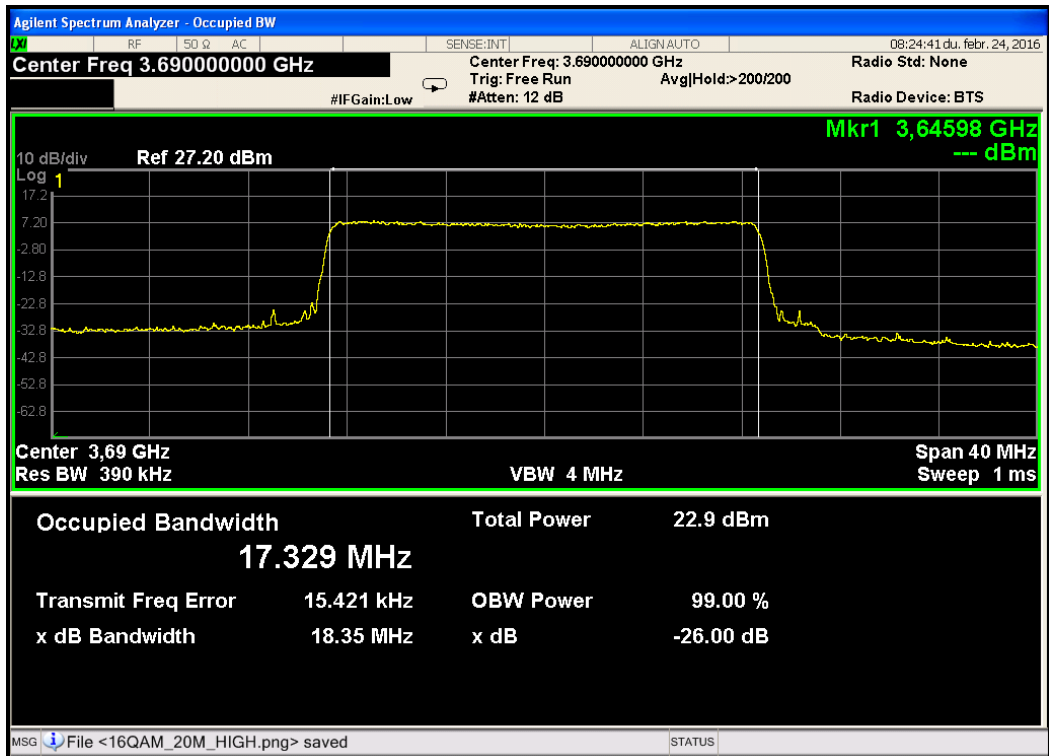

Figure 47. 20MHz CBW – Operating Frequency 3690.0MHz, 64QAM

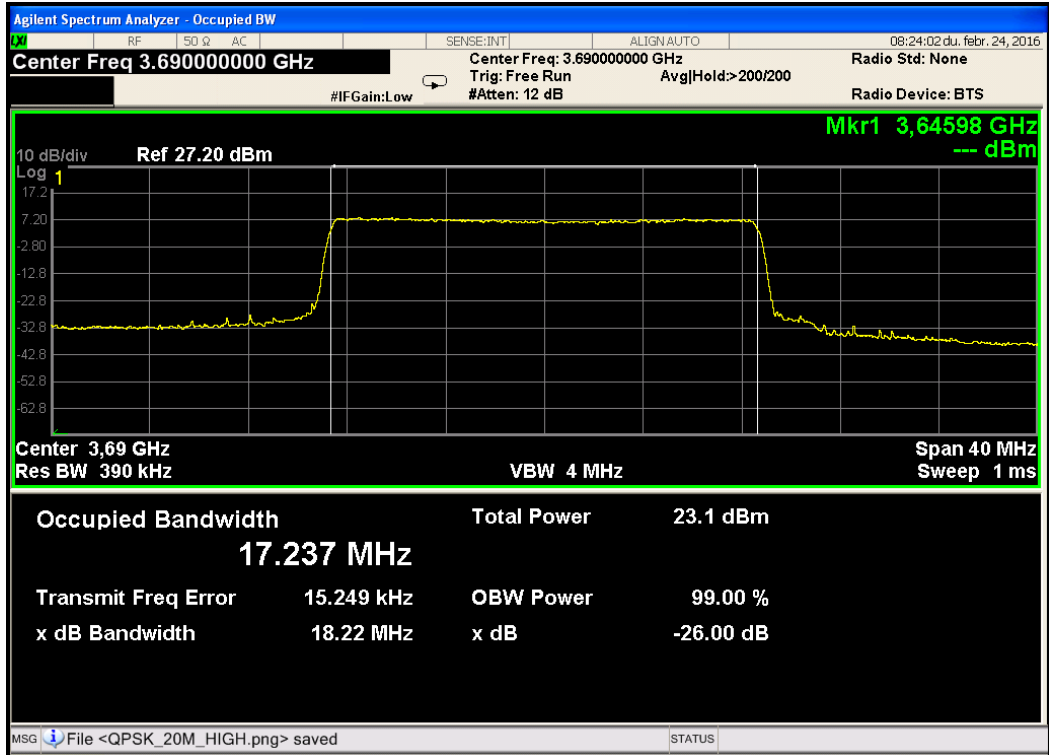

Figure 48. 20MHz CBW – Operating Frequency 3690.0MHz, 16QAM

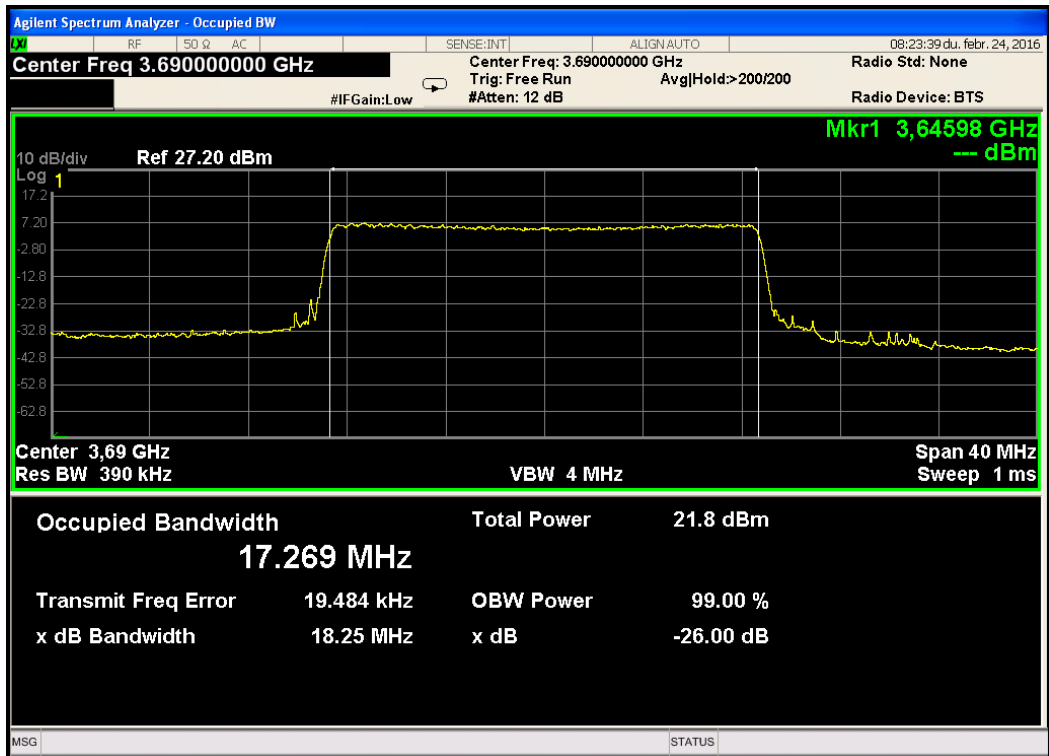

Figure 49. 20MHz CBW – Operating Frequency 3690.0MHz, QPSK



4.5 Test Equipment Used; Occupied Bandwidth

Instrument	Manufacturer	Model	Serial Number	Calibration	
				Last Calibration	Next Calibration Due
MXA Signal Analyzer	Agilent	N9020A	MY48011785	July 26 2015	July 26 2017
DC block	JFW	50DB-007	1-23	N/A	N/A
Splitter	Weinschel 93459	1515	MH203	N/A	N/A
Attenuator	MINI- CIRCUITS	MCL BW S10W2+	0728	N/A	N/A

Figure 50. Test Equipment Used



5. Transmitter Frequency Stability

5.1 Test Specification

RSS 197 Section 5.3

RSS Gen Issue 4, November 2014, Section 6.11

FCC Part 2, Section 2.1055

5.2 Test Procedure

The E.U.T operation mode and test setup are as described in Section 2 of this report.

Using a resolution bandwidth of 1% of the occupied bandwidth, a reference point at the unwanted emission level specified in Section 5.7 on the emission mask of the lowest and highest channel shall be selected, and the frequency at these points shall be recorded as f_L and f_H respectively.

Exploratory testing was performed at 25.0°C and 115.0VAC, to find the “worst case” F_L , F_H for all modulation type each CBW at 2 edge frequencies.

The E.U.T. was operated with a CW signal in the downlink path.

The E.U.T. was placed inside a temperature chamber.

The spectrum analyzer was set to 10.0 kHz span and 1.0 kHz RBW and 1.0 kHz VBW. Counter function was set for this evaluation.

The E.U.T. was operated from 115.0 VAC at nominal temperature (+25.0°C).

The carrier frequency was measured and recorded (reference frequency reading).

Carrier frequency measurement was repeated for:

- (a) +20.0°C and 97.7 VAC
- (b) +20.0°C and 132.2 VAC
- (c) -30.0°C and 115.0 VAC
- (d) -20.0°C and 115.0 VAC
- (e) -10.0°C and 115.0 VAC
- (f) +0.0°C and 115.0 VAC
- (g) +10.0°C and 115.0 VAC
- (h) +20.0°C and 115.0 VAC
- (i) +30.0°C and 115.0 VAC
- (j) +40.0°C and 115.0 VAC
- (k) +50.0°C and 115.0 VAC

The carrier frequency was measured and recorded after at least 20 minutes of exposing the E.U.T. to the temperature.

5.3 Limit

The applicant shall ensure frequency stability by showing that f_L minus the frequency offset and f_H plus the frequency offset shall be within the 3650-3700 MHz band.



5.4 Test Results

JUDGEMENT: Passed

The E.U.T met the requirements of RSS 197, Issue 1:2010, Section 5.3, RSS Gen Issue 4: 2014, Section 6.11 and FCC Part 2, Section 2.1055.

The details of the results are given in *Figure 55* to *Figure 66*.

Temperature	Voltage	F _L "wors case"	F _H "worst case"	Drift Low	Drift High	Within the 3650- 3700 MHz band
(°C)	(VAC)	(MHz)	(MHz)	(kHz)	(kHz)	
+20.0	97.7	3,650.5610	3,699.2810	+1.0	+1.0	YES
	115.0	3,650.5600	3,699.2800	-	-	YES
	132.2	3,650.5600	3,699.2800	0.0	0.0	YES
-30.0	115.0	3,650.5640	3,699.2830	+4.0	+3.0	YES
-20.0	115.0	3,650.5640	3,699.2830	+4.0	+3.0	YES
-10.0	115.0	3,650.5630	3,699.2820	+3.0	+2.0	YES
0.0	115.0	3,650.5620	3,699.2820	+2.0	+2.0	YES
+10.0	115.0	3,650.5610	3,699.2810	+1.0	+1.0	YES
+30.0	115.0	3,650.5590	3,699.2790	-1.0	-1.0	YES
+40.0	115.0	3,650.5590	3,699.2780	-1.0	-2.0	YES
+50.0	115.0	3,650.5580	3,699.2770	-2.0	-3.0	YES

Figure 51. Frequency Stability Test Results - 5MHz CBW



Temperature	Voltage	FL "worst case"	FH "worst case"	Drift Low	Drift High	Within the 3650- 3700 MHz band
(°C)	(VAC)	(MHz)	(MHz)	(kHz)	(kHz)	
+20.0	97.7	3,650.5810	3,699.4210	+1.0	+1.0	YES
	115.0	3,650.5800	3,699.4200	-	-	YES
	132.2	3,650.5801	3,699.4201	+0.1	+0.1	YES
-30.0	115.0	3,650.5840	3,699.4230	+4.0	+3.0	YES
-20.0	115.0	3,650.5830	3,699.4230	+3.0	+3.0	YES
-10.0	115.0	3,650.5830	3,699.4230	+3.0	+3.0	YES
0.0	115.0	3,650.5820	3,699.4220	+2.0	+2.0	YES
+10.0	115.0	3,650.5810	3,699.4210	+1.0	+1.0	YES
+30.0	115.0	3,650.5790	3,699.4180	-1.0	-2.0	YES
+40.0	115.0	3,650.5780	3,699.4170	-2.0	-3.0	YES
+50.0	115.0	3,650.5780	3,699.4170	-2.0	-3.0	YES

Figure 52. Frequency Stability Test Results - 10MHz CBW



Temperature	Voltage	F _L "worst case"	F _H "worst case"	Drift Low	Drift High	Within the 3650- 3700 MHz band
(°C)	(VAC)	(MHz)	(MHz)	(kHz)	(kHz)	
+20.0	97.7	3,650.7810	3,699.0710	+1.0	+1.0	YES
	115.0	3,650.7800	3,699.0700	-	-	YES
	132.2	3,650.7801	3,699.0701	+0.1	+0.1	YES
-30.0	115.0	3,650.7840	3,699.0730	+4.0	+3.0	YES
-20.0	115.0	3,650.7840	3,699.0730	+4.0	+3.0	YES
-10.0	115.0	3,650.7820	3,699.0720	+2.0	+2.0	YES
0.0	115.0	3,650.7810	3,699.0710	+1.0	+1.0	YES
+10.0	115.0	3,650.7810	3,699.0710	+1.0	+1.0	YES
+30.0	115.0	3,650.7790	3,699.0690	-1.0	-1.0	YES
+40.0	115.0	3,650.7780	3,699.0670	-2.0	-3.0	YES
+50.0	115.0	3,650.7780	3,699.0670	-2.0	-3.0	YES

Figure 53. Frequency Stability Test Results - 15MHz CBW



Temperature	Voltage	F _L "worst case"	F _H "worst case"	Drift Low	Drift High	Within the 3650- 3700 MHz band
(°C)	(VAC)	(MHz)	(MHz)	(kHz)	(kHz)	
+20.0	97.7	3,651.1610	3,698.8410	+1.0	+1.0	YES
	115.0	3,651.1600	3,698.8400	-	-	YES
	132.2	3,651.1601	3,698.8401	+0.1	+0.1	YES
-30.0	115.0	3,651.1640	3,698.8430	+4.0	+3.0	YES
-20.0	115.0	3,651.1640	3,698.8430	+4.0	+3.0	YES
-10.0	115.0	3,651.1620	3,698.8410	+2.0	+1.0	YES
0.0	115.0	3,651.1610	3,698.8410	+1.0	+1.0	YES
+10.0	115.0	3,651.1610	3,698.8410	+1.0	+1.0	YES
+30.0	115.0	3,651.1590	3,698.8390	-1.0	-1.0	YES
+40.0	115.0	3,651.1580	3,698.8380	-2.0	-2.0	YES
+50.0	115.0	3,651.1580	3,698.8370	-2.0	-3.0	YES

Figure 54. Frequency Stability Test Results - 20MHz CBW

Frequency Stability

E.U.T Description CPE
Type CPE8000-PRO-1D-3.x
Part Number: Not designated

Specification: RSS 197 Issue 1: 2010, Section 5.4; RSS Gen Issue 4: 2014, Section 6.11;
FCC Part 2, Section 2.1055

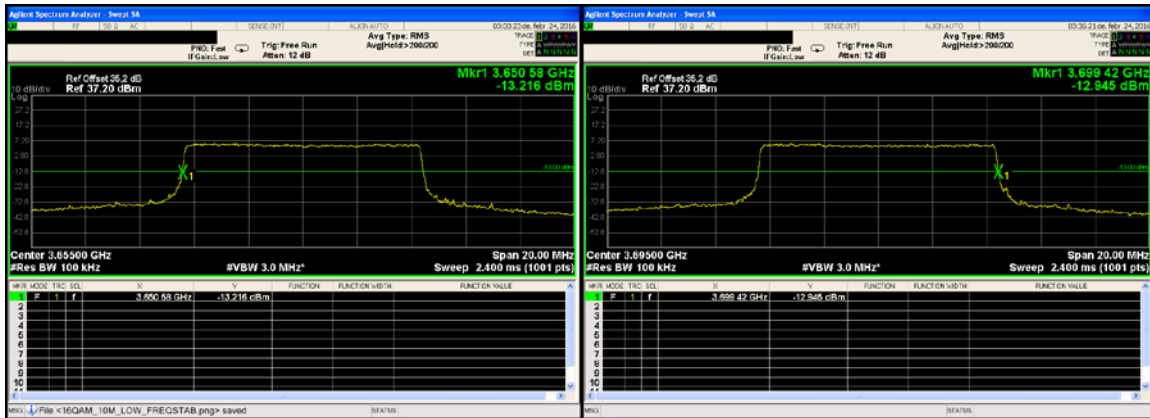

Figure 58. FL, FH for QPSK modulation, 20.0°C/115.0V- 10MHz CBW

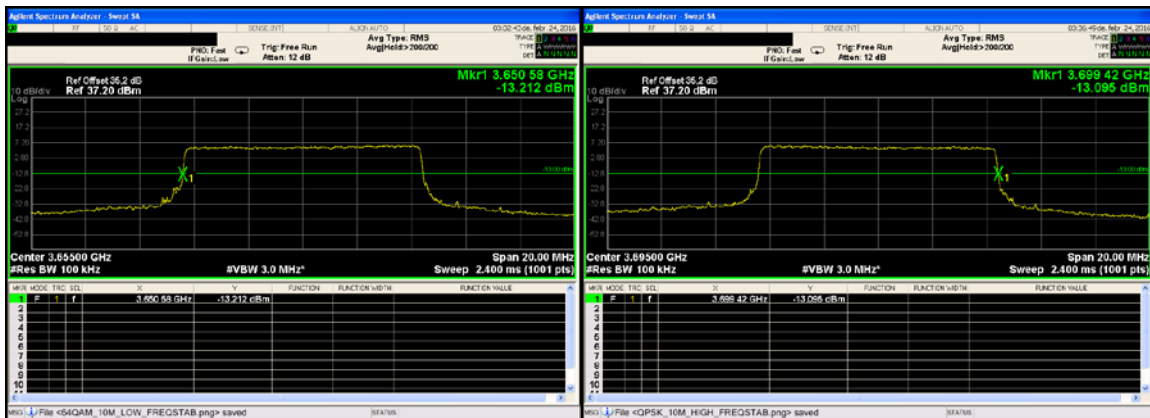

Figure 59. FL, FH for 16QAM modulation, 20.0°C/115.0V- 10MHz CBW

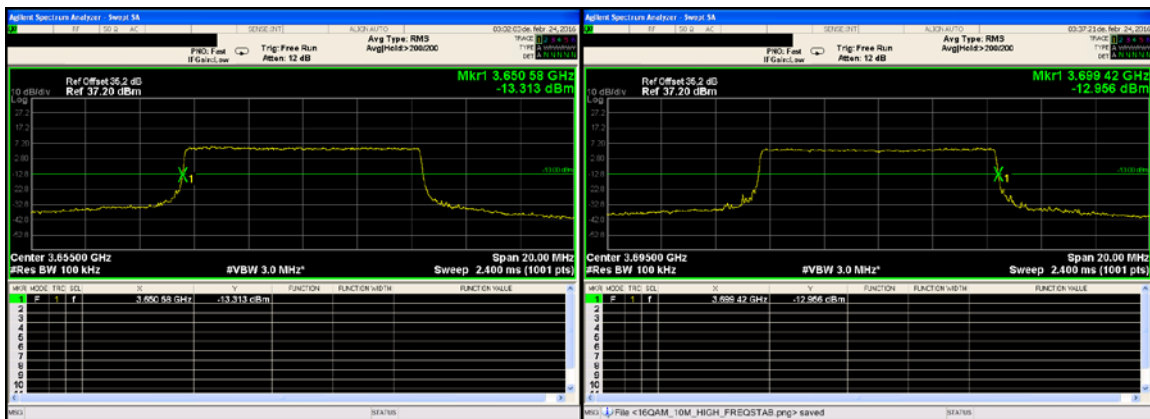

Figure 60. FL, FH for 64QAM modulation, 20.0°C/115.0V- 10MHz CBW

Frequency Stability

E.U.T Description CPE
Type CPE8000-PRO-1D-3.x
Part Number: Not designated

Specification: RSS 197 Issue 1: 2010, Section 5.4; RSS Gen Issue 4: 2014, Section 6.11;
FCC Part 2, Section 2.1055

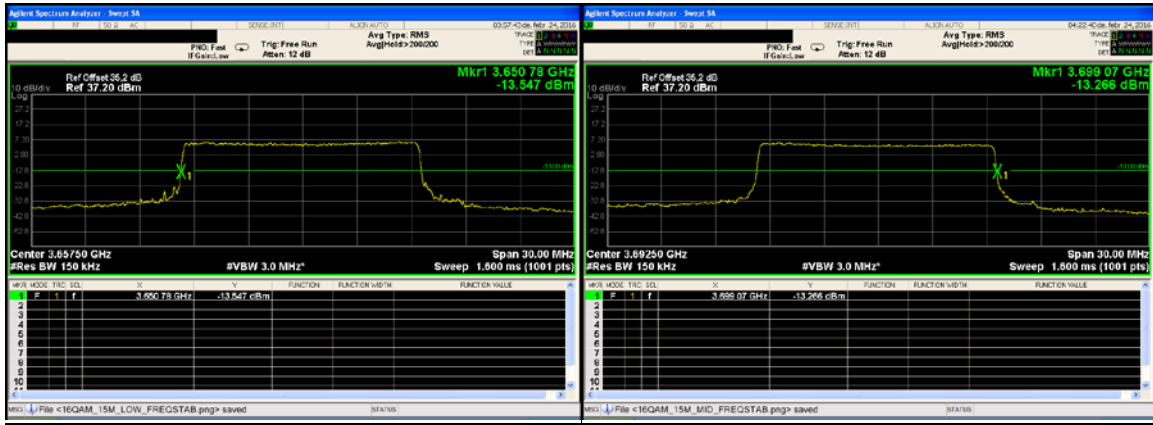

Figure 61. FL, FH for QPSK modulation, 20.0°C/115.0V - 15MHz CBW

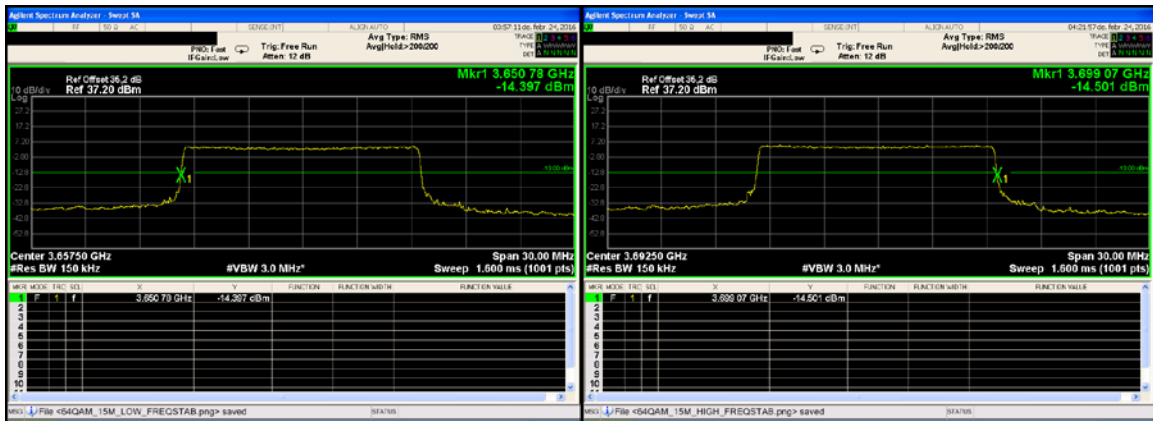

Figure 62. FL, FH for 16QAM modulation, 20.0°C/115.0V - 15MHz CBW

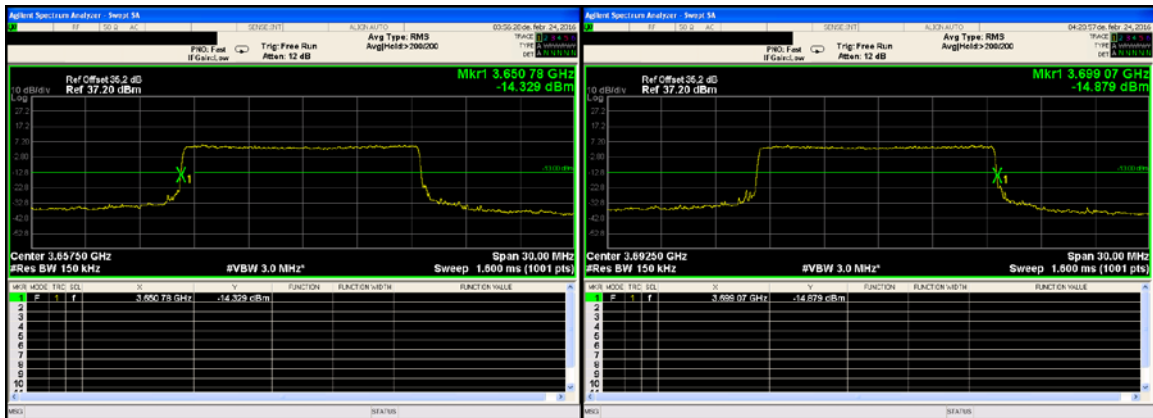

Figure 63. FL, FH for 64QAM modulation, 20.0°C/115.0V - 15MHz CBW

Frequency Stability

E.U.T Description CPE
Type CPE8000-PRO-1D-3.x
Part Number: Not designated

Specification: RSS 197 Issue 1: 2010, Section 5.4; RSS Gen Issue 4: 2014, Section 6.11;
FCC Part 2, Section 2.1055



Figure 64. FL, FH for QPSK modulation, 20.0°C/115.0V - 20MHz CBW

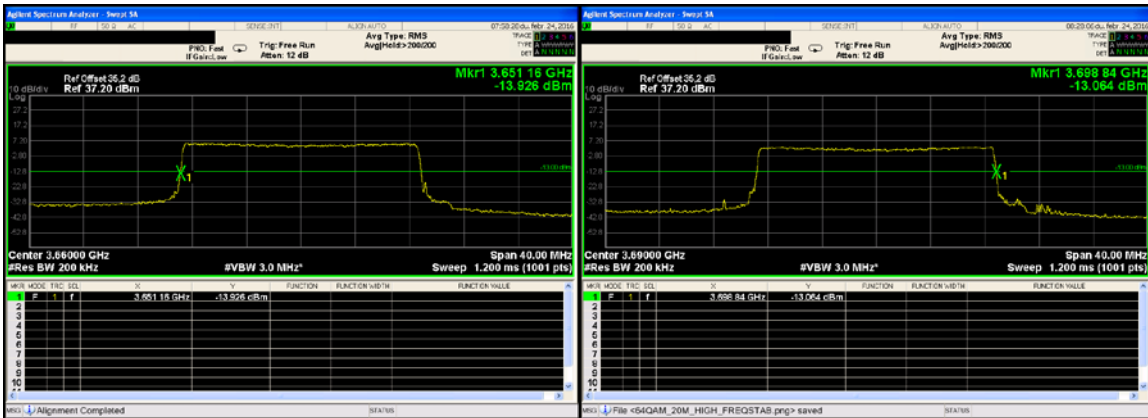

Figure 65. FL, FH for 16QAM modulation, 20.0°C/115.0V - 20MHz CBW

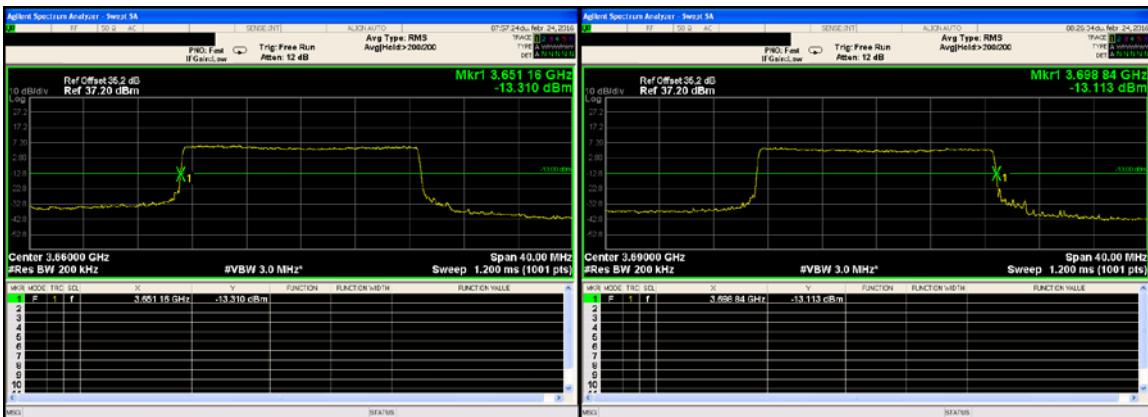

Figure 66. FL, FH for 64QAM modulation, 20.0°C/115.0V - 20MHz CBW



5.5 Test Instruments Used; Frequency Stability

Instrument	Manufacturer	Model	Serial Number	Calibration	
				Last Calibration	Next Calibration Due
MXA Signal Analyzer	Agilent	N9020A	MY48011785	July 26 2015	July 26 2017
Climatic Chamber	Thermotron	SM-32C	251030	February 24, 2015	April 30, 2016
Humidity Temperature Probe	Rotronic	HC2-IC102	60286140	August 2, 2015	August 2, 2016

Figure 67. Test Instruments Used Frequency Stability

6. Transmitter Output Power and Equivalent Isotropically Radiated Power (e.i.r.p.)

6.1 Test Specification

RSS 197, Issue 1: 2010, Section 5.6
SRSP-303.65, Issue 2: 2010, Section 5.1
FCC Part 90, Subpart Z, section 90.1321

6.2 Test Procedure

The E.U.T. antenna terminal was connected to the Spectrum Analyzer through an external attenuator, an appropriate coaxial cable, coupler, and DC block. (total loss=35.2dB Including duty cycle factor) The E.U.T. RF output was OFDMA modulated with QPSK, 16QAM and 64QAM, each at 5, 10,15 and 20 MHz CBW and in 2 power modes: low and high population and in 3 operational frequencies. Special attention was taken to prevent Spectrum Analyzer RF input overload. RBW was set to 1MHz.

6.3 FCC Limit

Base and fixed stations are limited to 25 watts/25 MHz (44.0dBm) equivalent isotropically radiated power (EIRP). In any event, the peak EIRP power density shall not exceed 1 Watt in any one-megahertz.

6.4 IC Limit

The maximum transmitter output power density of equipment, other than mobile and portable equipment, shall not exceed 1W (30dBm) in any 1 MHz bandwidth. However, in low population areas, a maximum e.i.r.p. density of 60 W/MHz (47.78dBm/MHz) is permitted.

6.5 Test Results

Judgment: PASSED

For additional information see *Figure 68* to *Figure 151*.

Operation Frequency (MHz)	Modulation	PSD Reading (dBm)	Antenna Gain (dbi)	Total PSD (dbm)	PSD Limit (dBm)	Margin (dB)
3652.5	QPSK	14.4	15.0	29.4	30.0	-0.6
	16QAM	14.8	15.0	29.8	30.0	-0.2
	64QAM	14.8	15.0	29.8	30.0	-0.2
3675.0	QPSK	14.6	15.0	29.6	30.0	-0.4
	16QAM	14.6	15.0	29.6	30.0	-0.4
	64QAM	14.5	15.0	29.5	30.0	-0.5
3697.5	QPSK	14.8	15.0	29.8	30.0	-0.2
	16QAM	14.6	15.0	29.6	30.0	-0.4
	64QAM	14.5	15.0	29.5	30.0	-0.5

Figure 68. PSD, 5 MHz CBW - High Population

Operation Frequency (MHz)	Modulation	Reading@1MHz (dBm)	Reading@5MHz (dBm)	Antenna Gain (dbi)	Total EIRP (dbm)	EIRP Limit (dBm)	Margin (dB)
3652.5	QPSK	14.4	21.4	15.0	36.4	44.0	-7.6
	16QAM	14.8	21.8	15.0	36.8	44.0	-7.2
	64QAM	14.8	21.8	15.0	36.8	44.0	-7.2
3675.0	QPSK	14.6	21.6	15.0	36.6	44.0	-7.4
	16QAM	14.6	21.6	15.0	36.6	44.0	-7.4
	64QAM	14.5	21.5	15.0	36.5	44.0	-7.5
3697.5	QPSK	14.8	21.8	15.0	36.8	44.0	-7.2
	16QAM	14.6	21.6	15.0	36.6	44.0	-7.4
	64QAM	14.5	21.5	15.0	36.5	44.0	-7.5

Reading@5MHz= Reading@1MHz+ 10 log (5M/1M) = 7.0dBm

Figure 69. EIRP, 5 MHz CBW, FCC Specification

Operation Frequency	Modulation	PSD Reading	Antenna Gain	Total PSD	Limit	Margin
(MHz)		(dBm)	(dbi)	(dbm)	(dBm)	(dB)
3655.0	QPSK	14.0	15.0	29.0	30.0	-1.0
	16QAM	14.0	15.0	29.0	30.0	-1.0
	64QAM	13.2	15.0	28.2	30.0	-1.8
3675.0	QPSK	14.3	15.0	29.3	30.0	-0.7
	16QAM	14.2	15.0	29.2	30.0	-0.8
	64QAM	14.3	15.0	29.3	30.0	-0.7
3695.0	QPSK	14.1	15.0	29.1	30.0	-0.9
	16QAM	14.3	15.0	29.3	30.0	-0.7
	64QAM	14.1	15.0	29.1	30.0	-0.9

Figure 70. PSD, 10 MHz CBW - High Population

Operation Frequency	Modulation	Reading@1MHz	Reading@10MHz	Antenna Gain	Total EIRP	EIRP Limit	Margin
(MHz)		(dBm)	(dBm)	(dbi)	(dbm)	(dBm)	(dB)
3655.0	QPSK	14.0	24.0	15.0	39.0	44.0	-5.0
	16QAM	14.0	24.0	15.0	39.0	44.0	-5.0
	64QAM	13.2	23.2	15.0	38.2	44.0	-5.8
3675.0	QPSK	14.3	24.3	15.0	39.3	44.0	-4.7
	16QAM	14.2	24.2	15.0	39.2	44.0	-4.8
	64QAM	14.3	24.3	15.0	39.3	44.0	-4.7
3695.0	QPSK	14.1	24.1	15.0	39.1	44.0	-4.9
	16QAM	14.3	24.3	15.0	39.3	44.0	-4.7
	64QAM	14.1	24.1	15.0	39.1	44.0	-4.9

Reading@10MHz= Reading@1MHz+ 10 log (10M/1M)=10.0dBm

Figure 71. EIRP, 10 MHz CBW, FCC Specification

Operation Frequency (MHz)	Modulation	PSD Reading (dBm)	Antenna Gain (dbi)	Total PSD (dbm)	Limit (dBm)	Margin (dB)
3657.5	QPSK	12.8	15.0	27.8	30.0	-2.2
	16QAM	12.1	15.0	27.1	30.0	-2.9
	64QAM	12.4	15.0	27.4	30.0	-2.6
3675.0	QPSK	12.3	15.0	27.3	30.0	-2.7
	16QAM	12.1	15.0	27.1	30.0	-2.9
	64QAM	12.3	15.0	27.3	30.0	-2.7
3692.5	QPSK	12.3	15.0	27.3	30.0	-2.7
	16QAM	12.4	15.0	27.4	30.0	-2.6
	64QAM	12.6	15.0	27.6	30.0	-2.4

Figure 72. PSD, 15 MHz CBW - High Population

Operation Frequency (MHz)	Modulation	Reading@1MHz (dBm)	Reading@15MHz (dBm)	Antenna Gain (dbi)	Total EIRP (dbm)	EIRP Limit (dBm)	Margin (dB)
3657.5	QPSK	12.8	24.5	15.0	39.5	44.0	-4.5
	16QAM	12.1	23.8	15.0	38.8	44.0	-5.2
	64QAM	12.4	24.1	15.0	39.1	44.0	-4.9
3675.0	QPSK	12.3	24.0	15.0	39.0	44.0	-5.0
	16QAM	12.1	23.8	15.0	38.8	44.0	-5.2
	64QAM	12.3	24.0	15.0	39.0	44.0	-5.0
3692.5	QPSK	12.3	24.0	15.0	39.0	44.0	-5.0
	16QAM	12.4	24.1	15.0	39.1	44.0	-4.9
	64QAM	12.6	24.3	15.0	39.3	44.0	-4.7

Reading@15MHz= Reading@1MHz+ 10 log (15M/1M) = 11.7dBm

Figure 73. EIRP, 15 MHz CBW - FCC Specification

Operation Frequency (MHz)	Modulation	PSD Reading (dBm)	Antenna Gain (dbi)	Total PSD (dbm)	Limit (dBm)	Margin (dB)
3660.0	QPSK	11.1	15.0	26.1	30.0	-3.9
	16QAM	11.0	15.0	26.0	30.0	-4.0
	64QAM	11.0	15.0	26.0	30.0	-4.0
3675.0	QPSK	11.4	15.0	26.4	30.0	-3.6
	16QAM	11.0	15.0	26.0	30.0	-4.0
	64QAM	11.2	15.0	26.2	30.0	-3.8
3690.0	QPSK	11.2	15.0	26.2	30.0	-3.8
	16QAM	11.4	15.0	26.4	30.0	-3.6
	64QAM	11.0	15.0	26.0	30.0	-4.0

Figure 74. PSD, 20 MHz CBW - High Population

Operation Frequency (MHz)	Modulation	Reading@1MHz (dBm)	Reading@20MHz (dBm)	Antenna Gain (dbi)	Total EIRP (dbm)	EIRP Limit (dBm)	Margin (dB)
3660.0	QPSK	11.1	24.1	15.0	39.1	44.0	-4.9
	16QAM	11.0	24.0	15.0	39.0	44.0	-5.0
	64QAM	11.0	24.0	15.0	39.0	44.0	-5.0
3675.0	QPSK	11.4	24.4	15.0	39.4	44.0	-4.6
	16QAM	11.0	24.0	15.0	39.0	44.0	-5.0
	64QAM	11.2	24.2	15.0	39.2	44.0	-4.8
3690.0	QPSK	11.2	24.2	15.0	39.2	44.0	-4.8
	16QAM	11.4	24.4	15.0	39.4	44.0	-4.6
	64QAM	11.0	24.0	15.0	39.0	44.0	-5.0

Reading@20MHz= Reading@1MHz+ 10 log (20M/1M) = 13.0dBm

Figure 75. EIRP, 20 MHz CBW, FCC Specification

Operation Frequency (MHz)	Modulation	PSD Reading (dBm)	Antenna Gain (dbi)	Total PSD (dbm)	Limit (dBm)	Margin (dB)
3652.5	QPSK	17.1	15.0	32.1	47.78	-15.68
	16QAM	17.1	15.0	32.1	47.78	-15.68
	64QAM	17.1	15.0	32.1	47.78	-15.68
3675.0	QPSK	17.0	15.0	32.0	47.78	-15.78
	16QAM	17.1	15.0	32.1	47.78	-15.68
	64QAM	17.0	15.0	32.0	47.78	-15.78
3697.5	QPSK	17.1	15.0	32.1	47.78	-15.68
	16QAM	17.0	15.0	32.0	47.78	-15.78
	64QAM	17.1	15.0	32.1	47.78	-15.68

Figure 76. PSD, 5 MHz CBW - Low Population

Operation Frequency (MHz)	Modulation	PSD Reading (dBm)	Antenna Gain (dbi)	Total PSD (dbm)	Limit (dBm)	Margin (dB)
3655.0	QPSK	14.0	15.0	29.0	47.78	-18.78
	16QAM	14.0	15.0	29.0	47.78	-18.78
	64QAM	13.2	15.0	28.2	47.78	-19.58
3675.0	QPSK	14.3	15.0	29.3	47.78	-18.48
	16QAM	14.2	15.0	29.2	47.78	-18.58
	64QAM	14.3	15.0	29.3	47.78	-18.48
3695.0	QPSK	14.1	15.0	29.1	47.78	-18.68
	16QAM	14.3	15.0	29.3	47.78	-18.48
	64QAM	14.1	15.0	29.1	47.78	-18.68

Figure 77. PSD, 10 MHz CBW - Low Population

Operation Frequency	Modulation	PSD Reading	Antenna Gain	Total PSD	Limit	Margin
(MHz)		(dBm)	(dbi)	(dbm)	(dBm)	(dB)
3657.5	QPSK	12.8	15.0	27.8	47.78	-19.98
	16QAM	12.1	15.0	27.1	47.78	-20.68
	64QAM	12.4	15.0	27.4	47.78	-20.38
3675.0	QPSK	12.3	15.0	27.3	47.78	-20.48
	16QAM	12.1	15.0	27.1	47.78	-20.68
	64QAM	12.3	15.0	27.3	47.78	-20.48
3692.5	QPSK	12.3	15.0	27.3	47.78	-20.48
	16QAM	12.4	15.0	27.4	47.78	-20.38
	64QAM	12.6	15.0	27.6	47.78	-20.18

Figure 78. PSD, 15 MHz CBW - Low Population

Operation Frequency	Modulation	PSD Reading	Antenna Gain	Total PSD	Limit	Margin
(MHz)		(dBm)	(dbi)	(dbm)	(dBm)	(dB)
3660.0	QPSK	11.1	15.0	26.1	47.78	-21.68
	16QAM	11.0	15.0	26.0	47.78	-21.78
	64QAM	11.0	15.0	26.0	47.78	-21.78
3675.0	QPSK	11.4	15.0	26.4	47.78	-21.38
	16QAM	11.0	15.0	26.0	47.78	-21.78
	64QAM	11.2	15.0	26.2	47.78	-21.58
3690.0	QPSK	11.2	15.0	26.2	47.78	-21.58
	16QAM	11.4	15.0	26.4	47.78	-21.38
	64QAM	11.0	15.0	26.0	47.78	-21.78

Figure 79. PSD, 20 MHz CBW - Low Population

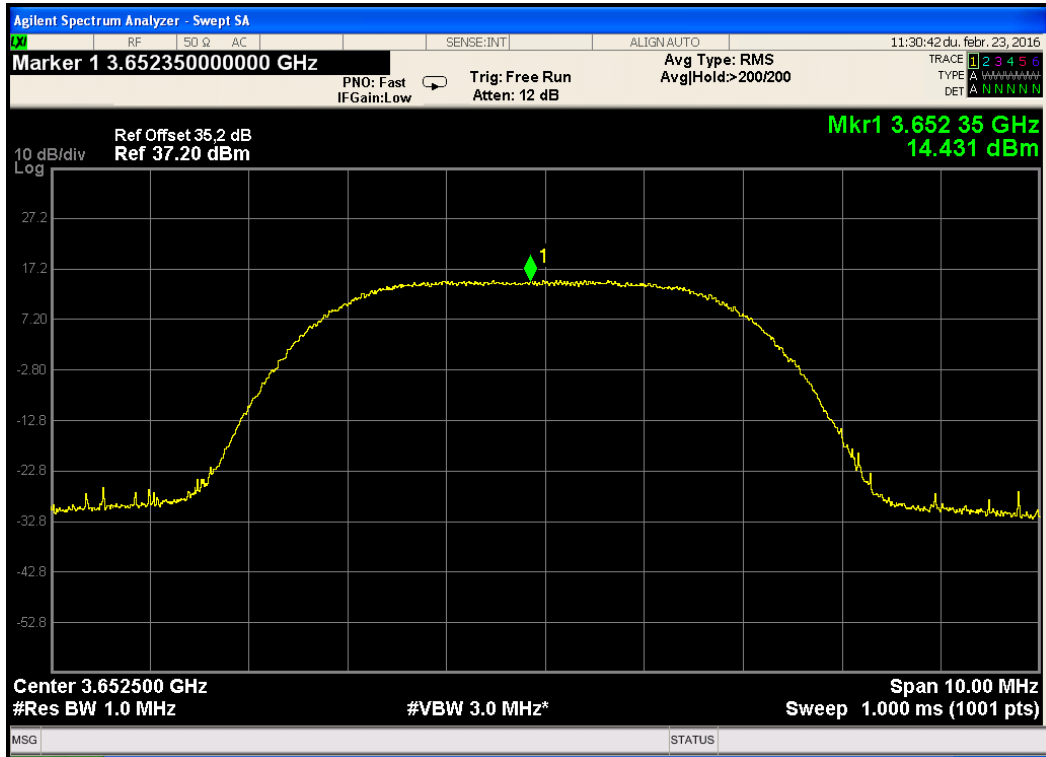

Figure 80. — 3652.5 MHz QPSK - 5MHz CBW, High Population

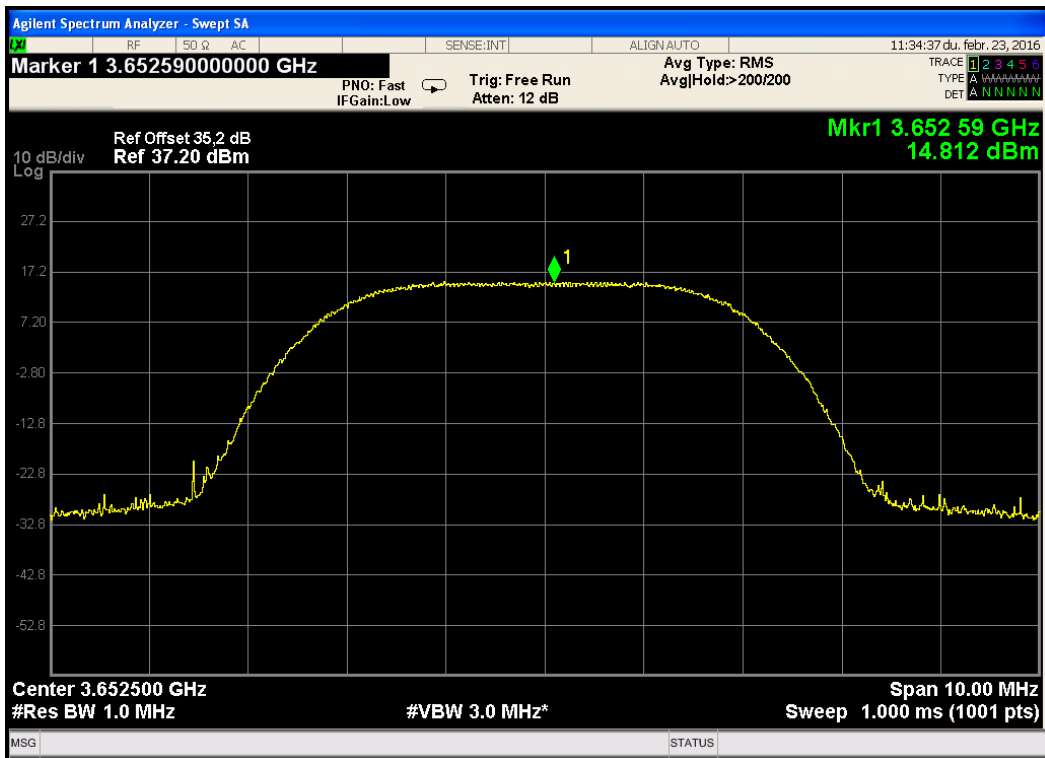

Figure 81. — 3652.5 MHz 16QAM - 5MHz CBW, High Population

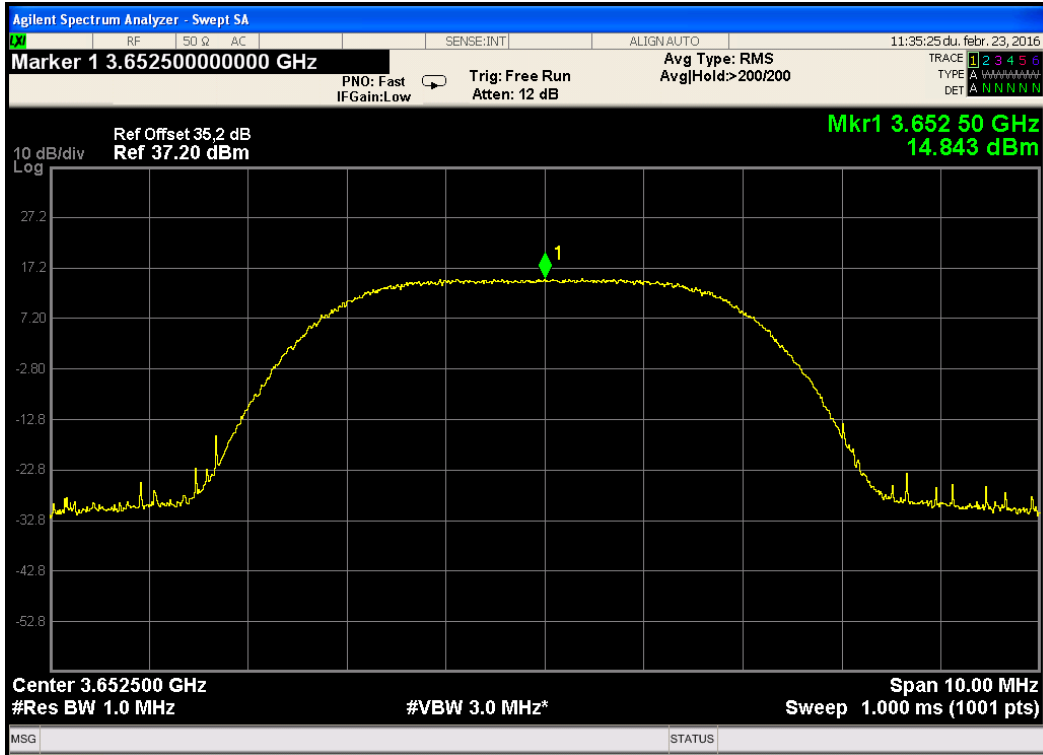

Figure 82. — 3652.5 MHz 64QAM - 5MHz CBW, High Population

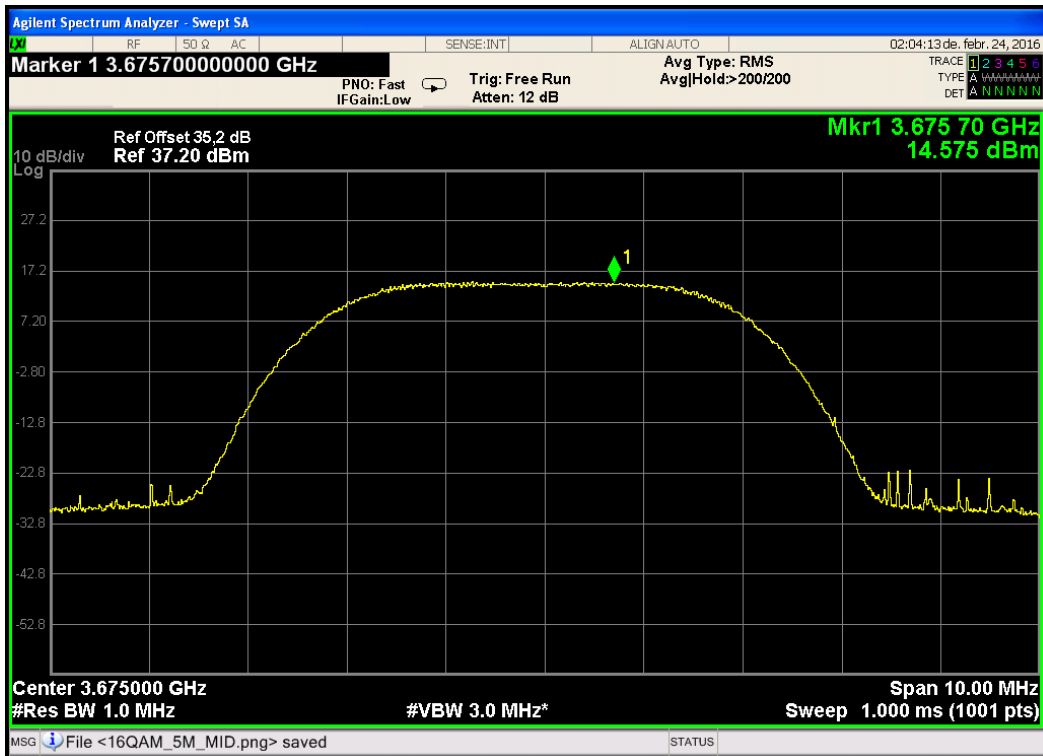

Figure 83. — 3675.0 MHz QPSK- 5MHz CBW, High Population

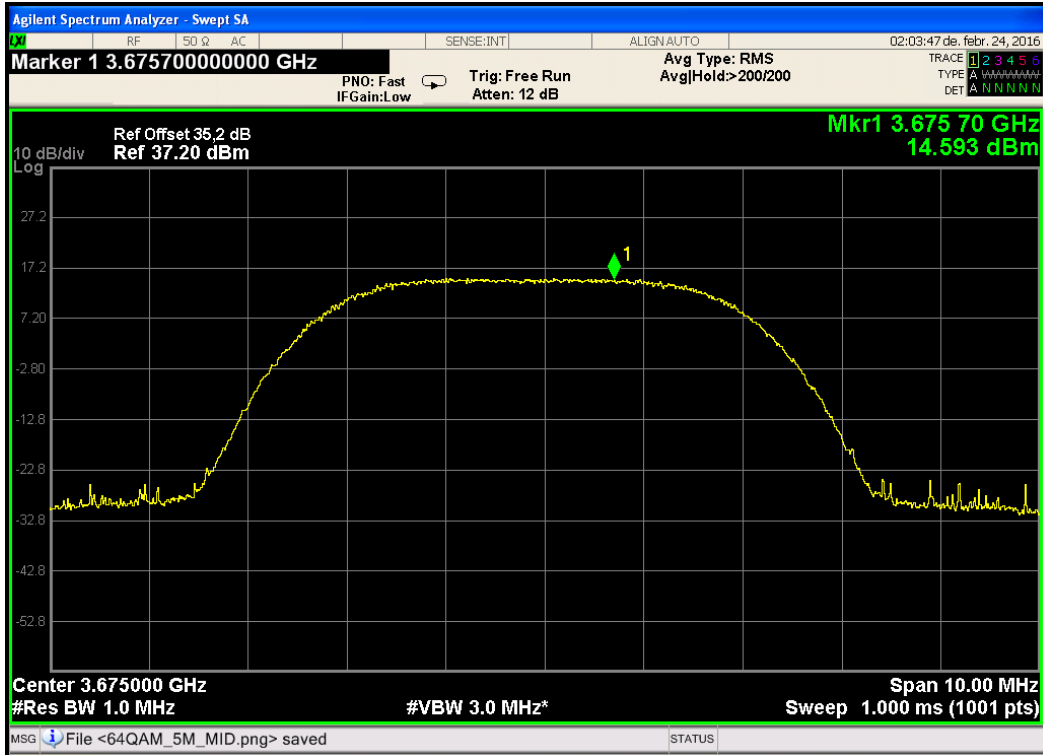

Figure 84. — 3675.0 MHz 16QAM- 5MHz CBW, High Population

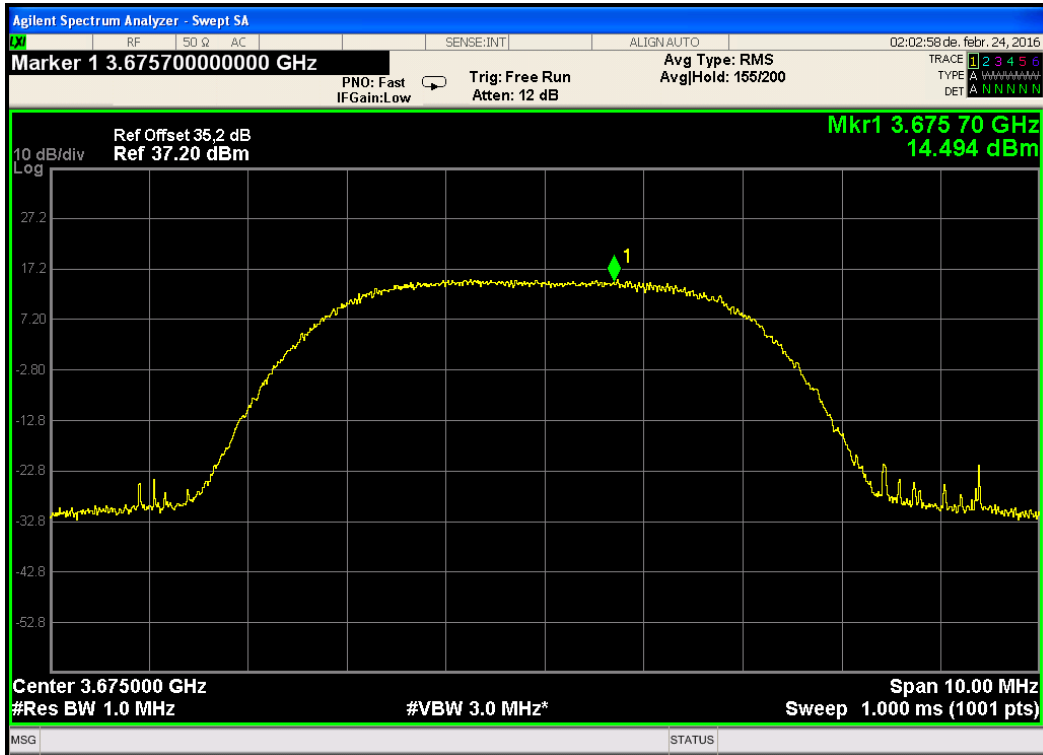

Figure 85. — 3675.0 MHz 64QAM- 5MHz CBW, High Population

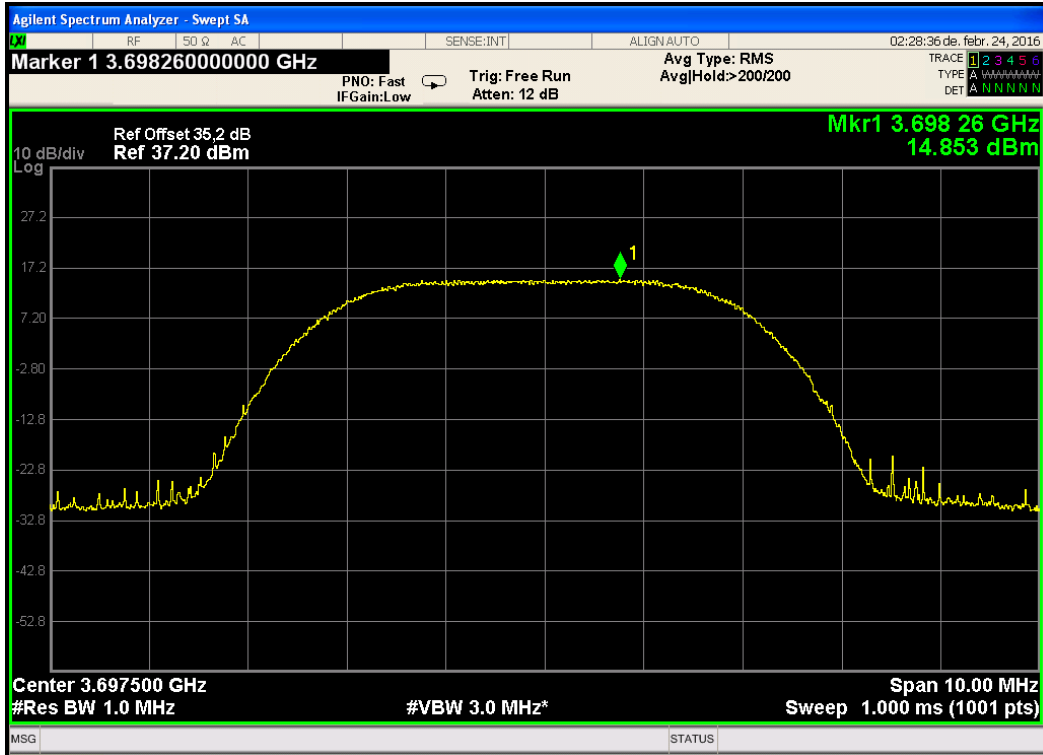

Figure 86. — 3697.5 MHz QPSK- 5MHz CBW, High Population

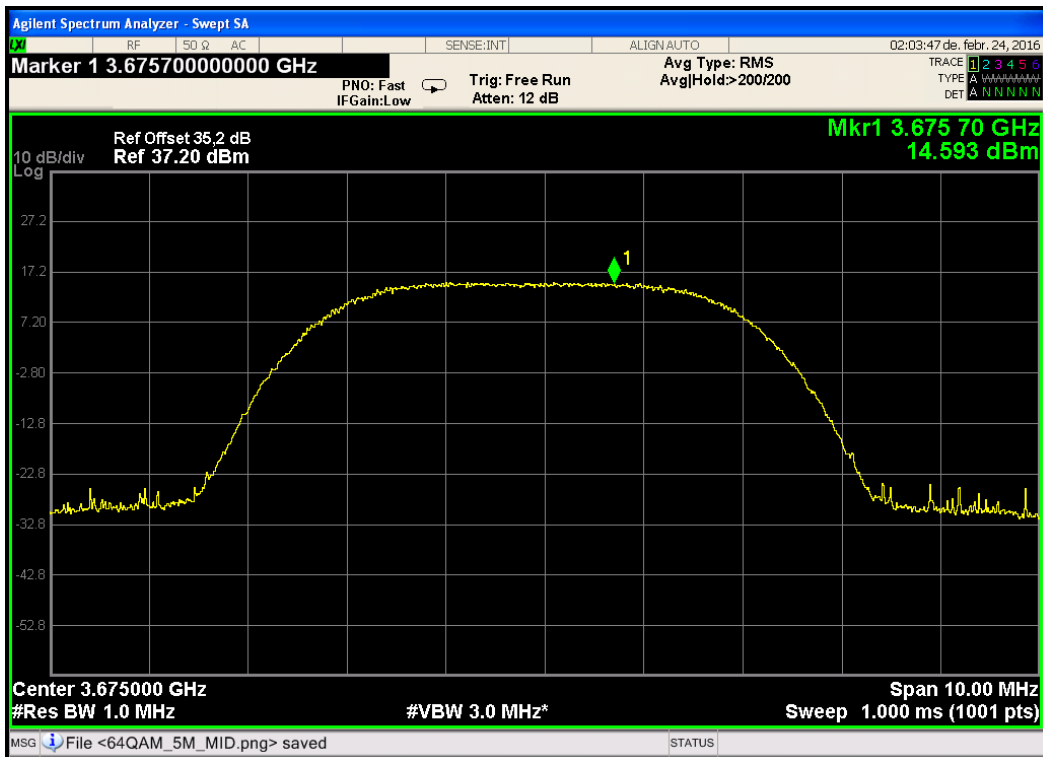

Figure 87. — 3697.5 MHz 16QAM- 5MHz CBW, High Population

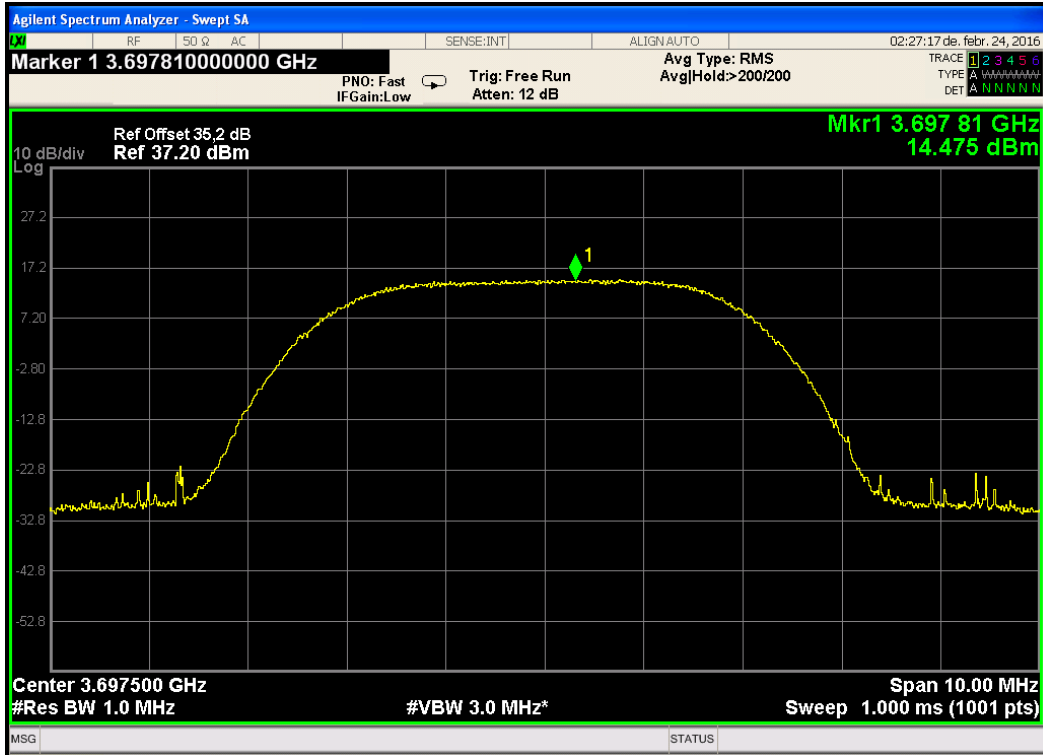

Figure 88. — 3697.5 MHz 64QAM- 5MHz CBW, High Population

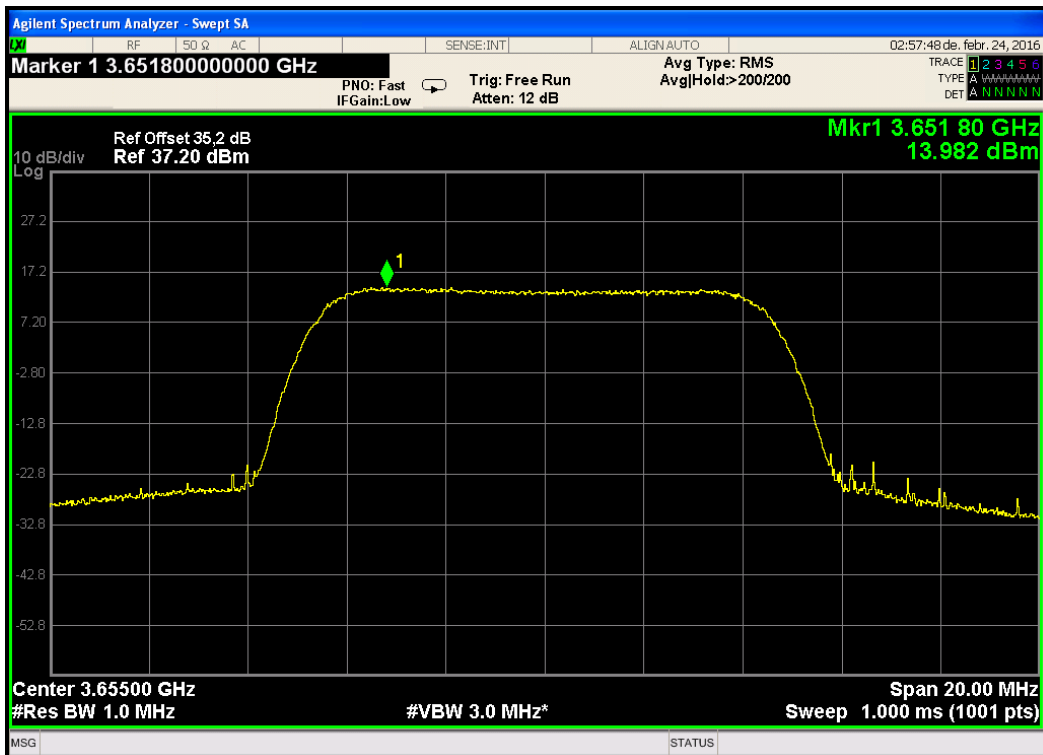

Figure 89. — 3655.0 MHz QPSK - 10MHz CBW, High Population

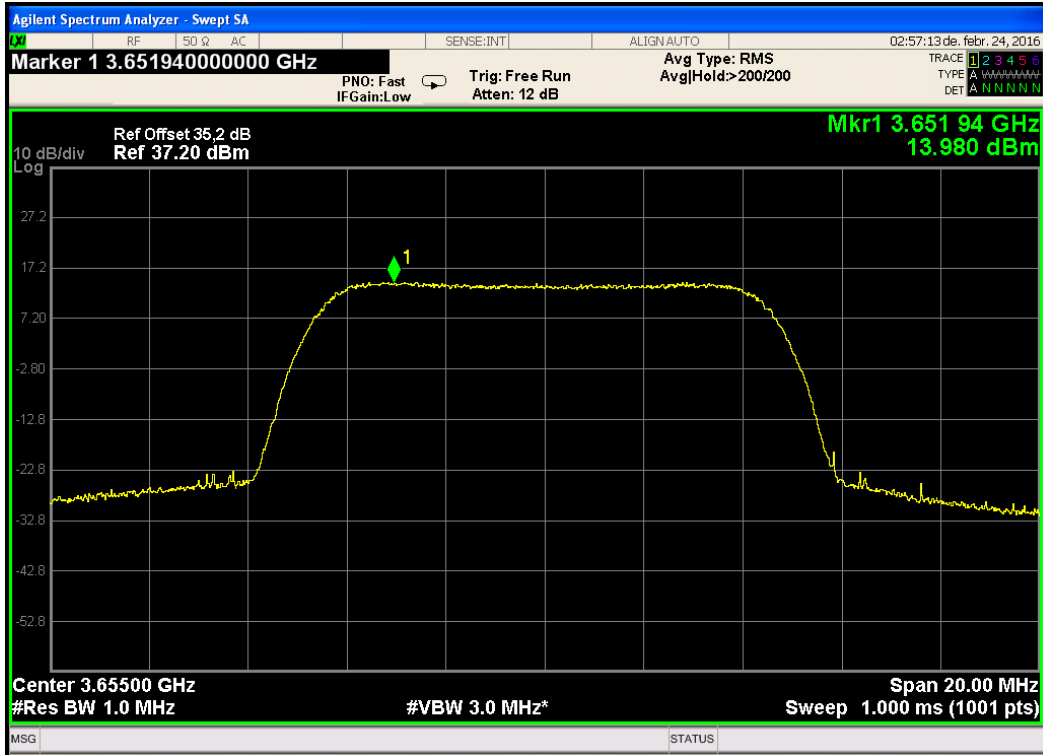

Figure 90. — 3655.0 MHz 16QAM - 10MHz CBW, High Population

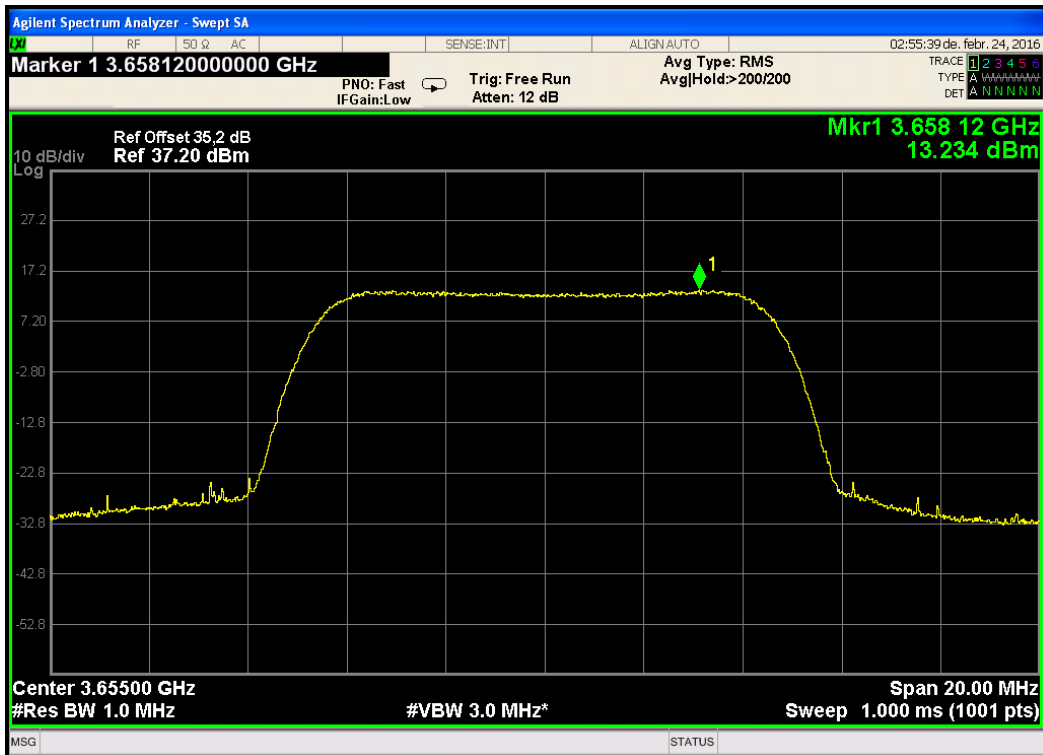

Figure 91. — 3655.0 MHz 64QAM - 10MHz CBW, High Population

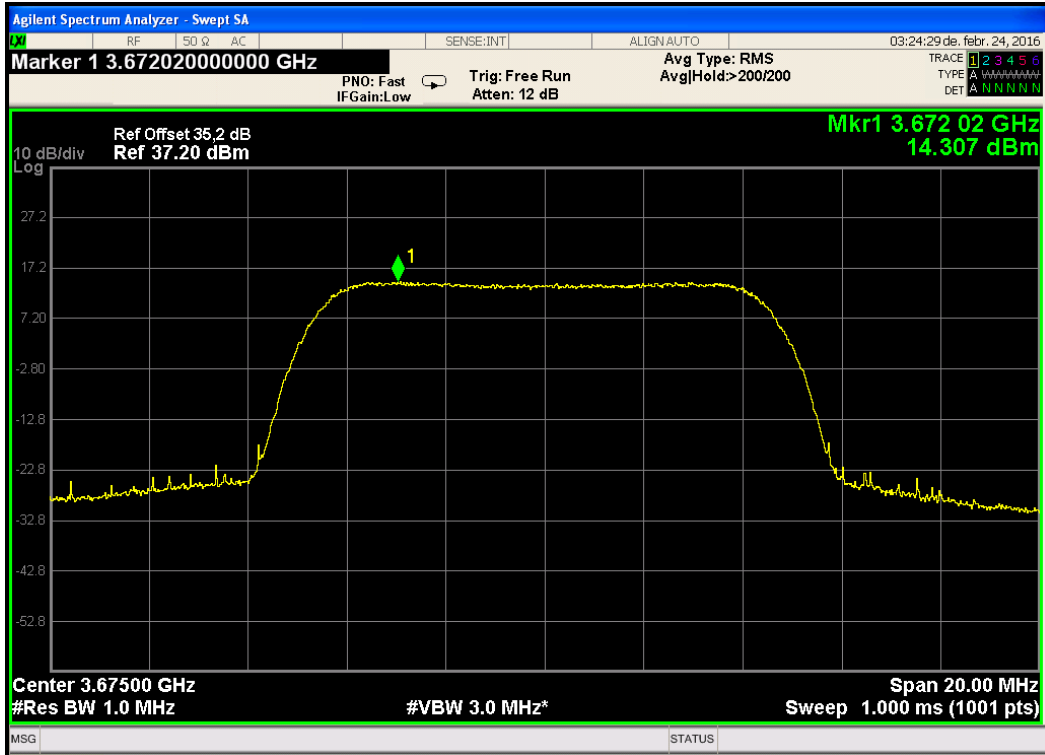

Figure 92. — 3675.0 MHz QPSK - 10MHz CBW, High Population

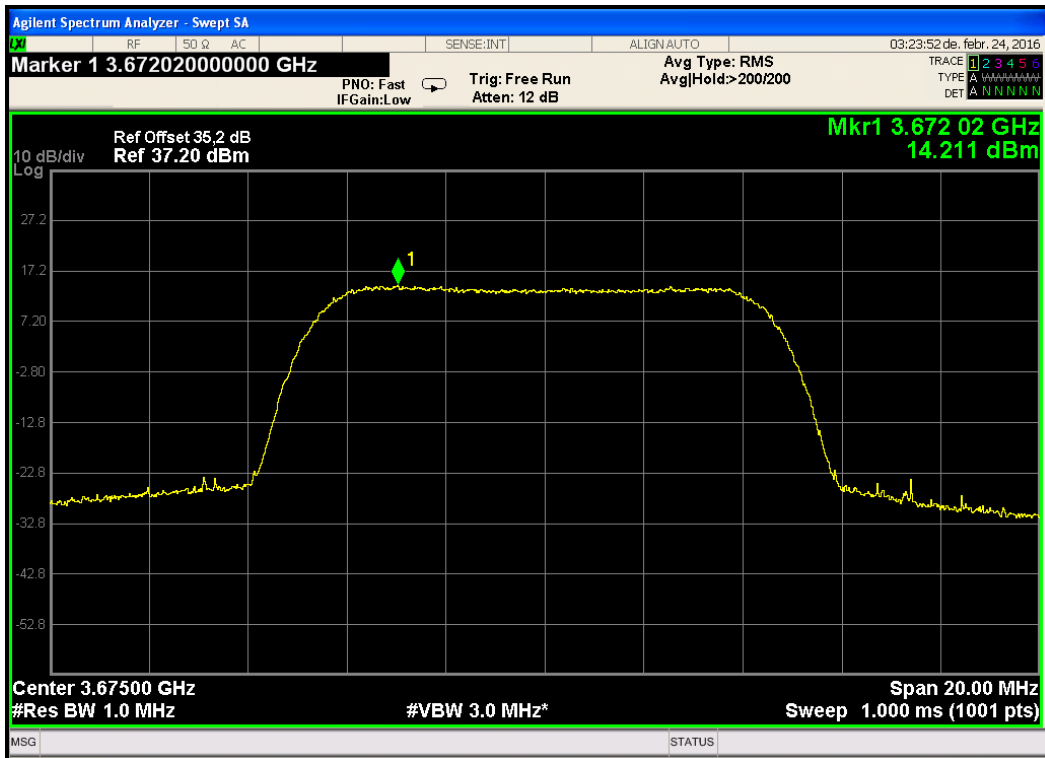

Figure 93. — 3675.0 MHz 16QAM - 10MHz CBW, High Population

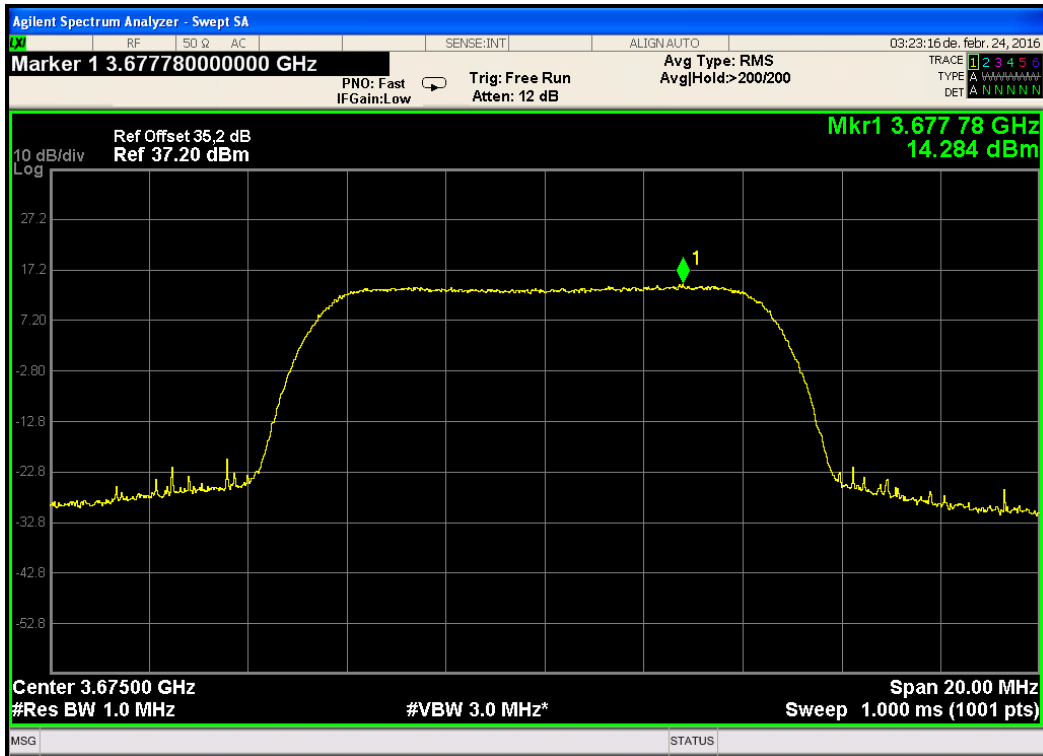

Figure 94. — 3675.0 MHz 64QAM - 10MHz CBW, High Population

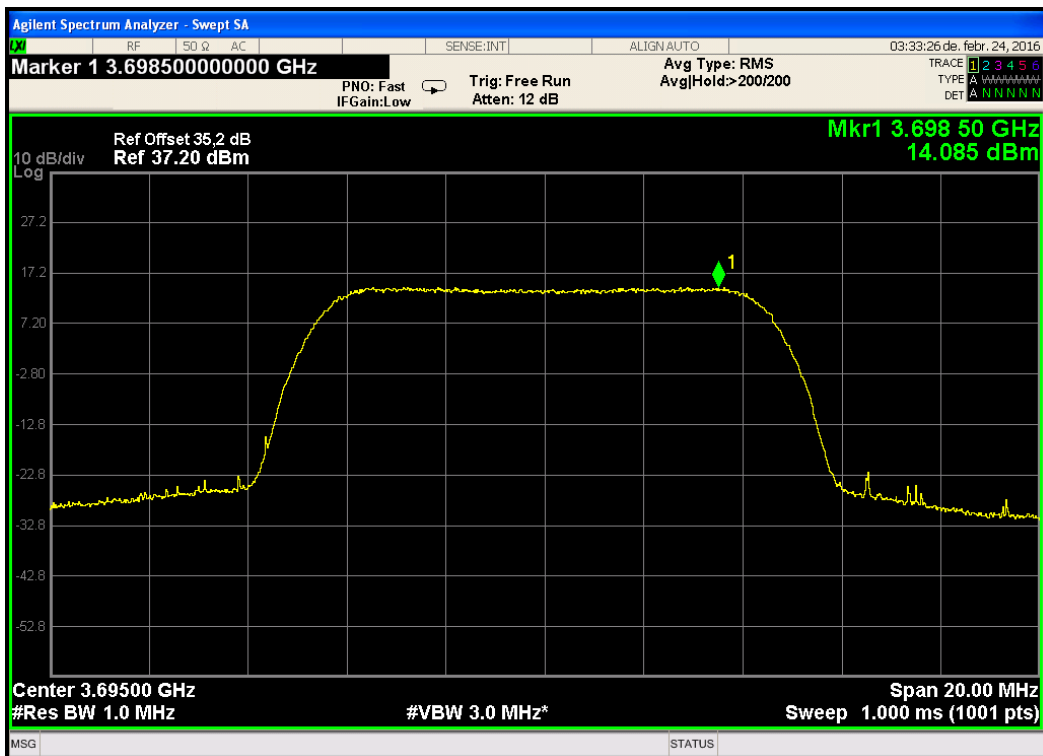

Figure 95. — 3695.0 MHz QPSK - 10MHz CBW, High Population

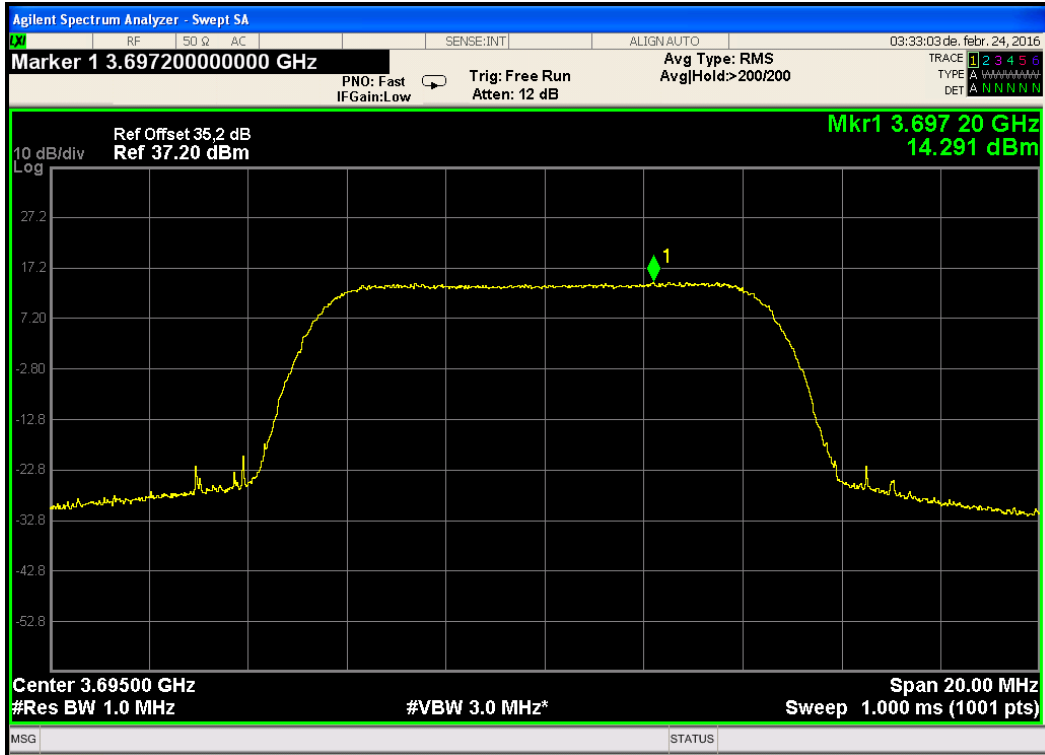

Figure 96. — 3695.0 MHz 16QAM - 10MHz CBW, High Population

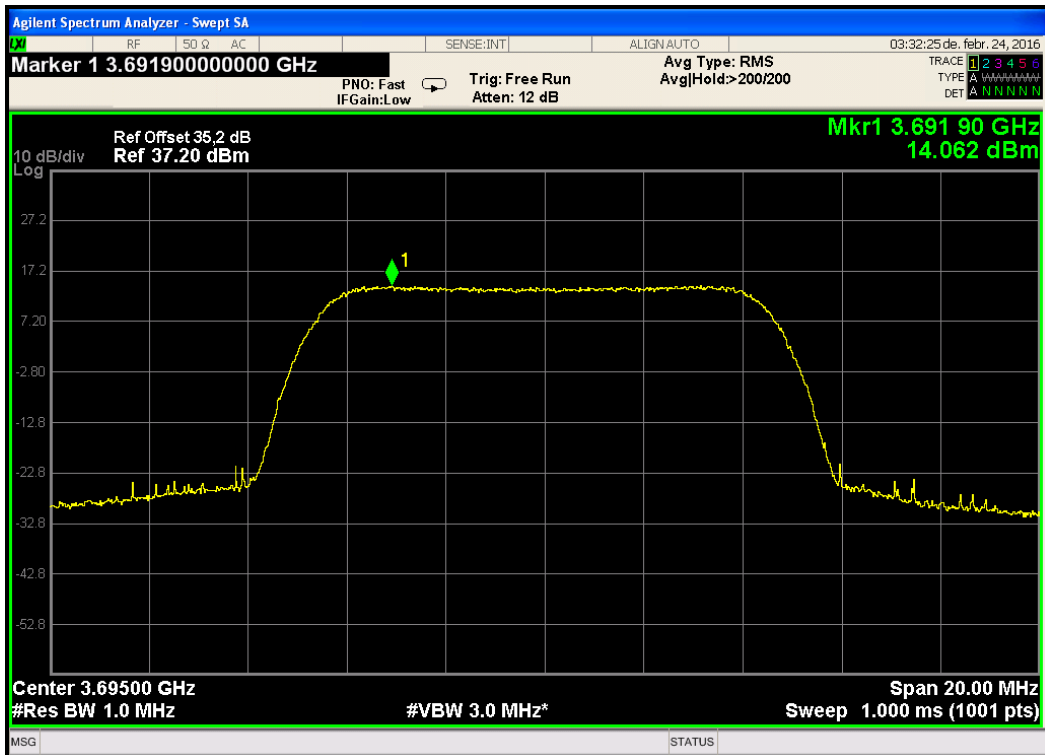

Figure 97. — 3695.0 MHz 64QAM - 10MHz CBW, High Population

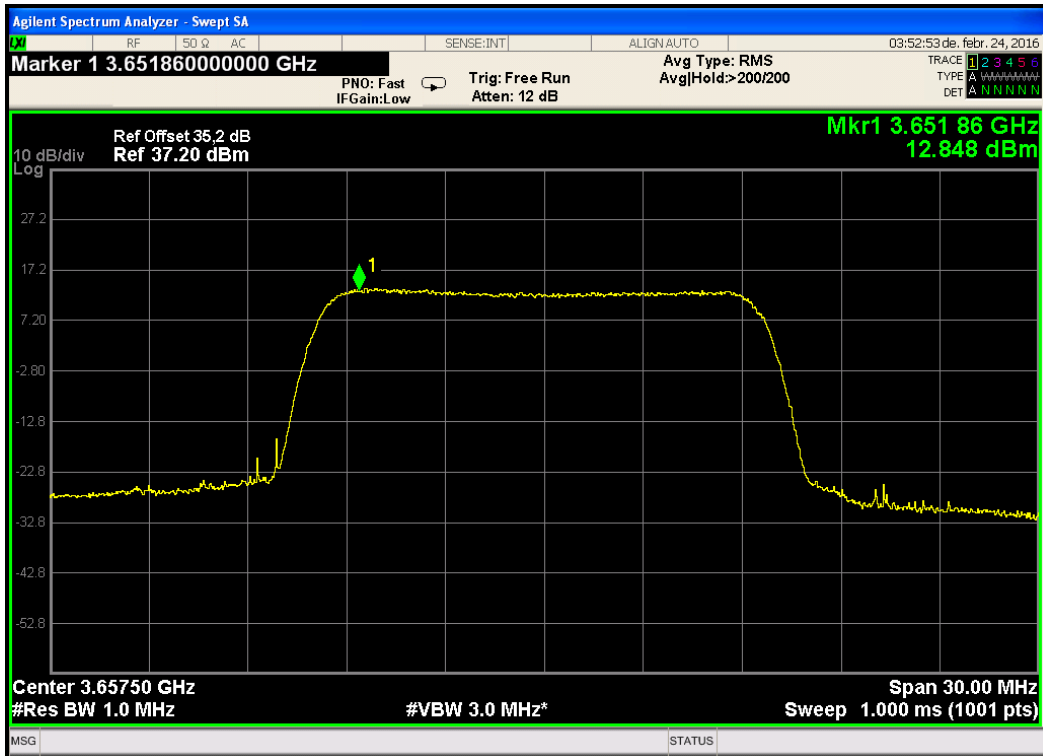

Figure 98. — 3657.5MHz QPSK - 15MHz CBW, High Population

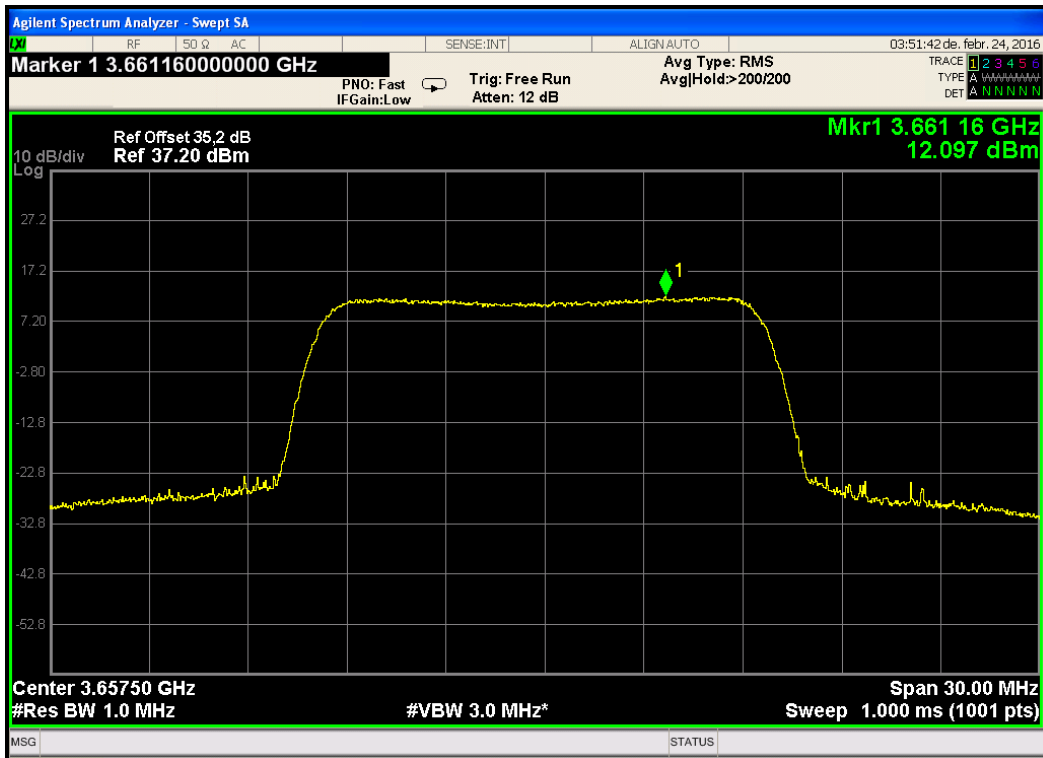

Figure 99. — 3657.5MHz 16QAM - 15MHz CBW, High Population

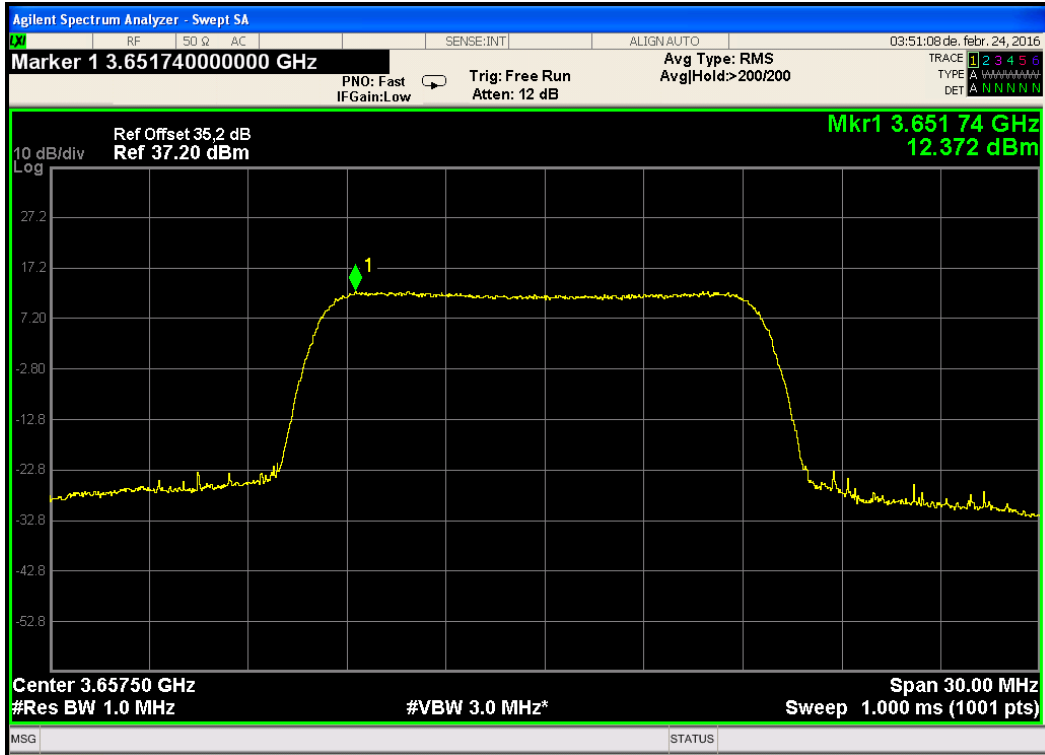

Figure 100. — 3657.5MHz 64QAM - 15MHz CBW, High Population

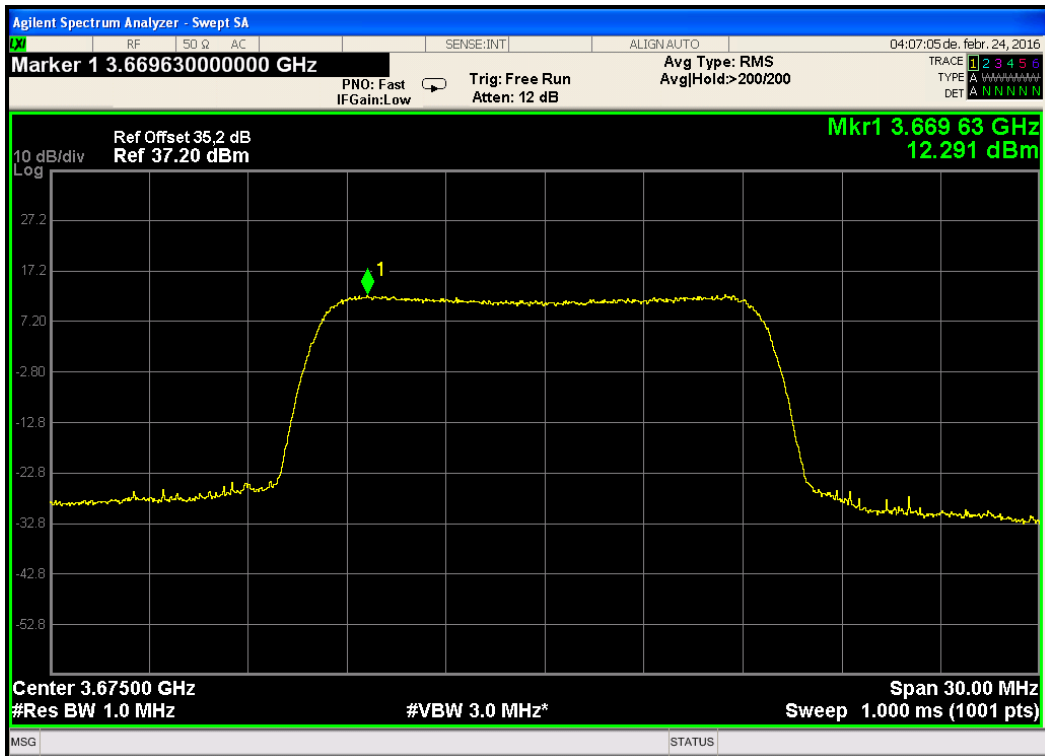

Figure 101. — 3675.0MHz QPSK - 15MHz CBW, High Population

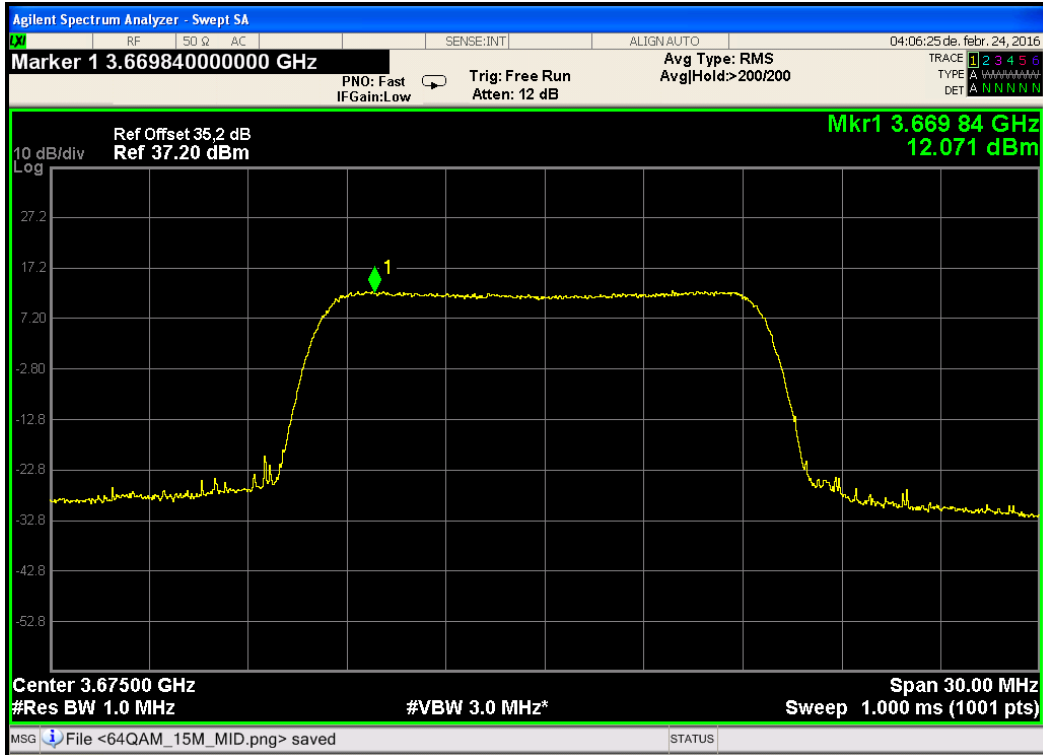

Figure 102. — 3675.0MHz 16QAM - 15MHz CBW, High Population

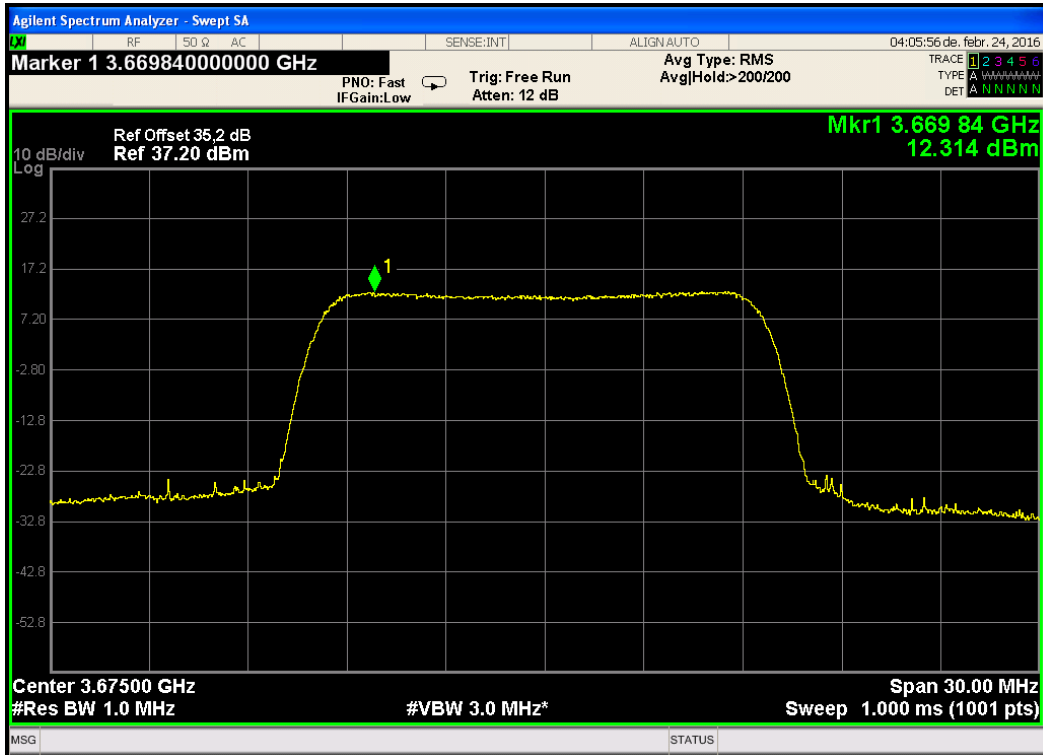

Figure 103. — 3675.0MHz 64QAM - 15MHz CBW, High Population

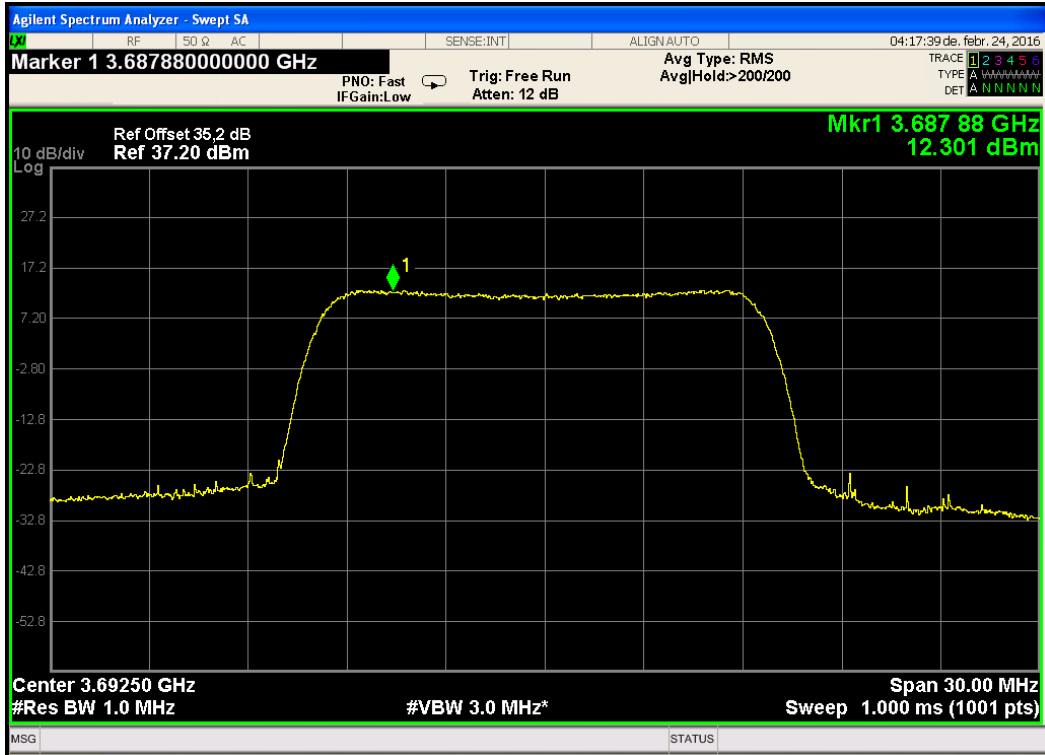

Figure 104. — 3692.5MHz QPSK - 15MHz CBW, High Population

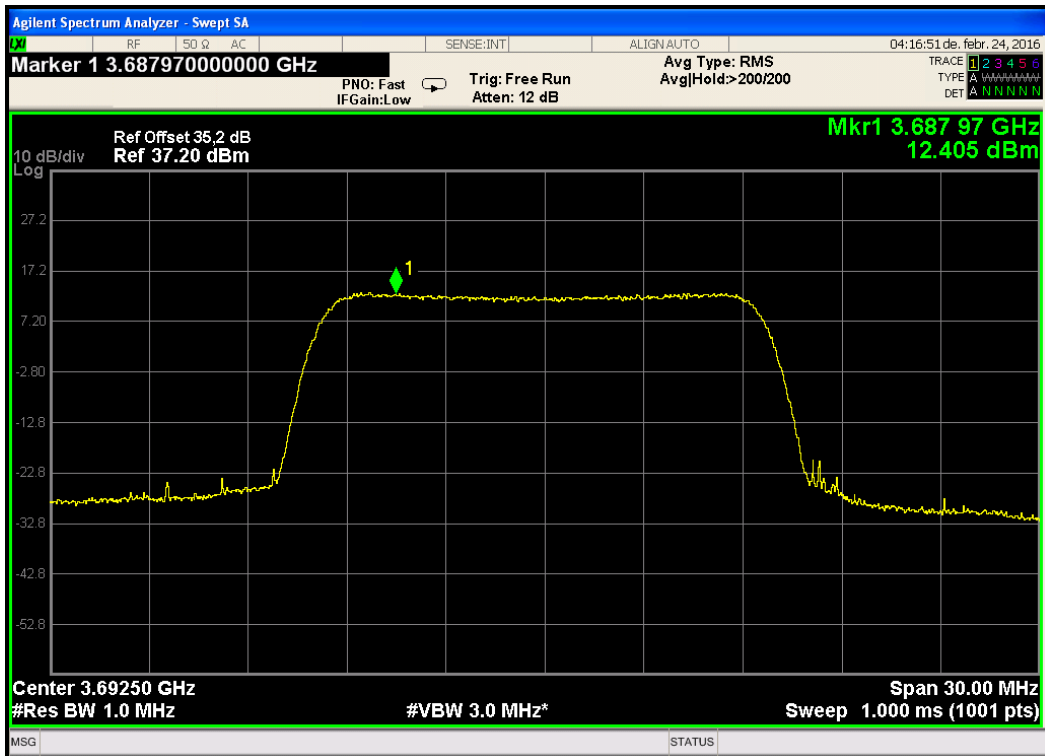

Figure 105. — 3692.5MHz 16QAM - 15MHz CBW, High Population

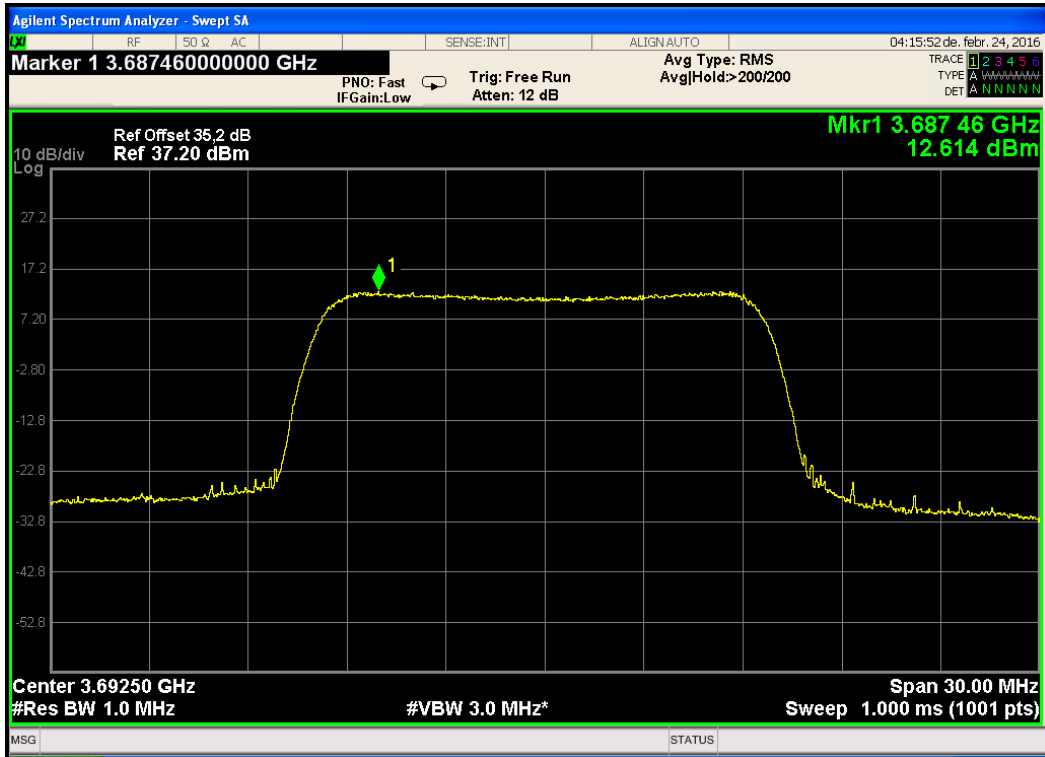

Figure 106. — 3692.5MHz 64QAM - 15MHz CBW, High Population

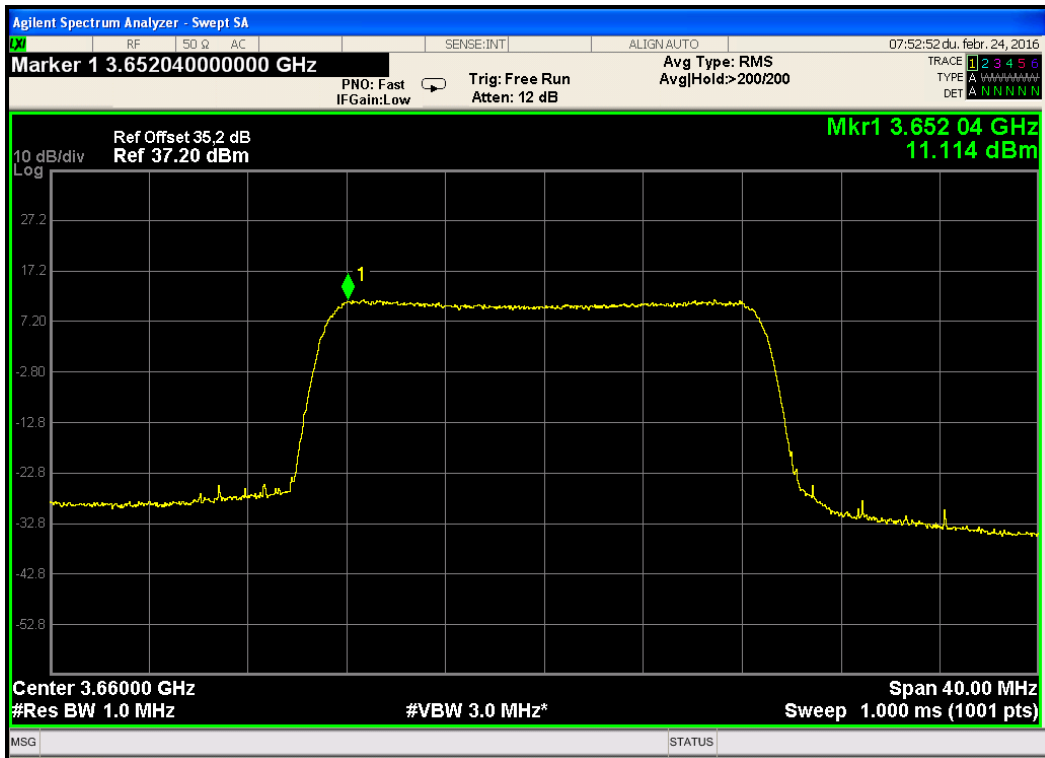

Figure 107. — 3660.0MHz QPSK - 20MHz CBW, High Population

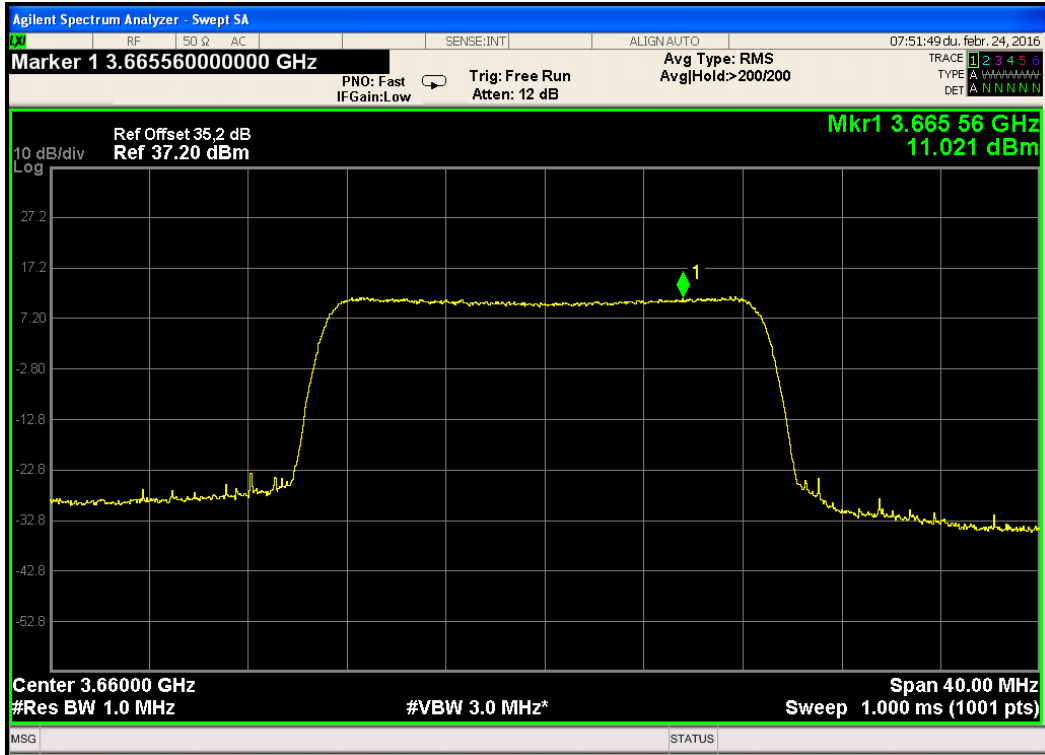

Figure 108. — 3660.0MHz 16QAM - 20MHz CBW, High Population

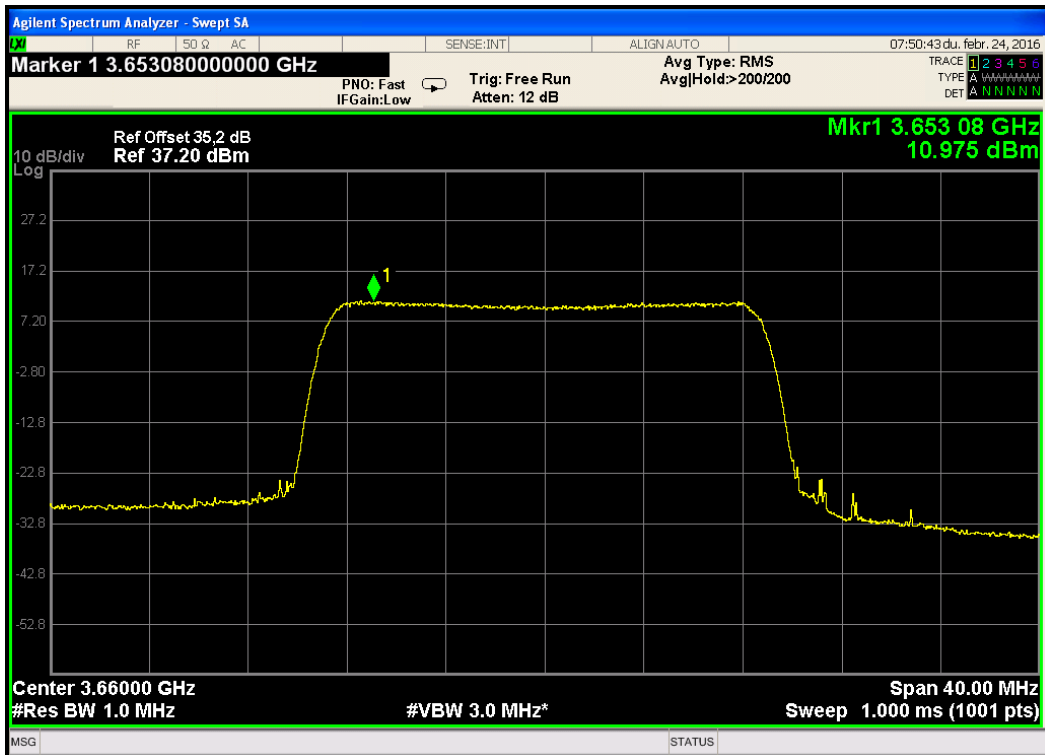

Figure 109. — 3660.0MHz 64QAM - 20MHz CBW, High Population

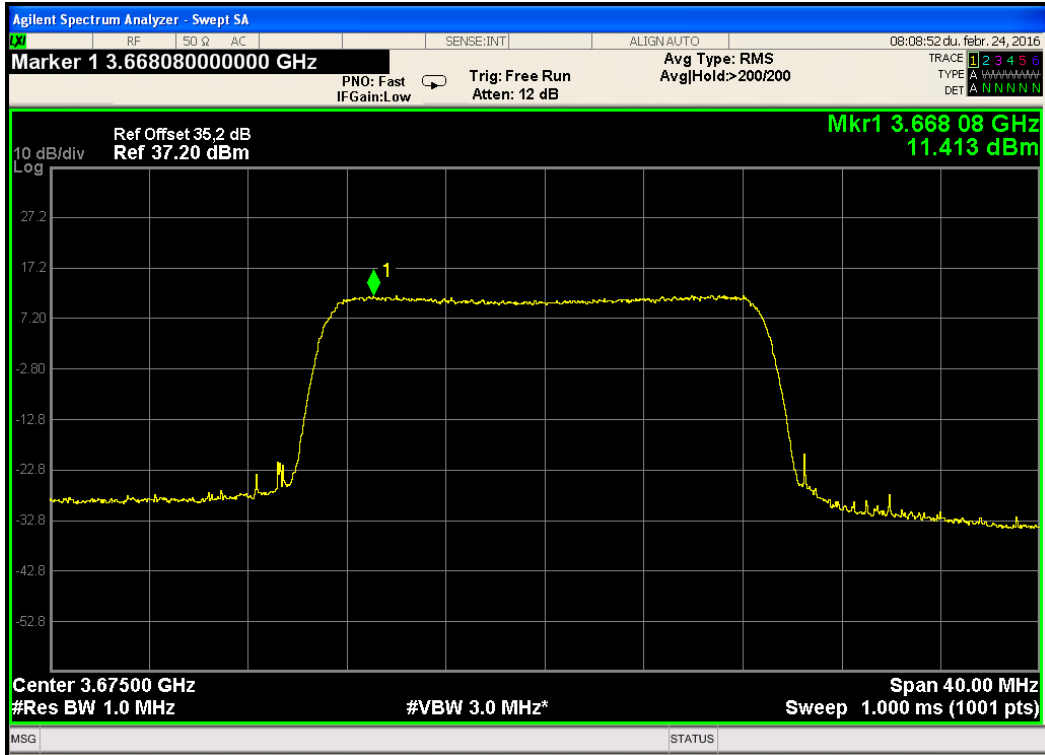

Figure 110. — 3675.0MHz QPSK - 20MHz CBW, High Population

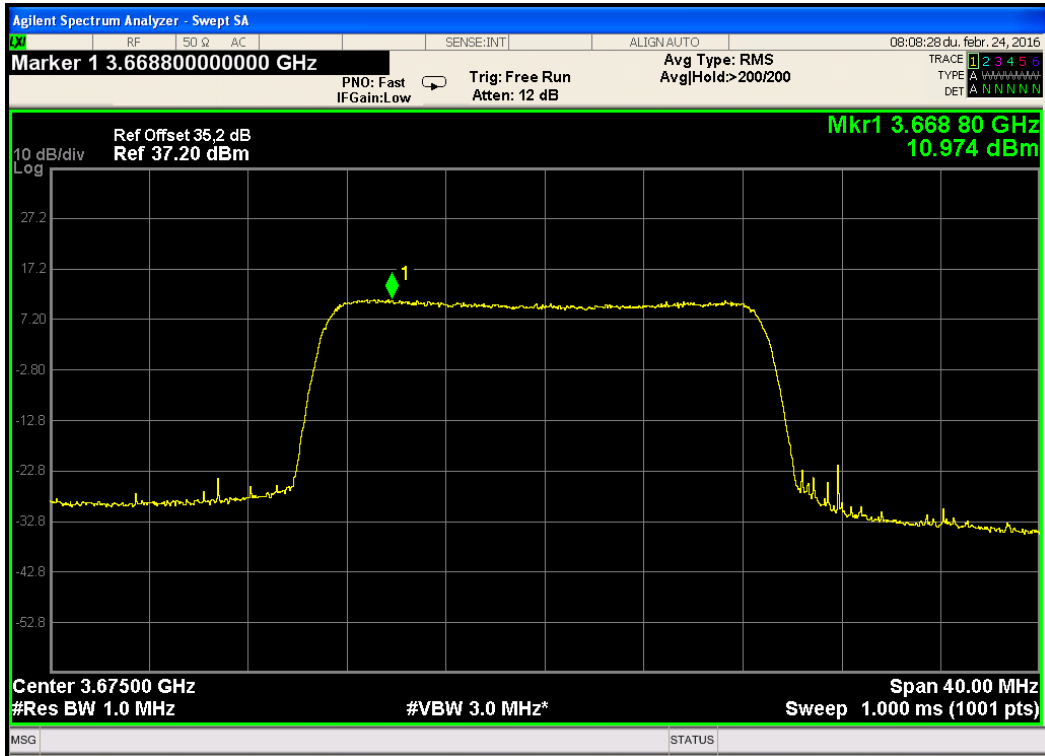

Figure 111. — 3675.0MHz 16QAM - 20MHz CBW, High Population

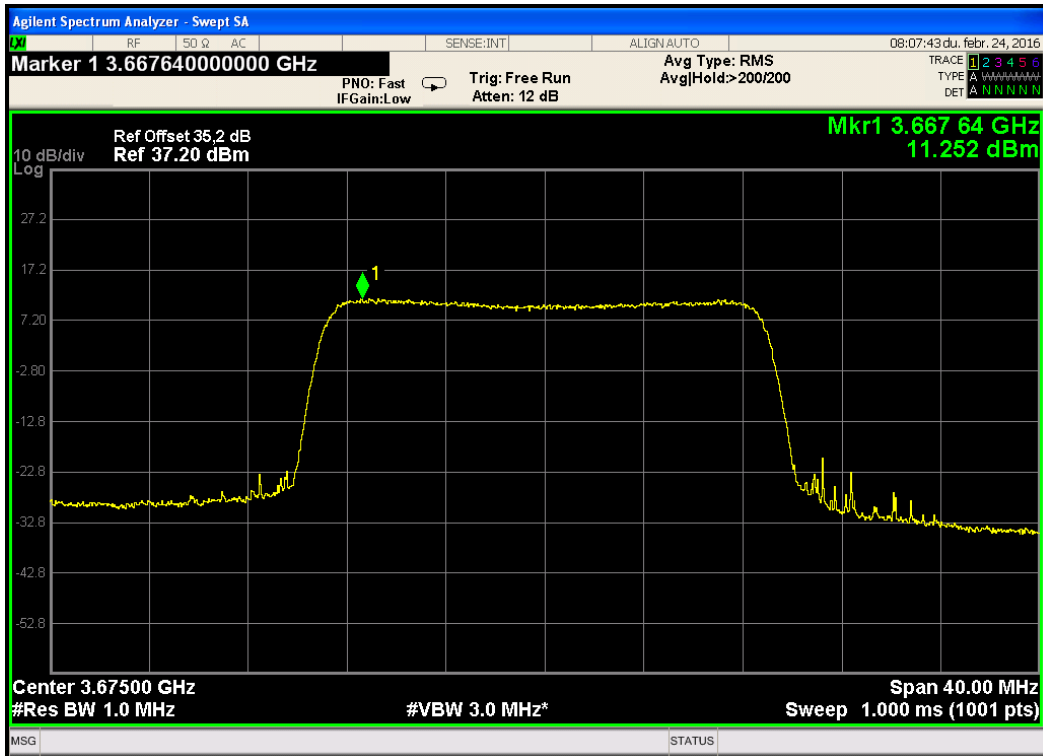

Figure 112. — 3675.0MHz 64QAM - 20MHz CBW, High Population

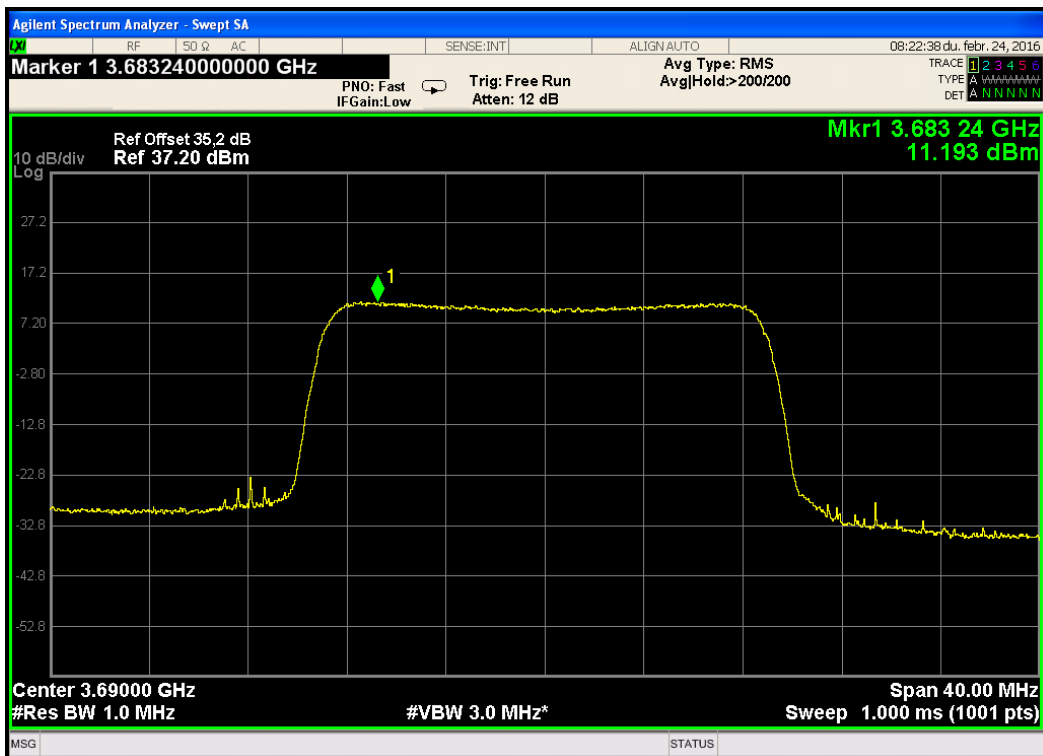

Figure 113. — 3690.0MHz QPSK - 20MHz CBW, High Population

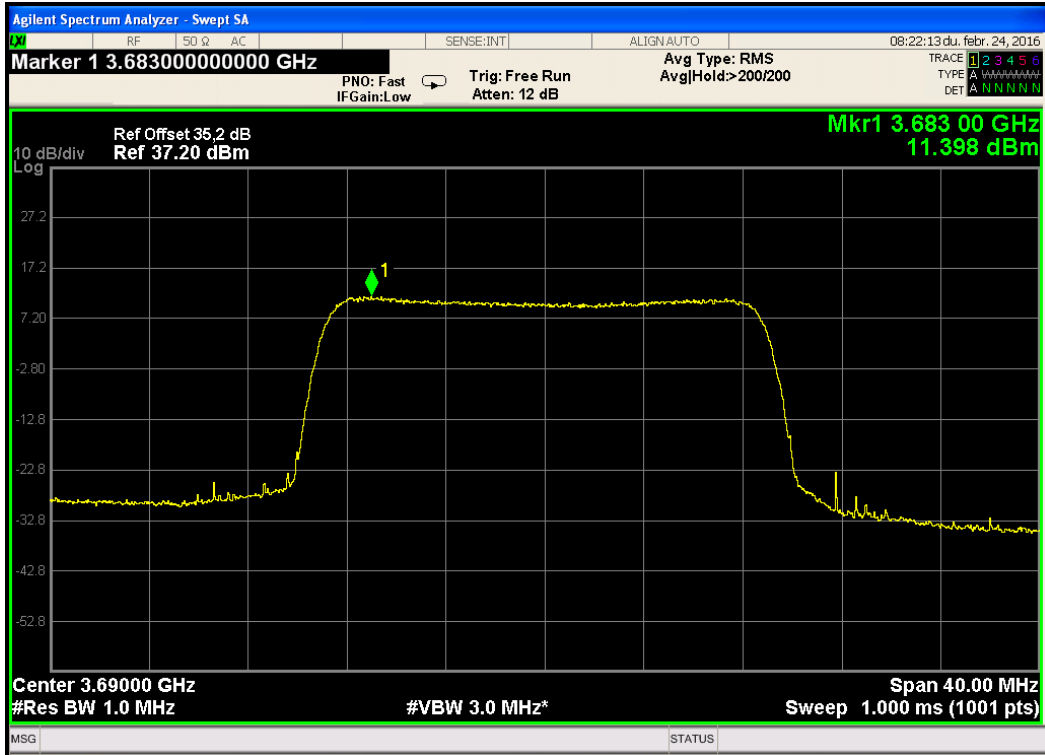

Figure 114. — 3690.0MHz 16QAM - 20MHz CBW, High Population

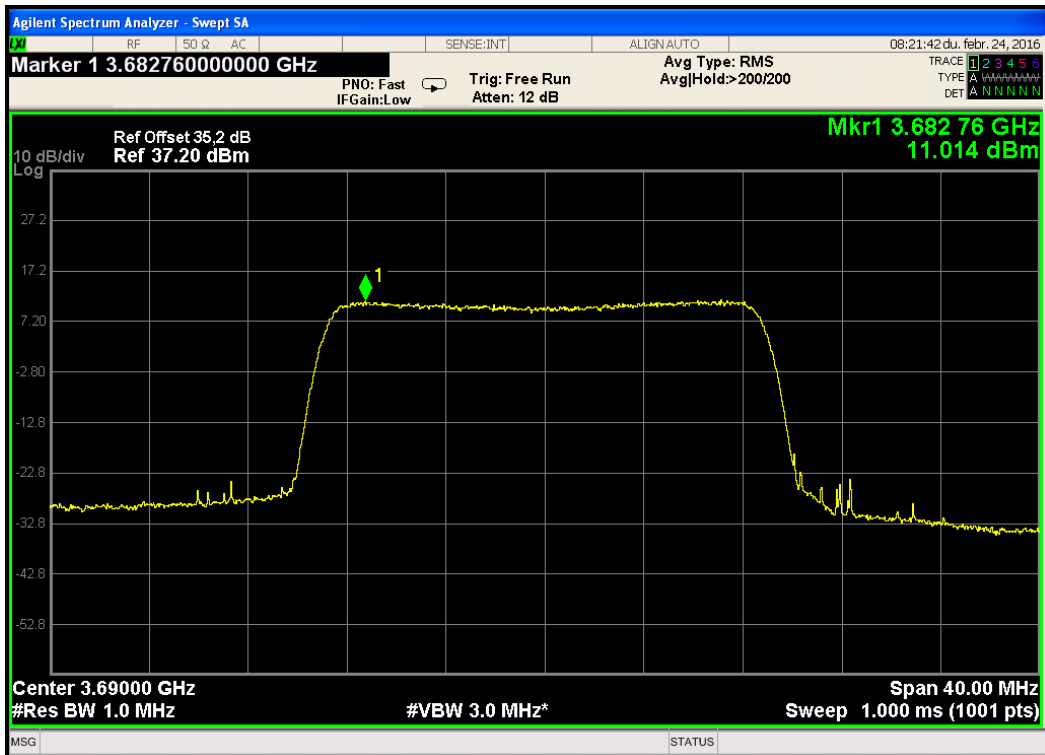

Figure 115. — 3690.0MHz 64QAM - 20MHz CBW, High Population

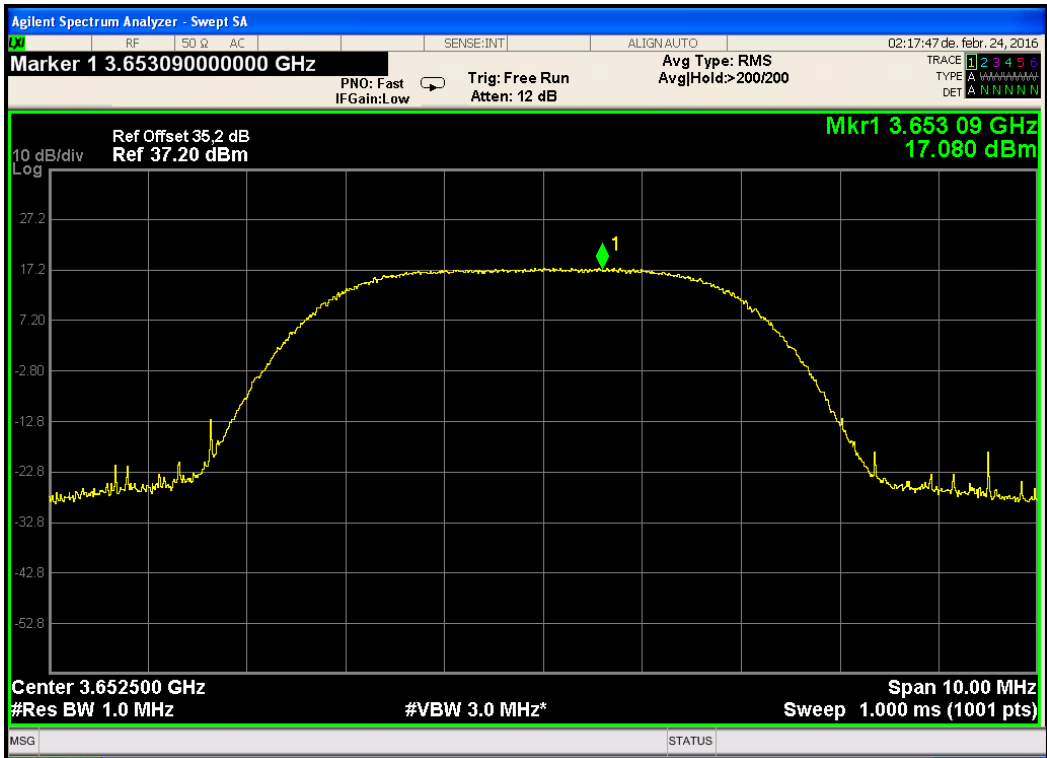

Figure 116. — 3652.5 MHz QPSK - 5MHz CBW, Low Population

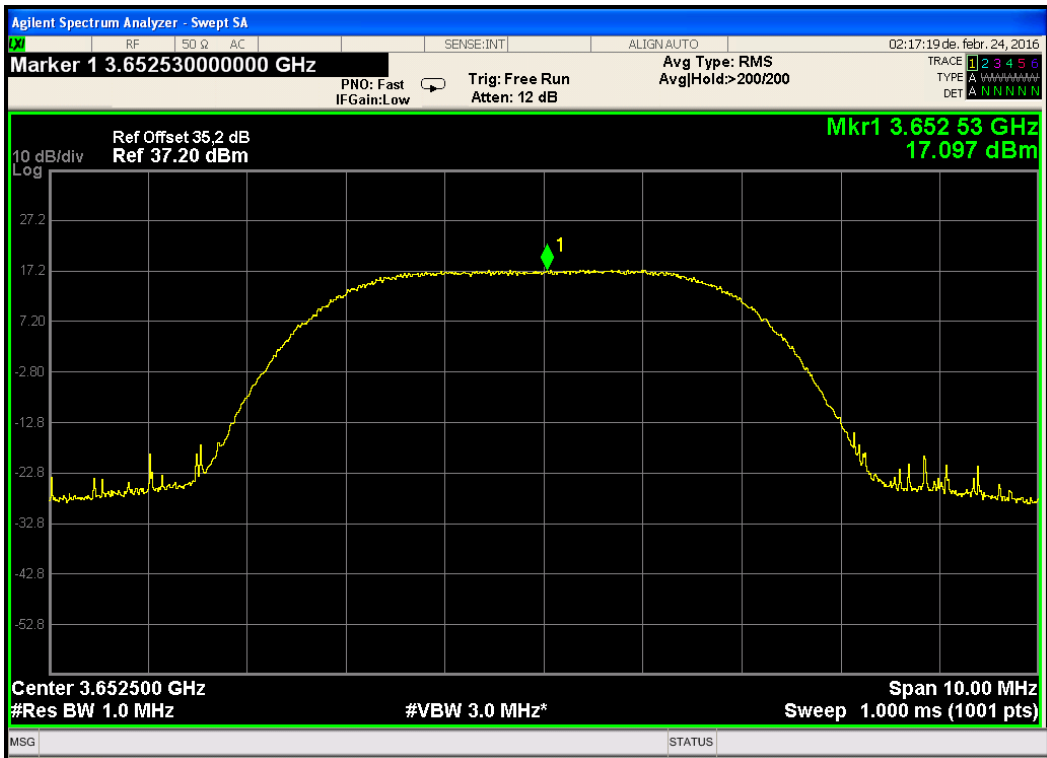

Figure 117. — 3652.5 MHz 16QAM - 5MHz CBW, Low Population

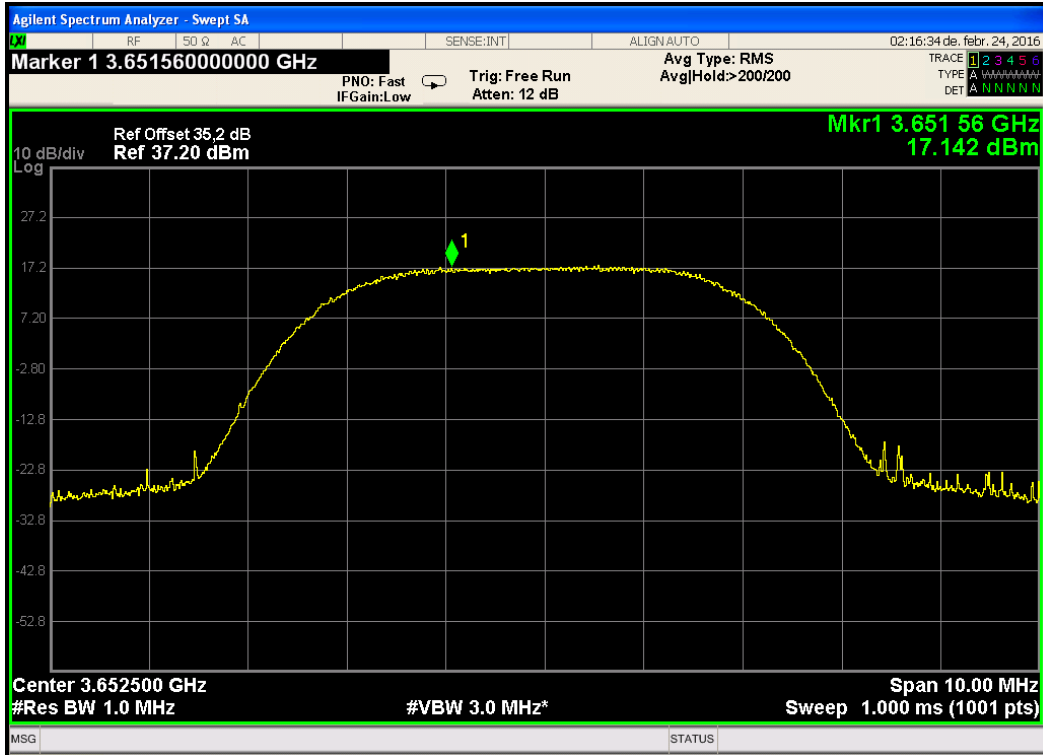

Figure 118. — 3652.5 MHz 64QAM - 5MHz CBW, Low Population

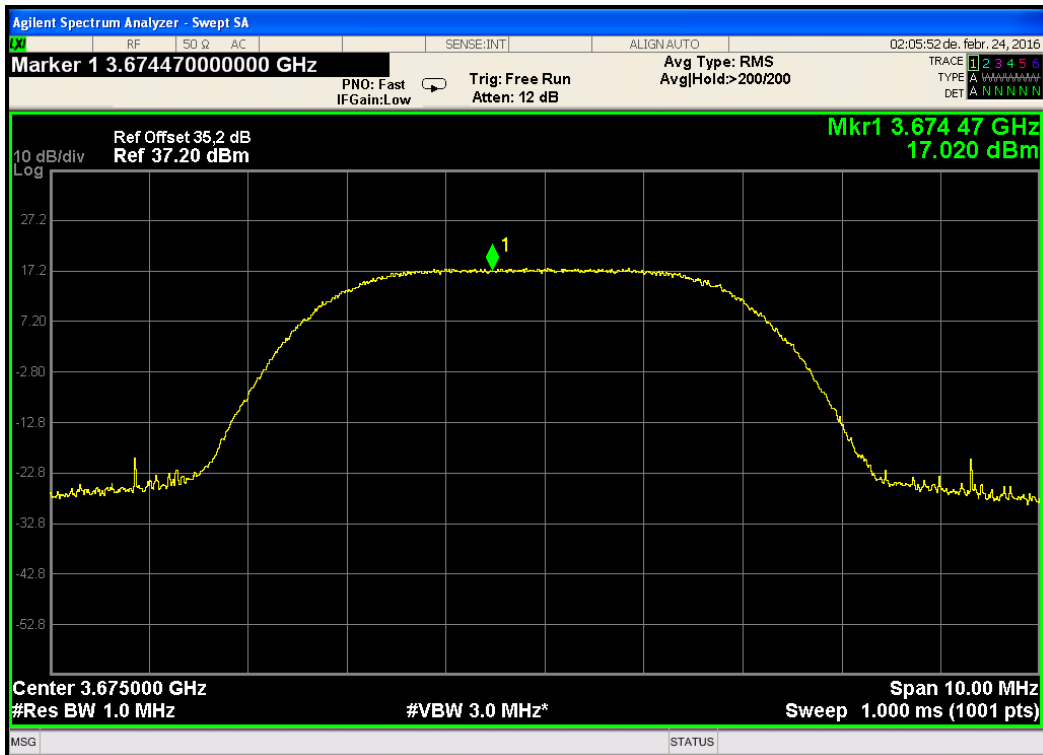

Figure 119. — 3675.0 MHz QPSK - 5MHz CBW, Low Population

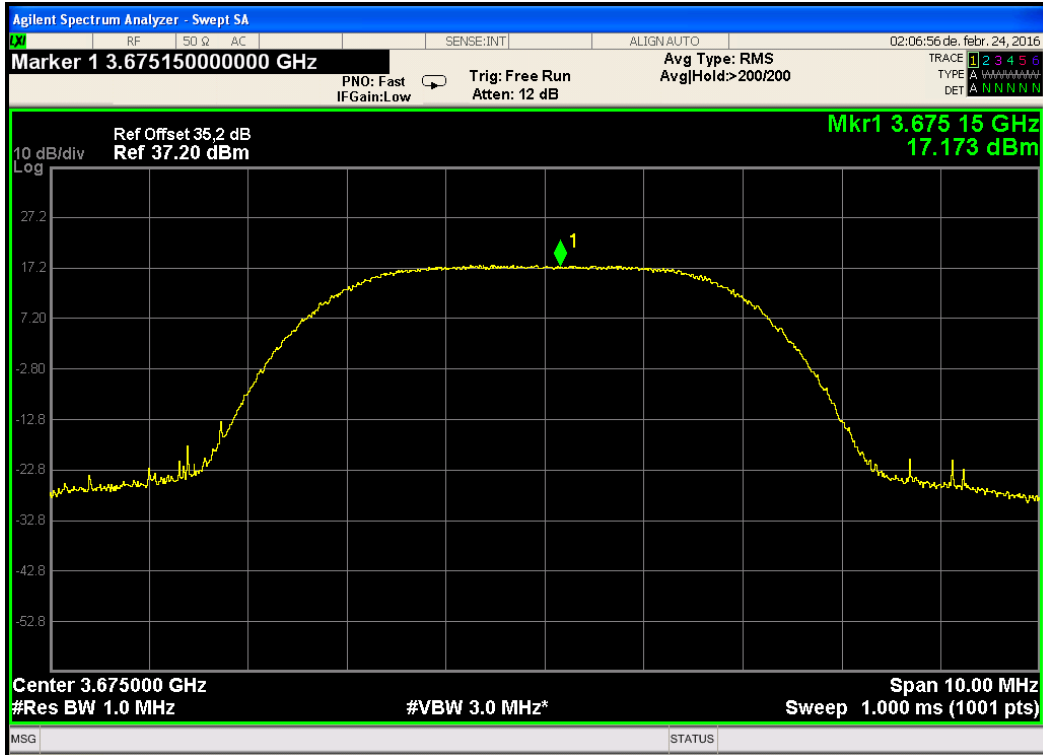

Figure 120. — 3675.0 MHz 16QAM - 5MHz CBW, Low Population

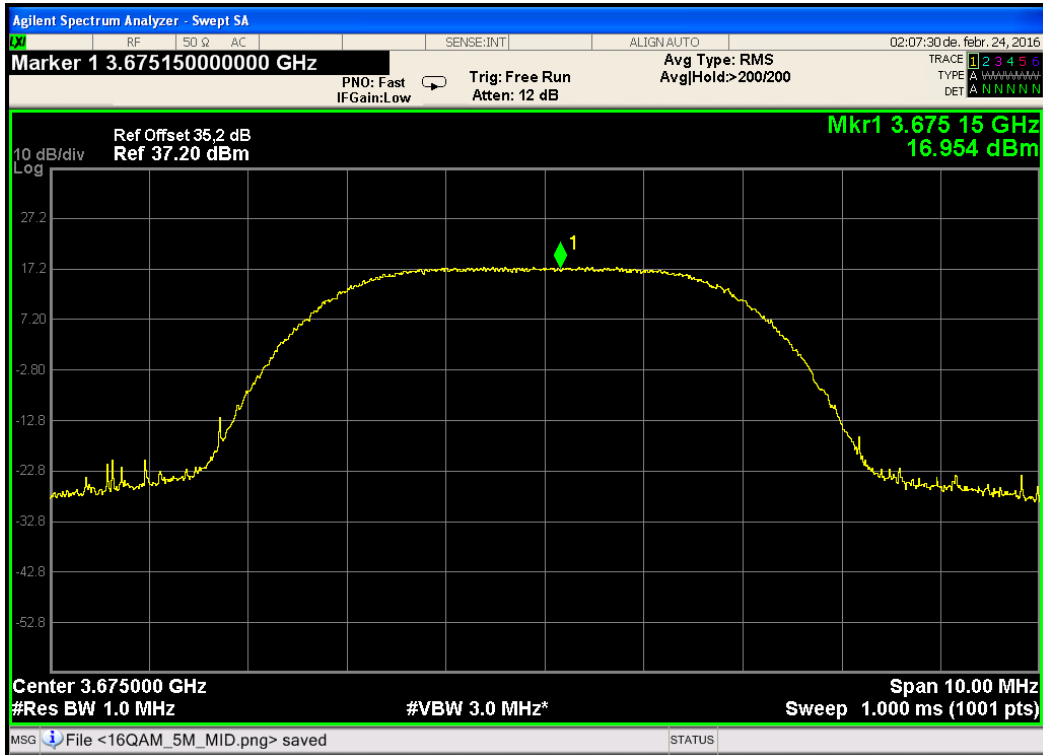

Figure 121. — 3675.0 MHz 64QAM - 5MHz CBW, Low Population

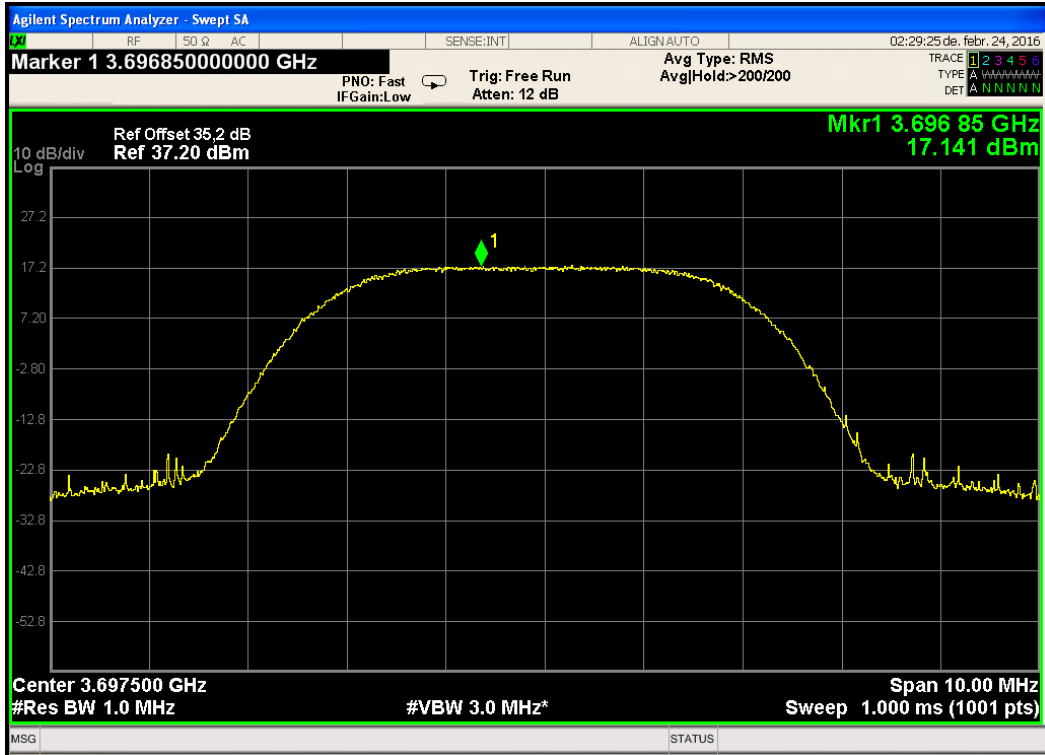

Figure 122. — 3697.5 MHz QPSK - 5MHz CBW, Low Population

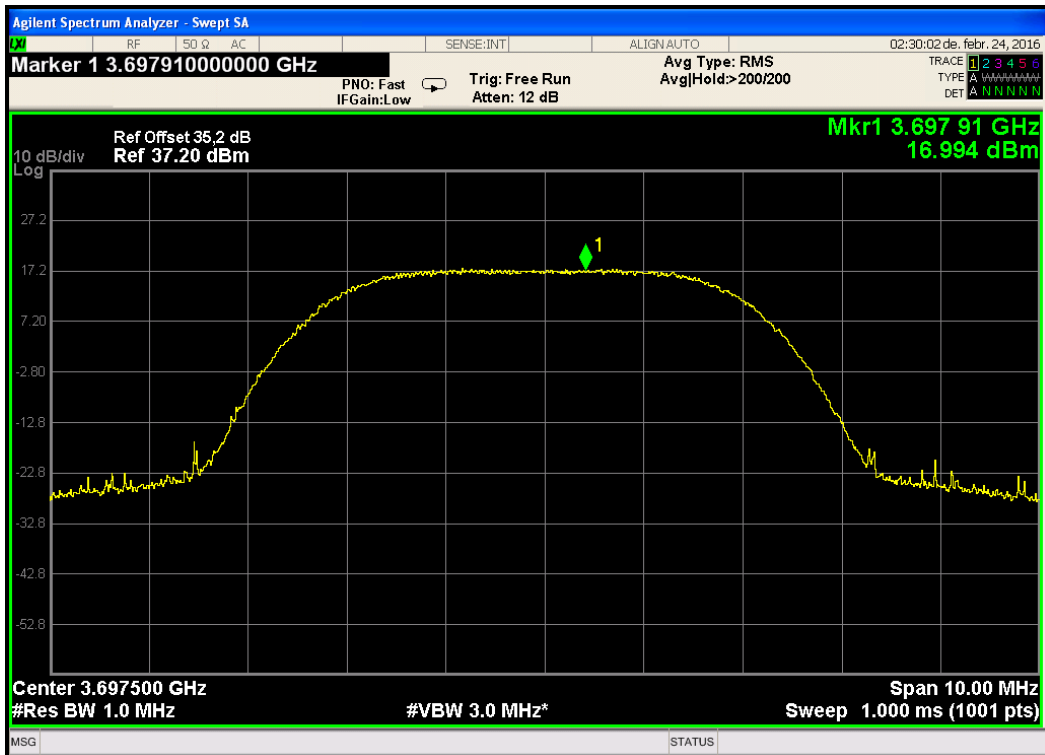

Figure 123. — 3697.5 MHz 16QAM - 5MHz CBW, Low Population

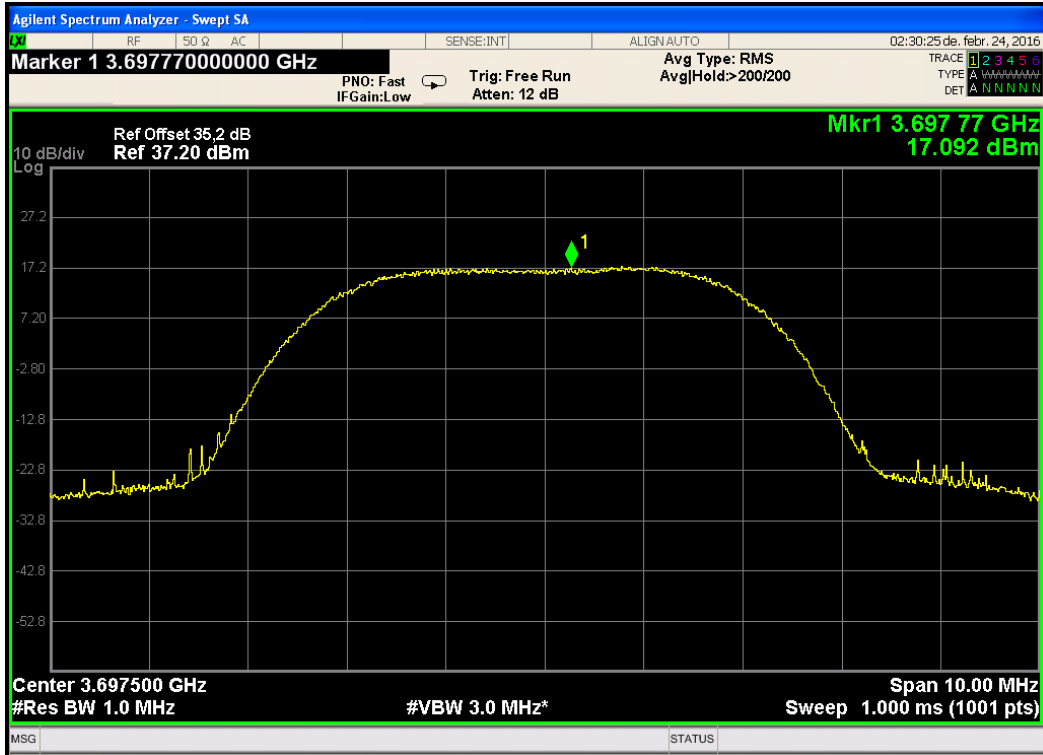

Figure 124. — 3697.5 MHz 64QAM - 5MHz CBW, Low Population

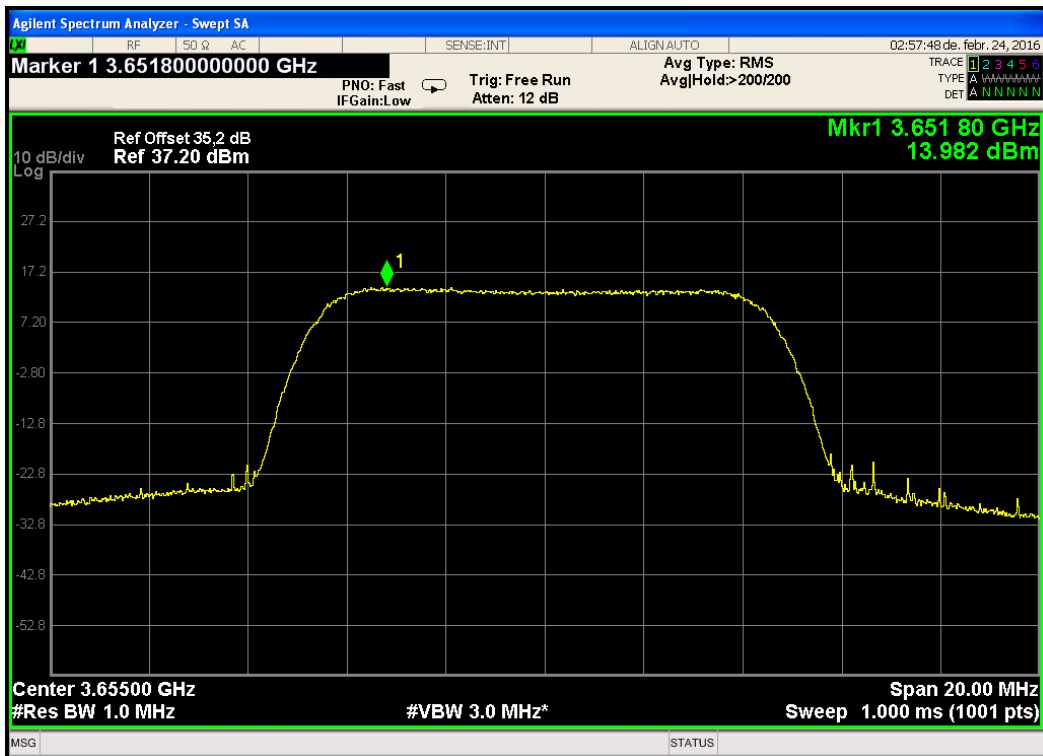

Figure 125. — 3655.0 MHz QPSK - 10MHz CBW, Low Population

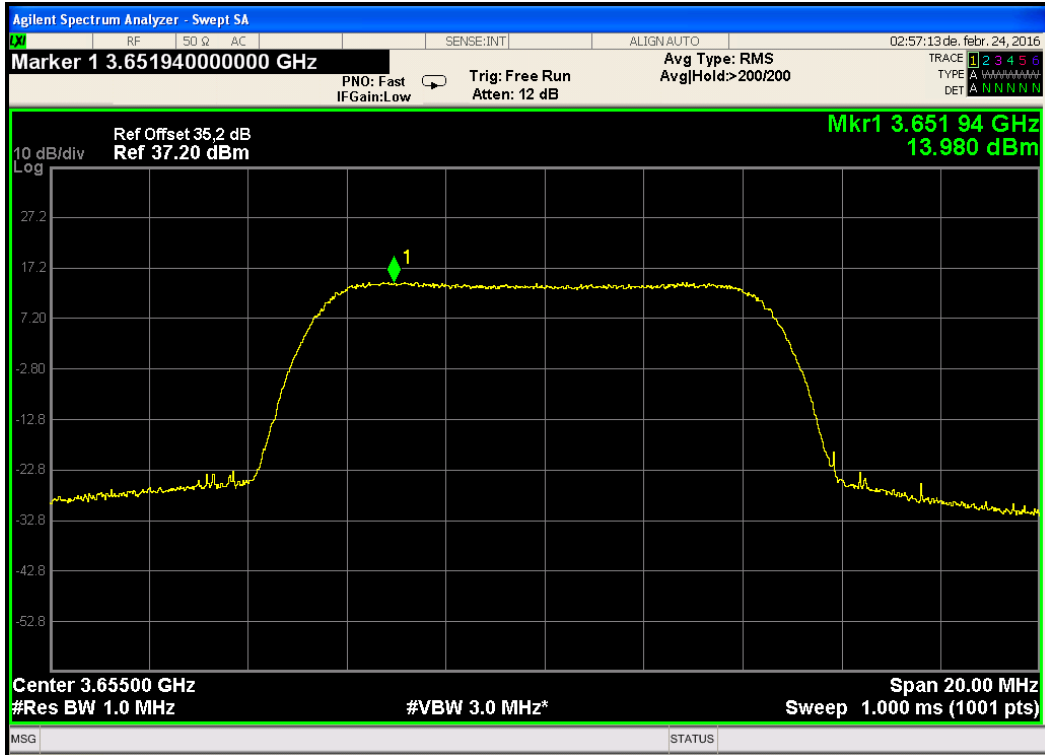

Figure 126. — 3655.0 MHz 16QAM - 10MHz CBW, Low Population

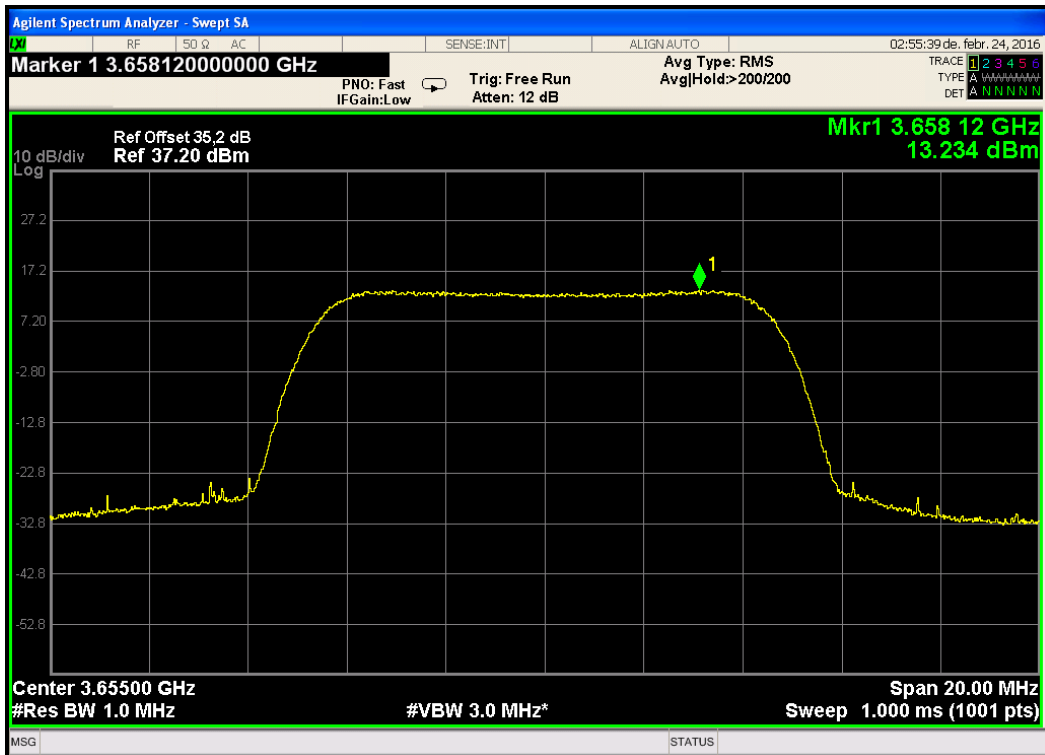

Figure 127. — 3655.0 MHz 64QAM - 10MHz CBW, Low Population

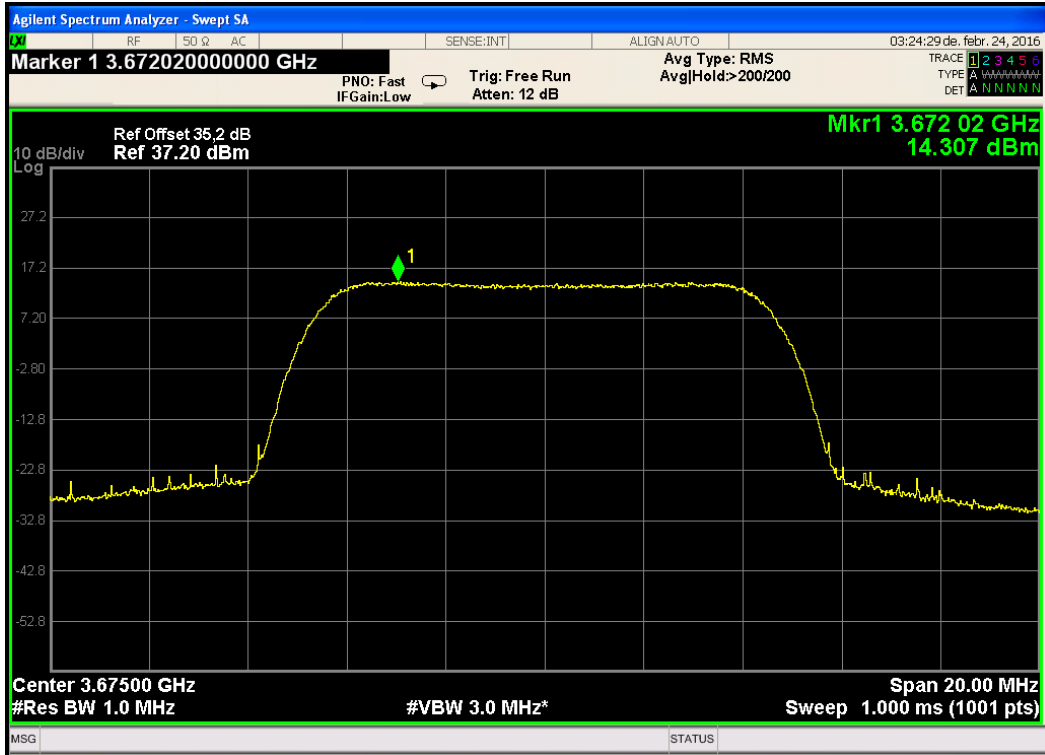

Figure 128. — 3675.0 MHz QPSK - 10MHz CBW, Low Population



Figure 129. — 3675.0 MHz 16QAM - 10MHz CBW, Low Population

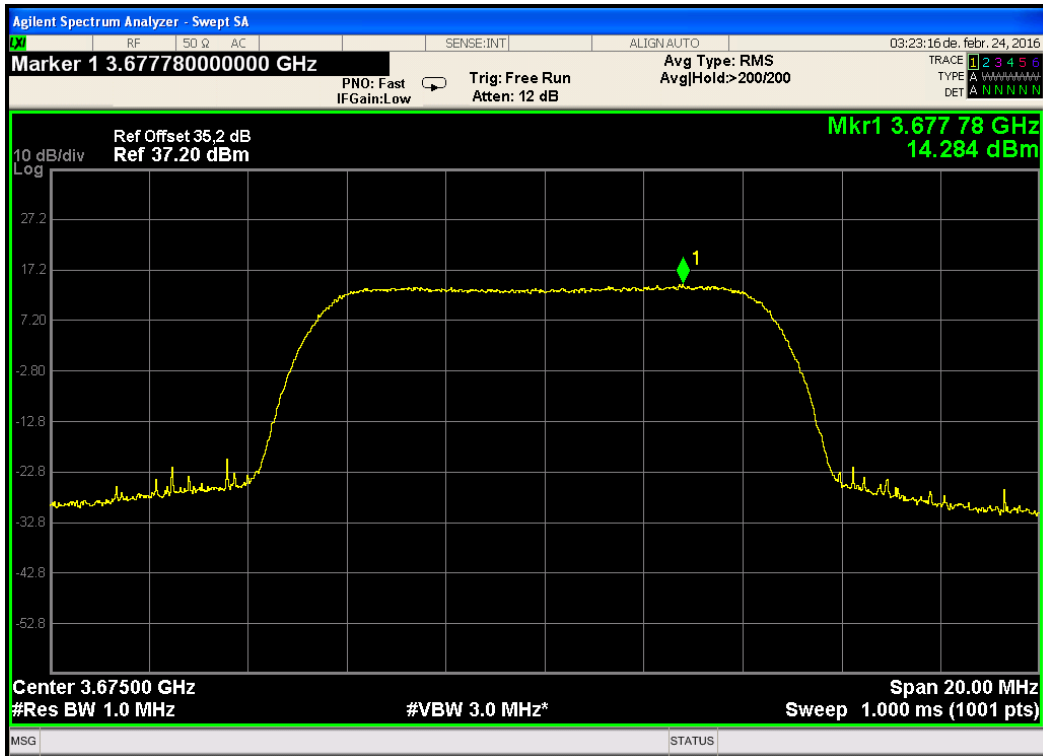

Figure 130. — 3675.0 MHz 64QAM - 10MHz CBW, Low Population

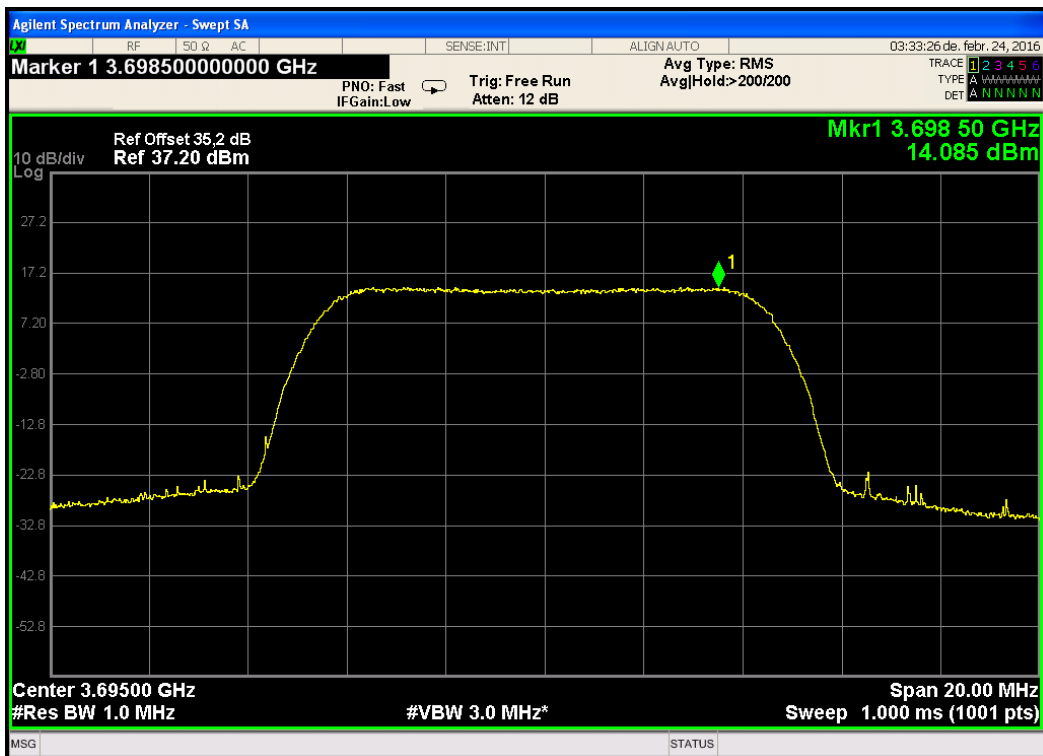

Figure 131. — 3695.0 MHz QPSK - 10MHz CBW, Low Population

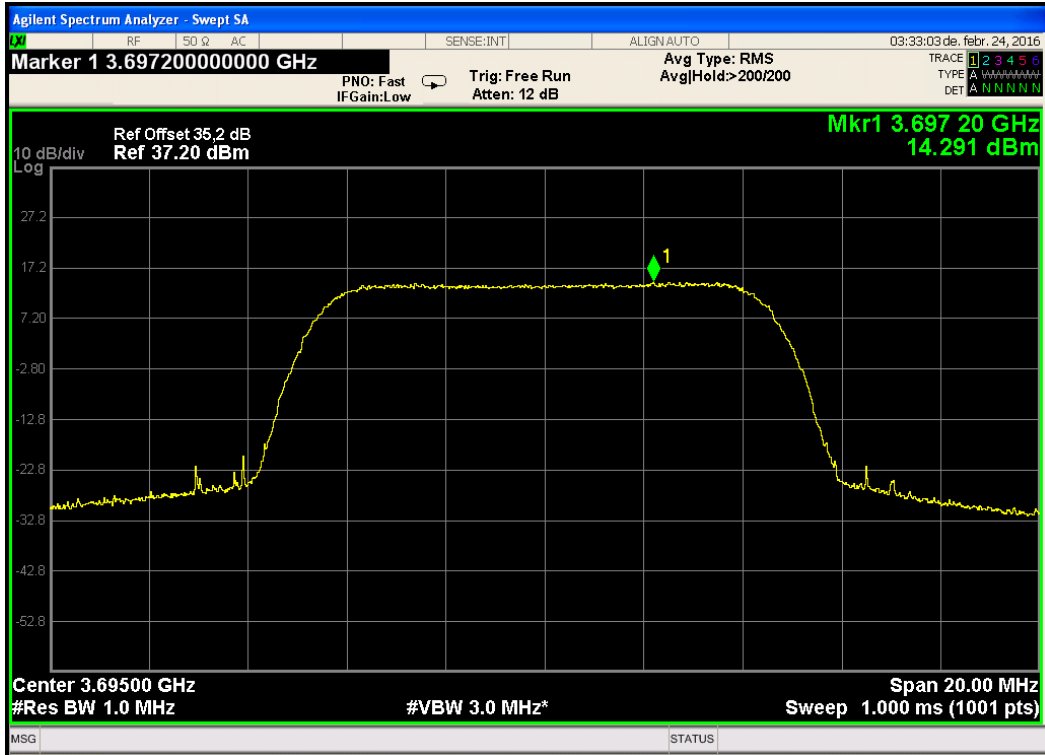

Figure 132. — 3695.0 MHz 16QAM - 10MHz CBW, Low Population

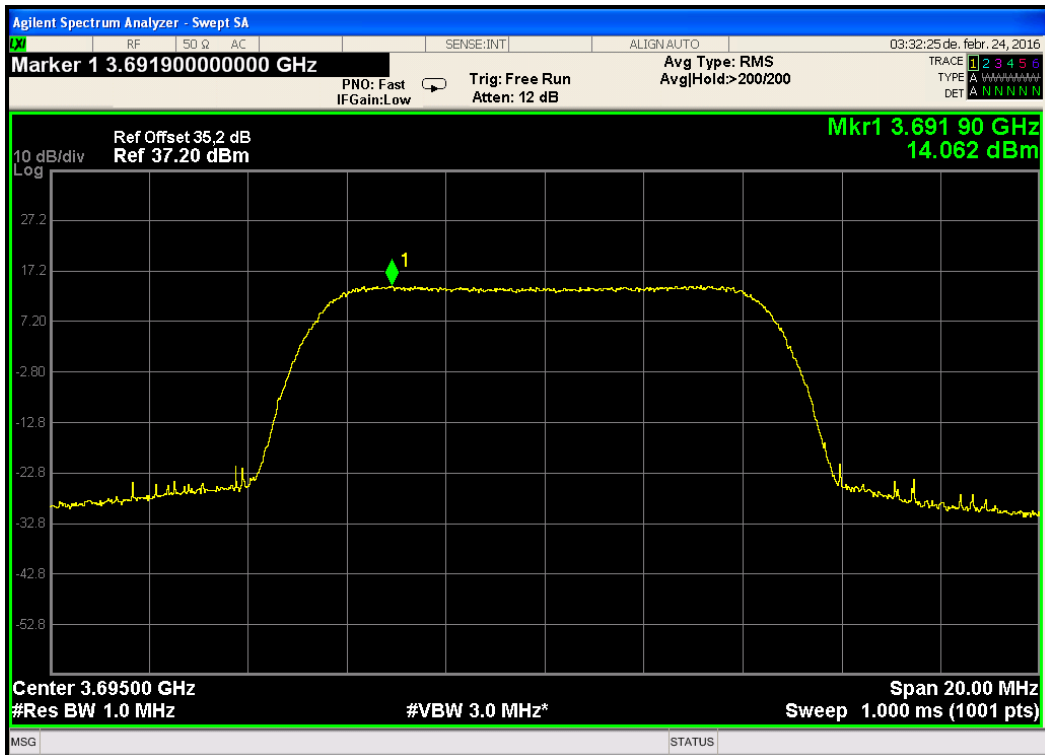

Figure 133. — 3695.0 MHz 64QAM - 10MHz CBW, Low Population

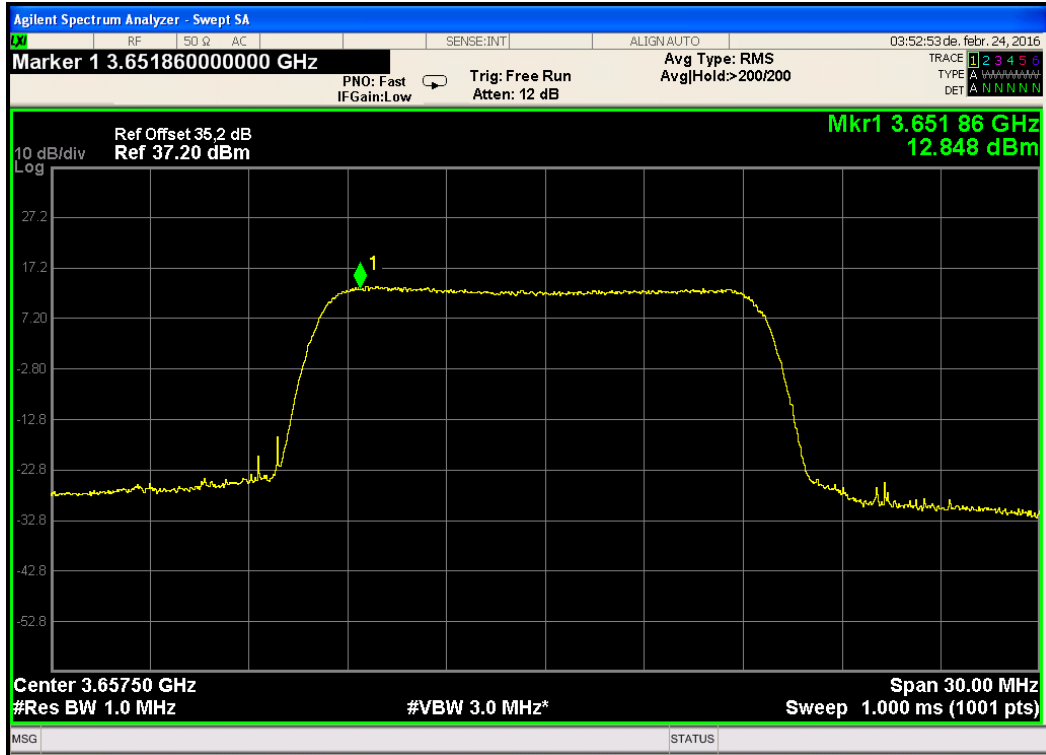

Figure 134. — 3657.5MHz QPSK - 15MHz CBW, Low Population

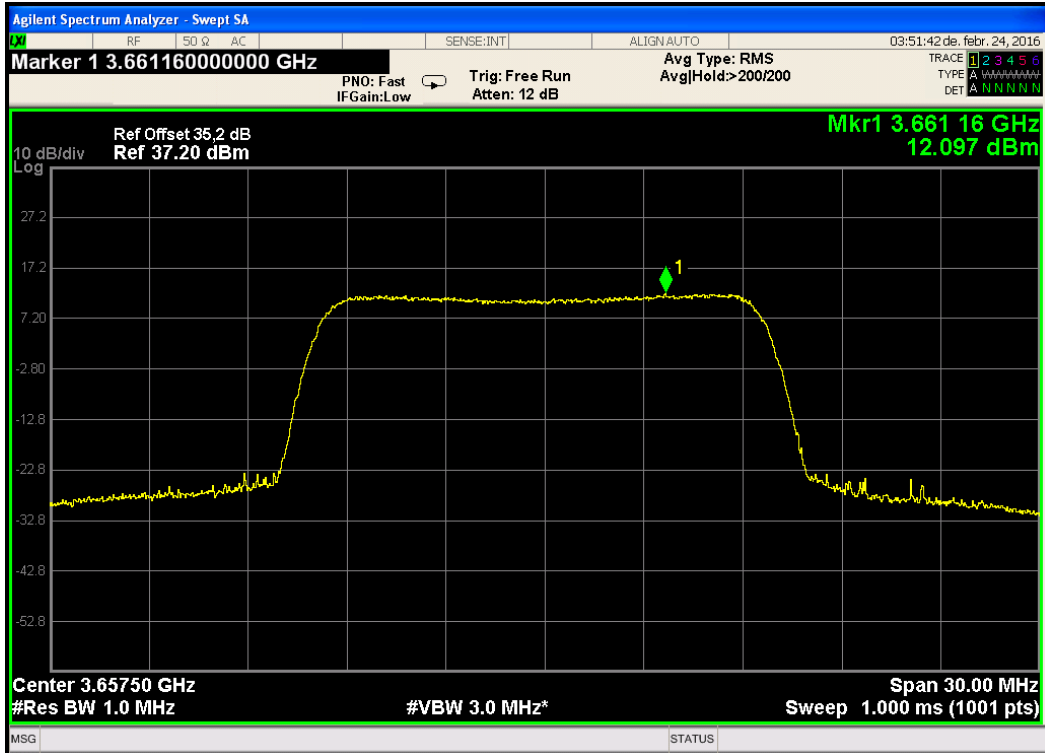

Figure 135. — 3657.5MHz 16QAM - 15MHz CBW, Low Population

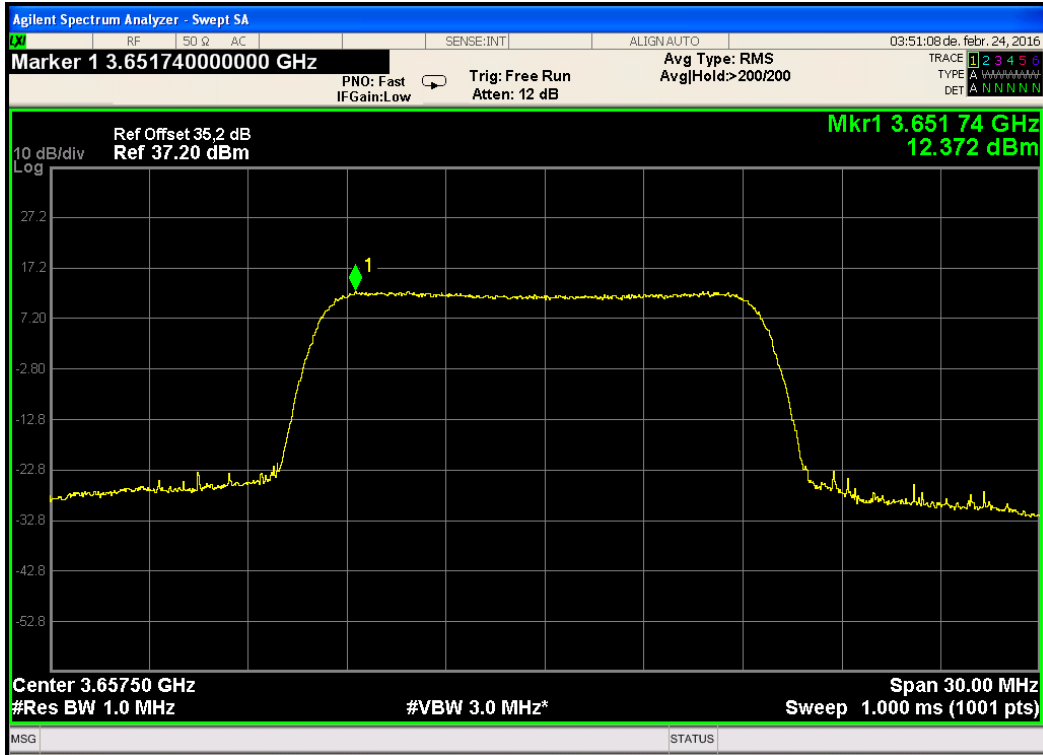

Figure 136. — 3657.5MHz 64QAM - 15MHz CBW, Low Population

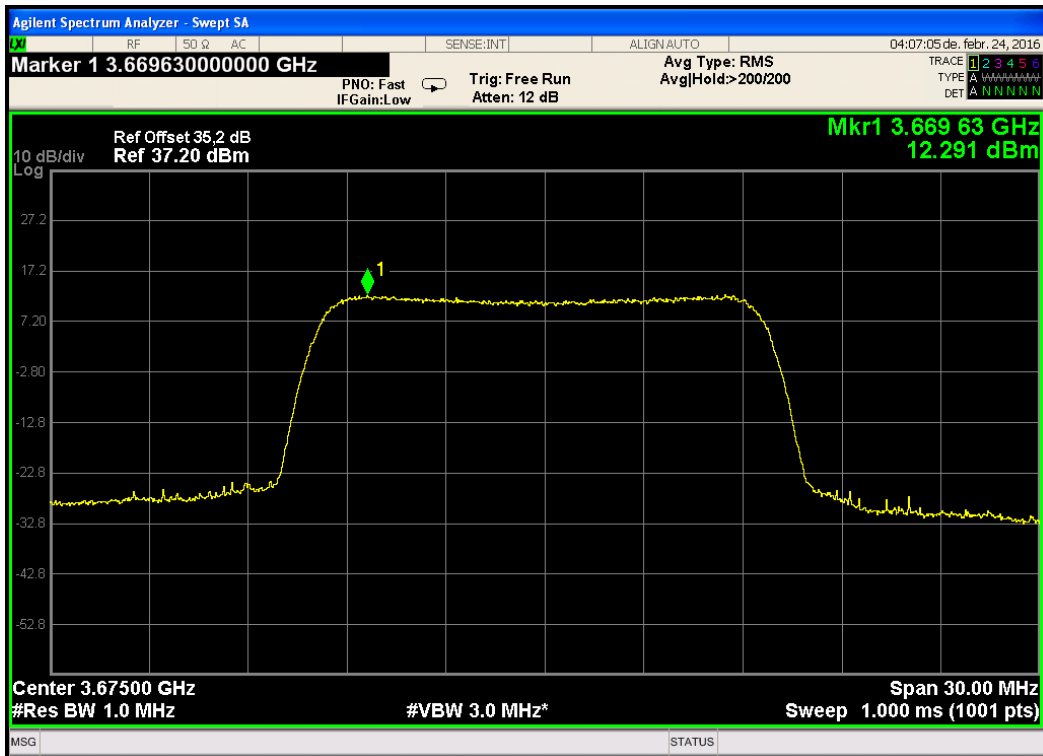

Figure 137. — 3675.0MHz QPSK - 15MHz CBW, Low Population

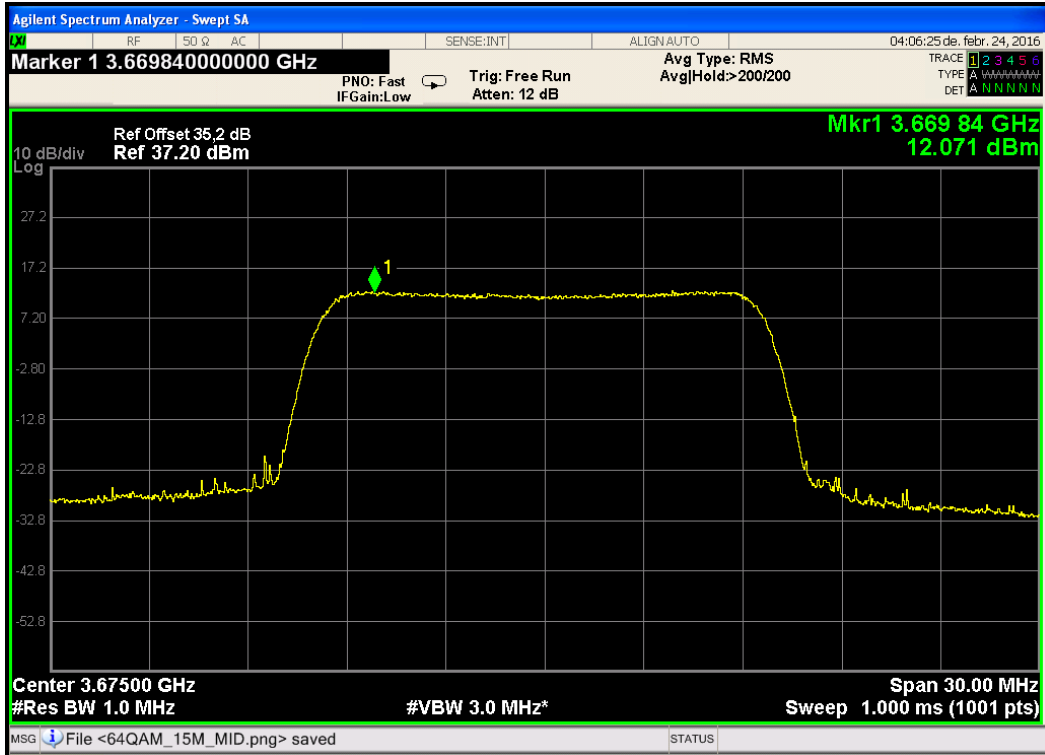

Figure 138. — 3675.0MHz 16QAM - 15MHz CBW, Low Population

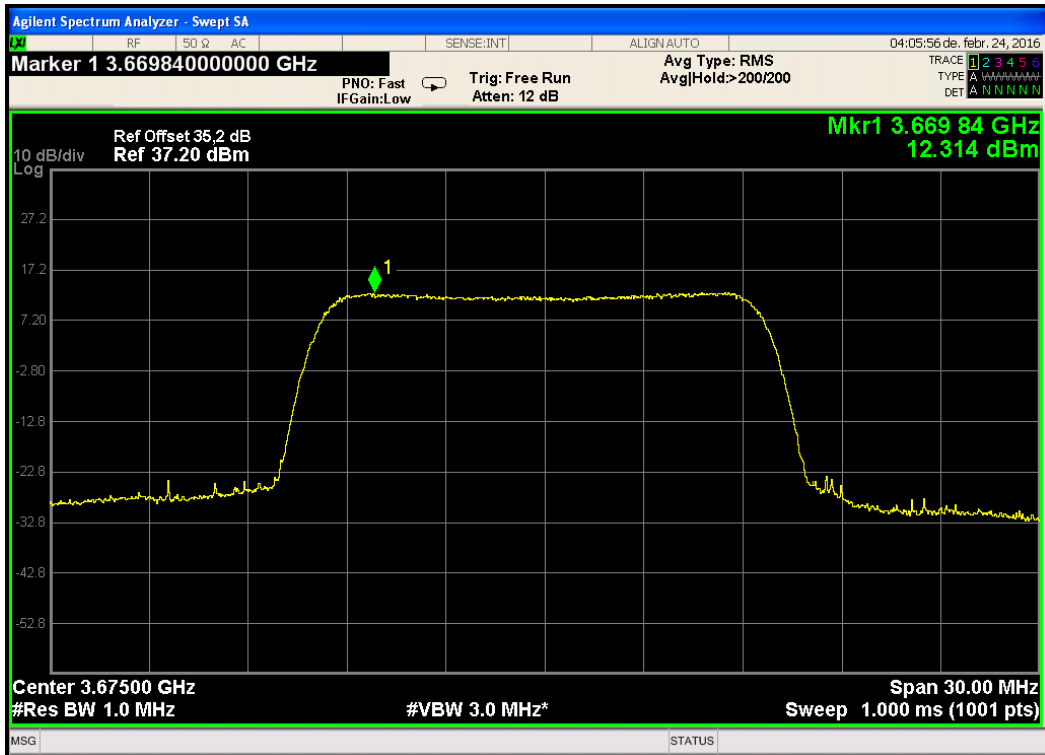

Figure 139. — 3675.0MHz 64QAM - 15MHz CBW, Low Population

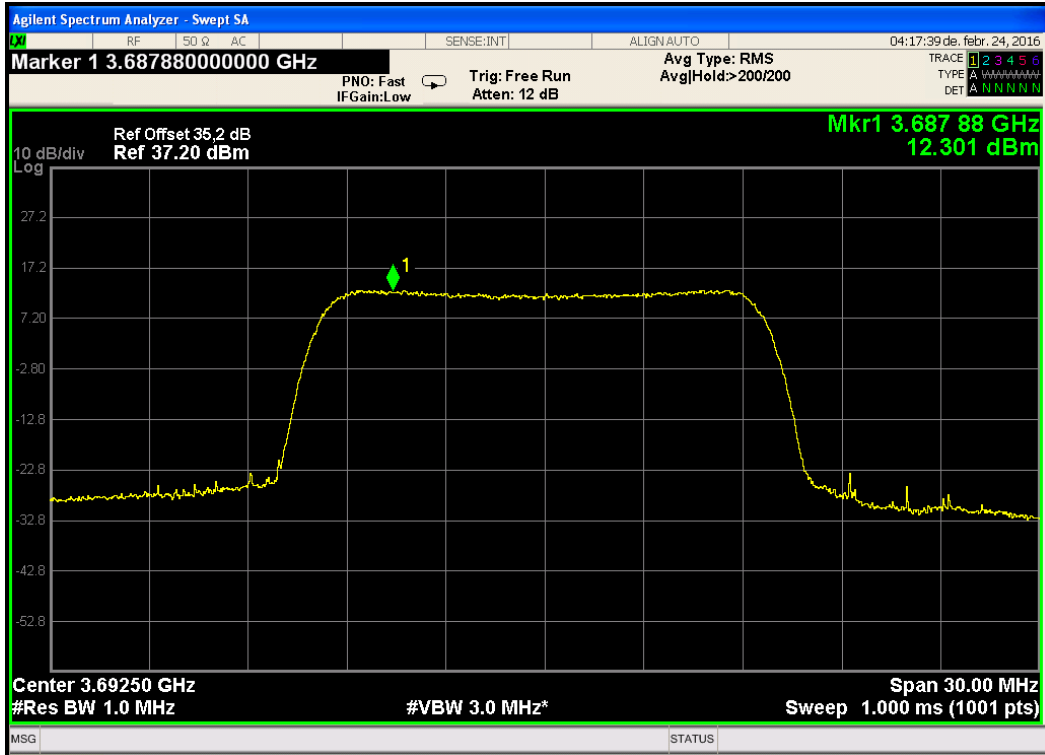

Figure 140. — 3692.5MHz QPSK - 15MHz CBW, Low Population

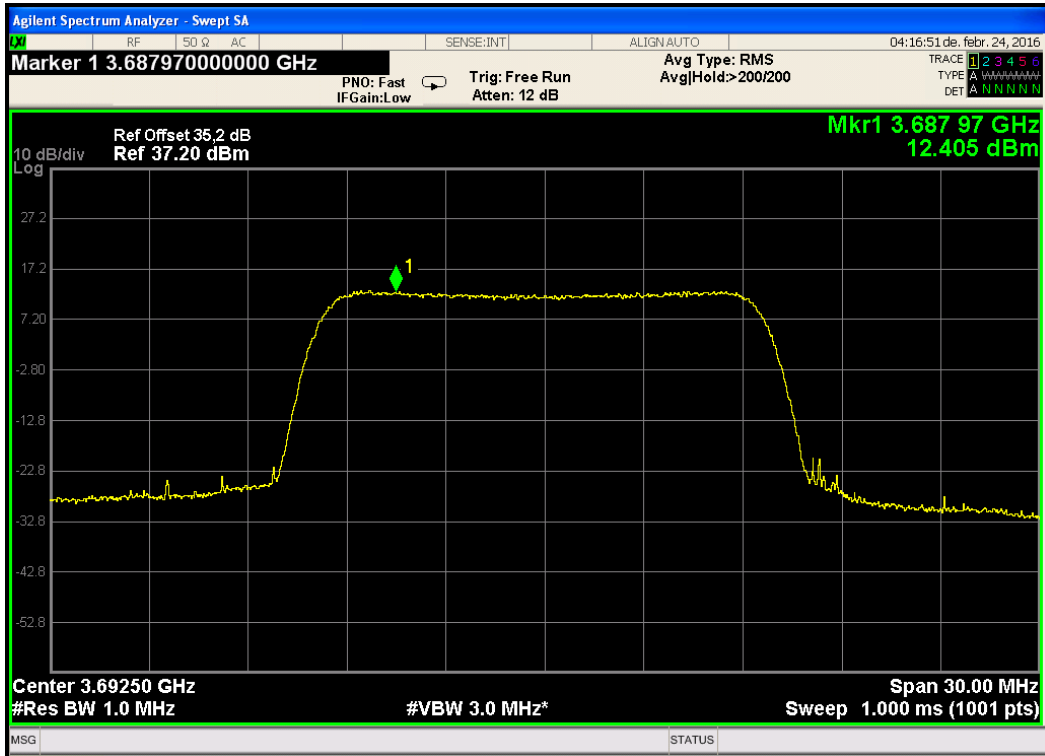

Figure 141. — 3692.5MHz 16QAM - 15MHz CBW, Low Population

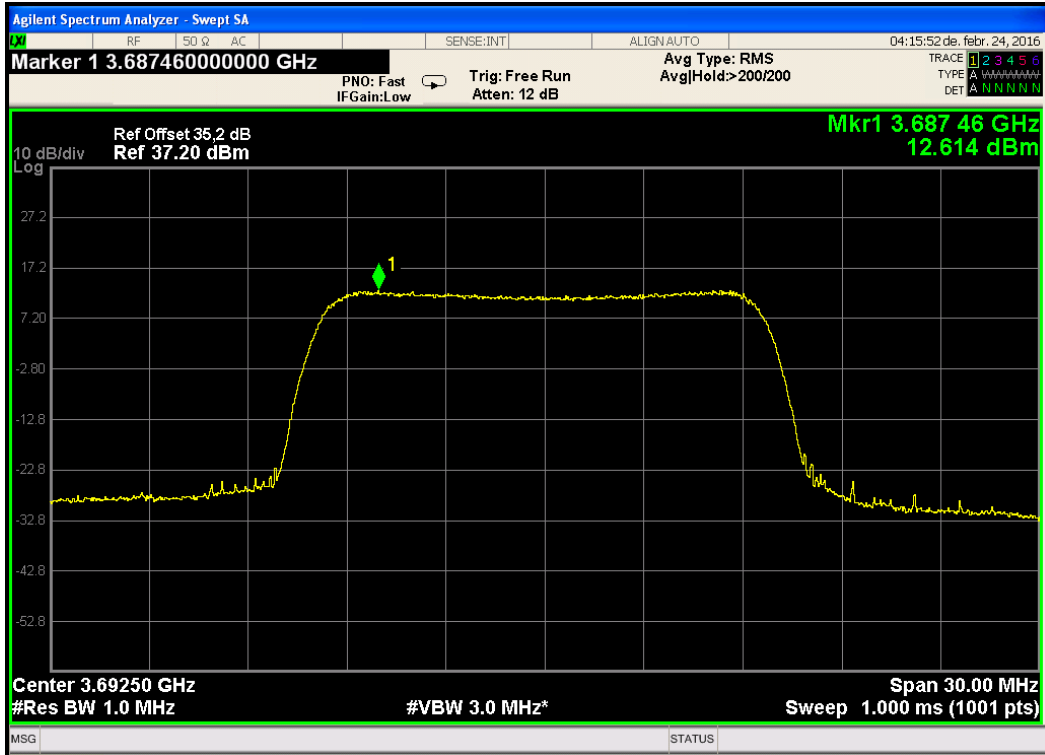

Figure 142. — 3692.5MHz 64QAM - 15MHz CBW, Low Population

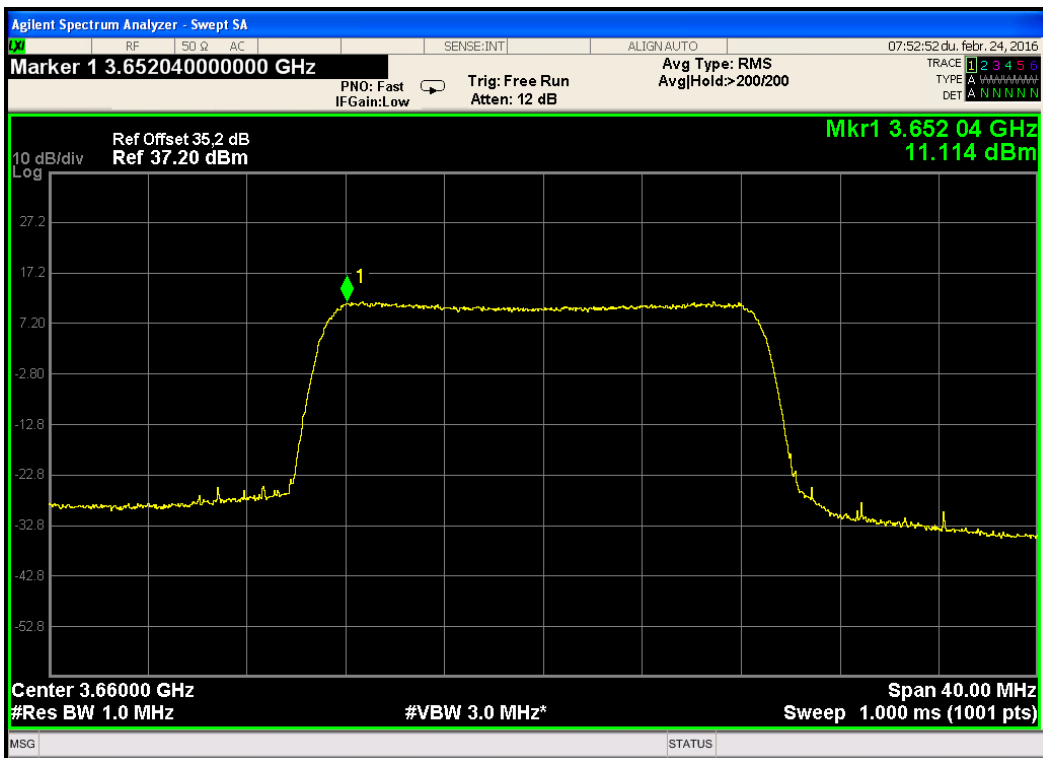

Figure 143. — 3660.0MHz QPSK - 20MHz CBW, Low Population

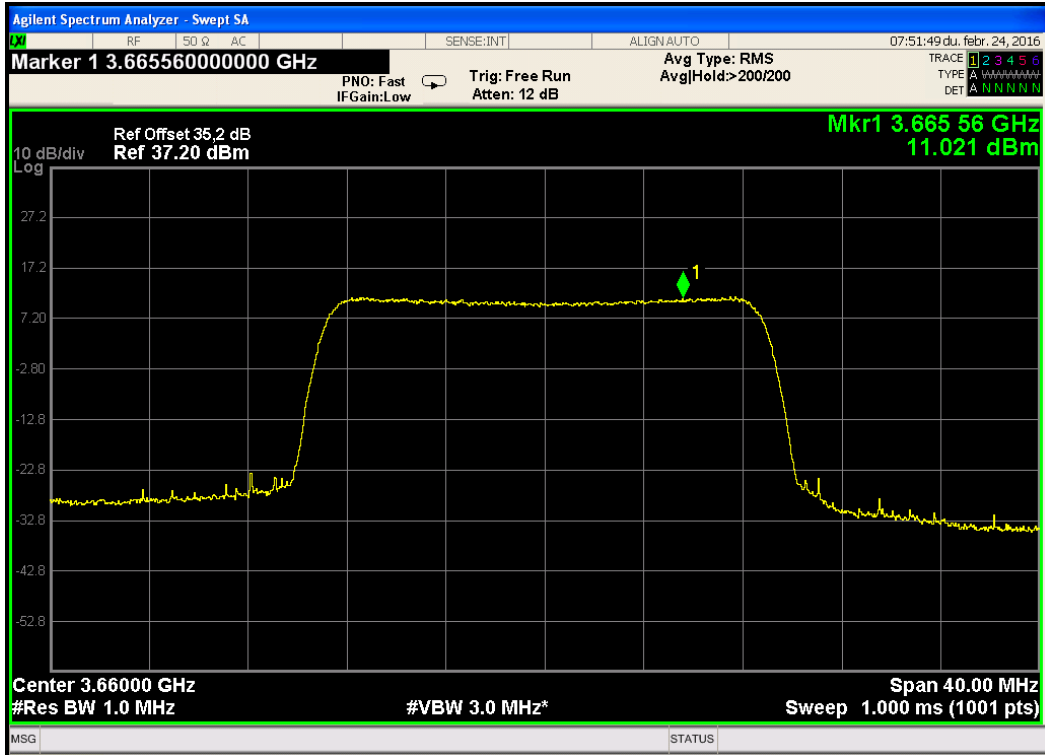

Figure 144. — 3660.0MHz 16QAM - 20MHz CBW, Low Population

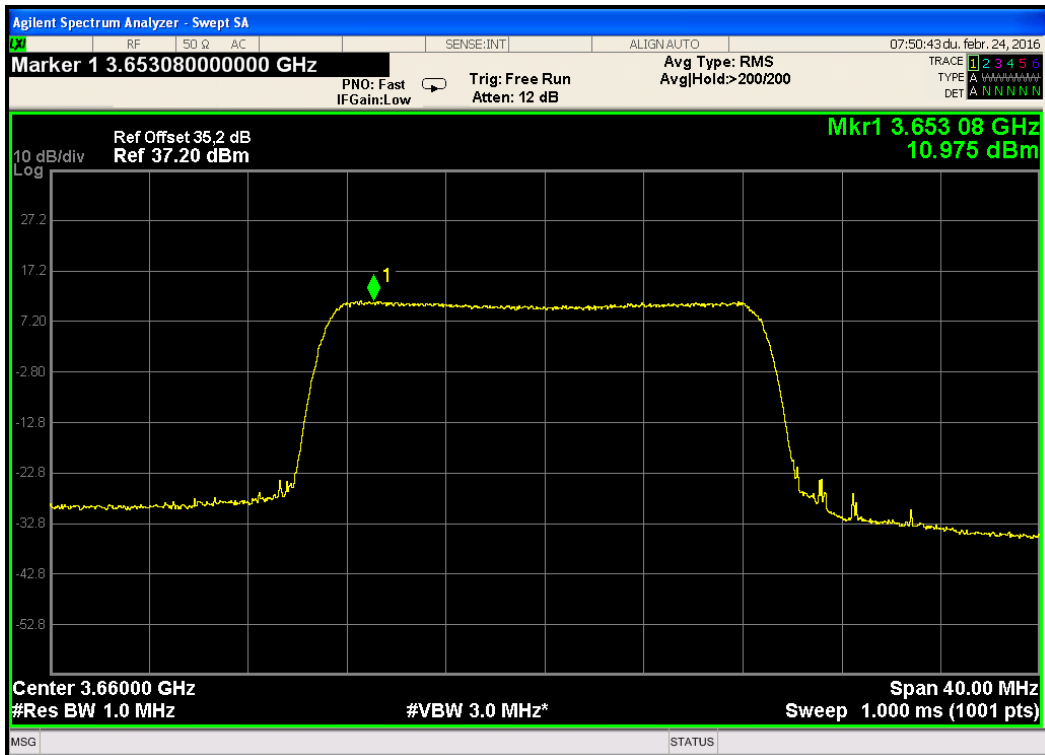

Figure 145. — 3660.0MHz 64QAM - 20MHz CBW, Low Population

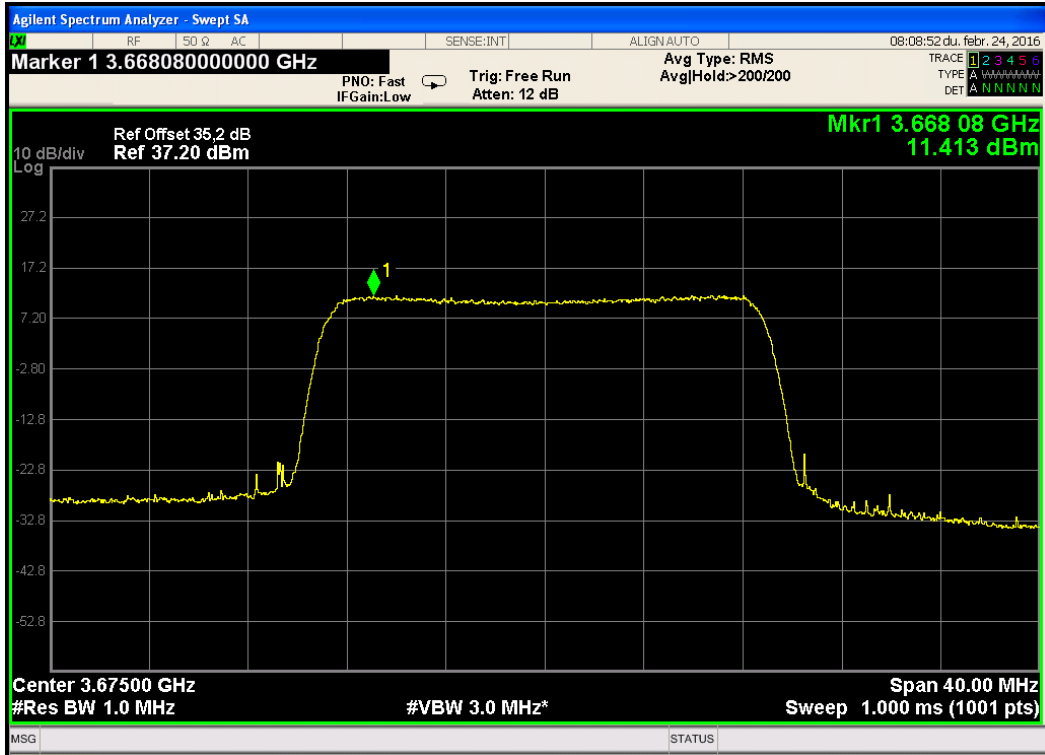

Figure 146. — 3675.0MHz QPSK - 20MHz CBW, Low Population

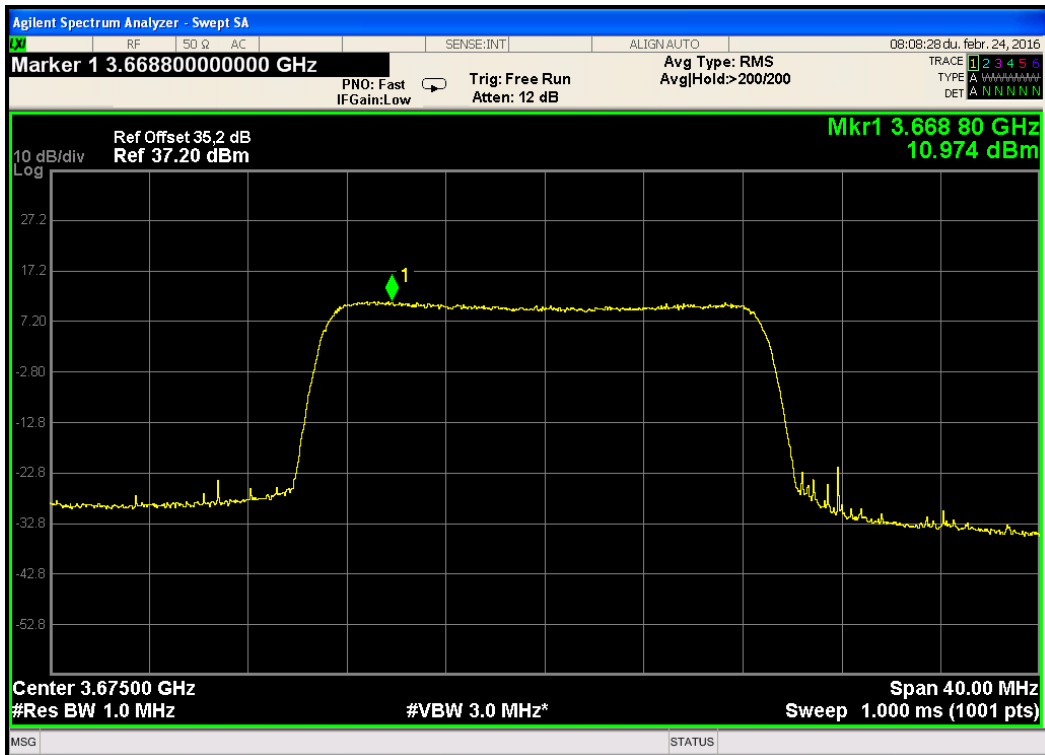

Figure 147. — 3675.0MHz 16QAM - 20MHz CBW, Low Population

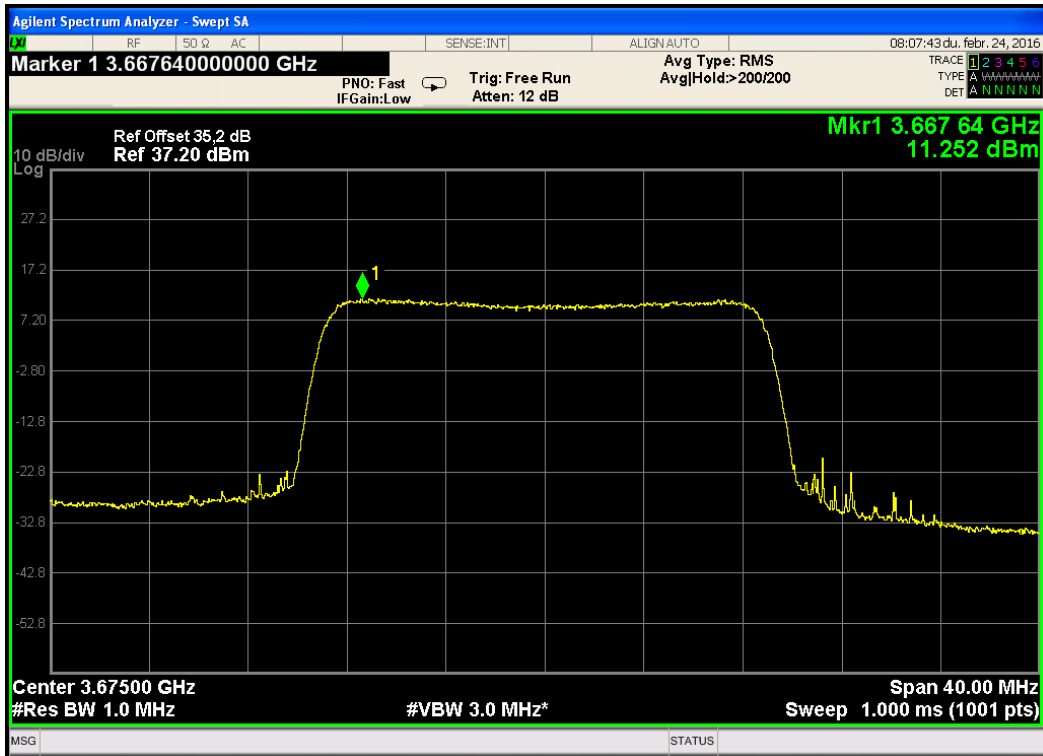

Figure 148. — 3675.0MHz 64QAM - 20MHz CBW, Low Population

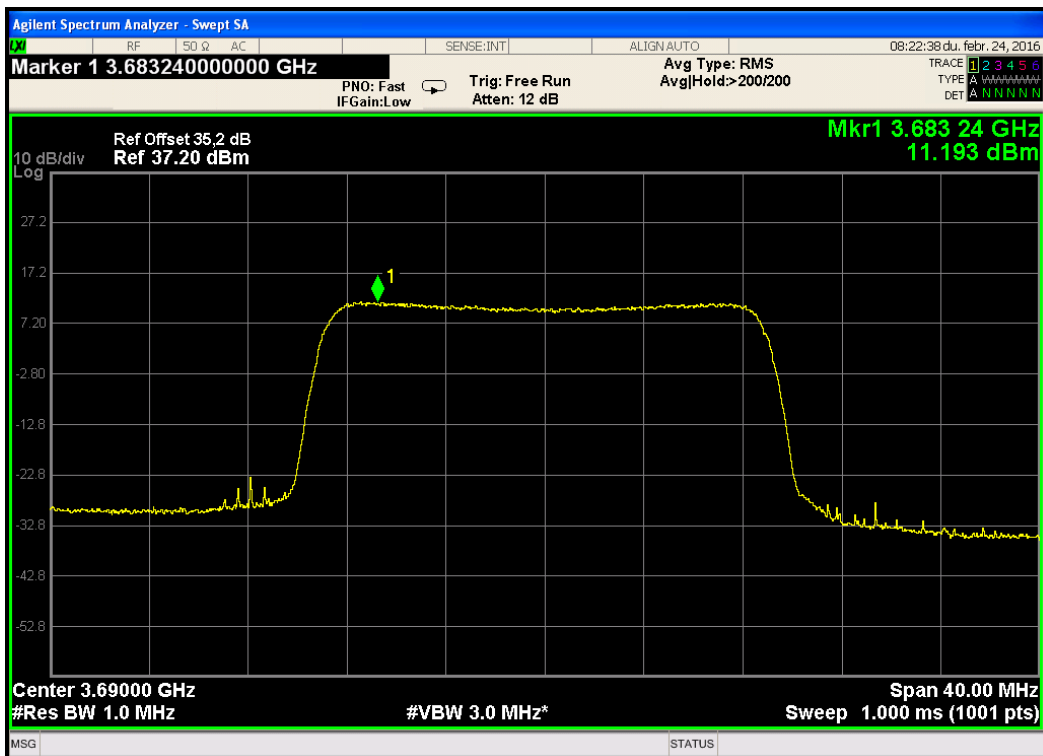

Figure 149. — 3690.0MHz QPSK - 20MHz CBW, Low Population

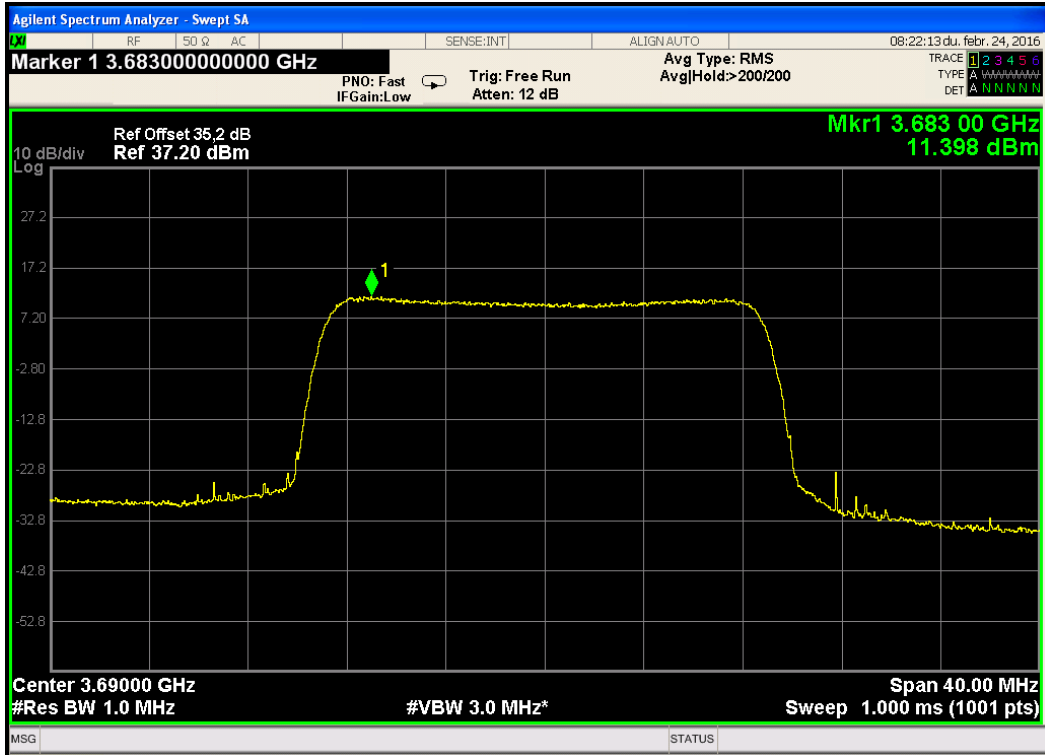

Figure 150. — 3690.0MHz 16QAM - 20MHz CBW, Low Population



Figure 151. — 3690.0MHz 64QAM - 20MHz CBW, Low Population

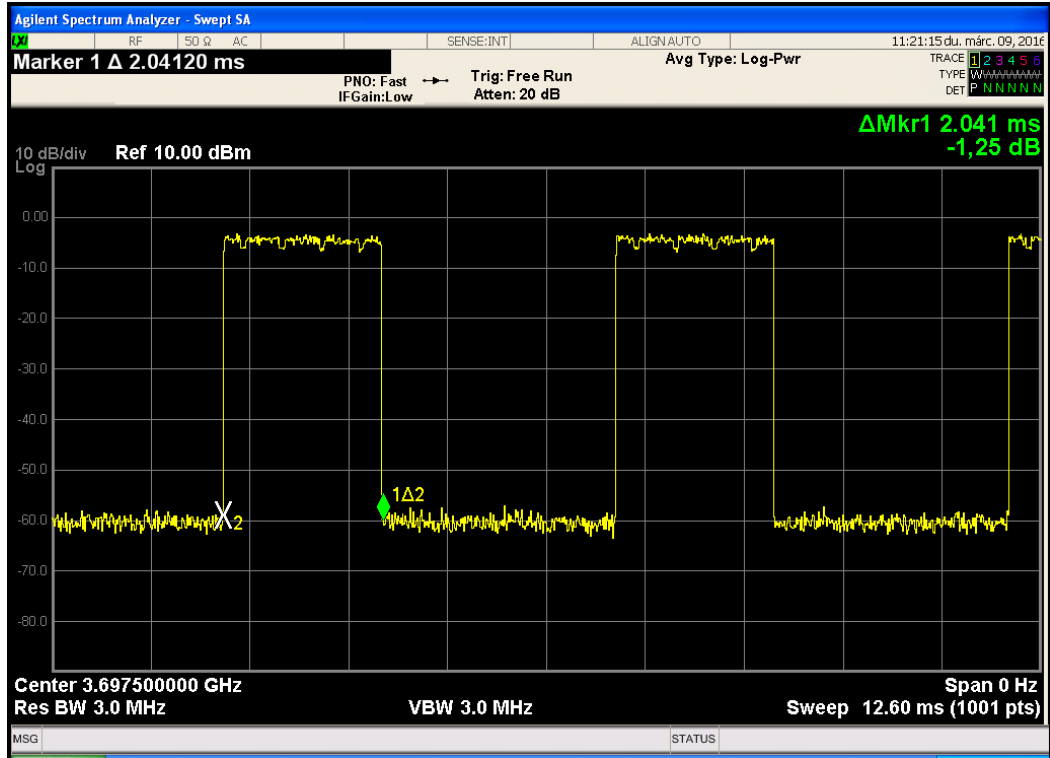

Figure 152. — Time “ON” of Burst

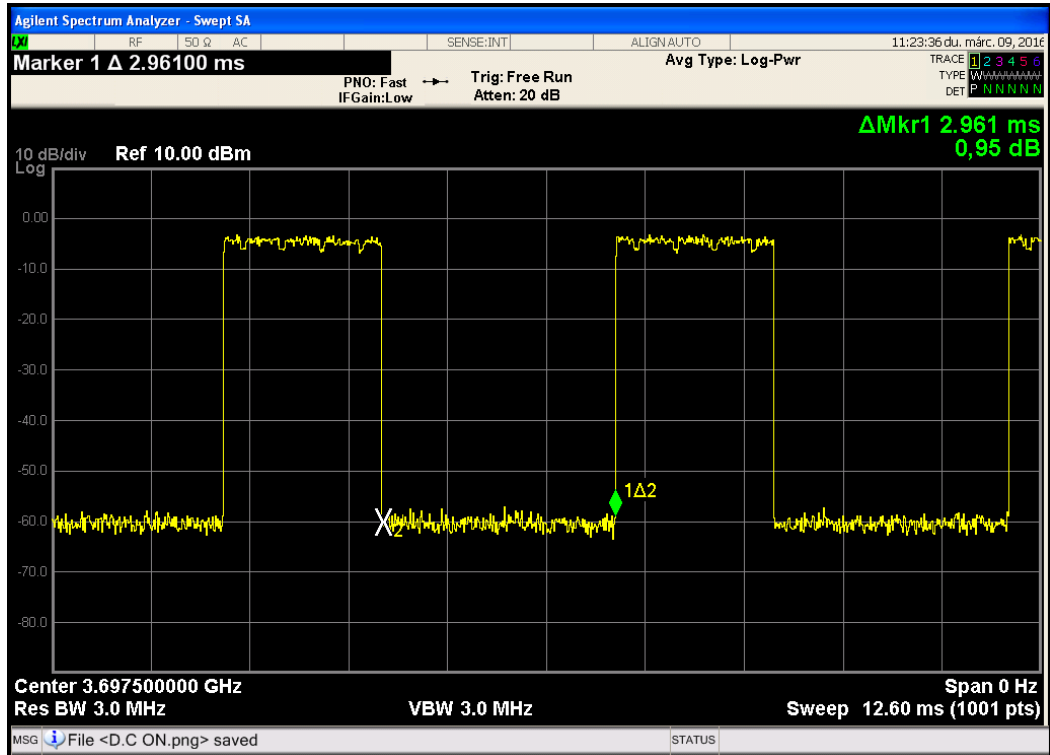

Figure 153. — Time “OFF” of Burst



6.6 Test Equipment Used; Transmitter Output Power and EIRP

Instrument	Manufacturer	Model	Serial Number	Calibration	
				Last Calibration	Next Calibration Due
MXA Signal Analyzer	Agilent	N9020A	MY48011785	July 26 2015	July 26 2017
DC block	JFW	50DB-007	1-23	N/A	N/A
Splitter	Weinschel 93459	1515	NV756	N/A	N/A
Attenuator	MINI- CIRCUITS	MCL BW S10W2+	0728	N/A	N/A
Attenuator	MINI- CIRCUITS	MCL BW S10W2+	6090	N/A	N/A

Figure 154. Test Equipment Used

7. Emission Masks

7.1 Test Specification

FCC Part 90, Subpart I, Section 90.210(b)

7.2 Test Procedure

The E.U.T. antenna terminal was connected to the Spectrum Analyzer through an external attenuator, an appropriate coaxial cable and DC block.

(max total loss= 35.8 dB).

Three operational frequencies (low, mid and high) were evaluated for all BWs (5MHz, 10MHz, 15MHz, 20MHz) for each modulation type (QPSK, 16QAM and 64QAM).

7.3 Limit

For transmitters that are equipped with an audio low-pass filter, the power of any emission must be attenuated below the unmodulated carrier power (P) as follows:

(1) On any frequency removed from the assigned frequency by more than 50 percent, but not more than 100 percent of the authorized bandwidth: At least 25 dB.

(2) On any frequency removed from the assigned frequency by more than 100 percent, but not more than 250 percent of the authorized bandwidth: At least 35 dB.

(3) On any frequency removed from the assigned frequency by more than 250 percent of the authorized bandwidth: At least $43 + 10 \log (P)$ dB.

*NOTE: the emission mask limit was reduced by 10dB to compensate for the RBW.

7.4 Test Results

JUDGEMENT: Passed

For additional information see *Figure 155* to *Figure 190*.

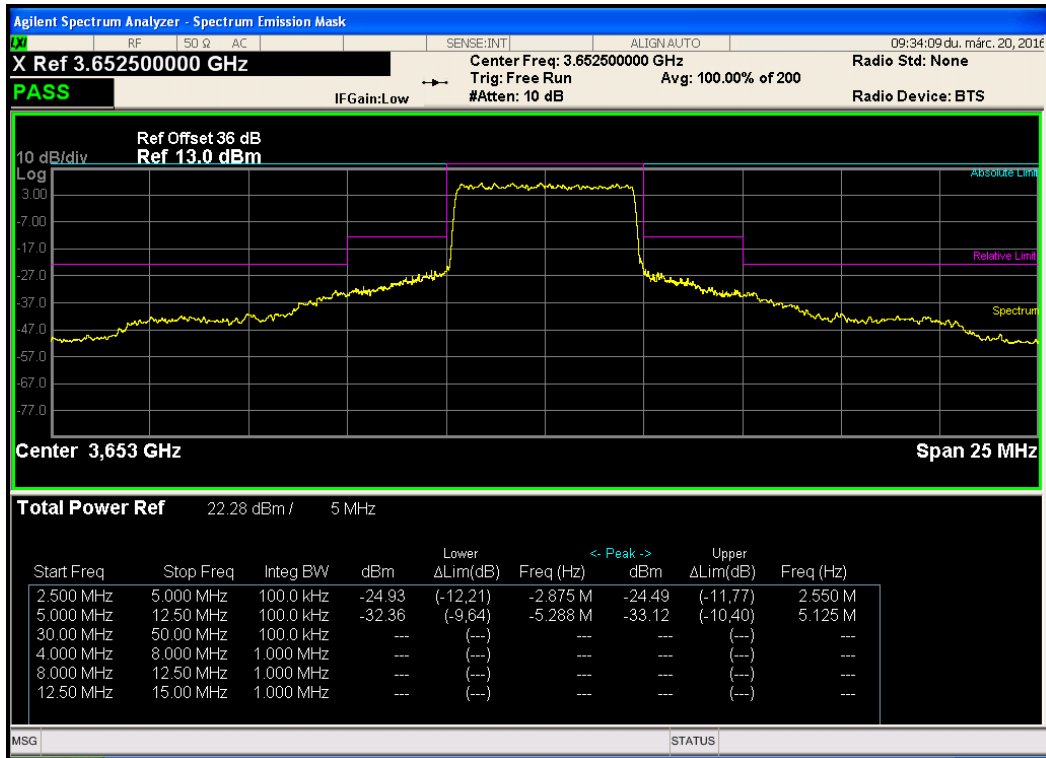

Figure 155. —5MHz CBW – Low Frequency, 64QAM

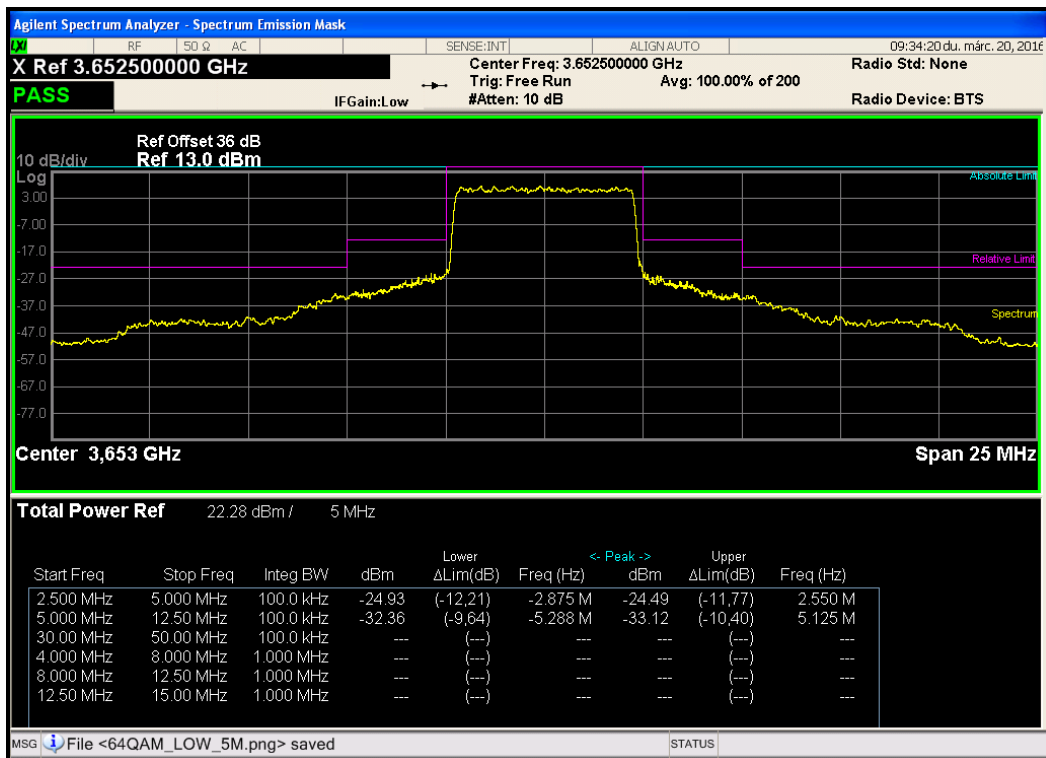

Figure 156. —5MHz CBW – Low Frequency, 16QAM