

Attachment to FCC Form 731

FCC ID: AQZ-MX-9325

Exhibit 6

Test Report

Table of Contents

2.1033 (c)(8) DC voltages and currents into the final amplifier stages 4

 5 watt power level 4

 25 watt power level 4

2.1046 - RF power output 5

 Test Procedure 5

 RF Power Test Data 5

 A2D Emission, 5 watt power level: 5

 A2D Emission, 25 watt power level: 6

 G1D/G7D Emission, 5 watt power level: 6

 G1D/G7D Emission, 25 watt power level: 6

2.1047 - Modulation characteristics 7

2.1049 - Occupied bandwidth 8

 A2D Emission Limits 8

 G1D/G7D Emission Limits 8

 Test Procedure – A2D Emission 8

 A2D Emissions test block diagram 9

 A2D Occupied Bandwidth Test Data 9

 A2D Emission, 5 Watts 2400 Hz modulation 90% AM average 9

 A2D Emission, 5 Watts random data 90% AM average 10

 A2D Emission, 5 Watts random data 90% AM peak hold 11

 A2D Emission, 25 Watts 2400 Hz modulation 90% AM average 12

 A2D Emission, 25 Watts random data 90% AM average 13

 A2D Emission, 25 Watts random data 90% AM peak hold 14

 Test Procedure – G1D and G7D Emissions 15

 G1D/G7D Emissions Test set-up – Occupied Bandwidth and 1st Adjacent
 channel power 15

1 st Adjacent Channel Test	16
2 nd through 8 th Adjacent Channel Test.....	16
G1D/G7D Emissions Test Set-up – 2 nd through 8 th Adjacent channel power	17
8 th Channel and Beyond Test.....	17
G1D/G7D Emissions Test set-up – 8 th channel and greater ACP.....	18
G1D/G7D Occupied Bandwidth Test Data	19
G1D/G7D Emission, 127.5 MHz, 25 W (87.139(a) limits)	19
G1D/G7D Emission, 127.5 MHz, 5 W (87.139(a) limits)	19
G1D/G7D Adjacent Channel Power – Tabular Data	20
1 st Adjacent Channel Power in 16 KHz Bandwidth, 25 Watts.....	20
1 st Adjacent Channel Power in 25 KHz Bandwidth, 25 watts	20
2 nd through 128 th Channel Power at 118 MHz, 25 watts	20
G1D/G7D 1 st Adjacent Channel Power Plots.....	21
Burst Power Measurement Display	21
127.5 MHz On-channel Power	22
127.5 MHz Upper 1 st Adjacent Channel, 16 KHz bandwidth.....	22
127.5 MHz Lower 1 st Adjacent Channel, 16 KHz bandwidth.....	23
127.5 MHz Upper 1 st Adjacent Channel, 25 KHz bandwidth.....	23
127.5 MHz Lower 1 st Adjacent Channel, 25 KHz bandwidth.....	24
136.975 MHz On-channel	24
136.975 MHz Upper 1 st Adjacent Channel, 16 KHz bandwidth	25
136.975 MHz Lower 1 st Adjacent Channel, 16 KHz bandwidth	25
136.975 MHz Upper 1 st Adjacent Channel, 25 KHz bandwidth	26
136.975 MHz Lower 1 st Adjacent Channel, 25 KHz bandwidth	26
118.00 MHz On-channel	27
118.00 MHz Upper 1 st Adjacent Channel, 16 KHz bandwidth	27
118.00 MHz Lower 1 st Adjacent Channel, 16 KHz bandwidth	28
118.00 MHz Upper 1 st Adjacent Channel, 25 KHz bandwidth	28
118.00 MHz Lower 1 st Adjacent Channel, 25 KHz bandwidth	29
2 nd through 128 th Channel ACP Plots using Crystal Filter	30
118 MHz 2 nd Adjacent Channel (Fo=118.05 MHz).....	30

118 MHz 4th Adjacent Channel (Fo=118.10 MHz)	30
118 MHz 8 th Adjacent Channel (Fo=118.20 MHz)	31
118 MHz 16 th Adjacent Channel (Fo=118.40 MHz)	31
118 MHz 32 nd Adjacent Channel (Fo=118.80 MHz).....	32
118 MHz 64 th Adjacent Channel (Fo=119.6 MHz)	32
118 MHz 128 th Adjacent Channel (Fo=121.2 MHz)	33
118 MHz ACP, wideband with notch, peak hold.....	33
2.1051 - Spurious Emissions at Antenna Terminals.....	34
Test Set-up.....	34
Test Procedure	34
Spurious Emissions Test Data.....	36
Plot of Spurious at Antenna Port, 0 to 2000 MHz, Fo = 127.5 MHz, 25 Watts	36
127.5 MHz harmonic data.....	36
Plot of Spurious at Antenna Port, 0 to 2000 MHz, Fo = 118 MHz, 25 watts.	37
118 MHz harmonic data.....	37
Plot of Spurious at Antenna Port, 0 to 2000 MHz, Fo = 136.975 MHz, 25 watts	38
136.975 MHz harmonic data	38
Close-in Spurious Emissions, 127.5 MHz, 25 watts.....	39
Close-in Spurious Emissions, 118 MHz, 25 watts	40
Close-in Spurious Emissions, 136.975 MHz, 25 watts.....	41
2.1053 - Field Strength of Spurious Radiation	42
2.1055 - Frequency Stability	42
Test Procedure	42
Test setup for frequency stability measurements	42
Frequency Stability Test Data.....	43
2.1057 - Frequency Spectrum to be Investigated.....	43
List of Test Equipment Used	44

2.1033 (c)(8) DC voltages and currents into the final amplifier stages

Refer to Exhibit 4, Block Diagrams (filenames exblkdia.PDF and pa_block.PDF), and Exhibit 5, Schematic Diagrams (filenames exciter.PDF, pa.PDF and lpf.PDF) for the block diagrams and schematic diagrams of the Exciter and Power Amplifier PWB assemblies.

A summary of the DC power input to the transmit amplifier devices (at 5 and 25 watt output levels) is as follows:

5 watt power level

<u>Device</u>	<u>Supply Volts DC</u>	<u>Current mA DC</u>	<u>Power input (W)</u>	<u>Emission mode</u>
Exciter Q10	28	200	5.6	all
PA Q1	28	900	25.2	all
PA Q2	28	1570	43.96	A2D
PA Q2	28	3000	84.00	G1D/G7D

25 watt power level

<u>Device</u>	<u>Supply Volts DC</u>	<u>Current mA DC</u>	<u>Power input (W)</u>	<u>Emission mode</u>
Exciter Q10	28	200	5.6	all
PA Q1	28	900	25.2	all
PA Q2	28	3180	89.04	A2D
PA Q2	28	4050	113.4	G1D/G7D

It should be noted that all devices are operated as Class A amplifiers.

2.1046 - RF power output

Test Procedure

For the A2D emission mode, the RF power output measurement was made with the unit operating from its nominal AC input line voltage, using an internally generated test signal. This test signal consisted of the RF carrier amplitude modulated to a depth of 50% by a 2400 Hz tone. Power output was measured at a center frequency of 127.500 MHz and at the 5 watt and 25 watt power levels, with the results being recorded. Power output was also measured with the transmitter operating at AC line voltages of ± 15 percent from nominal, and the results recorded.

For the G1D and G7D emissions, power was measured using an internally generated test message approximately 28 msec in length, sent at intervals of one second. This test message consisted of the first 28 msec of a sample VDL data transmission described in Appendix F, RTCA paper no 155-00/SC172-263 (final draft Draft of RTCA specification DO-224A). The resulting emission was measured with a vector signal analyzer set to measure power over the entire burst. The analyzer display was averaged over 10 trigger events before readings were taken. As in the case of the A2D data, the power output was measured at nominal AC line voltage, and at values of AC input representing the extremes of the equipment specification, and the results recorded.

RF Power Test Data

The RF power output test data is as follows:

A2D Emission, 5 watt power level:

<u>Input voltage, AC</u>	<u>Power output, watts</u>
97.75	4.79
115	4.80
132.25	4.79
195.5	4.79
230	4.79
264.5	4.79

A2D Emission, 25 watt power level:

<u>Input voltage, AC</u>	<u>Power output, watts</u>
97.75	26.0
115	26.0
132.25	26.0
195.5	26.0
230	26.0
264.5	26.0

G1D/G7D Emission, 5 watt power level:

<u>Input voltage, AC</u>	<u>Power output, dBm</u>	<u>Power output, watts</u>
97.75	36.6	4.6
115	36.6	4.6
132.25	36.6	4.6
195.5	36.6	4.6
230	36.6	4.6
264.5	36.9	4.9

G1D/G7D Emission, 25 watt power level:

<u>Input voltage, AC</u>	<u>Power output, dBm</u>	<u>Power output, watts</u>
97.75	43.7	23.4
115	43.7	23.4
132.25	43.7	23.4
195.5	43.7	23.4
230	43.7	23.4
264.5	43.7	23.4

2.1047 - Modulation characteristics

In order to understand the modulation characteristics of this transmitter please refer to Exhibit 12, Operational Description, for technical discussion of information for 2.1033 (c)(10) (modulation limiting) and 2.1033 (c)(13) (description of digital modulation system).

The 5 section baseband filter referred to in the discussion under 2.1033 (c)(13) is the last filter before the modulated stage. Its function is to prevent unwanted modulation of the carrier by spurious sources (“digital noise”) outside of the authorized bandwidth. This filter is common to all emission modes.

The frequency response characteristics of this filter is shown in the following plot.

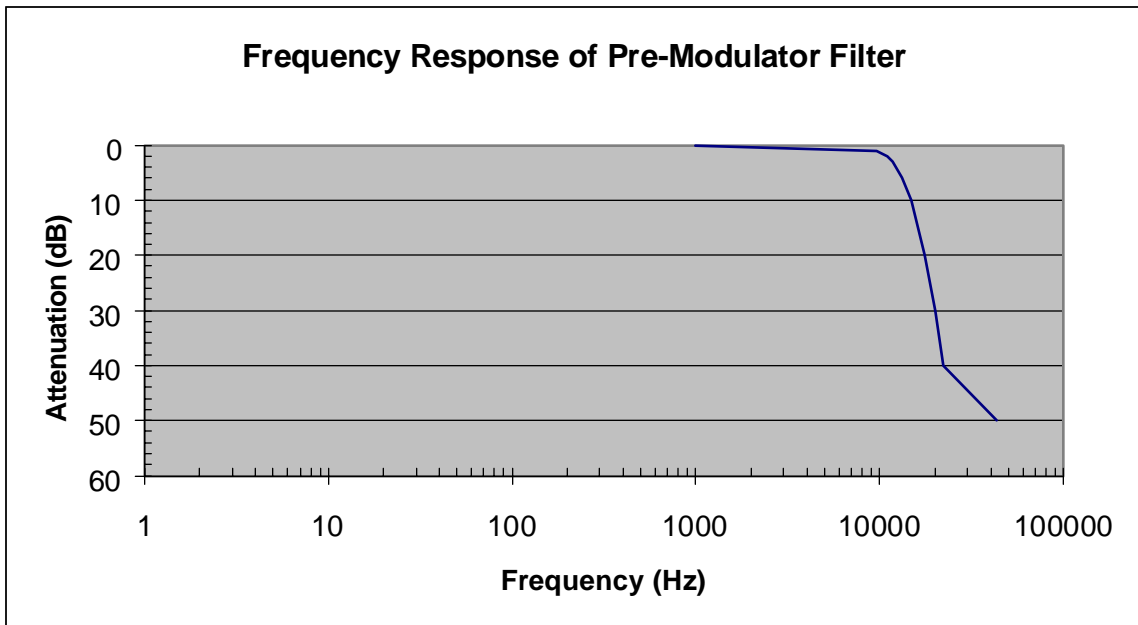

2.1049 - Occupied bandwidth

A2D Emission Limits

The A2D emission must meet the requirements set forth in § 87.139(a), which for an authorized bandwidth of 25 KHz are as follows:

0 to 12.5 KHz from center – no attenuation

12.5 to 25.0 KHz from center – 25 dB attenuation below carrier

25 to 62.5 KHz from center – 35 dB attenuation below carrier

beyond 62.5 KHz from center – 57 dB attenuation below carrier

G1D/G7D Emission Limits

For the G1D and G7D emission modes, there is currently no provision for emission limits other than § 87.139(a). However, since the intended use of these modes is for VHF digital data link (VDL) service, there are proposed limits such as are described in the “Minimum Operational Performance Specification For An Airborne VDL Mode 2 Transceiver Operating in the Frequency Range 118-136.975 MHz”, March 2000 EUROCAE specification. Other organizations such as the International Civil Aviation Organization (ICAO) have similar proposed specifications for both Mode 2 and 3.

In VDL service occupied bandwidth is actually specified as adjacent channel power, or ACP. With the transmitter producing the rated average power of + 44 dBm, the EUROCAE MOPS ACP limits are as follows:

1st adjacent channel, 25 KHz from center frequency: -18 dBm *

2nd adjacent channel, 50 KHz from center frequency: -28 dBm

4th adjacent channel, 100 KHz from center frequency: -38 dBm

8th adjacent channel, 200 KHz from center frequency: -43 dBm

16th adjacent channel, 400 KHz from center frequency: -48 dBm

32nd adjacent channel, 800 KHz from center frequency: -53 dBm

beyond 32nd adjacent channel: -53 dBm

* **NOTE:** The 1st adjacent channel power is measured in a 16 KHz bandwidth, all others are measured in a 25 KHz bandwidth.

Test Procedure – A2D Emission

For A2D occupied bandwidth measurements two test signals were chosen – a 2400 Hz audio tone, and random AM-MSK data. Since there is no external audio input to the transceiver, both of these signals were generated internally within the transceiver and are actually part of the standard product configuration. These test signals were chosen because they represent the worst-case modulation conditions.

For each test signal the modulation level was set at maximum (90%) and data taken at power levels of 5 and 25 watts. Plots of the resulting emission were made using both video averaging and peak hold to capture the worst-case modulation products that might show up randomly.

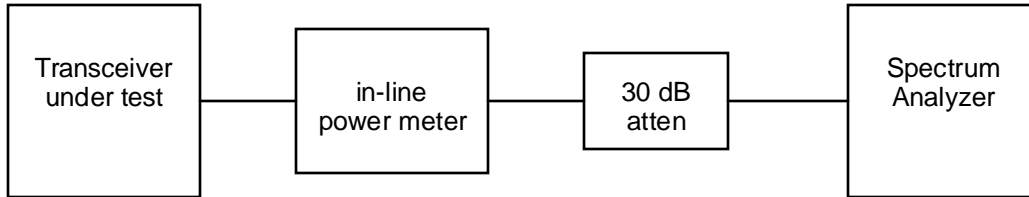

A2D Emissions test block diagram

A2D Occupied Bandwidth Test Data

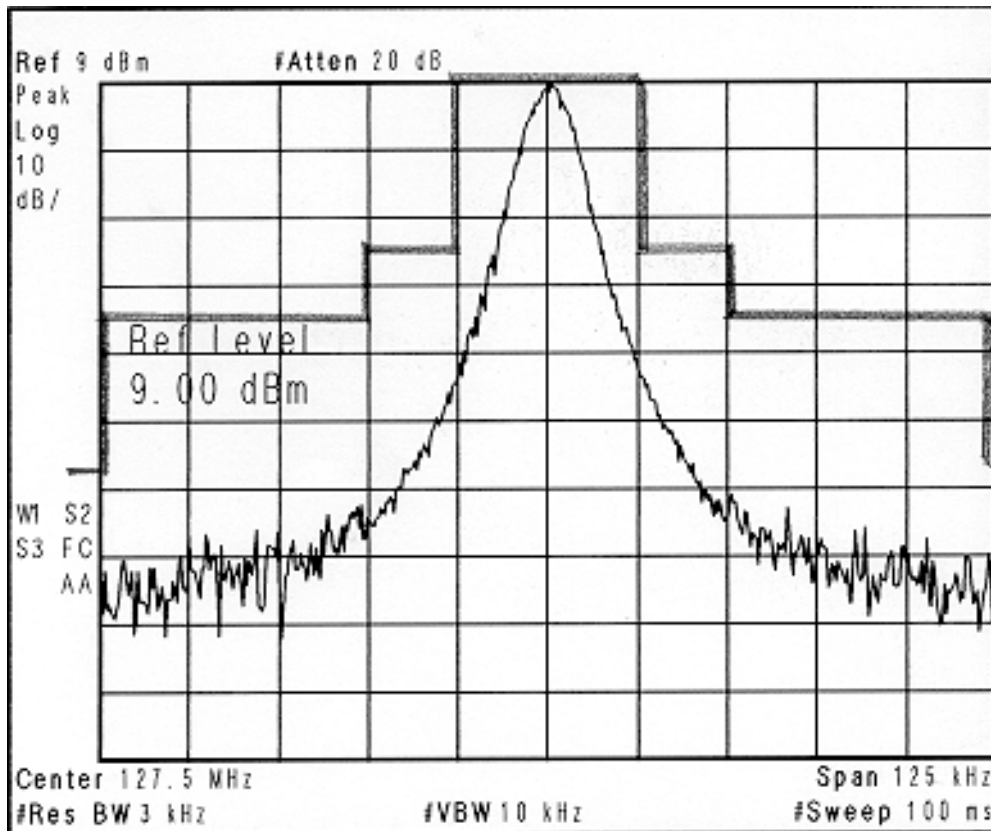

A2D Emission, 5 Watts 2400 Hz modulation 90% AM average

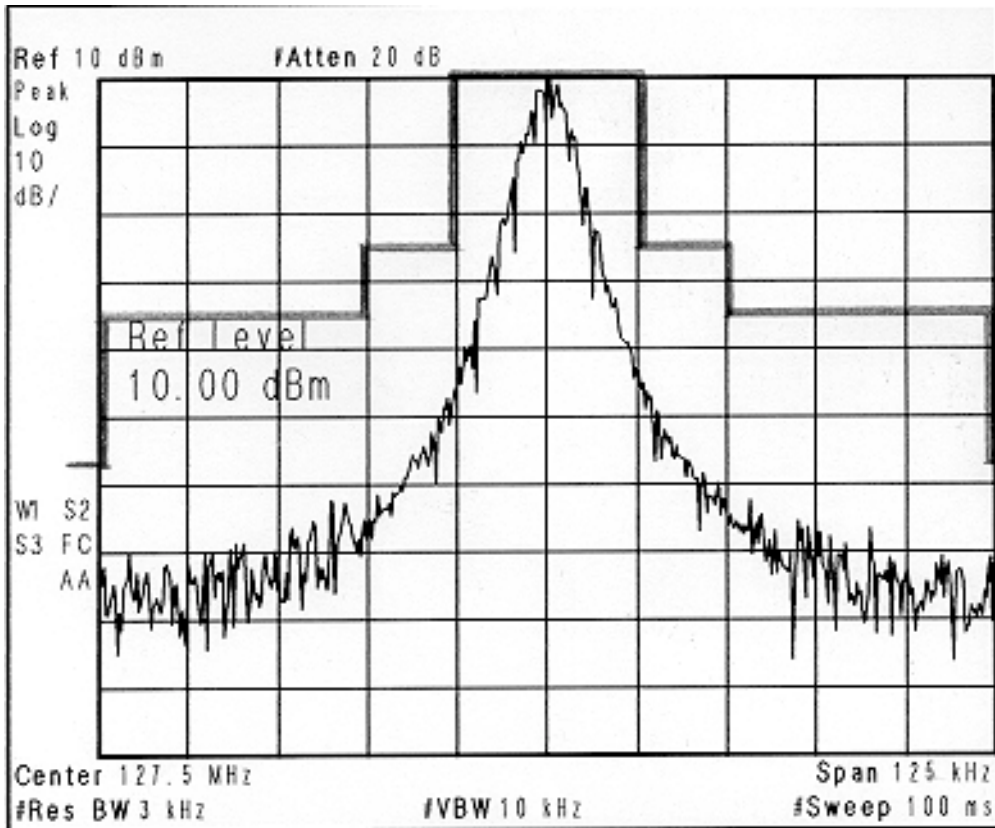

A2D Emission, 5 Watts random data 90% AM average

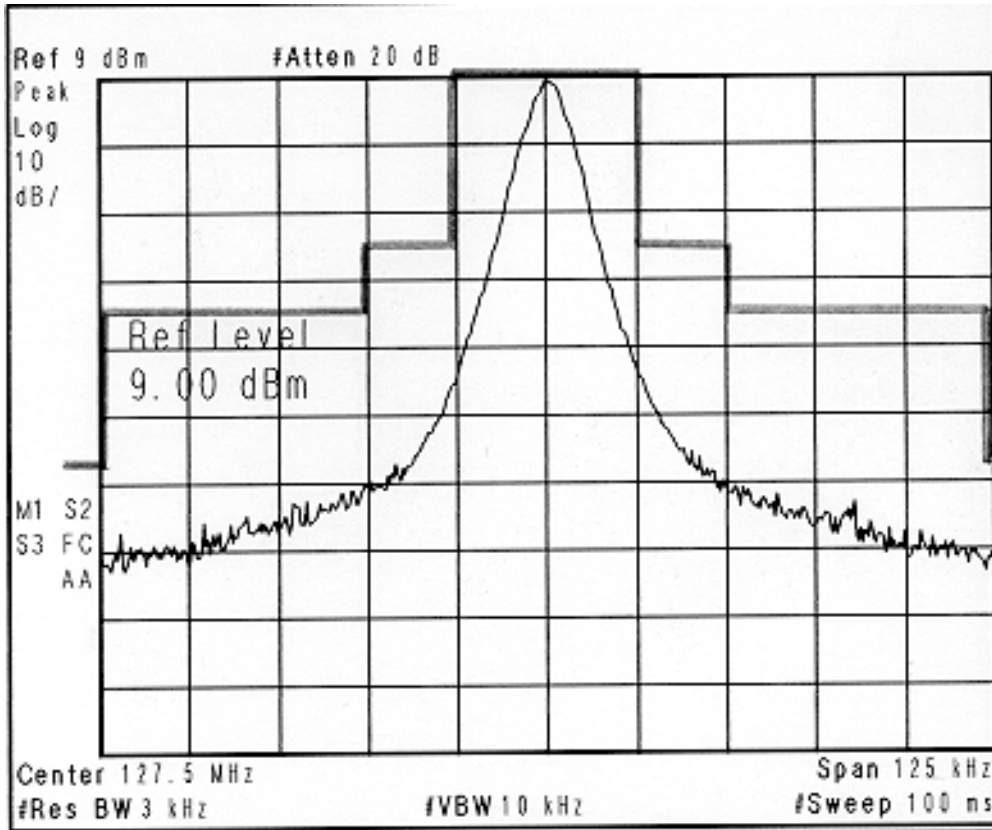

A2D Emission, 5 Watts random data 90% AM peak hold

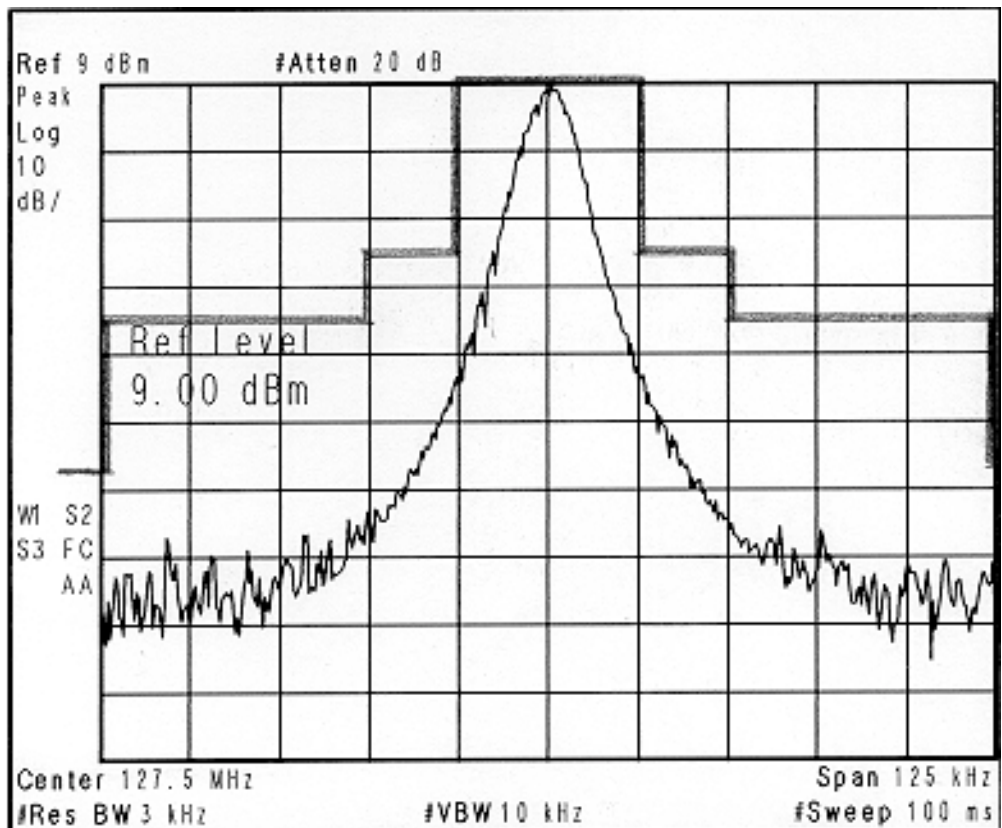

A2D Emission, 25 Watts 2400 Hz modulation 90% AM average

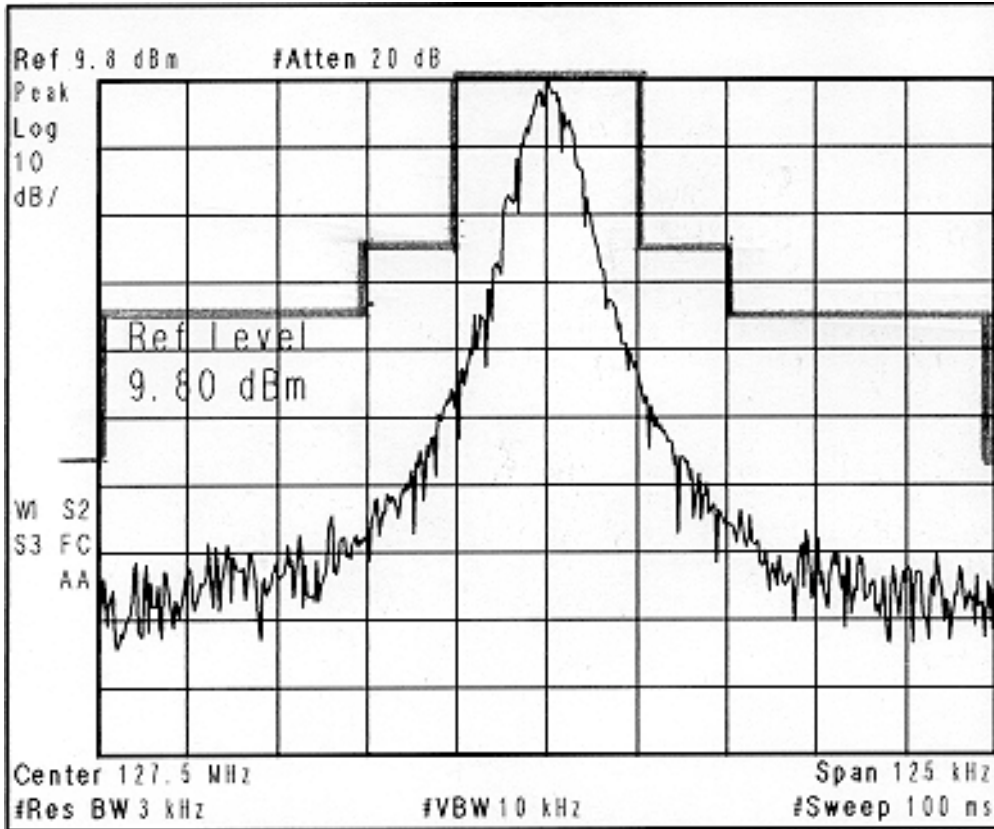

A2D Emission, 25 Watts random data 90% AM average

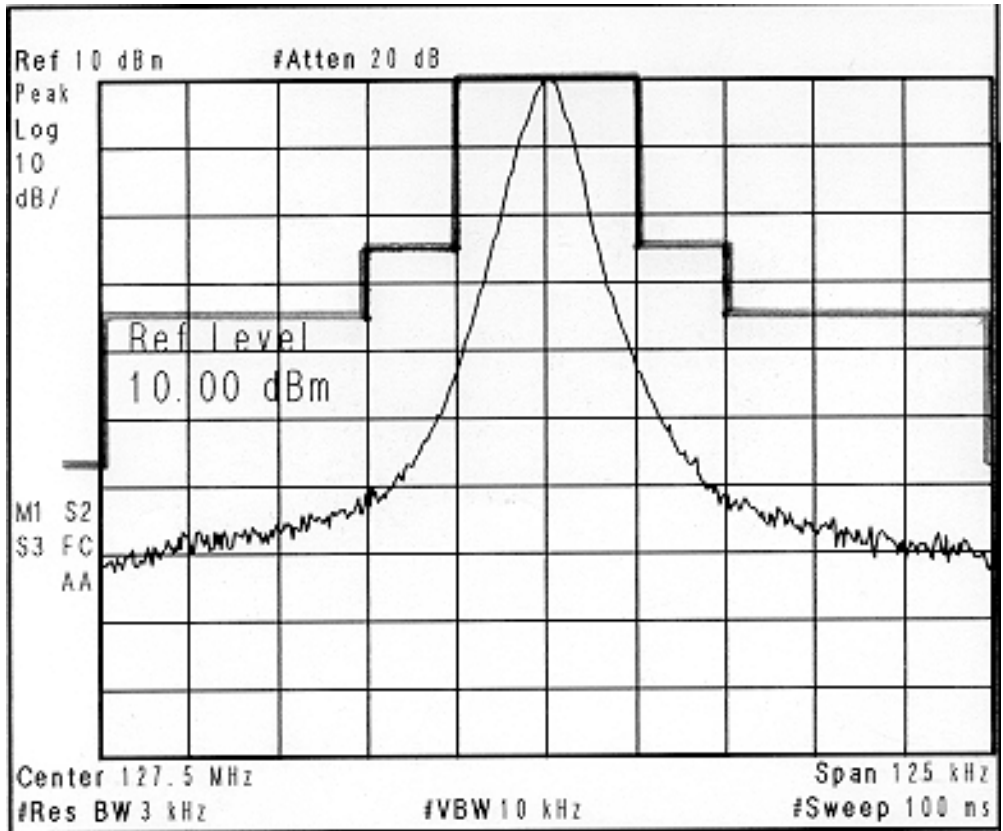

A2D Emission, 25 Watts random data 90% AM peak hold

Test Procedure – G1D and G7D Emissions

For the G1D and G7D emissions, two series of tests were actually performed, one demonstrating compliance with occupied bandwidth limits per §87.139(a), and the other to prove compliance with the current EUROCAE VDL MOPS adjacent channel power limits.

For §87.139(a) compliance the test set-up shown below was used. An internally generated test message approximately 128 msec in length, was transmitted at intervals of one second. The test message was a sample VDL data transmission as described in Appendix F, RTCA Paper No. 155-00/SC172-263 (final draft of RTCA specification DO-224A).

The transmitter was adjusted to produce the desired power output, and the resulting emission was measured with a vector signal analyzer set to peak hold mode. The analyzer display was averaged over 60 bursts before plots were taken. This test was performed at a representative frequency of 127.5 MHz and at both 5 watt and 25 watt power levels.

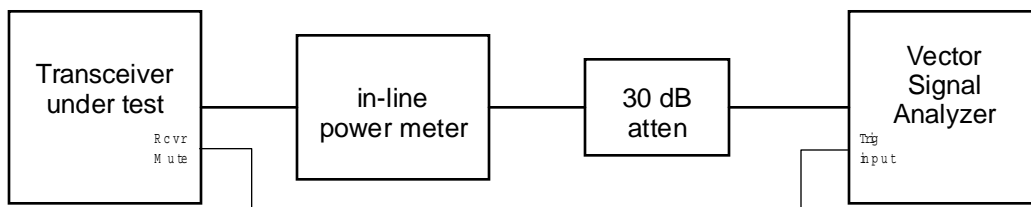

G1D/G7D Emissions Test set-up – Occupied Bandwidth and 1st Adjacent channel power

For VDL MOPS compliance testing, a more comprehensive test is required because of the burst power operating mode and the dynamic range limitations of the test equipment. When a composite D8PSK signal is passed through a linear system of finite dynamic range, adjacent channel power measurements can be degraded if special care is not taken. The tests outlined below have been used extensively during product development and have been empirically shown to be valid.

For all adjacent channel power measurements an internally generated test message was used. This message consisted of the first 28 milliseconds of a sample VDL data transmission as described in Appendix F, RTCA paper no 155-00/SC172-263 (final draft of RTCA specification DO-224A). The 28 msec message length was chosen to allow the vector signal analyzer to measure power over the entire burst.

All adjacent channel power tests were performed at a power level of 25 watts only, as this power level represents the worst-case operating condition for all adjacent channel power measurements.

1st Adjacent Channel Test

In order to characterize the first adjacent channel power, the test set-up was as shown in the above block diagram. The vector signal analyzer was set up to measure power over the entire burst by using the receiver mute signal present at the rear of the transceiver, which changes state when the transmitter starts its power ramp-up sequence. The analyzer input level was configured such that neither the instrument noise floor nor its input intercept point was a limiting factor in the measurement. The insertion loss of the attenuator was measured to be 30.6 dB across the band, and this value was used to adjust the power values appearing on the spectral plots, to obtain the actual ACP data.

2nd through 8th Adjacent Channel Test

For 2nd through 8th adjacent channel power measurements, special care was taken to avoid overloading the vector signal analyzer. This test used a crystal bandpass filter with a center frequency of 118.000 MHz to remove the fundamental transmitter output. This method requires that the transmit frequency be shifted the appropriate amount away from 118 MHz for each measurement. A transmit frequency of 118 MHz was used because the transmit VCO gain is highest at 118 MHz, consequently the VCO phase noise is worst at this frequency, and ACP measurements reflect this degradation at the 4th and higher channels. Thus by using 118 MHz as a test frequency the worst case conditions could be demonstrated.

The path between the transmitter output and analyzer input was first characterized in order to obtain the net gain or loss of the measurement system. In the set-up shown below the net gain of the power meter, attenuator, crystal filter and LNA was found to be -10.7 dB. This number was then added to the actual measured power values for each frequency. Data was taken at discrete frequencies corresponding to the 2nd through 128th adjacent channel, and appear as spectral plots on following pages.

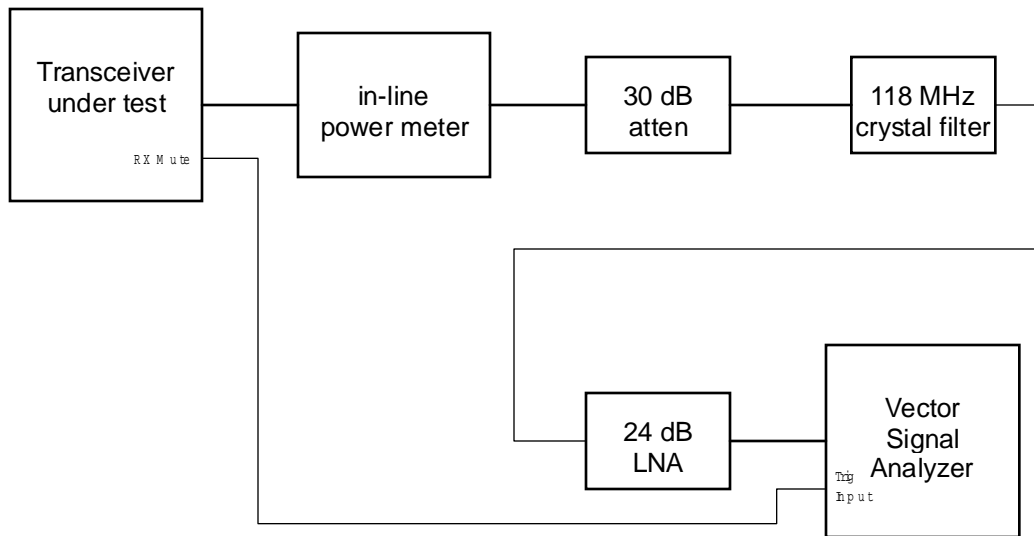

G1D/G7D Emissions Test Set-up – 2nd through 8th Adjacent channel power

8th Channel and Beyond Test

For adjacent channel power measurement beyond the 8th adjacent channel, a notch filter was used to suppress the fundamental signal as shown in the block diagram below. The use of the notch filter increases the dynamic range of the vector signal analyzer. The notch filter characteristics are such that there is only 1 dB of attenuation at ± 200 KHz from the notch frequency, with a notch depth of approximately 50 dB at the fundamental. The path attenuation between the transmitter output and the analyzer input was measured and found to be -37.6 dB at all frequencies 200 KHz or greater from the notch frequency of 118.000 MHz.

The signal analyzer was configured for a frequency span of 4 MHz. Since burst power measurement was no longer possible with this wide span, the analyzer was set to free run trigger with the display in peak hold mode. Then, while the burst message was being transmitted, the analyzer display was allowed to “paint” over a time period of 10 minutes (600 bursts), with the resulting trace captured. While this is somewhat different from the previous measurement methods used, it was felt that a wide span view was necessary to show compliance beyond the 8th channel, and that the peak hold measurement would display a worst-case condition.

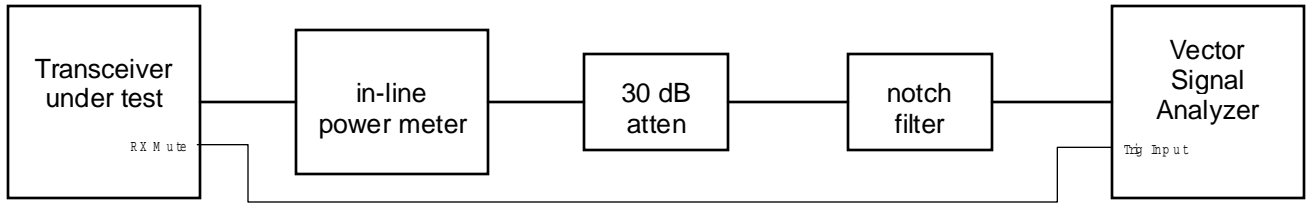

G1D/G7D Emissions Test set-up – 8th channel and greater ACP

G1D/G7D Occupied Bandwidth Test Data

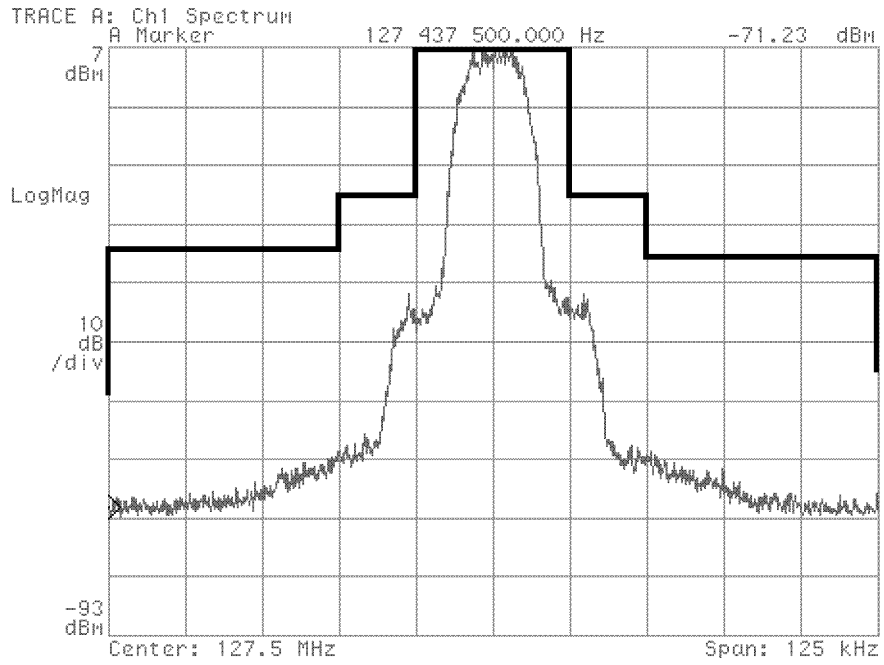

G1D/G7D Emission, 127.5 MHz, 25 W (87.139(a) limits)

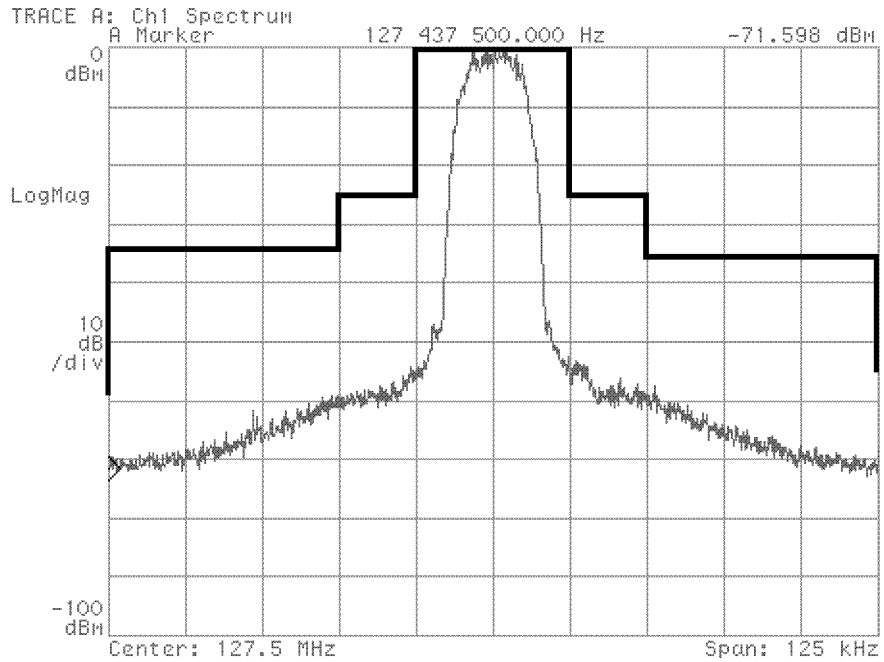

G1D/G7D Emission, 127.5 MHz, 5 W (87.139(a) limits)

G1D/G7D Adjacent Channel Power – Tabular Data

1st Adjacent Channel Power in 16 KHz Bandwidth, 25 Watts

<u>Freq. MHz</u>	<u>Upper</u>	<u>Lower</u>	<u>Limit (dBm)</u>
118.000	-18.9	-19.3	-18
127.500	-19.8	-20.2	-18
136.975	-19.9	-20.7	-18

1st Adjacent Channel Power in 25 KHz Bandwidth, 25 watts

<u>Freq. MHz</u>	<u>Upper</u>	<u>Lower</u>	<u>Limit (dBm)</u>
118.000	-4.5 dBm	-4.7	0
127.500	-5.3 dBm	-5.5	0
136.975	-3.9 dBm	-4.5	0

2nd through 128th Channel Power at 118 MHz, 25 watts

<u>Channel No.</u>	<u>Offset, KHz</u>	<u>Transmit Freq. MHz</u>	<u>ACP dBm</u>	<u>Limit dBm</u>
2 nd	50	118.050	-34.6	-28
4 th	100	118.100	-49.1	-38
8 th	200	118.200	-58.1	-43
16 th	400	118.400	-59.9	-48
32 nd	800	118.800	-66.3	-53
64 th	1600	119.600	-72.5	-53
128 th	3200	121.200	-77.5	-53

G1D/G7D 1st Adjacent Channel Power Plots

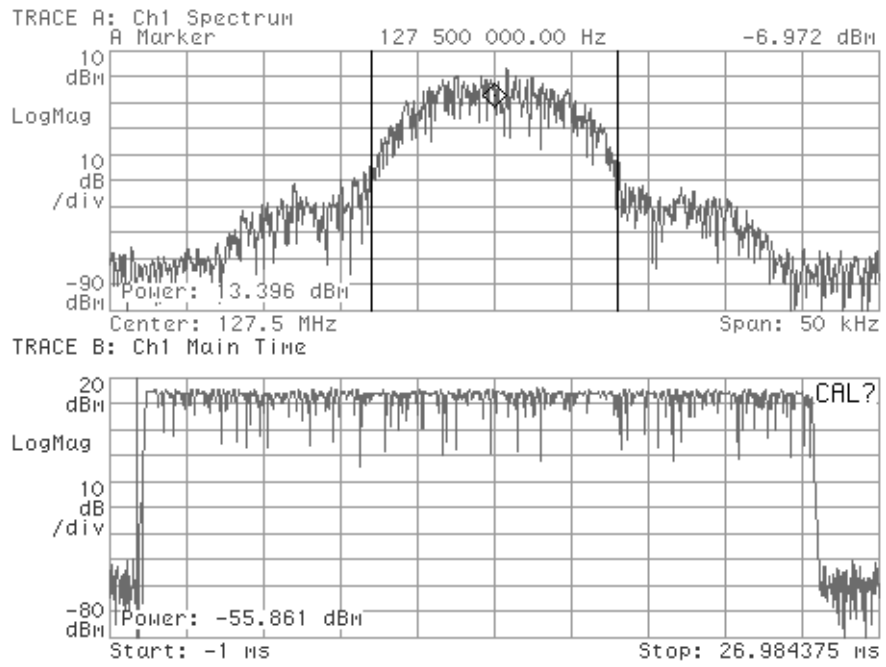

Burst Power Measurement Display

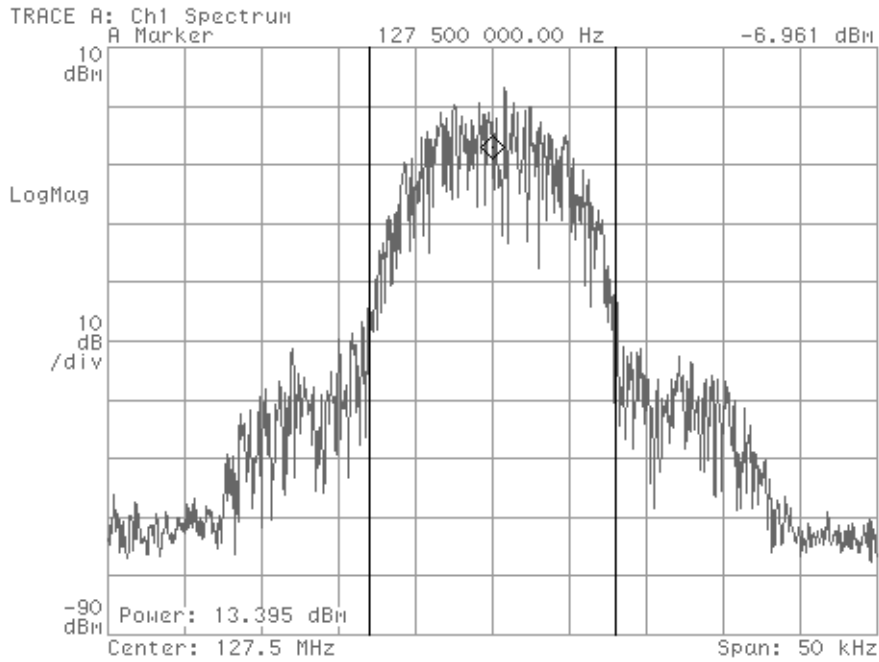

127.5 MHz On-channel Power

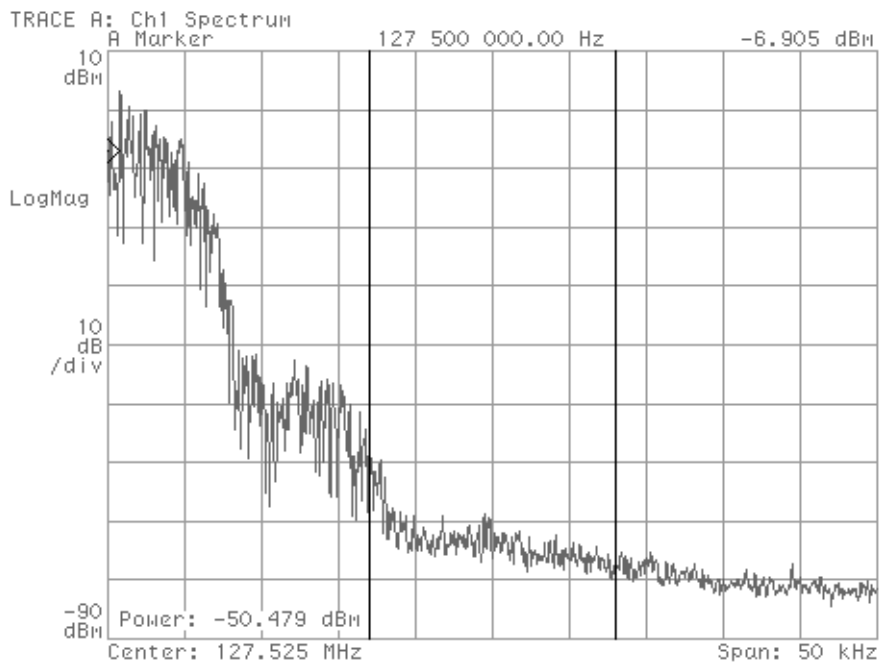

127.5 MHz Upper 1st Adjacent Channel, 16 KHz bandwidth

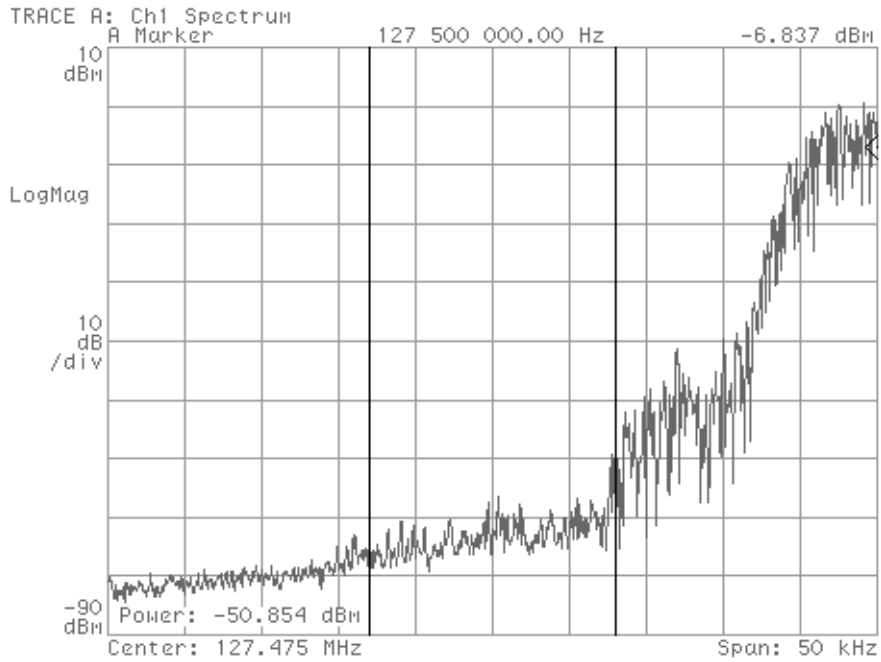

127.5 MHz Lower 1st Adjacent Channel, 16 KHz bandwidth

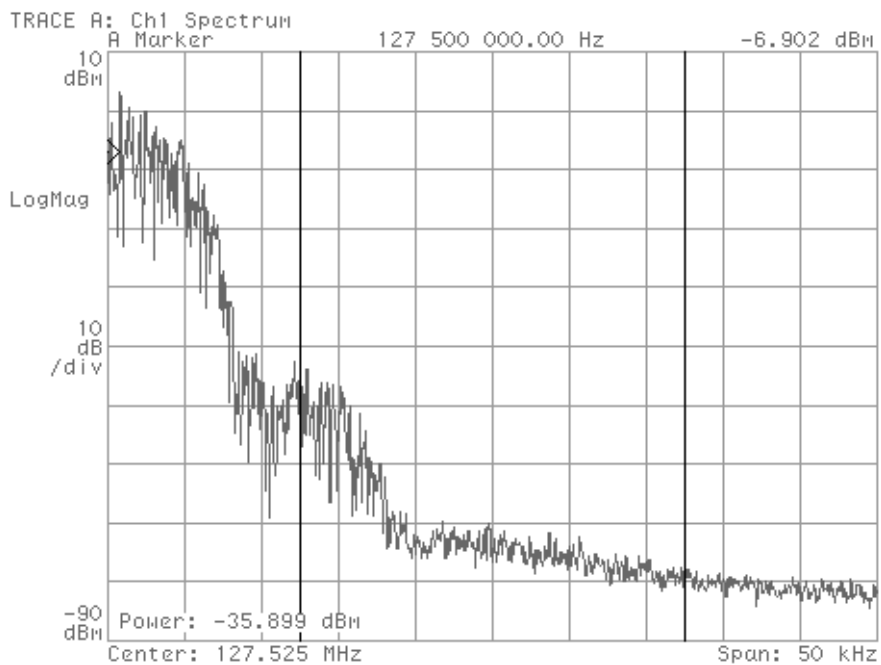

127.5 MHz Upper 1st Adjacent Channel, 25 KHz bandwidth

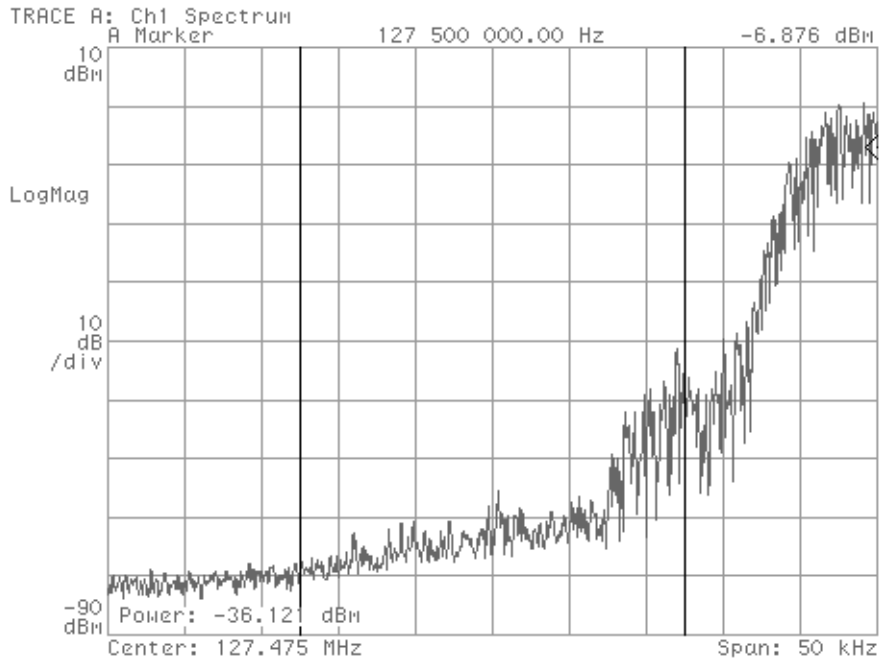

127.5 MHz Lower 1st Adjacent Channel, 25 KHz bandwidth

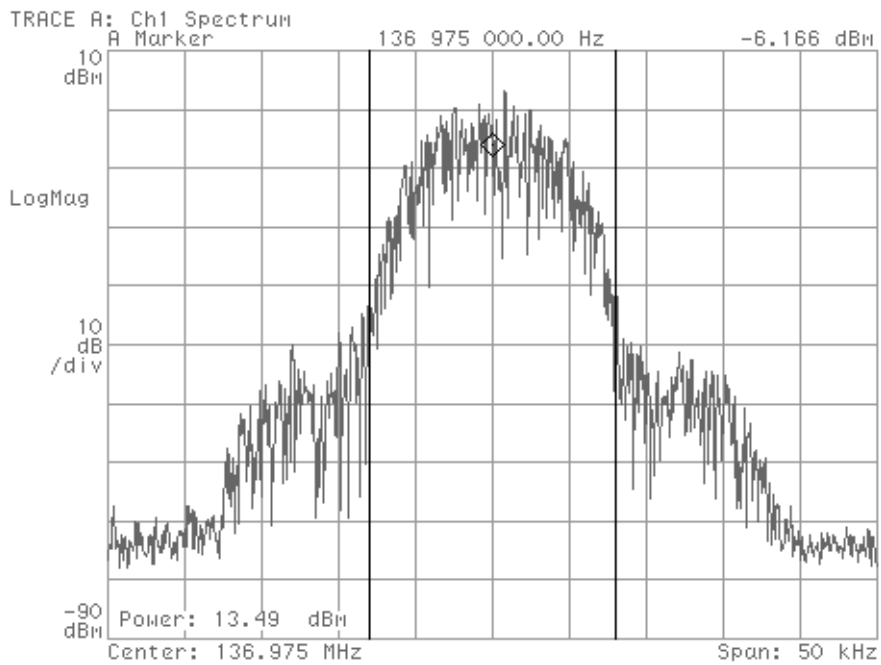

136.975 MHz On-channel

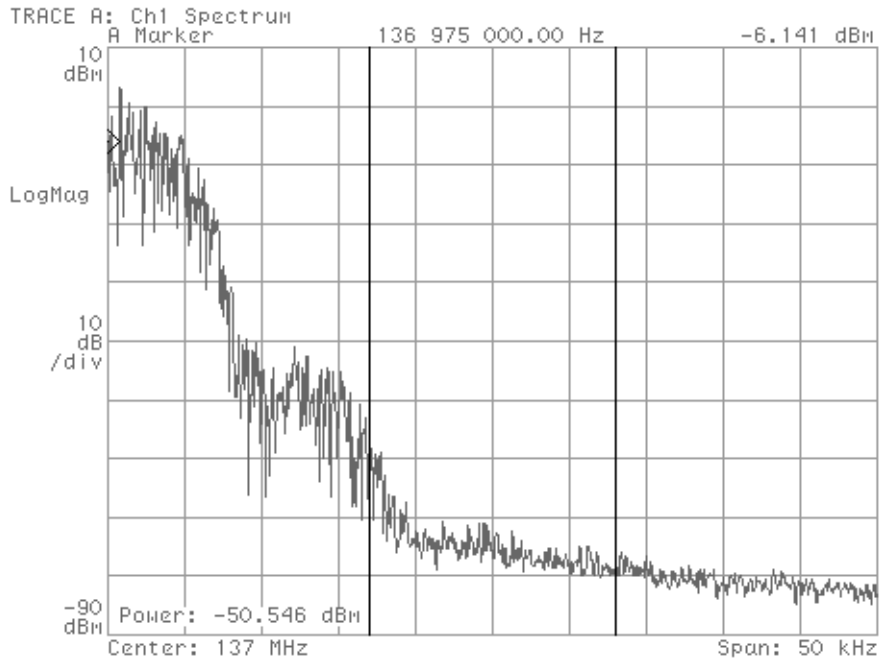

136.975 MHz Upper 1st Adjacent Channel, 16 KHz bandwidth

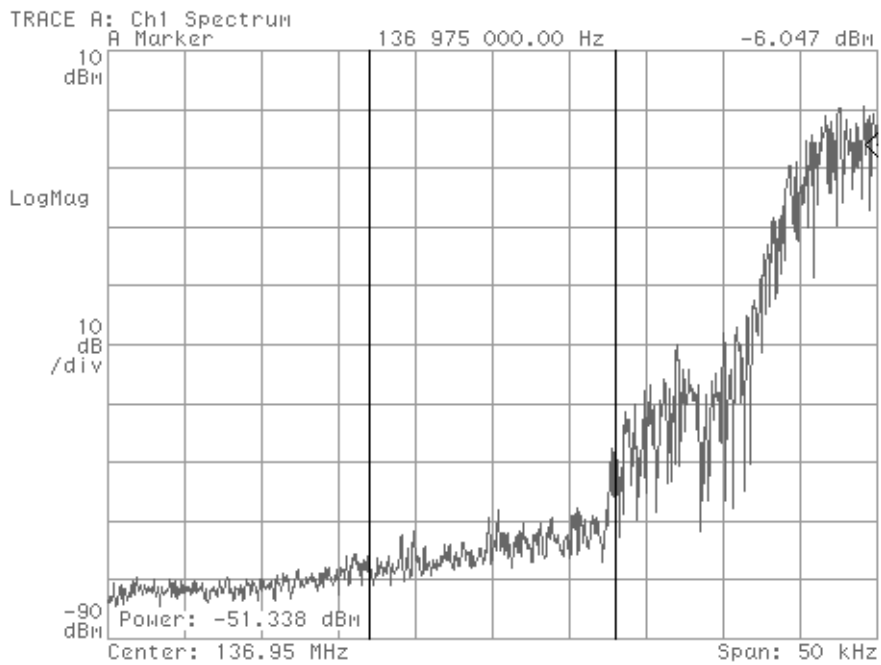

136.975 MHz Lower 1st Adjacent Channel, 16 KHz bandwidth

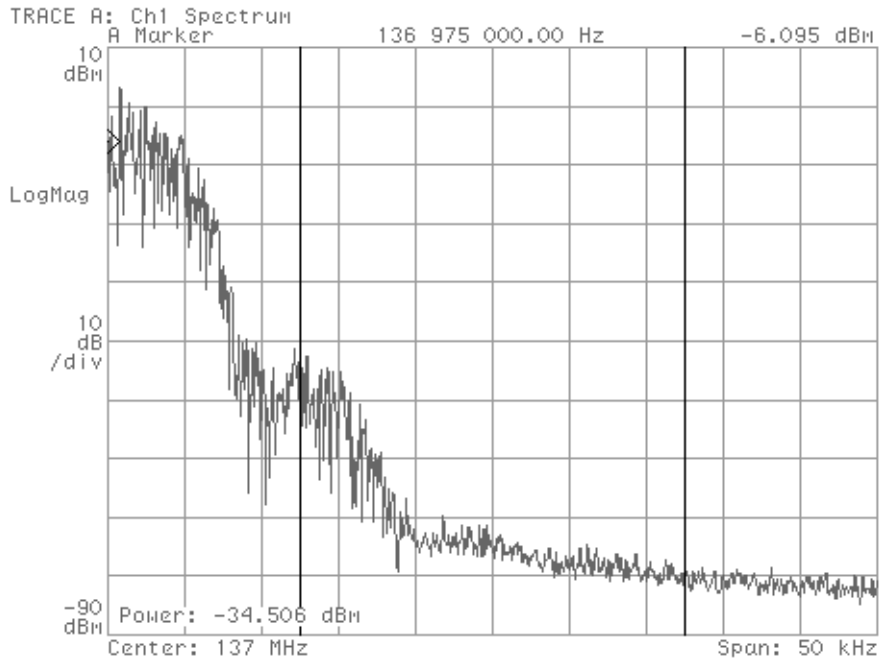

136.975 MHz Upper 1st Adjacent Channel, 25 KHz bandwidth

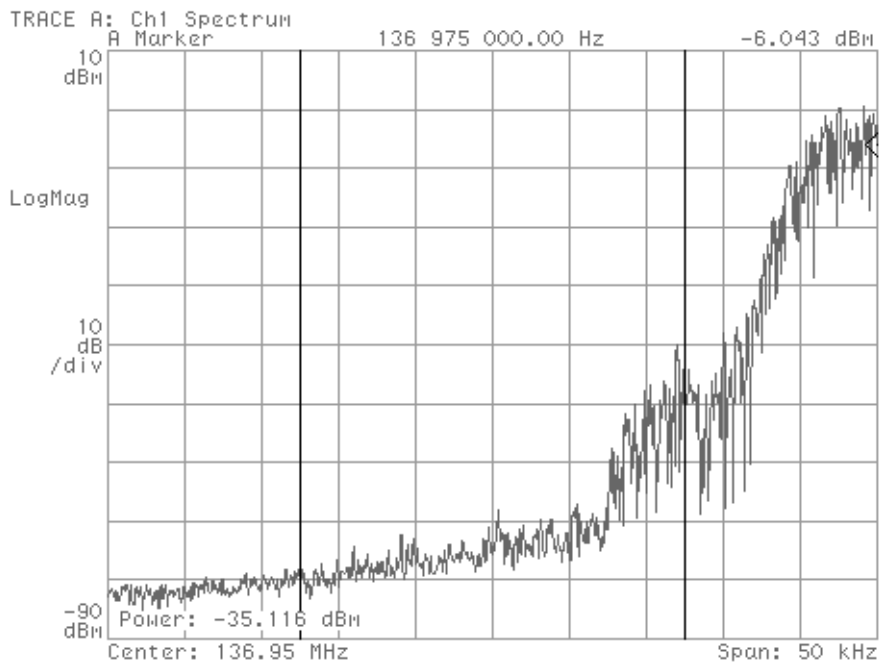

136.975 MHz Lower 1st Adjacent Channel, 25 KHz bandwidth

TRACE A: Ch1 Spectrum

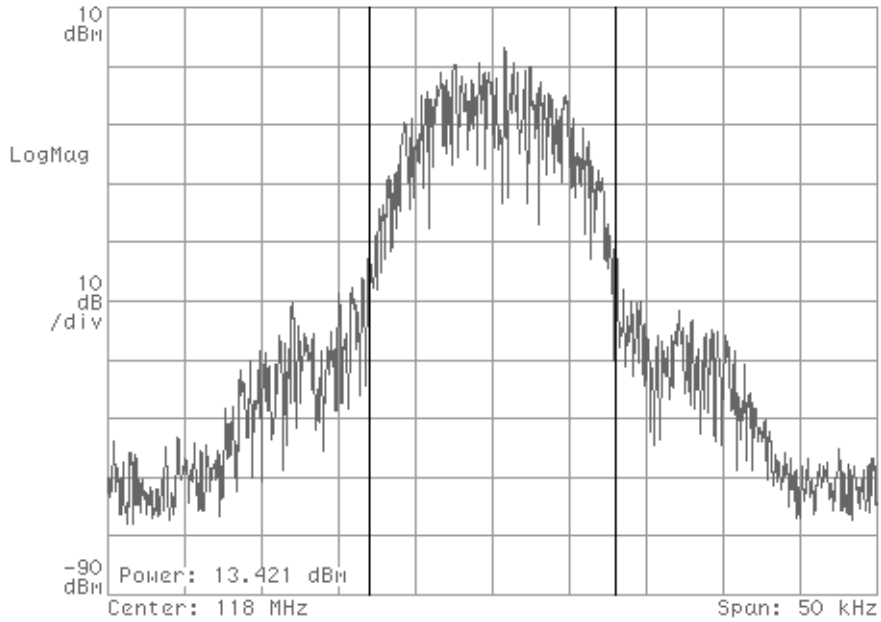

118.00 MHz On-channel

TRACE A: Ch1 Spectrum

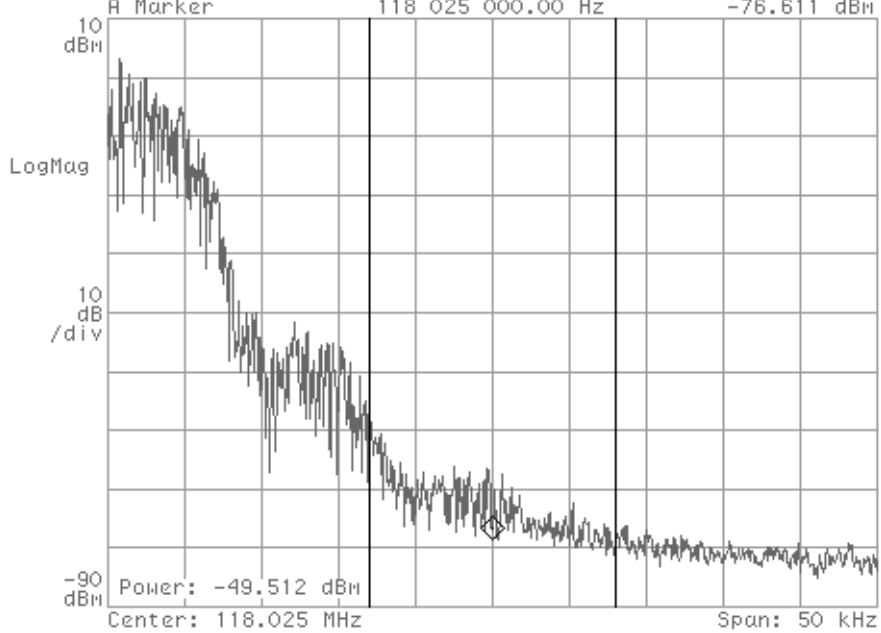

118.00 MHz Upper 1st Adjacent Channel, 16 KHz bandwidth

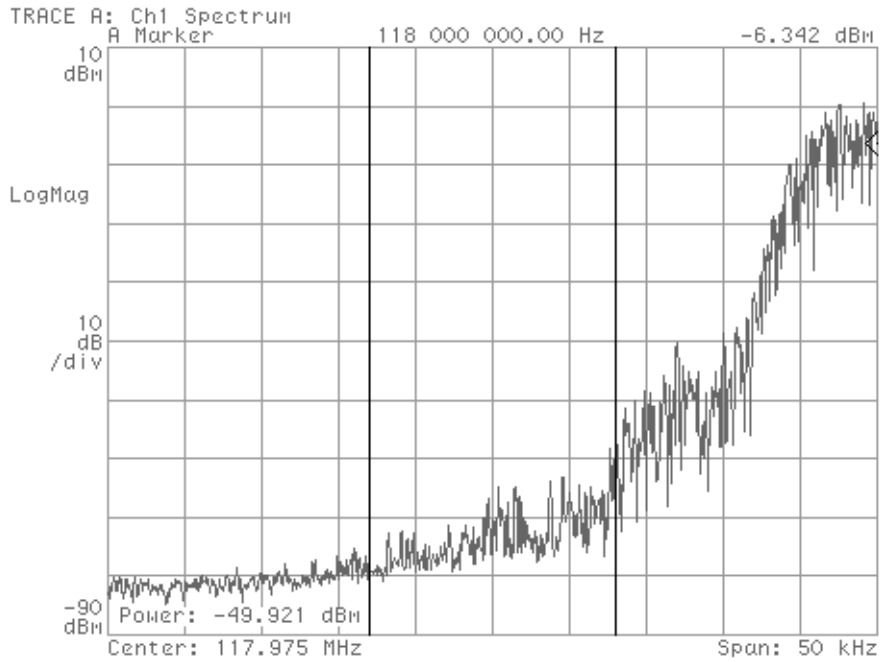

118.00 MHz Lower 1st Adjacent Channel, 16 KHz bandwidth

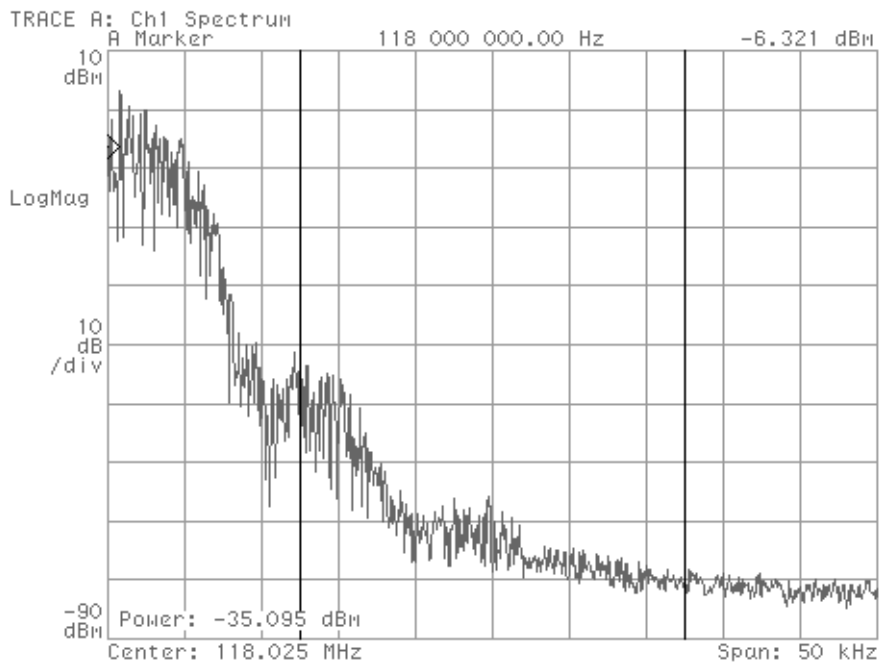

118.00 MHz Upper 1st Adjacent Channel, 25 KHz bandwidth

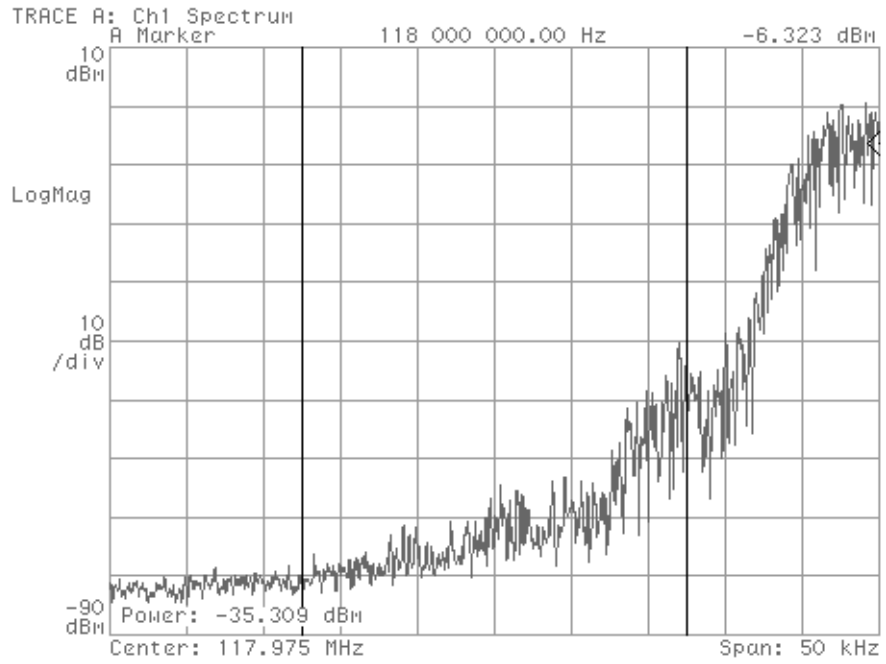

118.00 MHz Lower 1st Adjacent Channel, 25 KHz bandwidth

2nd through 128th Channel ACP Plots using Crystal Filter

TRACE A: Ch1 Spectrum

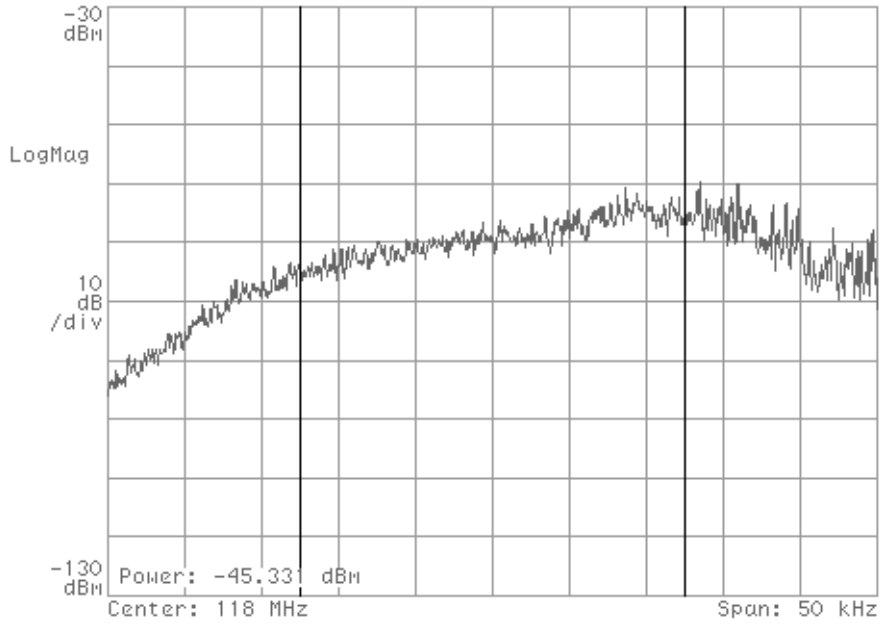

118 MHz 2nd Adjacent Channel (Fo=118.05 MHz)

TRACE A: Ch1 Spectrum

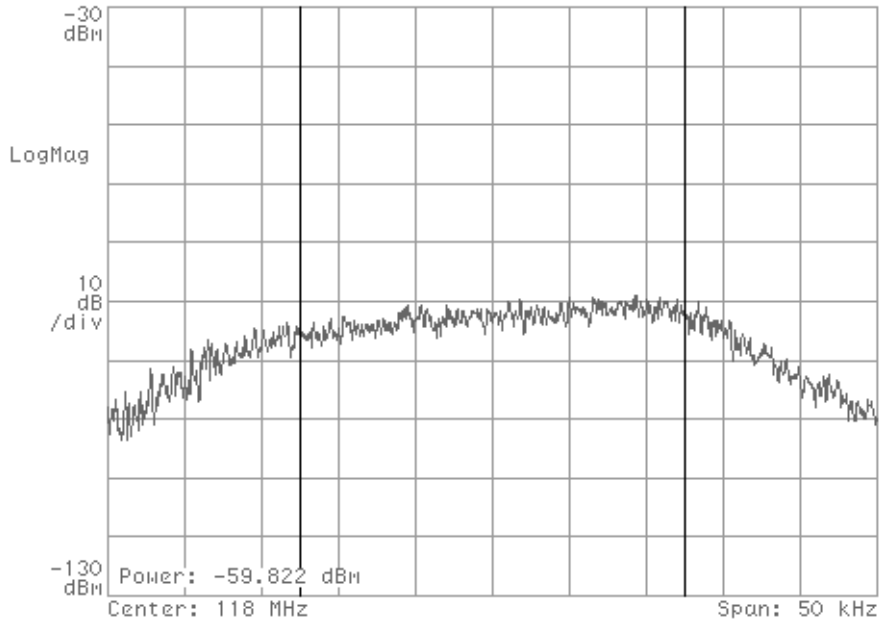

118 MHz 4th Adjacent Channel (Fo=118.10 MHz)

TRACE A: Ch1 Spectrum

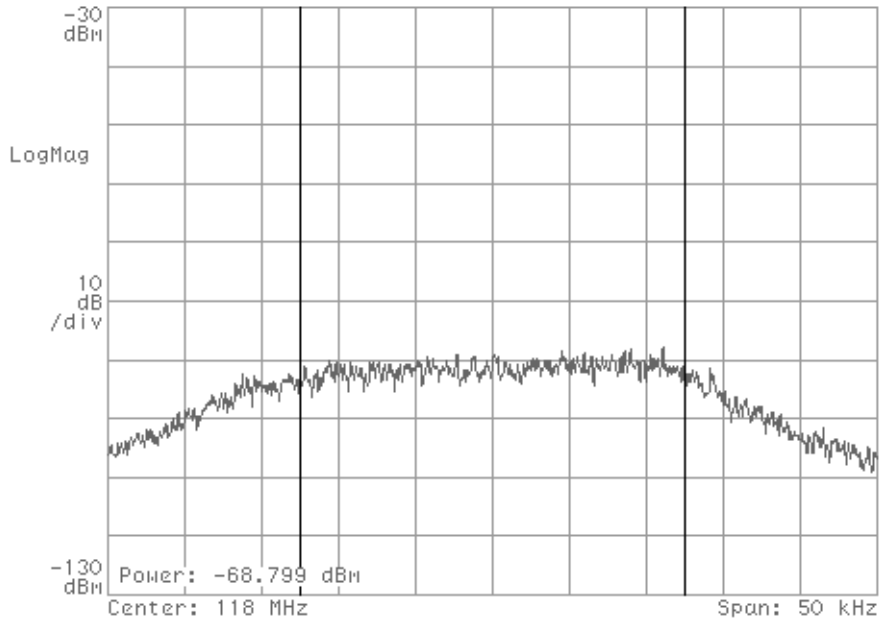

118 MHz 8th Adjacent Channel (Fo=118.20 MHz)

TRACE A: Ch1 Spectrum

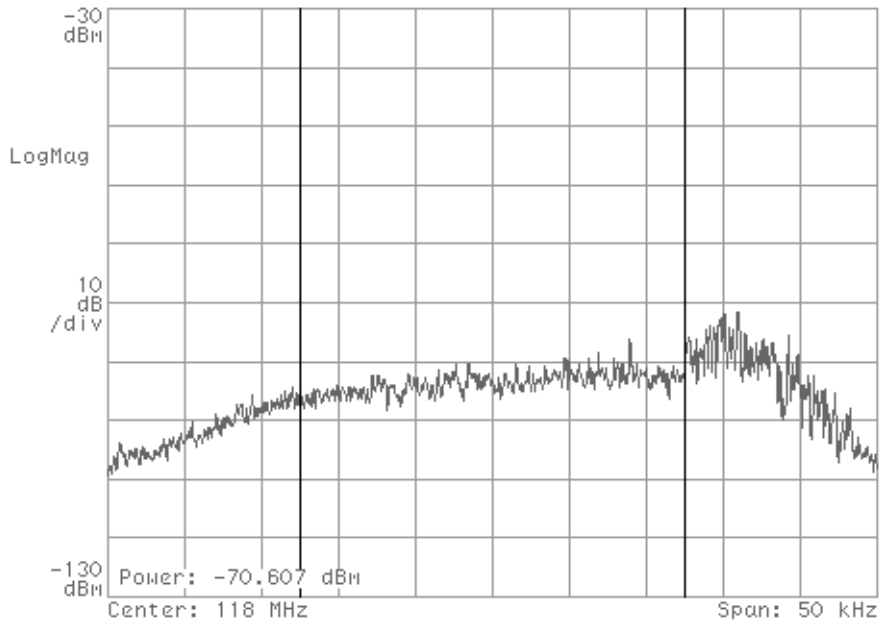

118 MHz 16th Adjacent Channel (Fo=118.40 MHz)

TRACE A: Ch1 Spectrum

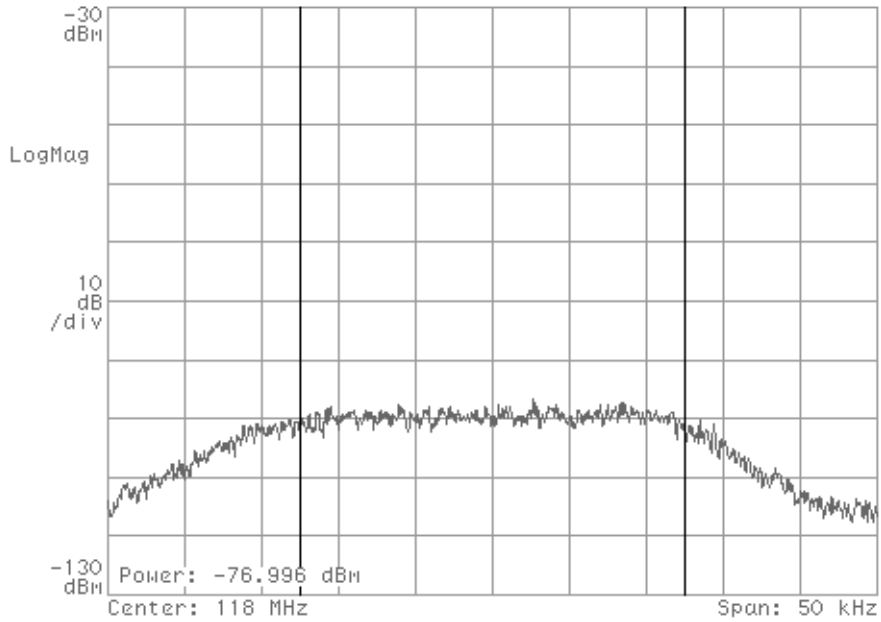

118 MHz 32nd Adjacent Channel (Fo=118.80 MHz)

TRACE A: Ch1 Spectrum

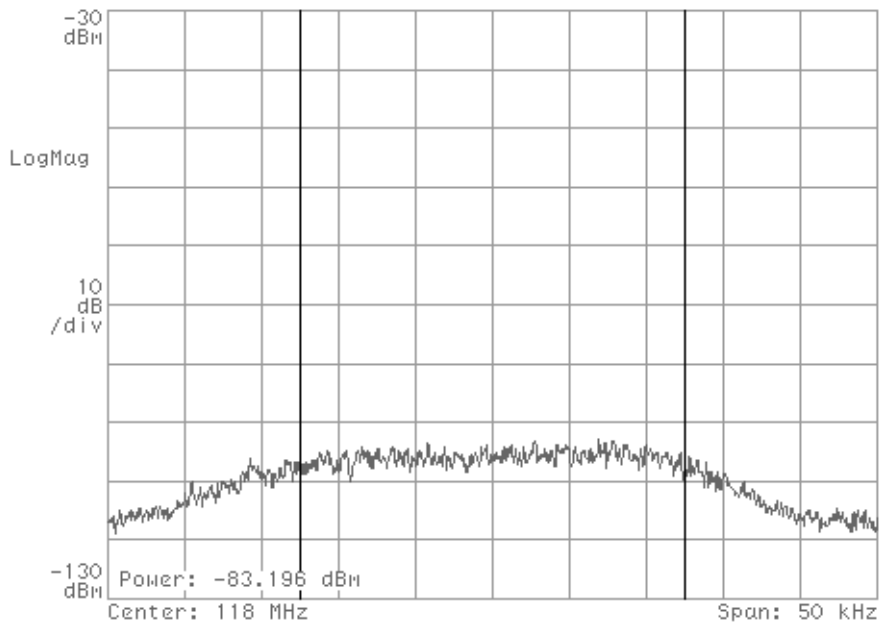

118 MHz 64th Adjacent Channel (Fo=119.6 MHz)

TRACE A: Ch1 Spectrum

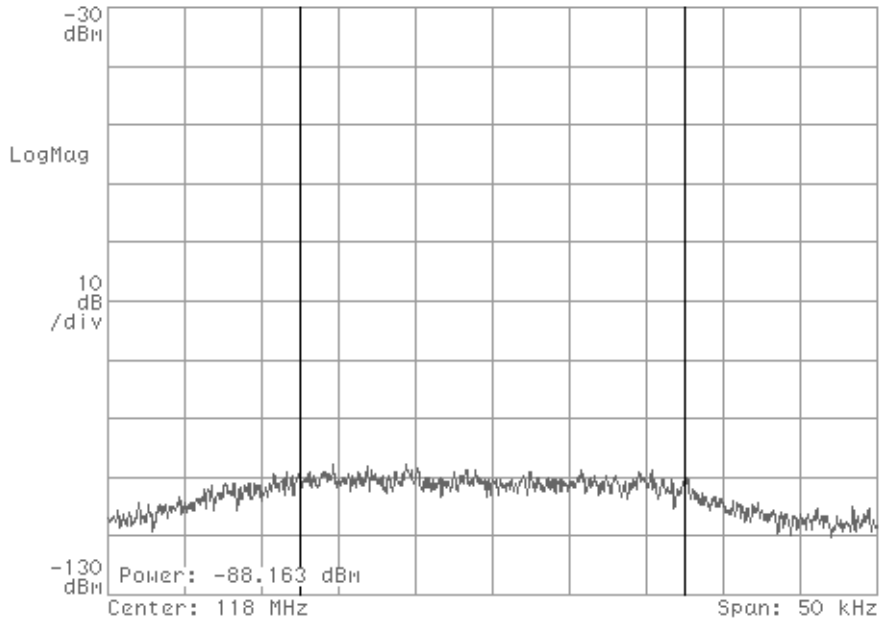

118 MHz 128th Adjacent Channel (Fo=121.2 MHz)

TRACE A: Ch1 Spectrum

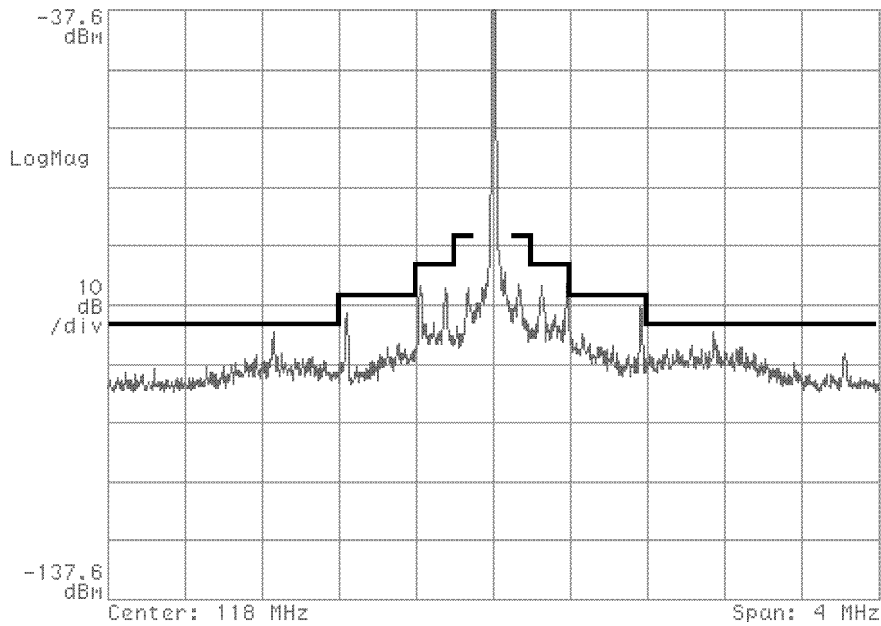

118 MHz ACP, wideband with notch, peak hold

2.1051 - Spurious Emissions at Antenna Terminals

Test Set-up

The block diagram below shows the test set-ups used to measure spurious emissions at the antenna terminals.

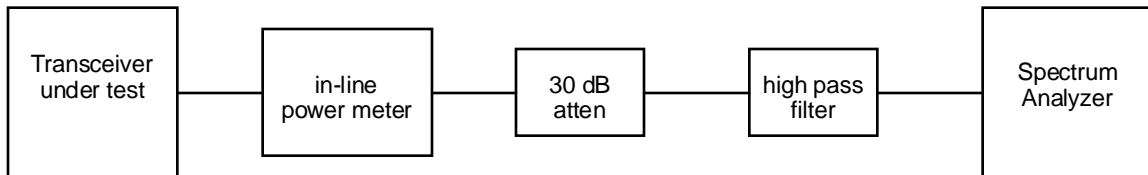

Test Set-up for wide-band harmonic investigation

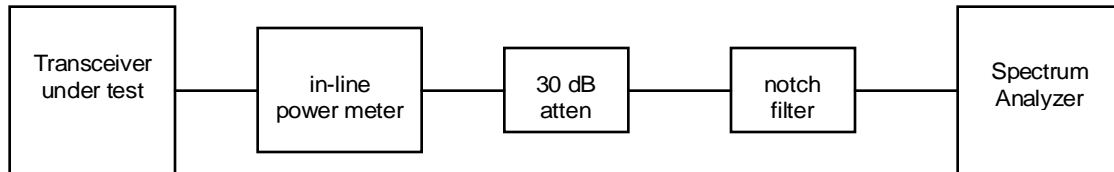

Test Set-up for close-in spurious investigation

Test Procedure

To look at wide-band harmonic output, a high-pass filter with a cut-off frequency of 205 MHz was placed in line between the 30 dB power pad and the spectrum analyzer to prevent the analyzer from being overloaded by the transmitted signal. The high pass filter response was first measured to obtain the exact amount of attenuation at each test frequency, so that the spectrum analyzer reference level could be adjusted accordingly. The transceiver under test was placed in the A2D emission mode and set to transmit a 2400 bit per second, continuous random data pattern at a power output level of 25 watts, with the modulation level set to 90 percent.

The power level of each harmonic up to 2 GHz was measured in a 16 KHz bandwidth (centered on the harmonic frequency) and the result recorded in tabular form. A plot showing harmonic and spurious output in the 10 KHz to 2 GHz range for each test frequency was also made.

To document close-in spurious responses, the high-pass filter was replaced by a notch filter. The combined characteristics of the notch filter and attenuator were measured in order to offset the reference level of the spectrum analyzer. As in the other test, the transceiver was caused to transmit a 2400 bit per second random data pattern at a power output level of 25 watts, with the modulation level set to 90 percent.

Plots were taken with analyzer spans of 3.2, 6.4 and 50 MHz to show the location and level of spurious responses close to the center frequency. The 3.2 and 6.4 MHz span plots are included in this test report; the 50 MHz span plots revealed no additional spurious products, and were thus omitted from this report to reduce file size.

Spurious Emissions Test Data

Plot of Spurious at Antenna Port, 0 to 2000 MHz, Fo = 127.5 MHz, 25 Watts

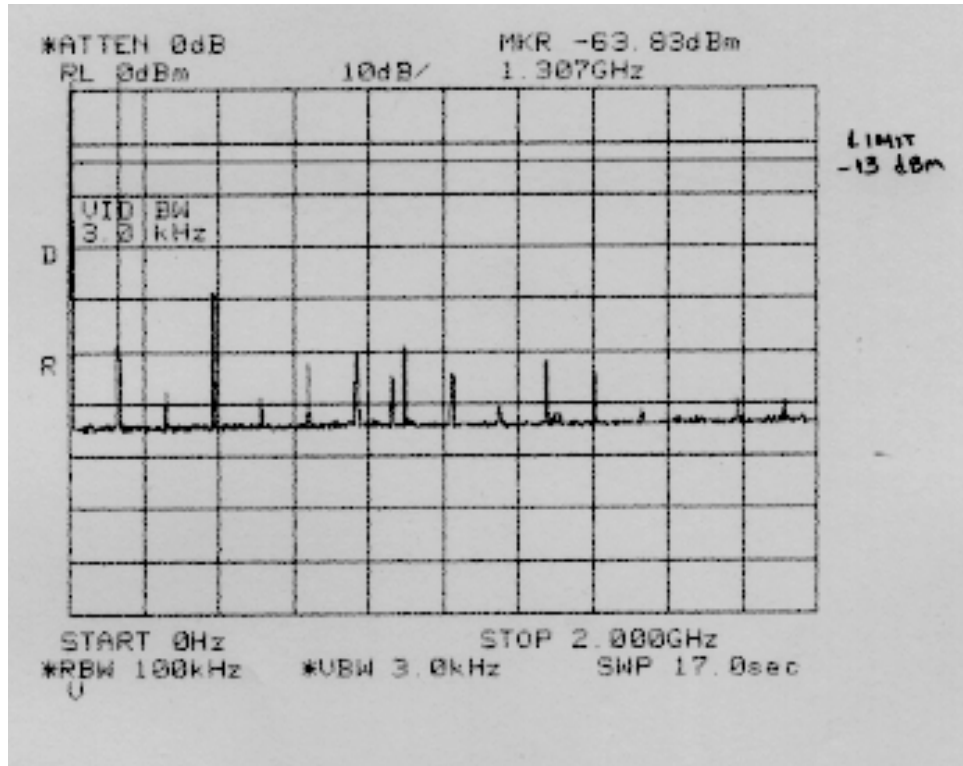

127.5 MHz harmonic data

Harmonic Frequency MHz	Measured level dBm	Correction factor dB	Actual spur level dBm	Limit dBm
255.0	-89.1	-31.0	-58.1	-13
382.5	-73.3	-31.0	-42.3	-13
510.0	-90.7	-31.1	-59.6	-13
637.5	-95.4	-31.2	-64.2	-13
765.0	-84.0	-31.3	-52.7	-13
892.5	-82.2	-31.4	-50.8	-13
1020.0	-87.2	-31.4	-55.8	-13
1147.5	-94.6	-31.5	-63.1	-13
1275.0	-85.8	-31.7	-54.1	-13
1402.5	-88.4	-31.7	-56.7	-13
1530.0	-96.8	-31.8	-65	-13
1657.5	-99.9	-32.4	-67.5	-13
1785.0	-94.6	-33.0	-61.6	-13
1912.5	-95.4	-33.8	-61.6	-13

Plot of Spurious at Antenna Port, 0 to 2000 MHz, Fo = 118 MHz, 25 watts

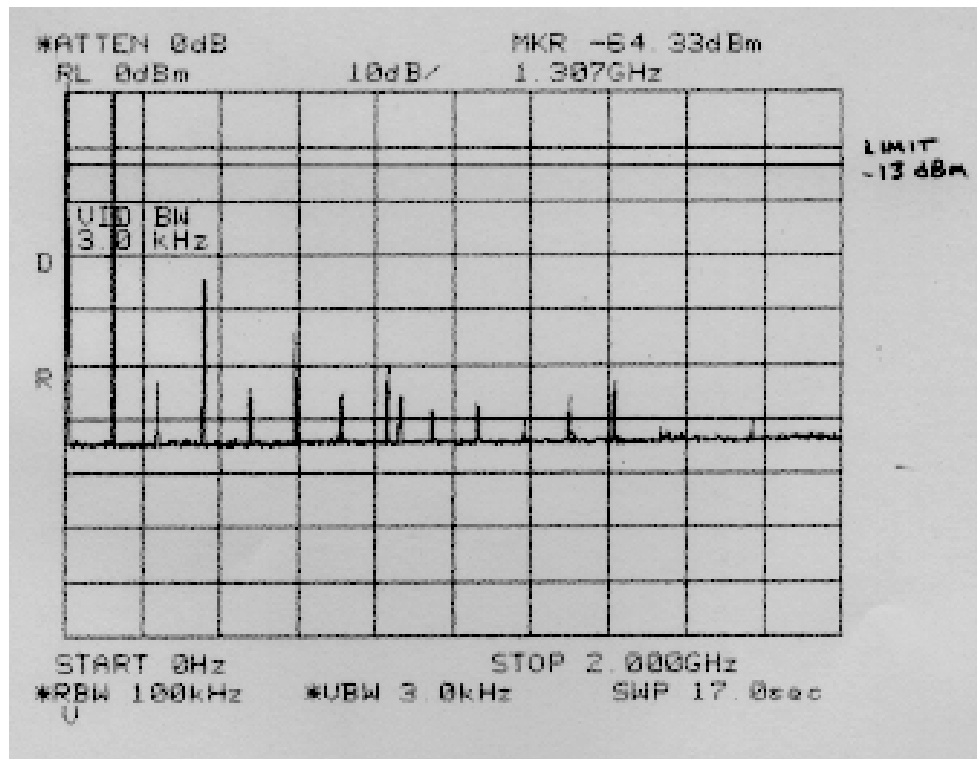

118 MHz harmonic data

Harmonic Frequency MHz	Measured level dBm	Correction factor dB	Actual spur level dBm	Limit dBm
236	-101.8	-31.0	-70.8	-13
354	-69.9	-31.0	-38.9	-13
472	-90.3	-31.1	-59.2	-13
590	-78.4	-31.2	-47.2	-13
708	-90.1	-31.3	-58.8	-13
826	-84.7	-31.4	-53.3	-13
944	-92.9	-31.4	-61.5	-13
1062	-90.3	-31.5	-58.8	-13
1180	-98.1	-31.6	-66.5	-13
1298	-89.6	-31.6	-58.0	-13
1416	-89.2	-31.7	-57.5	-13
1534	-97.3	-31.8	-65.5	-13
1652	-99.8	-32.4	-67.4	-13
1770	-95.3	-33.0	-62.3	-13
1888	-103.6	-33.5	-70.1	-13

Plot of Spurious at Antenna Port, 0 to 2000 MHz, Fo = 136.975 MHz, 25 watts

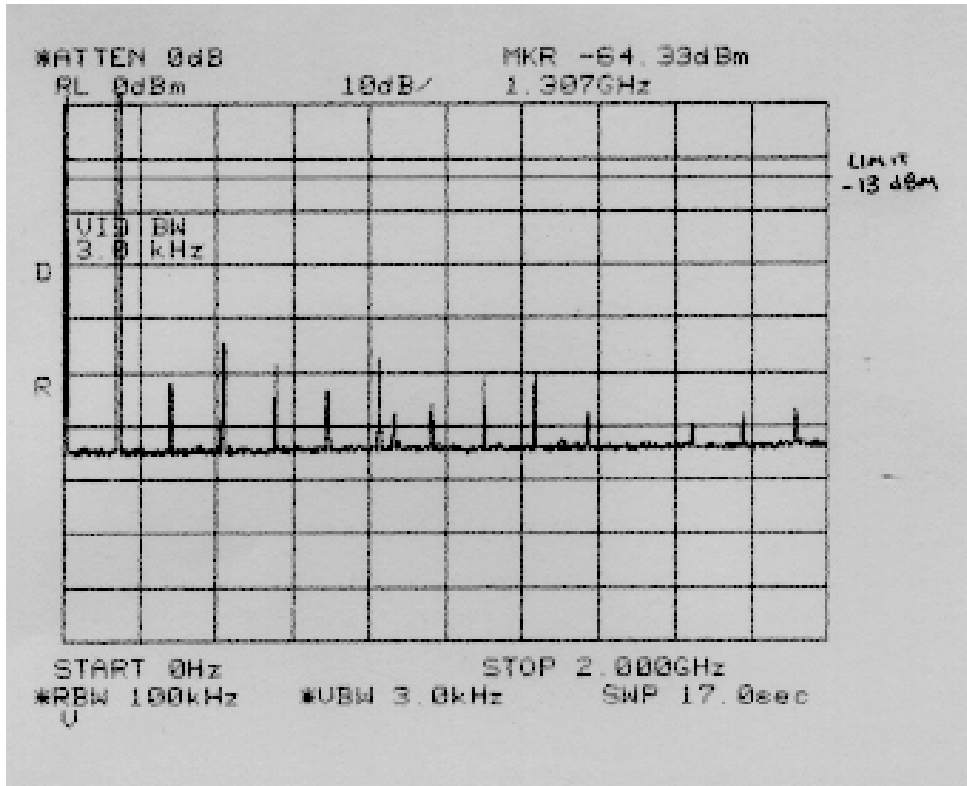

136.975 MHz harmonic data

Harmonic Frequency MHz	Measured level dBm	Correction factor dB	Actual spur level dBm	Limit dBm
273.950	-81.4	-31.0	-50.4	-13
410.925	-77.6	-31.0	-46.6	-13
547.900	-80.8	-31.1	-49.7	-13
684.875	-88.0	-31.3	-56.9	-13
821.850	-83.1	-31.4	-51.7	-13
958.825	-90.1	-31.4	-58.7	-13
1095.800	-84.9	-31.5	-53.4	-13
1232.775	-86.4	-31.7	-54.7	-13
1369.750	-93.9	-31.6	-62.3	-13
1506.725	-101.7	-31.8	-69.9	-13
1643.700	-105	-32.3	-72.7	-13
1780.675	-93.2	-33.0	-60.2	-13
1917.55	-105	-33.8	-71.2	-13

Close-in Spurious Emissions, 127.5 MHz, 25 watts

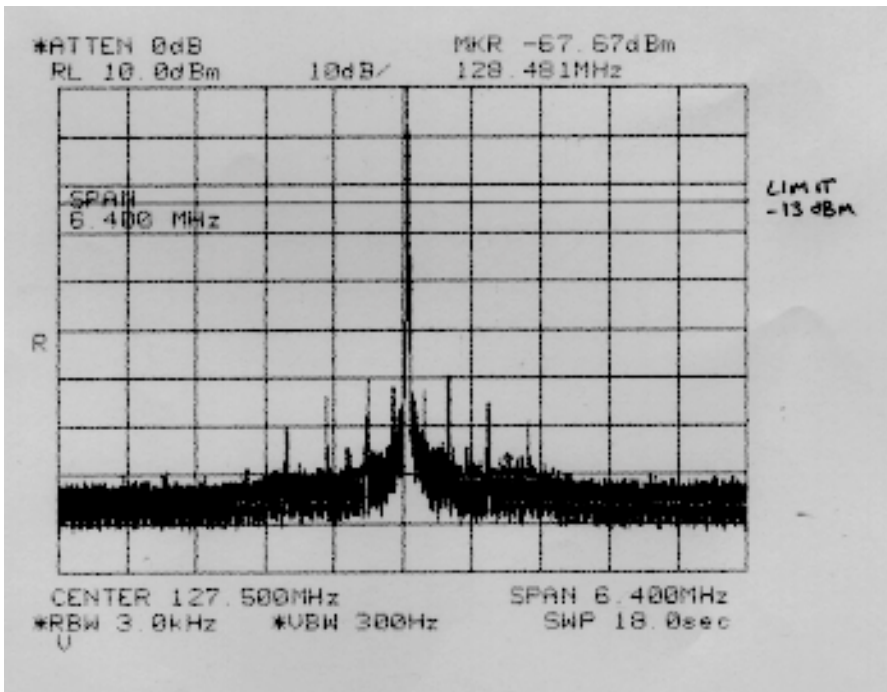
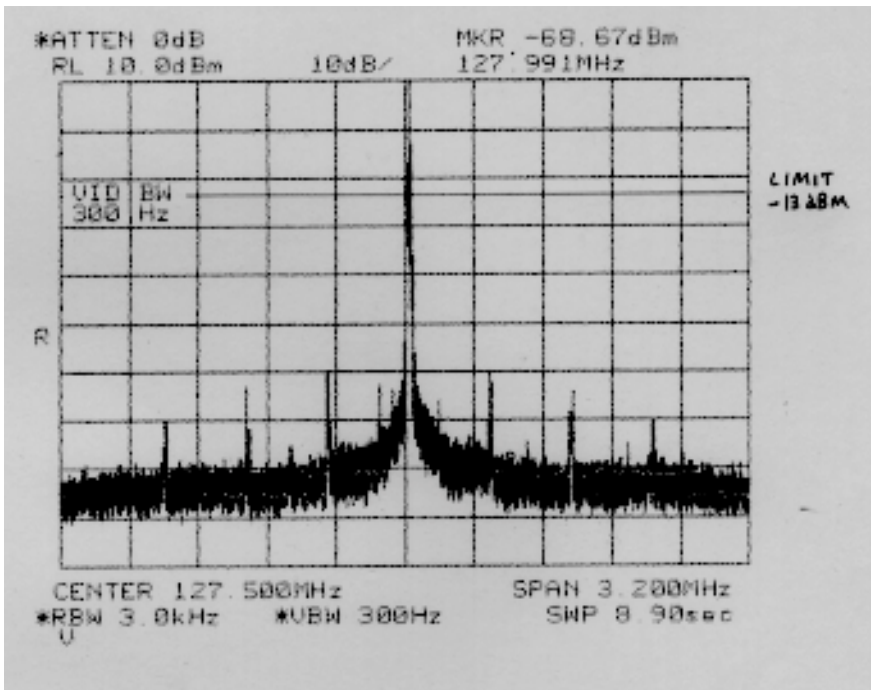

Close-in Spurious Emissions, 118 MHz, 25 watts

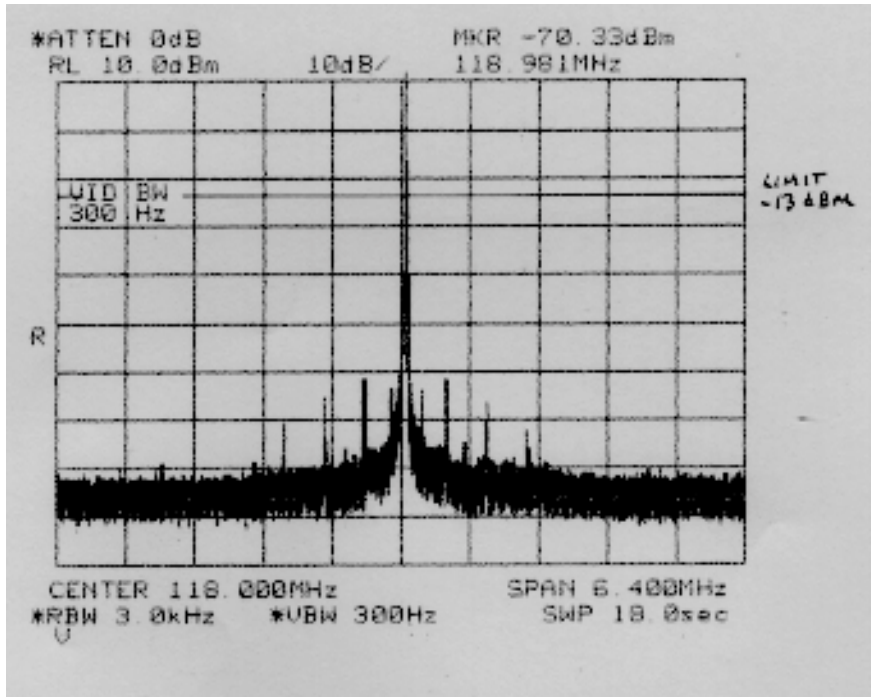
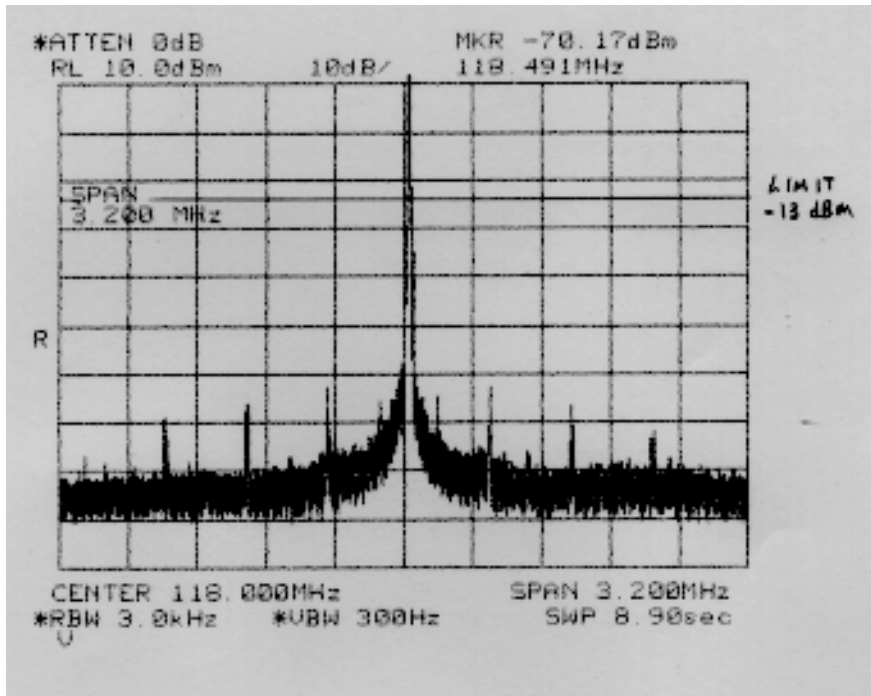

Close-in Spurious Emissions, 136.975 MHz, 25 watts

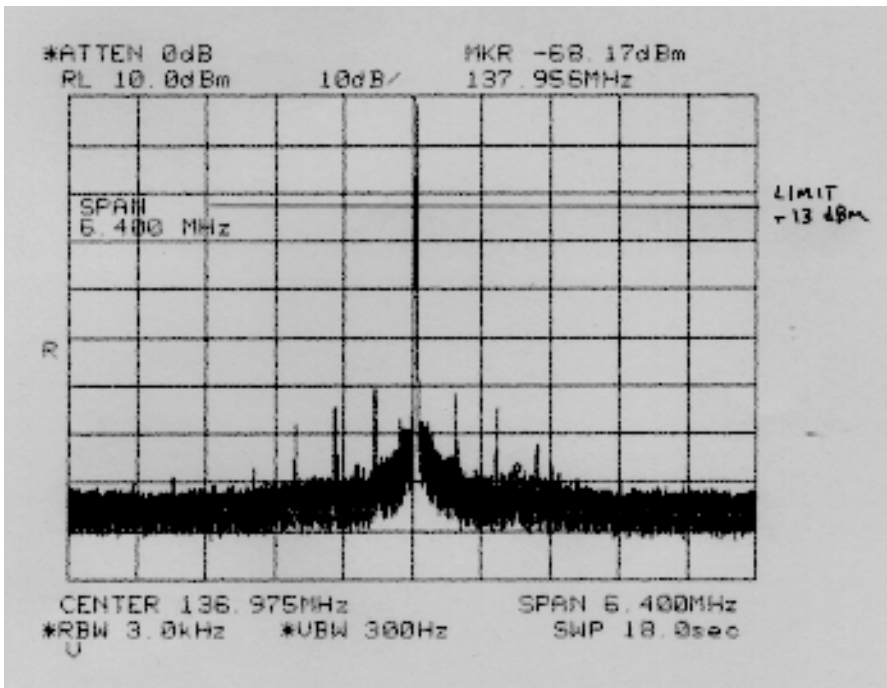
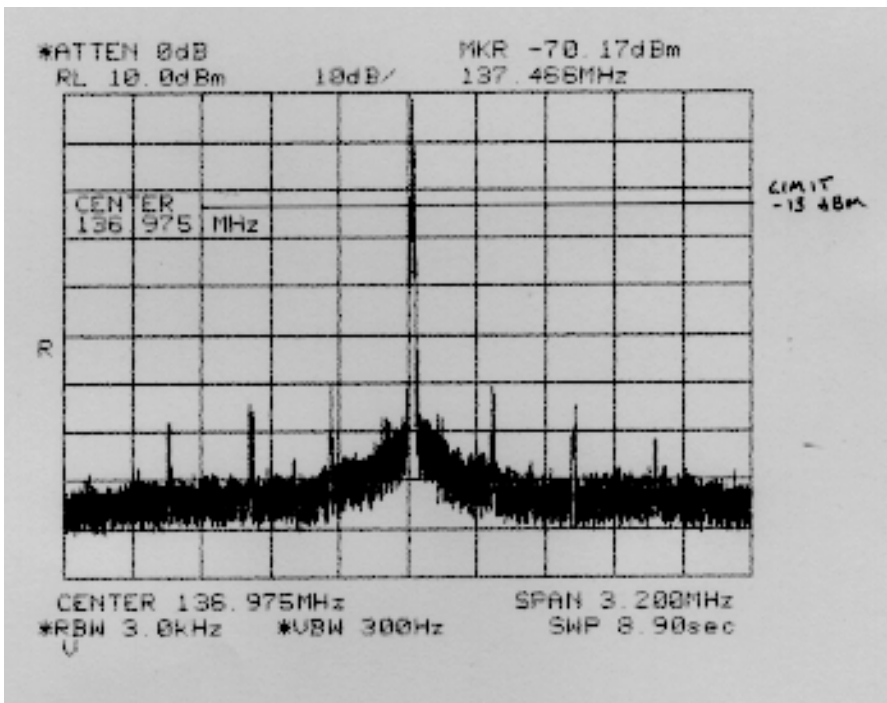

2.1053 - Field Strength of Spurious Radiation

Spurious radiation measurements were made by Instrument Specialties Co. Please refer to filename "exhibit 6B.doc" for a scanned image of their test report.

2.1055 - Frequency Stability

Test Procedure

To measure frequency stability, the transceiver was set up in the A2D emission mode to transmit an unmodulated carrier into a 50 ohm RF test load. The output of the test load was connected to a frequency counter which was used to measure the carrier frequency at 127.500 MHz. For all measurements, the frequency counter's time base was connected to the in-house frequency standard.

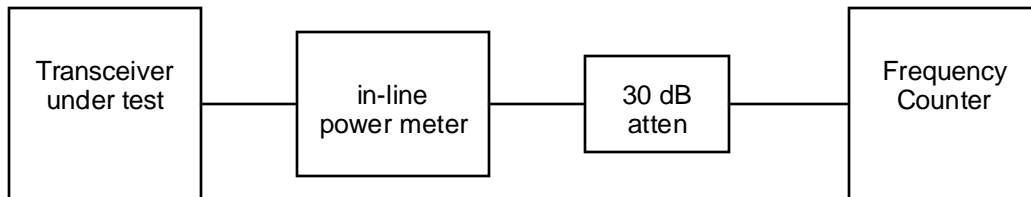

Test setup for frequency stability measurements

With the transceiver in a temperature chamber, frequency data was taken at ten degree intervals over the temperature range -30° to $+55^{\circ}$ C. An additional data point was taken at $+55^{\circ}$ C. For each data point, the transceiver temperature was allowed to stabilize for a minimum of 45 minutes before making measurements. After temperature stabilization, data was taken by keying the transmitter and observing the carrier frequency on the frequency counter. The frequency was observed for change during the first minute of transmission, then recorded. At all temperatures the frequency was observed to be within .05 ppm of the final frequency during the first minute of transmission, so no intermediate data points were taken.

To assess frequency stability over the operating voltage range, the transceiver was operated at room ambient temperature while it was connected to a variable AC power source. The frequency was measured at nominal line voltage values, and at line voltages ± 15 percent from the nominal values. To measure the frequency at each voltage the transmitter was keyed and the frequency recorded after one minute.

Frequency Stability Test Data

The following data was recorded for frequency stability vs. temperature.

<u>Temperature, °C</u>	<u>Transmit frequency, MHz</u>	<u>Frequency error, ppm</u>	<u>Limit, ppm</u>
-30	127.499854	- 1.145	20
-20	127.499886	- 0.894	20
-10	127.499914	- 0.674	20
0	127.499935	- 0.509	20
10	127.499925	- 0.588	20
20	127.499946	-0.423	20
30	127.500017	0.133	20
40	127.500016	0.125	20
50	127.499986	- 0.109	20
55	127.499956	- 0.345	20

The data that follows shows frequency stability versus supply voltage.

<u>Voltage, vac</u>	<u>Transmit frequency, MHz</u>	<u>Frequency error, ppm</u>	<u>Limit, ppm</u>
97.75	127.499974	- 0.203	20
115.0	127.499971	- 0.227	20
132.25	127.499974	- 0.203	20
195.5	127.499975	- 0.196	20
230.0	127.499978	- 0.172	20
264.5	127.499975	- 0.196	20

Note that the AC voltage values listed above represent the rated AC line voltage at nominal value and +/- 15 percent of nominal.

2.1057 - Frequency Spectrum to be Investigated

For all tests conducted at Harris Corporation the maximum frequency investigated was 2000 MHz. This value is greater than ten times the highest frequency used (181.975 MHz, in the receiver local oscillator circuit) in the transceiver.

List of Test Equipment Used

For measurements conducted at Harris Corporation (occupied bandwidth, frequency stability, power output and conducted spurious at antenna terminals) the following test equipment was used.

<u>Type of equipment</u>	<u>Manufacturer</u>	<u>Model Number</u>	<u>Serial Number</u>	<u>Calibration Date</u>
Spectrum analyzer	Hewlett-Packard	E4401B	US39440381	2/23/00
Spectrum analyzer	Hewlett-Packard	8560E	3517A01616	5/19/00
Power meter	Bird	4421	4217	-
Power sensor	Bird	4024	9507	5/3/00
RF load	Bird	8322	601	11/30/98
Signal generator	Hewlett-Packard	8657A	3430U92926	12/15/99
Frequency counter	Hewlett-Packard	53131A	KR91202816	2/4/00
Frequency standard	Hewlett-Packard	105B	-	3/29/00
AC power source	Pacific	345-AMX	28400	-
Variable RF atten.	Kay	839	4193-19	7/9/98
Fixed RF attenuator	Mini-Circuits	CAT-x	-	-
Notch filter	TX/RX Systems	20-35-96016	36462-A	-
Vector signal analyzer	Hewlett-Packard	89441A	US39313906	3/20/00
VSA RF section	Hewlett-Packard	89441A	US39312289	3/20/00
Network Analyzer	Hewlett-Packard	8753D	3410A05658	8/19/99
High pass filter	Mini-Circuits	NHP-250	-	-
Low noise amplifier	Mini-Circuits	ZFL-500LN	-	-
Crystal filter	Piezo Technology	4133VBB	1775	-
Personal computer	Compaq	Contura 410CX	-	-