

July 31, 2020

Enlighted, Inc
930 Benecia Ave.
Sunnyvale, CA 94085

Dear Hariharan Muthukrishnan,

Enclosed is the EMC Wireless test report for compliance testing of the Enlighted, Inc, SU-5i as tested to the requirements of Title 47 of the CFR, Ch. 1 (10-1-06 ed.), Part 15 Subpart C for Intentional Radiators.

Thank you for using the services of Eurofins E&E North America. If you have any questions regarding these results or if we can be of further service to you, please feel free to contact me.

Sincerely yours,
EUROFINS E&E NORTH AMERICA



Michelle Tawmging
Documentation Department

Reference: (\\Enlighted, Inc\\WIRS107425A-FCC247 BLE Rev 3)



Certificates and reports shall not be reproduced except in full, without the written permission of Eurofins E&E North America. This letter of transmittal is not a part of the attached report.

Eurofins MET Laboratories Inc. (Eurofins E&E North America) is part of the Eurofins Electrical & Electronics (E&E) global compliance network.

Electromagnetic Compatibility Criteria Test Report

for the

**Enlighted, Inc
SU-5i**

Tested under
the FCC Certification Rules
contained in
15.247 Subpart C for Intentional Radiators

Report: WIRS107425A-FCC247 BLE Rev 3

July 31, 2020

Prepared For:

**Enlighted, Inc
930 Benecia Ave.
Sunnyvale, CA 94085**

Prepared By:
Eurofins E&E North America
3162 Belick Street
Santa Clara, CA 95054

Electromagnetic Compatibility Criteria Test Report

for the

Enlighted, Inc
SU-5i

Tested under
the FCC Certification Rules
contained in
15.247 Subpart C for Intentional Radiators



Arsalan Hasan, Project Engineer
Electromagnetic Compatibility Lab



Michelle Tawmging
Documentation Department

Engineering Statement: The measurements shown in this report were made in accordance with the procedures indicated, and the emissions from this equipment were found to be within the limits applicable. I assume full responsibility for the accuracy and completeness of these measurements, and for the qualifications of all persons taking them. It is further stated that upon the basis of the measurements made, the equipment tested is capable of operation in accordance with the requirements of the FCC Rules Part 15.247 under normal use and maintenance.

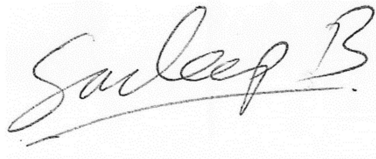

Sandeep Brar,
Manager, Electromagnetic Compatibility Lab

Report Status Sheet

Revision	Report Date	Reason for Revision
0	June 12, 2020	Initial Issue.
1	June 30, 2020	Review Updates
2	July 26, 2020	TCB Updates
3	July 31, 2020	TCB Updates

Table of Contents

I.	Executive Summary	1
	A. Purpose of Test.....	2
	B. Executive Summary	2
II.	Equipment Configuration.....	3
	A. Overview.....	4
	B. References.....	5
	C. Test Site.....	5
	D. Description of Test Sample	6
	E. Equipment Configuration.....	6
	F. Support Equipment.....	6
	G. Ports and Cabling Information	6
	H. Mode of Operation	7
	I. Method of Monitoring EUT Operation	8
	J. Modifications	8
	a) Modifications to EUT	8
	b) Modifications to Test Standard.....	8
	K. Disposition of EUT	8
	L. Measurement Uncertainty	8
III.	Electromagnetic Compatibility Criteria for Intentional Radiators	9
	§ 15.203 Antenna Requirement	10
	§ 15.207(a) Conducted Emissions Limits	11
	§ 15.247(a)(a) 6 dB and 99% Bandwidth	15
	§ 15.247(b) Peak Power Output.....	17
	§ 15.247(d) Radiated Spurious Emissions Requirements and Band Edge.....	20
	§ 15.247(d) RF Conducted Spurious Emissions Requirements and Band Edge.....	28
	§ 15.247(e) Peak Power Spectral Density.....	33
IV.	Test Equipment	35

List of Terms and Abbreviations

AC	Alternating Current
ACF	Antenna Correction Factor
Cal	Calibration
<i>d</i>	Measurement Distance
dB	Decibels
dB _μ A	Decibels above one microamp
dB _μ V	Decibels above one microvolt
dB _μ A/m	Decibels above one microamp per meter
dB _μ V/m	Decibels above one microvolt per meter
DC	Direct Current
E	Electric Field
DSL	Digital Subscriber Line
ESD	Electrostatic Discharge
EUT	Equipment Under Test
<i>f</i>	Frequency
FCC	Federal Communications Commission
GRP	Ground Reference Plane
H	Magnetic Field
HCP	Horizontal Coupling Plane
Hz	Hertz
IEC	International Electrotechnical Commission
kHz	kilohertz
kPa	kilopascal
kV	kilovolt
LISN	Line Impedance Stabilization Network
MHz	Megahertz
μH	microhenry
μ	microfarad
μs	microseconds
NEBS	Network Equipment-Building System
PRF	Pulse Repetition Frequency
RF	Radio Frequency
RMS	Root-Mean-Square
TWT	Traveling Wave Tube
V/m	Volts per meter
VCP	Vertical Coupling Plane

I. Executive Summary

A. Purpose of Test

An EMC Wireless evaluation was performed to determine compliance of the Enlighted, Inc SU-5i, with the requirements of Part 15, §15.247. All references are to the most current version of Title 47 of the Code of Federal Regulations in effect. In accordance with §2.1033, the following data is presented in support of the Certification of the SU-5i. Enlighted, Inc should retain a copy of this document which should be kept on file for at least two years after the manufacturing of the SU-5i, has been **permanently** discontinued.

B. Executive Summary

The following tests were conducted on a sample of the equipment for the purpose of demonstrating compliance with Part 15, §15.247, in accordance with Enlighted, Inc, purchase order number 0006277. All tests were conducted using measurement procedure ANSI C63.4-2014.

FCC Reference 47 CFR Part 15.247:2005	Description	Compliance
Title 47 of the CFR, Part 15 §15.203	Antenna Requirement	Compliant
Title 47 of the CFR, Part 15 §15.207(a)	Conducted Emission Limits	Compliant
Title 47 of the CFR, Part 15 §15.247(a)(2)	6dB Occupied Bandwidth	Compliant
Title 47 of the CFR, Part 15 §15.247(b)	Peak Power Output	Compliant
Title 47 of the CFR, Part 15 §15.247(d); §15.209; §15.205	Radiated Spurious Emissions Requirements	Compliant
Title 47 of the CFR, Part 15 §15.247(d)	RF Conducted Spurious Emissions Requirements	Compliant
Title 47 of the CFR, Part 15 §15.247(d)	RF Conducted Band Edge	Compliant
Title 47 of the CFR, Part 15; §15.247(e)	Peak Power Spectral Density	Compliant
Title 47 of the CFR, Part 15 §15.247(i)	Maximum Permissible Exposure (MPE)	Compliant

Table 1: Executive Summary of EMC Part 15.247 Compliance Testing

II. Equipment Configuration

A. Overview

Eurofins MET Laboratories, Inc. was contracted by Enlighted, Inc to perform testing on the SU-5i, under Enlighted, Inc’s purchase order number 0006277.

This document describes the test setups, test methods, required test equipment, and the test limit criteria used to perform compliance testing of the Enlighted, Inc, SU-5i.

The results obtained relate only to the item(s) tested.

Model(s) Tested:	SU-5i	
Model(s) Covered:	SU-5i	
EUT Specifications:	Primary Power: 5 VDC	
	FCC ID: AQQ-SU5I	
	Type of Modulations:	GFSK
	Equipment Code:	DTS
	Peak RF Output Power:	4.038 dBm
	EUT Frequency Ranges:	2402 – 2480 MHz
Analysis:	The results obtained relate only to the item(s) tested.	
Environmental Test Conditions:	Temperature: 15-35° C	
	Relative Humidity: 30-60%	
	Barometric Pressure: 860-1060 mbar	
Evaluated by:	Arsalan Hasan	
Report Date(s):	July 31, 2020	

Table 2: EUT Summary Table

B. References

CFR 47, Part 15, Subpart C	Federal Communication Commission, Code of Federal Regulations, Title 47, Part 15: General Rules and Regulations, Allocation, Assignment, and Use of Radio Frequencies
ANSI C63.4:2014	Methods and Measurements of Radio-Noise Emissions from Low-Voltage Electrical And Electronic Equipment in the Range of 9 kHz to 40 GHz
ISO/IEC 17025:2005	General Requirements for the Competence of Testing and Calibration Laboratories
ANSI C63.10-2013	American National Standard for Testing Unlicensed Wireless Devices

Table 3: References

C. Test Site

All testing was performed at Eurofins MET Labs, 3162 Belick St., Santa Clara, CA 95054. All equipment used in making physical determinations is accurate and bears recent traceability to the National Institute of Standards and Technology.

Eurofins MET Labs is a ISO/IEC 17025 accredited site by A2LA, California #0591.02.

D. Measurement Uncertainty

Test Method	Typical Expanded Uncertainty	K	Confidence Level
RF Frequencies	±4.52 Hz	2	95%
RF Power Conducted Emissions	±2.32 dB	2	95%
RF Power Conducted Spurious Emissions	±2.25 dB	2	95%
RF Power Radiated Emissions	±3.01 dB	2	95%

Table 4. Measurement Uncertainty

E. Description of Test Sample

The Enlighted, Inc SU-5i, Equipment Under Test (EUT), is a desk occupancy sensor placed under each open-office workspace detects when the desk is in use, providing real-time desk availability information. It has an embedded BLE radio that transmits and receives beacons. It has an 802.15.4 radio that works with secured Enlighted wireless network with AES-128 encryption delivering secure, reliable communication by sensing low-traffic channels and transmitting in bursts. It has a digital Passive Infrared (PIR) sensor that supports precise motion identification while minimizing false detection events

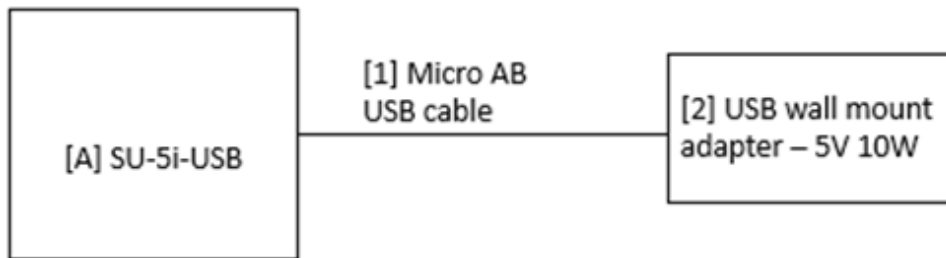

Figure 1: Block Diagram of Test Configuration

F. Equipment Configuration

The EUT was set up as outlined in Figure , Block Diagram of Test Setup. All cards, racks, etc., incorporated as part of the EUT is included in the following list.

Ref. ID	Slot #	Name / Description	Model Number	Part Number	Serial Number	Rev. #
A		Desk sensor	SU-5i-USB			

Table 5: Equipment Configuration

G. Support Equipment

Support equipment necessary for the operation and testing of the EUT is included in the following list.

Ref. ID	Name / Description	Manufacturer	Model Number	*Customer Supplied Calibration Data
	Laptop	Dell	Latitude 7480	NA

Table 6: Support Equipment

H. Ports and Cabling Information

Ref. ID	Port name on EUT	Cable Description or reason for no cable	Qty	Length as tested (m)	Max Length (m)	Shielded? (Y/N)	Termination Box ID & Port Name
1	USB	Micro USB A B type	1				
2	supply	USB Wall mount adapter	1				

Table 7: Ports and Cabling Information

I. Mode of Operation During Testing

Continuous transmit mode – Specific commands can be sent to the device using which we select the radio to transmit (BLE or 802.15.4), select the channel and power level at which the radio transmits. This will be the worst case condition.

Modulated signal mode – For specific test cases that involves to set the device to transmit in modulated signal, test commands have been provided that can be sent to put the radio (BLE or 15.4) in the respective modulated signal mode.

Normal operating mode – In normal circumstances the device will detect motion and transmit the information to other Enlighted sensors and Enlighted Gateway through 802.15.4. It will send BLE beaconing to other Enlighted sensors and Enlighted Room Control (wall switch) to listen for commands. The 15.4 and BLE beaconing transmissions lasts for not more than 50ms for every burst.

NOTE: The device worst case mode for emissions will be in continuous transmit mode. Modulated signal mode commands are expected to be used only for specific test cases that requests to test the modulated signal

EUT Software (internal to EUT): Enlighted Test Suite (ETS1.4.hex)
Support Software (used by support PC to exercise EUT): Tera term

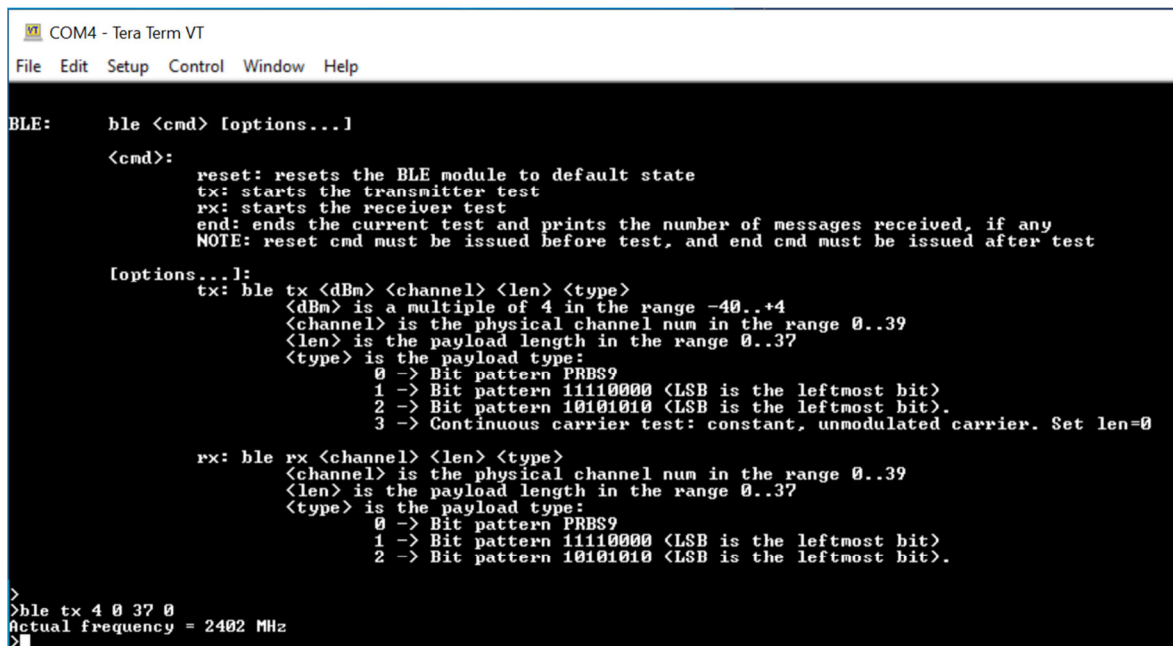

```

COM4 - Tera Term VT
File Edit Setup Control Window Help

BLE:   ble <cmd> [options...]

<cmd>:
  reset: resets the BLE module to default state
  tx: starts the transmitter test
  rx: starts the receiver test
  end: ends the current test and prints the number of messages received, if any
  NOTE: reset cmd must be issued before test, and end cmd must be issued after test

Options...:
  tx: ble tx <dBm> <channel> <len> <type>
      <dBm> is a multiple of 4 in the range -40..+4
      <channel> is the physical channel num in the range 0..39
      <len> is the payload length in the range 0..37
      <type> is the payload type:
          0 -> Bit pattern PRBS9
          1 -> Bit pattern 11110000 (LSB is the leftmost bit)
          2 -> Bit pattern 10101010 (LSB is the leftmost bit).
          3 -> Continuous carrier test: constant, unmodulated carrier. Set len=0

  rx: ble rx <channel> <len> <type>
      <channel> is the physical channel num in the range 0..39
      <len> is the payload length in the range 0..37
      <type> is the payload type:
          0 -> Bit pattern PRBS9
          1 -> Bit pattern 11110000 (LSB is the leftmost bit)
          2 -> Bit pattern 10101010 (LSB is the leftmost bit).

>
>ble tx 4 0 37 0
Actual frequency = 2402 MHz
>
  
```

Mode	Channel	Frequency	Test Software Setting
BLE	Low	2402	4
	Mid	2442	4
	High	2480	4

Table 8. Power setting used for BLE in the customer provided test software.

J. Method of Monitoring EUT Operation

The only way to check if the device is functioning will be to see if the device is still connected to the test laptop that is used for sending commands to set the device in a specific test condition. The LEDs will not show any indication.

K. Modifications**a) Modifications to EUT**

No modifications were made to the EUT.

b) Modifications to Test Standard

No modifications were made to the test standard.

L. Disposition of EUT

The test sample including all support equipment submitted to the Electro-Magnetic Compatibility Lab for testing was returned to Enlighted, Inc upon completion of testing.

III. Electromagnetic Compatibility Criteria for Intentional Radiators

Electromagnetic Compatibility Criteria for Intentional Radiators

§ 15.203 Antenna Requirement

Test Requirement: § 15.203: An intentional radiator shall be designed to ensure that no antenna other than that furnished by the responsible party shall be used with the device. The use of a permanently attached antenna or of an antenna that uses a unique coupling to the intentional radiator shall be considered sufficient to comply with the provisions of this section. The manufacturer may design the unit so that a broken antenna can be replaced by the user, but the use of a standard antenna jack or electrical connector is prohibited.

The structure and application of the EUT were analyzed to determine compliance with Section 15.203 of the Rules. Section 15.203 states that the subject device must meet at least one of the following criteria:

- a.) Antenna must be permanently attached to the unit.
- b.) Antenna must use a unique type of connector to attach to the EUT.
- c.) Unit must be professionally installed. Installer shall be responsible for verifying that the correct antenna is employed with the unit.

Results: The EUT **completed testing** to the criteria of §15.203.

Test Engineer: Arsalan Hasan

Test Date: March 25, 2020

EUT Model/Mode	Gain	Type	Manufacturer
SU-5i / BLE	2.4 dBi	IFA – PCB Trace Antenna	Enlighted Inc.

Table 9: Antenna Requirement, Antenna List

Electromagnetic Compatibility Criteria for Intentional Radiators

§ 15.207(a) Conducted Emissions Limits

Test Requirement(s): § 15.207 (a): For an intentional radiator that is designed to be connected to the public utility (AC) power line, the radio frequency voltage that is conducted back onto the AC power line on any frequency or frequencies, within the band 150 kHz to 30MHz, shall not exceed the limits in the following table, as measured using a 50 μ H/50 Σ line impedance stabilization network (LISN). Compliance with the provisions of this paragraph shall be based on the measurement of the radio frequency voltage between each power line and ground at the power terminal. The lower limit applies at the boundary between the frequency ranges.

Frequency range (MHz)	§ 15.207(a), Conducted Limit (dB μ V)	
	Quasi-Peak	Average
* 0.15- 0.45	66 - 56	56 - 46
0.45 - 0.5	56	46
0.5 - 30	60	50

Table 10: Conducted Limits for Intentional Radiators from FCC Part 15 § 15.207(a)

Test Procedure: The EUT was placed on a 0.8 m-high wooden table inside a screen room. The EUT was situated such that the back of the EUT was 0.4 m from one wall of the vertical ground plane, and the remaining sides of the EUT were no closer than 0.8 m from any other conductive surface. The EUT was powered from a 50 Ω /50 μ H Line Impedance Stabilization Network (LISN). The EMC receiver scanned the frequency range from 150 kHz to 30 MHz. Conducted Emissions measurements were made in accordance with *ANSI C63.4-2014 "Methods and Measurements of Radio-Noise Emissions from Low-Voltage Electrical and Electronic Equipment in the Range of 9kHz to 40 GHz"*. The measurements were performed over the frequency range of 0.15 MHz to 30 MHz using a 50 Ω /50 μ H LISN as the input transducer to an EMC/field intensity meter. For the purpose of this testing, the transmitter was turned on. Scans were performed with the transmitter on.

Test Results: The EUT **completed testing** to this requirement. Measured emissions were below applicable limits.

Test Engineer: Arsalan Hasan

Test Date: May 4, 2020

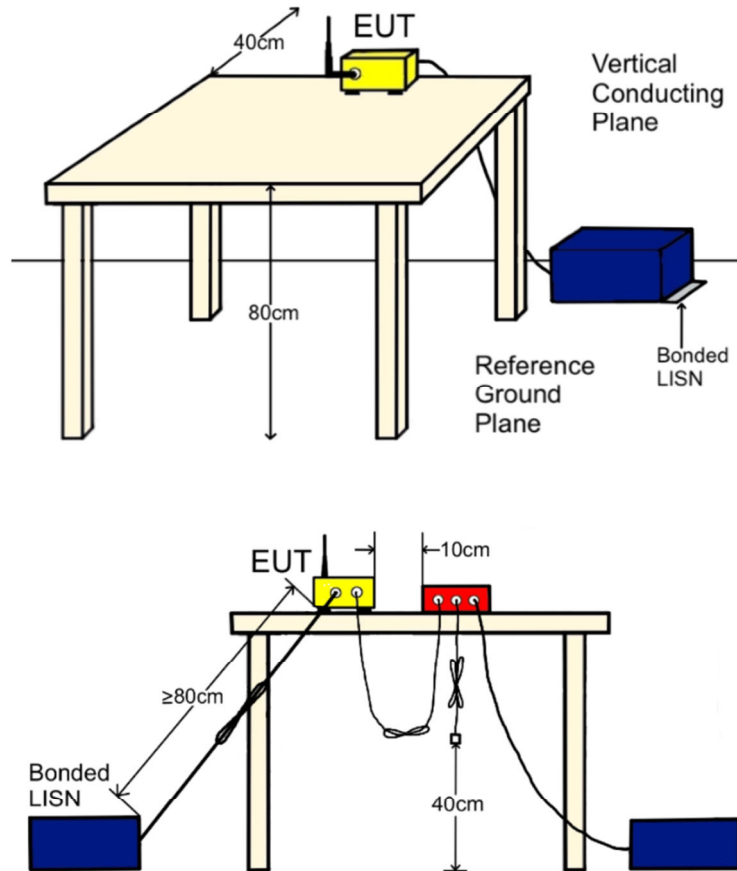
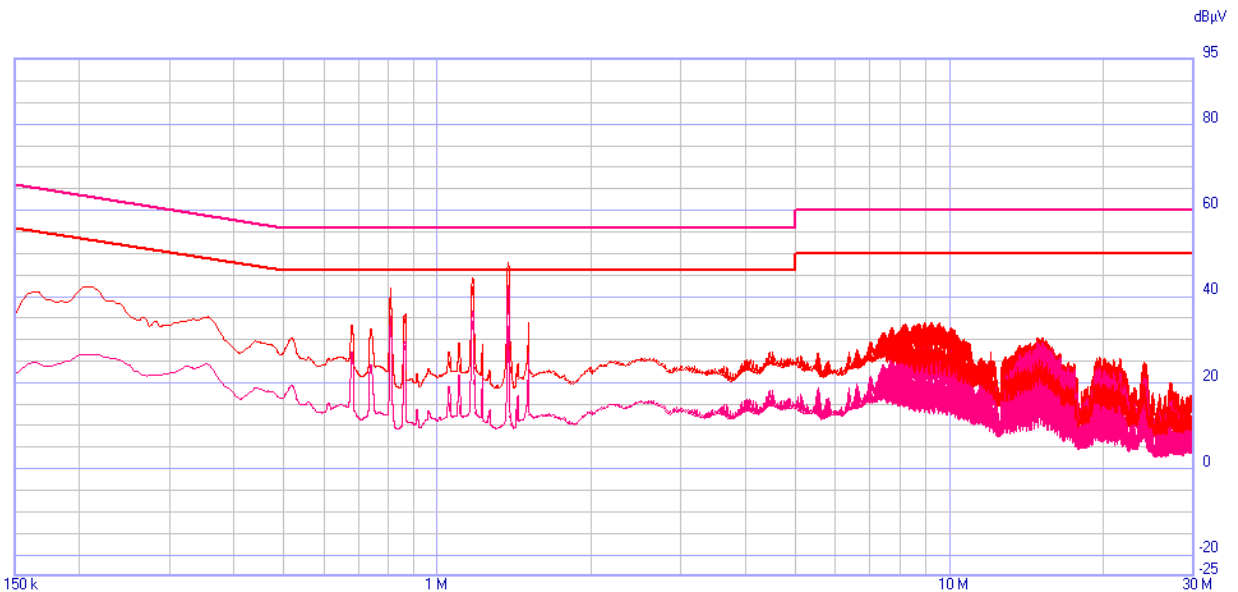

Figure 2: Conducted Emissions Voltage, Test Setup

LISN Ground Connection	VCP Ground Connection (<2.5mΩ)
1.4mΩ	1.4mΩ

	Freq (MHz)	QP Amplitude	QP Limit	Delta	Pass	Average Amplitude	Average Limit	Delta	Pass
Line	0.152045	39.33	65.888	-26.558	Pass	23.4	55.888	-32.488	Pass
Line	0.205215	50.51	63.404	-12.894	Pass	25.84	53.404	-27.564	Pass
Line	0.810535	43.25	56	-12.75	Pass	35.76	46	-10.24	Pass
Line	0.859615	37.86	56	-18.14	Pass	29.97	46	-16.03	Pass
Line	1.170455	45.5	56	-10.5	Pass	37.05	46	-8.95	Pass
Line	1.370865	46.85	56	-9.15	Pass	40.87	46	-5.13	Pass

Table 11: Conducted Emissions Limits, Line, Test Data



107425 Enlighted SU-5i BLE - Line

	Start [MHz]	Stop [MHz]	Step	Detector	Hold Time	RBW	Min Att	Pre Amp	Pre Sel	Prompt start	Ancillary
1	0.15	30	AUTO (2.045 kHz)	P Q A Q22av-b Margin 0 dB	500 ms	9 kHz	0	OFF	ON

Pulse Limiter ON
Ancillary = General

Limits:

Q22av-b
Q22qp-b

Plot 1: Conducted Emissions Limits, Line

	Freq (MHz)	QP Amplitude	QP Limit	Delta	Pass	Average Amplitude	Average Limit	Delta	Pass
Neutral	0.20726	37.7	63.322	-25.622	Pass	16.19	53.322	-37.132	Pass
Neutral	0.810535	36.09	56	-19.91	Pass	20.06	46	-25.94	Pass
Neutral	0.86166	30.74	56	-25.26	Pass	16.73	46	-29.27	Pass
Neutral	1.170455	38.77	56	-17.23	Pass	22.41	46	-23.59	Pass
Neutral	1.370865	42.56	56	-13.44	Pass	27.13	46	-18.87	Pass
Neutral	15.04373	30.63	60	-29.37	Pass	24.3	50	-25.7	Pass

Table 12: Conducted Emissions Limits, Neutral, Test Data

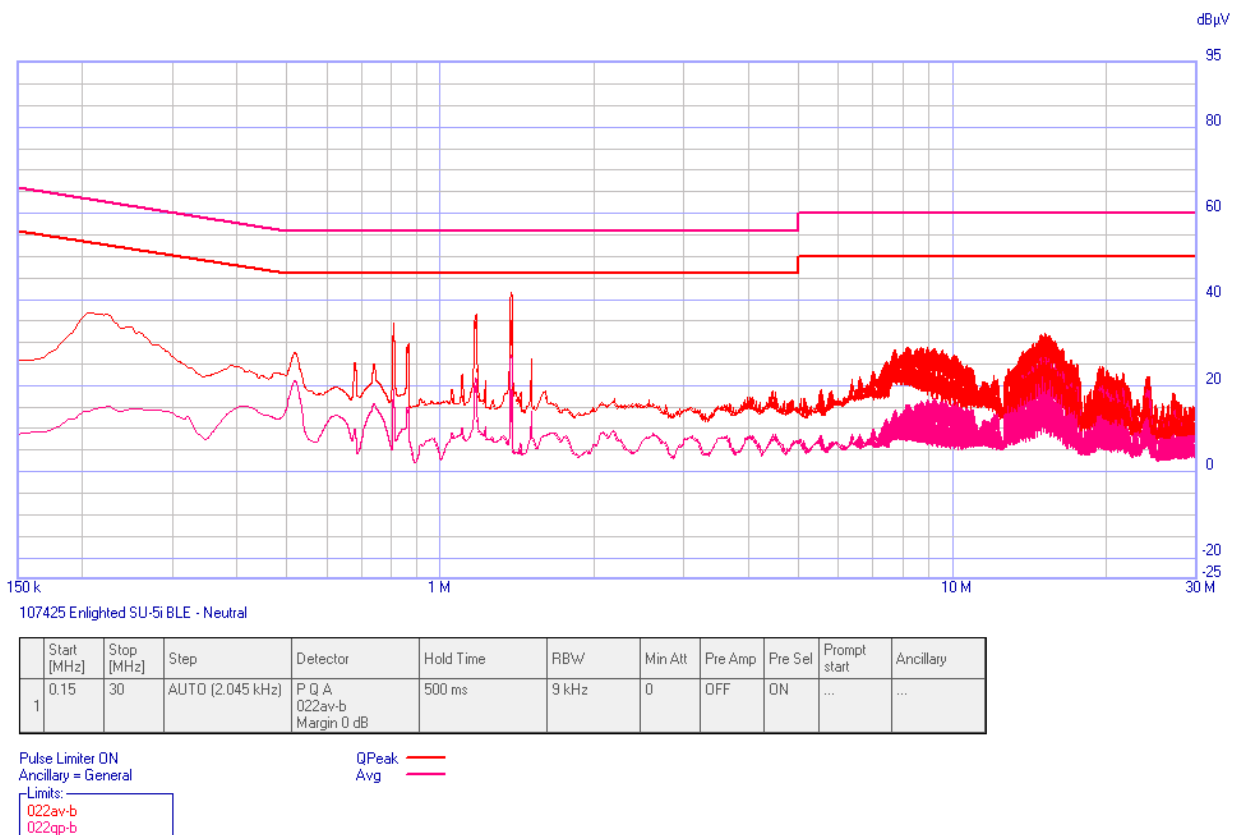

Plot 2: Conducted Emissions Limits, Neutral, Prescan

Electromagnetic Compatibility Criteria for Intentional Radiators

§ 15.247(a)(2) 6 dB Bandwidth

Test Requirements: § 15.247(a)(2): Operation under the provisions of this section is limited to frequency hopping and digitally modulated intentional radiators that comply with the following provisions:

For systems using digital modulation techniques, the EUT may operate in the 902-928 MHz, 2400-2483.5 MHz and 5725-5850 MHz bands. The minimum 6dB bandwidth shall be at least 500 kHz.

Test Procedure: The transmitter was on and transmitting at the highest output power. The bandwidth of the fundamental frequency was measured with the spectrum analyzer using an RBW approximately 1% of the total emission bandwidth, VBW > RBW. The 6 dB Bandwidth was measured and recorded. The measurements were performed on the low, mid and high channels.

Test Results The EUT **completed testing** to the requirements of § 15.247 (a)(2). No anomalies noted.

The 6 dB Bandwidth was determined from the plots on the following pages.

Test Engineer: Arsalan Hasan

Test Date: March 25, 2020

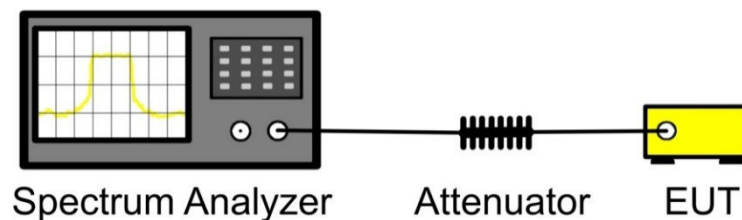
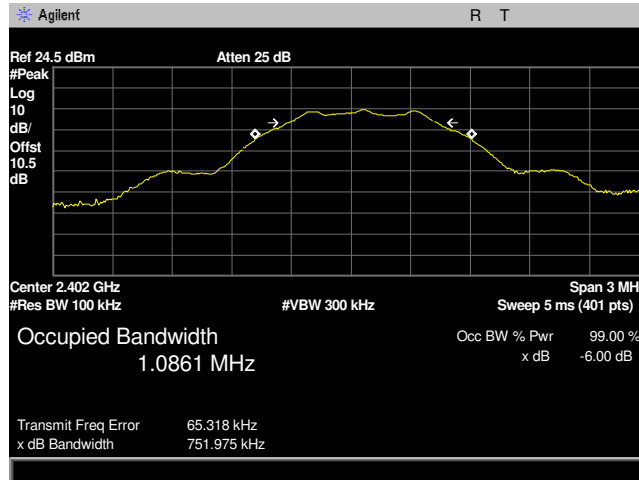

Figure 3: Block Diagram, Occupied Bandwidth Test Setup

Occupied Bandwidth			
Carrier Channel	Frequency (MHz)	Measured 6 dB Bandwidth (KHz)	Limit (KHz)
Low	2402	751.975	≥500
Mid	2442	731.701	≥500
High	2480	745.629	≥500

Table 13: 6 dB Bandwidth, Test Data



Plot 3: 6 dB Bandwidth, 2402MHz Low Channel

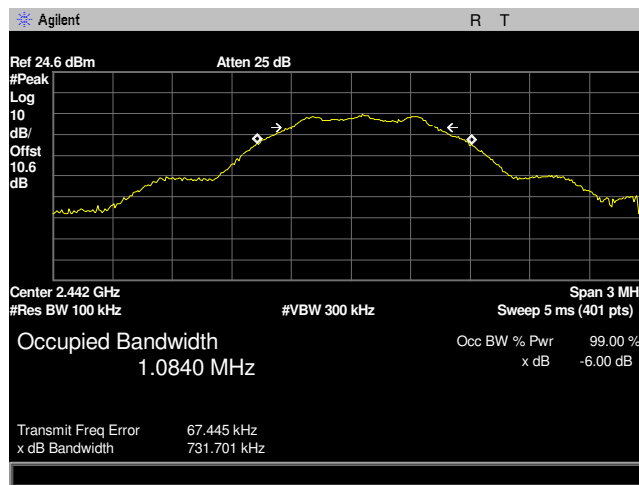

Plot 4: 6 dB Bandwidth, 2442MHz Mid Channel

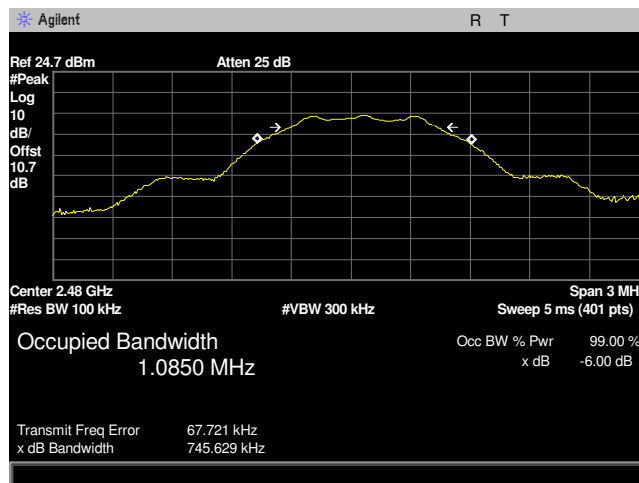

Plot 5: 6 dB Bandwidth, 2480MHz High Channel

Electromagnetic Compatibility Criteria for Intentional Radiators

§ 15.247(b) Peak Power Output

Test Requirements: §15.247(b): The maximum peak output power of the intentional radiator shall not exceed the following:

Digital Transmission Systems (MHz)	Output Limit (Watts)
902-928	1.000
2400-2483.5	1.000
5725- 5850	1.000

Table 14: Output Power Requirements from §15.247(b)

§15.247(c): if transmitting antennas of directional gain greater than 6 dBi are used the peak output power from the intentional radiator shall be reduced below the stated values in the Figure 21, as appropriate, by the amount in dB that the directional gain of the antenna exceeds 6 dBi.

Systems operating in the 2400 – 2483.5 MHz band and using a point to point application may employ transmitting antennas with directional gain greater than 6 dBi provided the maximum peak output power of the intentional radiator is reduced by 1 dB for every 3 dB that the directional gain of the antenna exceeds 6 dBi.

Systems operating in the 5725 – 5850 MHz band that are used exclusively for fixed, point-to-point operations may employ transmitting antennas with directional gain greater than 6 dBi without any corresponding reduction in transmitter peak output power.

Fixed, point-to-point operation excludes the use of point-to-multipoint systems, Omni-directional applications, and multiple co-located intentional radiators transmitting the same information. The operator of the spread spectrum intentional radiator or, if the equipment is professionally installed, the installer is responsible for ensuring that the system is used exclusively for fixed, point-to-point operations. The instruction manual furnished with the intentional radiator shall contain language in the installation instructions informing the operator and the installer of this responsibility.

Test Procedure: The transmitter was connected to a calibrated spectrum analyzer. The EUT was measured at the low, mid and high channels of each band at the maximum power level.

Test Results: The EUT **completed testing** to the requirements of §15.247(b). No anomalies noted.

Test Engineer: Arsalan Hasan

Test Date: April 19, 2020

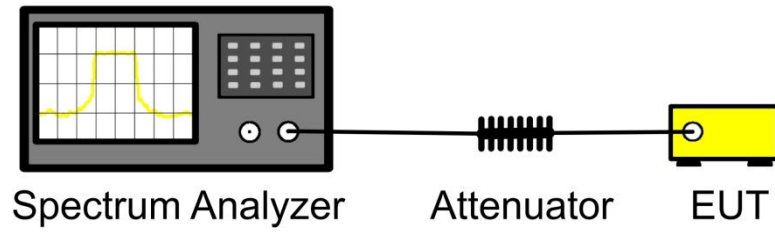
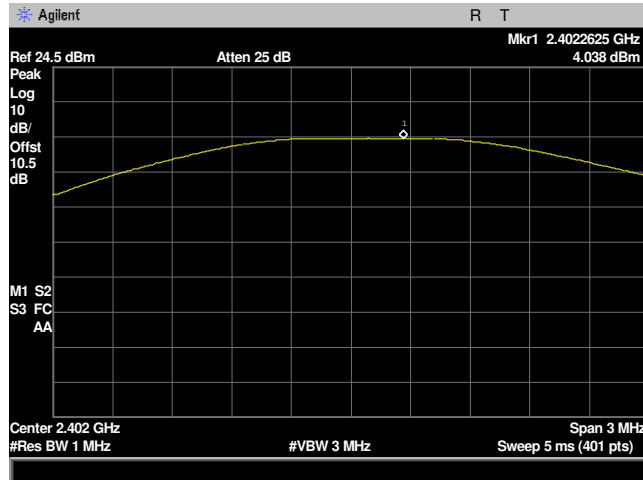

Figure 4: Peak Power Output Test Setup

Output Power			
Carrier Channel	Frequency (MHz)	Measured Conducted Power (dBm)	Limit (dBm)
Low	2402	4.038	≥30
Mid	2442	3.999	≥30
High	2480	4.012	≥30

Table 15: Peak Power Output, Test Data



Plot 6: Peak Power Output, 2402MHz Low Channel

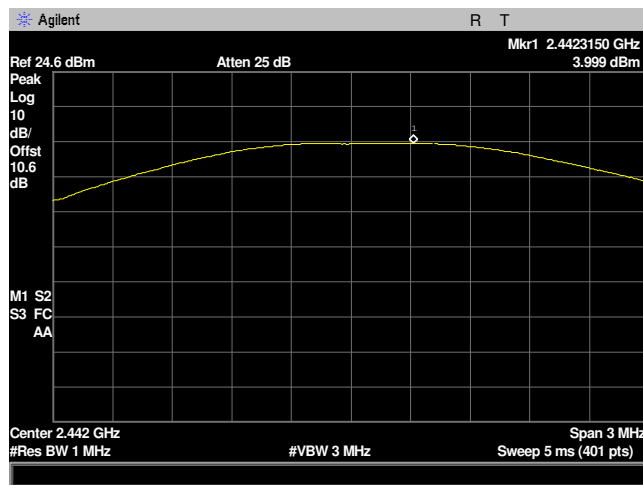

Plot 7: Peak Power Output, 2442MHz Mid Channel

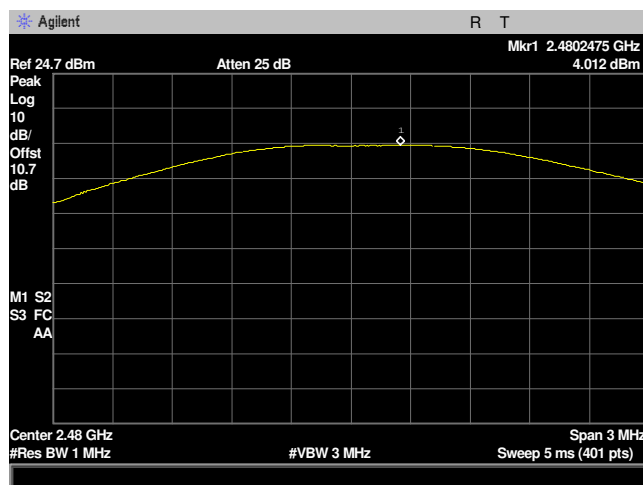

Plot 8: Peak Power Output, 2480MHz High Channel

Electromagnetic Compatibility Criteria for Intentional Radiators

§ 15.247(d) Radiated Spurious Emissions Requirements and Band Edge

Test Requirements: §15.247(d); §15.205: Emissions outside the frequency band.

§15.247(d): In any 100 kHz bandwidth outside the frequency band in which the spread spectrum or digitally modulated intentional radiator is operating, the radio frequency power that is produced by the intentional radiator shall be at least 20 dB below that in the 100 kHz bandwidth within the band that contains the highest level of the desired power, based on either an RF conducted or a radiated measurement. Attenuation below the general limits specified in § 15.209(a) is not required. In addition, radiated emissions which fall in the restricted bands, as defined in § 15.205(a), must also comply with the radiated emission limits specified in § 15.209(a).

§15.205(a): Except as shown in paragraph (d) of this section, only spurious emissions are permitted in any of the frequency bands listed below:

MHz	MHz	MHz	GHz
0.090–0.110-----	16.42–16.423	399.9–410	4.5–5.15
¹ 0.495–0.505-----	16.69475–16.69525	608–614	5.35–5.46
2.1735–2.1905-----	16.80425–16.80475	960–1240	7.25–7.75
4.125–4.128-----	25.5–25.67	1300–1427	8.025–8.5
4.17725–4.17775-----	37.5–38.25	1435–1626.5	9.0–9.2
4.20725–4.20775-----	73–74.6	1645.5–1646.5	9.3–9.5
6.215–6.218-----	74.8–75.2	1660–1710	10.6–12.7
6.26775–6.26825-----	108–121.94	1718.8–1722.2	13.25–13.4
6.31175–6.31225-----	123–138	2200–2300	14.47–14.5
8.291–8.294-----	149.9–150.05	2310–2390	15.35–16.2
8.362–8.366-----	156.52475–156.52525	2483.5–2500	17.7–21.4
8.37625–8.38675-----	156.7–156.9	2655–2900	22.01–23.12
8.41425–8.41475-----	162.0125–167.17	3260–3267	23.6–24.0
12.29–12.293-----	167.72–173.2	3332–3339	31.2–31.8
12.51975–12.52025-----	240–285	3345.8–3358 36.	43–36.5
12.57675–12.57725-----	322–335.4	3600–4400	(²)

Table 16: Restricted Bands of Operation

¹ Until February 1, 1999, this restricted band shall be 0.490 – 0.510 MHz.

² Above 38.6

Test Requirement(s): § 15.209 (a): Except as provided elsewhere in this subpart, the emissions from an intentional radiator shall not exceed the field strength levels specified in Table 17:

Frequency (MHz)	§ 15.209(a), Radiated Emission Limits (dBµV) @ 3m
30 - 88	40.00
88 - 216	43.50
216 - 960	46.00
Above 960	54.00

Table 17: Radiated Emissions Limits Calculated from FCC Part 15, § 15.209 (a)

Test Procedures: The transmitter was turned on. Measurements were performed of the low, mid and high Channels. The EUT was rotated orthogonally through all three axes. Plots shown are corrected for both antenna correction factor and distance and compared to a 3 m limit line. Only noise floor was measured below 30 MHz and above 18 GHz.

Test Results: The EUT **completed testing** to the requirements of § 15.247(d). No anomalies noted.

Test Engineer: Arsalan Hasan

Test Date: April 19, 2020

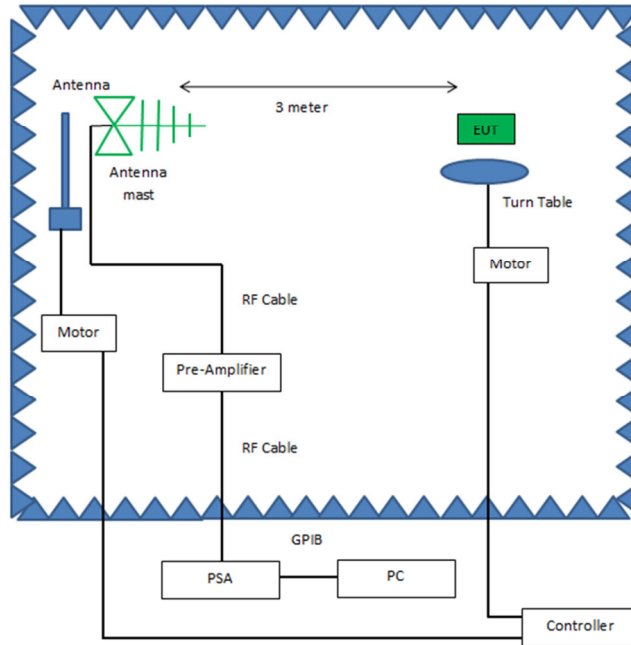

Figure 5: Radiated Emissions, Below 1GHz, Test Setup

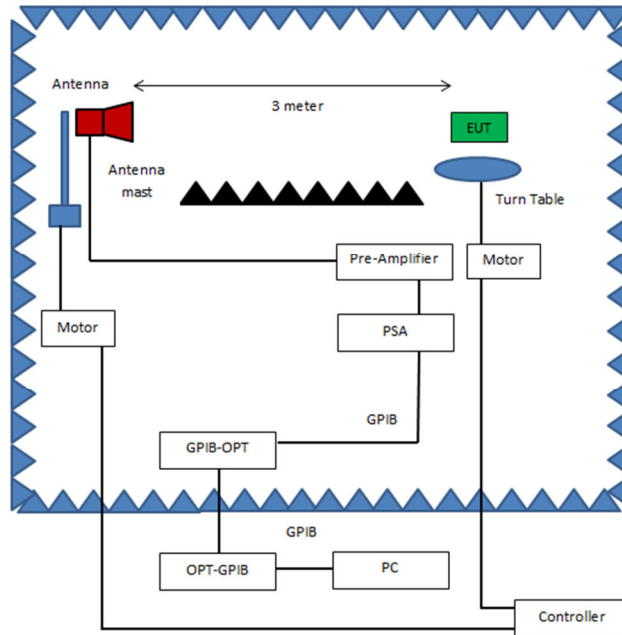
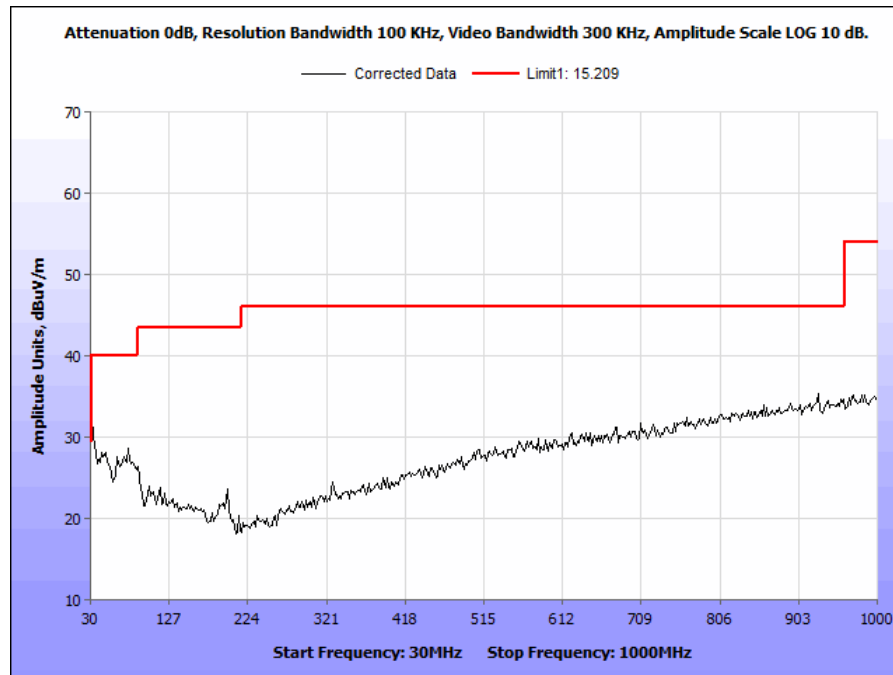

Figure 6: Radiated Emissions, Above 1GHz, Test Setup

Frequency (MHz)	EUT Azimuth (Degrees)	Antenna Polarity (H/V)	Antenna HEIGHT (m)	Uncorrected EMI Meter Reading (dBuV)	Antenna Correction Factor (dB/m) (+)	Cable Loss (dB) (+)	Distance Correction Factor (dB) (-)	Corrected Amplitude (dBuV/m)	Limit (dBuV/m)	Margin (dB)
62.36	157	V	1.2	19.67	7.83	1.40	0.00	28.90	40.00	-11.10
79.43	132	H	1.6	18.37	8.03	1.56	0.00	27.96	40.00	-12.04
421.78	186	V	1.1	8.56	15.68	2.37	0.00	26.61	46.00	-19.39
721	241	V	1.8	9.23	16.25	2.96	0.00	28.44	46.00	-17.56
892	147	H	1	10.38	17.15	3.28	0.00	30.81	46.00	-15.19
930	295	V	1	11.38	17.94	3.86	0.00	33.18	46.00	-12.82

Table 18. Radiated Emissions Data 30MHz – 1GHz



Plot 7: Radiated Emissions, BLE, 30 MHz - 1 GHz, (worst case)

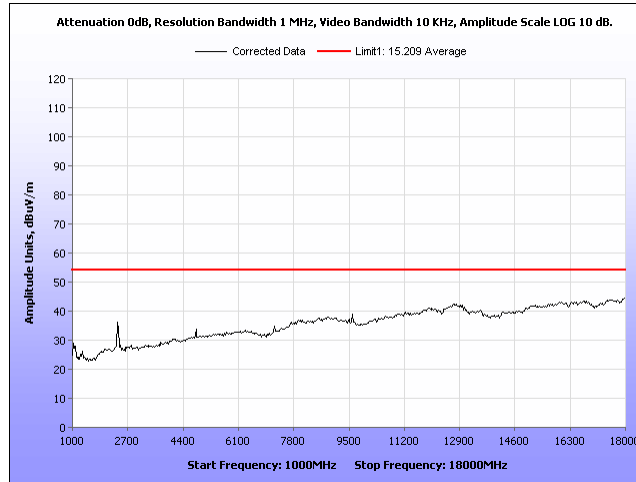

Plot 9: Radiated Spurious Emissions Requirements, Low Channel 2402MHz, Average

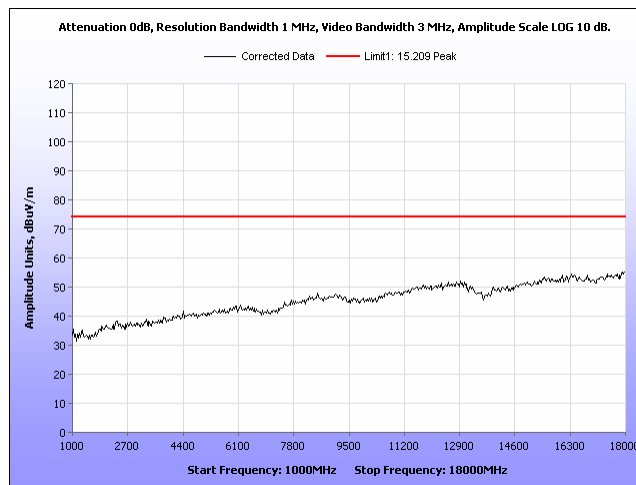

Plot 10: Radiated Spurious Emissions Requirements, Low Channel 2402MHz, Peak

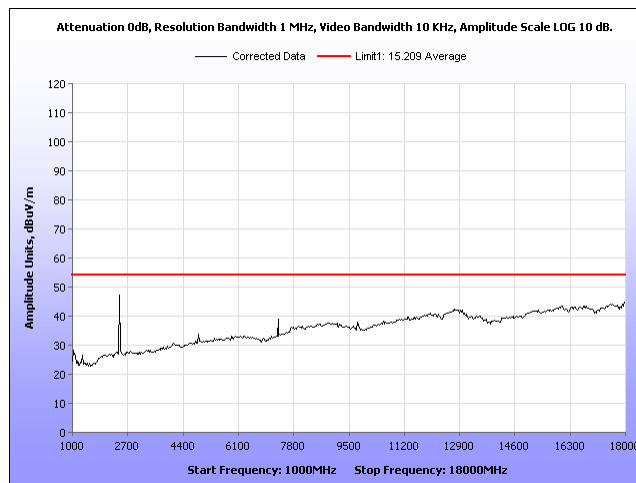

Plot 11: Radiated Spurious Emissions Requirements, Mid Channel 2442MHz, Average

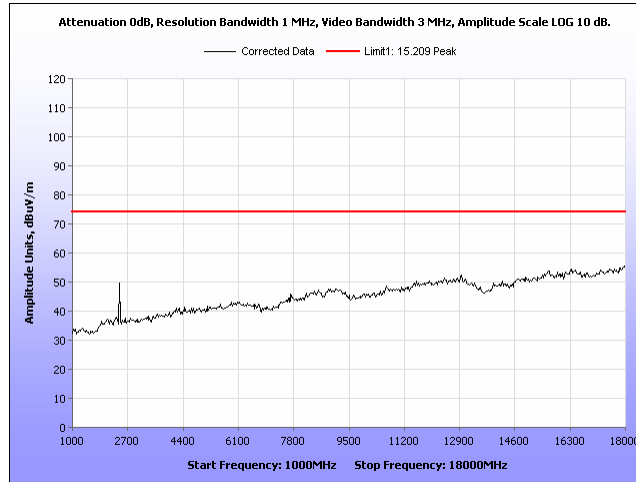

Plot 12: Radiated Spurious Emissions Requirements, Mid Channel 2442MHz, Peak

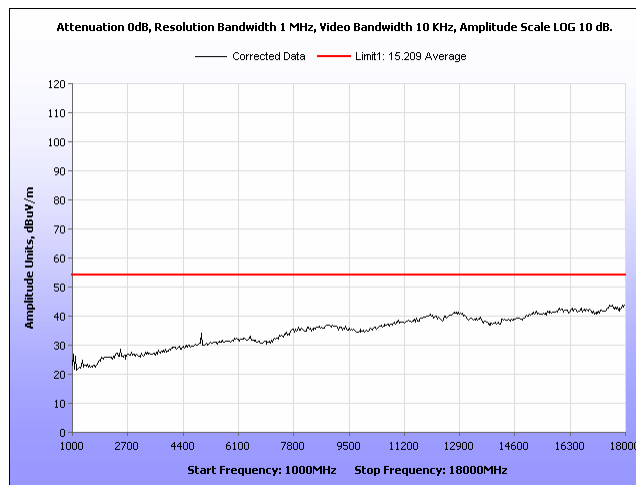

Plot 13: Radiated Spurious Emissions Requirements, High Channel 2480MHz, Average

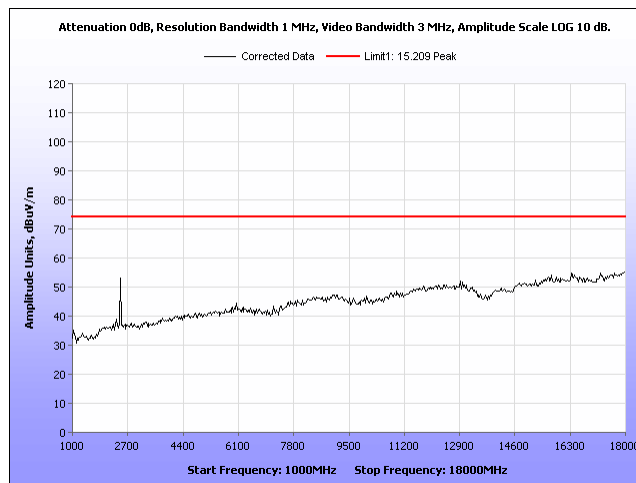

Plot 14: Radiated Spurious Emissions Requirements, High Channel 2480MHz, Peak

Radiated Band Edge Measurements

Test Procedures: The transmitter was turned on. Measurements were performed of the low, mid and high Channels. The EUT was rotated orthogonally through all three axes. Plots shown are corrected for both antenna correction factor and distance and compared to a 3 m limit line.

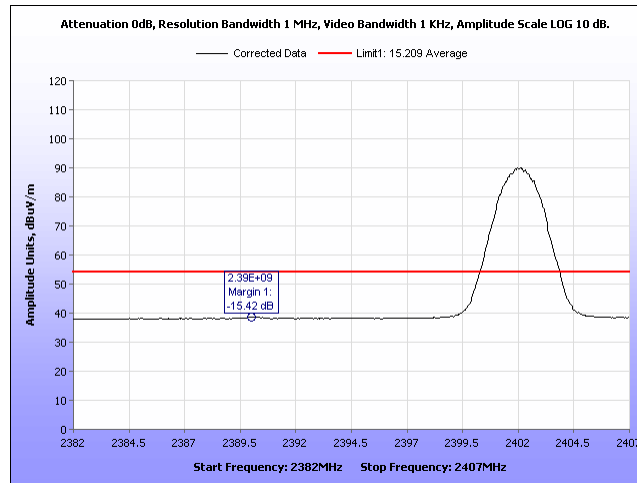

Plot 15: Radiated Band Edge, Low Channel 2402MHz, Average

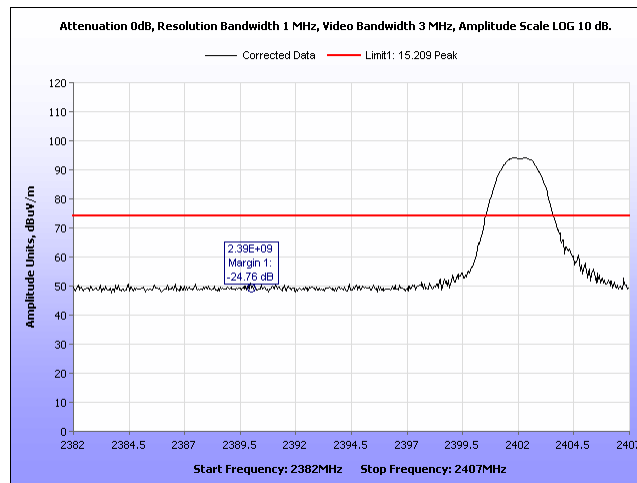

Plot 16: Radiated Band Edge, Low Channel 2402MHz, Peak

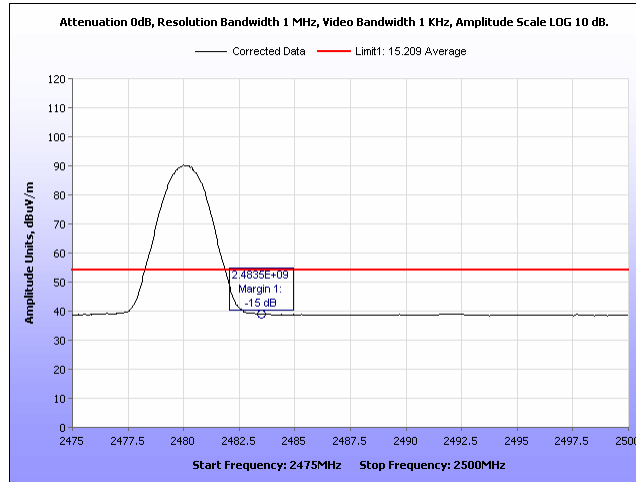

Plot 17: Radiated Band Edge, High Channel 2480MHz, Average

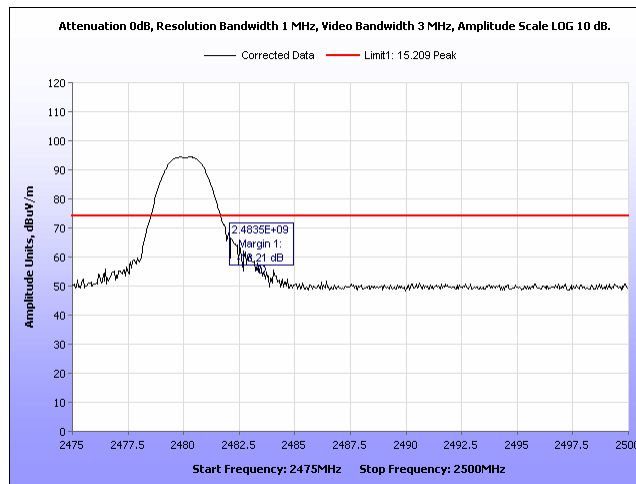

Plot 18: Radiated Band Edge, High Channel 2480MHz, Peak

Electromagnetic Compatibility Criteria for Intentional Radiators

§ 15.247(d) RF Conducted Spurious Emissions Requirements and Band Edge

Test Requirement: **15.247(d)** In any 100 kHz bandwidth outside the frequency band in which the spread spectrum or digitally modulated intentional radiator is operating, the radio frequency power that is produced by the intentional radiator shall be at least 20 dB below that in the 100 kHz bandwidth within the band that contains the highest level of the desired power, based on either an RF conducted or a radiated measurement, provided the transmitter demonstrates compliance with the peak conducted power limits. If the transmitter complies with the conducted power limits based on the use of RMS averaging over a time interval, as permitted under paragraph (b)(3) of this section, the attenuation required under this paragraph shall be 30 dB instead of 20 dB.

Test Procedure: For intentional radiators with a digital device portion which operates below 10 GHz, the spectrum was investigated as per §15.33(a)(1) and §15.33(a)(4); i.e., the lowest RF signal generated or used in the device up to the 10th harmonic of the highest fundamental frequency or to 40 GHz, whichever is lower.

Since the EUT had an integral antenna, conducted measurements could not be performed. Measurements needed to be taken radiated. An antenna was located 3 m away from the EUT and plots were taken. The EUT was rotated through all three orthogonal axes. The plots were corrected for both antenna correction factor and cable loss.

See following pages for detailed test results with RF Conducted Spurious Emissions.

Test Results: The EUT **completed testing** to the requirements of §15.247(d). No anomalies noted.

Test Engineer: Arsalan Hasan

Test Date: March 25, 2020

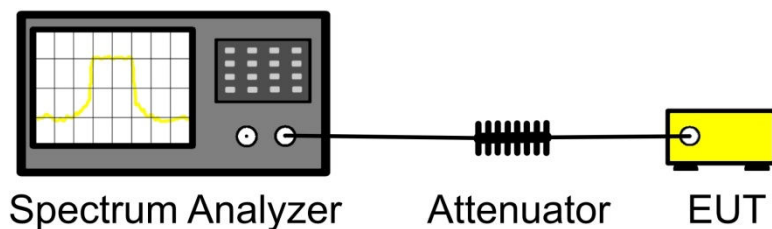
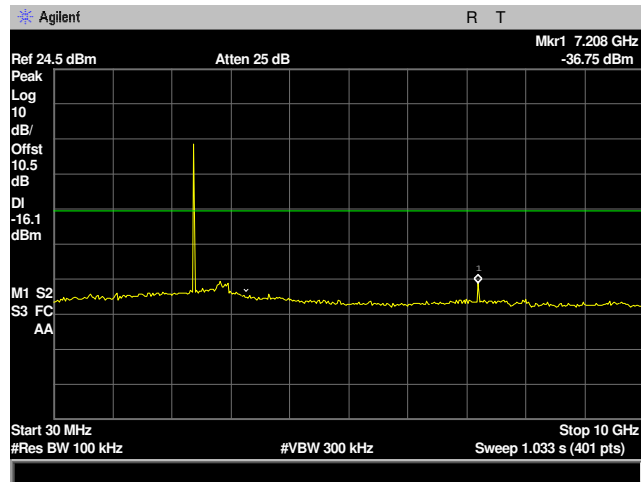
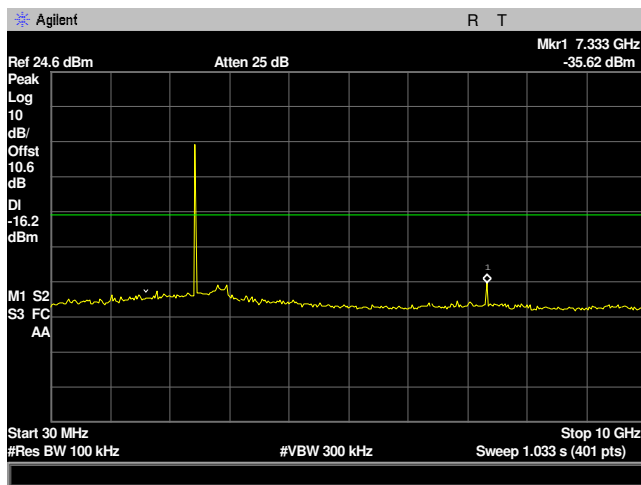

Figure 7: Block Diagram, Conducted Spurious Emissions Test Setup



Plot 19: RF Conducted Spurious Emissions Requirements, 30MHz-10GHz 2402MHz Low Channel



Plot 20: RF Conducted Spurious Emissions Requirements, 30MHz-10GHz 2442MHz Mid Channel

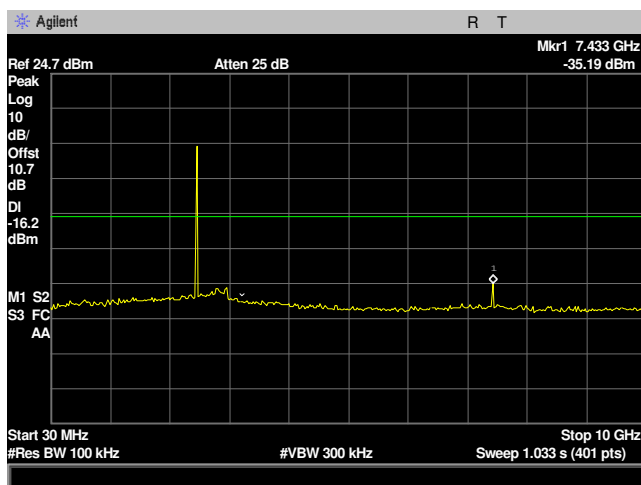

Plot 21: RF Conducted Spurious Emissions Requirements, 30MHz-10GHz 2480MHz High Channel

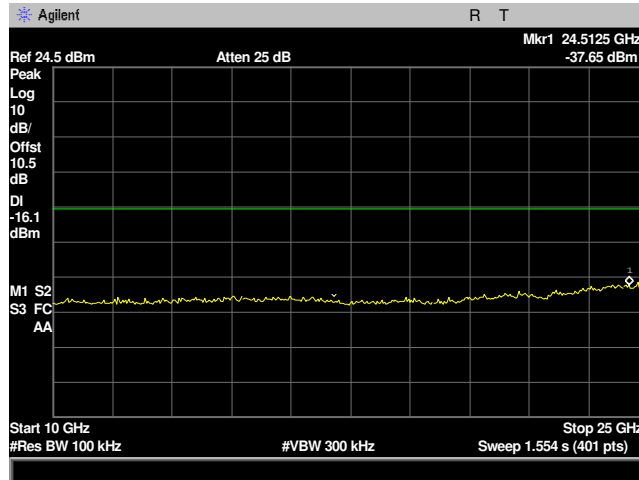

Plot 22: RF Conducted Spurious Emissions Requirements, 10GHz-25GHz 2402MHz Low Channel

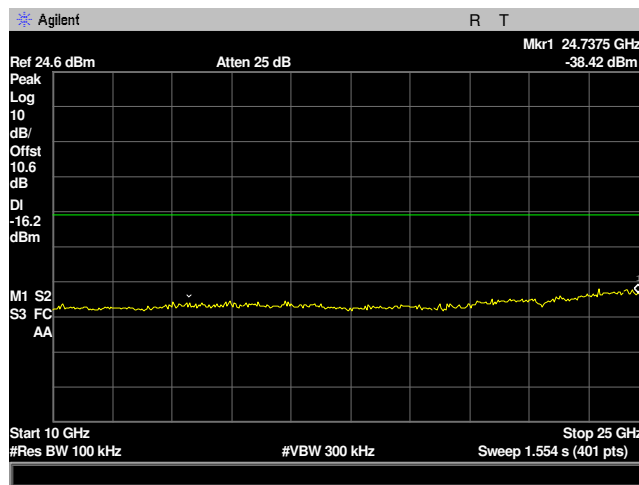

Plot 23: RF Conducted Spurious Emissions Requirements, 10GHz-25GHz 2442MHz Mid Channel

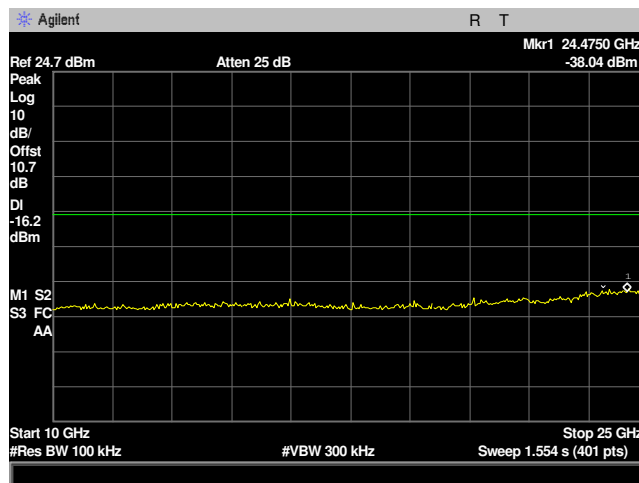

Plot 24: RF Conducted Spurious Emissions Requirements, 10GHz-25GHz 2480MHz High Channel

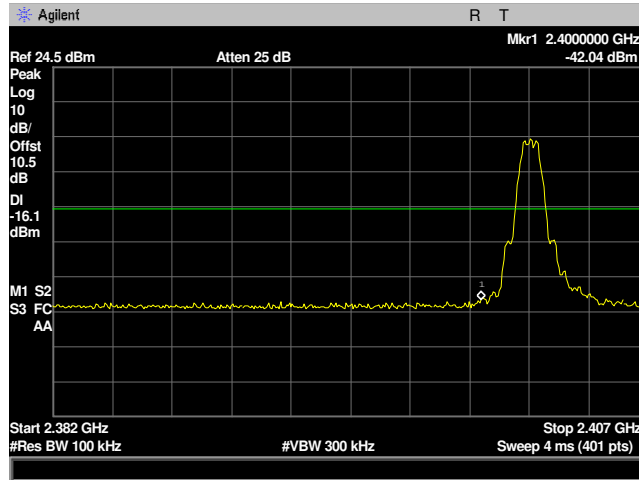

Plot 25: RF Conducted Band Edge, 2402MHz Low Channel

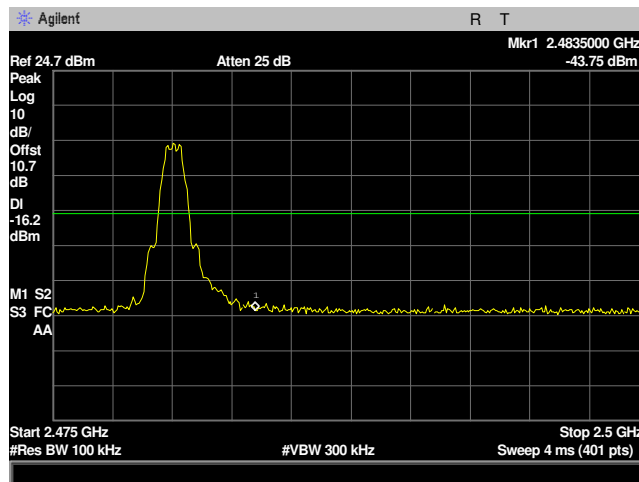

Plot 26: RF Conducted Band Edge, 2480MHz High Channel

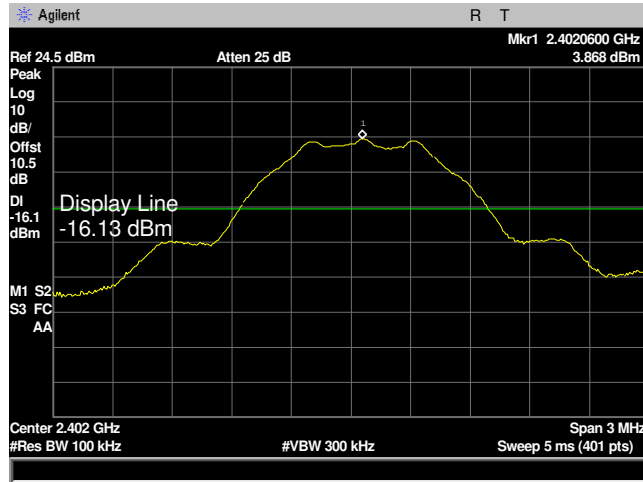

Plot 27: RF Conducted Band Edge, Reference Level 2402MHz Low Channel

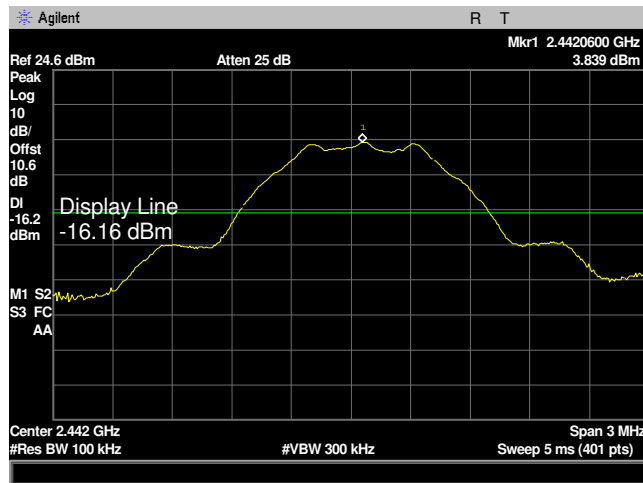

Plot 28: RF Conducted Band Edge, Reference Level 2442MHz Mid Channel

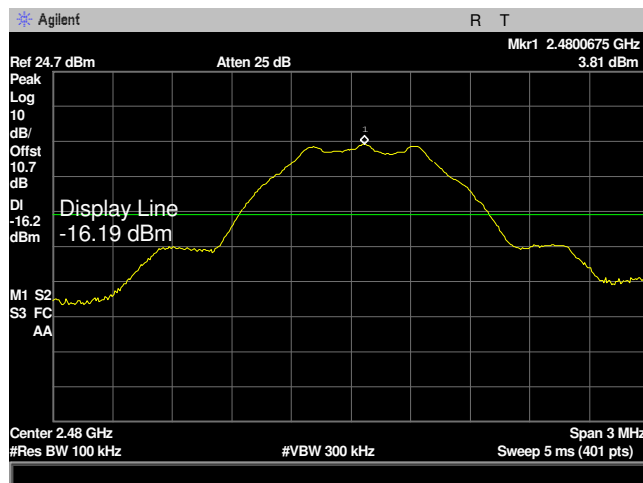

Plot 29: RF Conducted Band Edge, Reference Level 2480MHz High Channel

Electromagnetic Compatibility Criteria for Intentional Radiators

§ 15.247(e) Peak Power Spectral Density

Test Requirements: §15.247(e): For digitally modulated systems, the peak power spectral density conducted from the intentional radiator to the antenna shall not be greater than 8dBm in any 3 kHz band during any time interval of continuous transmission.

Test Procedure: The transmitter was connected directly to a Spectrum Analyzer through an attenuator. The power level was set to the maximum level throughout each of the 100 sweeps of power averaging. The RBW was set to 3 kHz and a VBW set to 9 kHz or greater. The spectrum analyzer was set to an auto sweep time and a peak detector was used. Measurements were carried out at the low, mid and high channels.

Test Results: The EUT **completed testing** to the requirements of § 15.247 (e). No anomalies noted.

The peak power spectral density was determined from plots on the following page(s).

Test Engineer: Arsalan Hasan

Test Date: March 25, 2020

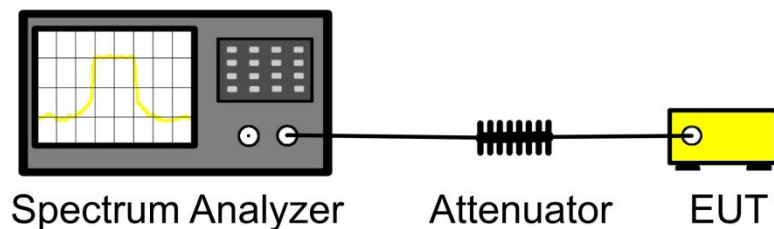
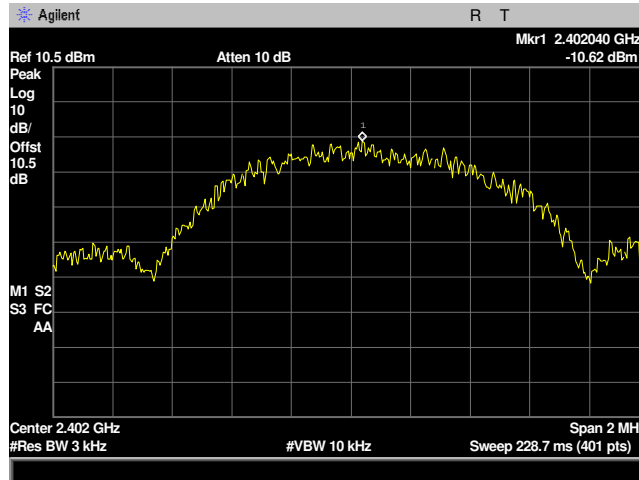

Figure 8: Block Diagram, Peak Power Spectral Density Test Setup

Power Spectral Density			
Carrier Channel	Frequency (MHz)	Measured Conducted Power (dBm)	Limit (dBm)
Low	2402	-10.62	8
Mid	2442	-10.65	8
High	2480	-10.81	8

Table 19: Peak Power Output, Test Data



Plot 30: Peak Power Spectral Density, 2402MHz Low Channel

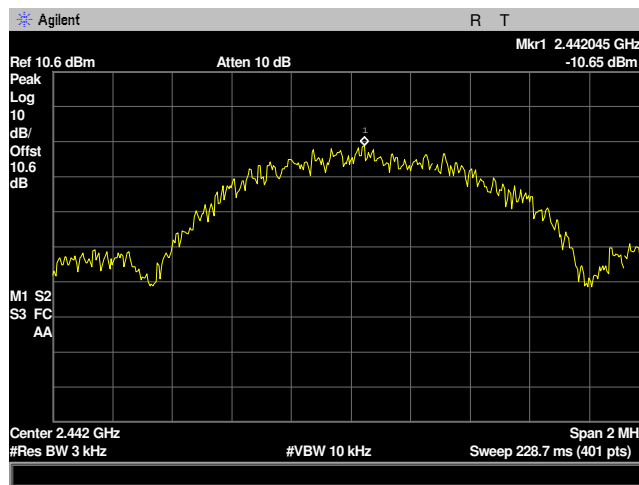

Plot 31: Peak Power Spectral Density, 2442MHz Mid Channel

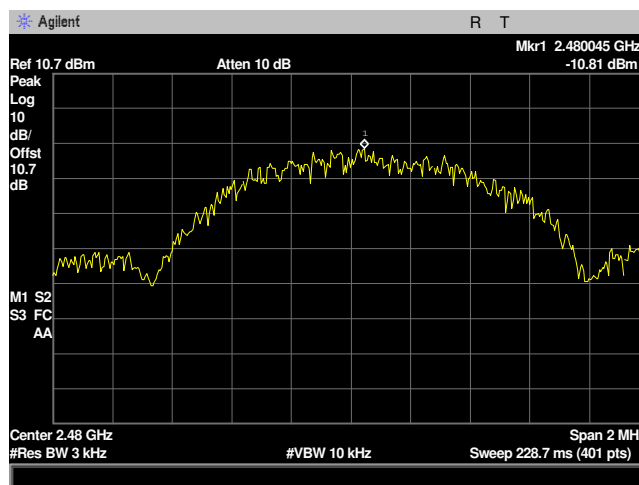

Plot 32: Peak Power Spectral Density, 2480MHz High Channel

IV. Test Equipment

Test Equipment

Calibrated test equipment utilized during testing was maintained in a current state of calibration per the requirements of ISO/IEC 17025:2017.

ASSET #	NOMENCLATURE	MANUFACTURER	MODEL	LAST CAL	CAL DUE
1S2399	TURNTABLE CONTROLLER	SUNOL SCIENCE	SC99V	FUNCTIONAL VERIFY	
1S3928	EMI TESTER RECEIVER	ROHDE & SCHWARZ	ESR26	03/04/2020	03/04/2021
1S2600	BILOG ANTENNA	TESEQ	CBL6112D	03/19/2019	03/19/2021
1S2486	5 METER CHAMBER CONTROL ROOM	PANASHIELD	5 METER CONTROL ROOM	FUNCTIONAL VERIFY	
1S3926	1MHZ STEP, 1GHZ COMBO GENERATOR	COM-POWER CORP	CGO-501	FUNCTIONAL VERIFY	
1S4067	DIGITAL BAROMETER	CONTROL CO	6530	06/22/2018	06/22/2020
1S2481	10 METER CHAMBER	ETS-LINGREN	DKE-8X8 DBL	FUNCTIONAL VERIFY	
1S406	DIGITAL BAROMETER	CONTROL CO	6530	6/22/2018	06/22/2020
1S380	EMI RECEIVER	NARDA SAFETY TEST SOLUTIONS	PMM 9010F	8/23/2019	8/23/2020
1S2678	LISN, DUAL LINE V-NETWORK	TESEQ	NNB 51	8/16/2019	8/16/2020
1S245	COMB GENERATOR (RADIATED)	COM-POWER	GG510	FUNCTIONAL VERIFY	
1S2599	LASER PROBE INTERFACE	AMPLIFIER RESEARCH	F1700	FUNCTIONAL VERIFY	
1S2603	DOUBLE RIDGED WAVEGUIDE HORN	ETS-LINDGREN	3117	09/18/2018	09/18/2020
1S2000	SPECTRUM ANALYZER	AGILENT	E4448A	11/06/2019	11/06/2020
1S3818	DRG HORN ANTENNA	A.H. SYSTEMS, INC	SAS-574	09/24/2018	09/24/2020

Table 20: Test Equipment List

Note: Functionally tested equipment is verified using calibrated instrumentation at the time of testing.

End of Report