

Report on the Radio Testing

For

Pektron Group Ltd

on

BTLE Node

Report no. TRA-051982-45-21B

28th February 2023

Report Number: TRA-051982-45-21B
Issue: B

REPORT ON THE RADIO TESTING OF A
Pektron Group Ltd
BTLE Node
WITH RESPECT TO SPECIFICATION
ISED RSS-210 Section 7 (Limited Testing Only) & FCC 47CFR 15.209 (Limited Testing Only)
TO SATISFY MODULAR INTEGRATION REQUIREMENTS OF
KDB 178919 D01 v06 and RSP-100, Issue 12

TEST DATE: 2023-01-11

Tested by: D Garvey

Written by: 

D Garvey
Radio Test Engineer

Approved by:

PP D Winstanley
Radio Senior Test Engineer

Date: 28th February 2023

Disclaimers:

- [1] THIS DOCUMENT MAY BE REPRODUCED ONLY IN ITS ENTIRETY AND WITHOUT CHANGE
[2] THE RESULTS CONTAINED IN THIS DOCUMENT RELATE ONLY TO THE ITEM(S) TESTED
-

1 Revision Record

<i>Issue Number</i>	<i>Issue Date</i>	<i>Revision History</i>
A	17 th January 2023	Original
B	28th February 2023	Updates after certification check

2 Summary

TEST REPORT NUMBER: TRA-051982-45-21B

WORKS ORDER NUMBER: TRA-051982-19

PURPOSE OF TEST: Class 2 Permissive Change

TEST SPECIFICATION: RSS-210 Section 7 (Limited Testing Only) & FCC
47CFR 15.209 (Limited Testing Only)

EQUIPMENT UNDER TEST (EUT): BTLE Node

ISED IDENTIFIER: 10176A-012

FCC IDENTIFIER: AQO012

EUT SERIAL NUMBER: BJ10024914

MANUFACTURER/AGENT: Pektron Group Ltd

ADDRESS: Alfreton Road
Derby
Derbyshire
DE21 4AP
United Kingdom

CLIENT CONTACT: Richard Jones
☎ 01332832424 ext 382
✉ rjones@pektron.co.uk

ORDER NUMBER: RJ/133/22

TEST DATE: 2023-01-11

TESTED BY: D Garvey
Element

2.1 Test Summary

Test Method and Description	Applicable to this equipment	Requirement Clause, 47CFR15	Result / Note	
	RSS			
Radiated spurious emissions, below 30 MHz	Gen, 8.9	15.209	<input checked="" type="checkbox"/>	Pass
Radiated spurious emissions	Gen, 8.9	15.209	<input checked="" type="checkbox"/>	Pass
AC power line conducted emissions	Gen, 8.8	15.207	<input type="checkbox"/>	Note 1
Occupied bandwidth	Gen, 6.7	15.215(c)	<input type="checkbox"/>	Note 1
Field strength of fundamental	Gen, 8.9	15.209	<input checked="" type="checkbox"/>	Pass

Specific Note:

1. Limited testing was performed to check transmitter radiated spurious emissions and output power only on a single channel and mode, as required by the client, to satisfy modular integration requirements of KDB 178919 D01 v06 and RSP-100.

General Notes:

The results contained in this report relate only to the items tested, in the condition at time of test, and were obtained in the period between the date of initial receipt of samples and the date of issue of the report.

The apparatus was set up and exercised using the configurations, modes of operation and arrangements defined in this report only. Any modifications made are identified in Section 8 of this report.

Particular operating modes, apparatus monitoring methods and performance criteria required by the standards tested to have been performed except where identified in Section 5.2 of this test report (Deviations from Test Standards).

3 Contents

1	Revision Record	3
2	Summary	4
2.1	Test Summary	5
3	Contents	6
4	Introduction	7
5	Test Specifications	8
5.1	Normative References	8
5.2	Deviations from Test Standards	8
6	Glossary of Terms	9
7	Equipment Under Test	10
7.1	EUT Identification	10
7.2	System Equipment	10
7.3	EUT Mode of Operation	10
7.4	EUT Radio Parameters	10
7.5	EUT Description	10
8	Modifications	11
9	EUT Test Setup	12
9.1	Block Diagram	12
9.2	General Set-up Photograph	13
9.3	Measurement software	13
10	General Technical Parameters	14
10.1	Normal Conditions	14
11	Radiated Emissions below 30 MHz	15
11.1	Definitions	15
11.2	Test Parameters	15
11.3	Test Method	16
11.4	Test Equipment	17
11.5	Test Results	18
12	Radiated Emissions	19
12.1	Definitions	19
12.2	Test Parameters	19
12.3	Test Method	20
12.4	Test Equipment	21
12.5	Test Results	21
13	Transmitter Output Power (Fundamental Radiated Emission)	22
13.1	Definition	22
13.2	Test Parameters	22
13.3	Test Method	23
13.4	Test Equipment	23
13.5	Test Results	24
14	Measurement Uncertainty	25
15	Customer Declaration	27

4 Introduction

This report TRA-051982-45-21B presents the results of the Radio testing on a Pektron Group Ltd, BTLE Node to specification 47CFR15 Radio Frequency Devices (Limited Testing) and RSS-210 Licence-exempt Radio Apparatus: Category I Equipment (Limited Testing).

The testing was carried out for Pektron Group Ltd by Element, at the address detailed below.

<input checked="" type="checkbox"/>	Element Hull Unit E South Orbital Trading Park Hedon Road Hull HU9 1NJ UK	<input type="checkbox"/>	Element Skelmersdale Unit 1 Pendle Place Skelmersdale West Lancashire WN8 9PN UK
-------------------------------------	---	--------------------------	--

This report details the configuration of the equipment, the test methods used and any relevant modifications where appropriate.

All test and measurement equipment under the control of the laboratory and requiring calibration is subject to an established programme and procedures to control and maintain measurement standards. The quality management system meets the principles of ISO 9001, and has quality control procedures for monitoring the validity of tests undertaken. Records and sufficient detail are retained to establish an audit trail of calibration records relating to its test results for a defined period. Under control of the established calibration programme, key quantities or values of the test & measurement instrumentation are within specification and comply with the relevant traceable internationally recognised and appropriate standard specifications, which are UKAS calibrated as such where these properties have a significant effect on results. Participation in inter-laboratory comparisons and proficiency testing ensures satisfactory correlation of results conform to Elements own procedures, as well as statistical techniques for analysis of test data providing the appropriate confidence in measurements.

FCC Site Listing:

The test laboratory is accredited for the above sites under the following US-UK MRA, Designation numbers.

Element Hull	UK2007
Element Skelmersdale	UK2020

ISED Registration Numbers:

Element Hull	3483A
Element North West	3930B

The test site requirements of ANSI C63.4-2014 are met up to 1 GHz.

The test site SVSWR requirements of CISPR 16-1-4:2010 are met over the frequency range 1 GHz to 18 GHz.

5 Test Specifications

5.1 Normative References

- FCC 47 CFR Ch. I – Part 15 – Radio Frequency Devices.
- ANSI C63.10-2013 – American National Standard of Procedures for Compliance Testing of Unlicensed Wireless Devices.
- ANSI C63.4-2014 – American National Standard for Methods of Measurement of Radio-Noise Emissions from Low-Voltage Electrical and Electronic Equipment in the Range of 9 kHz to 40 GHz.
- ISED RSS-210, Issue 10, December 2019 – Licence-exempt Radio Apparatus (All Frequency Bands): Category I Equipment.
- ISED RSS-Gen, Issue 5, March 2019 – General Requirements for Compliance of Radio Apparatus
- RSP-100, Issue 12, August 2019 – Certification of Radio Apparatus and Broadcasting Equipment.
- KDB178919 D01 Permissive Change Policy v06.

5.2 Deviations from Test Standards

Limited testing was performed to check transmitter radiated spurious emissions and output power only on a single channel and mode, as required by the client, to satisfy modular integration requirements of KDB 178919 D01 v06 and RSP-100.

6 Glossary of Terms

§	denotes a section reference from the standard, not this document
AC	Alternating Current
ANSI	American National Standards Institute
BW	bandwidth
C	Celsius
CFR	Code of Federal Regulations
CW	Continuous Wave
dB	decibel
dBm	dB relative to 1 milliwatt
DC	Direct Current
DSSS	Direct Sequence Spread Spectrum
EIRP	Equivalent Isotropically Radiated Power
ERP	Effective Radiated Power
EUT	Equipment Under Test
FCC	Federal Communications Commission
FHSS	Frequency Hopping Spread Spectrum
Hz	hertz
IC	Industry Canada (now ISED)
ISED	Innovation, Science and Economic Development Canada
ITU	International Telecommunication Union
LBT	Listen Before Talk
m	metre
max	maximum
MIMO	Multiple Input and Multiple Output
min	minimum
MRA	Mutual Recognition Agreement
N/A	Not Applicable
PCB	Printed Circuit Board
PDF	Portable Document Format
Pt-mpt	Point-to-multipoint
Pt-pt	Point-to-point
RF	Radio Frequency
RH	Relative Humidity
RMS	Root Mean Square
Rx	receiver
s	second
SVSWR	Site Voltage Standing Wave Ratio
Tx	transmitter
UKAS	United Kingdom Accreditation Service
V	volt
W	watt
Ω	ohm

7 Equipment Under Test

7.1 EUT Identification

- Name: BTLE Node
- Serial Number: BJ10024914
- Model Number: A-0819G13
- Software Revision: Bootloader: P0819B1.1.0 / Application: P0819A2.2.3
- Build Level / Revision Number: Production

7.2 System Equipment

Equipment listed below forms part of the overall test setup and is required for equipment functionality and/or monitoring during testing. The compliance levels achieved in this report relate only to the EUT and not items given in the following list.

Customer Laptop
Node Test Box
CAN Dongle

7.3 EUT Mode of Operation

The unit was connected via CAN to the laptop and commands, provided by the manufacturer, were sent to the EUT via software called CANoe. The unit was put into test mode transmitting a modulated signal at 125 kHz.

7.4 EUT Radio Parameters

Frequency of operation:	125 kHz
Modulation type:	ASK
Nominal Supply Voltage:	12 Vdc

7.5 EUT Description

The EUT is a BTLE node incorporating BTLE 2.4 GHz and LF 125 kHz radios, this test report only covers limited testing of the 125 kHz radio.

8 Modifications

No modifications were performed during this assessment.

9 EUT Test Setup

9.1 Block Diagram

The following diagram shows basic EUT interconnections:

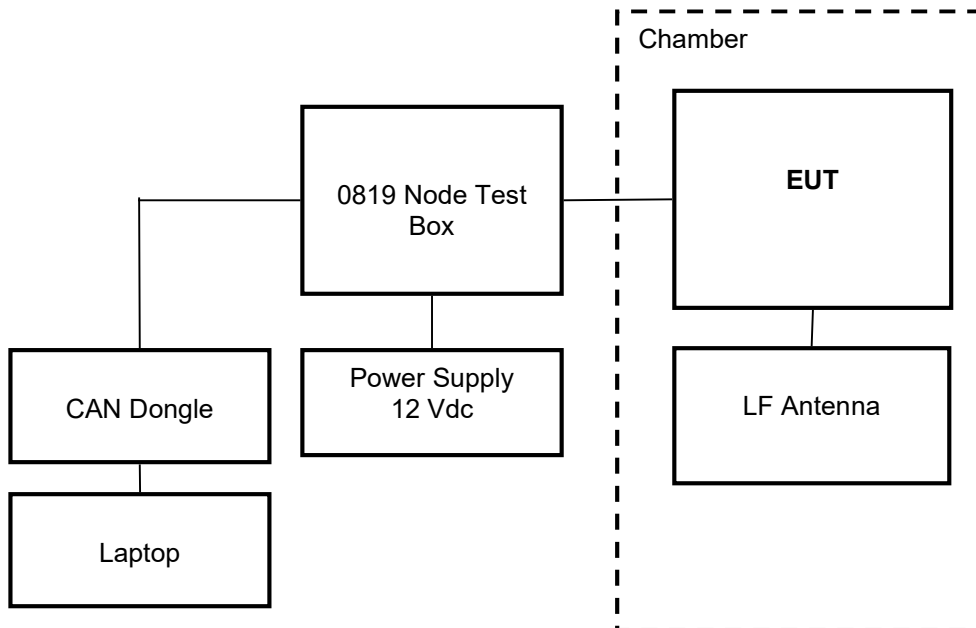

9.2 General Set-up Photograph

The following photograph shows basic EUT set-up:

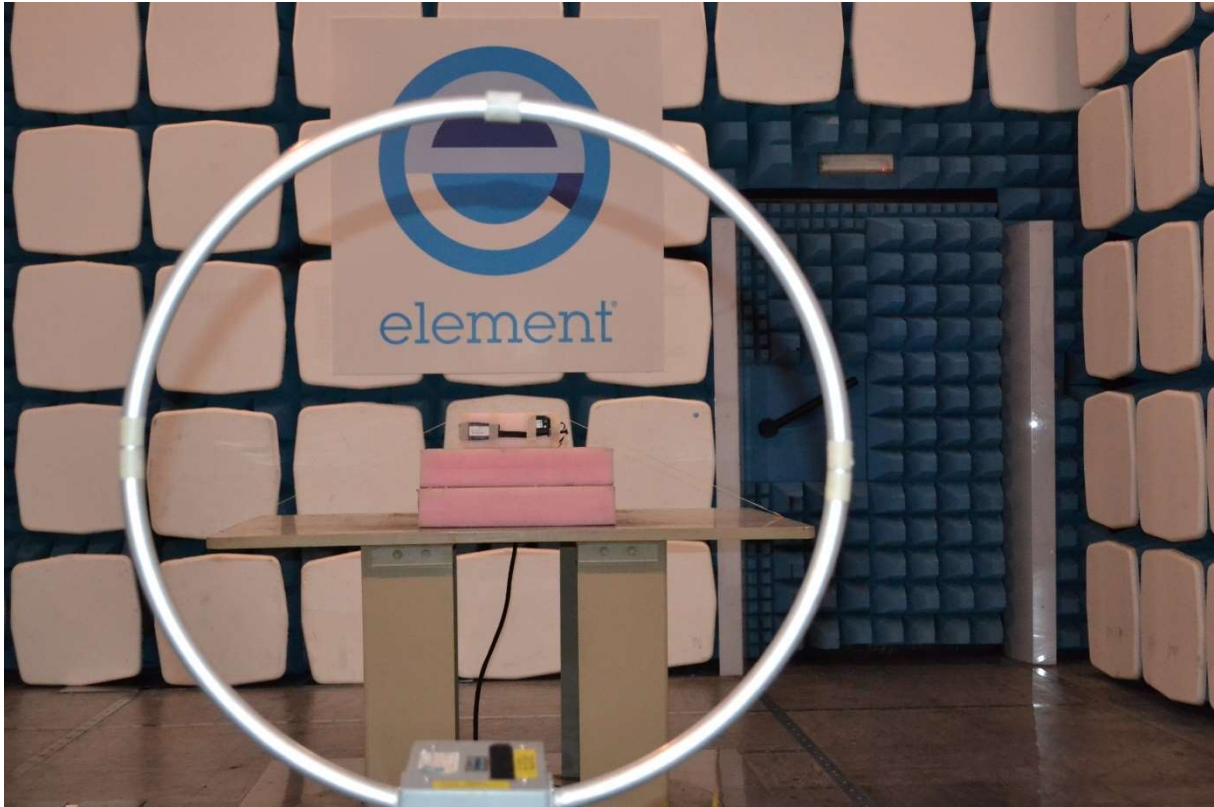

9.3 Measurement software

Where applicable, the following software was used to perform measurements contained within this report.

Element Emissions R5 (See Note)

Note:

The version of the Element software used is recorded in the results sheets contained within this report.

10 General Technical Parameters

10.1 Normal Conditions

The EUT was tested under the normal environmental conditions of the test laboratory, except where otherwise stated. The normal power source applied was 12 Vdc from an external power supply.

11 Radiated Emissions below 30 MHz

11.1 Definitions

Out-of-band emissions

Emissions on a frequency or frequencies immediately outside the necessary bandwidth which result from the modulation process, but exclude spurious emissions.

Spurious emissions

Emissions on a frequency or frequencies which are outside the necessary bandwidth and the level of which may be reduced without affecting the corresponding transmission of information. Spurious emissions include harmonic emissions, parasitic emissions, intermodulation products and frequency conversion products, but exclude out-of-band emissions.

Restricted bands

A frequency band in which intentional radiators are permitted to radiate only spurious emissions but not fundamental signals.

11.2 Test Parameters

Test Location:	Element Hull
Test Chamber:	Wireless Lab 2
Test Standard and Clause:	ANSI C63.10-2013, Clause 6.4
EUT Frequency Measured:	125 kHz
Deviations From Standard:	None
Measurement Distance and Site:	3 m, Chamber
EUT Height:	1 m
Measurement Antenna and Height:	60 cm shielded loop; 1 m
Measurement BW:	9 kHz to 150 kHz: 200 Hz; 150 kHz to 30 MHz: 9 kHz
Measurement Detector:	9 kHz to 90 kHz and 110 kHz to 490 kHz: Average, RMS Other frequencies below 30 MHz: Quasi-peak.

Environmental Conditions (Normal Environment)

Temperature: 21 °C	+15 °C to +35 °C (as declared)
Humidity: 42 %RH	20 %RH to 75 %RH (as declared)

Test Limit

Emissions from license-exempt transmitters shall comply with the field strength limits shown in the table below. Additionally, the level of any transmitter emission shall not exceed the level of the transmitter's fundamental emission.

General Field Strength Limits for License-Exempt Transmitters at Frequencies Below 30 MHz

<i>Frequency, f (kHz)</i>	<i>Field Strength</i>	<i>Measurement Distance (m)</i>
9 to 490	2,400 / 377.f (μA/m) 2,400 / f (μV/m)	300
490 to 1,750	24,000 / 377.f (μA/m) 24,000 / f (μV/m)	30
1,750 to 30,000	30 (μV/m)	30

n.b. Devices operated pursuant to §15.225 / RSS-210 A2.6 are exempt from complying with the restricted band requirements for the 13.36–13.41 MHz band only.

11.3 Test Method

With the EUT setup as per section 9 of this report and connected as per Figure i, the EUT fundamental frequency was maximised by rotating the EUT through 360°, in three orthogonal planes, and adjusting the measurement antenna azimuth.

Radiated electromagnetic emissions from the EUT are checked first by preview scans. Preview scans for all spectrum and modulation characteristics are checked, using a peak detector and where applicable worst-case determined for function, operation, orientation, etc. for both vertical and horizontal polarisations. Pre-scan plots are shown with a peak detector and 9 kHz RBW.

If the EUT connects to auxiliary equipment and is table or floor standing, the configurations prescribed in ANSI C63.10 are followed. Alternatively, a layout closest to normal use (as declared by the provider) is employed, (see EUT setup photographs for more detail).

Emissions between 9 kHz and 30 MHz are measured using a calibrated 60cm active loop antenna. Pre-amplifiers and filters are used where required. Care is taken to ensure that test receiver resolution bandwidth, video bandwidth and detector type(s) meet the regulatory requirements.

Power values measured on the test receiver / analyzer are converted to field strength, FS, in μV/m at the regulatory distance, using:

$$FS = 10 (PR - CF) / 20$$

Where,

PR is the power recorded on the receiver / spectrum analyzer in dBμV and includes any cable loss, antenna factor and pre-amplifier gain;

CF is the distance extrapolation factor in dB (where measurement distance different to limit distance);

Per FCC 47CFR15.31(f)(2), an extrapolation factor of 40 dB per decade was used for extrapolation from 3 m to 300 m, and from 3 m to 30 m.

This field strength value is then compared with the regulatory limit.

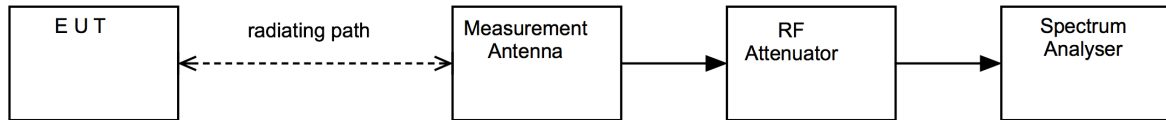
Figure i Test Setup**11.4 Test Equipment**

<i>Equipment Type</i>	<i>Manufacturer</i>	<i>Equipment Description</i>	<i>Element No</i>	<i>Due For Calibration</i>
Ferrite Lined Chamber	Rainford	Chamber	REF886	2024-06-15
FSU26	R&S	Spectrum Analyser	REF909	2023-08-05
6502	EMCO	Active Loop Antenna	R0079	2023-06-16
Emissions R5	Element	Radiated Test Software	REF9000	Cal not required

11.5 Test Results

Frequency: 125 kHz						
Emission Frequency (MHz)	Receiver Level (dB μ V/m)	Measurement Distance (m)	Limit Distance (m)	Extrapolation Factor (dB)	Field Strength (μ V/m)	Result
No spurious emissions were detected within 10 dB of the limit.						

9 kHz to 490 kHz

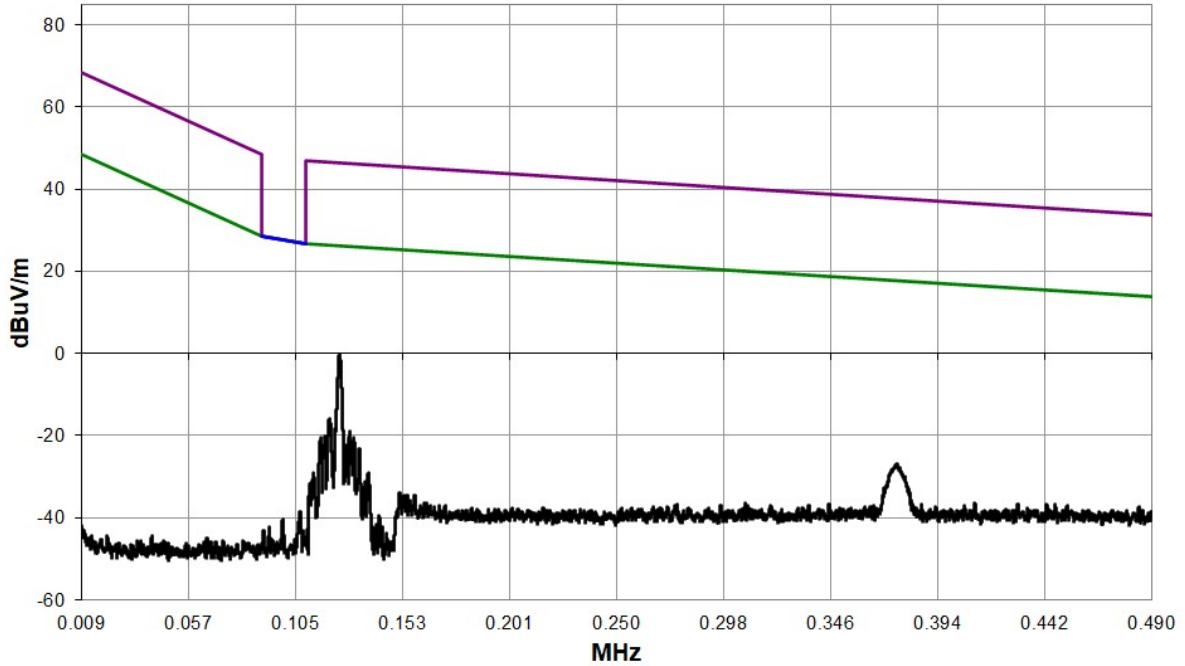

490 kHz to 30 MHz

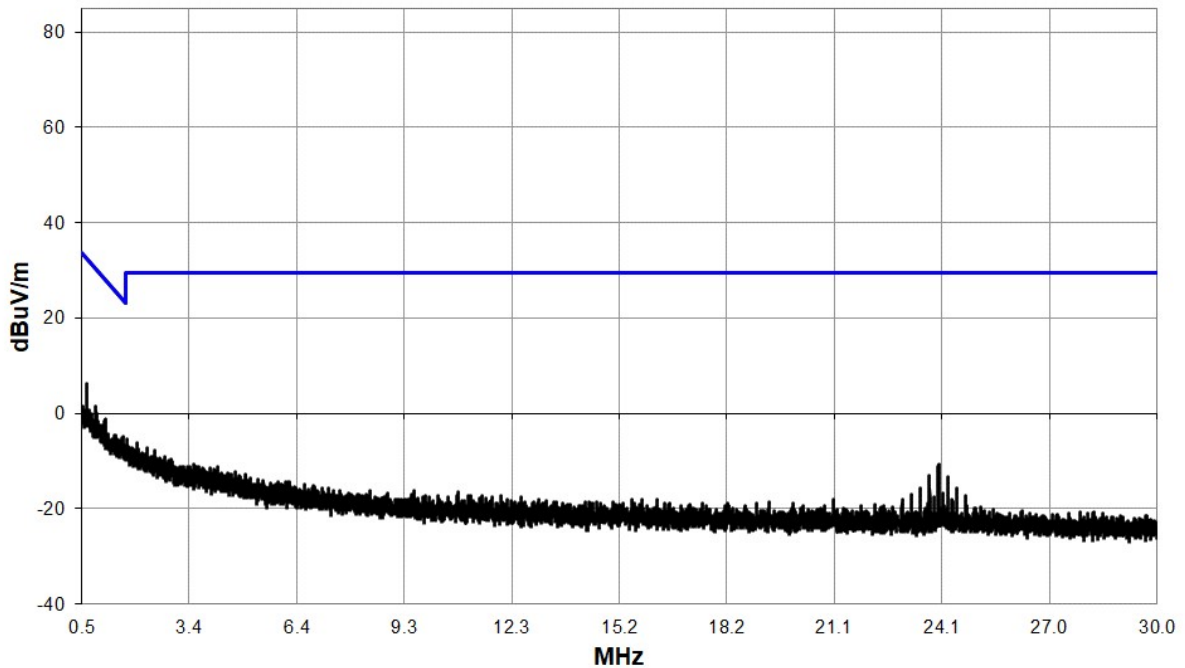

12 Radiated Emissions

12.1 Definitions

Out-of-band emissions

Emissions on a frequency or frequencies immediately outside the necessary bandwidth which result from the modulation process, but exclude spurious emissions.

Spurious emissions

Emissions on a frequency or frequencies which are outside the necessary bandwidth and the level of which may be reduced without affecting the corresponding transmission of information. Spurious emissions include harmonic emissions, parasitic emissions, intermodulation products and frequency conversion products, but exclude out-of-band emissions.

Restricted bands

A frequency band in which intentional radiators are permitted to radiate only spurious emissions but not fundamental signals.

12.2 Test Parameters

Test Location:	Element Hull
Test Chamber:	Wireless Lab 2
Test Standard and Clause:	ANSI C63.10-2013, Clause 6.5
EUT Frequency Measured:	125 kHz
Deviations From Standard:	None
Measurement BW:	30 MHz to 1 GHz: 120 kHz
Measurement Detector:	Quasi-peak

Environmental Conditions (Normal Environment)

Temperature: 21 °C	+15 °C to +35 °C (as declared)
Humidity: 40 %RH	20 %RH to 75 %RH (as declared)

Test Limit

Emissions from license-exempt transmitters shall comply with the field strength limits shown in the table below. Additionally, the level of any transmitter emission shall not exceed the level of the transmitter's fundamental emission.

General Field Strength Limits for License-Exempt Transmitters at Frequencies above 30 MHz

<i>Frequency (MHz)</i>	<i>Field Strength (μV/m at 3 m)</i>
30 to 88	100
88 to 216	150
216 to 960	200
Above 960	500

12.3 Test Method

With the EUT setup as per section 9 of this report and connected as per Figure ii, the emissions from the EUT were measured on a spectrum analyzer / EMI receiver.

Radiated electromagnetic emissions from the EUT are checked first by preview scans. Preview scans for all spectrum and modulation characteristics are checked, using a peak detector and where applicable worst-case determined for function, operation, orientation, etc. for both vertical and horizontal polarisations. Pre-scan plots are shown with a peak detector and 100 kHz RBW.

If the EUT connects to auxiliary equipment and is table or floor standing, the configurations prescribed in ANSI C63.10 are followed. Alternatively, a layout closest to normal use (as declared by the provider) is employed, (see EUT setup photographs for more detail).

Emissions between 30 MHz and 1 GHz are measured using calibrated broadband antennas. Emissions above 1 GHz are characterized using standard gain horn antennas. Pre-amplifiers and filters are used where required. Care is taken to ensure that test receiver resolution bandwidth, video bandwidth and detector type(s) meet the regulatory requirements.

For both horizontal and vertical polarizations, the EUT is then rotated through 360 degrees in azimuth until the highest emission is detected. At the previously determined azimuth the test antenna is raised and lowered from 1 to 4 m in height until a maximum emission level is detected, this maximum value is recorded.

Power values measured on the test receiver / analyzer are converted to field strength, FS, in dB μ V/m at the regulatory distance, using:

$$FS = PR + CL + AF - PA + DC - CF$$

Where,

PR is the power recorded on the receiver / spectrum analyzer in dB μ V;

CL is the cable loss in dB;

AF is the test antenna factor in dB/m;

PA is the pre-amplifier gain in dB (where used);

DC is the duty correction factor in dB (where used, e.g. harmonics of pulsed fundamental);

CF is the distance factor in dB (where measurement distance is different to limit distance);

$$\text{Factor} = CL + AF - PA$$

This field strength value is then compared with the regulatory limit.

Figure ii Test Setup

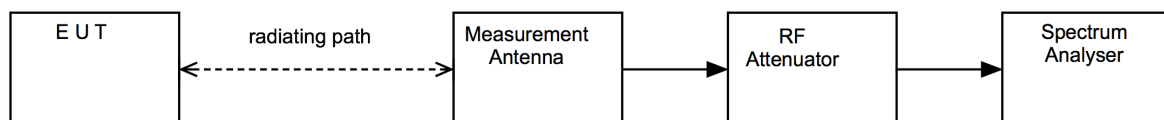

12.4 Test Equipment

Equipment Type	Manufacturer	Equipment Description	Element No	Due For Calibration
Ferrite Lined Chamber	Rainford	Chamber	REF886	2024-06-15
FSU26	R&S	Spectrum Analyser	REF909	2023-08-05
CBL6111D	TESEQ	Bilog Antenna	REF2385	2024-06-24
Pre-Amp (9 kHz – 1 GHz)	Sonoma	310	REF2389	2023-09-02
Emissions R5	Element	Radiated Test Software	REF9000	Cal not required

12.5 Test Results

Frequency: 125 kHz								
Detector	Freq. (MHz)	Meas'd Emission (dBµV)	Factor (dB)	Duty Cycle Corr'n (dB)	Distance Extrap'n Factor (dB)	Field Strength (dBµV/m)	Limit (dBµV/m)	Margin (dB)
No spurious emissions were detected within 10 dB of the limit.								

30 MHz to 1 GHz

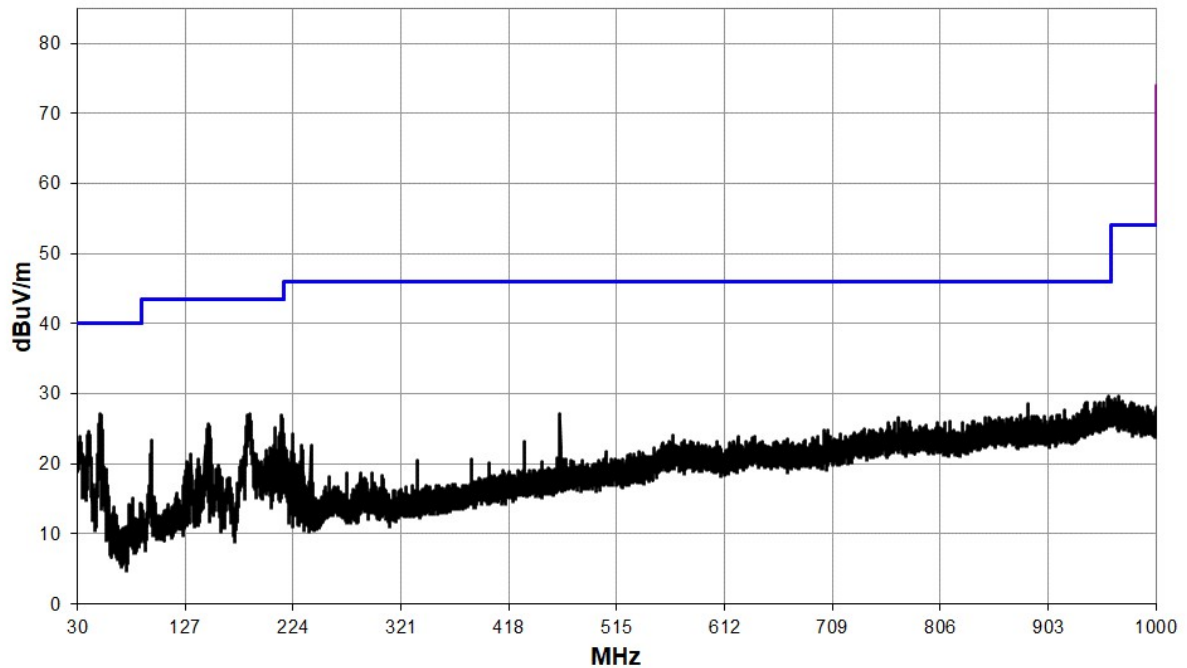

13 Transmitter Output Power (Fundamental Radiated Emission)

13.1 Definition

The RF power dissipated in the standard output termination when operating under the rated duty cycle selected by the applicant for approval.

13.2 Test Parameters

Test Location:	Element Hull
Test Chamber:	Wireless Lab 2
Test Antenna:	Active 60cm loop
Test Standard and Clause:	ANSI C63.10-2013, Clause 6.3 / 6.4
EUT Frequency Measured:	125 kHz
Deviations From Standard:	None
Measurement BW:	200 Hz
Spectrum Analyzer Video BW:	1 kHz
Measurement Detector:	Average

Environmental Conditions (Normal Environment)

Temperature: 21 °C	+15 °C to +35 °C (as declared)
Humidity: 40 %RH	20 %RH to 75 %RH (as declared)

Test Limit

Emissions from license-exempt transmitters shall comply with the field strength limits shown in the table below. Additionally, the level of any transmitter emission shall not exceed the level of the transmitter's fundamental emission.

General Field Strength Limits for License-Exempt Transmitters at Frequencies Below 30 MHz

<i>Frequency, f (kHz)</i>	<i>Field Strength</i>	<i>Measurement Distance (m)</i>
9 to 490	2,400 / 377.f (μA/m) 2,400 / f (μV/m)	300
490 to 1,750	24,000 / 377.f (μA/m) 24,000 / f (μV/m)	30
1,750 to 30,000	30 (μV/m)	30

n.b. Devices operated pursuant to §15.225 / RSS-210 A2.6 are exempt from complying with the restricted band requirements for the 13.36–13.41 MHz band only.

13.3 Test Method

With the EUT setup as per section 9 of this report and connected as per Figure v, the resolution bandwidth of the spectrum analyser was increased above the EUT occupied bandwidth and the peak emission data noted.

The measurements were performed with EUT set at its maximum duty. All modulation schemes, data rates and power settings were used to observe the worst-case configuration in each bandwidth.

Power values measured on the test receiver / analyzer are converted to field strength, FS, in $\mu\text{V}/\text{m}$ at the regulatory distance, using:

$$FS = 10 (PR - CF) / 20$$

Where,

PR is the power recorded on the receiver / spectrum analyzer in $\text{dB}\mu\text{V}$ and includes any cable loss, antenna factor and pre-amplifier gain;
 CF is the distance extrapolation factor in dB (where measurement distance different to limit distance);

Per FCC 47CFR15.31(f)(2) / RSS-Gen 6.4, an extrapolation factor of 40 dB per decade was used for extrapolation from 3 m to 300 m.

Per FCC 47CFR15.31(f)(2) / RSS-Gen 6.4, an extrapolation factor from 1 m to 3 m of 26.35 dB was determined from measurements at 1 and 3 metres.

This field strength value is then compared with the regulatory limit.

Figure v Test Setup

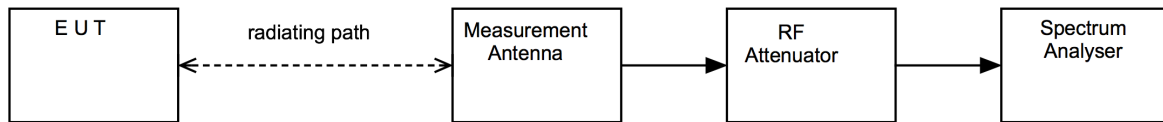

13.4 Test Equipment

<i>Equipment Type</i>	<i>Manufacturer</i>	<i>Equipment Description</i>	<i>Element No</i>	<i>Due For Calibration</i>
Ferrite Lined Chamber	Rainford	Chamber	REF886	2024-06-15
FSU26	R&S	Spectrum Analyser	REF909	2023-08-05
6502	EMCO	Active Loop Antenna	R0079	2023-06-16
Emissions R5	Element	Radiated Test Software	REF9000	Cal not required

13.5 Test Results

Frequency: 125 kHz						
Channel Frequency (kHz)	Receiver Level (dBμV/m)	Measurement Distance (m)	Limit Distance (m)	Extrapolation Factor (dB)	Field Strength (μV/m)	Result
125	105.96	1	300	106.35	0.956	Pass
125	79.61	3	300	80.00	0.956	Pass

14 Measurement Uncertainty

Radio Testing – General Uncertainty Schedule

All statements of uncertainty are expanded standard uncertainty using a coverage factor of 1.96 to give a 95 % confidence where no required test level exists.

Test/Measurement	Budget Number	MU
Conducted RF Power, Power Spectral Density, Adjacent Channel Power and Spurious emissions		
Absolute RF power (via antenna connector) Dare RPR3006W Power Head	MU4001	0.9 dB
Carrier Power and PSD - Spectrum Analysers	MU4004	0.9 dB
Adjacent Channel Power	MU4002	1.9 dB
Transmitter conducted spurious emissions	MU4041	0.9 dB
Conducted power and spurious emissions 40 GHz to 50 GHz	MU4042	2.4 dB
Conducted power and spurious emissions 50 GHz to 75 GHz	MU4043	2.5 dB
Conducted power and spurious emissions 75 GHz to 110 GHz	MU4044	2.4 dB
Radiated RF Power and Spurious emissions ERP and EIRP		
Effective Radiated Power Reverb Chamber	MU4020	3.7 dB
Effective Radiated Power	MU4021	4.7 dB
TRP Emissions 30 MHz to 1 GHz using CBL6111 or CBL6112 Bilog Antenna	MU4046	5.3 dB
TRP Emissions 1 GHz to 18 GHz using HL050 Log Periodic Antenna	MU4047	5.1 dB
TRP Emissions 18 GHz to 26.5 GHz using Standard Gain Horn	MU4048	2.7 dB
TRP Emissions 26.5 GHz to 40 GHz using Standard Gain Horn	MU4049	2.7 dB
Spurious Emissions Electric and Magnetic Field		
Radiated Spurious Emissions 30 MHz to 1 GHz	MU4037	4.7 dB
Radiated Spurious Emissions 1-18 GHz	MU4032	4.5 dB
E Field Emissions 18GHz to 26 GHz	MU4024	3.2 dB
E Field Emissions 26GHz to 40 GHz	MU4025	3.3 dB
E Field Emissions 40GHz to 50 GHz	MU4026	3.5 dB
E Field Emissions 50GHz to 75 GHz	MU4027	3.6 dB
E Field Emissions 75GHz to 110 GHz	MU4028	3.6 dB
Radiated Magnetic Field Emissions	MU4031	2.3 dB
Frequency Measurements		
Frequency Deviation	MU4022	0.316 kHz
Frequency error using CMTA test set	MU4023	113.441 Hz
Frequency error using GPS locked frequency source	MU4045	0.0413 ppm
Bandwidth/Spectral Mask Measurements		
Channel Bandwidth	MU4005	3.87 %
Transmitter Mask Amplitude	MU4039	1.3 dB
Transmitter Mask Frequency	MU4040	2.59 %
Time Domain Measurements		
Transmission Time	MU4038	4.40 %
Dynamic Frequency Selection (DFS) Parameters		
DFS Analyser - Measurement Time	MU4006	679 μ s
DFS Generator - Frequency Error	MU4007	92 Hz
DFS Threshold Conducted	MU4008	1.3 dB
DFS Threshold Radiated	MU4009	3.2 dB

Test/Measurement	Budget Number	MU
Receiver Parameters		
EN300328 Receiver Blocking	MU4010	1.1 dB
EN301893 Receiver Blocking	MU4011	1.1 dB
EN303340 Adjacent Channel Selectivity	MU4012	1.1 dB
EN303340 Overloading	MU4013	1.1 dB
EN303340 Receiver Blocking	MU4014	1.1 dB
EN303340 Receiver Sensitivity	MU4015	0.9 dB
EN303372-1 Image Rejection	MU4016	1.4 dB
EN303372-1 Receiver Blocking	MU4017	1.1 dB
EN303372-2 Adjacent Channel Selectivity	MU4018	1.1 dB
EN303372-2 Dynamic Range	MU4019	0.9 dB
Receiver Blocking Talk Mode Conducted	MU4033	1.2 dB
Receiver Blocking Talk Mode- radiated	MU4034	3.4 dB
Rx Blocking, listen mode, blocking level	MU4035	3.2 dB
Rx Blocking, listen mode, radiated Threshold Measurement	MU4036	3.4 dB
Adjacent Sub Band Selectivity	MU4003	4.2 dB

15 Customer Declaration

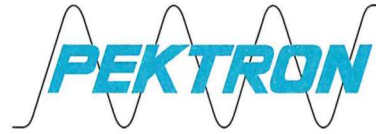

PEKTRON Group Limited

Alfreton Road
Derby
DE21 4AP

Tel: +44(0)1332 832424

www.pektron.com

16th January 2023

We, Pektron, declare the following to be true:

Element Materials Technology performed testing against a fully populated sample, A-0819G17 and depopulated unit A-0819G13.

Original versions certified

- A-0819G02 - BTLE/NFC/LF Node with a plastic sheath over the cables
- A-0819G03 - BTLE/LF with no plastic sheath over the cables. This is a depopulated unit to physically remove the NFC components from the PCB. NFC is not used on this variant
- A-0819G06 - BTLE/LF with a plastic sheath over the cables. This is a depopulated unit to physically remove the NFC components from the PCB. NFC is not used on this variant
- A-0819G07 - BTLE/NFC/LF with a plastic sheath over the cables

A Hardware Modification to the 125KHz Radio was found to be required for Compliance and new versions were produced with this modification as follows:

- A-0819G12 - BTLE/NFC/LF Node with a plastic sheath over the cables
- A-0819G13 - BTLE/LF with no plastic sheath over the cables. This is a depopulated unit to physically remove the NFC components from the PCB. NFC is not used on this variant
- A-0819G16 - BTLE/LF with a plastic sheath over the cables. This is a depopulated unit to physically remove the NFC components from the PCB. NFC is not used on this variant
- A-0819G17 - BTLE/NFC/LF with a plastic sheath over the cables

The modification affects the Transmit of the 125KHz LF Radio ONLY, therefore prior testing of the A-0819G02 to A-0819G07 Nodes remains valid for the A-0819G12 to A-0819G17 Nodes and is therefore referenced in the Reports.

There are no other differences between the A-0819G02 to A-0819G07 and A-0819G12 to A-0819G17 Nodes.

Regards,

Richard Jones
Electrical Test Manager

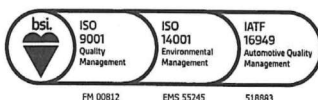

Registered in England: No. 823259