

Report on the Intermodulation Testing

For

Pektron Group Limited

on

BTLE Node

Report no. TRA-051982-47-13A

2021-04-13

RF915 4.0



Report Number: TRA-051982-47-13A  
Issue: A

REPORT ON THE INTERMODULATION TESTING OF A  
Pektron Group Limited  
BTLE Node  
WITH RESPECT TO SPECIFICATIONS  
47CFR15 & RSS-GEN  
INTERMODULATION EMISSIONS INVESTIGATION

TEST DATE: 2021-03-31

Written by:



Steven Garwell  
Radio Test Engineer

Approved by:

Daniel Winstanley  
Radio Senior Test Engineer

Date: 2021-04-13

Disclaimers:

- [1] THIS DOCUMENT MAY BE REPRODUCED ONLY IN ITS ENTIRETY AND WITHOUT CHANGE  
[2] THE RESULTS CONTAINED IN THIS DOCUMENT RELATE ONLY TO THE ITEM(S) TESTED

RF915 4.0

## 1 Revision Record

<i>Issue Number</i>	<i>Issue Date</i>	<i>Revision History</i>
A	2021-04-13	Original

## 2 Summary

TEST REPORT NUMBER: TRA-051982-47-13A

WORKS ORDER NUMBER: TRA-051982-02

PURPOSE OF TEST: USA: Testing of radio frequency equipment per the relevant authorization procedure of chapter 47 of CFR (code of federal regulations) Part 2, subpart J.

Canada: Testing of radio apparatus for TAC (technical acceptance certificate) per subsections 4(2) of the Radiocommunication Act and 21(1) of the Radiocommunication Regulations.

TEST SPECIFICATION(S): Intermodulation emissions investigation using 47CFR15 & RSS-GEN

EQUIPMENT UNDER TEST (EUT): BTLE Node

FCC ID: AQO012

ISED ID: 10176A-012

EUT SERIAL NUMBER: Not Stated

MANUFACTURER/AGENT: Pektron Group Limited

ADDRESS: Alfreton Road  
Derby  
Derbyshire  
DE21 4AP  
United Kingdom

CLIENT CONTACT: Richard Jones  
☎ 01332832424 ext 382  
✉ rjones@pektron.co.uk

ORDER NUMBER: PROJ-00000632

TEST DATE: 2021-03-31

TESTED BY: Steven Garwell  
Element

## 2.1 Test Summary

<i>Test Method and Description</i>	<i>Requirement Clause</i>		<i>Applicable to this equipment</i>	<i>Result / Note</i>
	<i>RSS</i>	<i>47CFR</i>		
Multi-radio Simultaneous Transmission Spurious Emissions	Gen, 8.10	Part 15	☒	<i>Pass</i>

### Notes:

The results contained in this report relate only to the items tested, in the condition at time of test, and were obtained in the period between the date of initial receipt of samples and the date of issue of the report.

The apparatus was set up and exercised using the configurations, modes of operation and arrangements defined in this report only. Any modifications made are identified in Section 8 of this report.

Particular operating modes, apparatus monitoring methods and performance criteria required by the standards tested to have been performed except where identified in Section 5.2 of this test report (Deviations from Test Standards).

### 3 Contents

1	Revision Record .....	3
2	Summary .....	4
2.1	Test Summary .....	5
3	Contents .....	6
4	Introduction .....	7
5	Glossary of Terms .....	8
6	Equipment Under Test.....	9
6.1	EUT Identification .....	9
6.2	System Equipment.....	9
6.3	EUT Mode of Operation .....	9
6.3.1	Transmission .....	9
6.4	EUT Description.....	9
7	Modifications.....	9
8	EUT Test Setup .....	10
8.1	Block Diagram .....	10
8.2	General Set-up Photograph .....	11
8.3	Measurement software .....	11
9	General Technical Parameters .....	12
9.1	Normal Conditions .....	12
10	Multi-radio Simultaneous Transmission Spurious Emissions below 30 MHz .....	13
10.1	Definitions .....	13
10.2	Test Parameters .....	13
10.3	Test Limit .....	14
10.4	Test Method.....	14
10.5	Test setup photograph.....	15
10.6	Test Equipment.....	15
10.7	Test Results.....	16
11	Multi-radio Simultaneous Transmission Spurious Emissions above 30 MHz.....	18
11.1	Definitions .....	18
11.2	Test Parameters .....	18
11.3	Test Limits .....	18
11.4	Test Method.....	19
11.5	Test Set-up Photograph.....	20
11.6	Test Equipment.....	20
11.7	Results.....	21
12	Measurement Uncertainty.....	23
13	MPE Calculation .....	<b>Error! Bookmark not defined.</b>
14	RF EXPOSURE TECHNICAL BRIEF .....	24

## 4 Introduction

This report TRA-051982-47-13A presents the results of the Radio testing on a Pektron Group Limited, BTLE Node.

The BTLE Node contains a BTLE 2.4 GHz radio, and a LF 125 kHz radio that are able to operate simultaneously.

The testing was carried out for Pektron Group Limited by Element, at the address detailed below.

<input type="checkbox"/>	Element Hull Unit E South Orbital Trading Park Hedon Road Hull HU9 1NJ UK	<input checked="" type="checkbox"/>	Element Skelmersdale Unit 1 Pendle Place Skelmersdale West Lancashire WN8 9PN UK
--------------------------	---	-------------------------------------	--

This report details the configuration of the equipment, the test methods used and any relevant modifications where appropriate.

All test and measurement equipment under the control of the laboratory and requiring calibration is subject to an established programme and procedures to control and maintain measurement standards. The quality management system meets the principles of ISO 9001, and has quality control procedures for monitoring the validity of tests undertaken. Records and sufficient detail are retained to establish an audit trail of calibration records relating to its test results for a defined period. Under control of the established calibration programme, key quantities or values of the test & measurement instrumentation are within specification and comply with the relevant traceable internationally recognised and appropriate standard specifications, which are UKAS calibrated as such where these properties have a significant effect on results. Participation in inter-laboratory comparisons and proficiency testing ensures satisfactory correlation of results conform to Elements own procedures, as well as statistical techniques for analysis of test data providing the appropriate confidence in measurements.

Throughout this report EUT denotes equipment under test.

FCC Site Listing:

The test laboratory is accredited for the above sites under the US-UK MRA,

Designation number(s):

Element Hull	UK2007
Element Skelmersdale	UK2020

IC Registration Number(s):

Element Hull	3483A
Element Skelmersdale	3930B

The test site requirements of ANSI C63.4-2014 are met up to 1GHz.

The test site SVSWR requirements of CISPR 16-1-4:2010 are met over the frequency range 1 GHz to 18 GHz.

## 5 Glossary of Terms

<b>§</b>	denotes a section reference from the standard, not this document
<b>AC</b>	Alternating Current
<b>ANSI</b>	American National Standards Institute
<b>BW</b>	bandwidth
<b>C</b>	Celsius
<b>CFR</b>	Code of Federal Regulations
<b>CW</b>	Continuous Wave
<b>dB</b>	decibel
<b>dBm</b>	dB relative to 1 milliwatt
<b>DC</b>	Direct Current
<b>DSSS</b>	Direct Sequence Spread Spectrum
<b>EIRP</b>	Equivalent Isotropically Radiated Power
<b>ERP</b>	Effective Radiated Power
<b>EUT</b>	Equipment Under Test
<b>FCC</b>	Federal Communications Commission
<b>FHSS</b>	Frequency Hopping Spread Spectrum
<b>Hz</b>	hertz
<b>IC</b>	Industry Canada
<b>ITU</b>	International Telecommunication Union
<b>LBT</b>	Listen Before Talk
<b>m</b>	metre
<b>max</b>	maximum
<b>MIMO</b>	Multiple Input and Multiple Output
<b>min</b>	minimum
<b>MRA</b>	Mutual Recognition Agreement
<b>N/A</b>	Not Applicable
<b>PCB</b>	Printed Circuit Board
<b>PDF</b>	Portable Document Format
<b>Pt-mpt</b>	Point-to-multipoint
<b>Pt-pt</b>	Point-to-point
<b>RF</b>	Radio Frequency
<b>RH</b>	Relative Humidity
<b>RMS</b>	Root Mean Square
<b>Rx</b>	receiver
<b>s</b>	second
<b>SVSWR</b>	Site Voltage Standing Wave Ratio
<b>Tx</b>	transmitter
<b>UKAS</b>	United Kingdom Accreditation Service
<b>V</b>	volt
<b>W</b>	watt
<b>Ω</b>	ohm



## 6 Equipment Under Test

### 6.1 EUT Identification

- Name: BTLE Node
- Serial Number: Not Stated
- Model Number: A-0819G06
- Software Revision: Software Revision: Bootloader: P0819B1.0.4 / Application: P0819A2.1.2
- Hardware Version: Production

### 6.2 System Equipment

Equipment listed below forms part of the overall test setup and is required for equipment functionality and/or monitoring during testing. The compliance levels achieved in this report relate only to the EUT and not items given in the following list.

1. *Dell Vostro Laptop*

### 6.3 EUT Mode of Operation

#### 6.3.1 Transmission

The mode of operation for transmitter tests was as follows:

Radios were set to transmit permanently in various combinations, the spectrum was checked to determine if any intermodulation products were generated due to multiple radios operating simultaneously. The worst case emission plots are shown in this document.

EUT was operated with worst case modes of operation for each radio device.

### 6.4 EUT Description

The EUT is a BTLE Node incorporating BTLE 2.4 GHz and a LF 125 kHz radio. This report covers the testing of inter-modulations produced by all radio technologies operating simultaneously.

## 7 Modifications

No modifications were performed during this assessment.

## 8 EUT Test Setup

### 8.1 Block Diagram

The following diagram shows basic EUT interconnections with cable type and cable lengths identified:

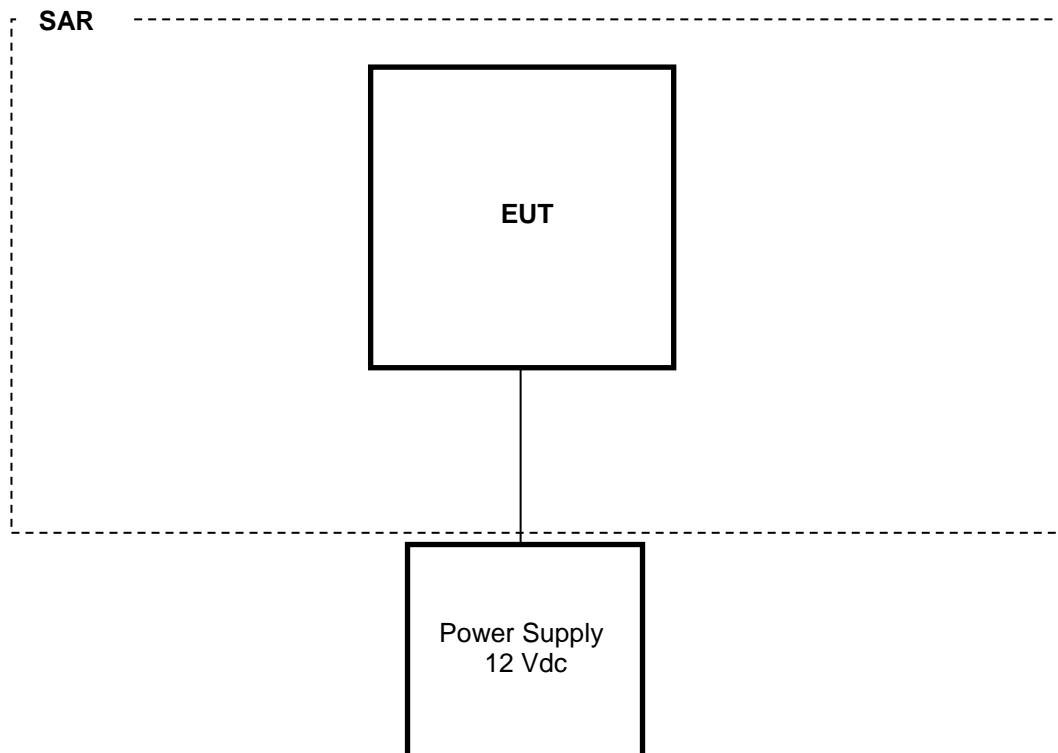

## 8.2 General Set-up Photograph

The following photographs shows basic EUT set-up:



## 8.3 Measurement software

Where applicable, the following software was used to perform measurements contained within this report.

Element Emissions R5 (See Note)  
Element Transmitter Bench Test (See Note)  
ETS Lindgren EMPower V1.0.4.2

Note:

The version of the Element software used is recorded in the results sheets contained within this report.

## 9 General Technical Parameters

### 9.1 Normal Conditions

The BTLE / Node was tested under the normal environmental conditions of the test laboratory, except where otherwise stated. The normal power source applied was 12 Vdc from an external power supply.

<b>Modes of operation:</b>	<b>BTLE</b>	<b>LF</b>
<b>Frequencies of operation:</b>	2402 MHz to 2480 MHz	125 kHz
<b>Antenna type(s):</b>	PCB Trace	LF Antenna
<b>Modulation type(s)</b>	GFSK	ASK
<b>Nominal Supply Voltage:</b>	12 Vdc	12 Vdc

## 10 Multi-radio Simultaneous Transmission Spurious Emissions below 30 MHz

### 10.1 Definitions

#### *Out-of-band emissions*

Emissions on a frequency or frequencies immediately outside the necessary bandwidth which result from the modulation process, but exclude spurious emissions.

#### *Spurious emissions*

Emissions on a frequency or frequencies which are outside the necessary bandwidth and the level of which may be reduced without affecting the corresponding transmission of information. Spurious emissions include harmonic emissions, parasitic emissions, intermodulation products and frequency conversion products, but exclude out-of-band emissions.

#### *Restricted bands*

A frequency band in which intentional radiators are permitted to radiate only spurious emissions but not fundamental signals.

### 10.2 Test Parameters

Test Location:	Element Skelmersdale
Test Chamber:	SK03 radio chamber
Test Standard and Clause:	ANSI C63.10-2013, Clause 6.4
Frequencies Measured:	2402 MHz, 2480 MHz, (BTLE) 13.56 MHz (NFC) 125 kHz (LF)
Deviations From Standard:	None
Measurement Distance and Site	3 m
EUT Height:	1 m
Measurement Antenna and Height:	60 cm shielded loop; 1 m
Measurement BW:	9 kHz to 150 kHz: 200 Hz; 150 kHz to 30 MHz: 9 kHz
Measurement Detector:	9 kHz to 90 kHz and 110 kHz to 490 kHz: Average, RMS Other frequencies below 30 MHz: Quasi-peak.

### Environmental Conditions (Normal Environment)

Temperature: 22 °C	+15 °C to +35 °C (as declared)
Humidity: 42 % RH	20 % RH to 75 % RH (as declared)
Supply: 12 Vdc	12 Vdc (as declared)

### 10.3 Test Limit

Emissions from license-exempt transmitters shall comply with the field strength limits shown in the table below. Additionally, the level of any transmitter emission shall not exceed the level of the transmitter's fundamental emission.

#### General Field Strength Limits for License-Exempt Transmitters at Frequencies below 30 MHz

<i>Frequency, f (kHz)</i>	<i>Field Strength</i>	<i>Measurement Distance (m)</i>
9 to 490	2,400 / 377.f (μA/m) 2,400 / f (μV/m)	300
490 to 1,750	24,000 / 377.f (μA/m) 24,000 / f (μV/m)	30
1,750 to 30,000	30 (μV/m)	30

n.b. Devices operated pursuant to §15.225 / RSS-210 B.6 are exempt from complying with the restricted band requirements for the 13.36–13.41 MHz band only.

### 10.4 Test Method

With the EUT setup as per section 9 of this report and connected as per Figure I, the EUT fundamental frequency was maximised by rotating the EUT through 360°, in three orthogonal planes, and adjusting the measurement antenna azimuth.

Radiated electromagnetic emissions from the EUT are checked first by preview scans. Preview scans for all spectrum and modulation characteristics are checked, using a peak detector and where applicable worst-case determined for function, operation, orientation, etc. for both vertical and horizontal polarisations. Pre-scan plots are shown with a peak detector and 9 kHz RBW.

If the EUT connects to auxiliary equipment and is table or floor standing, the configurations prescribed in ANSI C63.10 are followed. Alternatively, a layout closest to normal use (as declared by the provider) is employed, (see EUT setup photographs for more detail).

Emissions between 9 kHz and 30 MHz are measured using a calibrated 60cm active loop antenna. Pre-amplifiers and filters are used where required. Care is taken to ensure that test receiver resolution bandwidth, video bandwidth and detector type(s) meet the regulatory requirements.

Power values measured on the test receiver / analyzer are converted to field strength, FS, in μV/m at the regulatory distance, using:

$$FS = 10 (PR - CF) / 20$$

Where,

PR is the power recorded on the receiver / spectrum analyzer in dBμV and includes any cable loss, antenna factor and pre-amplifier gain;  
CF is the distance extrapolation factor in dB (where measurement distance different to limit distance);

Per FCC 47CFR15.31(f)(2) / RSS-Gen 6.4, an extrapolation factor of 40 dB per decade was used for extrapolation from 3 m to 30 m and from 3 m to 300 m.

This field strength value is then compared with the regulatory limit.

## Figure I Test Setup

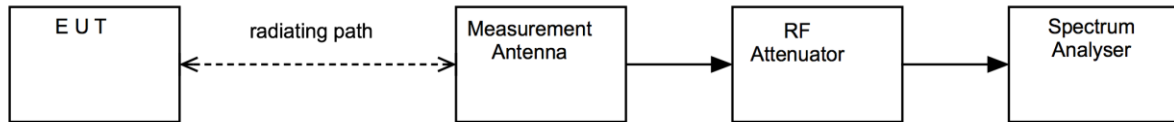

### 10.5 Test setup photograph



### 10.6 Test Equipment

<i>Equipment Type</i>	<i>Manufacturer</i>	<i>Equipment Description</i>	<i>Element No</i>	<i>Due For Calibration</i>
Spectrum Analyser	R&S	FSU46	REF910	2021-11-18
Loop Antenna	R&S	hfh2	L007	2021-07-09
ATS	Rainford EMC	Radio Chamber – PP	REF940	2021-12-09

### 10.7 Test Results

BTLE; Frequency 2402 MHz; NFC: 13.56 MHz; LF: 125 kHz

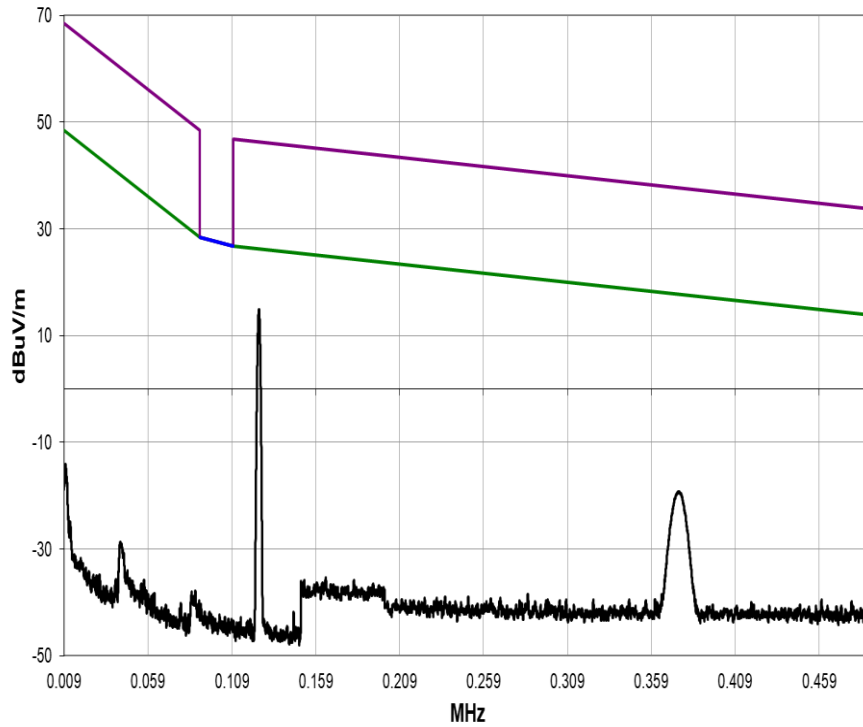

9 kHz to 490 kHz

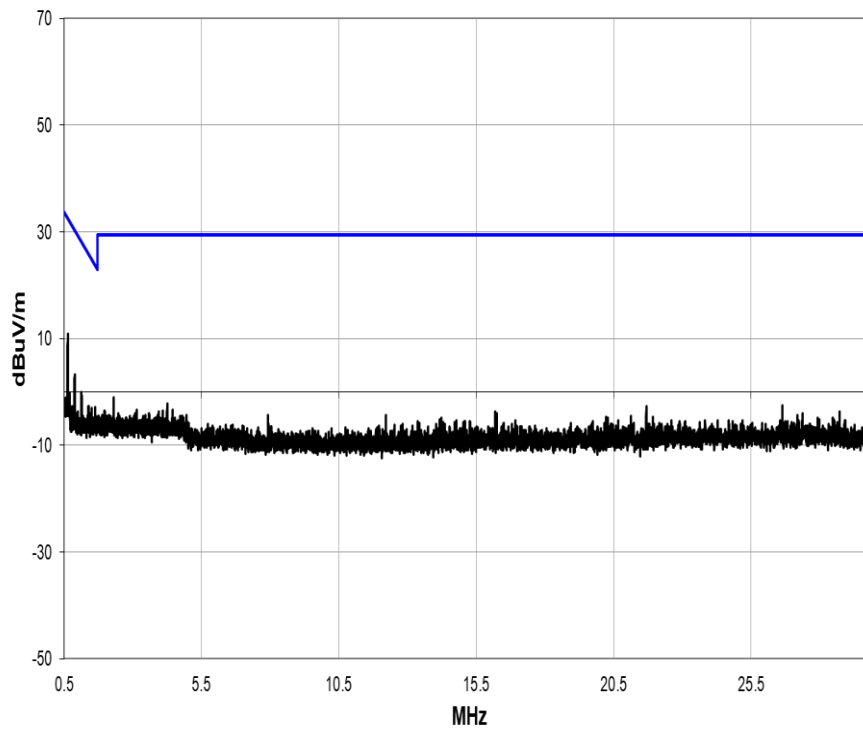

490 kHz to 30 MHz

All emissions on graphs are related to either the BTLE 2.4 GHz, NFC 13.56 MHz or LF 125 kHz operation and are not intermodulation products.



BTLE; Frequency 2480 MHz; NFC: 13.56 MHz; LF: 125 kHz

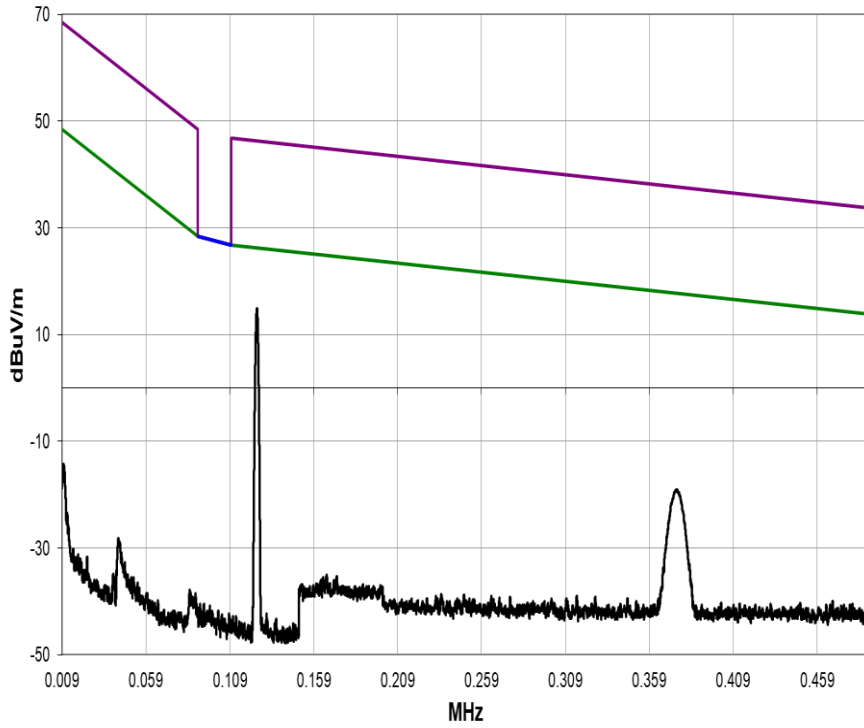

9 kHz to 490 kHz

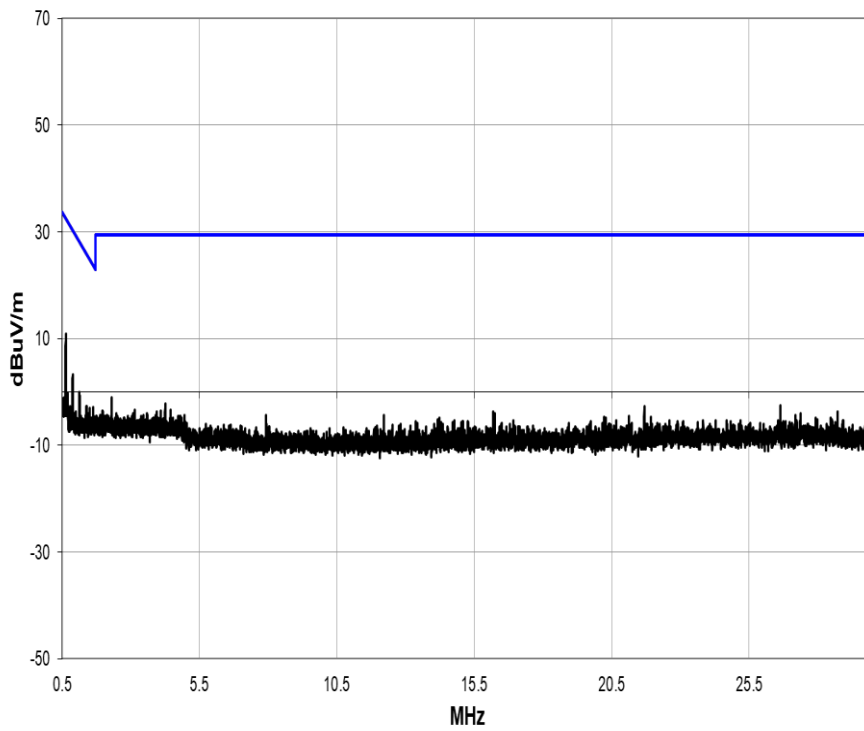

490 kHz to 30 MHz

All emissions on graphs are related to either the BTLE 2.4 GHz, NFC 13.56 MHz or LF 125 kHz operation and are not intermodulation products.

## 11 Multi-radio Simultaneous Transmission Spurious Emissions above 30 MHz

### 11.1 Definitions

#### *Spurious emissions*

Emissions on a frequency or frequencies, which are outside the necessary bandwidth and the level of which may be reduced without affecting the corresponding transmission of information. Spurious emissions include harmonic emissions, parasitic emissions, intermodulation products and frequency conversion products, but exclude out-of-band emissions.

#### *Intermodulation products*

Emissions of two or more electromagnetic waves transmitted simultaneously through a nonlinear electronic system.

### 11.2 Test Parameters

Test Location:	Element Skelmersdale
Test Chamber:	SK03 radio chamber
Test Standard and Clause:	ANSI C63.10-2013, Clause 6.5 and 6.6
Frequencies Tested:	2402 MHz, 2480 MHz, (BTLE) 125 kHz (LF)
Deviations From Standard:	None
Measurement BW:	9 kHz to 150 kHz: 1 kHz 150 kHz to 30 MHz: 10 kHz 30 MHz to 1 GHz: 120 kHz Above 1 GHz: 1 MHz
Measurement Detector:	Up to 1 GHz: quasi-peak Above 1 GHz: RMS average and Peak

### Environmental Conditions (Normal Environment)

Temperature: 22 °C	+15 °C to +35 °C (as declared)
Humidity: 33% RH	20 % RH to 75 % RH (as declared)
Supply: 12 Vdc	12 Vdc (as declared)

### 11.3 Test Limits

Unwanted emissions that fall within the restricted frequency bands shall comply with the limits specified:

#### General Field Strength Limits for License-Exempt Transmitters at Frequencies above 30 MHz

<b>Frequency (MHz)</b>	<b>Field Strength (<math>\mu\text{V}/\text{m}</math> at 3 m)</b>
30 to 88	100
88 to 216	150
216 to 960	200
Above 960	500

## General Field Strength Limits for License-Exempt Transmitters at Frequencies below 30 MHz

Frequency, <i>f</i> (kHz)	Field Strength	Measurement Distance (m)
9 to 490	2,400 / 377. <i>f</i> (μA/m) 2,400 / <i>f</i> (μV/m)	300
490 to 1,750	24,000 / 377. <i>f</i> (μA/m) 24,000 / <i>f</i> (μV/m)	30
1,750 to 30,000	30 (μV/m)	30

Least stringent limit applied to any intermodulation products.

### 11.4 Test Method

With the EUT setup as per section 9 of this report and connected as per Figure i, the emissions from the EUT were measured on a spectrum analyzer / EMI receiver.

Radiated electromagnetic emissions from the EUT are checked first by preview scans. Preview scans for all spectrum and modulation characteristics are checked, using a peak detector and where applicable worst-case determined for function, operation, orientation, etc. for both vertical and horizontal polarisations. Pre-scan plots are shown with a peak detector and 100 kHz RBW.

If the EUT connects to auxiliary equipment and is table or floor standing, the configurations prescribed in ANSI C63.10 are followed. Alternatively, a layout closest to normal use (as declared by the provider) is employed, (see EUT setup photographs for more detail).

Emissions between 30 MHz and 1 GHz are measured using calibrated broadband antennas. Emissions above 1 GHz are characterized using standard gain horn antennas. Pre-amplifiers and filters are used where required. Care is taken to ensure that test receiver resolution bandwidth, video bandwidth and detector type(s) meet the regulatory requirements.

For both horizontal and vertical polarizations, the EUT is then rotated through 360 degrees in azimuth until the highest emission is detected. At the previously determined azimuth the test antenna is raised and lowered from 1 to 4 m in height until a maximum emission level is detected, this maximum value is recorded.

Power values measured on the test receiver / analyzer are converted to field strength, FS, in dBμV/m at the regulatory distance, using:

$$FS = PR + CL + AF - PA + DC - CF$$

$$\text{Factor} = CL + AF - PA$$

Where,

PR is the power recorded on the receiver / spectrum analyzer in dBμV;

CL is the cable loss in dB;

AF is the test antenna factor in dB/m;

PA is the pre-amplifier gain in dB (where used);

DC is the duty correction factor in dB (where used, e.g. harmonics of pulsed fundamental);

CF is the distance factor in dB (where measurement distance different to limit distance);

This field strength value is then compared with the regulatory limit.

**Figure i Test Setup**

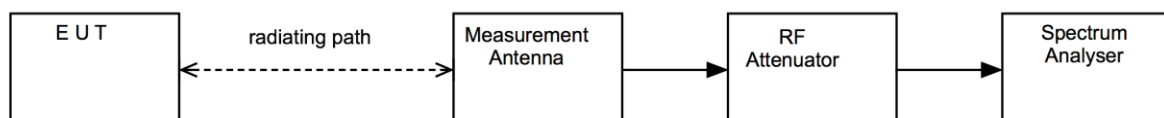

### 11.5 Test Set-up Photograph



### 11.6 Test Equipment

<i>Equipment Description</i>	<i>Manufacturer</i>	<i>Equipment Type</i>	<i>Element No</i>	<i>Due For Calibration</i>
Spectrum Analyser	R&S	FSU46	REF910	2021-11-16
Bilog	Chase	CBL611/A	U573	2021-09-19
1-18GHz Horn	EMCO	3115	L139	2021-07-16
Pre Amp	Watkins Johnson	6201-69	U372	2021-02-26
Pre Amp	Agilent	8449B	L572	2021-10-19
Horn 18-26GHz (&U330)	Flann	20240-20	L300	2022-04-23
Loop Antenna	R&S	hfh2	L007	2021-07-09
Radio Chamber - PP	Rainford EMC	ATS	REF940	2021-12-09

### 11.7 Results

BTLE; Frequency 2402 MHz; LF: 125 kHz

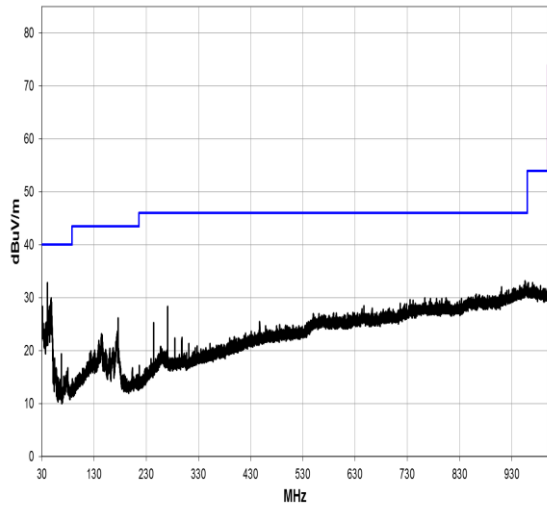

30 MHz to 1 GHz

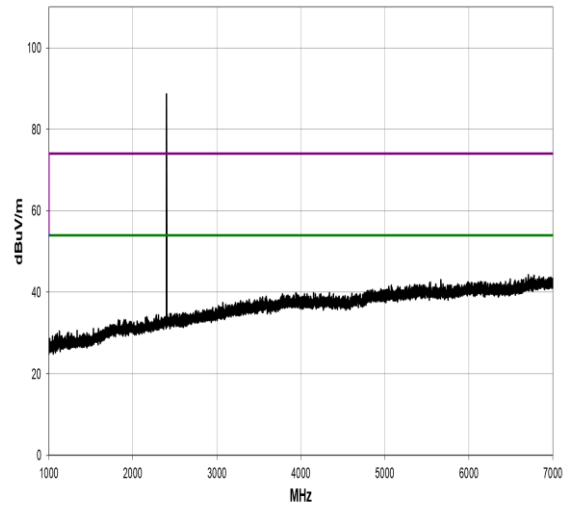

1 GHz to 7 GHz

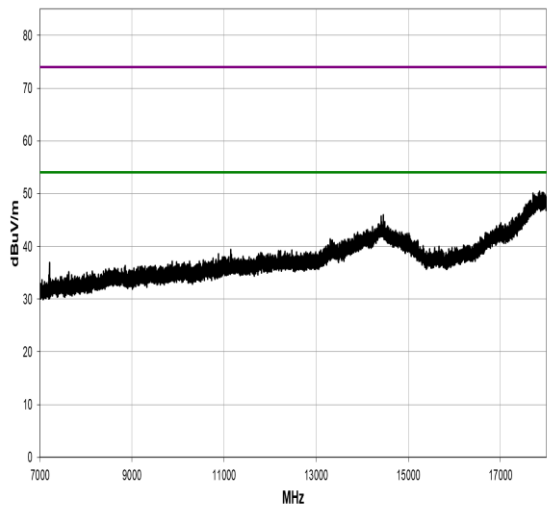

7 GHz to 18 GHz

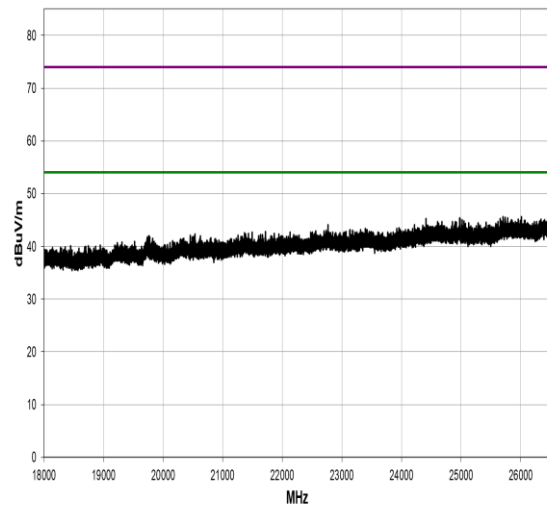

18 GHz to 26.5 GHz

All emissions on graphs are related to either the BTLE 2.4 GHz, LF 125 kHz operation and are not intermodulation products.

BTLE; Frequency 2480 MHz; LF: 125 kHz

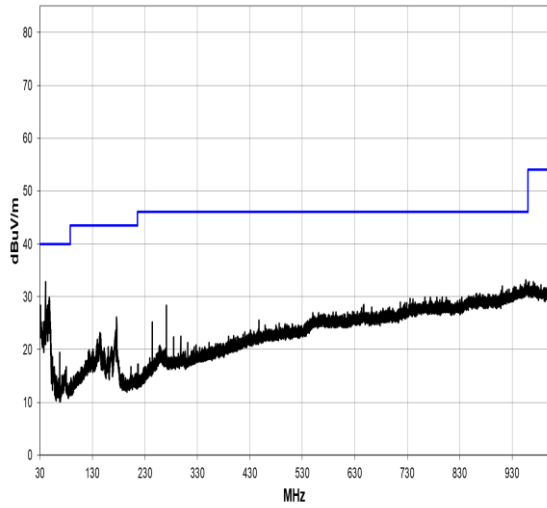

30 MHz to 1 GHz

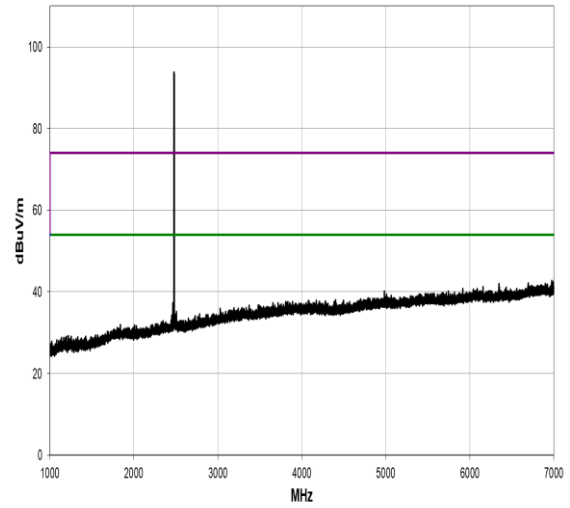

1 GHz to 7 GHz

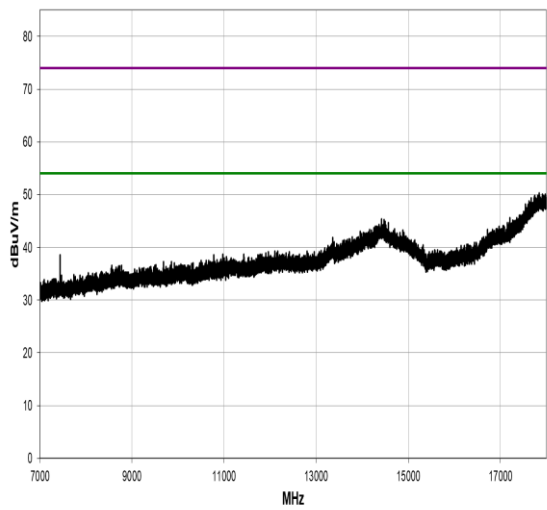

7 GHz to 18 GHz

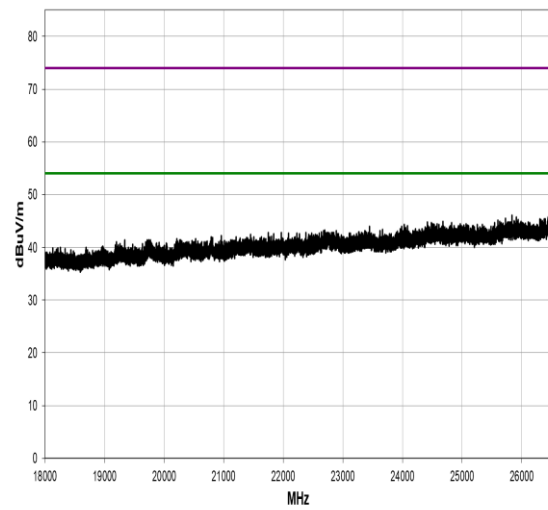

18 GHz to 26.5 GHz

All emissions on graphs are related to either the BTLE 2.4 GHz, LF 125 kHz operation and are not intermodulation products.

## 12 Measurement Uncertainty

### Calculated Measurement Uncertainties

All statements of uncertainty are expanded standard uncertainty using a coverage factor of 1.96 to give a 95 % confidence:

#### [1] Radiated spurious emissions

Uncertainty in test result (30 MHz to 1 GHz) = **4.6 dB**

Uncertainty in test result (1 GHz to 18 GHz) = **4.7 dB**

## 13 RF EXPOSURE TECHNICAL BRIEF

### RSS-102 issue 5

#### 2.5.2 Exemption Limits for Routine Evaluation – RF Exposure Evaluation

RF exposure evaluation is required if the separation distance between the user and/or bystander and the device's radiating element is greater than 20 cm, except when the device operates as follows:

- below 20 MHz and the source-based, time-averaged maximum e.i.r.p. of the device is equal to or less than 1 W (adjusted for tune-up tolerance);
- at or above 20 MHz and below 48 MHz and the source-based, time-averaged maximum e.i.r.p. of the device is equal to or less than  $4.49/f^{0.5}W$  (adjusted for tune-up tolerance), where  $f$  is in MHz;
- at or above 48 MHz and below 300 MHz and the source-based, time-averaged maximum e.i.r.p. of the device is equal to or less than 0.6 W (adjusted for tune-up tolerance);
- at or above 300 MHz and below 6 GHz and the source-based, time-averaged maximum e.i.r.p. of the device is equal to or less than  $1.31 \times 10^{-2} f^{0.6834} W$  (adjusted for tune-up tolerance), where  $f$  is in MHz;
- at or above 6 GHz and the source-based, time-averaged maximum e.i.r.p. of the device is equal to or less than 5 W (adjusted for tune-up tolerance).

<i>Radio Type</i>	<i>Frequency (MHz)</i>	<i>EIRP (mW)</i>	<i>RF Exposure Exclusion Threshold (W)</i>	<i>Ratio</i>	<i>Sum of Ratios</i>	<i>RF Exposure Evaluation</i>
LF	0.125	15.1	1.0	0.015	0.016	Not Required
BTLE	2402	1.3	2.7	0.000		