

**ELECTROMAGNETIC EMISSIONS
COMPLIANCE REPORT**

Applicant: SHARP Corporation Mobile Communication BU
2-13-1 Iida Hachihonmatsu, Higashi-hiroshima city, Hiroshima,
739-0192, Japan

Manufacturer: Sharp Corporation
1 Takumi-cho, Sakai-ku, Sakai City, Osaka 590-8522, Japan

Product Name: Smart Phone

Brand Name: SHARP

Report Number: TERF2404001033ER

FCC ID APYHRO00332

Date of EUT Received: April 18, 2024

Date of Test: April 18, 2024~May 14, 2024

Issue Date: May 22, 2024

Approved By _____

Blue Yang

We hereby certify that:

The above equipment was tested by SGS Taiwan Ltd. Central RF Lab. The test data, data evaluation, test procedures, and equipment configurations shown in this report were made in accordance with the procedures given in ANSI C63.10:2013 and the energy emitted by the sample EUT comply with FCC rule part §15.247.

The results of this report relate only to the sample identified in this report.

Unless otherwise stated the results shown in this test report refer only to the sample(s) tested and such sample(s) are retained for 90 days only.
除非另有說明，此報告結果僅對測試之樣品負責，同時此樣品僅保留90天。本報告未經本公司書面許可，不可部份複製。

This document is issued by the Company subject to its General Conditions of Service printed overleaf, available on request or accessible at <http://www.sgs.com.tw/Terms-and-Conditions> and for electronic format documents, subject to Terms and Conditions for Electronic Documents at <http://www.sgs.com.tw/Terms-and-Conditions>. Attention is drawn to the limitation of liability, indemnification and jurisdiction issues defined therein. Any holder of this document is advised that information contained hereon reflects the Company's findings at the time of its intervention only and within the limits of Client's instructions, if any. The Company's sole responsibility is to its Client and this document does not exonerate parties to a transaction from exercising all their rights and obligations under the transaction documents. This document cannot be reproduced except in full, without prior written approval of the Company. Any unauthorized alteration, forgery or falsification of the content or appearance of this document is unlawful and offenders may be prosecuted to the fullest extent of the law.

Revision History

Report Number	Revision	Description	Issue Date	Revised By	Remark
TERF2404001033ER	00	Original.	May 22, 2024	Karen Huang	

Note:

- 1、The remark "*" indicates modification of the report upon requests from certification body.

Unless otherwise stated the results shown in this test report refer only to the sample(s) tested and such sample(s) are retained for 90 days only.
 除非另有說明，此報告結果僅對測試之樣品負責，同時此樣品僅保留90天。本報告未經本公司書面許可，不可部份複製。

This document is issued by the Company subject to its General Conditions of Service printed overleaf, available on request or accessible at <http://www.sgs.com.tw/Terms-and-Conditions> and for electronic format documents, subject to Terms and Conditions for Electronic Documents at <http://www.sgs.com.tw/Terms-and-Conditions>. Attention is drawn to the limitation of liability, indemnification and jurisdiction issues defined therein. Any holder of this document is advised that information contained hereon reflects the Company's findings at the time of its intervention only and within the limits of Client's instructions, if any. The Company's sole responsibility is to its Client and this document does not exonerate parties to a transaction from exercising all their rights and obligations under the transaction documents. This document cannot be reproduced except in full, without prior written approval of the Company. Any unauthorized alteration, forgery or falsification of the content or appearance of this document is unlawful and offenders may be prosecuted to the fullest extent of the law.

Table of Contents

1	GENERAL INFORMATION	4
2	SYSTEM TEST CONFIGURATION.....	7
3	SUMMARY OF TEST RESULTS.....	10
4	DESCRIPTION OF TEST MODES.....	11
5	MEASUREMENT UNCERTAINTY	13
6	MEASUREMENT EQUIPMENT USED	14
7	CONDUCTED EMISSION TEST	16
8	PEAK OUTPUT POWER MEASUREMENT	20
9	EMISSION BANDWIDTH MEASUREMENT	32
10	CONDUCTED BAND EDGES AND SPURIOUS EMISSION MEASUREMENT	39
11	RADIATED BANDEDGE AND SPURIOUS EMISSION MEASUREMENT.....	55
12	POWER SPECTRAL DENSITY	143
13	ANTENNA REQUIREMENT.....	151

Unless otherwise stated the results shown in this test report refer only to the sample(s) tested and such sample(s) are retained for 90 days only.
 除非另有說明，此報告結果僅對測試之樣品負責，同時此樣品僅保留90天。本報告未經本公司書面許可，不可部份複製。

This document is issued by the Company subject to its General Conditions of Service printed overleaf, available on request or accessible at <http://www.sgs.com.tw/Terms-and-Conditions> and for electronic format documents, subject to Terms and Conditions for Electronic Documents at <http://www.sgs.com.tw/Terms-and-Conditions>. Attention is drawn to the limitation of liability, indemnification and jurisdiction issues defined therein. Any holder of this document is advised that information contained hereon reflects the Company's findings at the time of its intervention only and within the limits of Client's instructions, if any. The Company's sole responsibility is to its Client and this document does not exonerate parties to a transaction from exercising all their rights and obligations under the transaction documents. This document cannot be reproduced except in full, without prior written approval of the Company. Any unauthorized alteration, forgery or falsification of the content or appearance of this document is unlawful and offenders may be prosecuted to the fullest extent of the law.

1 GENERAL INFORMATION

1.1 Product Description

Product Name:	Smart Phone
Brand Name:	SHARP
Hardware Version:	DVT
Firmware Version:	N/A
Power Supply:	3.89Vdc from Rechargeable Battery
Test Software (Name/Version)	Tera Term/4.106

1.2 RF Specification

Radio Technology:	BLE
Frequency Range:	2402 – 2480MHz
Channel number:	40 channels
Modulation type:	GFSK
Transmit Power:	BLE 1M: 6.97dBm BLE 2M: 6.89dBm PHY=8: 6.94dBm PHY=2: 6.88dBm

1.3 Antenna Designation

Antenna Type	Antenna Model No.	Freq.	Peak Antenna Gain (dBi)
Inverted-F Antenna	ANT4	2.4GHz	-3.7
	ANT8	2.4GHz	-0.9

Note:

1. Measurements was done on the above antennas.
2. Antenna information is provided by the applicant.

Unless otherwise stated the results shown in this test report refer only to the sample(s) tested and such sample(s) are retained for 90 days only.
除非另有說明，此報告結果僅對測試之樣品負責，同時此樣品僅保留90天。本報告未經本公司書面許可，不可部份複製。

This document is issued by the Company subject to its General Conditions of Service printed overleaf, available on request or accessible at <http://www.sgs.com.tw/Terms-and-Conditions> and for electronic format documents, subject to Terms and Conditions for Electronic Documents at <http://www.sgs.com.tw/Terms-and-Conditions>. Attention is drawn to the limitation of liability, indemnification and jurisdiction issues defined therein. Any holder of this document is advised that information contained hereon reflects the Company's findings at the time of its intervention only and within the limits of Client's instructions, if any. The Company's sole responsibility is to its Client and this document does not exonerate parties to a transaction from exercising all their rights and obligations under the transaction documents. This document cannot be reproduced except in full, without prior written approval of the Company. Any unauthorized alteration, forgery or falsification of the content or appearance of this document is unlawful and offenders may be prosecuted to the fullest extent of the law.

1.4 Test Methodology of Applied Standards

FCC Part 15, Subpart C §15.247
 FCC KDB 558074 D01 15.247 Meas Guidance v05r02
 ANSI C63.10:2013

1.5 Test Facility

Laboratory	Test Site Address	Test Site Name	FCC Designation number	IC CAB identifier
SGS Taiwan Ltd. Central RF Lab. (TAF code 3702)	No.134, Wu Kung Road, New Taipei Industrial Park, Wuku District, New Taipei City, Taiwan.	SAC 1	TW0027	TW3702
		SAC 2		
		SAC 3		
		Conduction 1		
		Conducted 1		
		Conducted 2		
		Conducted 3		
		Conducted 4		
		Conducted 5		
		Conducted 6		
	No.2, Keji 1st Rd., Guishan District, Taoyuan City, Taiwan 333	Conduction C	TW0028	
		SAC C		
		SAC D		
		SAC G		
		Conducted A		
		Conducted B		
		Conducted C		
		Conducted D		
		Conducted E		
Conducted F				
Conducted G				

Note: Test site name is remarked on the equipment list in each section of this report as an indication where measurements occurred in specific test site and address.

Unless otherwise stated the results shown in this test report refer only to the sample(s) tested and such sample(s) are retained for 90 days only.
 除非另有說明，此報告結果僅對測試之樣品負責，同時此樣品僅保留90天。本報告未經本公司書面許可，不可部份複製。

This document is issued by the Company subject to its General Conditions of Service printed overleaf, available on request or accessible at <http://www.sgs.com.tw/Terms-and-Conditions> and for electronic format documents, subject to Terms and Conditions for Electronic Documents at <http://www.sgs.com.tw/Terms-and-Conditions>. Attention is drawn to the limitation of liability, indemnification and jurisdiction issues defined therein. Any holder of this document is advised that information contained hereon reflects the Company's findings at the time of its intervention only and within the limits of Client's instructions, if any. The Company's sole responsibility is to its Client and this document does not exonerate parties to a transaction from exercising all their rights and obligations under the transaction documents. This document cannot be reproduced except in full, without prior written approval of the Company. Any unauthorized alteration, forgery or falsification of the content or appearance of this document is unlawful and offenders may be prosecuted to the fullest extent of the law.

1.6 Special Accessories

There are no special accessories used while test was conducted.

1.7 Equipment Modifications

There was no modification incorporated into the EUT.

Unless otherwise stated the results shown in this test report refer only to the sample(s) tested and such sample(s) are retained for 90 days only.
除非另有說明，此報告結果僅對測試之樣品負責，同時此樣品僅保留90天。本報告未經本公司書面許可，不可部份複製。

This document is issued by the Company subject to its General Conditions of Service printed overleaf, available on request or accessible at <http://www.sgs.com.tw/Terms-and-Conditions> and for electronic format documents, subject to Terms and Conditions for Electronic Documents at <http://www.sgs.com.tw/Terms-and-Conditions>. Attention is drawn to the limitation of liability, indemnification and jurisdiction issues defined therein. Any holder of this document is advised that information contained hereon reflects the Company's findings at the time of its intervention only and within the limits of Client's instructions, if any. The Company's sole responsibility is to its Client and this document does not exonerate parties to a transaction from exercising all their rights and obligations under the transaction documents. This document cannot be reproduced except in full, without prior written approval of the Company. Any unauthorized alteration, forgery or falsification of the content or appearance of this document is unlawful and offenders may be prosecuted to the fullest extent of the law.

2 SYSTEM TEST CONFIGURATION

2.1 EUT Configuration

The EUT configuration for testing is installed on RF field strength measurement to meet the Commissions requirement and operating in a manner which intends to maximize its emission characteristics in a continuous normal application.

2.2 EUT Exercise

An engineering test mode (software/firmware) that applicant provided was utilized to manipulate the EUT into transmit, selection of the test channel, and modulation scheme.

2.3 Test Procedure

2.3.1 Conducted Emissions

The EUT is placed on a table which is 0.8 m above ground plane. Conducted emissions from the EUT measured in the frequency range between 0.15 MHz and 30MHz. The CISPR Quasi-Peak and Average detector mode is employed. The two LISNs provide 50uH/50 ohm of coupling impedance for the measuring instrument. Both lines of the power mains connected to the EUT were checked for maximum conducted interference.

2.3.2 Conducted Test (RF)

The active antenna port of the unlicensed wireless device is connected to the spectrum analyzer with attenuator to protect the instrumentation. If a second antenna port is available, it is tested at one operating frequency, with other port(s) appropriately terminated, to verify it has similar output characteristics as the fully tested port.

2.3.3 Radiated Emissions

The EUT is placed on a turn table. For emissions testing at or below 1 GHz, the table height shall be 0.8 m above the reference ground plane. For emission measurements above 1 GHz, the table height shall be 1.5 m. The turn table shall rotate 360 degrees to determine the position of maximum emission level. EUT is set 3m away from the receiving antenna which varied from 1m to 4m to find out the highest emission. And also, each emission was to be maximized by changing the polarization of receiving antenna both horizontal and vertical. In order to find out the max. emission, the relative positions of this transmitter (EUT) was rotated through three orthogonal axes and measurement procedures for electric field radiated emissions above 1 GHz the EUT measurement is to be made "while keeping the antenna in the 'cone of radiation' from that area and pointed at the area both in azimuth and elevation, with polarization oriented for maximum response." is still within the 3dB illumination BW of the measurement antenna.

Unless otherwise stated the results shown in this test report refer only to the sample(s) tested and such sample(s) are retained for 90 days only.
除非另有說明，此報告結果僅對測試之樣品負責，同時此樣品僅保留90天。本報告未經本公司書面許可，不可部份複製。

This document is issued by the Company subject to its General Conditions of Service printed overleaf, available on request or accessible at <http://www.sgs.com.tw/Terms-and-Conditions> and for electronic format documents, subject to Terms and Conditions for Electronic Documents at <http://www.sgs.com.tw/Terms-and-Conditions>. Attention is drawn to the limitation of liability, indemnification and jurisdiction issues defined therein. Any holder of this document is advised that information contained hereon reflects the Company's findings at the time of its intervention only and within the limits of Client's instructions, if any. The Company's sole responsibility is to its Client and this document does not exonerate parties to a transaction from exercising all their rights and obligations under the transaction documents. This document cannot be reproduced except in full, without prior written approval of the Company. Any unauthorized alteration, forgery or falsification of the content or appearance of this document is unlawful and offenders may be prosecuted to the fullest extent of the law.

2.4 Measurement Results Explanation Example

2.4.1 Radiated Emission Test Sites For Measurements From 9 kHz To 30 MHz

Radiated emission below 30MHz is measured in a 9m*6m*6m semi-anechoic chamber, the measurements correspond to those obtained at an open-field test site.

There is a comparison data of both open-field test site and semi-Anechoic chamber, and the result came out very similar.

2.4.2 For all conducted test items:

The offset level is set in the spectrum analyzer to compensate the RF cable loss and attenuation factor between EUT conducted port and spectrum analyzer. With the offset compensation, the spectrum analyzer reading level is exactly EUT RF output level.

Unless otherwise stated the results shown in this test report refer only to the sample(s) tested and such sample(s) are retained for 90 days only.
除非另有說明，此報告結果僅對測試之樣品負責，同時此樣品僅保留90天。本報告未經本公司書面許可，不可部份複製。

This document is issued by the Company subject to its General Conditions of Service printed overleaf, available on request or accessible at <http://www.sgs.com.tw/Terms-and-Conditions> and for electronic format documents, subject to Terms and Conditions for Electronic Documents at <http://www.sgs.com.tw/Terms-and-Conditions>. Attention is drawn to the limitation of liability, indemnification and jurisdiction issues defined therein. Any holder of this document is advised that information contained hereon reflects the Company's findings at the time of its intervention only and within the limits of Client's instructions, if any. The Company's sole responsibility is to its Client and this document does not exonerate parties to a transaction from exercising all their rights and obligations under the transaction documents. This document cannot be reproduced except in full, without prior written approval of the Company. Any unauthorized alteration, forgery or falsification of the content or appearance of this document is unlawful and offenders may be prosecuted to the fullest extent of the law.

2.5 Test Configuration

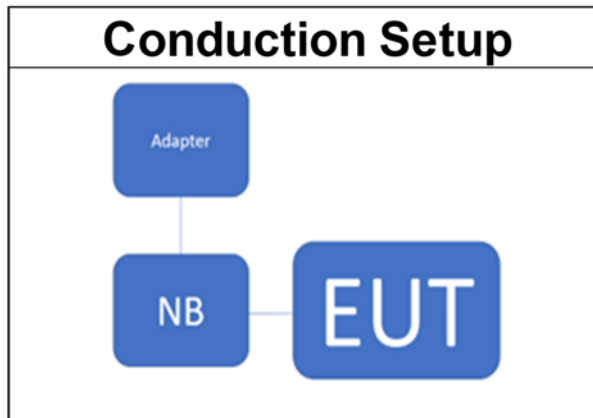
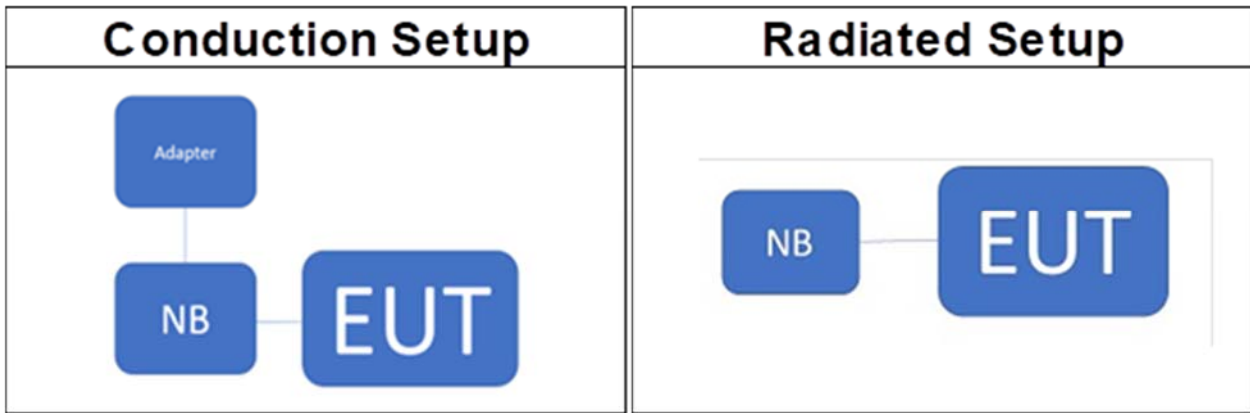

2.6 Control Unit(s)

AC Power-Line Conducted Emission Test Site: Conduction 1					
EQUIPMENT TYPE	MFR	MODEL NUMBER	SERIAL NUMBER	LAST CAL.	CAL DUE.
Notebook	Lenovo	T470	PF-0TGY30 17/07	N/A	N/A
Adapter	Lenovo	ADLX90NCC3A	N/A	N/A	N/A
Conducted Emission Test Site: Conducted 1					
EQUIPMENT TYPE	MFR	MODEL NUMBER	SERIAL NUMBER	LAST CAL.	CAL DUE.
Notebook	Lenovo	T470	PF-0TGY30 17/07	N/A	N/A
Radiated Emission Test Site: SAC 2					
EQUIPMENT TYPE	MFR	MODEL NUMBER	SERIAL NUMBER	LAST CAL.	CAL DUE.
Notebook	Lenovo	T470	PF-0TGY30 17/07	N/A	N/A

Unless otherwise stated the results shown in this test report refer only to the sample(s) tested and such sample(s) are retained for 90 days only.

除非另有說明，此報告結果僅對測試之樣品負責，同時此樣品僅保留90天。本報告未經本公司書面許可，不可部份複製。

This document is issued by the Company subject to its General Conditions of Service printed overleaf, available on request or accessible at <http://www.sgs.com.tw/Terms-and-Conditions>, and for electronic format documents, subject to Terms and Conditions for Electronic Documents at <http://www.sgs.com.tw/Terms-and-Conditions>. Attention is drawn to the limitation of liability, indemnification and jurisdiction issues defined therein. Any holder of this document is advised that information contained herein reflects the Company's findings at the time of its intervention only and within the limits of Client's instructions, if any. The Company's sole responsibility is to its Client and this document does not exonerate parties to a transaction from exercising all their rights and obligations under the transaction documents. This document cannot be reproduced except in full, without prior written approval of the Company. Any unauthorized alteration, forgery or falsification of the content or appearance of this document is unlawful and offenders may be prosecuted to the fullest extent of the law.

3 SUMMARY OF TEST RESULTS

FCC Rules	Description Of Test	Result
§15.207(a)	AC Power Line Conducted Emission	Compliant
§15.247(b)(3)	Peak Output Power	Compliant
§15.247(a)(2)	Emission Bandwidth	Compliant
§15.247(d) §15.209	Conducted Band Edge and Spurious Emission	Compliant
§15.247(d) §15.209	Radiated Band Edge and Spurious Emission	Compliant
§15.205	Restricted Bands	Compliant
§15.247(e)	Peak Power Density	Compliant
§15.203	Antenna Requirement	Compliant

Unless otherwise stated the results shown in this test report refer only to the sample(s) tested and such sample(s) are retained for 90 days only.

除非另有說明，此報告結果僅對測試之樣品負責，同時此樣品僅保留90天。本報告未經本公司書面許可，不可部份複製。

This document is issued by the Company subject to its General Conditions of Service printed overleaf, available on request or accessible at <http://www.sgs.com.tw/Terms-and-Conditions> and for electronic format documents, subject to Terms and Conditions for Electronic Documents at <http://www.sgs.com.tw/Terms-and-Conditions>. Attention is drawn to the limitation of liability, indemnification and jurisdiction issues defined therein. Any holder of this document is advised that information contained hereon reflects the Company's findings at the time of its intervention only and within the limits of Client's instructions, if any. The Company's sole responsibility is to its Client and this document does not exonerate parties to a transaction from exercising all their rights and obligations under the transaction documents. This document cannot be reproduced except in full, without prior written approval of the Company. Any unauthorized alteration, forgery or falsification of the content or appearance of this document is unlawful and offenders may be prosecuted to the fullest extent of the law.

4 DESCRIPTION OF TEST MODES

4.1 Operating Frequencies

2400~2483.5 MHz							
CH	Freq. (MHz)	CH	Freq. (MHz)	CH	Freq. (MHz)	CH	Freq. (MHz)
0	2402	10	2422	20	2442	30	2462
1	2404	11	2424	21	2444	31	2464
2	2406	12	2426	22	2446	32	2466
3	2408	13	2428	23	2448	33	2468
4	2410	14	2430	24	2450	34	2470
5	2412	15	2432	25	2452	35	2472
6	2414	16	2434	26	2454	36	2474
7	2416	17	2436	27	2456	37	2476
8	2418	18	2438	28	2458	38	2478
9	2420	19	2440	29	2460	39	2480

4.2 The Worst Test Modes and Channel Details

1. The EUT has been tested under operating condition.
2. Test program used to control the EUT for staying in continuous transmitting and receiving mode is programmed.
3. The field strength of radiation emission was measured as the EUT positioned in different orthogonal planes (E1/E2/H) based on actual usage of the EUT to pre-scan the emissions for determining the worst case scenario.
4. Investigation has been done on all the possible configurations for searching the worst case.

CONDUCTED TEST				
MODE	AVAILABLE CHANNEL	TESTED CHANNEL	MODULATION	DATA RATE (Mbps)
Bluetooth LE	0 to 39	0,19,39	GFSK	1
Bluetooth LE	0 to 39	0,19,39	GFSK	2
PHY=8	0 to 39	0,19,39	GFSK	0.125
PHY=2	0 to 39	0,19,39	GFSK	0.5

Unless otherwise stated the results shown in this test report refer only to the sample(s) tested and such sample(s) are retained for 90 days only.

除非另有說明，此報告結果僅對測試之樣品負責，同時此樣品僅保留90天。本報告未經本公司書面許可，不可部份複製。

This document is issued by the Company subject to its General Conditions of Service printed overleaf, available on request or accessible at <http://www.sgs.com.tw/Terms-and-Conditions> and for electronic format documents, subject to Terms and Conditions for Electronic Documents at <http://www.sgs.com.tw/Terms-and-Conditions>. Attention is drawn to the limitation of liability, indemnification and jurisdiction issues defined therein. Any holder of this document is advised that information contained herein reflects the Company's findings at the time of its intervention only and within the limits of Client's instructions, if any. The Company's sole responsibility is to its Client and this document does not exonerate parties to a transaction from exercising all their rights and obligations under the transaction documents. This document cannot be reproduced except in full, without prior written approval of the Company. Any unauthorized alteration, forgery or falsification of the content or appearance of this document is unlawful and offenders may be prosecuted to the fullest extent of the law.

TRANSMIT RADIATED EMISSION TEST (BELOW 1 GHz)				
MODE	AVAILABLE CHANNEL	TESTED CHANNEL	MODULATION	DATA RATE (Mbps)
Bluetooth LE	0 to 39	19	GFSK	1
TRANSMIT RADIATED EMISSION TEST (ABOVE 1 GHz)				
MODE	AVAILABLE CHANNEL	TESTED CHANNEL	MODULATION	DATA RATE (Mbps)
Bluetooth LE	0 to 39	0,19,39	GFSK	1
Bluetooth LE	0 to 39	0,19,39	GFSK	2
Bluetooth LE	0 to 39	0,19,39	GFSK	0.125
Bluetooth LE	0 to 39	0,19,39	GFSK	0.5

Unless otherwise stated the results shown in this test report refer only to the sample(s) tested and such sample(s) are retained for 90 days only.

除非另有說明，此報告結果僅對測試之樣品負責，同時此樣品僅保留90天。本報告未經本公司書面許可，不可部份複製。

This document is issued by the Company subject to its General Conditions of Service printed overleaf, available on request or accessible at <http://www.sgs.com.tw/Terms-and-Conditions> and for electronic format documents, subject to Terms and Conditions for Electronic Documents at <http://www.sgs.com.tw/Terms-and-Conditions>. Attention is drawn to the limitation of liability, indemnification and jurisdiction issues defined therein. Any holder of this document is advised that information contained hereon reflects the Company's findings at the time of its intervention only and within the limits of Client's instructions, if any. The Company's sole responsibility is to its Client and this document does not exonerate parties to a transaction from exercising all their rights and obligations under the transaction documents. This document cannot be reproduced except in full, without prior written approval of the Company. Any unauthorized alteration, forgery or falsification of the content or appearance of this document is unlawful and offenders may be prosecuted to the fullest extent of the law.

SGS Taiwan Ltd.

No.134,Wu Kung Road, New Taipei Industrial Park, Wuku District, New Taipei City, Taiwan/新北市五股區新北產業園區五工路 134 號

台灣檢驗科技股份有限公司

t (886-2) 2299-3279

f (886-2) 2298-0488

www.sgs.com.tw

Member of SGS Group

5 MEASUREMENT UNCERTAINTY

Test Items	Uncertainty
AC Power Line Conducted Emission	+/- 1.54 dB
Output Power measurement	+/- 0.97 dB
Emission Bandwidth	+/- 1.38 Hz
Conducted emission measurement	+/- 0.77 dB
Peak Power Density	+/- 0.61 dB
Temperature	+/- 0.6 °C
Humidity	+/- 3 %
DC / AC Power Source	+/- 1 %

Radiated Spurious Emission Measurement Uncertainty			
Polarization: Vertical	+/-	1.89 dB	9kHz~30MHz
	+/-	4.15 dB	30MHz - 1000MHz
	+/-	3.43 dB	1GHz - 18GHz
	+/-	3.86 dB	18GHz - 40GHz
Polarization: Horizontal	+/-	1.89 dB	9kHz~30MHz
	+/-	4.02 dB	30MHz - 1000MHz
	+/-	3.43 dB	1GHz - 18GHz
	+/-	3.86 dB	18GHz - 40GHz
Radiated Spurious Emission	+/-	2 dB	33GHz-50GHz
	+/-	1.59 dB	50GHz-60GHz
	+/-	1.7 dB	60GHz-90GHz
	+/-	1.64 dB	90GHz-140GHz
	+/-	3.83 dB	140GHz-220GHz

Note:

1. This uncertainty represents an expanded uncertainty expressed at approximately the 95% confidence level using a coverage factor of k=2.
2. The conformity assessment statement in this report is based solely on the test results, measurement uncertainty is excluded.

Unless otherwise stated the results shown in this test report refer only to the sample(s) tested and such sample(s) are retained for 90 days only.

除非另有說明，此報告結果僅對測試之樣品負責，同時此樣品僅保留90天。本報告未經本公司書面許可，不可部份複製。
This document is issued by the Company subject to its General Conditions of Service printed overleaf, available on request or accessible at <http://www.sgs.com.tw/Terms-and-Conditions> and for electronic format documents, subject to Terms and Conditions for Electronic Documents at <http://www.sgs.com.tw/Terms-and-Conditions>. Attention is drawn to the limitation of liability, indemnification and jurisdiction issues defined therein. Any holder of this document is advised that information contained hereon reflects the Company's findings at the time of its intervention only and within the limits of Client's instructions, if any. The Company's sole responsibility is to its Client and this document does not exonerate parties to a transaction from exercising all their rights and obligations under the transaction documents. This document cannot be reproduced except in full, without prior written approval of the Company. Any unauthorized alteration, forgery or falsification of the content or appearance of this document is unlawful and offenders may be prosecuted to the fullest extent of the law.

6 MEASUREMENT EQUIPMENT USED

6.1 Emission from AC power line

AC Power-Line Conducted Emission Test Site: Conduction 1					
EQUIPMENT TYPE	MFR	MODEL NUMBER	SERIAL NUMBER	LAST CAL.	CAL DUE.
Test Software	Audix	e3	Ver. 9.210616	N.C.R	N.C.R
LISN	SCHWARZBECK	NSLK 8127	1040	09/06/2023	09/05/2024
Coaxial Cables	EMC Instruments Corp.	EMCCFD300-BM-BM-3000	161207	06/22/2023	06/21/2024
Pulse Limiter	SCHWARZBECK	VTSD 9561F-N	793	06/22/2023	06/21/2024
EMI Test Receiver	R&S	ESCI 7	100759	08/21/2023	08/20/2024

6.2 Conducted Measurement

Conducted Emission Test Site: Conducted 1					
EQUIPMENT TYPE	MFR	MODEL NUMBER	SERIAL NUMBER	LAST CAL.	CAL DUE.
EXA Spectrum Analyzer	KEYSIGHT	N9010B	MY59071571	06/07/2023	06/06/2024
Test Software	SGS	Radio Test Software	Ver. 21	N.C.R	N.C.R
Power Meter	Anritsu	ML2496A	1242004	10/24/2023	10/23/2024
Power Sensor	Anritsu	MA2411B	1207365	10/24/2023	10/23/2024
Power Sensor	Anritsu	MA2411B	1207368	10/24/2023	10/23/2024
DC Power Supply	Agilent	E3640A	KR93300208	09/12/2023	09/11/2024
DC Block	Mini-Circuits	BLK-18-S+	10	12/12/2023	12/11/2024

Unless otherwise stated the results shown in this test report refer only to the sample(s) tested and such sample(s) are retained for 90 days only.

除非另有說明，此報告結果僅對測試之樣品負責，同時此樣品僅保留90天。本報告未經本公司書面許可，不可部份複製。
This document is issued by the Company subject to its General Conditions of Service printed overleaf, available on request or accessible at <http://www.sgs.com.tw/Terms-and-Conditions> and for electronic format documents, subject to Terms and Conditions for Electronic Documents at <http://www.sgs.com.tw/Terms-and-Conditions>. Attention is drawn to the limitation of liability, indemnification and jurisdiction issues defined therein. Any holder of this document is advised that information contained hereon reflects the Company's findings at the time of its intervention only and within the limits of Client's instructions, if any. The Company's sole responsibility is to its Client and this document does not exonerate parties to a transaction from exercising all their rights and obligations under the transaction documents. This document cannot be reproduced except in full, without prior written approval of the Company. Any unauthorized alteration, forgery or falsification of the content or appearance of this document is unlawful and offenders may be prosecuted to the fullest extent of the law.

6.3 Radiated Measurement

Radiated Emission Test Site: SAC 2					
EQUIPMENT TYPE	MFR	MODEL NUMBER	SERIAL NUMBER	LAST CAL.	CAL DUE.
Loop Antenna	COM-POWER	AL-130R	10160104	12/04/2023	12/03/2024
Horn Antenna	RF SPIN	DRH0844	LE2D05A0844	07/03/2023	07/02/2024
Horn Antenna	RF SPIN	DRH18-E	210303A18-ES	02/16/2024	02/15/2025
Bi-log Antenna	SCHWARZBECK	VULB9168	9168-1278	03/04/2024	03/03/2025
EXA Spectrum Analyzer	KEYSIGHT	N9010B	MY60242392	12/22/2023	12/21/2024
Test Software	Audix	e3	Ver. 9.210616	N.C.R	N.C.R
EMI Test Receiver	R&S	ESCI 7	100759	08/21/2023	08/20/2024
Site Cal	SGS	SAC 2	N/A	08/31/2023	08/30/2024
Pre-Amplifier	EMCI	EMC184045B	980135	08/31/2023	08/30/2024
Pre-Amplifier	EMCI	EMC330N	980826	08/31/2023	08/30/2024
Pre-Amplifier	EMCI	EMC118A45SEE	980867	08/31/2023	08/30/2024
4G High Pass Filter	WI	WHKX4.0	21	12/12/2023	12/11/2024
Band Reject Filter 2400-2483.5	EWT	EWT-14-0166	M3	12/12/2023	12/11/2024
Attenuator	Mini-Circuits	BW-S10W2+	23	12/12/2023	12/11/2024
Coaxial Cables	Huber Suhner	SUCOFLEX 102	RX Cable 18G-40G MY2630/2+805062/ 2	08/31/2023	08/30/2024
Coaxial Cables	EMCI	EMC104-SM-SM-1000+EMC105-SM-SM-1000+EMC105-SM-SM-1500+EMC104-SM-SM-600+EMC105-SM-SM-2000	RX Cable 9K-18G (220236+201211+220906+220237+220909)	08/31/2023	08/30/2024

NOTE: N.C.R refers to Not Calibrated Required.

Unless otherwise stated the results shown in this test report refer only to the sample(s) tested and such sample(s) are retained for 90 days only.

除非另有說明，此報告結果僅對測試之樣品負責，同時此樣品僅保留90天。本報告未經本公司書面許可，不可部份複製。

This document is issued by the Company subject to its General Conditions of Service printed overleaf, available on request or accessible at <http://www.sgs.com.tw/Terms-and-Conditions> and for electronic format documents, subject to Terms and Conditions for Electronic Documents at <http://www.sgs.com.tw/Terms-and-Conditions>. Attention is drawn to the limitation of liability, indemnification and jurisdiction issues defined therein. Any holder of this document is advised that information contained hereon reflects the Company's findings at the time of its intervention only and within the limits of Client's instructions, if any. The Company's sole responsibility is to its Client and this document does not exonerate parties to a transaction from exercising all their rights and obligations under the transaction documents. This document cannot be reproduced except in full, without prior written approval of the Company. Any unauthorized alteration, forgery or falsification of the content or appearance of this document is unlawful and offenders may be prosecuted to the fullest extent of the law.

7 CONDUCTED EMISSION TEST

7.1 Standard Applicable:

Frequency range within 150kHz to 30MHz shall not exceed the Limit table as below.

Frequency range MHz	Limits (dB μ V)	
	Quasi-peak	Average
0.15 to 0.50	66 to 56	56 to 46
0.50 to 5	56	46
5 to 30	60	50

Note

1. The lower limit shall apply at the transition frequencies
2. The limit decreases linearly with the logarithm of the frequency in the range 0.15 MHz to 0.50 MHz.

7.2 EUT Setup:

1. The conducted emission tests were performed in the test site, using the setup in accordance with the ANSI C63.10:2013.
2. The AC/DC Power adaptor of EUT was plug-in LISN. The EUT was placed flushed with the rear of the table.
3. The LISN was connected with 120Vac/60Hz power source.

7.3 Test Setup

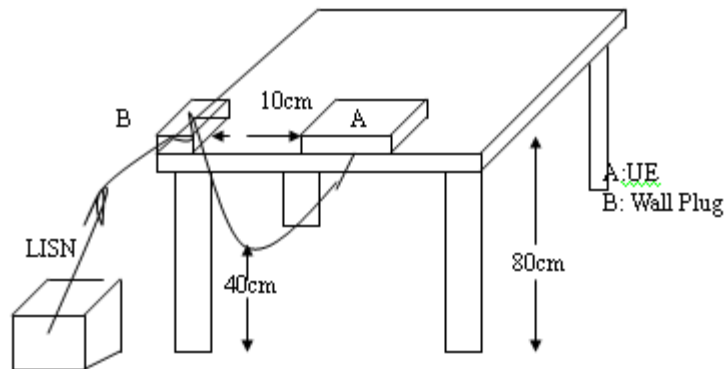

Unless otherwise stated the results shown in this test report refer only to the sample(s) tested and such sample(s) are retained for 90 days only.

除非另有說明，此報告結果僅對測試之樣品負責，同時此樣品僅保留90天。本報告未經本公司書面許可，不可部份複製。
This document is issued by the Company subject to its General Conditions of Service printed overleaf, available on request or accessible at <http://www.sgs.com.tw/Terms-and-Conditions> and for electronic format documents, subject to Terms and Conditions for Electronic Documents at <http://www.sgs.com.tw/Terms-and-Conditions>. Attention is drawn to the limitation of liability, indemnification and jurisdiction issues defined therein. Any holder of this document is advised that information contained hereon reflects the Company's findings at the time of its intervention only and within the limits of Client's instructions, if any. The Company's sole responsibility is to its Client and this document does not exonerate parties to a transaction from exercising all their rights and obligations under the transaction documents. This document cannot be reproduced except in full, without prior written approval of the Company. Any unauthorized alteration, forgery or falsification of the content or appearance of this document is unlawful and offenders may be prosecuted to the fullest extent of the law.

7.4 Measurement Procedure:

1. The EUT was placed on a table which is 0.8m above ground plane.
2. Maximum procedure was performed on the six highest emissions to ensure EUT compliance.
3. Repeat above procedures until all phases of power being supplied by given UE are completed

7.5 Measurement Result:

Note: Refer to next page for measurement data and plots.

Note2: The * reveals the worst-case results that closest to the limit.

Unless otherwise stated the results shown in this test report refer only to the sample(s) tested and such sample(s) are retained for 90 days only.
除非另有說明，此報告結果僅對測試之樣品負責，同時此樣品僅保留90天。本報告未經本公司書面許可，不可部份複製。

This document is issued by the Company subject to its General Conditions of Service printed overleaf, available on request or accessible at <http://www.sgs.com.tw/Terms-and-Conditions> and for electronic format documents, subject to Terms and Conditions for Electronic Documents at <http://www.sgs.com.tw/Terms-and-Conditions>. Attention is drawn to the limitation of liability, indemnification and jurisdiction issues defined therein. Any holder of this document is advised that information contained hereon reflects the Company's findings at the time of its intervention only and within the limits of Client's instructions, if any. The Company's sole responsibility is to its Client and this document does not exonerate parties to a transaction from exercising all their rights and obligations under the transaction documents. This document cannot be reproduced except in full, without prior written approval of the Company. Any unauthorized alteration, forgery or falsification of the content or appearance of this document is unlawful and offenders may be prosecuted to the fullest extent of the law.

AC POWER LINE CONDUCTED EMISSION TEST DATA

Report Number :TERF2404001033ER
 Operation Mode :BLE
 Power :120V/60Hz
 Probe :L
 Note: :

Test Site :Conduction 1
 Test Date :2024-05-10
 Temp./Humi. :23.0°C/50%
 Engineer :Eason Wang

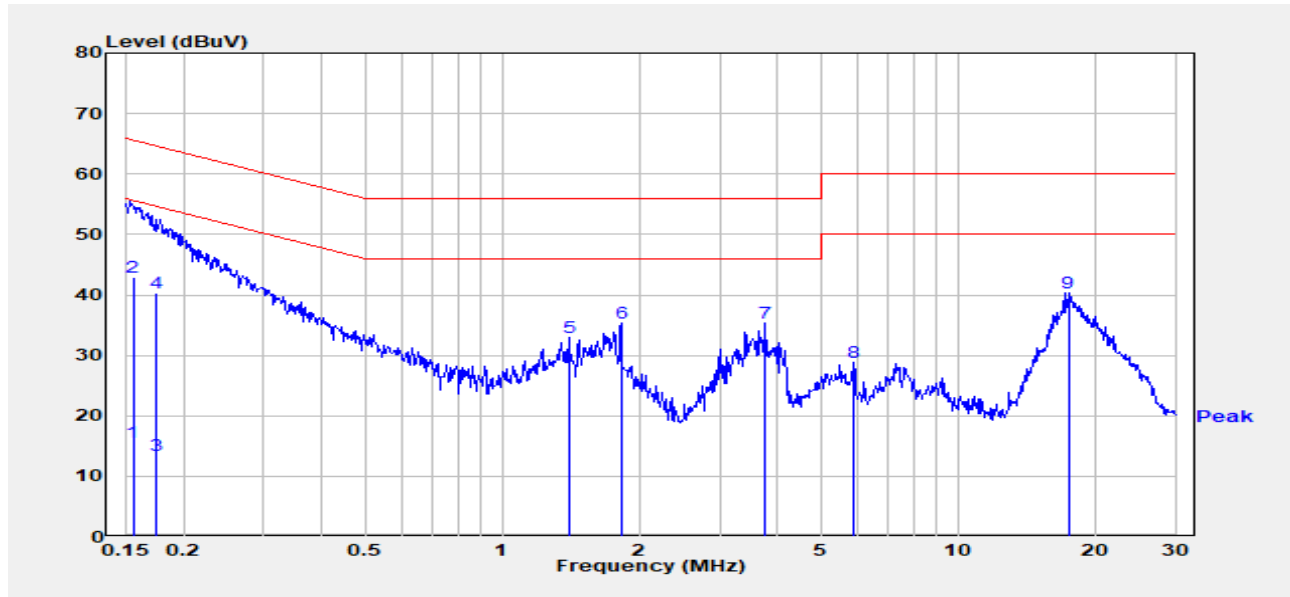

Freq. MHz	Detector Mode PK/QP/AV	Spectrum Reading Level dBµV	Factor dB	Actual FS dBµV	Limit dBµV	Margin dB
0.155	Average	5.47	10.13	15.60	55.74	-40.14
0.155	QP	32.70	10.13	42.83	65.74	-22.91
0.174	Average	3.27	10.13	13.40	54.77	-41.37
0.174	QP	30.13	10.13	40.26	64.77	-24.51
1.403	Peak	22.68	10.20	32.87	56.00	-23.13
1.829	Peak	25.06	10.19	35.25	56.00	-20.75
3.779	Peak	25.13	10.29	35.42	56.00	-20.58
5.929	Peak	18.50	10.35	28.85	60.00	-31.15
17.475	Peak	29.84	10.50	40.34	60.00	-19.66

Unless otherwise stated the results shown in this test report refer only to the sample(s) tested and such sample(s) are retained for 90 days only.

除非另有說明，此報告結果僅對測試之樣品負責，同時此樣品僅保留90天。本報告未經本公司書面許可，不可部份複製。

This document is issued by the Company subject to its General Conditions of Service printed overleaf, available on request or accessible at <http://www.sgs.com.tw/Terms-and-Conditions> and for electronic format documents, subject to Terms and Conditions for Electronic Documents at <http://www.sgs.com.tw/Terms-and-Conditions>. Attention is drawn to the limitation of liability, indemnification and jurisdiction issues defined therein. Any holder of this document is advised that information contained hereon reflects the Company's findings at the time of its intervention only and within the limits of Client's instructions, if any. The Company's sole responsibility is to its Client and this document does not exonerate parties to a transaction from exercising all their rights and obligations under the transaction documents. This document cannot be reproduced except in full, without prior written approval of the Company. Any unauthorized alteration, forgery or falsification of the content or appearance of this document is unlawful and offenders may be prosecuted to the fullest extent of the law.

Report Number :TERF2404001033ER
 Operation Mode :BLE
 Power :120V/60Hz
 Probe :N
 Note: :

Test Site :Conduction 1
 Test Date :2024-05-10
 Temp./Humi. :23.0°C/50%
 Engineer :Eason Wang

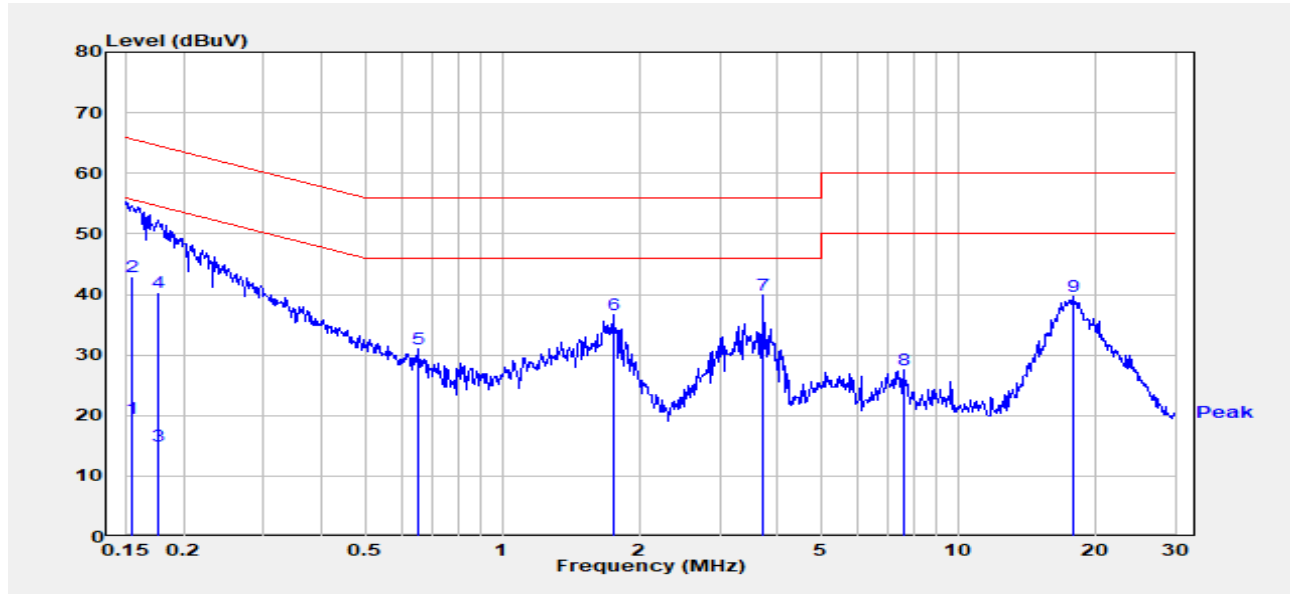

Freq. MHz	Detector Mode PK/QP/AV	Spectrum Reading Level dBuV	Factor dB	Actual FS dBuV	Limit dBuV	Margin dB
0.154	Average	9.32	10.12	19.44	55.78	-36.34
0.154	QP	32.87	10.12	42.99	65.78	-22.79
0.176	Average	4.85	10.12	14.97	54.68	-39.71
0.176	QP	30.11	10.12	40.23	64.68	-24.45
0.654	Peak	20.91	10.17	31.08	56.00	-24.92
1.753	Peak	26.45	10.19	36.64	56.00	-19.36
3.740	Peak	29.52	10.29	39.82	56.00	-16.18
7.606	Peak	17.22	10.38	27.60	60.00	-32.40
17.849	Peak	29.09	10.56	39.65	60.00	-20.35

Unless otherwise stated the results shown in this test report refer only to the sample(s) tested and such sample(s) are retained for 90 days only.

除非另有說明，此報告結果僅對測試之樣品負責，同時此樣品僅保留90天。本報告未經本公司書面許可，不可部份複製。

This document is issued by the Company subject to its General Conditions of Service printed overleaf, available on request or accessible at <http://www.sgs.com.tw/Terms-and-Conditions> and for electronic format documents, subject to Terms and Conditions for Electronic Documents at <http://www.sgs.com.tw/Terms-and-Conditions>. Attention is drawn to the limitation of liability, indemnification and jurisdiction issues defined therein. Any holder of this document is advised that information contained hereon reflects the Company's findings at the time of its intervention only and within the limits of Client's instructions, if any. The Company's sole responsibility is to its Client and this document does not exonerate parties to a transaction from exercising all their rights and obligations under the transaction documents. This document cannot be reproduced except in full, without prior written approval of the Company. Any unauthorized alteration, forgery or falsification of the content or appearance of this document is unlawful and offenders may be prosecuted to the fullest extent of the law.

8 PEAK OUTPUT POWER MEASUREMENT

8.1 Standard Applicable:

8.1.1 Duty Cycle

Pre-analysis Check: While conducting average power measurement, duty cycle of each mode shall be checked to ensure its duty cycle in order to compensate for the loss due to insufficient ratio of duty cycle.

All duty cycle is pre-scanned, and result as obtained below shows only the most representative ones where duty cycle is conducted as the given transmission with given virtual operation that expresses the percentage.

8.1.2 FCC

For systems using digital modulation in the 2400-2483.5 MHz bands, the limit for peak output power is 1Watt.

If the transmitting antenna of directional gain greater than 6dBi are used the peak output power from the intentional radiator shall be reduced below the above stated value by the amount in dB that the directional gain of the Antenna exceeds 6dBi.

In case of point-to-point operation, the limit has to be reduced by 1dB for every 3dB that the directional gain of Antenna exceeds 6dBi.

8.2 Test Setup

8.2.1 Duty Cycle

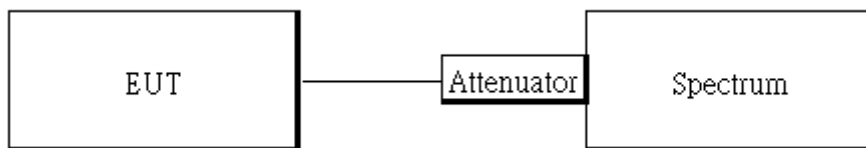

8.2.2 Output Power

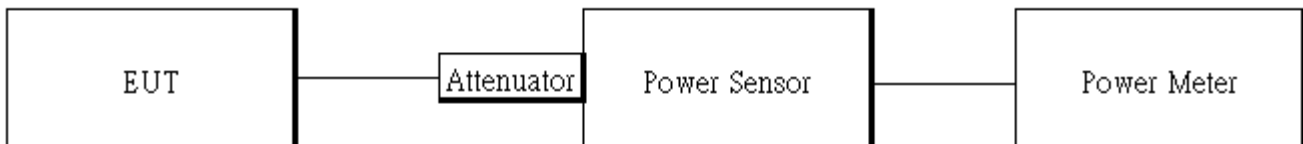

Unless otherwise stated the results shown in this test report refer only to the sample(s) tested and such sample(s) are retained for 90 days only.

除非另有說明，此報告結果僅對測試之樣品負責，同時此樣品僅保留90天。本報告未經本公司書面許可，不可部份複製。

This document is issued by the Company subject to its General Conditions of Service printed overleaf, available on request or accessible at <http://www.sgs.com.tw/Terms-and-Conditions> and for electronic format documents, subject to Terms and Conditions for Electronic Documents at <http://www.sgs.com.tw/Terms-and-Conditions>. Attention is drawn to the limitation of liability, indemnification and jurisdiction issues defined therein. Any holder of this document is advised that information contained hereon reflects the Company's findings at the time of its intervention only and within the limits of Client's instructions, if any. The Company's sole responsibility is to its Client and this document does not exonerate parties to a transaction from exercising all their rights and obligations under the transaction documents. This document cannot be reproduced except in full, without prior written approval of the Company. Any unauthorized alteration, forgery or falsification of the content or appearance of this document is unlawful and offenders may be prosecuted to the fullest extent of the law.

8.3 Measurement Procedure:

8.3.1 Duty Cycle

1. Place the EUT on the table and set it in transmitting mode.
2. Set span = Zero
3. RBW = 8MHz, VBW = 8MHz,
4. Detector = Peak

8.3.2 Output Power

1. Place the EUT on the table and set it in transmitting mode.
2. The testing follows the Measurement Procedure of FCC KDB 558074 D01 DTS Meas. Guidance.
3. Remove the antenna from the EUT and then connect a low loss RF cable from the antenna port to the power meter.
4. Record the max. Reading as observed from Power Meter.
5. Repeat above procedures until all test default channel measured was complete.

Unless otherwise stated the results shown in this test report refer only to the sample(s) tested and such sample(s) are retained for 90 days only.
除非另有說明，此報告結果僅對測試之樣品負責，同時此樣品僅保留90天。本報告未經本公司書面許可，不可部份複製。

This document is issued by the Company subject to its General Conditions of Service printed overleaf, available on request or accessible at <http://www.sgs.com.tw/Terms-and-Conditions> and for electronic format documents, subject to Terms and Conditions for Electronic Documents at <http://www.sgs.com.tw/Terms-and-Conditions>. Attention is drawn to the limitation of liability, indemnification and jurisdiction issues defined therein. Any holder of this document is advised that information contained hereon reflects the Company's findings at the time of its intervention only and within the limits of Client's instructions, if any. The Company's sole responsibility is to its Client and this document does not exonerate parties to a transaction from exercising all their rights and obligations under the transaction documents. This document cannot be reproduced except in full, without prior written approval of the Company. Any unauthorized alteration, forgery or falsification of the content or appearance of this document is unlawful and offenders may be prosecuted to the fullest extent of the law.

8.4 Duty Factor:

Mode: ANT4

	Duty Cycle (%) = Ton / (Ton+Toff)	Duty Factor (dB) =10*log (1/Duty Cycle)	1/T (kHz)	VBW setting (kHz)
BLE 1M	63.20	1.99	2.53	3.00
BLE 2M	57.87	2.38	0.92	1.00
PHY=8	97.48	0.11	0.06	1.00
PHY=2	91.20	0.40	0.22	1.00

Mode: ANT8

	Duty Cycle (%) = Ton / (Ton+Toff)	Duty Factor (dB) =10*log (1/Duty Cycle)	1/T (kHz)	VBW setting (kHz)
BLE 1M	63.20	1.99	2.53	3.00
BLE 2M	57.87	2.38	0.92	1.00
PHY=8	97.49	0.11	0.06	1.00
PHY=2	91.20	0.40	0.22	1.00

Unless otherwise stated the results shown in this test report refer only to the sample(s) tested and such sample(s) are retained for 90 days only.
 除非另有說明，此報告結果僅對測試之樣品負責，同時此樣品僅保留90天。本報告未經本公司書面許可，不可部份複製。

This document is issued by the Company subject to its General Conditions of Service printed overleaf, available on request or accessible at <http://www.sgs.com.tw/Terms-and-Conditions> and for electronic format documents, subject to Terms and Conditions for Electronic Documents at <http://www.sgs.com.tw/Terms-and-Conditions>. Attention is drawn to the limitation of liability, indemnification and jurisdiction issues defined therein. Any holder of this document is advised that information contained hereon reflects the Company's findings at the time of its intervention only and within the limits of Client's instructions, if any. The Company's sole responsibility is to its Client and this document does not exonerate parties to a transaction from exercising all their rights and obligations under the transaction documents. This document cannot be reproduced except in full, without prior written approval of the Company. Any unauthorized alteration, forgery or falsification of the content or appearance of this document is unlawful and offenders may be prosecuted to the fullest extent of the law.

BLE_1M_LowCH00-2402

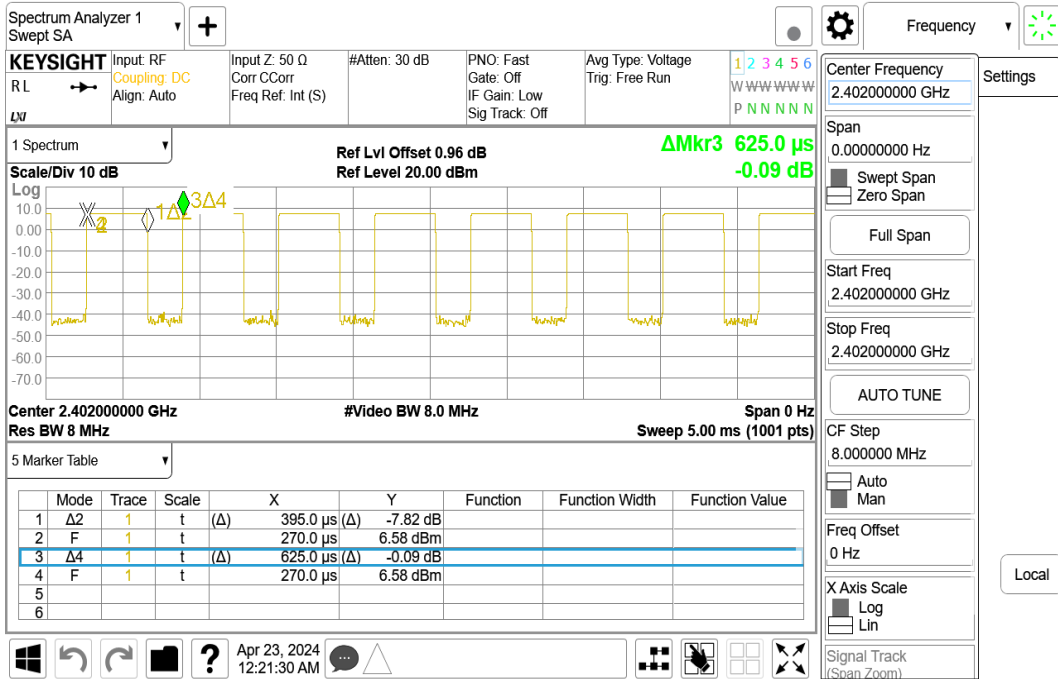

BLE_2M_LowCH00-2402

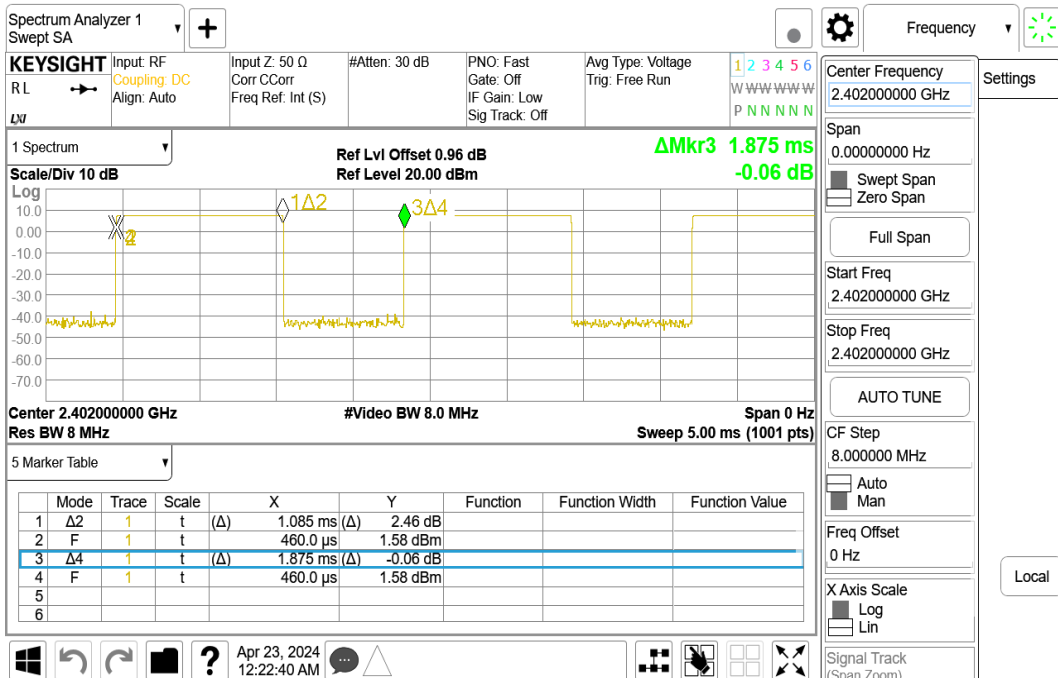

Unless otherwise stated the results shown in this test report refer only to the sample(s) tested and such sample(s) are retained for 90 days only.

除非另有說明，此報告結果僅對測試之樣品負責，同時此樣品僅保留90天。本報告未經本公司書面許可，不可部份複製。

This document is issued by the Company subject to its General Conditions of Service printed overleaf, available on request or accessible at <http://www.sgs.com.tw/Terms-and-Conditions> and for electronic format documents, subject to Terms and Conditions for Electronic Documents at <http://www.sgs.com.tw/Terms-and-Conditions>. Attention is drawn to the limitation of liability, indemnification and jurisdiction issues defined therein. Any holder of this document is advised that information contained herein reflects the Company's findings at the time of its intervention only and within the limits of Client's instructions, if any. The Company's sole responsibility is to its Client and this document does not exonerate parties to a transaction from exercising all their rights and obligations under the transaction documents. This document cannot be reproduced except in full, without prior written approval of the Company. Any unauthorized alteration, forgery or falsification of the content or appearance of this document is unlawful and offenders may be prosecuted to the fullest extent of the law.

BLE_125k_LowCH00-2402



BLE_500k_LowCH00-2402

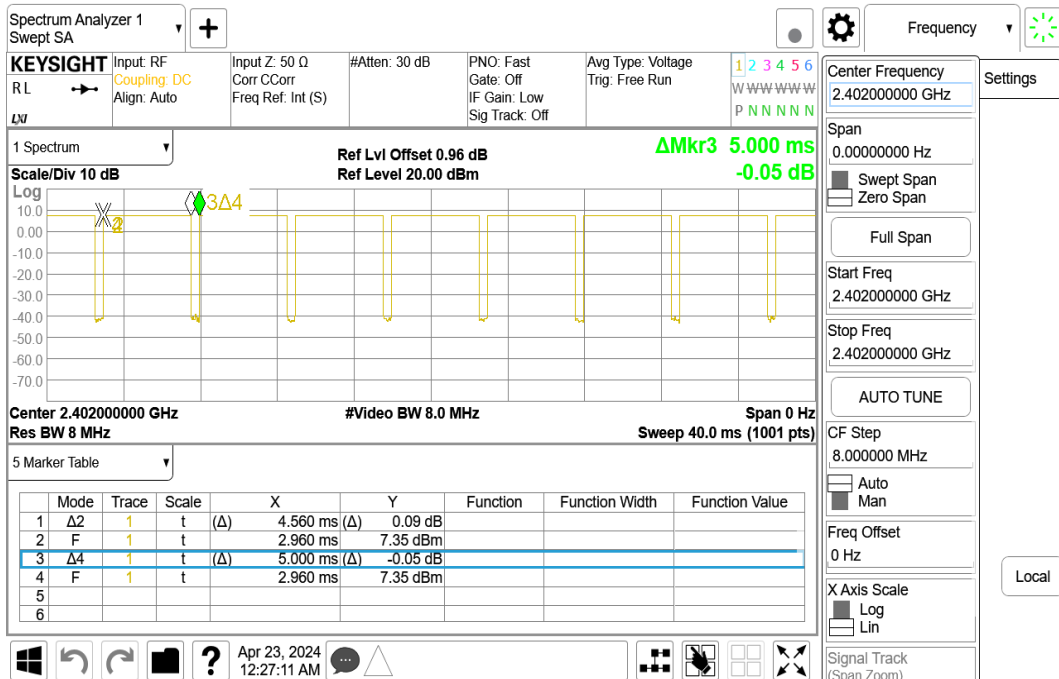

Unless otherwise stated the results shown in this test report refer only to the sample(s) tested and such sample(s) are retained for 90 days only.

除非另有說明，此報告結果僅對測試之樣品負責，同時此樣品僅保留90天。本報告未經本公司書面許可，不可部份複製。

This document is issued by the Company subject to its General Conditions of Service printed overleaf, available on request or accessible at <http://www.sgs.com.tw/Terms-and-Conditions> and for electronic format documents, subject to Terms and Conditions for Electronic Documents at <http://www.sgs.com.tw/Terms-and-Conditions>. Attention is drawn to the limitation of liability, indemnification and jurisdiction issues defined therein. Any holder of this document is advised that information contained hereon reflects the Company's findings at the time of its intervention only and within the limits of Client's instructions, if any. The Company's sole responsibility is to its Client and this document does not exonerate parties to a transaction from exercising all their rights and obligations under the transaction documents. This document cannot be reproduced except in full, without prior written approval of the Company. Any unauthorized alteration, forgery or falsification of the content or appearance of this document is unlawful and offenders may be prosecuted to the fullest extent of the law.

BLE_1M_LowCH00-2402

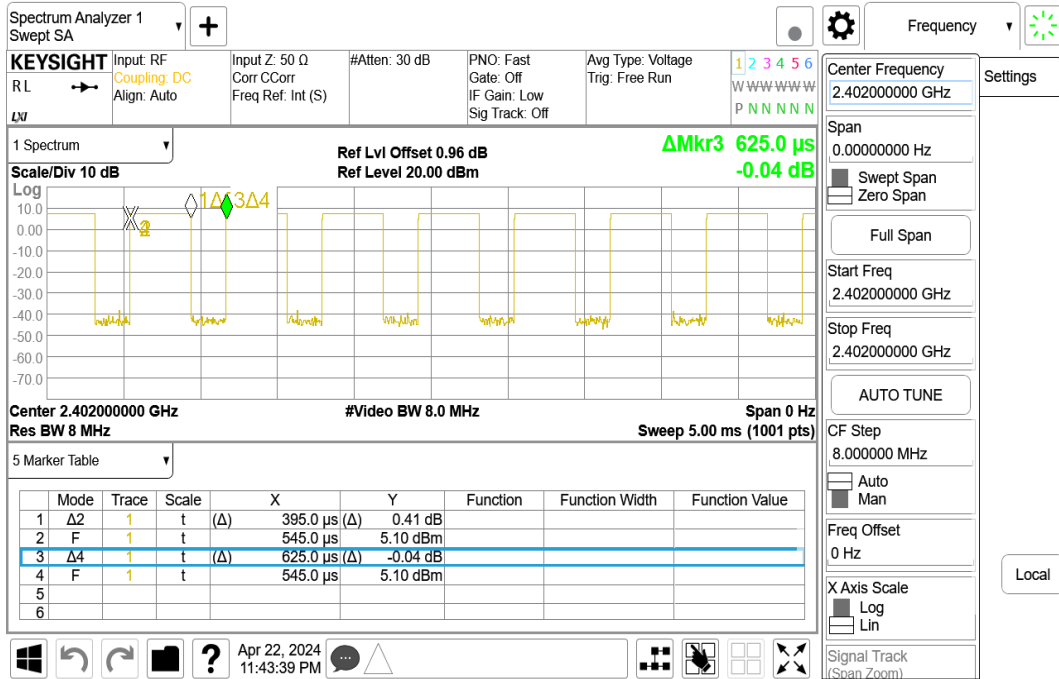

BLE_2M_LowCH00-2402



Unless otherwise stated the results shown in this test report refer only to the sample(s) tested and such sample(s) are retained for 90 days only.

除非另有說明，此報告結果僅對測試之樣品負責，同時此樣品僅保留90天。本報告未經本公司書面許可，不可部份複製。

This document is issued by the Company subject to its General Conditions of Service printed overleaf, available on request or accessible at <http://www.sgs.com.tw/Terms-and-Conditions> and for electronic format documents, subject to Terms and Conditions for Electronic Documents at <http://www.sgs.com.tw/Terms-and-Conditions>. Attention is drawn to the limitation of liability, indemnification and jurisdiction issues defined therein. Any holder of this document is advised that information contained herein reflects the Company's findings at the time of its intervention only and within the limits of Client's instructions, if any. The Company's sole responsibility is to its Client and this document does not exonerate parties to a transaction from exercising all their rights and obligations under the transaction documents. This document cannot be reproduced except in full, without prior written approval of the Company. Any unauthorized alteration, forgery or falsification of the content or appearance of this document is unlawful and offenders may be prosecuted to the fullest extent of the law.

BLE_125k_LowCH00-2402

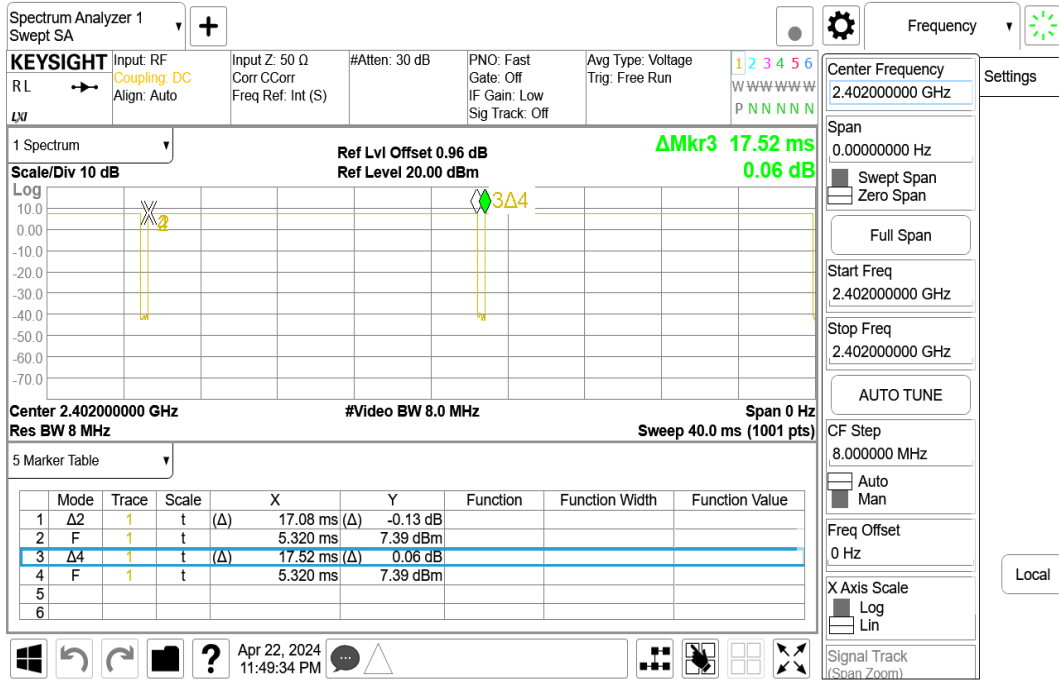

BLE_500k_LowCH00-2402

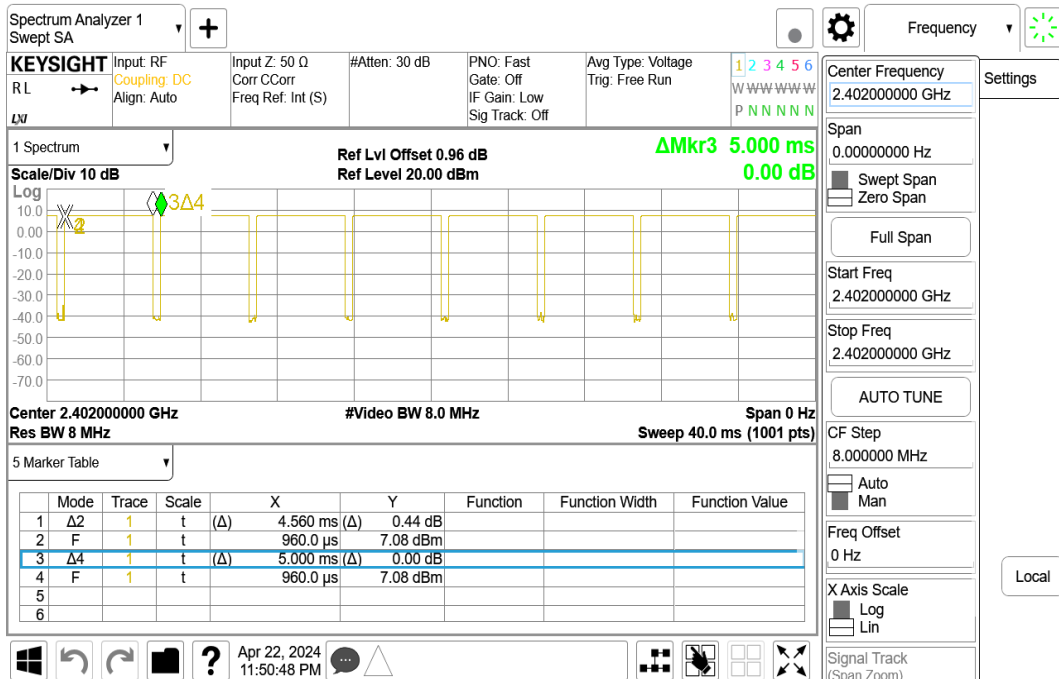

Unless otherwise stated the results shown in this test report refer only to the sample(s) tested and such sample(s) are retained for 90 days only.

除非另有說明，此報告結果僅對測試之樣品負責，同時此樣品僅保留90天。本報告未經本公司書面許可，不可部份複製。

This document is issued by the Company subject to its General Conditions of Service printed overleaf, available on request or accessible at <http://www.sgs.com.tw/Terms-and-Conditions> and for electronic format documents, subject to Terms and Conditions for Electronic Documents at <http://www.sgs.com.tw/Terms-and-Conditions>. Attention is drawn to the limitation of liability, indemnification and jurisdiction issues defined therein. Any holder of this document is advised that information contained hereon reflects the Company's findings at the time of its intervention only and within the limits of Client's instructions, if any. The Company's sole responsibility is to its Client and this document does not exonerate parties to a transaction from exercising all their rights and obligations under the transaction documents. This document cannot be reproduced except in full, without prior written approval of the Company. Any unauthorized alteration, forgery or falsification of the content or appearance of this document is unlawful and offenders may be prosecuted to the fullest extent of the law.

8.5 Output Power:

8.5.1 Peak & Avg

Mode: ANT4

BLE 1M mode:

CH	Frequency (MHz)	Power Setting	Peak Output Power (dBm)	Required Limit (dBm)
Low	2402	2	6.97	30
Mid	2440	2	6.65	30
High	2480	1	6.79	30
CH	Frequency (MHz)	Power Setting	Avg. Output Power (dBm)	Required Limit (dBm)
Low	2402	2	6.71	30
Mid	2440	2	6.36	30
High	2480	1	6.52	30

**Note:*

1. Measured by power meter, cable loss 0.96 dB + Duty cycle factor has been offsetted to the power meter for Avg. power and cable loss has been offsetted for Peak power measurement.

Unless otherwise stated the results shown in this test report refer only to the sample(s) tested and such sample(s) are retained for 90 days only.

除非另有說明，此報告結果僅對測試之樣品負責，同時此樣品僅保留90天。本報告未經本公司書面許可，不可部份複製。

This document is issued by the Company subject to its General Conditions of Service printed overleaf, available on request or accessible at <http://www.sgs.com.tw/Terms-and-Conditions> and for electronic format documents, subject to Terms and Conditions for Electronic Documents at <http://www.sgs.com.tw/Terms-and-Conditions>. Attention is drawn to the limitation of liability, indemnification and jurisdiction issues defined therein. Any holder of this document is advised that information contained hereon reflects the Company's findings at the time of its intervention only and within the limits of Client's instructions, if any. The Company's sole responsibility is to its Client and this document does not exonerate parties to a transaction from exercising all their rights and obligations under the transaction documents. This document cannot be reproduced except in full, without prior written approval of the Company. Any unauthorized alteration, forgery or falsification of the content or appearance of this document is unlawful and offenders may be prosecuted to the fullest extent of the law.

BLE 2M mode:

CH	Frequency (MHz)	Power set	Peak Output Power (dBm)	Required Limit (dBm)
Low	2402	2	6.89	30
Mid	2440	2	6.58	30
High	2480	1	6.69	30
CH	Frequency (MHz)	Power set	Avg. Output Power (dBm)	Required Limit (dBm)
Low	2402	2	6.61	30
Mid	2440	2	6.41	30
High	2480	1	6.46	30

*Note:

1. Measured by power meter, cable loss 0.96 dB + Duty cycle factor has been offseted to the power meter for Avg. power and cable loss has been offseted for Peak power measurement.

PHY=8 mode:

CH	Frequency (MHz)	Power set	Peak Output Power (dBm)	Required Limit (dBm)
Low	2402	2	6.94	30
Mid	2440	2	6.57	30
High	2480	1	6.73	30
CH	Frequency (MHz)	Power set	Avg. Output Power (dBm)	Required Limit (dBm)
Low	2402	2	6.65	30
Mid	2440	2	6.34	30
High	2480	1	6.45	30

*Note:

1. Measured by power meter, cable loss dB + Duty cycle factor has been offseted to the power meter for Avg. power and cable loss has been offseted for Peak power measurement.

Unless otherwise stated the results shown in this test report refer only to the sample(s) tested and such sample(s) are retained for 90 days only.
 除非另有說明，此報告結果僅對測試之樣品負責，同時此樣品僅保留90天。本報告未經本公司書面許可，不可部份複製。

This document is issued by the Company subject to its General Conditions of Service printed overleaf, available on request or accessible at <http://www.sgs.com.tw/Terms-and-Conditions> and for electronic format documents, subject to Terms and Conditions for Electronic Documents at <http://www.sgs.com.tw/Terms-and-Conditions>. Attention is drawn to the limitation of liability, indemnification and jurisdiction issues defined therein. Any holder of this document is advised that information contained hereon reflects the Company's findings at the time of its intervention only and within the limits of Client's instructions, if any. The Company's sole responsibility is to its Client and this document does not exonerate parties to a transaction from exercising all their rights and obligations under the transaction documents. This document cannot be reproduced except in full, without prior written approval of the Company. Any unauthorized alteration, forgery or falsification of the content or appearance of this document is unlawful and offenders may be prosecuted to the fullest extent of the law.

PHY=2 mode:

CH	Frequency (MHz)	Power set	Peak Output Power (dBm)	Required Limit (dBm)
Low	2402	2	6.88	30
Mid	2440	2	6.53	30
High	2480	1	6.68	30
CH	Frequency (MHz)	Power set	Avg. Output Power (dBm)	Required Limit (dBm)
Low	2402	2	6.59	30
Mid	2440	2	6.33	30
High	2480	1	6.44	30

**Note:*

1. Measured by power meter, cable loss dB + Duty cycle factor has been offseted to the power meter for Avg. power and cable loss has been offseted for Peak power measurement.

Unless otherwise stated the results shown in this test report refer only to the sample(s) tested and such sample(s) are retained for 90 days only.
 除非另有說明，此報告結果僅對測試之樣品負責，同時此樣品僅保留90天。本報告未經本公司書面許可，不可部份複製。

This document is issued by the Company subject to its General Conditions of Service printed overleaf, available on request or accessible at <http://www.sgs.com.tw/Terms-and-Conditions> and for electronic format documents, subject to Terms and Conditions for Electronic Documents at <http://www.sgs.com.tw/Terms-and-Conditions>. Attention is drawn to the limitation of liability, indemnification and jurisdiction issues defined therein. Any holder of this document is advised that information contained hereon reflects the Company's findings at the time of its intervention only and within the limits of Client's instructions, if any. The Company's sole responsibility is to its Client and this document does not exonerate parties to a transaction from exercising all their rights and obligations under the transaction documents. This document cannot be reproduced except in full, without prior written approval of the Company. Any unauthorized alteration, forgery or falsification of the content or appearance of this document is unlawful and offenders may be prosecuted to the fullest extent of the law.

Mode: ANT8

BLE 1M mode:

CH	Frequency (MHz)	Power Setting	Peak Output Power (dBm)	Required Limit (dBm)
Low	2402	2	6.74	30
Mid	2440	3	6.64	30
High	2480	2	6.68	30
CH	Frequency (MHz)	Power Setting	Avg. Output Power (dBm)	Required Limit (dBm)
Low	2402	2	6.50	30
Mid	2440	3	6.39	30
High	2480	2	6.46	30

**Note:*

1. Measured by power meter, cable loss 0.96 dB + Duty cycle factor has been offsetted to the power meter for Avg. power and cable loss has been offsetted for Peak power measurement.

BLE 2M mode:

CH	Frequency (MHz)	Power set	Peak Output Power (dBm)	Required Limit (dBm)
Low	2402	2	6.85	30
Mid	2440	3	6.73	30
High	2480	2	6.80	30
CH	Frequency (MHz)	Power set	Avg. Output Power (dBm)	Required Limit (dBm)
Low	2402	2	6.55	30
Mid	2440	3	6.40	30
High	2480	2	6.48	30

**Note:*

1. Measured by power meter, cable loss 0.96 dB + Duty cycle factor has been offsetted to the power meter for Avg. power and cable loss has been offsetted for Peak power measurement.

Unless otherwise stated the results shown in this test report refer only to the sample(s) tested and such sample(s) are retained for 90 days only.
 除非另有說明，此報告結果僅對測試之樣品負責，同時此樣品僅保留90天。本報告未經本公司書面許可，不可部份複製。

This document is issued by the Company subject to its General Conditions of Service printed overleaf, available on request or accessible at <http://www.sgs.com.tw/Terms-and-Conditions> and for electronic format documents, subject to Terms and Conditions for Electronic Documents at <http://www.sgs.com.tw/Terms-and-Conditions>. Attention is drawn to the limitation of liability, indemnification and jurisdiction issues defined therein. Any holder of this document is advised that information contained hereon reflects the Company's findings at the time of its intervention only and within the limits of Client's instructions, if any. The Company's sole responsibility is to its Client and this document does not exonerate parties to a transaction from exercising all their rights and obligations under the transaction documents. This document cannot be reproduced except in full, without prior written approval of the Company. Any unauthorized alteration, forgery or falsification of the content or appearance of this document is unlawful and offenders may be prosecuted to the fullest extent of the law.

PHY=8 mode:

CH	Frequency (MHz)	Power set	Peak Output Power (dBm)	Required Limit (dBm)
Low	2402	1	6.73	30
Mid	2440	3	6.59	30
High	2480	1	6.60	30
CH	Frequency (MHz)	Power set	Avg. Output Power (dBm)	Required Limit (dBm)
Low	2402	1	6.48	30
Mid	2440	3	6.36	30
High	2480	1	6.45	30

**Note:*

1. Measured by power meter, cable loss dB + Duty cycle factor has been offseted to the power meter for Avg. power and cable loss has been offseted for Peak power measurement.

PHY=2 mode:

CH	Frequency (MHz)	Power set	Peak Output Power (dBm)	Required Limit (dBm)
Low	2402	1	6.78	30
Mid	2440	3	6.61	30
High	2480	2	6.75	30
CH	Frequency (MHz)	Power set	Avg. Output Power (dBm)	Required Limit (dBm)
Low	2402	1	6.51	30
Mid	2440	3	6.34	30
High	2480	2	6.47	30

**Note:*

1. Measured by power meter, cable loss dB + Duty cycle factor has been offseted to the power meter for Avg. power and cable loss has been offseted for Peak power measurement.

Unless otherwise stated the results shown in this test report refer only to the sample(s) tested and such sample(s) are retained for 90 days only.
 除非另有說明，此報告結果僅對測試之樣品負責，同時此樣品僅保留90天。本報告未經本公司書面許可，不可部份複製。

This document is issued by the Company subject to its General Conditions of Service printed overleaf, available on request or accessible at <http://www.sgs.com.tw/Terms-and-Conditions> and for electronic format documents, subject to Terms and Conditions for Electronic Documents at <http://www.sgs.com.tw/Terms-and-Conditions>. Attention is drawn to the limitation of liability, indemnification and jurisdiction issues defined therein. Any holder of this document is advised that information contained hereon reflects the Company's findings at the time of its intervention only and within the limits of Client's instructions, if any. The Company's sole responsibility is to its Client and this document does not exonerate parties to a transaction from exercising all their rights and obligations under the transaction documents. This document cannot be reproduced except in full, without prior written approval of the Company. Any unauthorized alteration, forgery or falsification of the content or appearance of this document is unlawful and offenders may be prosecuted to the fullest extent of the law.

9 EMISSION BANDWIDTH MEASUREMENT

9.1 Standard Applicable

The minimum 6 dB bandwidth shall be at least 500 kHz .

9.2 Test Setup

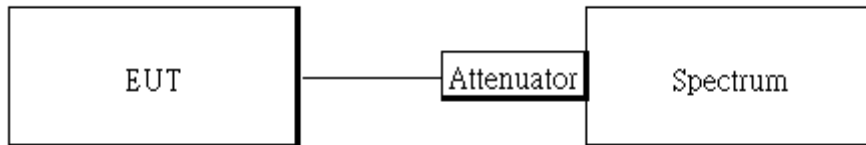

9.3 Measurement Procedure:

1. Place the EUT on the table and set it in transmitting mode.
2. Remove the antenna from the EUT and then connect a low loss RF cable from the antenna port to the spectrum analyzer.

9.3.1 6dB BW measurements

1. The testing follows the Measurement Procedure of the KDB 558074 D01.
2. Set the spectrum analyzer as
RBW= 100 kHz ,
VBW = 3 X RBW,
Span= 2 to 5 times of the OBW,
Sweep=auto, Detector = Peak, and Max hold.
3. Mark the upper and lower frequencies of -6dB.
4. Repeat above procedures until all test default channel is completed.

Unless otherwise stated the results shown in this test report refer only to the sample(s) tested and such sample(s) are retained for 90 days only.
除非另有說明，此報告結果僅對測試之樣品負責，同時此樣品僅保留90天。本報告未經本公司書面許可，不可部份複製。

This document is issued by the Company subject to its General Conditions of Service printed overleaf, available on request or accessible at <http://www.sgs.com.tw/Terms-and-Conditions> and for electronic format documents, subject to Terms and Conditions for Electronic Documents at <http://www.sgs.com.tw/Terms-and-Conditions>. Attention is drawn to the limitation of liability, indemnification and jurisdiction issues defined therein. Any holder of this document is advised that information contained hereon reflects the Company's findings at the time of its intervention only and within the limits of Client's instructions, if any. The Company's sole responsibility is to its Client and this document does not exonerate parties to a transaction from exercising all their rights and obligations under the transaction documents. This document cannot be reproduced except in full, without prior written approval of the Company. Any unauthorized alteration, forgery or falsification of the content or appearance of this document is unlawful and offenders may be prosecuted to the fullest extent of the law.

9.4 Measurement Result:

9.4.1 6dB BW measurements

Mode: ANT4

BLE 1M mode

Frequency (MHz)	6dB BW (MHz)	Required BW (MHz)	Result
2402	0.6827	≥ 0.5	PASS
2440	0.6838	≥ 0.5	PASS
2480	0.6808	≥ 0.5	PASS

BLE 2M mode

Frequency (MHz)	6dB BW (MHz)	Required BW (MHz)	Result
2402	1.16	≥ 0.5	PASS
2440	1.157	≥ 0.5	PASS
2480	1.157	≥ 0.5	PASS

PHY=8 mode

Frequency (MHz)	6dB BW (MHz)	Required BW (MHz)	Result
2402	0.6086	≥ 0.5	PASS
2440	0.637	≥ 0.5	PASS
2480	0.6575	≥ 0.5	PASS

PHY=2 mode

Frequency (MHz)	6dB BW (MHz)	Required BW (MHz)	Result
2402	0.6655	≥ 0.5	PASS
2440	0.6649	≥ 0.5	PASS
2480	0.6648	≥ 0.5	PASS

Unless otherwise stated the results shown in this test report refer only to the sample(s) tested and such sample(s) are retained for 90 days only.

除非另有說明，此報告結果僅對測試之樣品負責，同時此樣品僅保留90天。本報告未經本公司書面許可，不可部份複製。

This document is issued by the Company subject to its General Conditions of Service printed overleaf, available on request or accessible at <http://www.sgs.com.tw/Terms-and-Conditions> and for electronic format documents, subject to Terms and Conditions for Electronic Documents at <http://www.sgs.com.tw/Terms-and-Conditions>. Attention is drawn to the limitation of liability, indemnification and jurisdiction issues defined therein. Any holder of this document is advised that information contained hereon reflects the Company's findings at the time of its intervention only and within the limits of Client's instructions, if any. The Company's sole responsibility is to its Client and this document does not exonerate parties to a transaction from exercising all their rights and obligations under the transaction documents. This document cannot be reproduced except in full, without prior written approval of the Company. Any unauthorized alteration, forgery or falsification of the content or appearance of this document is unlawful and offenders may be prosecuted to the fullest extent of the law.

BLE 1M mode

Frequency (MHz)	6dB BW (MHz)	Required BW (MHz)	Result
2402	0.6824	≥ 0.5	PASS
2440	0.6816	≥ 0.5	PASS
2480	0.685	≥ 0.5	PASS

BLE 2M mode

Frequency (MHz)	6dB BW (MHz)	Required BW (MHz)	Result
2402	1.157	≥ 0.5	PASS
2440	1.157	≥ 0.5	PASS
2480	1.158	≥ 0.5	PASS

PHY=8 mode

Frequency (MHz)	6dB BW (MHz)	Required BW (MHz)	Result
2402	0.6082	≥ 0.5	PASS
2440	0.6085	≥ 0.5	PASS
2480	0.634	≥ 0.5	PASS

PHY=2 mode

Frequency (MHz)	6dB BW (MHz)	Required BW (MHz)	Result
2402	0.6674	≥ 0.5	PASS
2440	0.6666	≥ 0.5	PASS
2480	0.6674	≥ 0.5	PASS

Unless otherwise stated the results shown in this test report refer only to the sample(s) tested and such sample(s) are retained for 90 days only.

除非另有說明，此報告結果僅對測試之樣品負責，同時此樣品僅保留90天。本報告未經本公司書面許可，不可部份複製。

This document is issued by the Company subject to its General Conditions of Service printed overleaf, available on request or accessible at <http://www.sgs.com.tw/Terms-and-Conditions> and for electronic format documents, subject to Terms and Conditions for Electronic Documents at <http://www.sgs.com.tw/Terms-and-Conditions>. Attention is drawn to the limitation of liability, indemnification and jurisdiction issues defined therein. Any holder of this document is advised that information contained hereon reflects the Company's findings at the time of its intervention only and within the limits of Client's instructions, if any. The Company's sole responsibility is to its Client and this document does not exonerate parties to a transaction from exercising all their rights and obligations under the transaction documents. This document cannot be reproduced except in full, without prior written approval of the Company. Any unauthorized alteration, forgery or falsification of the content or appearance of this document is unlawful and offenders may be prosecuted to the fullest extent of the law.

ANT4_OBW_BLE 1M_LowCH00-2402MHz

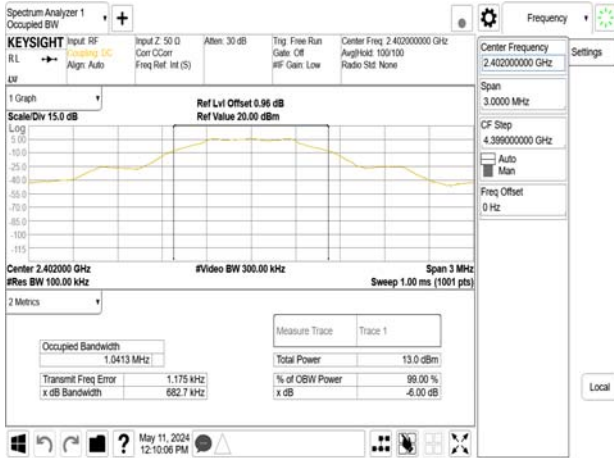

OBW_BLE 2M_LowCH00-2402MHz

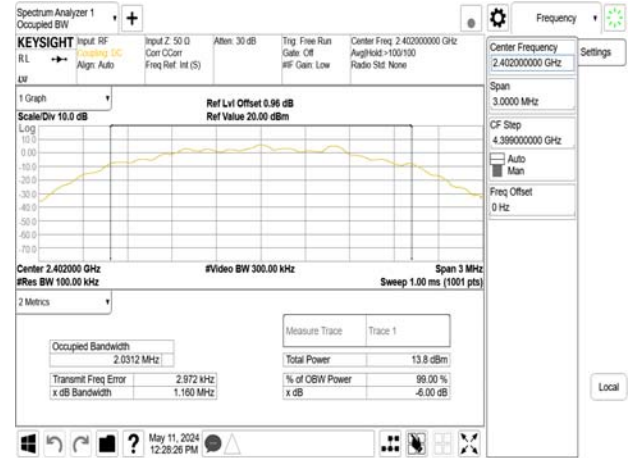

OBW_BLE 1M_MidCH19-2440MHz



OBW_BLE 2M_MidCH19-2440MHz



OBW_BLE 1M_HighCH39-2480MHz



OBW_BLE 2M_HighCH39-2480MHz



Unless otherwise stated the results shown in this test report refer only to the sample(s) tested and such sample(s) are retained for 90 days only.

除非另有說明，此報告結果僅對測試之樣品負責，同時此樣品僅保留90天。本報告未經本公司書面許可，不可部份複製。

This document is issued by the Company subject to its General Conditions of Service printed overleaf, available on request or accessible at <http://www.sgs.com.tw/Terms-and-Conditions> and for electronic format documents, subject to Terms and Conditions for Electronic Documents at <http://www.sgs.com.tw/Terms-and-Conditions>. Attention is drawn to the limitation of liability, indemnification and jurisdiction issues defined therein. Any holder of this document is advised that information contained hereon reflects the Company's findings at the time of its intervention only and within the limits of Client's instructions, if any. The Company's sole responsibility is to its Client and this document does not exonerate parties to a transaction from exercising all their rights and obligations under the transaction documents. This document cannot be reproduced except in full, without prior written approval of the Company. Any unauthorized alteration, forgery or falsification of the content or appearance of this document is unlawful and offenders may be prosecuted to the fullest extent of the law.

OBW_BLE 1M_LowCH00-2402MHz

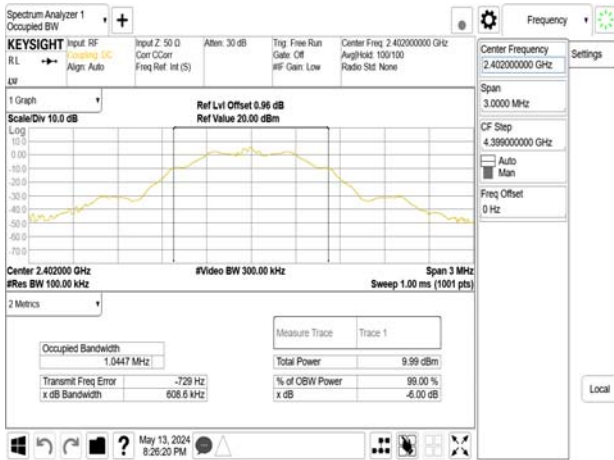

OBW_BLE 2M_LowCH00-2402MHz



OBW_BLE 1M_MidCH19-2440MHz



OBW_BLE 2M_MidCH19-2440MHz



OBW_BLE 1M_HighCH39-2480MHz



OBW_BLE 2M_HighCH39-2480MHz



Unless otherwise stated the results shown in this test report refer only to the sample(s) tested and such sample(s) are retained for 90 days only.

除非另有說明，此報告結果僅對測試之樣品負責，同時此樣品僅保留90天。本報告未經本公司書面許可，不可部份複製。

This document is issued by the Company subject to its General Conditions of Service printed overleaf, available on request or accessible at <http://www.sgs.com.tw/Terms-and-Conditions> and for electronic format documents, subject to Terms and Conditions for Electronic Documents at <http://www.sgs.com.tw/Terms-and-Conditions>. Attention is drawn to the limitation of liability, indemnification and jurisdiction issues defined therein. Any holder of this document is advised that information contained hereon reflects the Company's findings at the time of its intervention only and within the limits of Client's instructions, if any. The Company's sole responsibility is to its Client and this document does not exonerate parties to a transaction from exercising all their rights and obligations under the transaction documents. This document cannot be reproduced except in full, without prior written approval of the Company. Any unauthorized alteration, forgery or falsification of the content or appearance of this document is unlawful and offenders may be prosecuted to the fullest extent of the law.

ANT8_OBW_BLE 1M_LowCH00-2402MHz

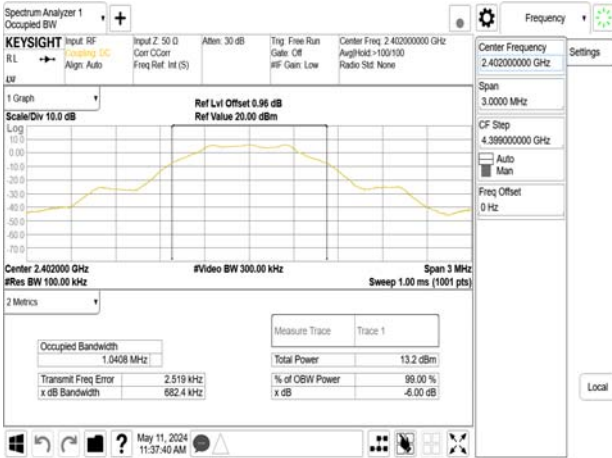

OBW_BLE 2M_LowCH00-2402MHz

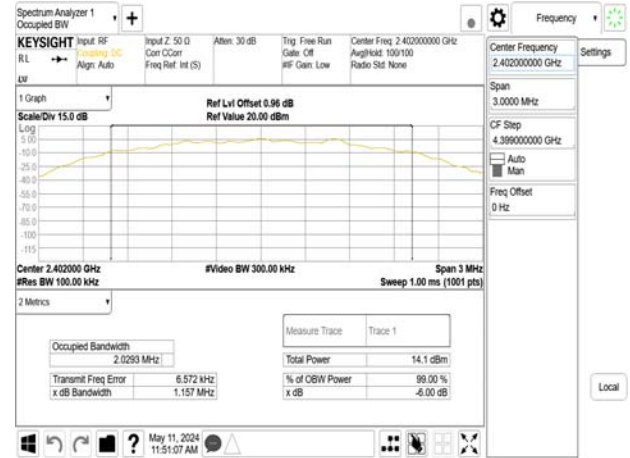

OBW_BLE 1M_MidCH19-2440MHz



OBW_BLE 2M_MidCH19-2440MHz



OBW_BLE 1M_HighCH39-2480MHz



OBW_BLE 2M_HighCH39-2480MHz



Unless otherwise stated the results shown in this test report refer only to the sample(s) tested and such sample(s) are retained for 90 days only.

除非另有說明，此報告結果僅對測試之樣品負責，同時此樣品僅保留90天。本報告未經本公司書面許可，不可部份複製。

This document is issued by the Company subject to its General Conditions of Service printed overleaf, available on request or accessible at <http://www.sgs.com.tw/Terms-and-Conditions> and for electronic format documents, subject to Terms and Conditions for Electronic Documents at <http://www.sgs.com.tw/Terms-and-Conditions>. Attention is drawn to the limitation of liability, indemnification and jurisdiction issues defined therein. Any holder of this document is advised that information contained hereon reflects the Company's findings at the time of its intervention only and within the limits of Client's instructions, if any. The Company's sole responsibility is to its Client and this document does not exonerate parties to a transaction from exercising all their rights and obligations under the transaction documents. This document cannot be reproduced except in full, without prior written approval of the Company. Any unauthorized alteration, forgery or falsification of the content or appearance of this document is unlawful and offenders may be prosecuted to the fullest extent of the law.

OBW_BLE 1M_LowCH00-2402MHz

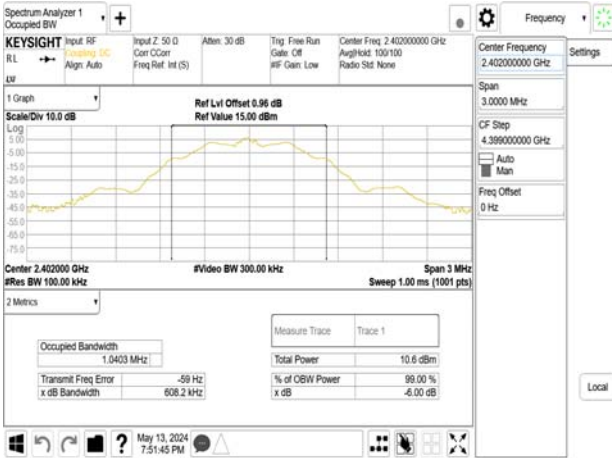

OBW_BLE 2M_LowCH00-2402MHz

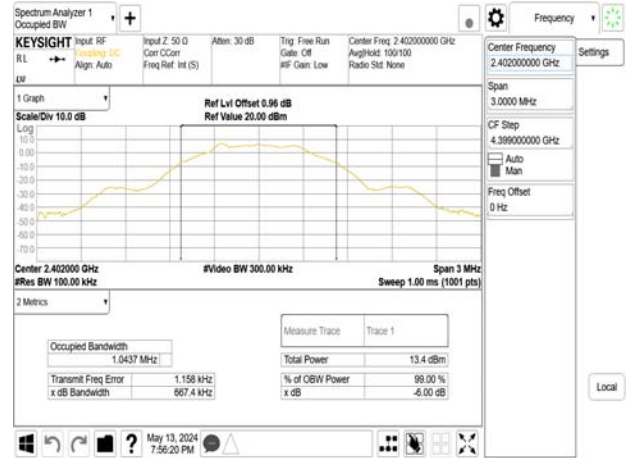

OBW_BLE 1M_MidCH19-2440MHz



OBW_BLE 2M_MidCH19-2440MHz



OBW_BLE 1M_HighCH39-2480MHz



OBW_BLE 2M_HighCH39-2480MHz



Unless otherwise stated the results shown in this test report refer only to the sample(s) tested and such sample(s) are retained for 90 days only.

除非另有說明，此報告結果僅對測試之樣品負責，同時此樣品僅保留90天。本報告未經本公司書面許可，不可部份複製。

This document is issued by the Company subject to its General Conditions of Service printed overleaf, available on request or accessible at <http://www.sgs.com.tw/Terms-and-Conditions> and for electronic format documents, subject to Terms and Conditions for Electronic Documents at <http://www.sgs.com.tw/Terms-and-Conditions>. Attention is drawn to the limitation of liability, indemnification and jurisdiction issues defined therein. Any holder of this document is advised that information contained hereon reflects the Company's findings at the time of its intervention only and within the limits of Client's instructions, if any. The Company's sole responsibility is to its Client and this document does not exonerate parties to a transaction from exercising all their rights and obligations under the transaction documents. This document cannot be reproduced except in full, without prior written approval of the Company. Any unauthorized alteration, forgery or falsification of the content or appearance of this document is unlawful and offenders may be prosecuted to the fullest extent of the law.

10 CONDUCTED BAND EDGES AND SPURIOUS EMISSION MEASUREMENT

10.1 Standard Applicable

In any 100 kHz bandwidth outside the frequency band in which the spread spectrum or digitally modulated intentional radiator is operating, the radio frequency power that is produced by the intentional radiator shall be at least 20 dB below that in the 100 kHz bandwidth within the band that contains the highest level of the desired power, based on either an RF conducted or a radiated measurement, provided the transmitter demonstrates compliance with the peak conducted power limits. In addition, radiated emissions which fall in the restricted bands, as defined in §15.205(a), must also comply with the radiated emission limits specified in §15.209(a).

10.2 Test Setup

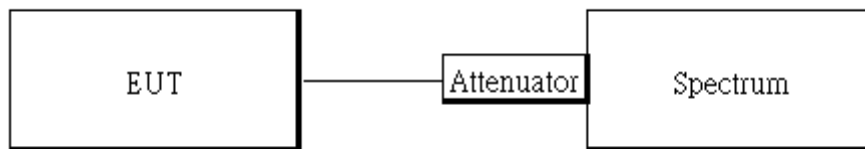

10.3 Measurement Procedure

10.3.1 Reference Level of Emission Limit:

1. Set analyzer center frequency to DTS channel center frequency.
2. The testing follows the Measurement Procedure of FCC KDB 558074 D01 DTS Meas. Guidance.
3. Set the span to 1.5 times the DTS channel bandwidth.
4. Set the RBW = 100kHz & VBW = 300 kHz.
5. Detector = peak.
6. Sweep time = auto couple.
7. Trace mode = max hold.
8. Allow trace to fully stabilize.
9. Use the peak marker function to determine the maximum amplitude level.

Unless otherwise stated the results shown in this test report refer only to the sample(s) tested and such sample(s) are retained for 90 days only.
除非另有說明，此報告結果僅對測試之樣品負責，同時此樣品僅保留90天。本報告未經本公司書面許可，不可部份複製。

This document is issued by the Company subject to its General Conditions of Service printed overleaf, available on request or accessible at <http://www.sgs.com.tw/Terms-and-Conditions> and for electronic format documents, subject to Terms and Conditions for Electronic Documents at <http://www.sgs.com.tw/Terms-and-Conditions>. Attention is drawn to the limitation of liability, indemnification and jurisdiction issues defined therein. Any holder of this document is advised that information contained hereon reflects the Company's findings at the time of its intervention only and within the limits of Client's instructions, if any. The Company's sole responsibility is to its Client and this document does not exonerate parties to a transaction from exercising all their rights and obligations under the transaction documents. This document cannot be reproduced except in full, without prior written approval of the Company. Any unauthorized alteration, forgery or falsification of the content or appearance of this document is unlawful and offenders may be prosecuted to the fullest extent of the law.

10.3.2 Conducted Band Edge:

1. To connect Antenna Port of EUT to Spectrum.
2. The testing follows the Measurement Procedure of FCC KDB 558074 D01 DTS Meas. Guidance.
3. Remove the antenna from the EUT and then connect a low loss RF cable from the antenna port to the spectrum analyzer.
4. Set start to edge frequency, and stop frequency of spectrum analyzer so as to encompass the spectrum to be examined.
5. Set the spectrum analyzer as RBW=100 kHz, VBW=300 kHz, Detector = Peak, Sweep = auto
6. Set DL as the limit = reading on marker of reference level measurement – 20dBm
7. Mark the highest readings of the emissions outside of 2400MHz~2483.5MHz.
8. Repeat above procedures until all default test channel (low and high) was complete.

10.3.3 Conducted Spurious Emission:

1. To connect Antenna Port of EUT to Spectrum.
2. The testing follows the Measurement Procedure of FCC KDB 558074 D01 DTS Meas. Guidance.
3. Set RBW = 100 kHz & VBW=300 kHz, Detector =Peak, Sweep = Auto
4. Allow trace to fully stabilize.
5. Use the peak marker function to determine the maximum power level in any 100 kHz band segment within the fundamental EBW.
6. Repeat above procedures until all default test channel measured were complete.

Unless otherwise stated the results shown in this test report refer only to the sample(s) tested and such sample(s) are retained for 90 days only.
除非另有說明，此報告結果僅對測試之樣品負責，同時此樣品僅保留90天。本報告未經本公司書面許可，不可部份複製。

This document is issued by the Company subject to its General Conditions of Service printed overleaf, available on request or accessible at <http://www.sgs.com.tw/Terms-and-Conditions> and for electronic format documents, subject to Terms and Conditions for Electronic Documents at <http://www.sgs.com.tw/Terms-and-Conditions>. Attention is drawn to the limitation of liability, indemnification and jurisdiction issues defined therein. Any holder of this document is advised that information contained hereon reflects the Company's findings at the time of its intervention only and within the limits of Client's instructions, if any. The Company's sole responsibility is to its Client and this document does not exonerate parties to a transaction from exercising all their rights and obligations under the transaction documents. This document cannot be reproduced except in full, without prior written approval of the Company. Any unauthorized alteration, forgery or falsification of the content or appearance of this document is unlawful and offenders may be prosecuted to the fullest extent of the law.

10.4 Measurement Result

Mode: ANT4

BLE 1M_Reference Level of Limit

Frequency (MHz)	RF Power Density (dBm)	Reference Level of Limit = PSD - 20dB (dBm)
2402	5.93	-14.07
2440	5.94	-14.06
2480	6.01	-13.99

Note:

- 1.cable loss as 0.96dB that offsets in the spectrum
- 2.Refer to next page for plots.

BLE 2M_Reference Level of Limit

Frequency (MHz)	RF Power Density (dBm)	Reference Level of Limit = PSD - 20dB (dBm)
2402	6.07	-13.93
2440	6.05	-13.95
2480	6.09	-13.91

Note:

- 1.cable loss as 0.96dB that offsets in the spectrum
- 2.Refer to next page for plots.

PHY=8_Reference Level of Limit

Frequency (MHz)	RF Power Density (dBm)	Reference Level of Limit = PSD - 20dB (dBm)
2402	5.77	-14.23
2440	5.73	-14.27
2480	5.68	-14.32

Note:

- 1.cable loss as 0.96dB that offsets in the spectrum
- 2.Refer to next page for plots.

Unless otherwise stated the results shown in this test report refer only to the sample(s) tested and such sample(s) are retained for 90 days only.
 除非另有說明，此報告結果僅對測試之樣品負責，同時此樣品僅保留90天。本報告未經本公司書面許可，不可部份複製。

This document is issued by the Company subject to its General Conditions of Service printed overleaf, available on request or accessible at <http://www.sgs.com.tw/Terms-and-Conditions> and for electronic format documents, subject to Terms and Conditions for Electronic Documents at <http://www.sgs.com.tw/Terms-and-Conditions>. Attention is drawn to the limitation of liability, indemnification and jurisdiction issues defined therein. Any holder of this document is advised that information contained hereon reflects the Company's findings at the time of its intervention only and within the limits of Client's instructions, if any. The Company's sole responsibility is to its Client and this document does not exonerate parties to a transaction from exercising all their rights and obligations under the transaction documents. This document cannot be reproduced except in full, without prior written approval of the Company. Any unauthorized alteration, forgery or falsification of the content or appearance of this document is unlawful and offenders may be prosecuted to the fullest extent of the law.

PHY=2_Reference Level of Limit

Frequency (MHz)	RF Power Density (dBm)	Reference Level of Limit = PSD - 20dB (dBm)
2402	6.24	-13.76
2440	6.19	-13.81
2480	6.29	-13.71

Note:

- 1.cable loss as 0.96dB that offsets in the spectrum
- 2.Refer to next page for plots.

Mode: ANT8

BLE 1M_Reference Level of Limit

Frequency (MHz)	RF Power Density (dBm)	Reference Level of Limit = PSD - 20dB (dBm)
2402	6.04	-13.96
2440	6.07	-13.93
2480	6.25	-13.75

Note:

- 1.cable loss as 0.96dB that offsets in the spectrum
- 2.Refer to next page for plots.

BLE 2M_Reference Level of Limit

Frequency (MHz)	RF Power Density (dBm)	Reference Level of Limit = PSD - 20dB (dBm)
2402	6.23	-13.77
2440	6.22	-13.78
2480	6.40	-13.60

Note:

- 1.cable loss as 0.96dB that offsets in the spectrum
- 2.Refer to next page for plots.

Unless otherwise stated the results shown in this test report refer only to the sample(s) tested and such sample(s) are retained for 90 days only.
 除非另有說明，此報告結果僅對測試之樣品負責，同時此樣品僅保留90天。本報告未經本公司書面許可，不可部份複製。

This document is issued by the Company subject to its General Conditions of Service printed overleaf, available on request or accessible at <http://www.sgs.com.tw/Terms-and-Conditions> and for electronic format documents, subject to Terms and Conditions for Electronic Documents at <http://www.sgs.com.tw/Terms-and-Conditions>. Attention is drawn to the limitation of liability, indemnification and jurisdiction issues defined therein. Any holder of this document is advised that information contained hereon reflects the Company's findings at the time of its intervention only and within the limits of Client's instructions, if any. The Company's sole responsibility is to its Client and this document does not exonerate parties to a transaction from exercising all their rights and obligations under the transaction documents. This document cannot be reproduced except in full, without prior written approval of the Company. Any unauthorized alteration, forgery or falsification of the content or appearance of this document is unlawful and offenders may be prosecuted to the fullest extent of the law.

PHY=8_Reference Level of Limit

Frequency (MHz)	RF Power Density (dBm)	Reference Level of Limit = PSD - 20dB (dBm)
2402	6.14	-13.86
2440	5.88	-14.12
2480	6.38	-13.62

Note:

- 1.cable loss as 0.96dB that offsets in the spectrum
- 2.Refer to next page for plots.

PHY=2_Reference Level of Limit

Frequency (MHz)	RF Power Density (dBm)	Reference Level of Limit = PSD - 20dB (dBm)
2402	6.67	-13.33
2440	6.41	-13.59
2480	6.59	-13.41

Note:

- 1.cable loss as 0.96dB that offsets in the spectrum
- 2.Refer to next page for plots.

Unless otherwise stated the results shown in this test report refer only to the sample(s) tested and such sample(s) are retained for 90 days only.
 除非另有說明，此報告結果僅對測試之樣品負責，同時此樣品僅保留90天。本報告未經本公司書面許可，不可部份複製。

This document is issued by the Company subject to its General Conditions of Service printed overleaf, available on request or accessible at <http://www.sgs.com.tw/Terms-and-Conditions> and for electronic format documents, subject to Terms and Conditions for Electronic Documents at <http://www.sgs.com.tw/Terms-and-Conditions>. Attention is drawn to the limitation of liability, indemnification and jurisdiction issues defined therein. Any holder of this document is advised that information contained hereon reflects the Company's findings at the time of its intervention only and within the limits of Client's instructions, if any. The Company's sole responsibility is to its Client and this document does not exonerate parties to a transaction from exercising all their rights and obligations under the transaction documents. This document cannot be reproduced except in full, without prior written approval of the Company. Any unauthorized alteration, forgery or falsification of the content or appearance of this document is unlawful and offenders may be prosecuted to the fullest extent of the law.

ANT4_Reference Level_BLE 1M_LowCH00-2402MHz



Reference Level_BLE 2M_LowCH00-2402MHz

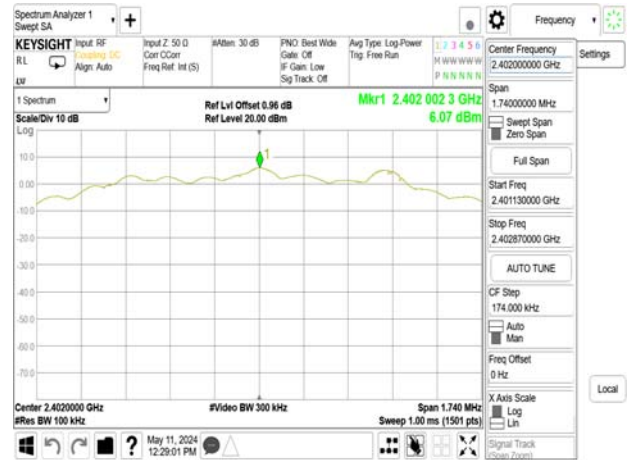

Reference Level_BLE 1M_MidCH19-2440MHz



Reference Level_BLE 2M_MidCH19-2440MHz



Reference Level_BLE 1M_HighCH39-2480MHz



Reference Level_BLE 2M_HighCH39-2480MHz

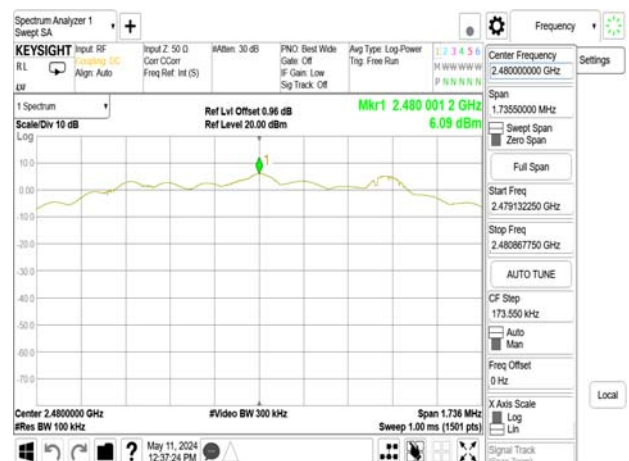

Unless otherwise stated the results shown in this test report refer only to the sample(s) tested and such sample(s) are retained for 90 days only.

除非另有說明，此報告結果僅對測試之樣品負責，同時此樣品僅保留90天。本報告未經本公司書面許可，不可部份複製。

This document is issued by the Company subject to its General Conditions of Service printed overleaf, available on request or accessible at <http://www.sgs.com.tw/Terms-and-Conditions> and for electronic format documents, subject to Terms and Conditions for Electronic Documents at <http://www.sgs.com.tw/Terms-and-Conditions>. Attention is drawn to the limitation of liability, indemnification and jurisdiction issues defined therein. Any holder of this document is advised that information contained hereon reflects the Company's findings at the time of its intervention only and within the limits of Client's instructions, if any. The Company's sole responsibility is to its Client and this document does not exonerate parties to a transaction from exercising all their rights and obligations under the transaction documents. This document cannot be reproduced except in full, without prior written approval of the Company. Any unauthorized alteration, forgery or falsification of the content or appearance of this document is unlawful and offenders may be prosecuted to the fullest extent of the law.

Reference Level_BLE 1M_LowCH00-2402MHz

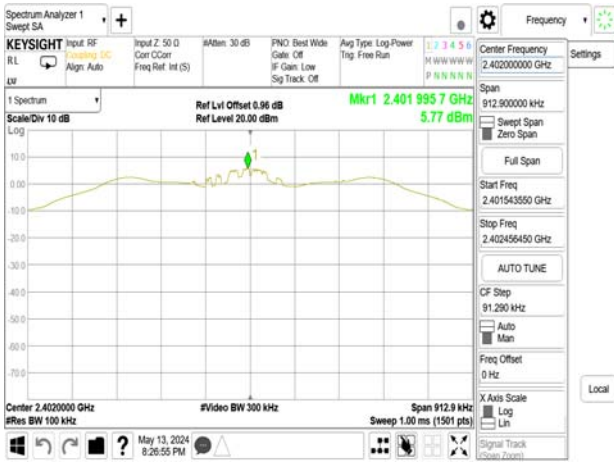

Reference Level_BLE 2M_LowCH00-2402MHz



Reference Level_BLE 1M_MidCH19-2440MHz



Reference Level_BLE 2M_MidCH19-2440MHz



Reference Level_BLE 1M_HighCH39-2480MHz



Reference Level_BLE 2M_HighCH39-2480MHz



Unless otherwise stated the results shown in this test report refer only to the sample(s) tested and such sample(s) are retained for 90 days only.

除非另有說明，此報告結果僅對測試之樣品負責，同時此樣品僅保留90天。本報告未經本公司書面許可，不可部份複製。

This document is issued by the Company subject to its General Conditions of Service printed overleaf, available on request or accessible at <http://www.sgs.com.tw/Terms-and-Conditions> and for electronic format documents, subject to Terms and Conditions for Electronic Documents at <http://www.sgs.com.tw/Terms-and-Conditions>. Attention is drawn to the limitation of liability, indemnification and jurisdiction issues defined therein. Any holder of this document is advised that information contained hereon reflects the Company's findings at the time of its intervention only and within the limits of Client's instructions, if any. The Company's sole responsibility is to its Client and this document does not exonerate parties to a transaction from exercising all their rights and obligations under the transaction documents. This document cannot be reproduced except in full, without prior written approval of the Company. Any unauthorized alteration, forgery or falsification of the content or appearance of this document is unlawful and offenders may be prosecuted to the fullest extent of the law.

Band Edge_BLE 1M_LowCH00-2402MHz

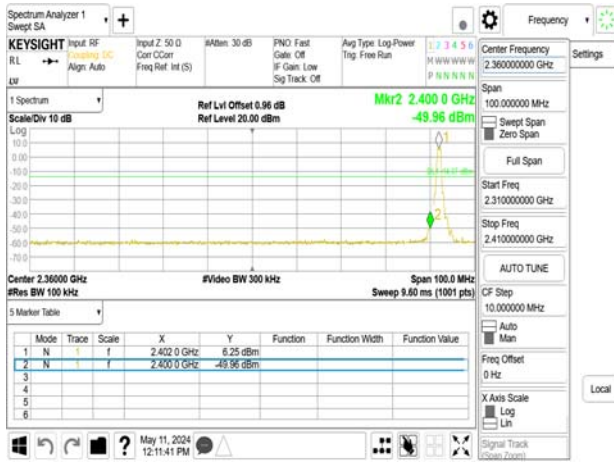

Band Edge_BLE 2M_HighCH39-2480MHz

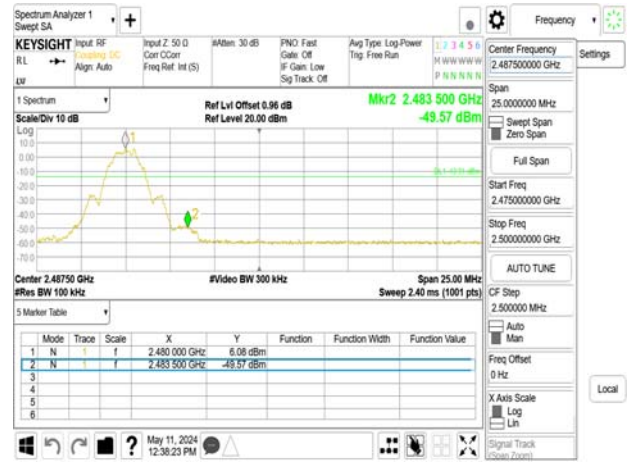

Band Edge_BLE 1M_HighCH39-2480MHz

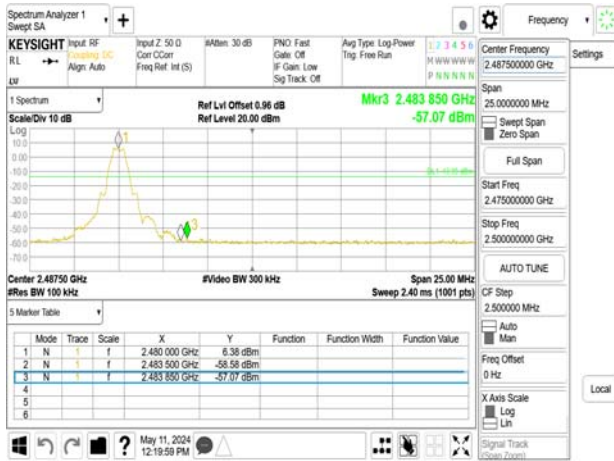

Band Edge_BLE 1M_LowCH00-2402MHz

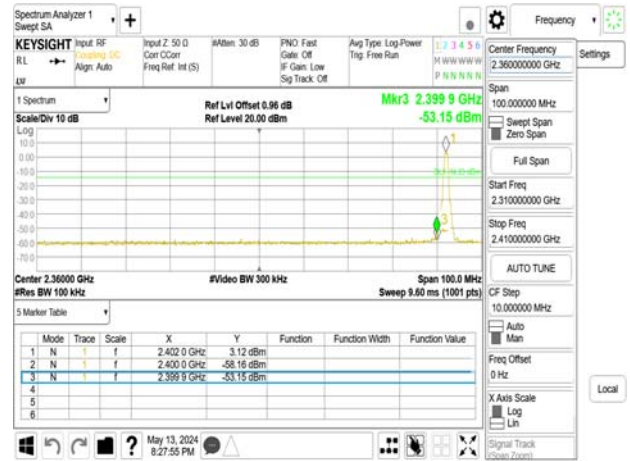

Band Edge_BLE 2M_LowCH00-2402MHz

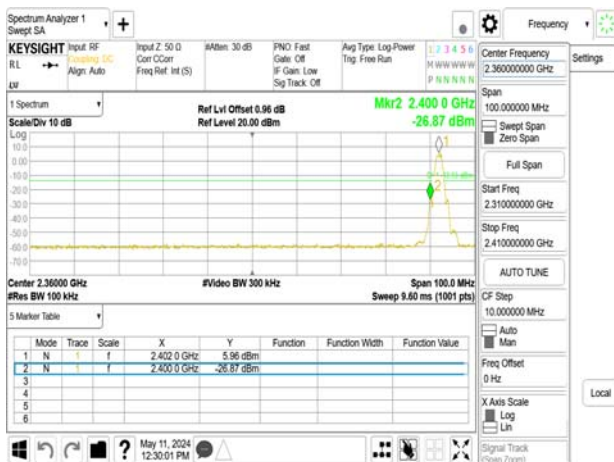

Band Edge_BLE 1M_HighCH39-2480MHz

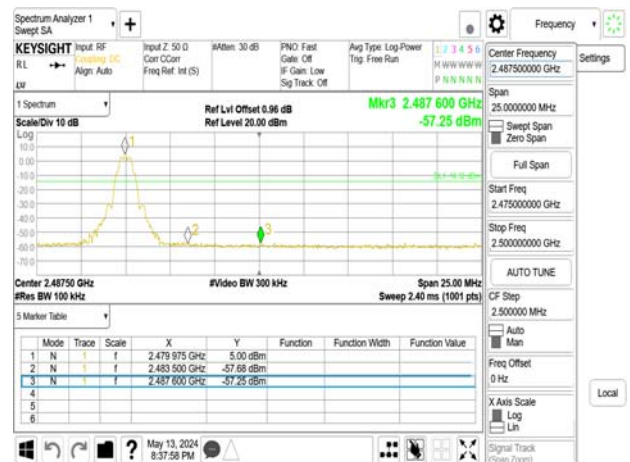

Unless otherwise stated the results shown in this test report refer only to the sample(s) tested and such sample(s) are retained for 90 days only.

除非另有說明，此報告結果僅對測試之樣品負責，同時此樣品僅保留90天。本報告未經本公司書面許可，不可部份複製。

This document is issued by the Company subject to its General Conditions of Service printed overleaf, available on request or accessible at <http://www.sgs.com.tw/Terms-and-Conditions> and for electronic format documents, subject to Terms and Conditions for Electronic Documents at <http://www.sgs.com.tw/Terms-and-Conditions>. Attention is drawn to the limitation of liability, indemnification and jurisdiction issues defined therein. Any holder of this document is advised that information contained hereon reflects the Company's findings at the time of its intervention only and within the limits of Client's instructions, if any. The Company's sole responsibility is to its Client and this document does not exonerate parties to a transaction from exercising all their rights and obligations under the transaction documents. This document cannot be reproduced except in full, without prior written approval of the Company. Any unauthorized alteration, forgery or falsification of the content or appearance of this document is unlawful and offenders may be prosecuted to the fullest extent of the law.

Band Edge_BLE 2M_LowCH00-2402MHz

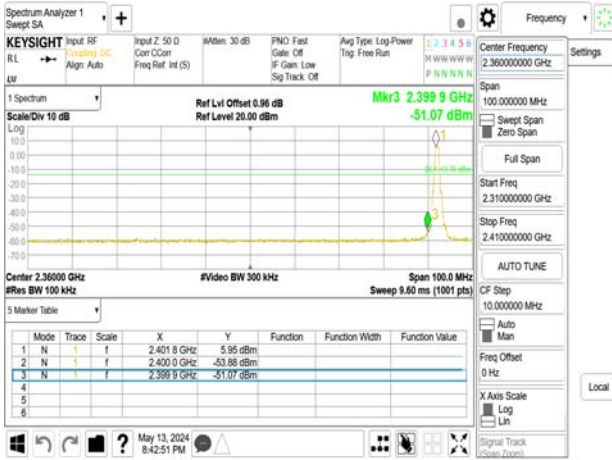

Spurious Emission_BLE 1M_MidCH19-2440MHz

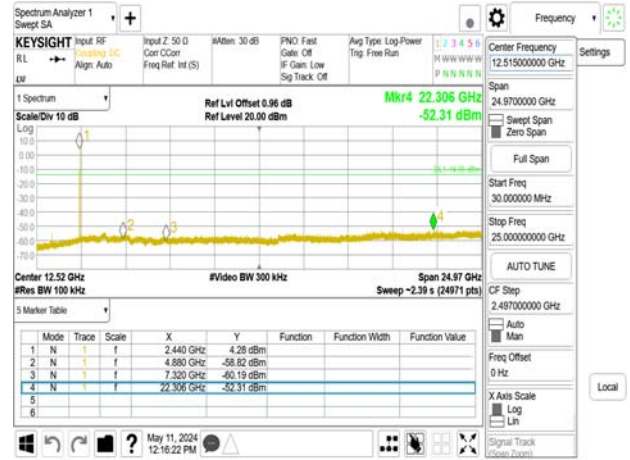

Band Edge_BLE 2M_HighCH39-2480MHz

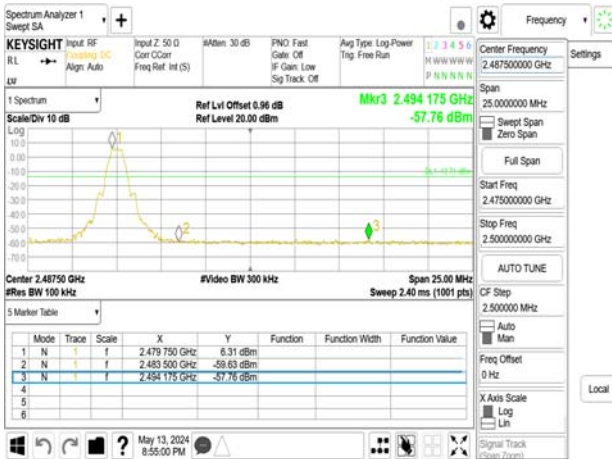

Spurious Emission_BLE 1M_HighCH39-2480MHz

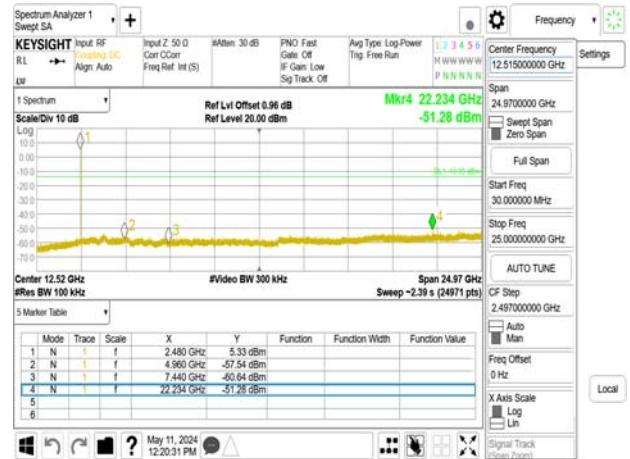

Spurious Emission_BLE 1M_LowCH00-2402MHz

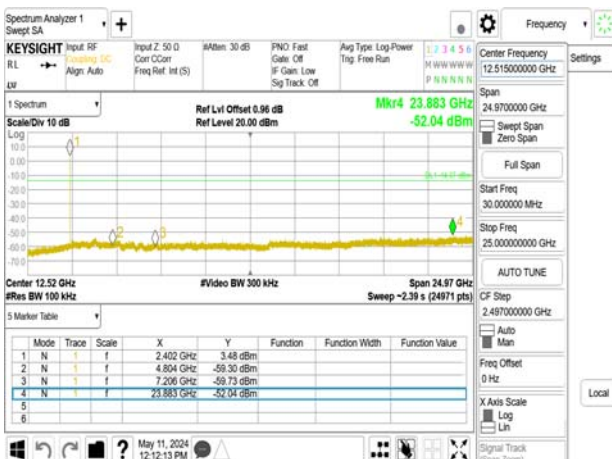

Spurious Emission_BLE 2M_LowCH00-2402MHz

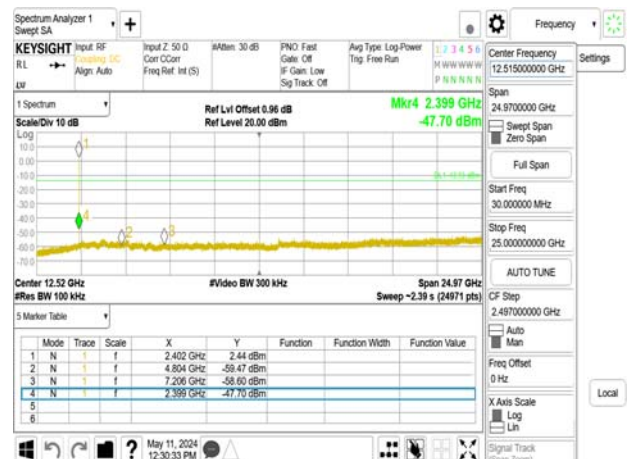

Unless otherwise stated the results shown in this test report refer only to the sample(s) tested and such sample(s) are retained for 90 days only.

除非另有說明，此報告結果僅對測試之樣品負責，同時此樣品僅保留90天。本報告未經本公司書面許可，不可部份複製。

This document is issued by the Company subject to its General Conditions of Service printed overleaf, available on request or accessible at <http://www.sgs.com.tw/Terms-and-Conditions> and for electronic format documents, subject to Terms and Conditions for Electronic Documents at <http://www.sgs.com.tw/Terms-and-Conditions>. Attention is drawn to the limitation of liability, indemnification and jurisdiction issues defined therein. Any holder of this document is advised that information contained hereon reflects the Company's findings at the time of its intervention only and within the limits of Client's instructions, if any. The Company's sole responsibility is to its Client and this document does not exonerate parties to a transaction from exercising all their rights and obligations under the transaction documents. This document cannot be reproduced except in full, without prior written approval of the Company. Any unauthorized alteration, forgery or falsification of the content or appearance of this document is unlawful and offenders may be prosecuted to the fullest extent of the law.

Spurious Emission_BLE 2M_MidCH19-2440MHz

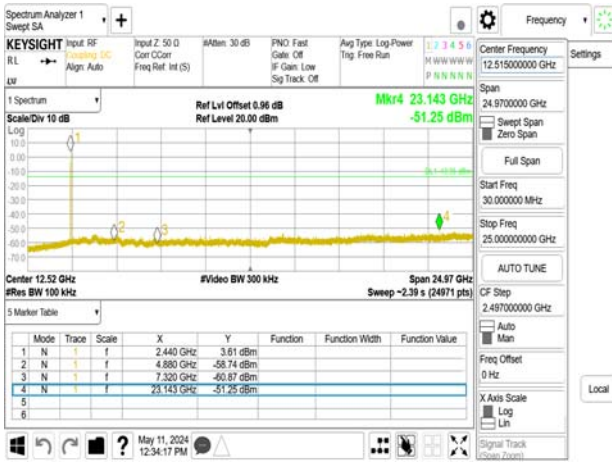

Spurious Emission_BLE 1M_MidCH19-2440MHz

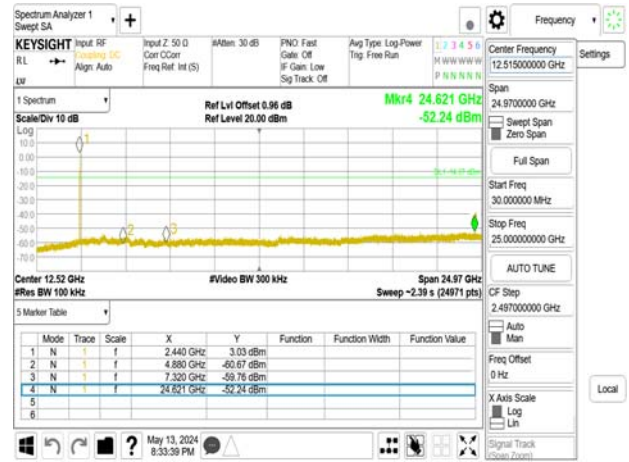

Spurious Emission_BLE 2M_HighCH39-2480MHz

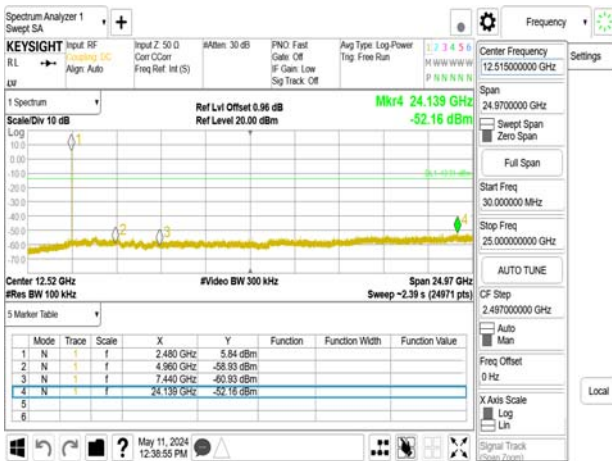

Spurious Emission_BLE 1M_HighCH39-2480MHz



Spurious Emission_BLE 1M_LowCH00-2402MHz

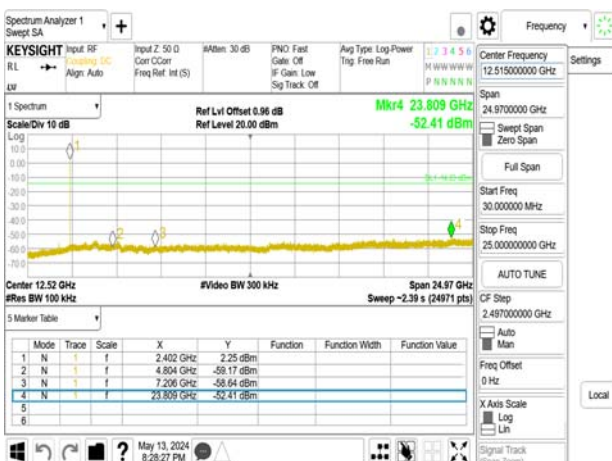

Spurious Emission_BLE 2M_LowCH00-2402MHz

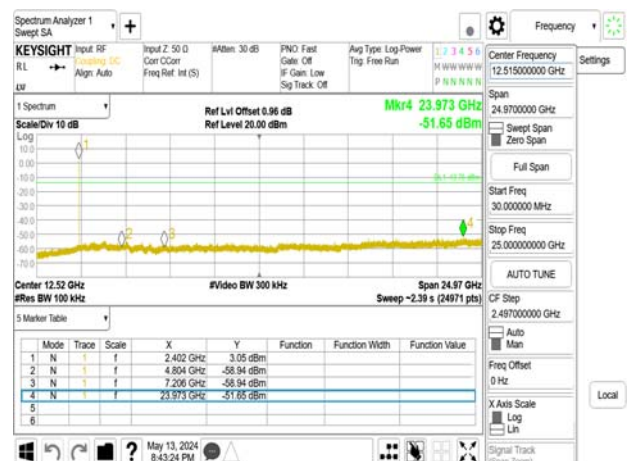

Unless otherwise stated the results shown in this test report refer only to the sample(s) tested and such sample(s) are retained for 90 days only.

除非另有說明，此報告結果僅對測試之樣品負責，同時此樣品僅保留90天。本報告未經本公司書面許可，不可部份複製。

This document is issued by the Company subject to its General Conditions of Service printed overleaf, available on request or accessible at <http://www.sgs.com.tw/Terms-and-Conditions> and for electronic format documents, subject to Terms and Conditions for Electronic Documents at <http://www.sgs.com.tw/Terms-and-Conditions>. Attention is drawn to the limitation of liability, indemnification and jurisdiction issues defined therein. Any holder of this document is advised that information contained hereon reflects the Company's findings at the time of its intervention only and within the limits of Client's instructions, if any. The Company's sole responsibility is to its Client and this document does not exonerate parties to a transaction from exercising all their rights and obligations under the transaction documents. This document cannot be reproduced except in full, without prior written approval of the Company. Any unauthorized alteration, forgery or falsification of the content or appearance of this document is unlawful and offenders may be prosecuted to the fullest extent of the law.

Spurious Emission_BLE 2M_MidCH19-2440MHz

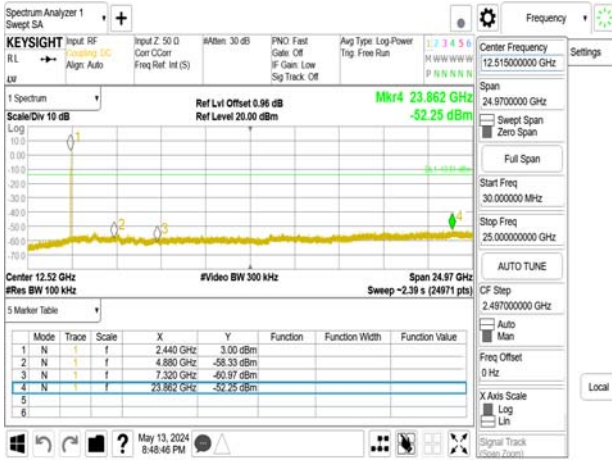

ANT8_Reference Level_BLE 1M_LowCH00-2402MHz



Spurious Emission_BLE 2M_HighCH39-2480MHz

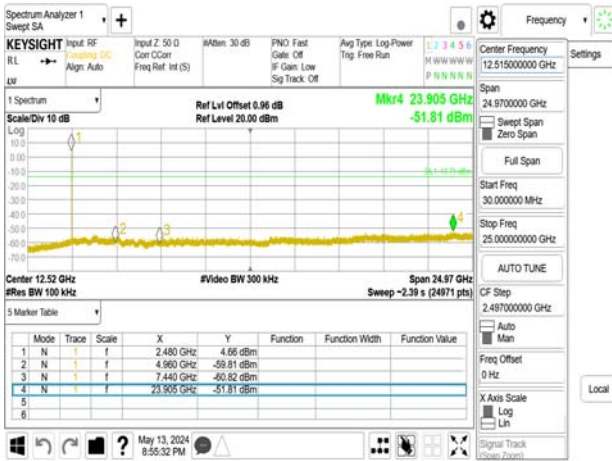

Reference Level_BLE 1M_MidCH19-2440MHz



Reference Level_BLE 1M_HighCH39-2480MHz



Unless otherwise stated the results shown in this test report refer only to the sample(s) tested and such sample(s) are retained for 90 days only.

除非另有說明，此報告結果僅對測試之樣品負責，同時此樣品僅保留90天。本報告未經本公司書面許可，不可部份複製。

This document is issued by the Company subject to its General Conditions of Service printed overleaf, available on request or accessible at <http://www.sgs.com.tw/Terms-and-Conditions> and for electronic format documents, subject to Terms and Conditions for Electronic Documents at <http://www.sgs.com.tw/Terms-and-Conditions>. Attention is drawn to the limitation of liability, indemnification and jurisdiction issues defined therein. Any holder of this document is advised that information contained hereon reflects the Company's findings at the time of its intervention only and within the limits of Client's instructions, if any. The Company's sole responsibility is to its Client and this document does not exonerate parties to a transaction from exercising all their rights and obligations under the transaction documents. This document cannot be reproduced except in full, without prior written approval of the Company. Any unauthorized alteration, forgery or falsification of the content or appearance of this document is unlawful and offenders may be prosecuted to the fullest extent of the law.

Reference Level_BLE 2M_LowCH00-2402MHz

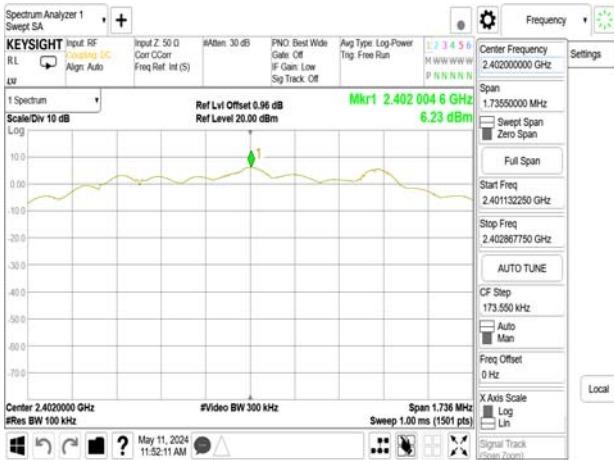

Reference Level_BLE 1M_LowCH00-2402MHz



Reference Level_BLE 2M_MidCH19-2440MHz



Reference Level_BLE 1M_MidCH19-2440MHz



Reference Level_BLE 2M_HighCH39-2480MHz

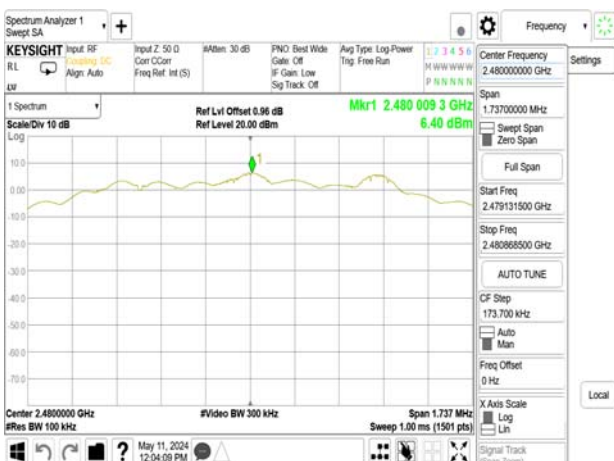

Reference Level_BLE 1M_HighCH39-2480MHz



Unless otherwise stated the results shown in this test report refer only to the sample(s) tested and such sample(s) are retained for 90 days only.

除非另有說明，此報告結果僅對測試之樣品負責，同時此樣品僅保留90天。本報告未經本公司書面許可，不可部份複製。

This document is issued by the Company subject to its General Conditions of Service printed overleaf, available on request or accessible at <http://www.sgs.com.tw/Terms-and-Conditions> and for electronic format documents, subject to Terms and Conditions for Electronic Documents at <http://www.sgs.com.tw/Terms-and-Conditions>. Attention is drawn to the limitation of liability, indemnification and jurisdiction issues defined therein. Any holder of this document is advised that information contained hereon reflects the Company's findings at the time of its intervention only and within the limits of Client's instructions, if any. The Company's sole responsibility is to its Client and this document does not exonerate parties to a transaction from exercising all their rights and obligations under the transaction documents. This document cannot be reproduced except in full, without prior written approval of the Company. Any unauthorized alteration, forgery or falsification of the content or appearance of this document is unlawful and offenders may be prosecuted to the fullest extent of the law.

Reference Level_BLE 2M_LowCH00-2402MHz



Band Edge_BLE 1M_LowCH00-2402MHz

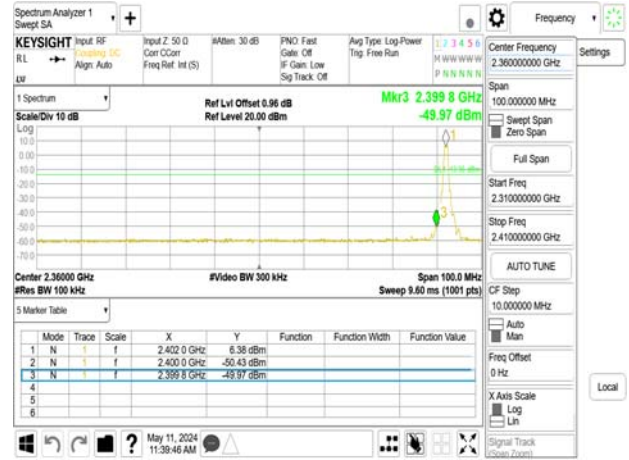

Reference Level_BLE 2M_MidCH19-2440MHz



Band Edge_BLE 1M_HighCH39-2480MHz

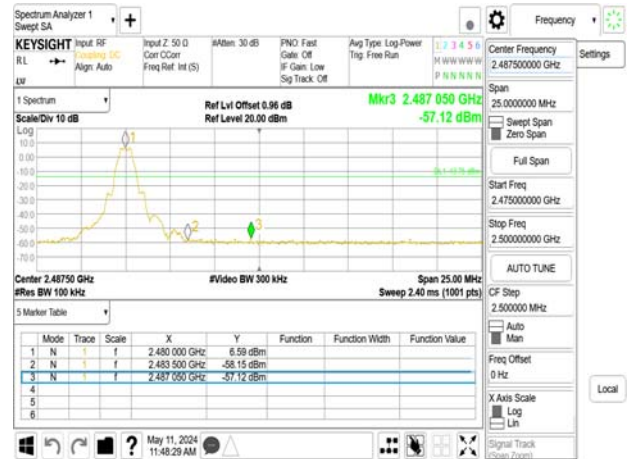

Reference Level_BLE 2M_HighCH39-2480MHz



Band Edge_BLE 2M_LowCH00-2402MHz

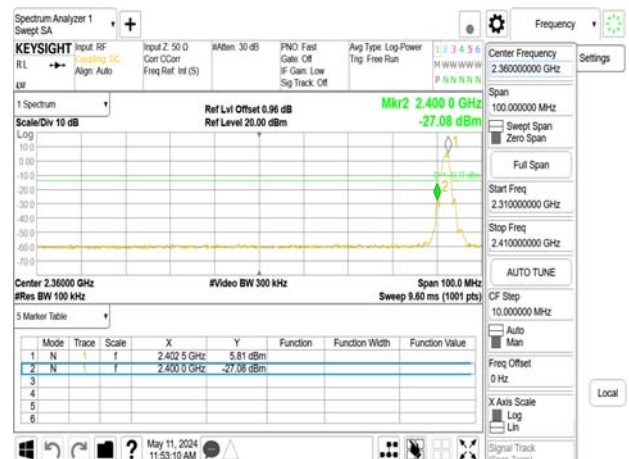

Unless otherwise stated the results shown in this test report refer only to the sample(s) tested and such sample(s) are retained for 90 days only.

除非另有說明，此報告結果僅對測試之樣品負責，同時此樣品僅保留90天。本報告未經本公司書面許可，不可部份複製。

This document is issued by the Company subject to its General Conditions of Service printed overleaf, available on request or accessible at <http://www.sgs.com.tw/Terms-and-Conditions> and for electronic format documents, subject to Terms and Conditions for Electronic Documents at <http://www.sgs.com.tw/Terms-and-Conditions>. Attention is drawn to the limitation of liability, indemnification and jurisdiction issues defined therein. Any holder of this document is advised that information contained hereon reflects the Company's findings at the time of its intervention only and within the limits of Client's instructions, if any. The Company's sole responsibility is to its Client and this document does not exonerate parties to a transaction from exercising all their rights and obligations under the transaction documents. This document cannot be reproduced except in full, without prior written approval of the Company. Any unauthorized alteration, forgery or falsification of the content or appearance of this document is unlawful and offenders may be prosecuted to the fullest extent of the law.

Band Edge_BLE 2M_HighCH39-2480MHz

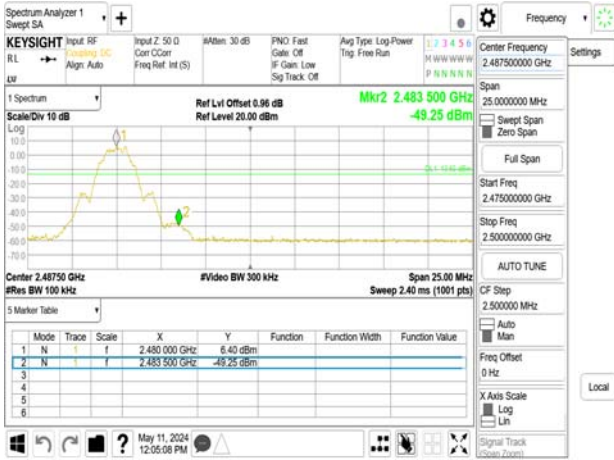

Band Edge_BLE 2M_LowCH00-2402MHz

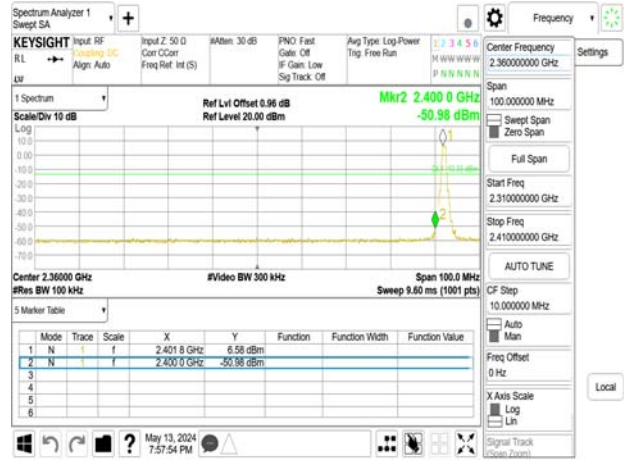

Band Edge_BLE 1M_LowCH00-2402MHz

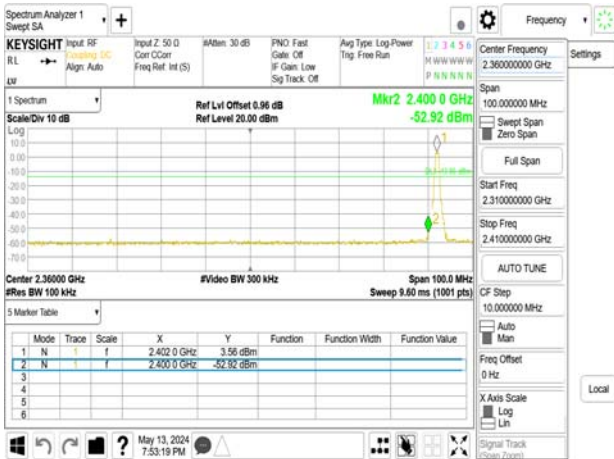

Band Edge_BLE 2M_HighCH39-2480MHz

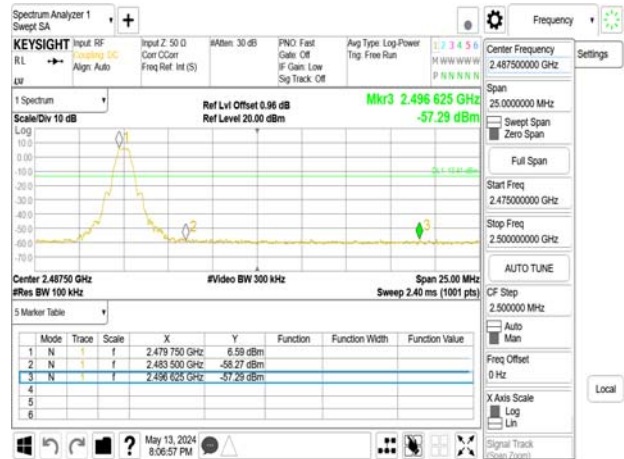

Band Edge_BLE 1M_HighCH39-2480MHz

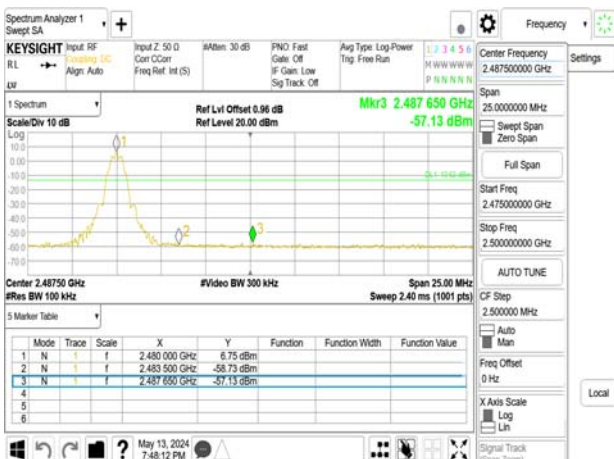

Spurious Emission_BLE 1M_LowCH00-2402MHz

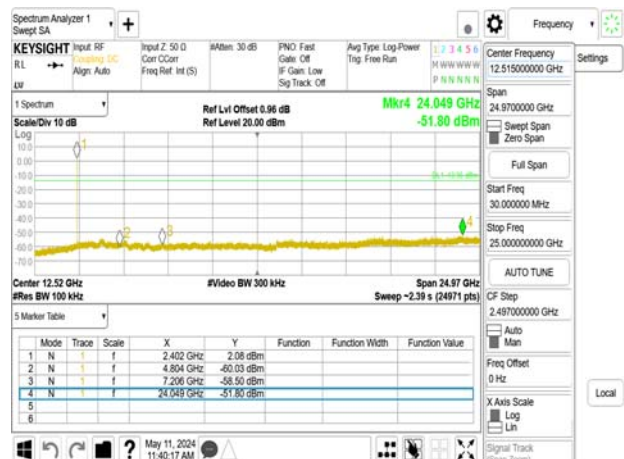

Unless otherwise stated the results shown in this test report refer only to the sample(s) tested and such sample(s) are retained for 90 days only.

除非另有說明，此報告結果僅對測試之樣品負責，同時此樣品僅保留90天。本報告未經本公司書面許可，不可部份複製。

This document is issued by the Company subject to its General Conditions of Service printed overleaf, available on request or accessible at <http://www.sgs.com.tw/Terms-and-Conditions> and for electronic format documents, subject to Terms and Conditions for Electronic Documents at <http://www.sgs.com.tw/Terms-and-Conditions>. Attention is drawn to the limitation of liability, indemnification and jurisdiction issues defined therein. Any holder of this document is advised that information contained hereon reflects the Company's findings at the time of its intervention only and within the limits of Client's instructions, if any. The Company's sole responsibility is to its Client and this document does not exonerate parties to a transaction from exercising all their rights and obligations under the transaction documents. This document cannot be reproduced except in full, without prior written approval of the Company. Any unauthorized alteration, forgery or falsification of the content or appearance of this document is unlawful and offenders may be prosecuted to the fullest extent of the law.

Spurious Emission_BLE 1M_MidCH19-2440MHz

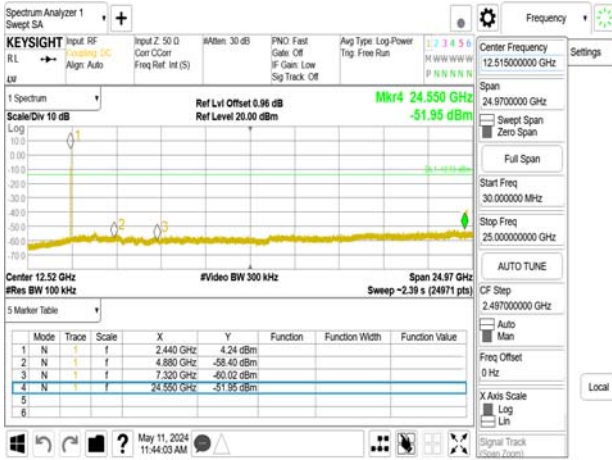

Spurious Emission_BLE 2M_MidCH19-2440MHz

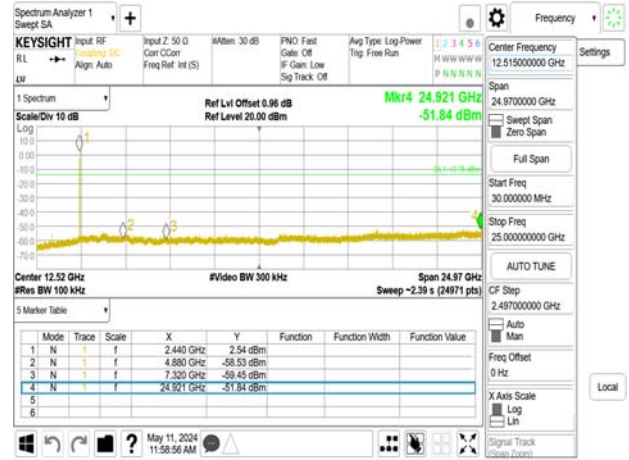

Spurious Emission_BLE 1M_HighCH39-2480MHz

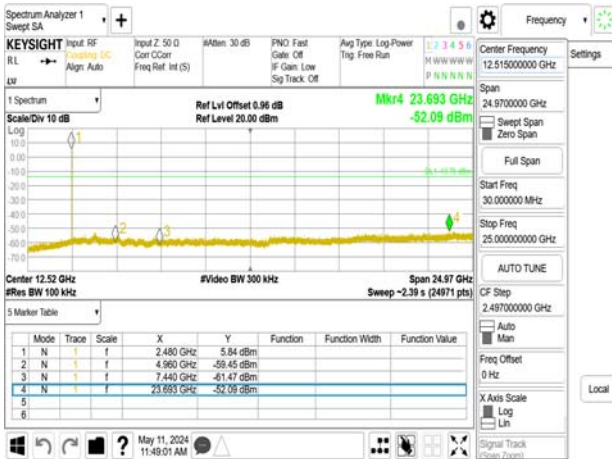

Spurious Emission_BLE 2M_HighCH39-2480MHz

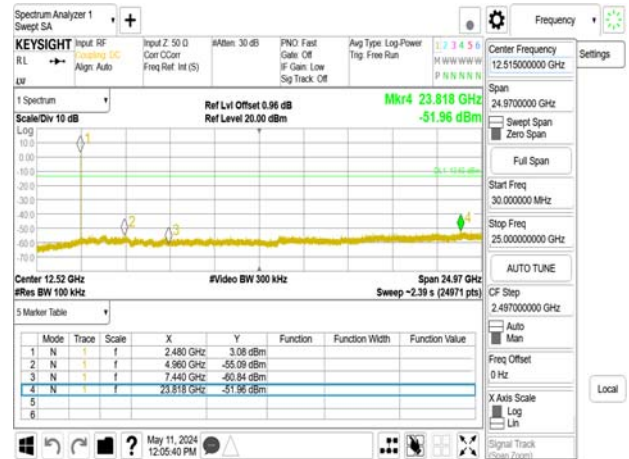

Spurious Emission_BLE 2M_LowCH00-2402MHz

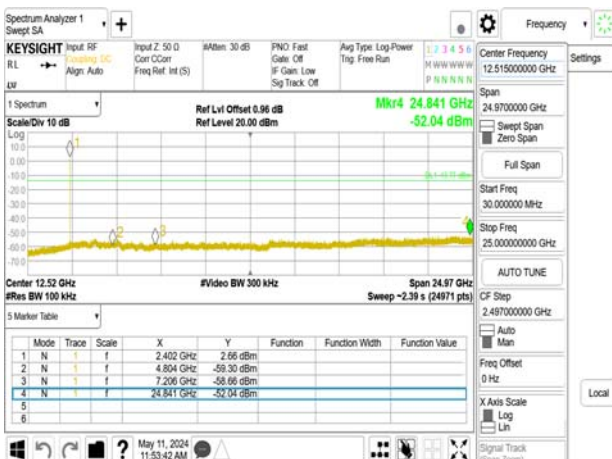

Spurious Emission_BLE 1M_LowCH00-2402MHz

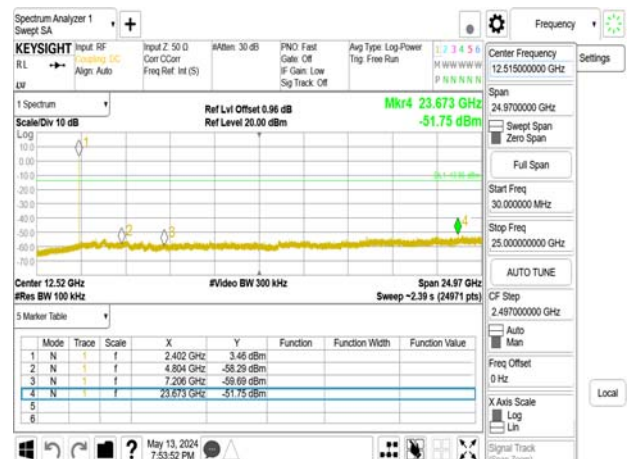

Unless otherwise stated the results shown in this test report refer only to the sample(s) tested and such sample(s) are retained for 90 days only.

除非另有說明，此報告結果僅對測試之樣品負責，同時此樣品僅保留90天。本報告未經本公司書面許可，不可部份複製。

This document is issued by the Company subject to its General Conditions of Service printed overleaf, available on request or accessible at <http://www.sgs.com.tw/Terms-and-Conditions> and for electronic format documents, subject to Terms and Conditions for Electronic Documents at <http://www.sgs.com.tw/Terms-and-Conditions>. Attention is drawn to the limitation of liability, indemnification and jurisdiction issues defined therein. Any holder of this document is advised that information contained hereon reflects the Company's findings at the time of its intervention only and within the limits of Client's instructions, if any. The Company's sole responsibility is to its Client and this document does not exonerate parties to a transaction from exercising all their rights and obligations under the transaction documents. This document cannot be reproduced except in full, without prior written approval of the Company. Any unauthorized alteration, forgery or falsification of the content or appearance of this document is unlawful and offenders may be prosecuted to the fullest extent of the law.

Spurious Emission_BLE 1M_MidCH19-2440MHz

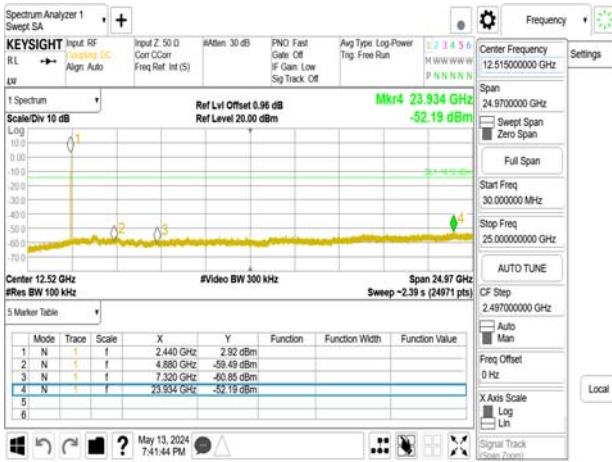

Spurious Emission_BLE 2M_MidCH19-2440MHz

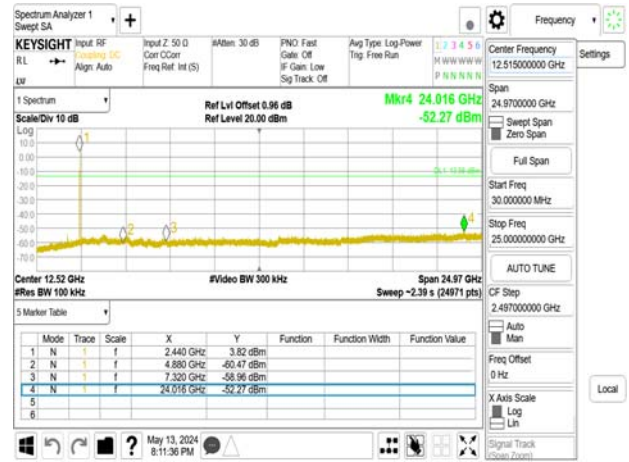

Spurious Emission_BLE 1M_HighCH39-2480MHz

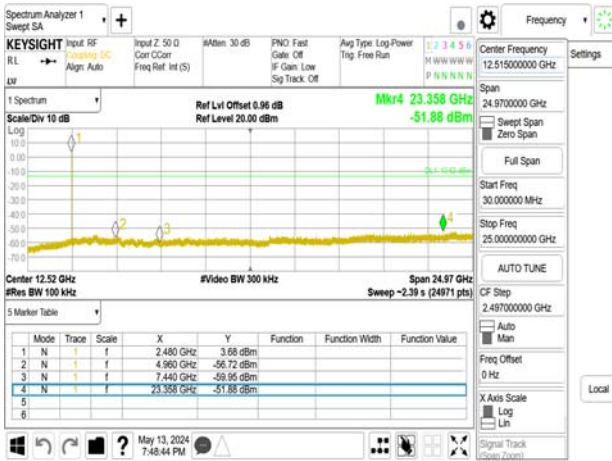

Spurious Emission_BLE 2M_HighCH39-2480MHz

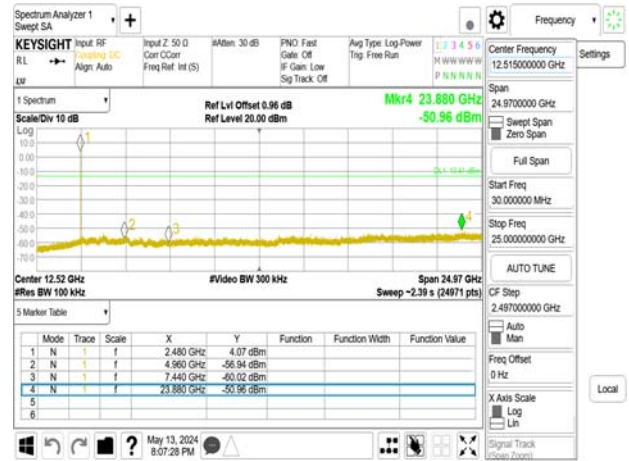

Spurious Emission_BLE 2M_LowCH00-2402MHz

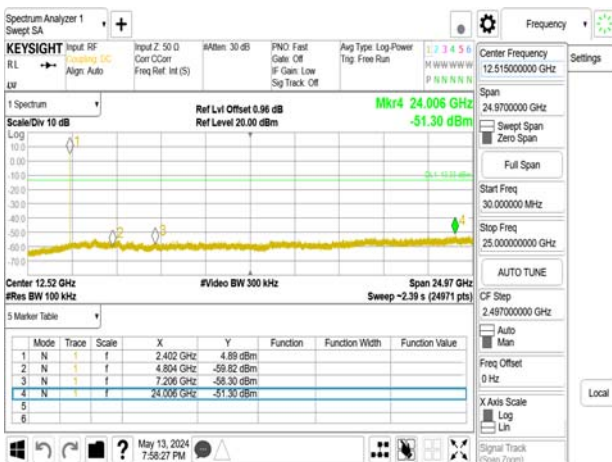

Unless otherwise stated the results shown in this test report refer only to the sample(s) tested and such sample(s) are retained for 90 days only.

除非另有說明，此報告結果僅對測試之樣品負責，同時此樣品僅保留90天。本報告未經本公司書面許可，不可部份複製。

This document is issued by the Company subject to its General Conditions of Service printed overleaf, available on request or accessible at <http://www.sgs.com.tw/Terms-and-Conditions> and for electronic format documents, subject to Terms and Conditions for Electronic Documents at <http://www.sgs.com.tw/Terms-and-Conditions>. Attention is drawn to the limitation of liability, indemnification and jurisdiction issues defined therein. Any holder of this document is advised that information contained hereon reflects the Company's findings at the time of its intervention only and within the limits of Client's instructions, if any. The Company's sole responsibility is to its Client and this document does not exonerate parties to a transaction from exercising all their rights and obligations under the transaction documents. This document cannot be reproduced except in full, without prior written approval of the Company. Any unauthorized alteration, forgery or falsification of the content or appearance of this document is unlawful and offenders may be prosecuted to the fullest extent of the law.

11 RADIATED BANDEDGE AND SPURIOUS EMISSION MEASUREMENT

Spurious Emission

In any 100 kHz bandwidth outside the frequency band in which the spread spectrum or digitally modulated intentional radiator is operating, the radio frequency power that is produced by the intentional radiator shall be at least 20 dB below that in the 100 kHz bandwidth within the band that contains the highest level of the desired power, based on either an RF conducted or a radiated measurement, provided the transmitter demonstrates compliance with the peak conducted power limits. In addition, radiated emissions which fall in the restricted bands must also comply with the §15.209 limit as below.

And according to §15.33(a) (1) for an intentional radiator operates below 10GHz, the frequency range of measurements: to the tenth harmonic of the highest fundamental frequency or to 40GHz, whichever is lower.

Frequency (MHz)	Field strength (microvolts/meter)	Distance (meters)
0.009-0.490	2400/F(kHz)	300
0.490-1.705	24000/F(kHz)	30
1.705-30	30	30
30-88	100	3
88-216	150	3
216-960	200	3
Above 960	500	3

Note: The lower limit shall apply at the transition frequencies.

Unless otherwise stated the results shown in this test report refer only to the sample(s) tested and such sample(s) are retained for 90 days only.
 除非另有說明，此報告結果僅對測試之樣品負責，同時此樣品僅保留90天。本報告未經本公司書面許可，不可部份複製。

This document is issued by the Company subject to its General Conditions of Service printed overleaf, available on request or accessible at <http://www.sgs.com.tw/Terms-and-Conditions> and for electronic format documents, subject to Terms and Conditions for Electronic Documents at <http://www.sgs.com.tw/Terms-and-Conditions>. Attention is drawn to the limitation of liability, indemnification and jurisdiction issues defined therein. Any holder of this document is advised that information contained hereon reflects the Company's findings at the time of its intervention only and within the limits of Client's instructions, if any. The Company's sole responsibility is to its Client and this document does not exonerate parties to a transaction from exercising all their rights and obligations under the transaction documents. This document cannot be reproduced except in full, without prior written approval of the Company. Any unauthorized alteration, forgery or falsification of the content or appearance of this document is unlawful and offenders may be prosecuted to the fullest extent of the law.

11.1 Test Setup

(A) Radiated Emission Test Set-Up, Frequency Below 30MHz.

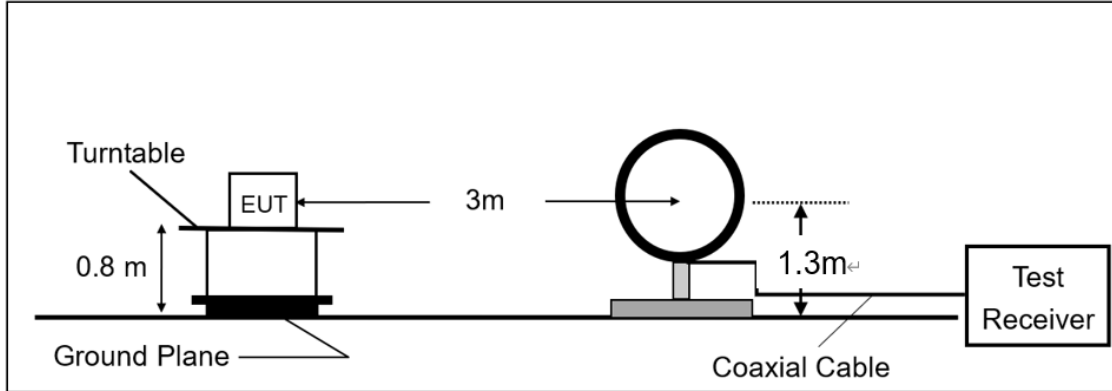

(B) Radiated Emission Test Set-Up, Frequency From 30MHz to 1000MHz.

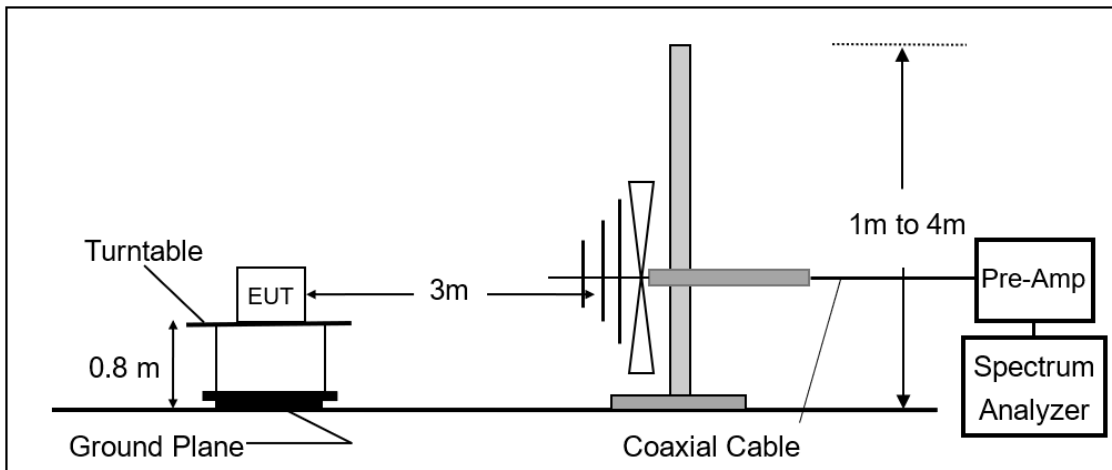

(C) Radiated Emission Test Set-Up, Frequency Above 1GHz.

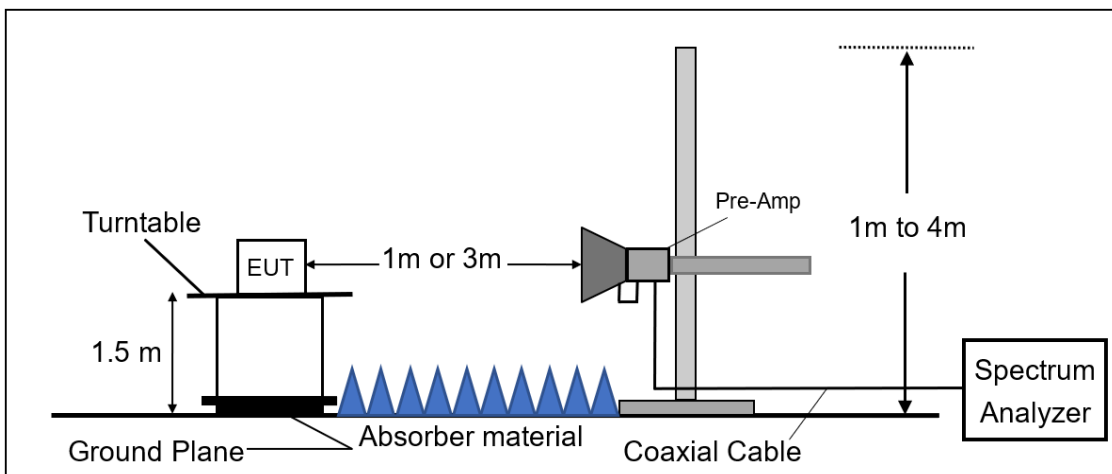

Unless otherwise stated the results shown in this test report refer only to the sample(s) tested and such sample(s) are retained for 90 days only.

除非另有說明，此報告結果僅對測試之樣品負責，同時此樣品僅保留90天。本報告未經本公司書面許可，不可部份複製。

This document is issued by the Company subject to its General Conditions of Service printed overleaf, available on request or accessible at <http://www.sgs.com.tw/Terms-and-Conditions> and for electronic format documents, subject to Terms and Conditions for Electronic Documents at <http://www.sgs.com.tw/Terms-and-Conditions>. Attention is drawn to the limitation of liability, indemnification and jurisdiction issues defined therein. Any holder of this document is advised that information contained hereon reflects the Company's findings at the time of its intervention only and within the limits of Client's instructions, if any. The Company's sole responsibility is to its Client and this document does not exonerate parties to a transaction from exercising all their rights and obligations under the transaction documents. This document cannot be reproduced except in full, without prior written approval of the Company. Any unauthorized alteration, forgery or falsification of the content or appearance of this document is unlawful and offenders may be prosecuted to the fullest extent of the law.

11.2 Measurement Procedure

1. The testing follows the Measurement Procedure of FCC KDB 558074 D01 DTS Meas. Guidance.
2. The EUT was placed on a turn table with 0.8m for frequency < 1GHz and 1.5m for frequency > 1GHz above ground plane.
3. The turn table shall rotate 360 degrees to determine the position of maximum emission level.
4. EUT is set 3m away from the receiving antenna which varied from 1m to 4m to find out the highest emissions.
5. Set the spectrum analyzer as RBW=100 kHz and VBW=300 kHz for Peak Detector (PK) at frequency between 30MHz and 1 GHz.
6. Use receiver mode as RBW=120 kHz for Quasi-peak (QP) at frequency between 30MHz and 1 GHz.
7. Set the spectrum analyzer as RBW=1 MHz, VBW=3 MHz for Maximum Emission Measurements at frequency above 1 GHz.
8. Set the spectrum analyzer as RBW=1 MHz, VBW=10 Hz (Duty cycle > 98%) or VBW ≥ 1/T (Duty cycle < 98%) for Average Emission Measurements at frequency above 1 GHz.
9. When measurement procedures for electric field radiated emissions above 1 GHz the EUT measurement is to be made “while keeping the antenna in the ‘cone of radiation’ from that area and pointed at the area both in azimuth and elevation, with polarization oriented for maximum response.” is still within the 3dB illumination BW of the measurement antenna.
10. Maximum procedure was performed on the six highest emissions to ensure EUT compliance.
11. And also, each emission was to be maximized by changing the polarization of receiving antenna both horizontal and vertical.
12. Repeat above procedures until all default test channel measured were complete.

Unless otherwise stated the results shown in this test report refer only to the sample(s) tested and such sample(s) are retained for 90 days only.
除非另有說明，此報告結果僅對測試之樣品負責，同時此樣品僅保留90天。本報告未經本公司書面許可，不可部份複製。

This document is issued by the Company subject to its General Conditions of Service printed overleaf, available on request or accessible at <http://www.sgs.com.tw/Terms-and-Conditions> and for electronic format documents, subject to Terms and Conditions for Electronic Documents at <http://www.sgs.com.tw/Terms-and-Conditions>. Attention is drawn to the limitation of liability, indemnification and jurisdiction issues defined therein. Any holder of this document is advised that information contained hereon reflects the Company's findings at the time of its intervention only and within the limits of Client's instructions, if any. The Company's sole responsibility is to its Client and this document does not exonerate parties to a transaction from exercising all their rights and obligations under the transaction documents. This document cannot be reproduced except in full, without prior written approval of the Company. Any unauthorized alteration, forgery or falsification of the content or appearance of this document is unlawful and offenders may be prosecuted to the fullest extent of the law.

11.3 Field Strength Calculation

The field strength is calculated by adding the Antenna Factor and Cable Factor and subtracting the Amplifier Gain and Duty Cycle Correction Factor (if any) from the measured reading. The basic equation with a sample calculation is as follows:

$$FS = RA + AF + CL - AG$$

Where *FS = Field Strength*

CL = Cable Attenuation Factor (Cable Loss)

RA = Reading Amplitude

AG = Amplifier Gain

AF = Antenna Factor

The limit of the emission level is expressed in dBuV/m, which converts $20 \cdot \log(uV/m)$

Actual FS(dBμV/m) = SPA. Reading level(dBμV) + Factor(dB)

Factor(dB) = Antenna Factor(dBμV/m) + Cable Loss(dB) – Pre_Amplifier Gain(dB)

11.4 Test Results of Radiated Spurious Emissions from 9 kHz to 30 MHz

The low frequency, which started from 9 kHz to 30MHz, was pre-scanned and the result which was 20dB lower than the limit per 15.31(o) was not reported.

Unless otherwise stated the results shown in this test report refer only to the sample(s) tested and such sample(s) are retained for 90 days only.
 除非另有說明，此報告結果僅對測試之樣品負責，同時此樣品僅保留90天。本報告未經本公司書面許可，不可部份複製。

This document is issued by the Company subject to its General Conditions of Service printed overleaf, available on request or accessible at <http://www.sgs.com.tw/Terms-and-Conditions> and for electronic format documents, subject to Terms and Conditions for Electronic Documents at <http://www.sgs.com.tw/Terms-and-Conditions>. Attention is drawn to the limitation of liability, indemnification and jurisdiction issues defined therein. Any holder of this document is advised that information contained hereon reflects the Company's findings at the time of its intervention only and within the limits of Client's instructions, if any. The Company's sole responsibility is to its Client and this document does not exonerate parties to a transaction from exercising all their rights and obligations under the transaction documents. This document cannot be reproduced except in full, without prior written approval of the Company. Any unauthorized alteration, forgery or falsification of the content or appearance of this document is unlawful and offenders may be prosecuted to the fullest extent of the law.

11.4.1 Radiated Band Edge Measurement Result

Mode: ANT4

Report Number :TERF2404001033ER
 Operation Mode :BLE 1M
 Test Frequency :2402 MHz
 Test Mode :Bandedge
 EUT Pol :E1 Plane

Test Site :SAC 2
 Test Date :2024-05-08
 Temp./Humi. :23.1°C/62%
 Antenna Pol. :Vertical
 Engineer :Eason Wang

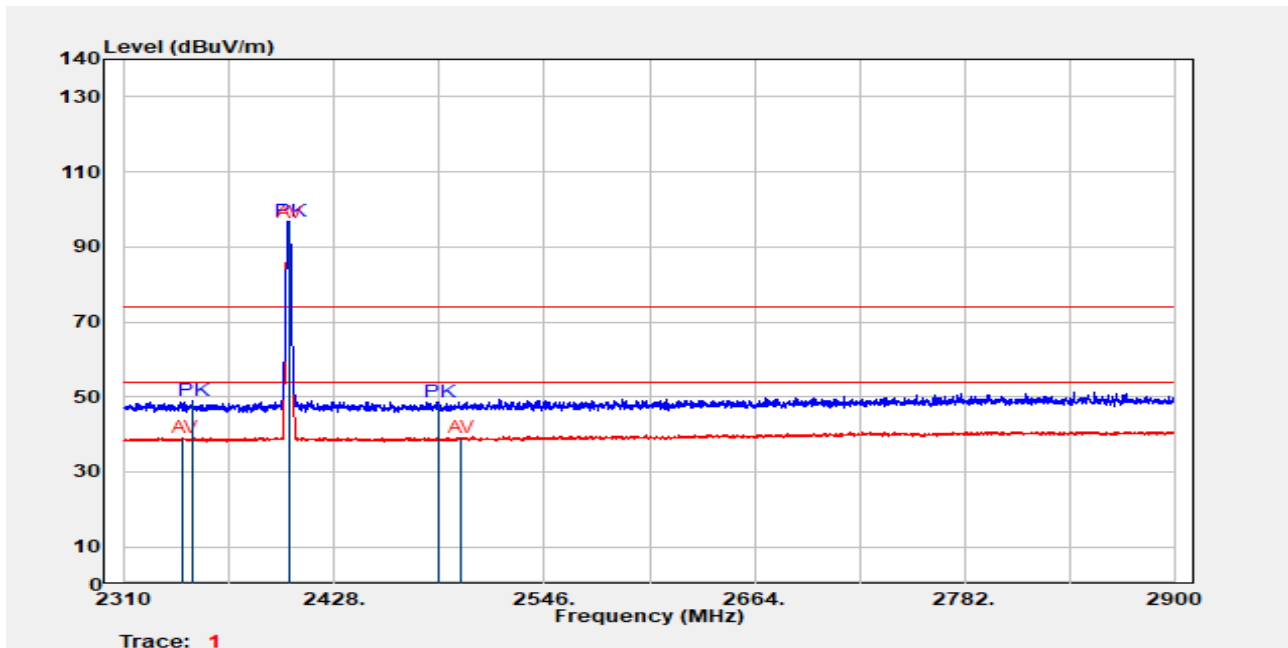

Freq. MHz	Detector Mode PK/QP/AV	Spectrum Reading Level dBuV	Factor dB	Actual FS dBuV/m	Limit @3m dBuV/m	Margin dB
2342.85	Average	43.51	-4.40	39.11	54.00	-14.89
2347.58	Peak	53.39	-4.40	48.99	74.00	-25.01
2402.00	Peak	101.21	-4.43	96.78	-	-
2402.00	Average	100.75	-4.43	96.32	-	-
2486.08	Peak	53.14	-4.50	48.64	74.00	-25.36
2498.47	Average	43.53	-4.41	39.12	54.00	-14.88

Unless otherwise stated the results shown in this test report refer only to the sample(s) tested and such sample(s) are retained for 90 days only.

除非另有說明，此報告結果僅對測試之樣品負責，同時此樣品僅保留90天。本報告未經本公司書面許可，不可部份複製。
 This document is issued by the Company subject to its General Conditions of Service printed overleaf, available on request or accessible at <http://www.sgs.com.tw/Terms-and-Conditions> and for electronic format documents, subject to Terms and Conditions for Electronic Documents at <http://www.sgs.com.tw/Terms-and-Conditions>. Attention is drawn to the limitation of liability, indemnification and jurisdiction issues defined therein. Any holder of this document is advised that information contained hereon reflects the Company's findings at the time of its intervention only and within the limits of Client's instructions, if any. The Company's sole responsibility is to its Client and this document does not exonerate parties to a transaction from exercising all their rights and obligations under the transaction documents. This document cannot be reproduced except in full, without prior written approval of the Company. Any unauthorized alteration, forgery or falsification of the content or appearance of this document is unlawful and offenders may be prosecuted to the fullest extent of the law.

Report Number :TERF2404001033ER
 Operation Mode :BLE 1M
 Test Frequency :2402 MHz
 Test Mode :Bandedge
 EUT Pol :E1 Plane

Test Site :SAC 2
 Test Date :2024-05-08
 Temp./Humi. :23.1°C/62%
 Antenna Pol. :Horizontal
 Engineer :Eason Wang

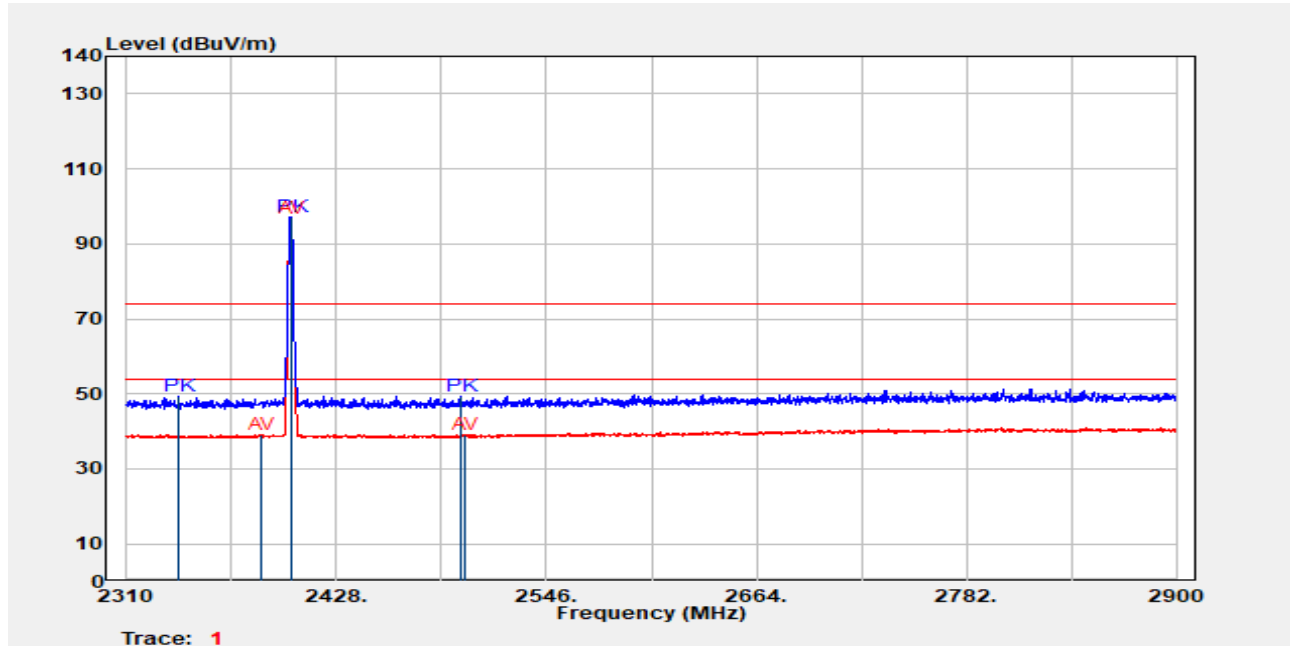

Freq. MHz	Detector Mode PK/QP/AV	Spectrum Reading Level dBμV	Factor dB	Actual FS dBμV/m	Limit @3m dBμV/m	Margin dB
2338.72	Peak	53.61	-4.40	49.21	74.00	-24.79
2385.55	Average	43.48	-4.32	39.16	54.00	-14.84
2402.00	Peak	101.50	-4.43	97.07	-	-
2402.00	Average	101.11	-4.43	96.68	-	-
2497.49	Peak	53.80	-4.42	49.38	74.00	-24.62
2499.65	Average	43.54	-4.39	39.15	54.00	-14.85

Unless otherwise stated the results shown in this test report refer only to the sample(s) tested and such sample(s) are retained for 90 days only.

除非另有說明，此報告結果僅對測試之樣品負責，同時此樣品僅保留90天。本報告未經本公司書面許可，不可部份複製。

This document is issued by the Company subject to its General Conditions of Service printed overleaf, available on request or accessible at <http://www.sgs.com.tw/Terms-and-Conditions> and for electronic format documents, subject to Terms and Conditions for Electronic Documents at <http://www.sgs.com.tw/Terms-and-Conditions>. Attention is drawn to the limitation of liability, indemnification and jurisdiction issues defined therein. Any holder of this document is advised that information contained hereon reflects the Company's findings at the time of its intervention only and within the limits of Client's instructions, if any. The Company's sole responsibility is to its Client and this document does not exonerate parties to a transaction from exercising all their rights and obligations under the transaction documents. This document cannot be reproduced except in full, without prior written approval of the Company. Any unauthorized alteration, forgery or falsification of the content or appearance of this document is unlawful and offenders may be prosecuted to the fullest extent of the law.

Report Number :TERF2404001033ER
 Operation Mode :BLE 1M
 Test Frequency :2480 MHz
 Test Mode :Bandedge
 EUT Pol :E1 Plane

Test Site :SAC 2
 Test Date :2024-05-08
 Temp./Humi. :23.1°C/62%
 Antenna Pol. :Vertical
 Engineer :Eason Wang

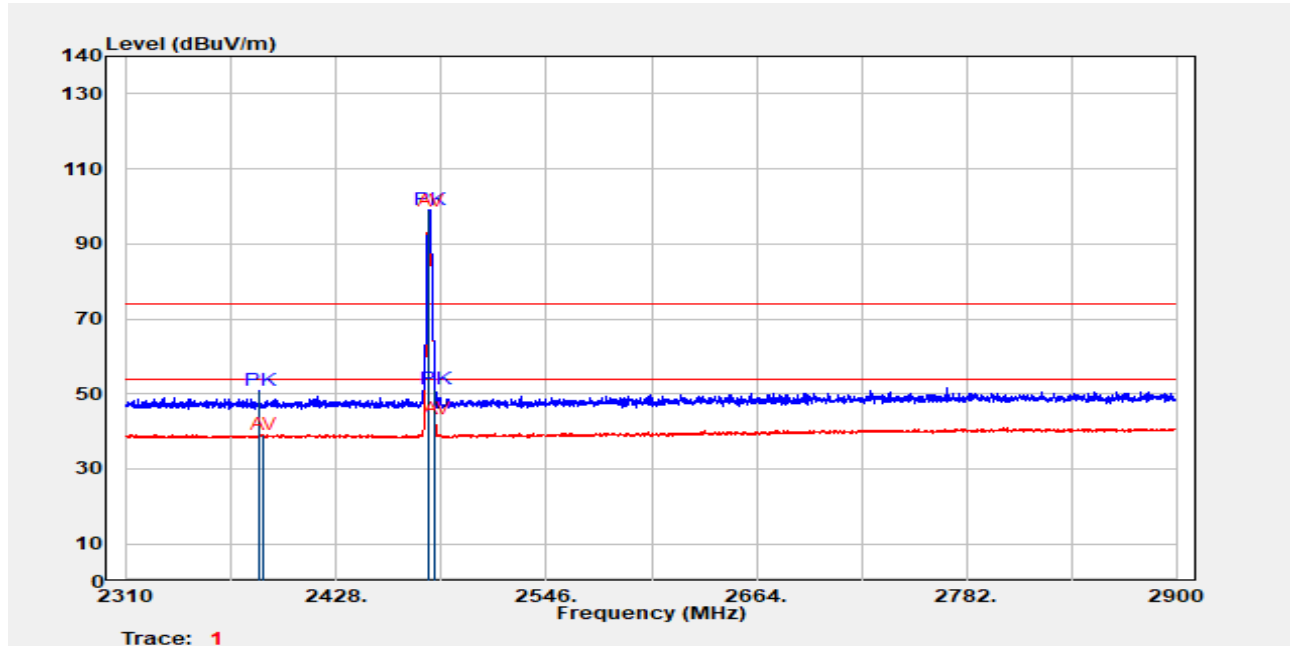

Freq. MHz	Detector Mode PK/QP/AV	Spectrum Reading Level dBμV	Factor dB	Actual FS dBμV/m	Limit @3m dBμV/m	Margin dB
2384.56	Peak	55.00	-4.32	50.68	74.00	-23.32
2386.73	Average	43.54	-4.32	39.22	54.00	-14.78
2480.00	Peak	103.54	-4.51	99.03	-	-
2480.00	Average	103.03	-4.51	98.52	-	-
2483.52	Peak	55.79	-4.50	51.29	74.00	-22.71
2483.52	Average	47.72	-4.50	43.22	54.00	-10.78

Unless otherwise stated the results shown in this test report refer only to the sample(s) tested and such sample(s) are retained for 90 days only.

除非另有說明，此報告結果僅對測試之樣品負責，同時此樣品僅保留90天。本報告未經本公司書面許可，不可部份複製。

This document is issued by the Company subject to its General Conditions of Service printed overleaf, available on request or accessible at <http://www.sgs.com.tw/Terms-and-Conditions> and for electronic format documents, subject to Terms and Conditions for Electronic Documents at <http://www.sgs.com.tw/Terms-and-Conditions>. Attention is drawn to the limitation of liability, indemnification and jurisdiction issues defined therein. Any holder of this document is advised that information contained hereon reflects the Company's findings at the time of its intervention only and within the limits of Client's instructions, if any. The Company's sole responsibility is to its Client and this document does not exonerate parties to a transaction from exercising all their rights and obligations under the transaction documents. This document cannot be reproduced except in full, without prior written approval of the Company. Any unauthorized alteration, forgery or falsification of the content or appearance of this document is unlawful and offenders may be prosecuted to the fullest extent of the law.

Report Number :TERF2404001033ER
 Operation Mode :BLE 1M
 Test Frequency :2480 MHz
 Test Mode :Bandedge
 EUT Pol :E1 Plane

Test Site :SAC 2
 Test Date :2024-05-08
 Temp./Humi. :23.1°C/62%
 Antenna Pol. :Horizontal
 Engineer :Eason Wang

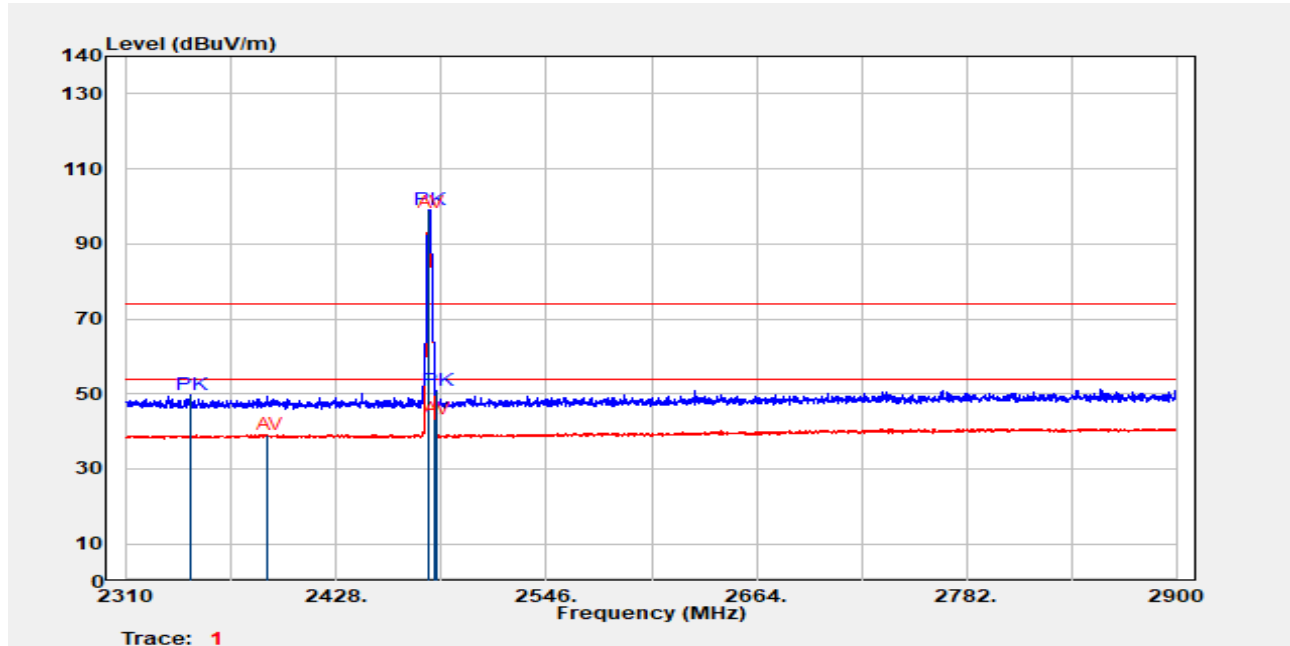

Freq. MHz	Detector Mode PK/QP/AV	Spectrum Reading Level dBμV	Factor dB	Actual FS dBμV/m	Limit @3m dBμV/m	Margin dB
2346.20	Peak	54.00	-4.40	49.60	74.00	-24.40
2389.28	Average	43.48	-4.32	39.16	54.00	-14.84
2480.00	Peak	103.43	-4.51	98.92	-	-
2480.00	Average	102.87	-4.51	98.36	-	-
2483.52	Average	47.61	-4.50	43.11	54.00	-10.89
2483.72	Peak	55.34	-4.50	50.84	74.00	-23.16

Unless otherwise stated the results shown in this test report refer only to the sample(s) tested and such sample(s) are retained for 90 days only.

除非另有說明，此報告結果僅對測試之樣品負責，同時此樣品僅保留90天。本報告未經本公司書面許可，不可部份複製。

This document is issued by the Company subject to its General Conditions of Service printed overleaf, available on request or accessible at <http://www.sgs.com.tw/Terms-and-Conditions> and for electronic format documents, subject to Terms and Conditions for Electronic Documents at <http://www.sgs.com.tw/Terms-and-Conditions>. Attention is drawn to the limitation of liability, indemnification and jurisdiction issues defined therein. Any holder of this document is advised that information contained hereon reflects the Company's findings at the time of its intervention only and within the limits of Client's instructions, if any. The Company's sole responsibility is to its Client and this document does not exonerate parties to a transaction from exercising all their rights and obligations under the transaction documents. This document cannot be reproduced except in full, without prior written approval of the Company. Any unauthorized alteration, forgery or falsification of the content or appearance of this document is unlawful and offenders may be prosecuted to the fullest extent of the law.

Report Number :TERF2404001033ER
 Operation Mode :BLE 2M
 Test Frequency :2402 MHz
 Test Mode :Bandedge
 EUT Pol :E1 Plane

Test Site :SAC 2
 Test Date :2024-05-08
 Temp./Humi. :23.1°C/62%
 Antenna Pol. :Vertical
 Engineer :Eason Wang

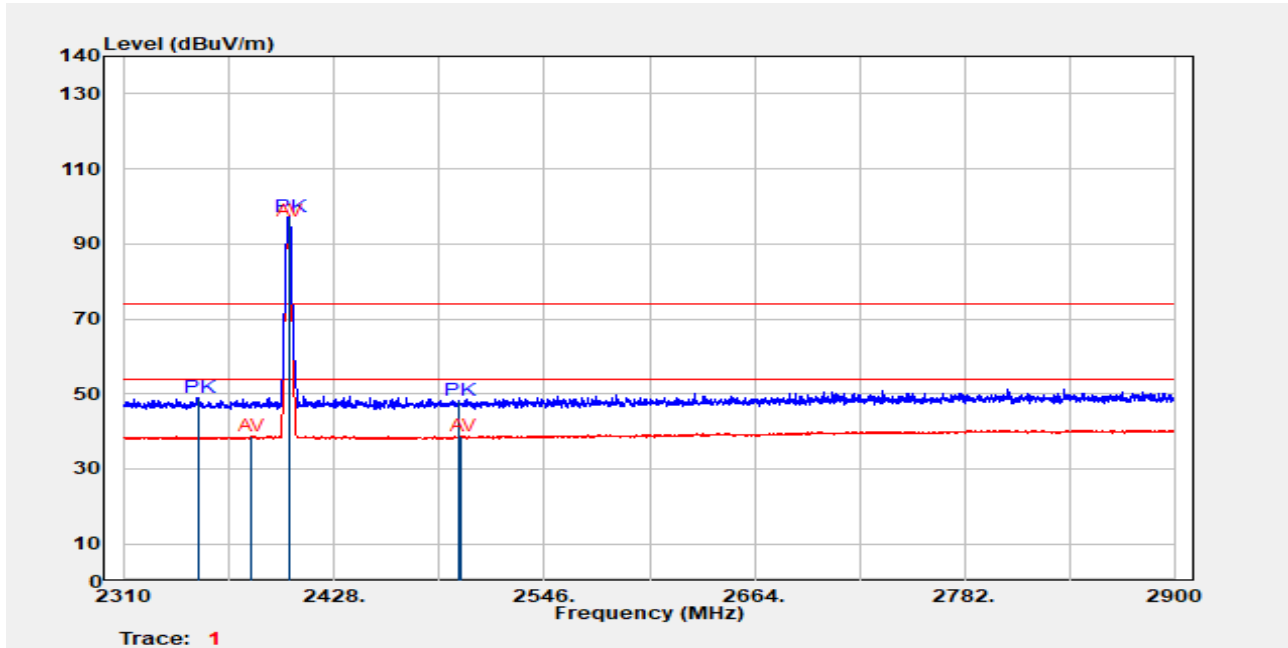

Freq. MHz	Detector Mode PK/QP/AV	Spectrum Reading Level dBμV	Factor dB	Actual FS dBμV/m	Limit @3m dBμV/m	Margin dB
2351.12	Peak	53.23	-4.40	48.83	74.00	-25.17
2380.43	Average	42.90	-4.32	38.58	54.00	-15.42
2402.00	Peak	101.64	-4.43	97.21	-	-
2402.00	Average	100.41	-4.43	95.98	-	-
2498.08	Peak	52.57	-4.41	48.16	74.00	-25.84
2499.26	Average	42.98	-4.40	38.58	54.00	-15.42

Unless otherwise stated the results shown in this test report refer only to the sample(s) tested and such sample(s) are retained for 90 days only.

除非另有說明，此報告結果僅對測試之樣品負責，同時此樣品僅保留90天。本報告未經本公司書面許可，不可部份複製。

This document is issued by the Company subject to its General Conditions of Service printed overleaf, available on request or accessible at <http://www.sgs.com.tw/Terms-and-Conditions> and for electronic format documents, subject to Terms and Conditions for Electronic Documents at <http://www.sgs.com.tw/Terms-and-Conditions>. Attention is drawn to the limitation of liability, indemnification and jurisdiction issues defined therein. Any holder of this document is advised that information contained hereon reflects the Company's findings at the time of its intervention only and within the limits of Client's instructions, if any. The Company's sole responsibility is to its Client and this document does not exonerate parties to a transaction from exercising all their rights and obligations under the transaction documents. This document cannot be reproduced except in full, without prior written approval of the Company. Any unauthorized alteration, forgery or falsification of the content or appearance of this document is unlawful and offenders may be prosecuted to the fullest extent of the law.

Report Number :TERF2404001033ER
 Operation Mode :BLE 2M
 Test Frequency :2402 MHz
 Test Mode :Bandedge
 EUT Pol :E1 Plane

Test Site :SAC 2
 Test Date :2024-05-08
 Temp./Humi. :23.1°C/62%
 Antenna Pol. :Horizontal
 Engineer :Eason Wang

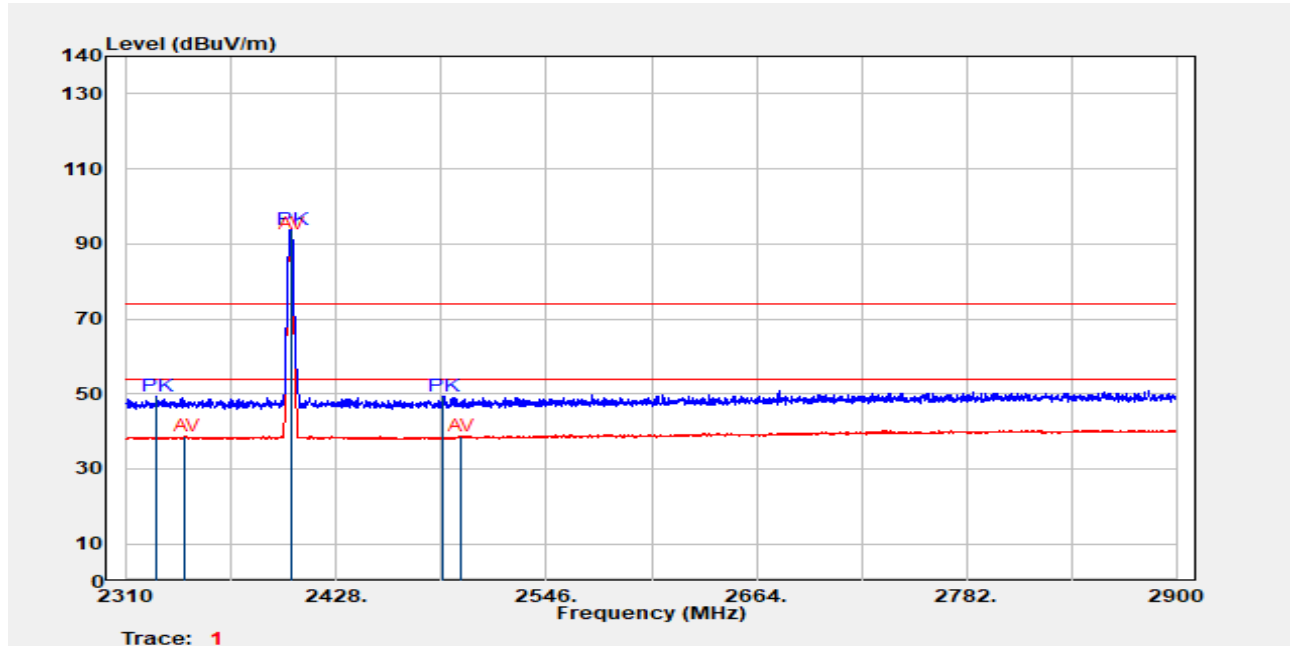

Freq. MHz	Detector Mode PK/QP/AV	Spectrum Reading Level dBμV	Factor dB	Actual FS dBμV/m	Limit @3m dBμV/m	Margin dB
2326.33	Peak	53.73	-4.41	49.32	74.00	-24.68
2342.85	Average	43.08	-4.40	38.68	54.00	-15.32
2402.00	Peak	98.18	-4.43	93.75	-	-
2402.00	Average	96.92	-4.43	92.49	-	-
2488.04	Peak	53.80	-4.50	49.30	74.00	-24.70
2497.29	Average	43.02	-4.42	38.60	54.00	-15.40

Unless otherwise stated the results shown in this test report refer only to the sample(s) tested and such sample(s) are retained for 90 days only.

除非另有說明，此報告結果僅對測試之樣品負責，同時此樣品僅保留90天。本報告未經本公司書面許可，不可部份複製。

This document is issued by the Company subject to its General Conditions of Service printed overleaf, available on request or accessible at <http://www.sgs.com.tw/Terms-and-Conditions> and for electronic format documents, subject to Terms and Conditions for Electronic Documents at <http://www.sgs.com.tw/Terms-and-Conditions>. Attention is drawn to the limitation of liability, indemnification and jurisdiction issues defined therein. Any holder of this document is advised that information contained hereon reflects the Company's findings at the time of its intervention only and within the limits of Client's instructions, if any. The Company's sole responsibility is to its Client and this document does not exonerate parties to a transaction from exercising all their rights and obligations under the transaction documents. This document cannot be reproduced except in full, without prior written approval of the Company. Any unauthorized alteration, forgery or falsification of the content or appearance of this document is unlawful and offenders may be prosecuted to the fullest extent of the law.

Report Number :TERF2404001033ER
 Operation Mode :BLE 2M
 Test Frequency :2480 MHz
 Test Mode :Bandedge
 EUT Pol :E1 Plane

Test Site :SAC 2
 Test Date :2024-05-08
 Temp./Humi. :23.1°C/62%
 Antenna Pol. :Vertical
 Engineer :Eason Wang

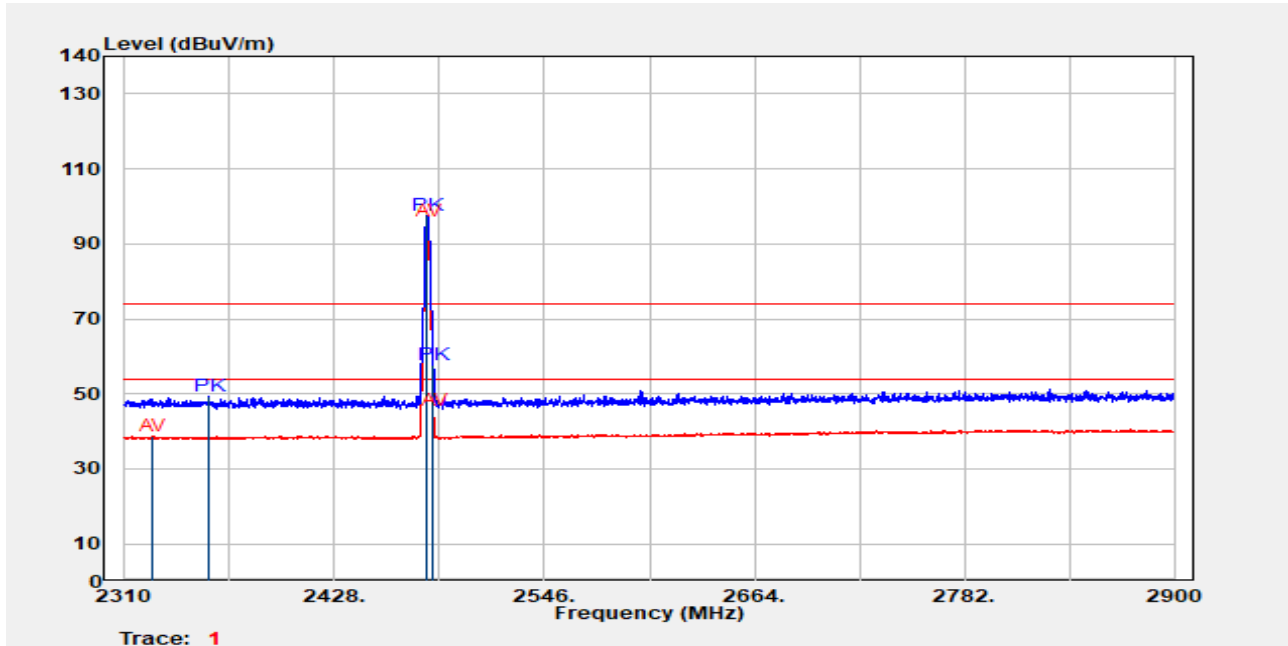

Freq. MHz	Detector Mode PK/QP/AV	Spectrum Reading Level dBμV	Factor dB	Actual FS dBμV/m	Limit @3m dBμV/m	Margin dB
2325.35	Average	43.07	-4.41	38.66	54.00	-15.34
2357.41	Peak	53.76	-4.40	49.36	74.00	-24.64
2480.00	Peak	101.90	-4.51	97.39	-	-
2480.00	Average	100.41	-4.51	95.90	-	-
2483.52	Peak	62.17	-4.50	57.67	74.00	-16.33
2483.52	Average	49.87	-4.50	45.37	54.00	-8.63

Unless otherwise stated the results shown in this test report refer only to the sample(s) tested and such sample(s) are retained for 90 days only.

除非另有說明，此報告結果僅對測試之樣品負責，同時此樣品僅保留90天。本報告未經本公司書面許可，不可部份複製。

This document is issued by the Company subject to its General Conditions of Service printed overleaf, available on request or accessible at <http://www.sgs.com.tw/Terms-and-Conditions> and for electronic format documents, subject to Terms and Conditions for Electronic Documents at <http://www.sgs.com.tw/Terms-and-Conditions>. Attention is drawn to the limitation of liability, indemnification and jurisdiction issues defined therein. Any holder of this document is advised that information contained hereon reflects the Company's findings at the time of its intervention only and within the limits of Client's instructions, if any. The Company's sole responsibility is to its Client and this document does not exonerate parties to a transaction from exercising all their rights and obligations under the transaction documents. This document cannot be reproduced except in full, without prior written approval of the Company. Any unauthorized alteration, forgery or falsification of the content or appearance of this document is unlawful and offenders may be prosecuted to the fullest extent of the law.

Report Number :TERF2404001033ER
 Operation Mode :BLE 2M
 Test Frequency :2480 MHz
 Test Mode :Bandedge
 EUT Pol :E1 Plane

Test Site :SAC 2
 Test Date :2024-05-08
 Temp./Humi. :23.1°C/62%
 Antenna Pol. :Horizontal
 Engineer :Eason Wang

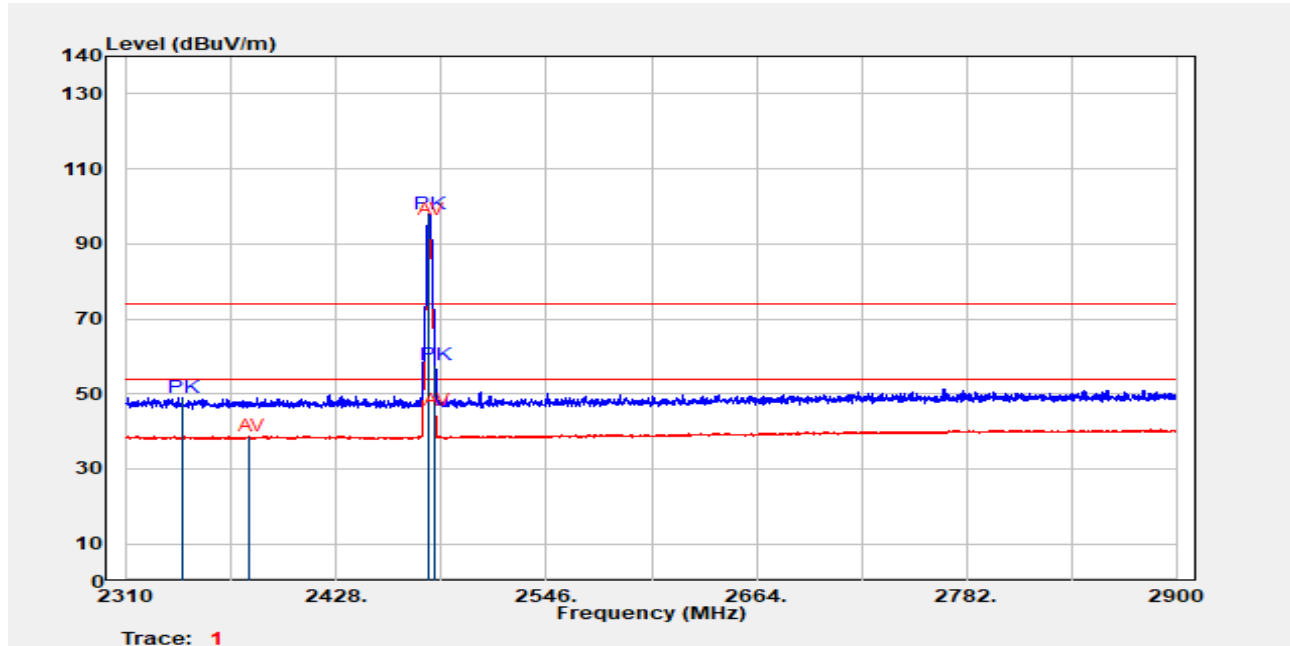

Freq. MHz	Detector Mode PK/QP/AV	Spectrum Reading Level dBμV	Factor dB	Actual FS dBμV/m	Limit @3m dBμV/m	Margin dB
2341.28	Peak	53.48	-4.40	49.08	74.00	-24.92
2379.25	Average	43.06	-4.33	38.73	54.00	-15.27
2480.00	Peak	102.25	-4.51	97.74	-	-
2480.00	Average	100.81	-4.51	96.30	-	-
2483.52	Peak	62.15	-4.50	57.65	74.00	-16.35
2483.52	Average	50.04	-4.50	45.54	54.00	-8.46

Unless otherwise stated the results shown in this test report refer only to the sample(s) tested and such sample(s) are retained for 90 days only.

除非另有說明，此報告結果僅對測試之樣品負責，同時此樣品僅保留90天。本報告未經本公司書面許可，不可部份複製。

This document is issued by the Company subject to its General Conditions of Service printed overleaf, available on request or accessible at <http://www.sgs.com.tw/Terms-and-Conditions> and for electronic format documents, subject to Terms and Conditions for Electronic Documents at <http://www.sgs.com.tw/Terms-and-Conditions>. Attention is drawn to the limitation of liability, indemnification and jurisdiction issues defined therein. Any holder of this document is advised that information contained hereon reflects the Company's findings at the time of its intervention only and within the limits of Client's instructions, if any. The Company's sole responsibility is to its Client and this document does not exonerate parties to a transaction from exercising all their rights and obligations under the transaction documents. This document cannot be reproduced except in full, without prior written approval of the Company. Any unauthorized alteration, forgery or falsification of the content or appearance of this document is unlawful and offenders may be prosecuted to the fullest extent of the law.

Report Number :TERF2404001033ER
 Operation Mode :BLE PHY=8
 Test Frequency :2402 MHz
 Test Mode :Bandedge
 EUT Pol :E1 Plane

Test Site :SAC 2
 Test Date :2024-05-08
 Temp./Humi. :23.1°C/62%
 Antenna Pol. :Vertical
 Engineer :Eason Wang

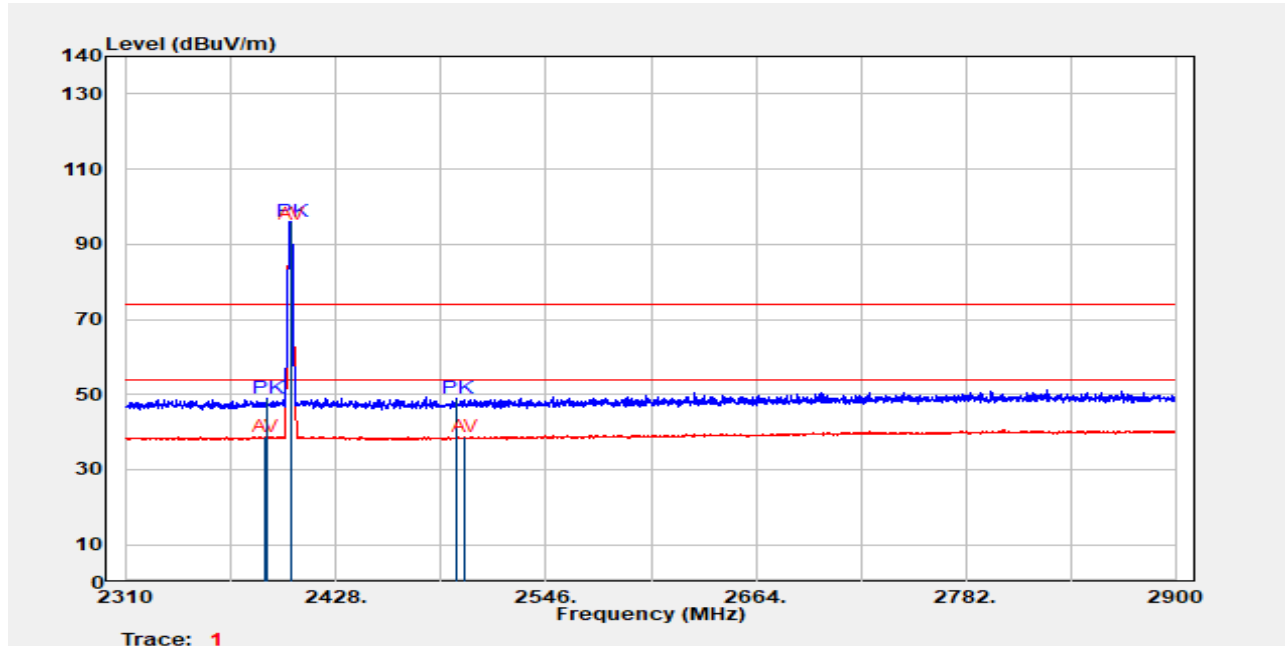

Freq. MHz	Detector Mode PK/QP/AV	Spectrum Reading Level dBμV	Factor dB	Actual FS dBμV/m	Limit @3m dBμV/m	Margin dB
2387.709	Average	42.94	-4.32	38.61	54.00	-15.39
2388.890	Peak	53.17	-4.32	48.84	74.00	-25.16
2402.000	Peak	100.37	-4.43	95.94	-	-
2402.000	Average	99.79	-4.43	95.37	-	-
2495.519	Peak	53.32	-4.44	48.88	74.00	-25.12
2500.043	Average	43.20	-4.39	38.81	54.00	-15.19

Unless otherwise stated the results shown in this test report refer only to the sample(s) tested and such sample(s) are retained for 90 days only.

除非另有說明，此報告結果僅對測試之樣品負責，同時此樣品僅保留90天。本報告未經本公司書面許可，不可部份複製。

This document is issued by the Company subject to its General Conditions of Service printed overleaf, available on request or accessible at <http://www.sgs.com.tw/Terms-and-Conditions> and for electronic format documents, subject to Terms and Conditions for Electronic Documents at <http://www.sgs.com.tw/Terms-and-Conditions>. Attention is drawn to the limitation of liability, indemnification and jurisdiction issues defined therein. Any holder of this document is advised that information contained hereon reflects the Company's findings at the time of its intervention only and within the limits of Client's instructions, if any. The Company's sole responsibility is to its Client and this document does not exonerate parties to a transaction from exercising all their rights and obligations under the transaction documents. This document cannot be reproduced except in full, without prior written approval of the Company. Any unauthorized alteration, forgery or falsification of the content or appearance of this document is unlawful and offenders may be prosecuted to the fullest extent of the law.

Report Number :TERF2404001033ER
 Operation Mode :BLE PHY=8
 Test Frequency :2402 MHz
 Test Mode :Bandedge
 EUT Pol :E1 Plane

Test Site :SAC 2
 Test Date :2024-05-08
 Temp./Humi. :23.1°C/62%
 Antenna Pol. :Horizontal
 Engineer :Eason Wang

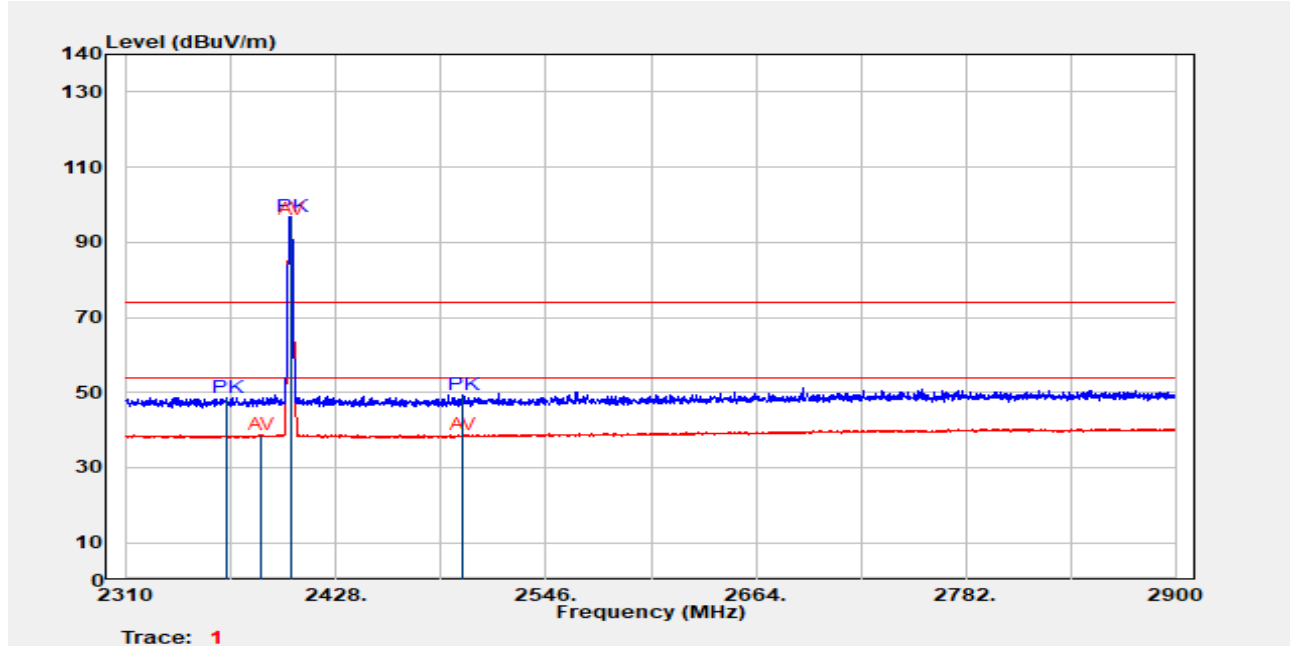

Freq. MHz	Detector Mode PK/QP/AV	Spectrum Reading Level dBμV	Factor dB	Actual FS dBμV/m	Limit @3m dBμV/m	Margin dB
2366.069	Peak	53.03	-4.41	48.62	74.00	-25.38
2385.348	Average	42.90	-4.32	38.58	54.00	-15.42
2402.000	Peak	101.10	-4.43	96.67	-	-
2402.000	Average	100.57	-4.43	96.14	-	-
2498.863	Average	43.06	-4.40	38.65	54.00	-15.35
2499.453	Peak	53.79	-4.40	49.40	74.00	-24.60

Unless otherwise stated the results shown in this test report refer only to the sample(s) tested and such sample(s) are retained for 90 days only.

除非另有說明，此報告結果僅對測試之樣品負責，同時此樣品僅保留90天。本報告未經本公司書面許可，不可部份複製。

This document is issued by the Company subject to its General Conditions of Service printed overleaf, available on request or accessible at <http://www.sgs.com.tw/Terms-and-Conditions> and for electronic format documents, subject to Terms and Conditions for Electronic Documents at <http://www.sgs.com.tw/Terms-and-Conditions>. Attention is drawn to the limitation of liability, indemnification and jurisdiction issues defined therein. Any holder of this document is advised that information contained hereon reflects the Company's findings at the time of its intervention only and within the limits of Client's instructions, if any. The Company's sole responsibility is to its Client and this document does not exonerate parties to a transaction from exercising all their rights and obligations under the transaction documents. This document cannot be reproduced except in full, without prior written approval of the Company. Any unauthorized alteration, forgery or falsification of the content or appearance of this document is unlawful and offenders may be prosecuted to the fullest extent of the law.

Report Number :TERF2404001033ER
 Operation Mode :BLE PHY=8
 Test Frequency :2480 MHz
 Test Mode :Bandedge
 EUT Pol :E1 Plane

Test Site :SAC 2
 Test Date :2024-05-08
 Temp./Humi. :23.1°C/62%
 Antenna Pol. :Vertical
 Engineer :Eason Wang

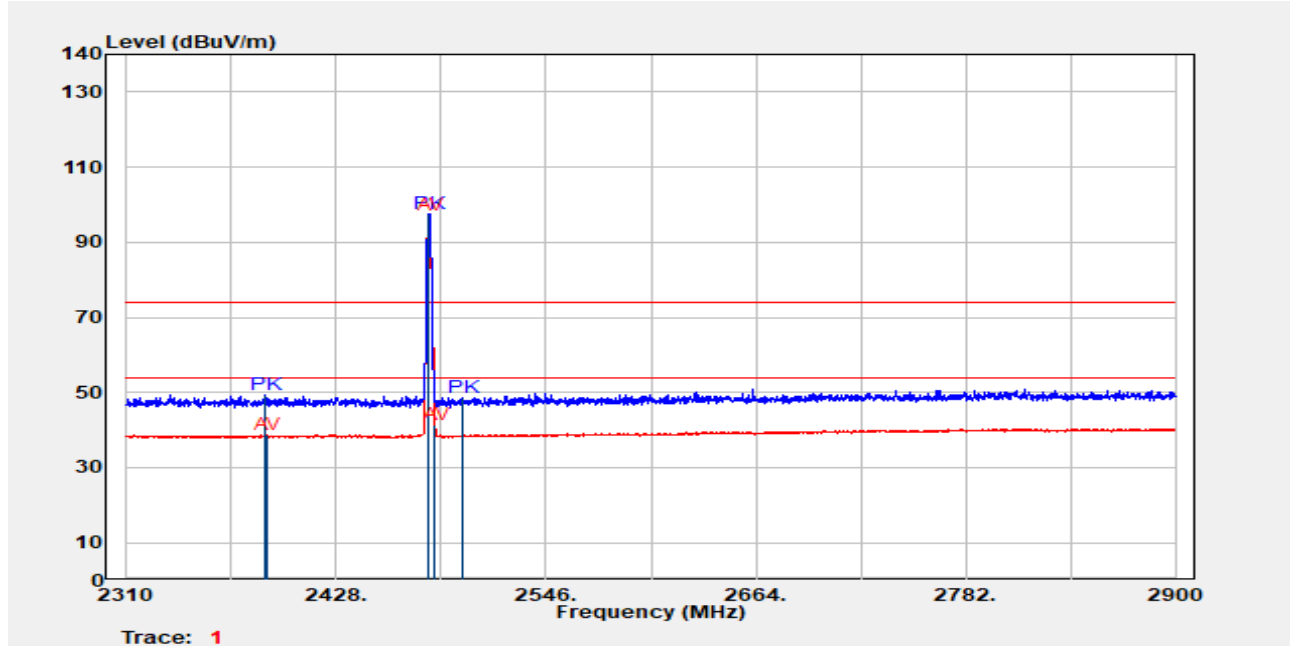

Freq. MHz	Detector Mode PK/QP/AV	Spectrum Reading Level dBμV	Factor dB	Actual FS dBμV/m	Limit @3m dBμV/m	Margin dB
2387.906	Peak	53.72	-4.32	49.40	74.00	-24.60
2388.890	Average	42.89	-4.32	38.57	54.00	-15.43
2480.000	Peak	102.20	-4.51	97.69	-	-
2480.000	Average	101.60	-4.51	97.10	-	-
2483.518	Average	46.01	-4.50	41.50	54.00	-12.50
2499.060	Peak	53.06	-4.40	48.66	74.00	-25.34

Unless otherwise stated the results shown in this test report refer only to the sample(s) tested and such sample(s) are retained for 90 days only.

除非另有說明，此報告結果僅對測試之樣品負責，同時此樣品僅保留90天。本報告未經本公司書面許可，不可部份複製。

This document is issued by the Company subject to its General Conditions of Service printed overleaf, available on request or accessible at <http://www.sgs.com.tw/Terms-and-Conditions> and for electronic format documents, subject to Terms and Conditions for Electronic Documents at <http://www.sgs.com.tw/Terms-and-Conditions>. Attention is drawn to the limitation of liability, indemnification and jurisdiction issues defined therein. Any holder of this document is advised that information contained hereon reflects the Company's findings at the time of its intervention only and within the limits of Client's instructions, if any. The Company's sole responsibility is to its Client and this document does not exonerate parties to a transaction from exercising all their rights and obligations under the transaction documents. This document cannot be reproduced except in full, without prior written approval of the Company. Any unauthorized alteration, forgery or falsification of the content or appearance of this document is unlawful and offenders may be prosecuted to the fullest extent of the law.

Report Number :TERF2404001033ER
 Operation Mode :BLE PHY=8
 Test Frequency :2480 MHz
 Test Mode :Bandedge
 EUT Pol :E1 Plane

Test Site :SAC 2
 Test Date :2024-05-08
 Temp./Humi. :23.1°C/62%
 Antenna Pol. :Horizontal
 Engineer :Eason Wang

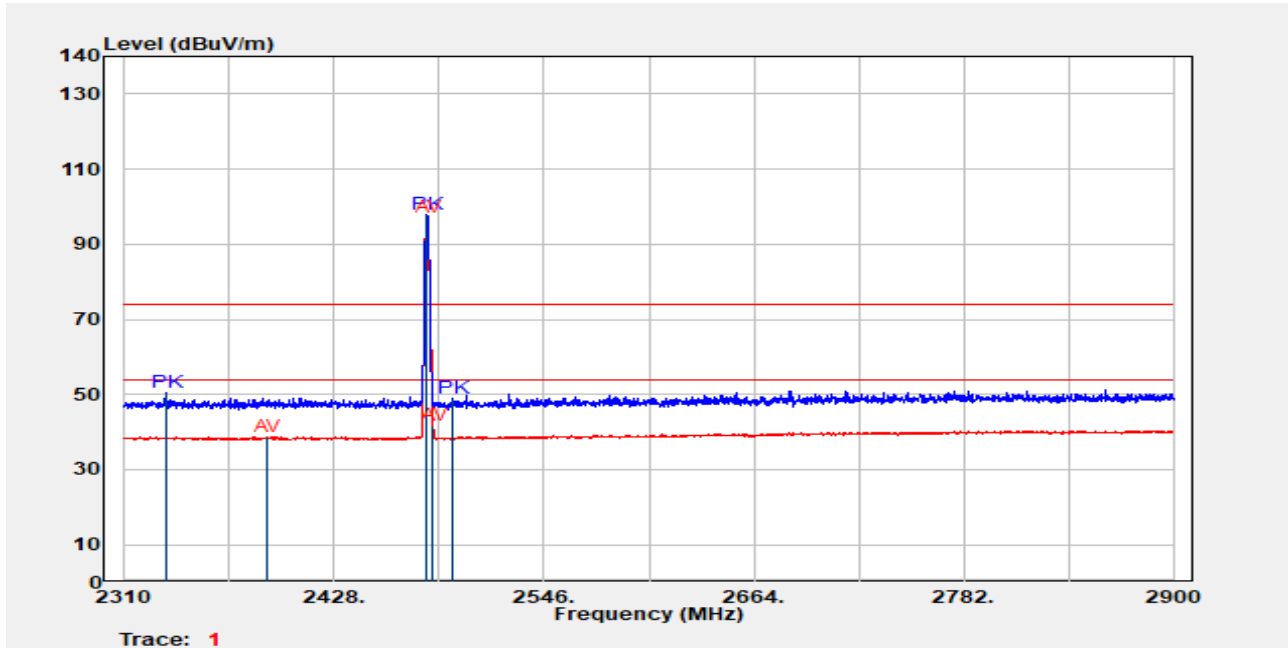

Freq. MHz	Detector Mode PK/QP/AV	Spectrum Reading Level dBμV	Factor dB	Actual FS dBμV/m	Limit @3m dBμV/m	Margin dB
2332.821	Peak	54.73	-4.40	50.33	74.00	-23.67
2389.677	Average	43.00	-4.32	38.67	54.00	-15.33
2480.000	Peak	102.25	-4.51	97.74	-	-
2480.000	Average	101.67	-4.51	97.16	-	-
2483.518	Average	46.09	-4.50	41.58	54.00	-12.42
2494.535	Peak	53.54	-4.45	49.09	74.00	-24.91

Unless otherwise stated the results shown in this test report refer only to the sample(s) tested and such sample(s) are retained for 90 days only.

除非另有說明，此報告結果僅對測試之樣品負責，同時此樣品僅保留90天。本報告未經本公司書面許可，不可部份複製。

This document is issued by the Company subject to its General Conditions of Service printed overleaf, available on request or accessible at <http://www.sgs.com.tw/Terms-and-Conditions> and for electronic format documents, subject to Terms and Conditions for Electronic Documents at <http://www.sgs.com.tw/Terms-and-Conditions>. Attention is drawn to the limitation of liability, indemnification and jurisdiction issues defined therein. Any holder of this document is advised that information contained hereon reflects the Company's findings at the time of its intervention only and within the limits of Client's instructions, if any. The Company's sole responsibility is to its Client and this document does not exonerate parties to a transaction from exercising all their rights and obligations under the transaction documents. This document cannot be reproduced except in full, without prior written approval of the Company. Any unauthorized alteration, forgery or falsification of the content or appearance of this document is unlawful and offenders may be prosecuted to the fullest extent of the law.

Report Number :TERF2404001033ER
 Operation Mode :BLE PHY=2
 Test Frequency :2402 MHz
 Test Mode :Bandedge
 EUT Pol :E1 Plane

Test Site :SAC 2
 Test Date :2024-05-08
 Temp./Humi. :23.1°C/62%
 Antenna Pol. :Vertical
 Engineer :Eason Wang

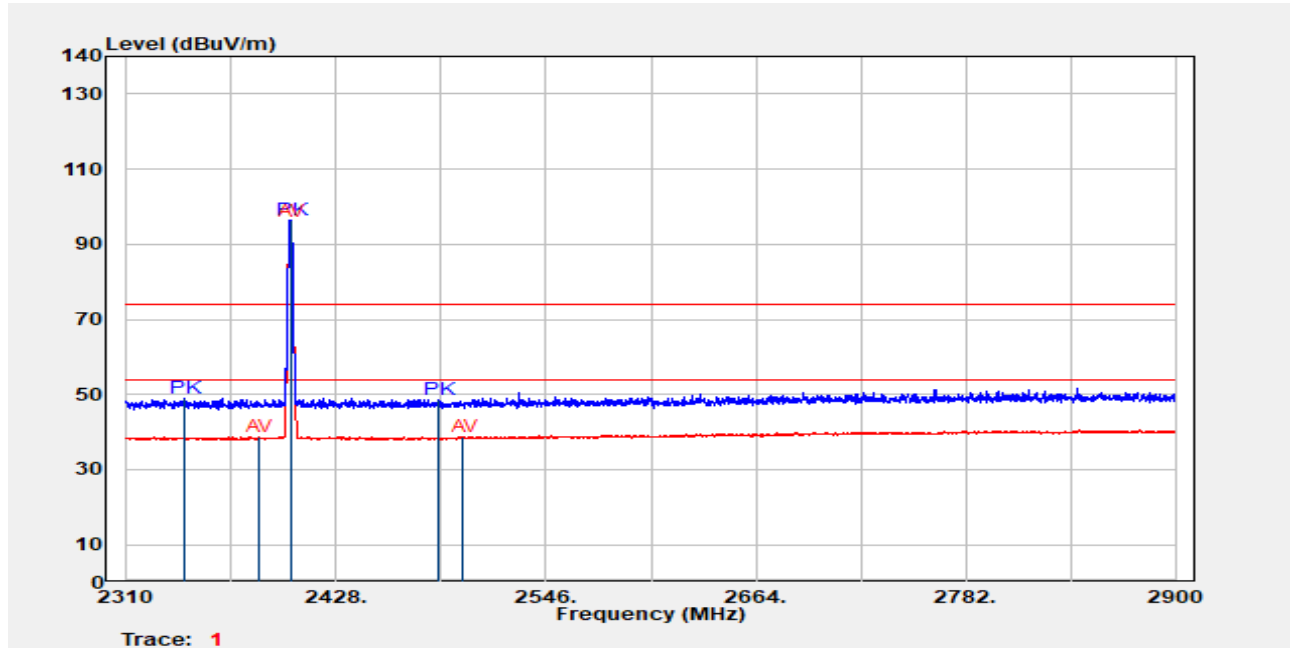

Freq. MHz	Detector Mode PK/QP/AV	Spectrum Reading Level dBμV	Factor dB	Actual FS dBμV/m	Limit @3m dBμV/m	Margin dB
2342.461	Peak	53.20	-4.40	48.80	74.00	-25.20
2384.365	Average	43.03	-4.32	38.70	54.00	-15.30
2402.000	Peak	100.64	-4.43	96.21	-	-
2402.000	Average	100.24	-4.43	95.81	-	-
2485.092	Peak	52.90	-4.50	48.40	74.00	-25.60
2499.256	Average	43.01	-4.40	38.61	54.00	-15.39

Unless otherwise stated the results shown in this test report refer only to the sample(s) tested and such sample(s) are retained for 90 days only.

除非另有說明，此報告結果僅對測試之樣品負責，同時此樣品僅保留90天。本報告未經本公司書面許可，不可部份複製。

This document is issued by the Company subject to its General Conditions of Service printed overleaf, available on request or accessible at <http://www.sgs.com.tw/Terms-and-Conditions> and for electronic format documents, subject to Terms and Conditions for Electronic Documents at <http://www.sgs.com.tw/Terms-and-Conditions>. Attention is drawn to the limitation of liability, indemnification and jurisdiction issues defined therein. Any holder of this document is advised that information contained hereon reflects the Company's findings at the time of its intervention only and within the limits of Client's instructions, if any. The Company's sole responsibility is to its Client and this document does not exonerate parties to a transaction from exercising all their rights and obligations under the transaction documents. This document cannot be reproduced except in full, without prior written approval of the Company. Any unauthorized alteration, forgery or falsification of the content or appearance of this document is unlawful and offenders may be prosecuted to the fullest extent of the law.

Report Number :TERF2404001033ER
 Operation Mode :BLE PHY=2
 Test Frequency :2402 MHz
 Test Mode :Bandedge
 EUT Pol :E1 Plane

Test Site :SAC 2
 Test Date :2024-05-08
 Temp./Humi. :23.1°C/62%
 Antenna Pol. :Horizontal
 Engineer :Eason Wang

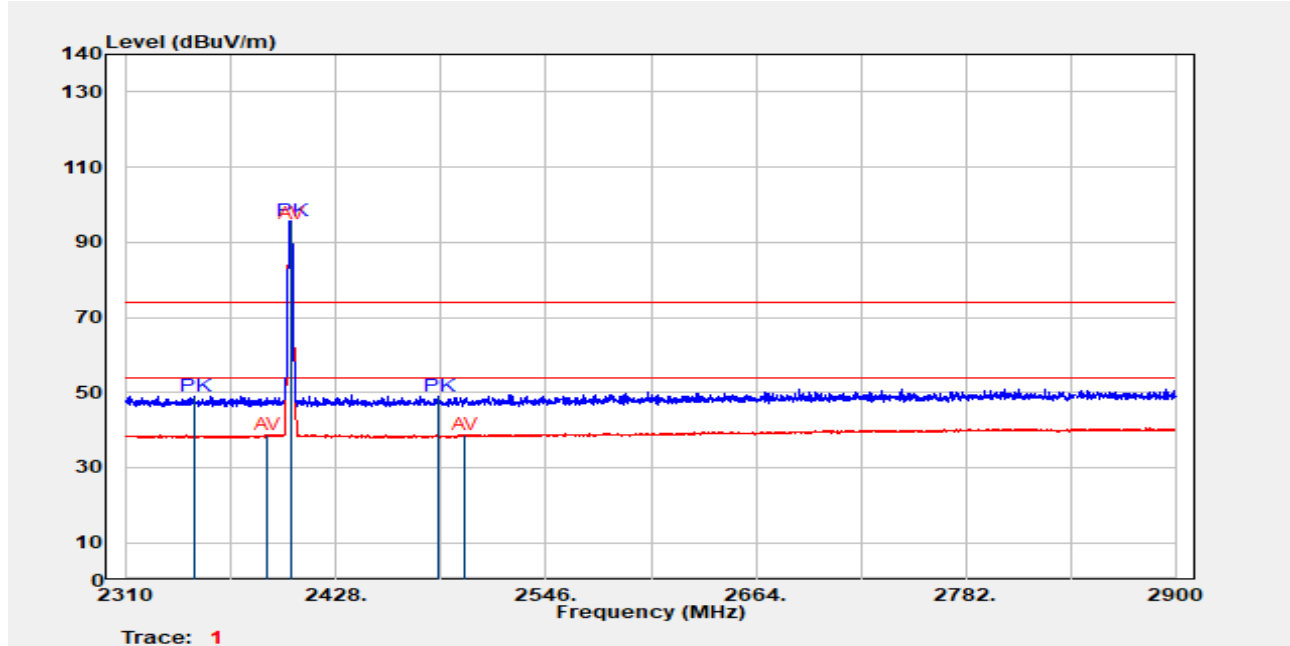

Freq. MHz	Detector Mode PK/QP/AV	Spectrum Reading Level dBμV	Factor dB	Actual FS dBμV/m	Limit @3m dBμV/m	Margin dB
2348.363	Peak	53.38	-4.40	48.98	74.00	-25.02
2389.086	Average	43.00	-4.32	38.68	54.00	-15.32
2402.000	Peak	99.91	-4.43	95.49	-	-
2402.000	Average	99.46	-4.43	95.04	-	-
2485.092	Peak	53.34	-4.50	48.84	74.00	-25.16
2499.847	Average	43.19	-4.39	38.80	54.00	-15.20

Unless otherwise stated the results shown in this test report refer only to the sample(s) tested and such sample(s) are retained for 90 days only.

除非另有說明，此報告結果僅對測試之樣品負責，同時此樣品僅保留90天。本報告未經本公司書面許可，不可部份複製。

This document is issued by the Company subject to its General Conditions of Service printed overleaf, available on request or accessible at <http://www.sgs.com.tw/Terms-and-Conditions> and for electronic format documents, subject to Terms and Conditions for Electronic Documents at <http://www.sgs.com.tw/Terms-and-Conditions>. Attention is drawn to the limitation of liability, indemnification and jurisdiction issues defined therein. Any holder of this document is advised that information contained hereon reflects the Company's findings at the time of its intervention only and within the limits of Client's instructions, if any. The Company's sole responsibility is to its Client and this document does not exonerate parties to a transaction from exercising all their rights and obligations under the transaction documents. This document cannot be reproduced except in full, without prior written approval of the Company. Any unauthorized alteration, forgery or falsification of the content or appearance of this document is unlawful and offenders may be prosecuted to the fullest extent of the law.

Report Number :TERF2404001033ER
 Operation Mode :BLE PHY=2
 Test Frequency :2480 MHz
 Test Mode :Bandedge
 EUT Pol :E1 Plane

Test Site :SAC 2
 Test Date :2024-05-08
 Temp./Humi. :23.1°C/62%
 Antenna Pol. :Vertical
 Engineer :Eason Wang

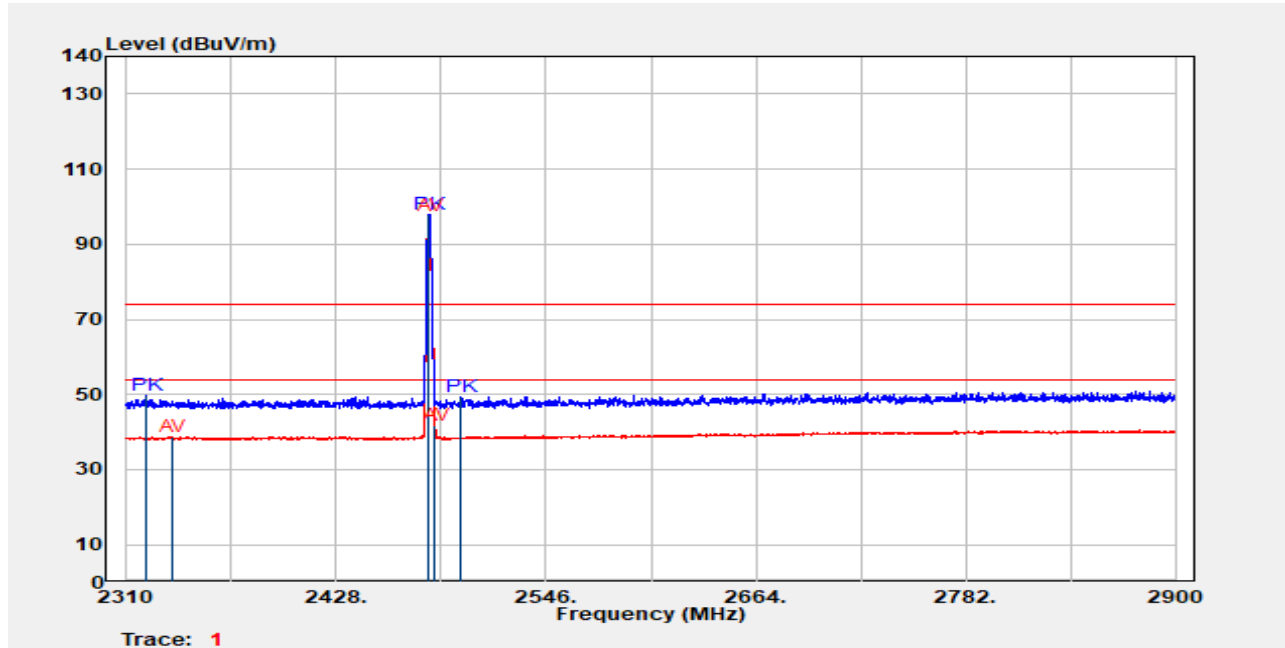

Freq. MHz	Detector Mode PK/QP/AV	Spectrum Reading Level dBμV	Factor dB	Actual FS dBμV/m	Limit @3m dBμV/m	Margin dB
2320.820	Peak	54.00	-4.41	49.60	74.00	-24.40
2335.182	Average	43.03	-4.40	38.63	54.00	-15.37
2480.000	Peak	102.37	-4.51	97.87	-	-
2480.000	Average	101.88	-4.51	97.37	-	-
2483.518	Average	46.08	-4.50	41.58	54.00	-12.42
2498.273	Peak	53.62	-4.41	49.21	74.00	-24.79

Unless otherwise stated the results shown in this test report refer only to the sample(s) tested and such sample(s) are retained for 90 days only.

除非另有說明，此報告結果僅對測試之樣品負責，同時此樣品僅保留90天。本報告未經本公司書面許可，不可部份複製。

This document is issued by the Company subject to its General Conditions of Service printed overleaf, available on request or accessible at <http://www.sgs.com.tw/Terms-and-Conditions> and for electronic format documents, subject to Terms and Conditions for Electronic Documents at <http://www.sgs.com.tw/Terms-and-Conditions>. Attention is drawn to the limitation of liability, indemnification and jurisdiction issues defined therein. Any holder of this document is advised that information contained hereon reflects the Company's findings at the time of its intervention only and within the limits of Client's instructions, if any. The Company's sole responsibility is to its Client and this document does not exonerate parties to a transaction from exercising all their rights and obligations under the transaction documents. This document cannot be reproduced except in full, without prior written approval of the Company. Any unauthorized alteration, forgery or falsification of the content or appearance of this document is unlawful and offenders may be prosecuted to the fullest extent of the law.

Report Number :TERF2404001033ER
 Operation Mode :BLE PHY=2
 Test Frequency :2480 MHz
 Test Mode :Bandedge
 EUT Pol :E1 Plane

Test Site :SAC 2
 Test Date :2024-05-08
 Temp./Humi. :23.1°C/62%
 Antenna Pol. :Horizontal
 Engineer :Eason Wang

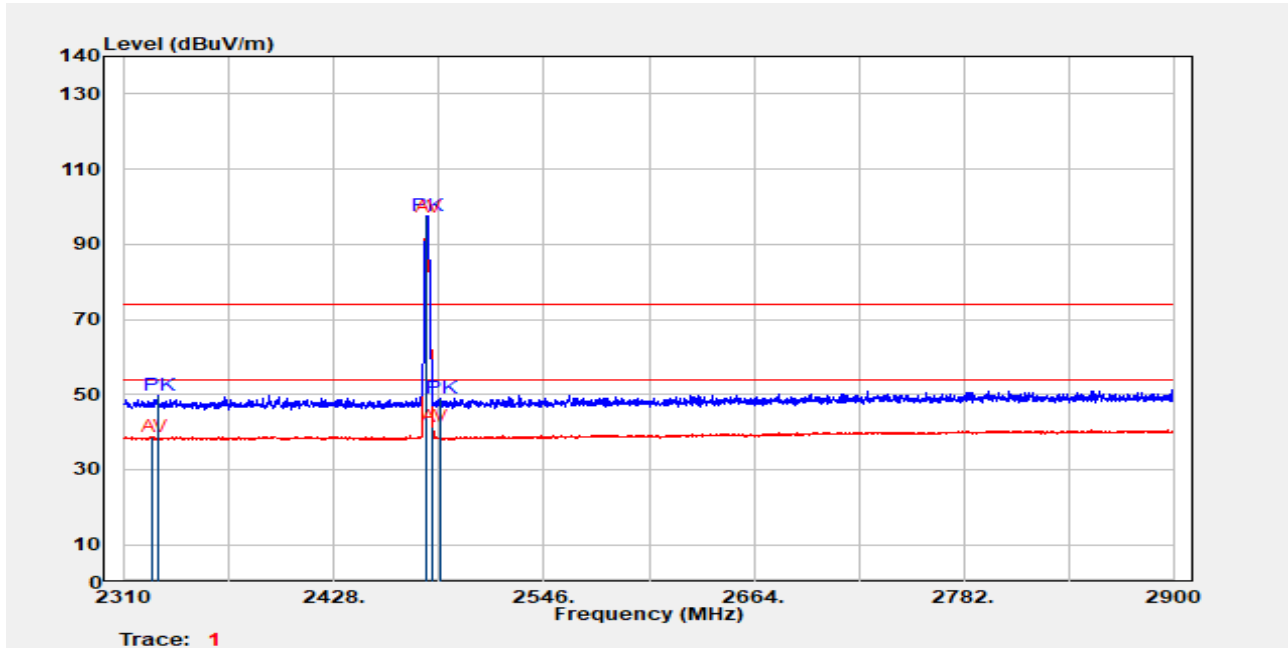

Freq. MHz	Detector Mode PK/QP/AV	Spectrum Reading Level dBμV	Factor dB	Actual FS dBμV/m	Limit @3m dBμV/m	Margin dB
2325.935	Average	43.08	-4.40	38.68	54.00	-15.32
2329.083	Peak	53.98	-4.40	49.58	74.00	-24.42
2480.000	Peak	102.12	-4.51	97.62	-	-
2480.000	Average	101.67	-4.51	97.16	-	-
2483.518	Average	45.85	-4.50	41.34	54.00	-12.66
2487.256	Peak	53.62	-4.50	49.12	74.00	-24.88

Unless otherwise stated the results shown in this test report refer only to the sample(s) tested and such sample(s) are retained for 90 days only.

除非另有說明，此報告結果僅對測試之樣品負責，同時此樣品僅保留90天。本報告未經本公司書面許可，不可部份複製。

This document is issued by the Company subject to its General Conditions of Service printed overleaf, available on request or accessible at <http://www.sgs.com.tw/Terms-and-Conditions> and for electronic format documents, subject to Terms and Conditions for Electronic Documents at <http://www.sgs.com.tw/Terms-and-Conditions>. Attention is drawn to the limitation of liability, indemnification and jurisdiction issues defined therein. Any holder of this document is advised that information contained hereon reflects the Company's findings at the time of its intervention only and within the limits of Client's instructions, if any. The Company's sole responsibility is to its Client and this document does not exonerate parties to a transaction from exercising all their rights and obligations under the transaction documents. This document cannot be reproduced except in full, without prior written approval of the Company. Any unauthorized alteration, forgery or falsification of the content or appearance of this document is unlawful and offenders may be prosecuted to the fullest extent of the law.

Mode: ANT8

Report Number :TERF2404001033ER
 Operation Mode :BLE 1M
 Test Frequency :2402 MHz
 Test Mode :Bandedge
 EUT Pol :E1 Plane

Test Site :SAC 2
 Test Date :2024-05-07
 Temp./Humi. :24.3°C/59%
 Antenna Pol. :Vertical
 Engineer :Eason Wang

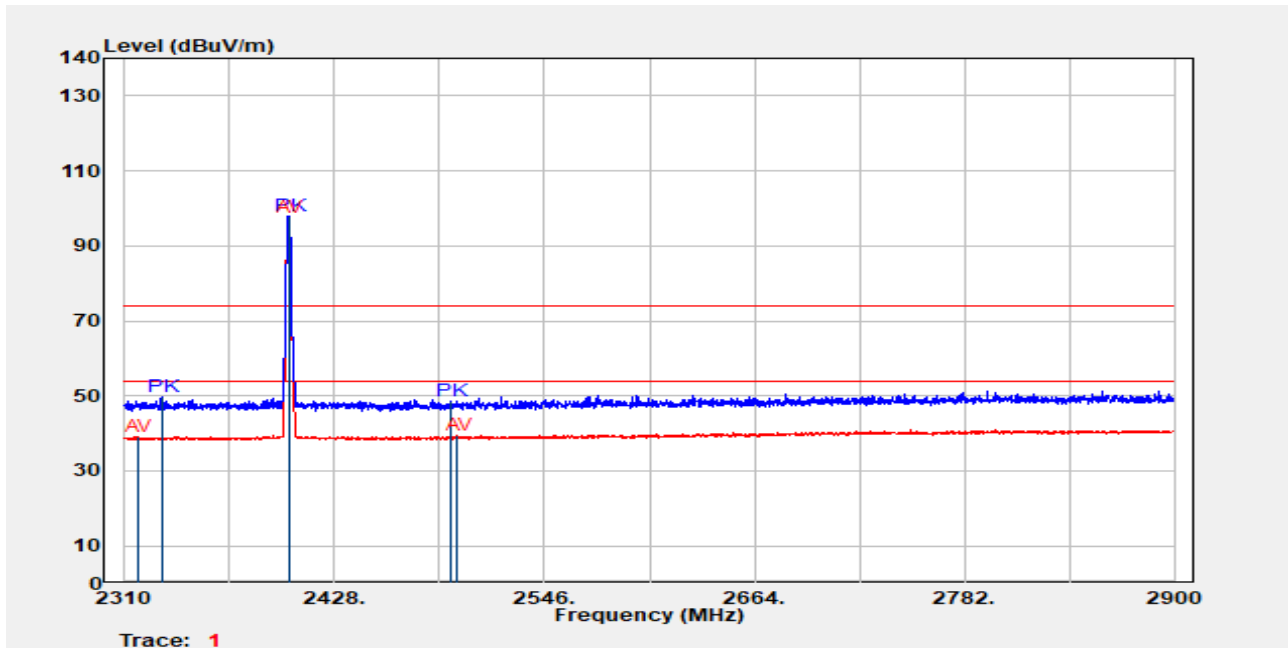

Freq. MHz	Detector Mode PK/QP/AV	Spectrum Reading Level dBμV	Factor dB	Actual FS dBμV/m	Limit @3m dBμV/m	Margin dB
2317.28	Average	43.40	-4.37	39.03	54.00	-14.97
2330.66	Peak	54.22	-4.40	49.82	74.00	-24.18
2402.00	Peak	102.27	-4.43	97.84	-	-
2402.00	Average	101.93	-4.43	97.50	-	-
2492.76	Peak	53.10	-4.47	48.63	74.00	-25.37
2497.09	Average	43.69	-4.42	39.27	54.00	-14.73

Unless otherwise stated the results shown in this test report refer only to the sample(s) tested and such sample(s) are retained for 90 days only.

除非另有說明，此報告結果僅對測試之樣品負責，同時此樣品僅保留90天。本報告未經本公司書面許可，不可部份複製。

This document is issued by the Company subject to its General Conditions of Service printed overleaf, available on request or accessible at <http://www.sgs.com.tw/Terms-and-Conditions> and for electronic format documents, subject to Terms and Conditions for Electronic Documents at <http://www.sgs.com.tw/Terms-and-Conditions>. Attention is drawn to the limitation of liability, indemnification and jurisdiction issues defined therein. Any holder of this document is advised that information contained hereon reflects the Company's findings at the time of its intervention only and within the limits of Client's instructions, if any. The Company's sole responsibility is to its Client and this document does not exonerate parties to a transaction from exercising all their rights and obligations under the transaction documents. This document cannot be reproduced except in full, without prior written approval of the Company. Any unauthorized alteration, forgery or falsification of the content or appearance of this document is unlawful and offenders may be prosecuted to the fullest extent of the law.

Report Number :TERF2404001033ER
 Operation Mode :BLE 1M
 Test Frequency :2402 MHz
 Test Mode :Bandedge
 EUT Pol :E1 Plane

Test Site :SAC 2
 Test Date :2024-05-07
 Temp./Humi. :24.3°C/59%
 Antenna Pol. :Horizontal
 Engineer :Eason Wang

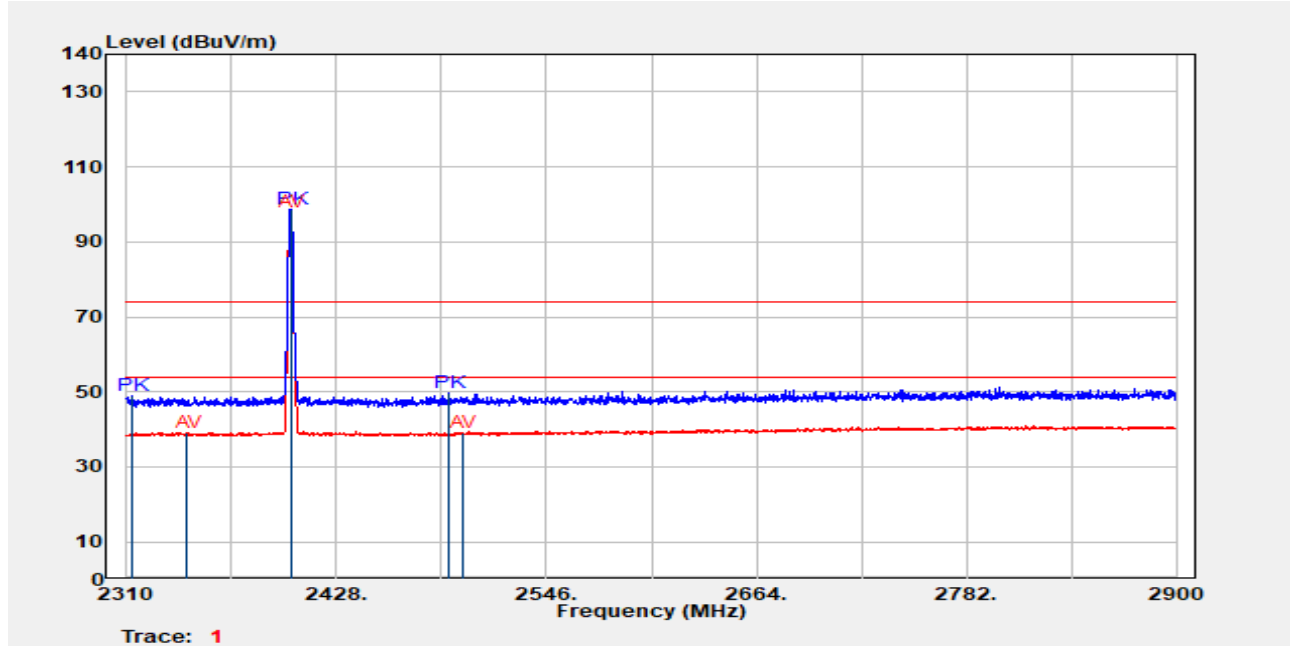

Freq. MHz	Detector Mode PK/QP/AV	Spectrum Reading Level dBμV	Factor dB	Actual FS dBμV/m	Limit @3m dBμV/m	Margin dB
2313.34	Peak	53.18	-4.34	48.84	74.00	-25.16
2344.04	Average	43.54	-4.40	39.14	54.00	-14.86
2402.00	Peak	102.90	-4.43	98.47	-	-
2402.00	Average	102.48	-4.43	98.05	-	-
2490.80	Peak	54.09	-4.49	49.60	74.00	-24.40
2498.47	Average	43.60	-4.41	39.19	54.00	-14.81

Unless otherwise stated the results shown in this test report refer only to the sample(s) tested and such sample(s) are retained for 90 days only.

除非另有說明，此報告結果僅對測試之樣品負責，同時此樣品僅保留90天。本報告未經本公司書面許可，不可部份複製。

This document is issued by the Company subject to its General Conditions of Service printed overleaf, available on request or accessible at <http://www.sgs.com.tw/Terms-and-Conditions> and for electronic format documents, subject to Terms and Conditions for Electronic Documents at <http://www.sgs.com.tw/Terms-and-Conditions>. Attention is drawn to the limitation of liability, indemnification and jurisdiction issues defined therein. Any holder of this document is advised that information contained hereon reflects the Company's findings at the time of its intervention only and within the limits of Client's instructions, if any. The Company's sole responsibility is to its Client and this document does not exonerate parties to a transaction from exercising all their rights and obligations under the transaction documents. This document cannot be reproduced except in full, without prior written approval of the Company. Any unauthorized alteration, forgery or falsification of the content or appearance of this document is unlawful and offenders may be prosecuted to the fullest extent of the law.

Report Number :TERF2404001033ER
 Operation Mode :BLE 1M
 Test Frequency :2480 MHz
 Test Mode :Bandedge
 EUT Pol :E1 Plane

Test Site :SAC 2
 Test Date :2024-05-07
 Temp./Humi. :24.3°C/59%
 Antenna Pol. :Vertical
 Engineer :Eason Wang

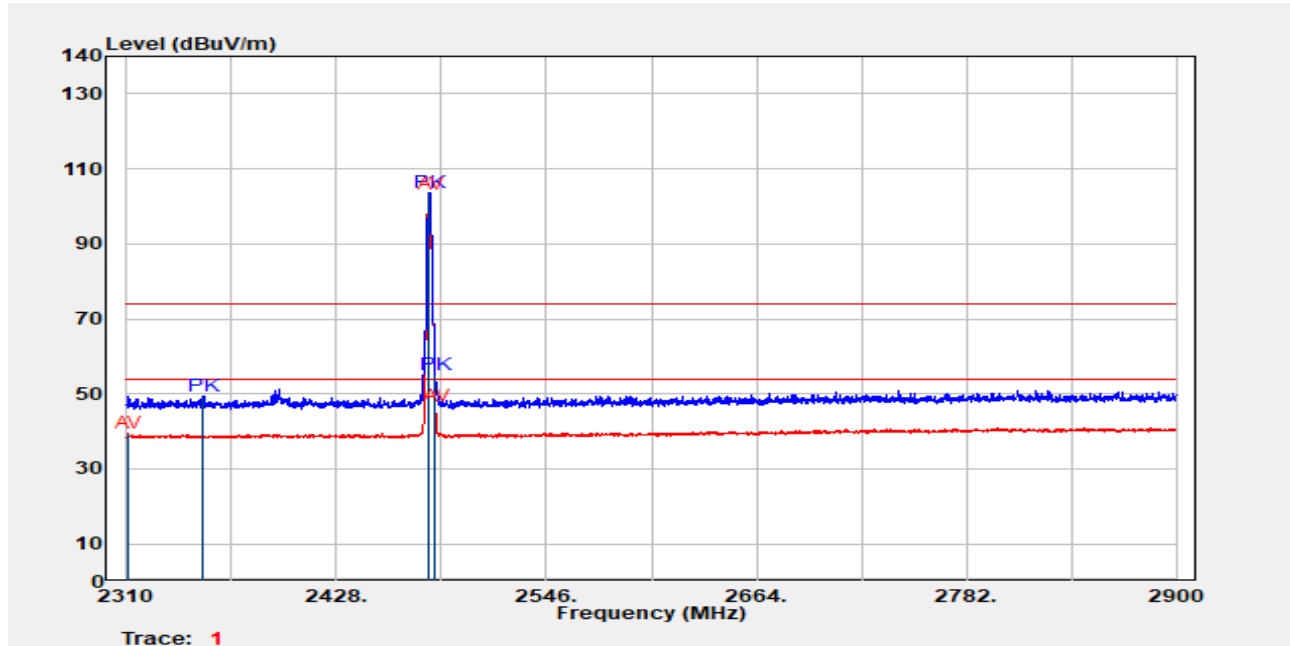

Freq. MHz	Detector Mode PK/QP/AV	Spectrum Reading Level dBμV	Factor dB	Actual FS dBμV/m	Limit @3m dBμV/m	Margin dB
2310.79	Average	43.70	-4.32	39.38	54.00	-14.62
2353.08	Peak	53.88	-4.40	49.48	74.00	-24.52
2480.00	Peak	108.15	-4.51	103.64	-	-
2480.00	Average	107.73	-4.51	103.22	-	-
2483.52	Peak	59.48	-4.50	54.98	74.00	-19.02
2483.52	Average	51.29	-4.50	46.79	54.00	-7.21

Unless otherwise stated the results shown in this test report refer only to the sample(s) tested and such sample(s) are retained for 90 days only.

除非另有說明，此報告結果僅對測試之樣品負責，同時此樣品僅保留90天。本報告未經本公司書面許可，不可部份複製。
 This document is issued by the Company subject to its General Conditions of Service printed overleaf, available on request or accessible at <http://www.sgs.com.tw/Terms-and-Conditions> and for electronic format documents, subject to Terms and Conditions for Electronic Documents at <http://www.sgs.com.tw/Terms-and-Conditions>. Attention is drawn to the limitation of liability, indemnification and jurisdiction issues defined therein. Any holder of this document is advised that information contained hereon reflects the Company's findings at the time of its intervention only and within the limits of Client's instructions, if any. The Company's sole responsibility is to its Client and this document does not exonerate parties to a transaction from exercising all their rights and obligations under the transaction documents. This document cannot be reproduced except in full, without prior written approval of the Company. Any unauthorized alteration, forgery or falsification of the content or appearance of this document is unlawful and offenders may be prosecuted to the fullest extent of the law.

Report Number :TERF2404001033ER
 Operation Mode :BLE 1M
 Test Frequency :2480 MHz
 Test Mode :Bandedge
 EUT Pol :E1 Plane

Test Site :SAC 2
 Test Date :2024-05-07
 Temp./Humi. :24.3°C/59%
 Antenna Pol. :Horizontal
 Engineer :Eason Wang

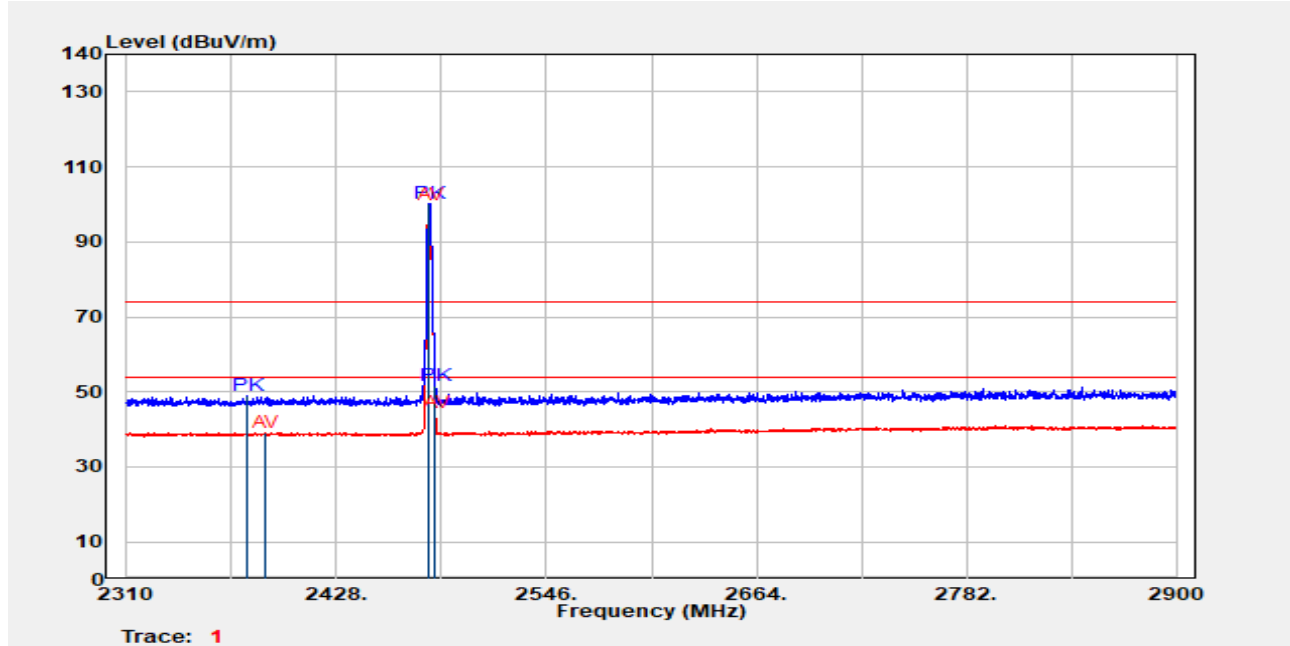

Freq. MHz	Detector Mode PK/QP/AV	Spectrum Reading Level dBμV	Factor dB	Actual FS dBμV/m	Limit @3m dBμV/m	Margin dB
2377.48	Peak	53.18	-4.35	48.83	74.00	-25.17
2387.32	Average	43.38	-4.32	39.06	54.00	-14.94
2480.00	Peak	104.74	-4.51	100.23	-	-
2480.00	Average	104.37	-4.51	99.86	-	-
2483.52	Peak	56.28	-4.50	51.78	74.00	-22.22
2483.52	Average	48.71	-4.50	44.21	54.00	-9.79

Unless otherwise stated the results shown in this test report refer only to the sample(s) tested and such sample(s) are retained for 90 days only.

除非另有說明，此報告結果僅對測試之樣品負責，同時此樣品僅保留90天。本報告未經本公司書面許可，不可部份複製。
 This document is issued by the Company subject to its General Conditions of Service printed overleaf, available on request or accessible at <http://www.sgs.com.tw/Terms-and-Conditions> and for electronic format documents, subject to Terms and Conditions for Electronic Documents at <http://www.sgs.com.tw/Terms-and-Conditions>. Attention is drawn to the limitation of liability, indemnification and jurisdiction issues defined therein. Any holder of this document is advised that information contained hereon reflects the Company's findings at the time of its intervention only and within the limits of Client's instructions, if any. The Company's sole responsibility is to its Client and this document does not exonerate parties to a transaction from exercising all their rights and obligations under the transaction documents. This document cannot be reproduced except in full, without prior written approval of the Company. Any unauthorized alteration, forgery or falsification of the content or appearance of this document is unlawful and offenders may be prosecuted to the fullest extent of the law.

Report Number :TERF2404001033ER
 Operation Mode :BLE 2M
 Test Frequency :2402 MHz
 Test Mode :Bandedge
 EUT Pol :E1 Plane

Test Site :SAC 2
 Test Date :2024-05-07
 Temp./Humi. :24.3°C/59%
 Antenna Pol. :Vertical
 Engineer :Eason Wang

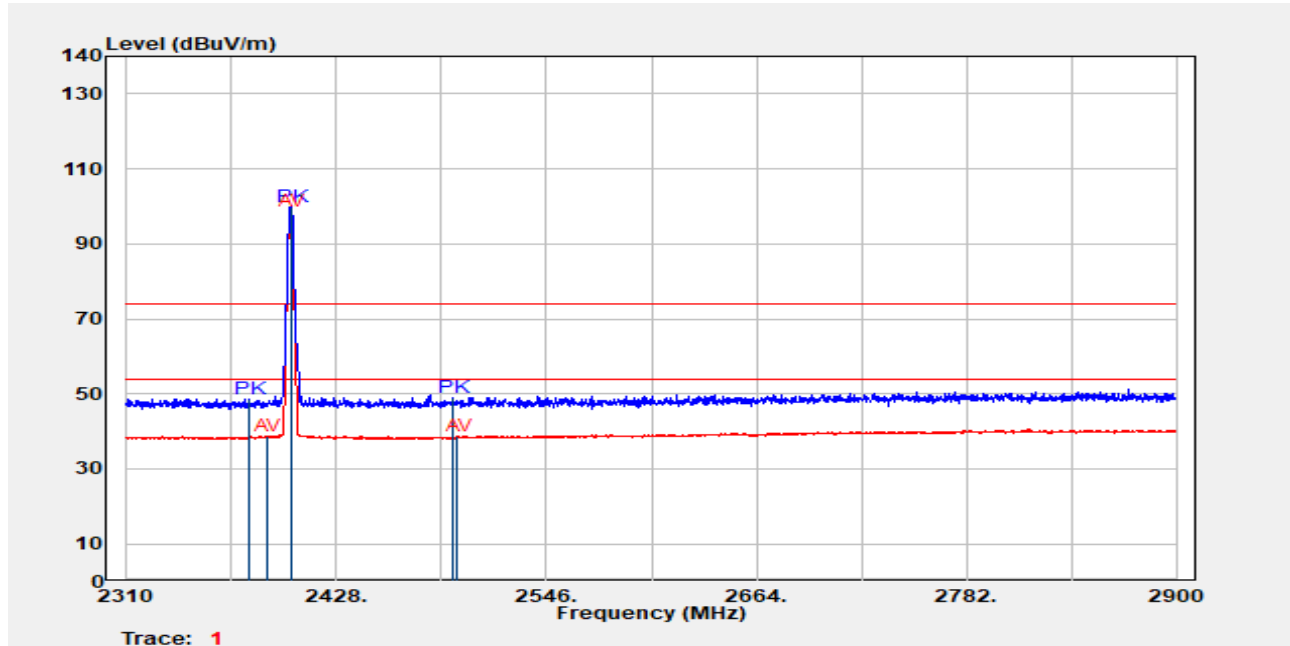

Freq. MHz	Detector Mode PK/QP/AV	Spectrum Reading Level dBμV	Factor dB	Actual FS dBμV/m	Limit @3m dBμV/m	Margin dB
2378.86	Peak	52.97	-4.33	48.64	74.00	-25.36
2388.89	Average	42.99	-4.32	38.67	54.00	-15.33
2402.00	Peak	104.34	-4.43	99.91	-	-
2402.00	Average	103.05	-4.43	98.62	-	-
2493.75	Peak	53.43	-4.46	48.97	74.00	-25.03
2496.11	Average	43.29	-4.43	38.86	54.00	-15.14

Unless otherwise stated the results shown in this test report refer only to the sample(s) tested and such sample(s) are retained for 90 days only.

除非另有說明，此報告結果僅對測試之樣品負責，同時此樣品僅保留90天。本報告未經本公司書面許可，不可部份複製。

This document is issued by the Company subject to its General Conditions of Service printed overleaf, available on request or accessible at <http://www.sgs.com.tw/Terms-and-Conditions> and for electronic format documents, subject to Terms and Conditions for Electronic Documents at <http://www.sgs.com.tw/Terms-and-Conditions>. Attention is drawn to the limitation of liability, indemnification and jurisdiction issues defined therein. Any holder of this document is advised that information contained hereon reflects the Company's findings at the time of its intervention only and within the limits of Client's instructions, if any. The Company's sole responsibility is to its Client and this document does not exonerate parties to a transaction from exercising all their rights and obligations under the transaction documents. This document cannot be reproduced except in full, without prior written approval of the Company. Any unauthorized alteration, forgery or falsification of the content or appearance of this document is unlawful and offenders may be prosecuted to the fullest extent of the law.

Report Number :TERF2404001033ER
 Operation Mode :BLE 2M
 Test Frequency :2402 MHz
 Test Mode :Bandedge
 EUT Pol :E1 Plane

Test Site :SAC 2
 Test Date :2024-05-07
 Temp./Humi. :24.3°C/59%
 Antenna Pol. :Horizontal
 Engineer :Eason Wang

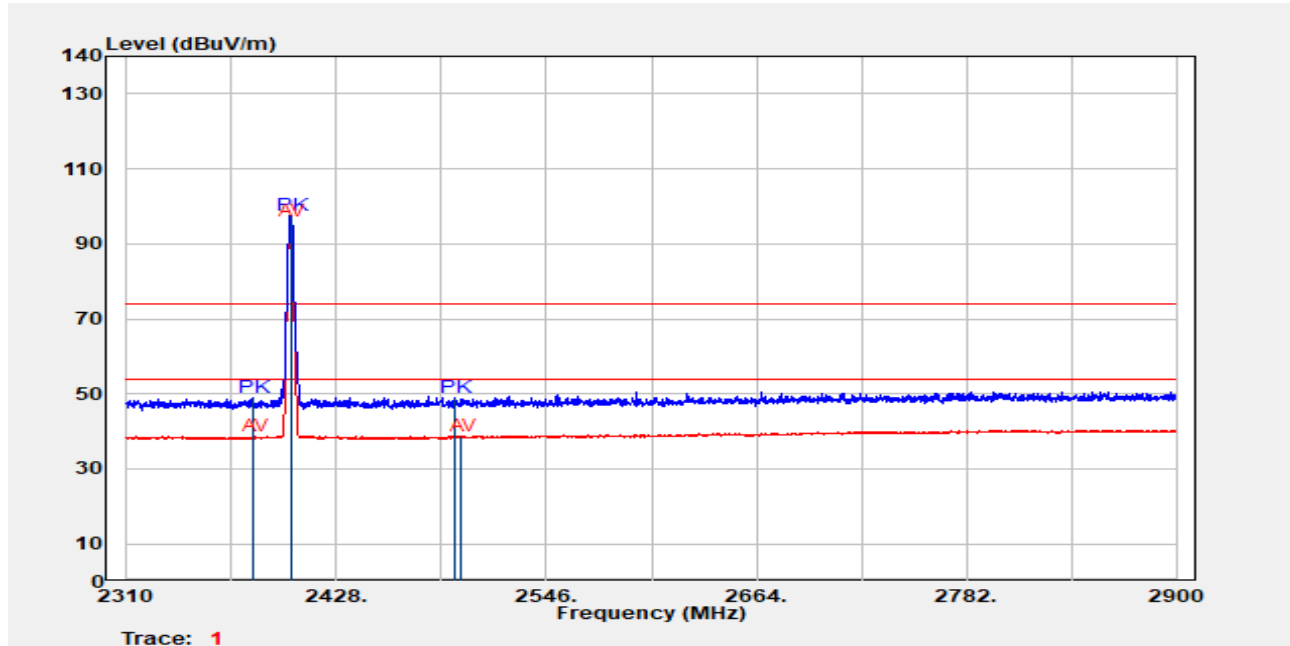

Freq. MHz	Detector Mode PK/QP/AV	Spectrum Reading Level dBμV	Factor dB	Actual FS dBμV/m	Limit @3m dBμV/m	Margin dB
2381.41	Peak	53.17	-4.31	48.86	74.00	-25.14
2381.41	Average	43.06	-4.31	38.75	54.00	-15.25
2402.00	Peak	101.80	-4.43	97.37	-	-
2402.00	Average	100.56	-4.43	96.13	-	-
2494.34	Peak	53.37	-4.45	48.92	74.00	-25.08
2498.08	Average	43.16	-4.41	38.75	54.00	-15.25

Unless otherwise stated the results shown in this test report refer only to the sample(s) tested and such sample(s) are retained for 90 days only.

除非另有說明，此報告結果僅對測試之樣品負責，同時此樣品僅保留90天。本報告未經本公司書面許可，不可部份複製。

This document is issued by the Company subject to its General Conditions of Service printed overleaf, available on request or accessible at <http://www.sgs.com.tw/Terms-and-Conditions> and for electronic format documents, subject to Terms and Conditions for Electronic Documents at <http://www.sgs.com.tw/Terms-and-Conditions>. Attention is drawn to the limitation of liability, indemnification and jurisdiction issues defined therein. Any holder of this document is advised that information contained hereon reflects the Company's findings at the time of its intervention only and within the limits of Client's instructions, if any. The Company's sole responsibility is to its Client and this document does not exonerate parties to a transaction from exercising all their rights and obligations under the transaction documents. This document cannot be reproduced except in full, without prior written approval of the Company. Any unauthorized alteration, forgery or falsification of the content or appearance of this document is unlawful and offenders may be prosecuted to the fullest extent of the law.

Report Number :TERF2404001033ER
 Operation Mode :BLE 2M
 Test Frequency :2480 MHz
 Test Mode :Bandedge
 EUT Pol :E1 Plane

Test Site :SAC 2
 Test Date :2024-05-07
 Temp./Humi. :24.3°C/59%
 Antenna Pol. :Vertical
 Engineer :Eason Wang

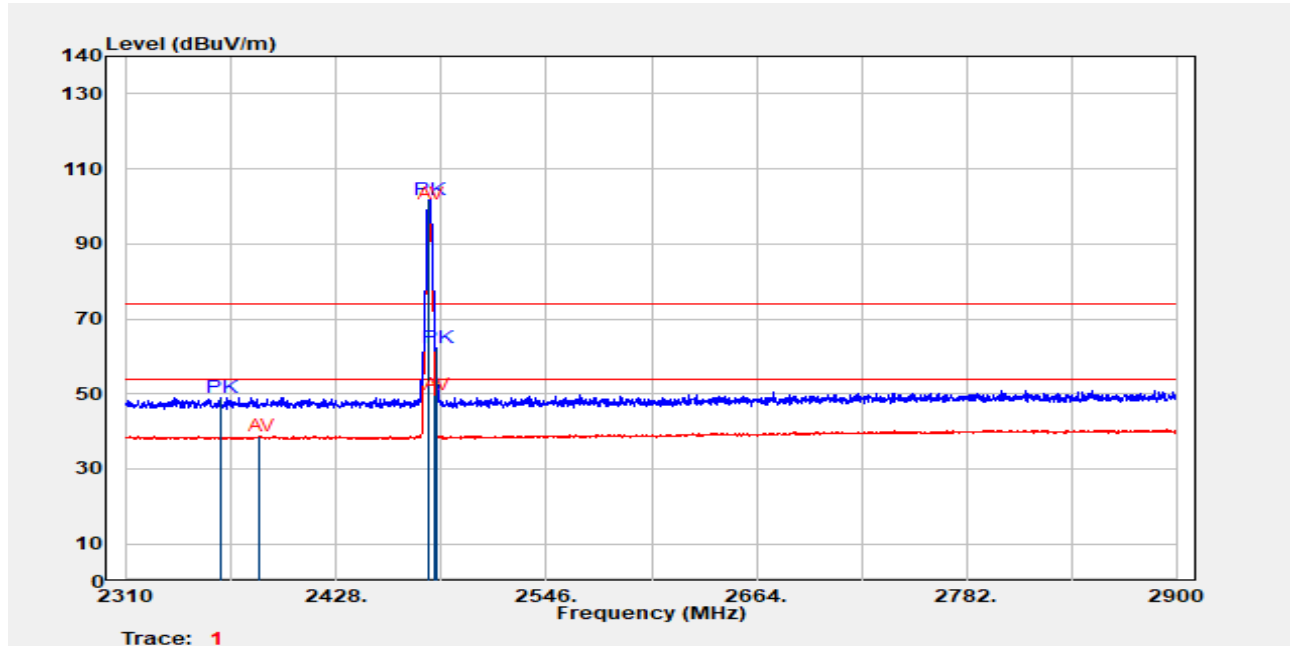

Freq. MHz	Detector Mode PK/QP/AV	Spectrum Reading Level dBμV	Factor dB	Actual FS dBμV/m	Limit @3m dBμV/m	Margin dB
2362.33	Peak	53.43	-4.41	49.02	74.00	-24.98
2384.96	Average	42.99	-4.32	38.67	54.00	-15.33
2480.00	Peak	106.30	-4.51	101.79	-	-
2480.00	Average	104.94	-4.51	100.43	-	-
2483.52	Average	54.32	-4.50	49.82	54.00	-4.18
2483.72	Peak	66.55	-4.50	62.05	74.00	-11.95

Unless otherwise stated the results shown in this test report refer only to the sample(s) tested and such sample(s) are retained for 90 days only.

除非另有說明，此報告結果僅對測試之樣品負責，同時此樣品僅保留90天。本報告未經本公司書面許可，不可部份複製。
 This document is issued by the Company subject to its General Conditions of Service printed overleaf, available on request or accessible at <http://www.sgs.com.tw/Terms-and-Conditions> and for electronic format documents, subject to Terms and Conditions for Electronic Documents at <http://www.sgs.com.tw/Terms-and-Conditions>. Attention is drawn to the limitation of liability, indemnification and jurisdiction issues defined therein. Any holder of this document is advised that information contained hereon reflects the Company's findings at the time of its intervention only and within the limits of Client's instructions, if any. The Company's sole responsibility is to its Client and this document does not exonerate parties to a transaction from exercising all their rights and obligations under the transaction documents. This document cannot be reproduced except in full, without prior written approval of the Company. Any unauthorized alteration, forgery or falsification of the content or appearance of this document is unlawful and offenders may be prosecuted to the fullest extent of the law.

Report Number :TERF2404001033ER
 Operation Mode :BLE 2M
 Test Frequency :2480 MHz
 Test Mode :Bandedge
 EUT Pol :E1 Plane

Test Site :SAC 2
 Test Date :2024-05-07
 Temp./Humi. :24.3°C/59%
 Antenna Pol. :Horizontal
 Engineer :Eason Wang

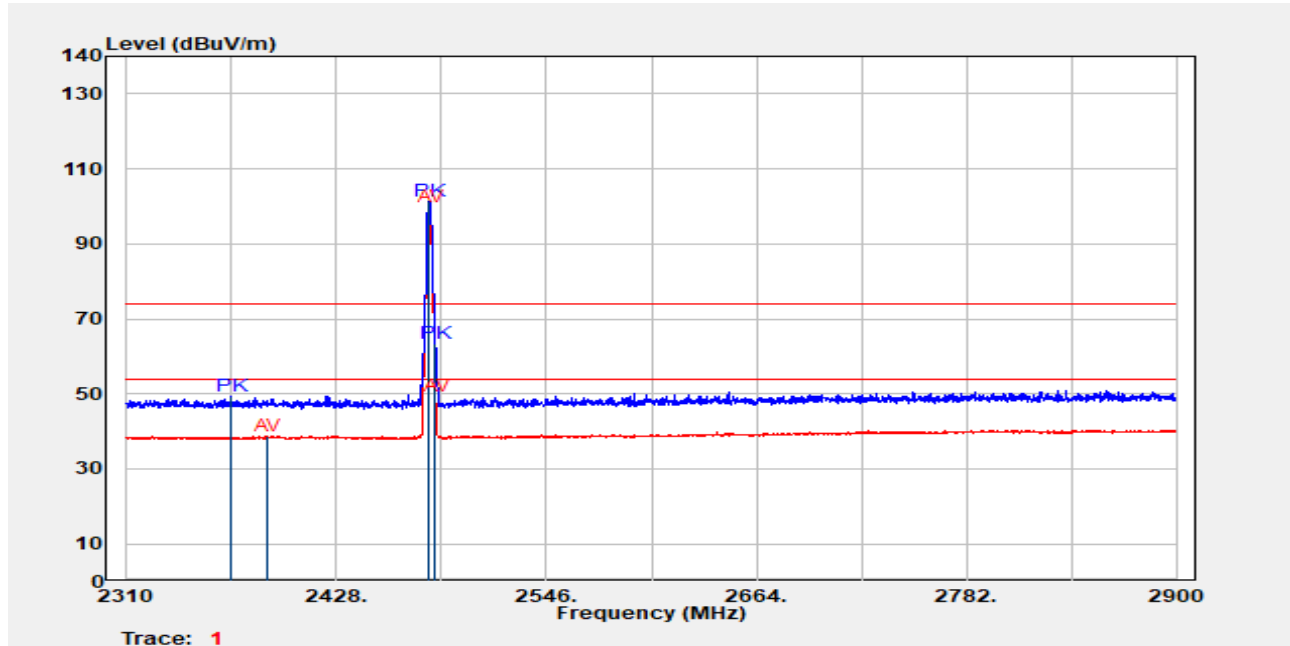

Freq. MHz	Detector Mode PK/QP/AV	Spectrum Reading Level dBμV	Factor dB	Actual FS dBμV/m	Limit @3m dBμV/m	Margin dB
2368.23	Peak	53.73	-4.42	49.31	74.00	-24.69
2388.89	Average	42.90	-4.32	38.58	54.00	-15.42
2480.00	Peak	105.68	-4.51	101.17	-	-
2480.00	Average	104.47	-4.51	99.96	-	-
2483.52	Peak	67.85	-4.50	63.35	74.00	-10.65
2483.52	Average	53.87	-4.50	49.37	54.00	-4.63

Unless otherwise stated the results shown in this test report refer only to the sample(s) tested and such sample(s) are retained for 90 days only.

除非另有說明，此報告結果僅對測試之樣品負責，同時此樣品僅保留90天。本報告未經本公司書面許可，不可部份複製。
 This document is issued by the Company subject to its General Conditions of Service printed overleaf, available on request or accessible at <http://www.sgs.com.tw/Terms-and-Conditions> and for electronic format documents, subject to Terms and Conditions for Electronic Documents at <http://www.sgs.com.tw/Terms-and-Conditions>. Attention is drawn to the limitation of liability, indemnification and jurisdiction issues defined therein. Any holder of this document is advised that information contained hereon reflects the Company's findings at the time of its intervention only and within the limits of Client's instructions, if any. The Company's sole responsibility is to its Client and this document does not exonerate parties to a transaction from exercising all their rights and obligations under the transaction documents. This document cannot be reproduced except in full, without prior written approval of the Company. Any unauthorized alteration, forgery or falsification of the content or appearance of this document is unlawful and offenders may be prosecuted to the fullest extent of the law.

Report Number :TERF2404001033ER
 Operation Mode :BLE PHY=8
 Test Frequency :2402 MHz
 Test Mode :Bandedge
 EUT Pol :E1 Plane

Test Site :SAC 2
 Test Date :2024-05-07
 Temp./Humi. :24.3°C/59%
 Antenna Pol. :Vertical
 Engineer :Eason Wang

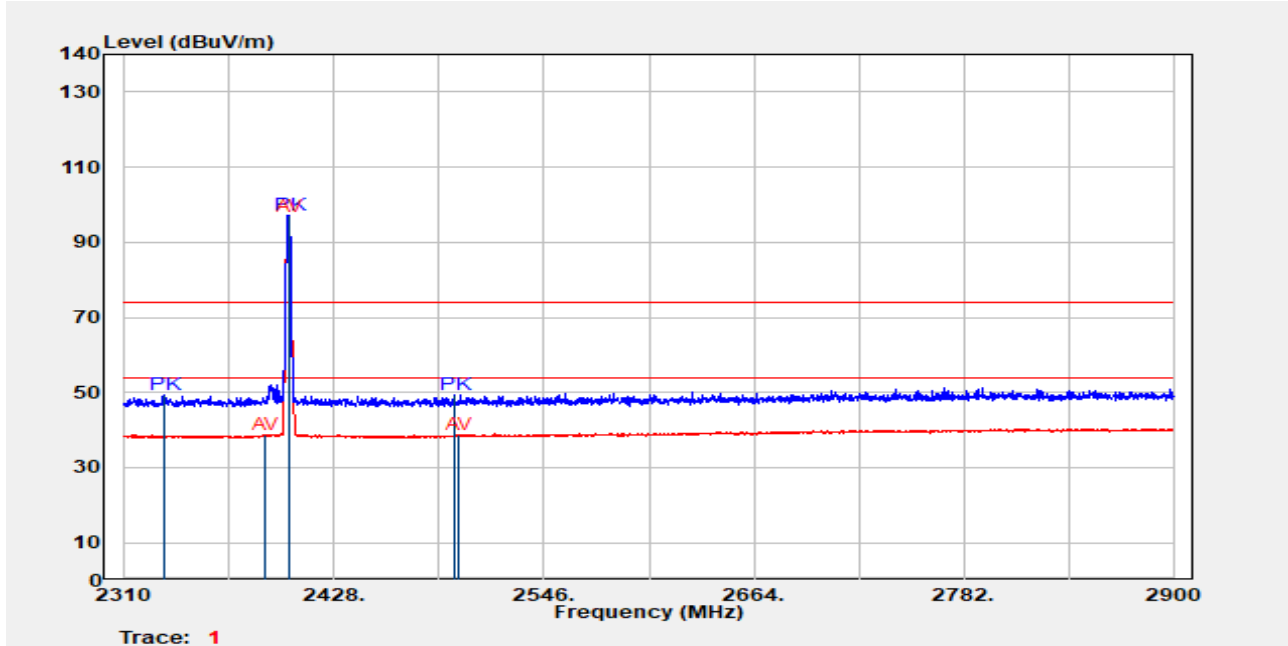

Freq. MHz	Detector Mode PK/QP/AV	Spectrum Reading Level dBμV	Factor dB	Actual FS dBμV/m	Limit @3m dBμV/m	Margin dB
2331.837	Peak	53.57	-4.40	49.17	74.00	-24.83
2388.496	Average	43.05	-4.32	38.73	54.00	-15.27
2402.000	Peak	101.71	-4.43	97.29	-	-
2402.000	Average	101.22	-4.43	96.80	-	-
2495.715	Peak	53.92	-4.44	49.49	74.00	-24.51
2497.486	Average	43.08	-4.42	38.66	54.00	-15.34

Unless otherwise stated the results shown in this test report refer only to the sample(s) tested and such sample(s) are retained for 90 days only.

除非另有說明，此報告結果僅對測試之樣品負責，同時此樣品僅保留90天。本報告未經本公司書面許可，不可部份複製。

This document is issued by the Company subject to its General Conditions of Service printed overleaf, available on request or accessible at <http://www.sgs.com.tw/Terms-and-Conditions> and for electronic format documents, subject to Terms and Conditions for Electronic Documents at <http://www.sgs.com.tw/Terms-and-Conditions>. Attention is drawn to the limitation of liability, indemnification and jurisdiction issues defined therein. Any holder of this document is advised that information contained hereon reflects the Company's findings at the time of its intervention only and within the limits of Client's instructions, if any. The Company's sole responsibility is to its Client and this document does not exonerate parties to a transaction from exercising all their rights and obligations under the transaction documents. This document cannot be reproduced except in full, without prior written approval of the Company. Any unauthorized alteration, forgery or falsification of the content or appearance of this document is unlawful and offenders may be prosecuted to the fullest extent of the law.

Report Number :TERF2404001033ER
 Operation Mode :BLE PHY=8
 Test Frequency :2402 MHz
 Test Mode :Bandedge
 EUT Pol :E1 Plane

Test Site :SAC 2
 Test Date :2024-05-07
 Temp./Humi. :24.3°C/59%
 Antenna Pol. :Horizontal
 Engineer :Eason Wang

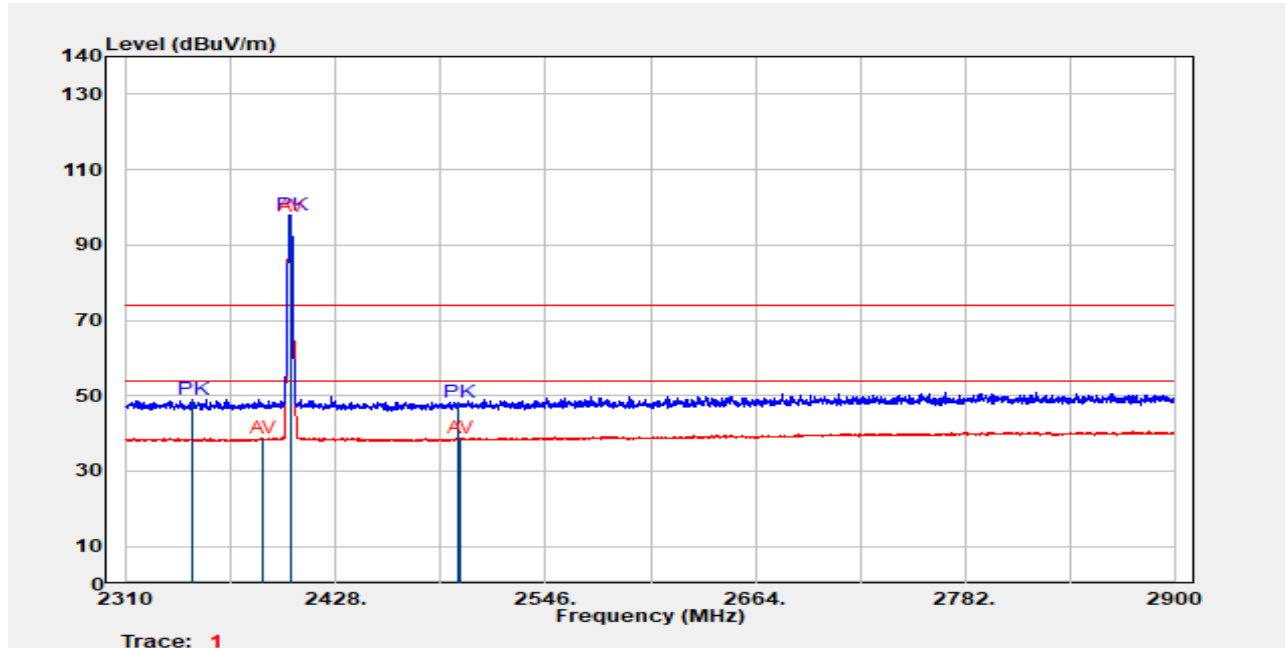

Freq. MHz	Detector Mode PK/QP/AV	Spectrum Reading Level dBμV	Factor dB	Actual FS dBμV/m	Limit @3m dBμV/m	Margin dB
2347.182	Peak	53.48	-4.40	49.08	74.00	-24.92
2386.529	Average	42.95	-4.32	38.63	54.00	-15.37
2402.000	Peak	102.32	-4.43	97.89	-	-
2402.000	Average	101.83	-4.43	97.40	-	-
2496.699	Peak	52.71	-4.43	48.29	74.00	-25.71
2497.879	Average	43.13	-4.41	38.72	54.00	-15.28

Unless otherwise stated the results shown in this test report refer only to the sample(s) tested and such sample(s) are retained for 90 days only.

除非另有說明，此報告結果僅對測試之樣品負責，同時此樣品僅保留90天。本報告未經本公司書面許可，不可部份複製。

This document is issued by the Company subject to its General Conditions of Service printed overleaf, available on request or accessible at <http://www.sgs.com.tw/Terms-and-Conditions> and for electronic format documents, subject to Terms and Conditions for Electronic Documents at <http://www.sgs.com.tw/Terms-and-Conditions>. Attention is drawn to the limitation of liability, indemnification and jurisdiction issues defined therein. Any holder of this document is advised that information contained hereon reflects the Company's findings at the time of its intervention only and within the limits of Client's instructions, if any. The Company's sole responsibility is to its Client and this document does not exonerate parties to a transaction from exercising all their rights and obligations under the transaction documents. This document cannot be reproduced except in full, without prior written approval of the Company. Any unauthorized alteration, forgery or falsification of the content or appearance of this document is unlawful and offenders may be prosecuted to the fullest extent of the law.

Report Number :TERF2404001033ER
 Operation Mode :BLE PHY=8
 Test Frequency :2480 MHz
 Test Mode :Bandedge
 EUT Pol :E1 Plane

Test Site :SAC 2
 Test Date :2024-05-07
 Temp./Humi. :24.3°C/59%
 Antenna Pol. :Vertical
 Engineer :Eason Wang

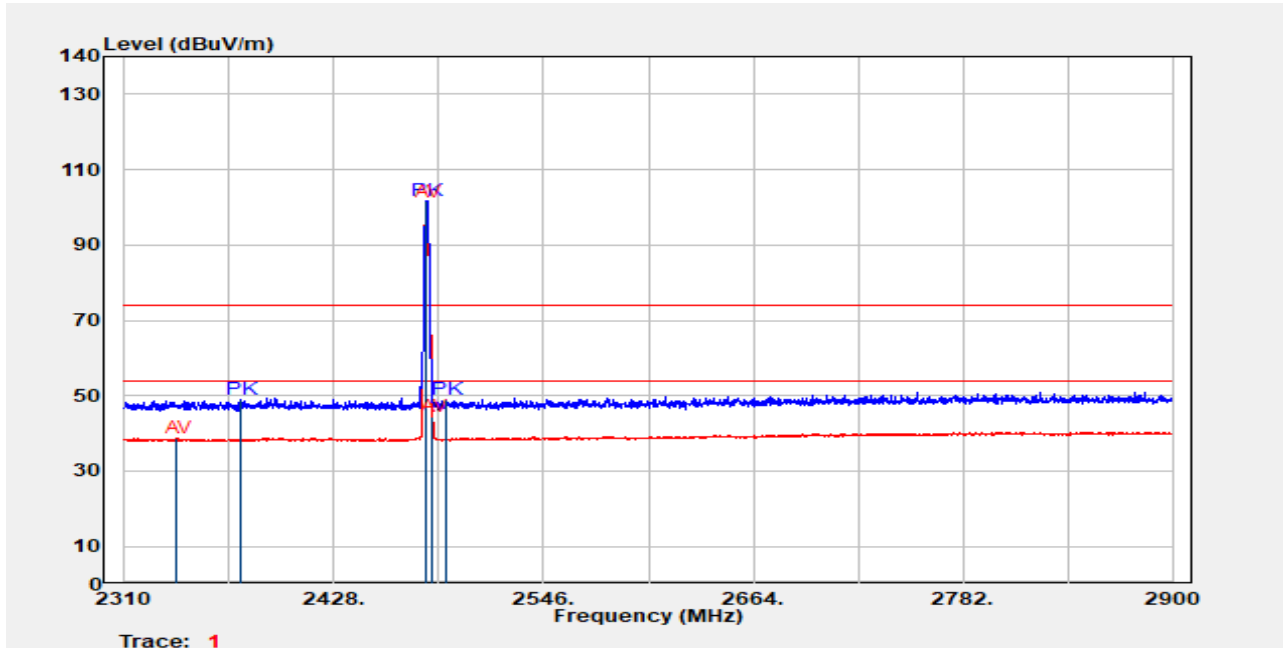

Freq. MHz	Detector Mode PK/QP/AV	Spectrum Reading Level dBμV	Factor dB	Actual FS dBμV/m	Limit @3m dBμV/m	Margin dB
2339.313	Average	43.07	-4.40	38.66	54.00	-15.34
2375.512	Peak	53.13	-4.36	48.77	74.00	-25.23
2480.000	Peak	106.26	-4.51	101.75	-	-
2480.000	Average	105.71	-4.51	101.20	-	-
2483.518	Average	48.73	-4.50	44.22	54.00	-9.78
2490.994	Peak	53.46	-4.49	48.98	74.00	-25.02

Unless otherwise stated the results shown in this test report refer only to the sample(s) tested and such sample(s) are retained for 90 days only.

除非另有說明，此報告結果僅對測試之樣品負責，同時此樣品僅保留90天。本報告未經本公司書面許可，不可部份複製。

This document is issued by the Company subject to its General Conditions of Service printed overleaf, available on request or accessible at <http://www.sgs.com.tw/Terms-and-Conditions> and for electronic format documents, subject to Terms and Conditions for Electronic Documents at <http://www.sgs.com.tw/Terms-and-Conditions>. Attention is drawn to the limitation of liability, indemnification and jurisdiction issues defined therein. Any holder of this document is advised that information contained hereon reflects the Company's findings at the time of its intervention only and within the limits of Client's instructions, if any. The Company's sole responsibility is to its Client and this document does not exonerate parties to a transaction from exercising all their rights and obligations under the transaction documents. This document cannot be reproduced except in full, without prior written approval of the Company. Any unauthorized alteration, forgery or falsification of the content or appearance of this document is unlawful and offenders may be prosecuted to the fullest extent of the law.

Report Number :TERF2404001033ER
 Operation Mode :BLE PHY=8
 Test Frequency :2480 MHz
 Test Mode :Bandedge
 EUT Pol :E1 Plane

Test Site :SAC 2
 Test Date :2024-05-07
 Temp./Humi. :24.3°C/59%
 Antenna Pol. :Horizontal
 Engineer :Eason Wang

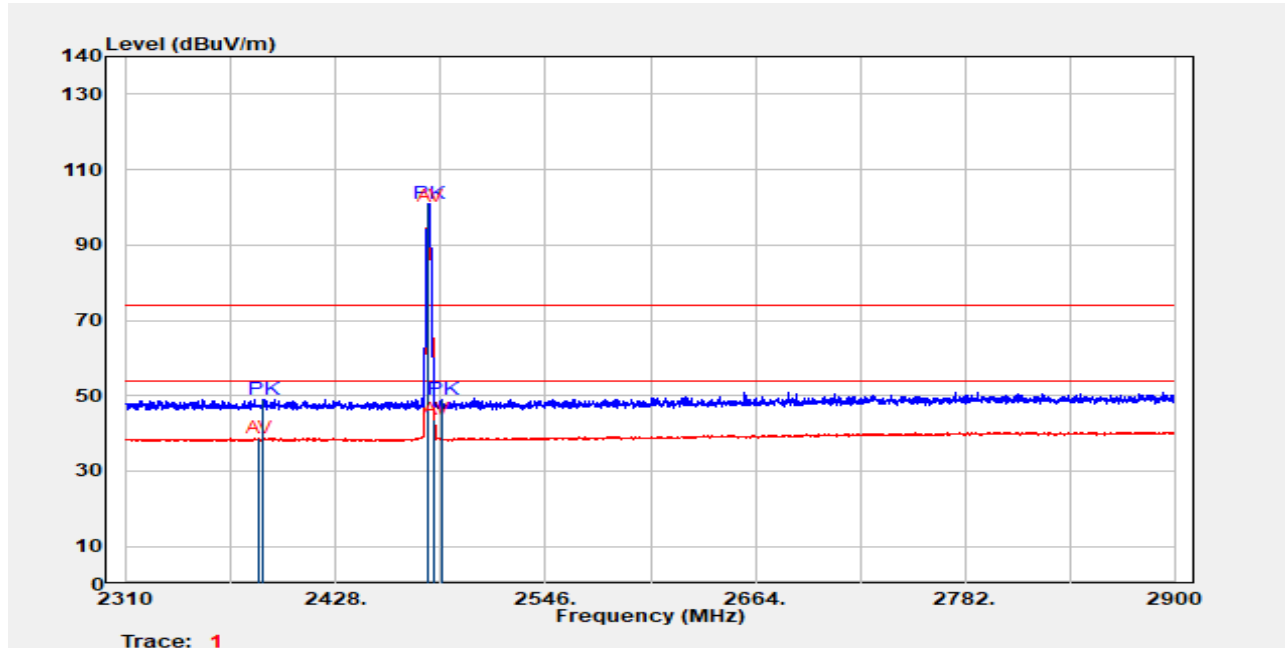

Freq. MHz	Detector Mode PK/QP/AV	Spectrum Reading Level dBμV	Factor dB	Actual FS dBμV/m	Limit @3m dBμV/m	Margin dB
2384.168	Average	42.99	-4.32	38.67	54.00	-15.33
2387.119	Peak	53.30	-4.32	48.97	74.00	-25.03
2480.000	Peak	105.42	-4.51	100.91	-	-
2480.000	Average	104.84	-4.51	100.34	-	-
2483.518	Average	48.07	-4.50	43.56	54.00	-10.44
2487.846	Peak	53.51	-4.50	49.01	74.00	-24.99

Unless otherwise stated the results shown in this test report refer only to the sample(s) tested and such sample(s) are retained for 90 days only.

除非另有說明，此報告結果僅對測試之樣品負責，同時此樣品僅保留90天。本報告未經本公司書面許可，不可部份複製。

This document is issued by the Company subject to its General Conditions of Service printed overleaf, available on request or accessible at <http://www.sgs.com.tw/Terms-and-Conditions> and for electronic format documents, subject to Terms and Conditions for Electronic Documents at <http://www.sgs.com.tw/Terms-and-Conditions>. Attention is drawn to the limitation of liability, indemnification and jurisdiction issues defined therein. Any holder of this document is advised that information contained hereon reflects the Company's findings at the time of its intervention only and within the limits of Client's instructions, if any. The Company's sole responsibility is to its Client and this document does not exonerate parties to a transaction from exercising all their rights and obligations under the transaction documents. This document cannot be reproduced except in full, without prior written approval of the Company. Any unauthorized alteration, forgery or falsification of the content or appearance of this document is unlawful and offenders may be prosecuted to the fullest extent of the law.

Report Number :TERF2404001033ER
 Operation Mode :BLE PHY=2
 Test Frequency :2402 MHz
 Test Mode :Bandedge
 EUT Pol :E1 Plane

Test Site :SAC 2
 Test Date :2024-05-07
 Temp./Humi. :24.3°C/59%
 Antenna Pol. :Vertical
 Engineer :Eason Wang

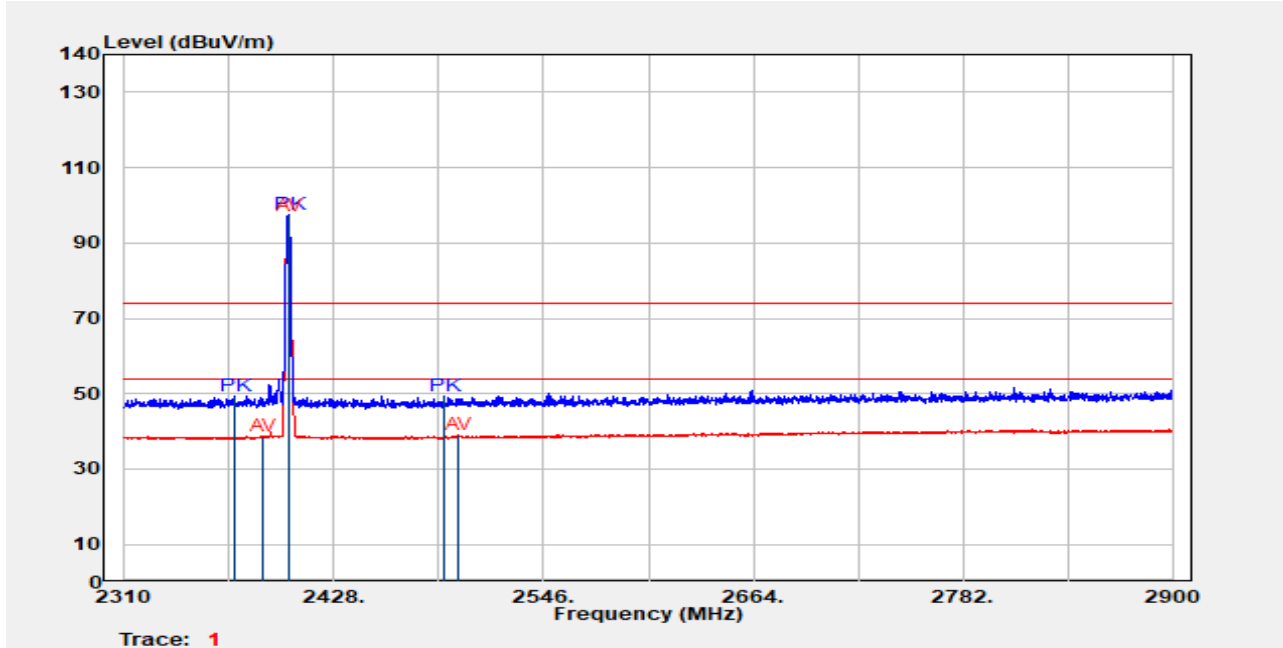

Freq. MHz	Detector Mode PK/QP/AV	Spectrum Reading Level dBμV	Factor dB	Actual FS dBμV/m	Limit @3m dBμV/m	Margin dB
2371.380	Peak	53.61	-4.40	49.21	74.00	-24.79
2387.512	Average	42.94	-4.32	38.62	54.00	-15.38
2402.000	Peak	101.79	-4.43	97.37	-	-
2402.000	Average	101.36	-4.43	96.94	-	-
2489.813	Peak	53.87	-4.50	49.37	74.00	-24.63
2497.486	Average	43.31	-4.42	38.89	54.00	-15.11

Unless otherwise stated the results shown in this test report refer only to the sample(s) tested and such sample(s) are retained for 90 days only.

除非另有說明，此報告結果僅對測試之樣品負責，同時此樣品僅保留90天。本報告未經本公司書面許可，不可部份複製。

This document is issued by the Company subject to its General Conditions of Service printed overleaf, available on request or accessible at <http://www.sgs.com.tw/Terms-and-Conditions> and for electronic format documents, subject to Terms and Conditions for Electronic Documents at <http://www.sgs.com.tw/Terms-and-Conditions>. Attention is drawn to the limitation of liability, indemnification and jurisdiction issues defined therein. Any holder of this document is advised that information contained hereon reflects the Company's findings at the time of its intervention only and within the limits of Client's instructions, if any. The Company's sole responsibility is to its Client and this document does not exonerate parties to a transaction from exercising all their rights and obligations under the transaction documents. This document cannot be reproduced except in full, without prior written approval of the Company. Any unauthorized alteration, forgery or falsification of the content or appearance of this document is unlawful and offenders may be prosecuted to the fullest extent of the law.

Report Number :TERF2404001033ER
 Operation Mode :BLE PHY=2
 Test Frequency :2402 MHz
 Test Mode :Bandedge
 EUT Pol :E1 Plane

Test Site :SAC 2
 Test Date :2024-05-07
 Temp./Humi. :24.3°C/59%
 Antenna Pol. :Horizontal
 Engineer :Eason Wang

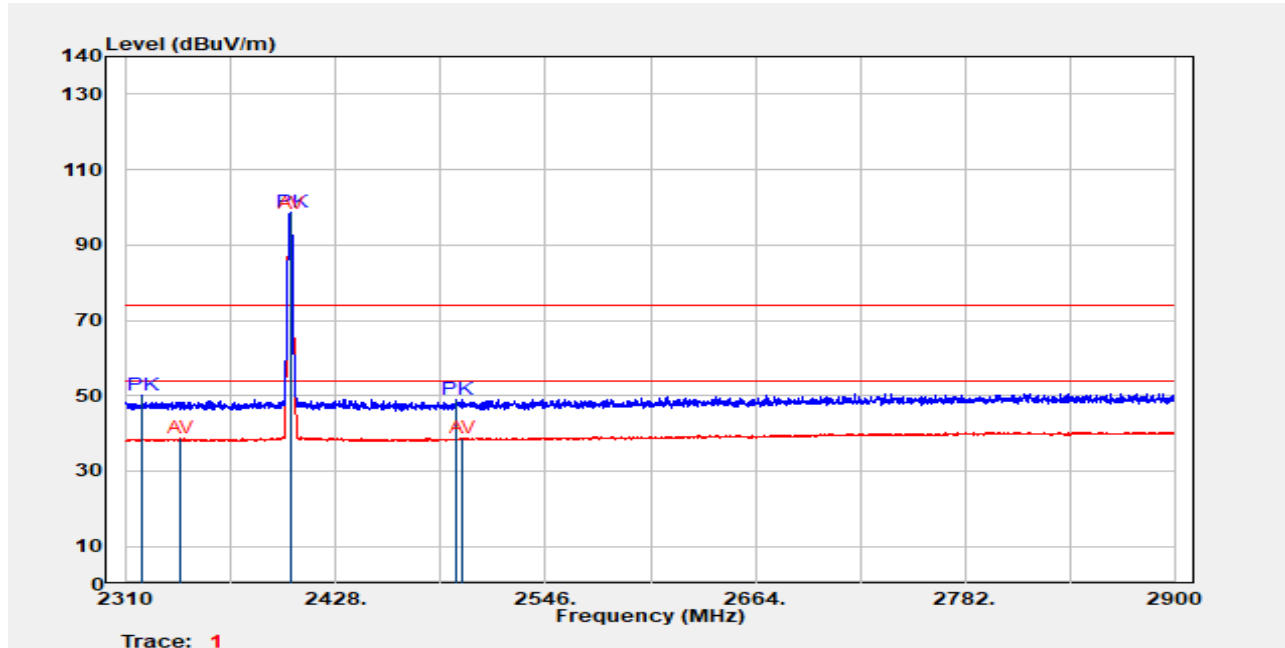

Freq. MHz	Detector Mode PK/QP/AV	Spectrum Reading Level dBμV	Factor dB	Actual FS dBμV/m	Limit @3m dBμV/m	Margin dB
2318.459	Peak	54.44	-4.39	50.05	74.00	-23.95
2339.707	Average	43.09	-4.40	38.69	54.00	-15.31
2402.000	Peak	102.93	-4.43	98.51	-	-
2402.000	Average	102.52	-4.43	98.09	-	-
2495.912	Peak	53.46	-4.43	49.03	74.00	-24.97
2498.863	Average	43.10	-4.40	38.69	54.00	-15.31

Unless otherwise stated the results shown in this test report refer only to the sample(s) tested and such sample(s) are retained for 90 days only.

除非另有說明，此報告結果僅對測試之樣品負責，同時此樣品僅保留90天。本報告未經本公司書面許可，不可部份複製。

This document is issued by the Company subject to its General Conditions of Service printed overleaf, available on request or accessible at <http://www.sgs.com.tw/Terms-and-Conditions> and for electronic format documents, subject to Terms and Conditions for Electronic Documents at <http://www.sgs.com.tw/Terms-and-Conditions>. Attention is drawn to the limitation of liability, indemnification and jurisdiction issues defined therein. Any holder of this document is advised that information contained hereon reflects the Company's findings at the time of its intervention only and within the limits of Client's instructions, if any. The Company's sole responsibility is to its Client and this document does not exonerate parties to a transaction from exercising all their rights and obligations under the transaction documents. This document cannot be reproduced except in full, without prior written approval of the Company. Any unauthorized alteration, forgery or falsification of the content or appearance of this document is unlawful and offenders may be prosecuted to the fullest extent of the law.

Report Number :TERF2404001033ER
 Operation Mode :BLE PHY=2
 Test Frequency :2480 MHz
 Test Mode :Bandedge
 EUT Pol :E1 Plane

Test Site :SAC 2
 Test Date :2024-05-07
 Temp./Humi. :24.3°C/59%
 Antenna Pol. :Vertical
 Engineer :Eason Wang

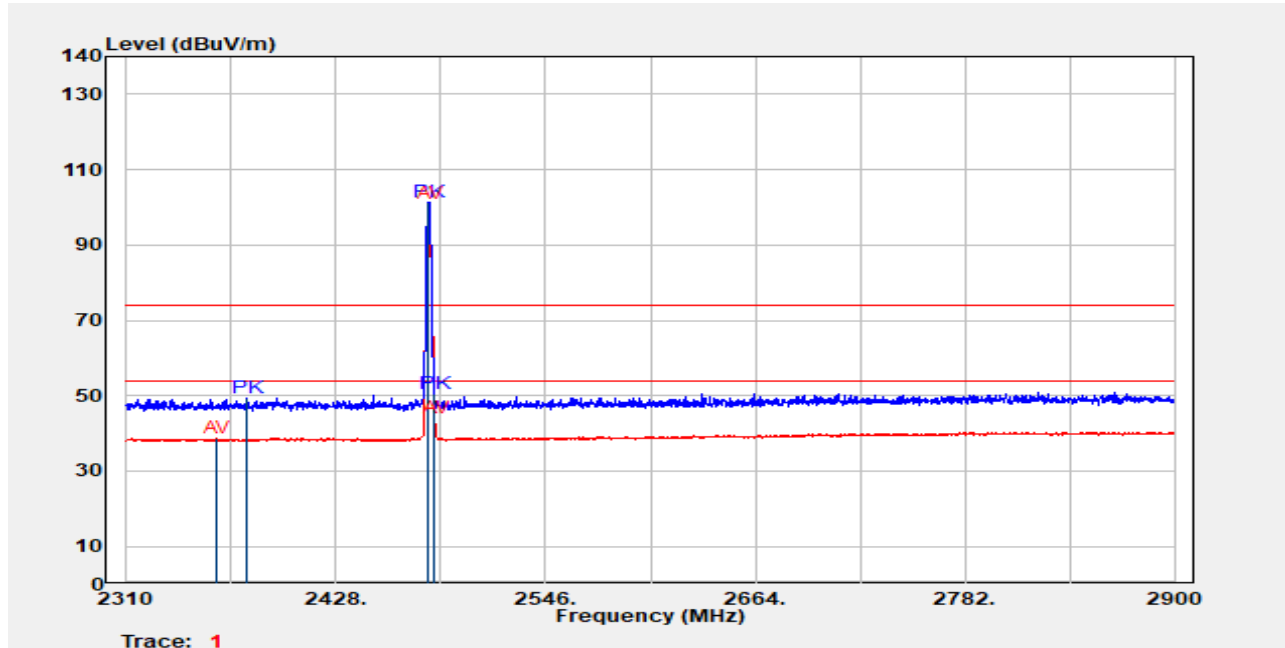

Freq. MHz	Detector Mode PK/QP/AV	Spectrum Reading Level dBμV	Factor dB	Actual FS dBμV/m	Limit @3m dBμV/m	Margin dB
2360.364	Average	43.02	-4.41	38.62	54.00	-15.38
2377.479	Peak	53.82	-4.34	49.47	74.00	-24.53
2480.000	Peak	105.91	-4.51	101.40	-	-
2480.000	Average	105.51	-4.51	101.00	-	-
2483.518	Peak	55.12	-4.50	50.62	74.00	-23.38
2483.518	Average	48.48	-4.50	43.97	54.00	-10.03

Unless otherwise stated the results shown in this test report refer only to the sample(s) tested and such sample(s) are retained for 90 days only.

除非另有說明，此報告結果僅對測試之樣品負責，同時此樣品僅保留90天。本報告未經本公司書面許可，不可部份複製。

This document is issued by the Company subject to its General Conditions of Service printed overleaf, available on request or accessible at <http://www.sgs.com.tw/Terms-and-Conditions> and for electronic format documents, subject to Terms and Conditions for Electronic Documents at <http://www.sgs.com.tw/Terms-and-Conditions>. Attention is drawn to the limitation of liability, indemnification and jurisdiction issues defined therein. Any holder of this document is advised that information contained hereon reflects the Company's findings at the time of its intervention only and within the limits of Client's instructions, if any. The Company's sole responsibility is to its Client and this document does not exonerate parties to a transaction from exercising all their rights and obligations under the transaction documents. This document cannot be reproduced except in full, without prior written approval of the Company. Any unauthorized alteration, forgery or falsification of the content or appearance of this document is unlawful and offenders may be prosecuted to the fullest extent of the law.

Report Number :TERF2404001033ER
 Operation Mode :BLE PHY=2
 Test Frequency :2480 MHz
 Test Mode :Bandedge
 EUT Pol :E1 Plane

Test Site :SAC 2
 Test Date :2024-05-07
 Temp./Humi. :24.3°C/59%
 Antenna Pol. :Horizontal
 Engineer :Eason Wang

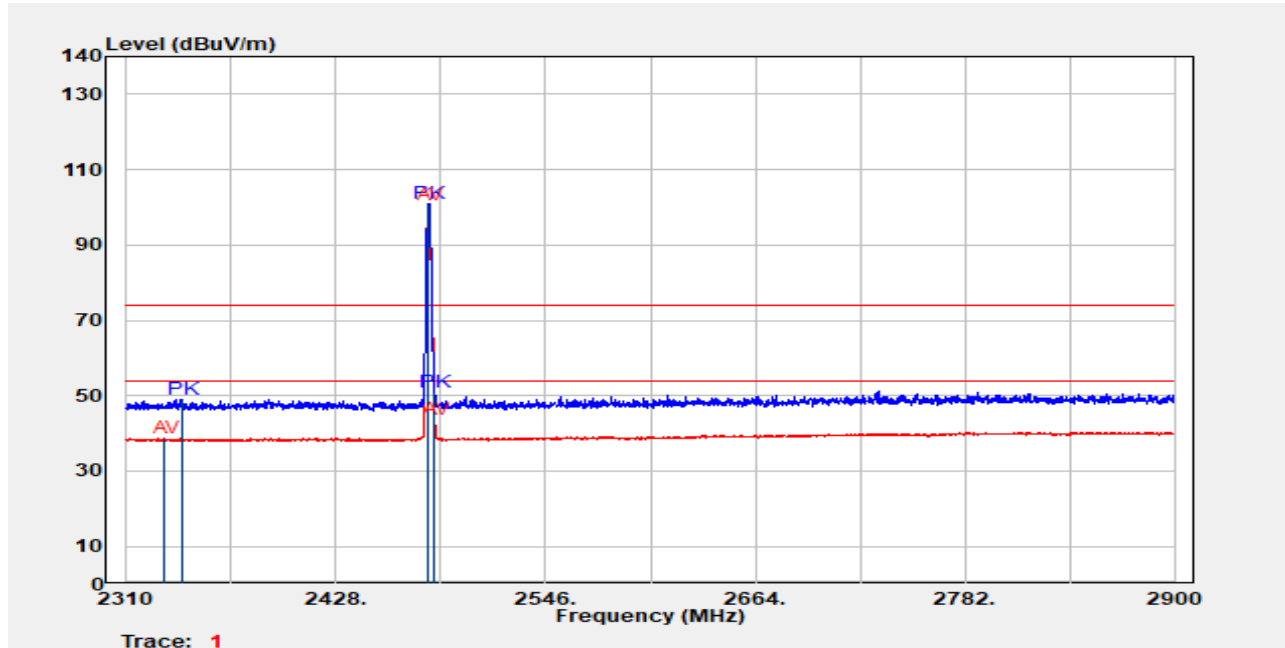

Freq. MHz	Detector Mode PK/QP/AV	Spectrum Reading Level dBμV	Factor dB	Actual FS dBμV/m	Limit @3m dBμV/m	Margin dB
2331.641	Average	43.01	-4.40	38.61	54.00	-15.39
2340.887	Peak	53.37	-4.40	48.96	74.00	-25.04
2480.000	Peak	105.37	-4.51	100.86	-	-
2480.000	Average	104.93	-4.51	100.42	-	-
2483.518	Peak	55.39	-4.50	50.88	74.00	-23.12
2483.518	Average	48.00	-4.50	43.50	54.00	-10.50

Unless otherwise stated the results shown in this test report refer only to the sample(s) tested and such sample(s) are retained for 90 days only.

除非另有說明，此報告結果僅對測試之樣品負責，同時此樣品僅保留90天。本報告未經本公司書面許可，不可部份複製。

This document is issued by the Company subject to its General Conditions of Service printed overleaf, available on request or accessible at <http://www.sgs.com.tw/Terms-and-Conditions> and for electronic format documents, subject to Terms and Conditions for Electronic Documents at <http://www.sgs.com.tw/Terms-and-Conditions>. Attention is drawn to the limitation of liability, indemnification and jurisdiction issues defined therein. Any holder of this document is advised that information contained hereon reflects the Company's findings at the time of its intervention only and within the limits of Client's instructions, if any. The Company's sole responsibility is to its Client and this document does not exonerate parties to a transaction from exercising all their rights and obligations under the transaction documents. This document cannot be reproduced except in full, without prior written approval of the Company. Any unauthorized alteration, forgery or falsification of the content or appearance of this document is unlawful and offenders may be prosecuted to the fullest extent of the law.

11.4.2 Radiated Spurious Emission

Mode: ANT4

Report Number :TERF2404001033ER
 Operation Mode :BLE 1M
 Test Frequency :2440 MHz
 Test Mode :Tx
 EUT Pol :E1 Plane

Test Site :SAC 2
 Test Date :2024-05-08
 Temp./Humi. :23.1°C/62%
 Antenna Pol. :Vertical
 Engineer :Eason Wang

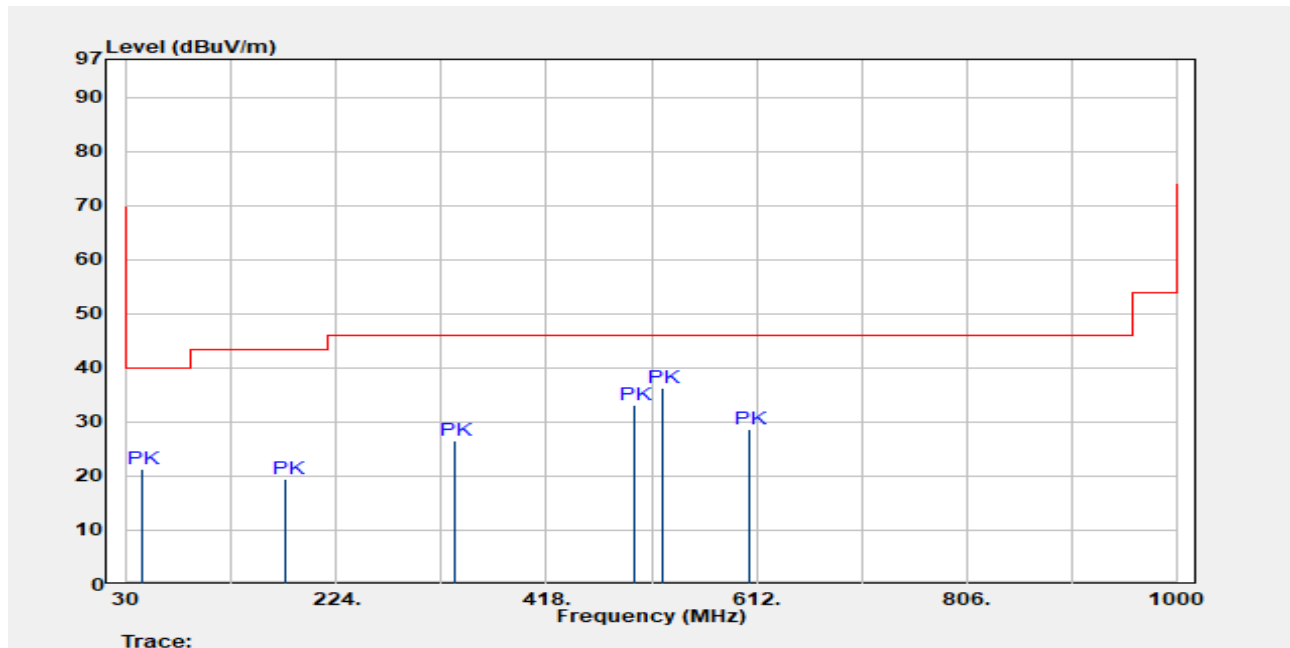

Freq. MHz	Detector Mode PK/QP/AV	Spectrum Reading Level dBuV	Factor dB	Actual FS dBuV/m	Limit @3m dBuV/m	Margin dB
43.58	Peak	34.06	-12.89	21.17	40.00	-18.83
177.44	Peak	33.38	-14.00	19.38	43.50	-24.12
333.61	Peak	37.80	-11.16	26.64	46.00	-19.36
498.51	Peak	40.10	-7.06	33.04	46.00	-12.96
524.70	Peak	42.89	-6.67	36.22	46.00	-9.78
606.18	Peak	33.02	-4.49	28.53	46.00	-17.47

Unless otherwise stated the results shown in this test report refer only to the sample(s) tested and such sample(s) are retained for 90 days only.

除非另有說明，此報告結果僅對測試之樣品負責，同時此樣品僅保留90天。本報告未經本公司書面許可，不可部份複製。

This document is issued by the Company subject to its General Conditions of Service printed overleaf, available on request or accessible at <http://www.sgs.com.tw/Terms-and-Conditions> and for electronic format documents, subject to Terms and Conditions for Electronic Documents at <http://www.sgs.com.tw/Terms-and-Conditions>. Attention is drawn to the limitation of liability, indemnification and jurisdiction issues defined therein. Any holder of this document is advised that information contained hereon reflects the Company's findings at the time of its intervention only and within the limits of Client's instructions, if any. The Company's sole responsibility is to its Client and this document does not exonerate parties to a transaction from exercising all their rights and obligations under the transaction documents. This document cannot be reproduced except in full, without prior written approval of the Company. Any unauthorized alteration, forgery or falsification of the content or appearance of this document is unlawful and offenders may be prosecuted to the fullest extent of the law.

Report Number :TERF2404001033ER
 Operation Mode :BLE 1M
 Test Frequency :2440 MHz
 Test Mode :Tx
 EUT Pol :E1 Plane

Test Site :SAC 2
 Test Date :2024-05-08
 Temp./Humi. :23.1°C/62%
 Antenna Pol. :Horizontal
 Engineer :Eason Wang

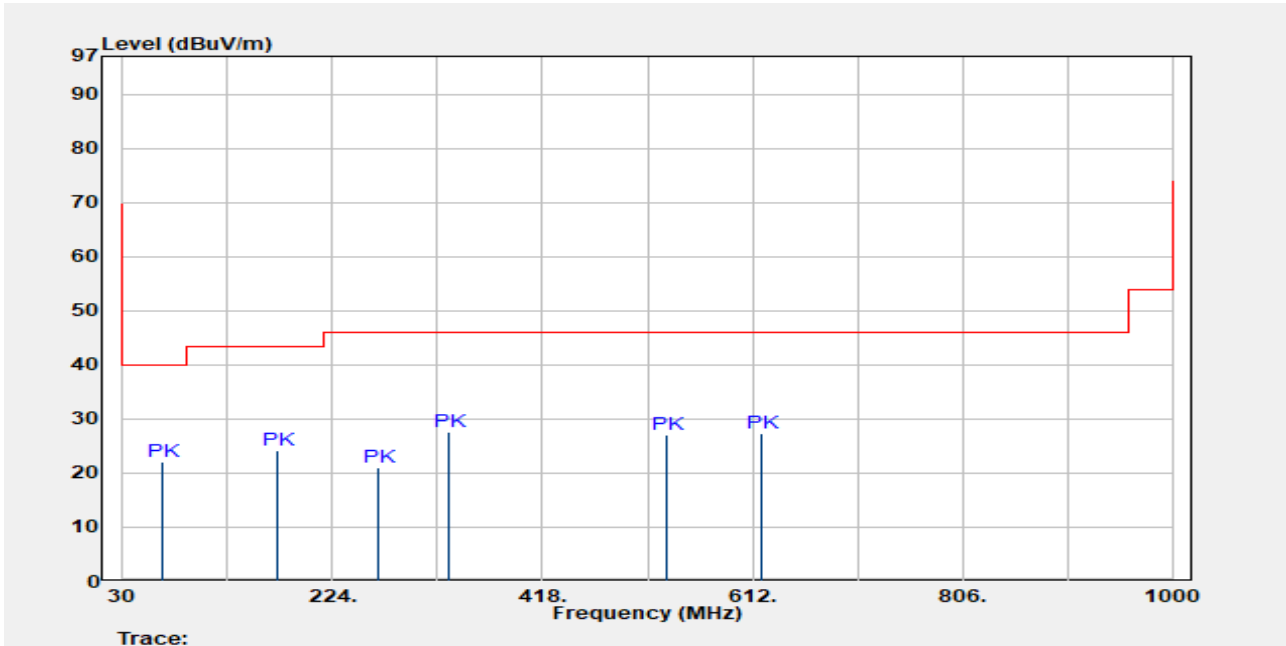

Freq. MHz	Detector Mode PK/QP/AV	Spectrum Reading Level dBμV	Factor dB	Actual FS dBμV/m	Limit @3m dBμV/m	Margin dB
65.89	Peak	36.98	-14.94	22.04	40.00	-17.96
173.56	Peak	37.73	-13.64	24.09	43.50	-19.41
265.71	Peak	33.96	-12.94	21.02	46.00	-24.98
331.67	Peak	38.80	-11.21	27.59	46.00	-18.41
532.46	Peak	33.90	-6.78	27.12	46.00	-18.88
620.73	Peak	31.93	-4.54	27.39	46.00	-18.61

Unless otherwise stated the results shown in this test report refer only to the sample(s) tested and such sample(s) are retained for 90 days only.

除非另有說明，此報告結果僅對測試之樣品負責，同時此樣品僅保留90天。本報告未經本公司書面許可，不可部份複製。

This document is issued by the Company subject to its General Conditions of Service printed overleaf, available on request or accessible at <http://www.sgs.com.tw/Terms-and-Conditions> and for electronic format documents, subject to Terms and Conditions for Electronic Documents at <http://www.sgs.com.tw/Terms-and-Conditions>. Attention is drawn to the limitation of liability, indemnification and jurisdiction issues defined therein. Any holder of this document is advised that information contained hereon reflects the Company's findings at the time of its intervention only and within the limits of Client's instructions, if any. The Company's sole responsibility is to its Client and this document does not exonerate parties to a transaction from exercising all their rights and obligations under the transaction documents. This document cannot be reproduced except in full, without prior written approval of the Company. Any unauthorized alteration, forgery or falsification of the content or appearance of this document is unlawful and offenders may be prosecuted to the fullest extent of the law.

Report Number :TERF2404001033ER
 Operation Mode :BLE 1M
 Test Frequency :2402 MHz
 Test Mode :Tx
 EUT Pol :E1 Plane

Test Site :SAC 2
 Test Date :2024-05-08
 Temp./Humi. :23.1°C/62%
 Antenna Pol. :Vertical
 Engineer :Eason Wang

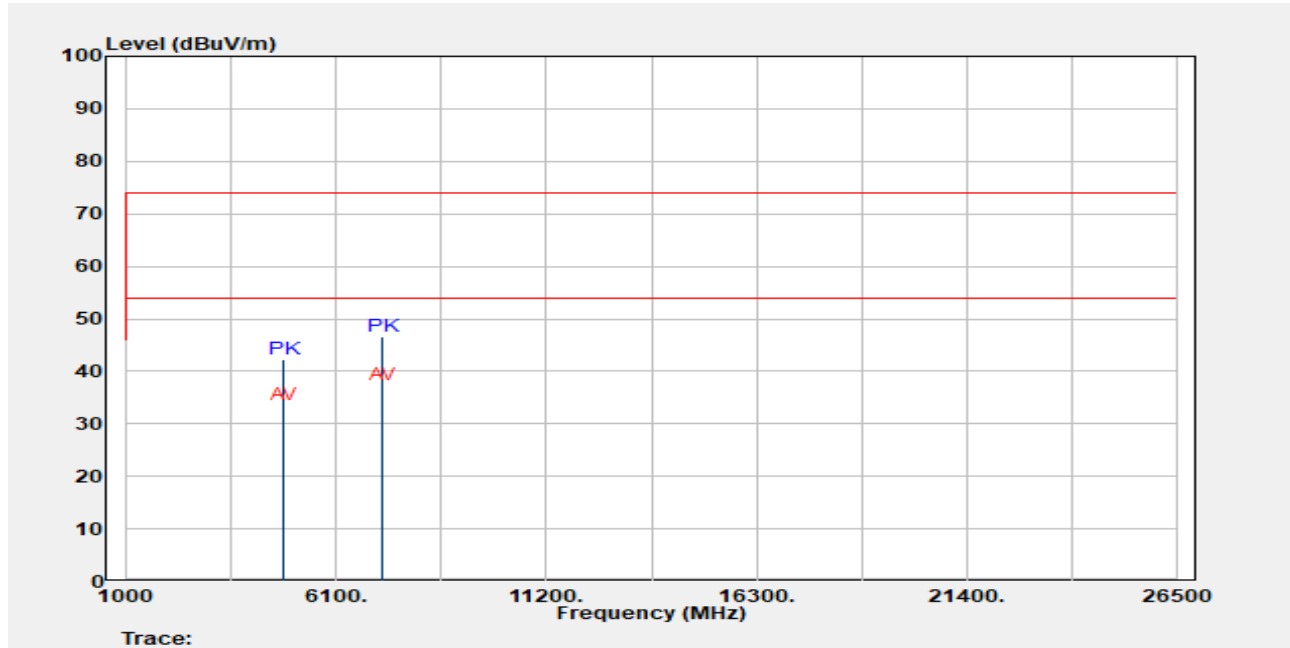

Trace:	Freq.	Detector Mode	Spectrum Reading Level	Factor	Actual FS	Limit @3m	Margin
	MHz	PK/QP/AV	dBuV	dB	dBuV/m	dBuV/m	dB
	4804.00	Peak	40.31	2.05	42.36	74.00	-31.64
	4804.00	Average	31.45	2.05	33.50	54.00	-20.50
	7206.00	Peak	39.10	7.50	46.60	74.00	-27.40
	7206.00	Average	29.96	7.50	37.46	54.00	-16.54

Unless otherwise stated the results shown in this test report refer only to the sample(s) tested and such sample(s) are retained for 90 days only.

除非另有說明，此報告結果僅對測試之樣品負責，同時此樣品僅保留90天。本報告未經本公司書面許可，不可部份複製。
 This document is issued by the Company subject to its General Conditions of Service printed overleaf, available on request or accessible at <http://www.sgs.com.tw/Terms-and-Conditions> and for electronic format documents, subject to Terms and Conditions for Electronic Documents at <http://www.sgs.com.tw/Terms-and-Conditions>. Attention is drawn to the limitation of liability, indemnification and jurisdiction issues defined therein. Any holder of this document is advised that information contained hereon reflects the Company's findings at the time of its intervention only and within the limits of Client's instructions, if any. The Company's sole responsibility is to its Client and this document does not exonerate parties to a transaction from exercising all their rights and obligations under the transaction documents. This document cannot be reproduced except in full, without prior written approval of the Company. Any unauthorized alteration, forgery or falsification of the content or appearance of this document is unlawful and offenders may be prosecuted to the fullest extent of the law.

Report Number :TERF2404001033ER
 Operation Mode :BLE 1M
 Test Frequency :2402 MHz
 Test Mode :Tx
 EUT Pol :E1 Plane

Test Site :SAC 2
 Test Date :2024-05-08
 Temp./Humi. :23.1°C/62%
 Antenna Pol. :Horizontal
 Engineer :Eason Wang

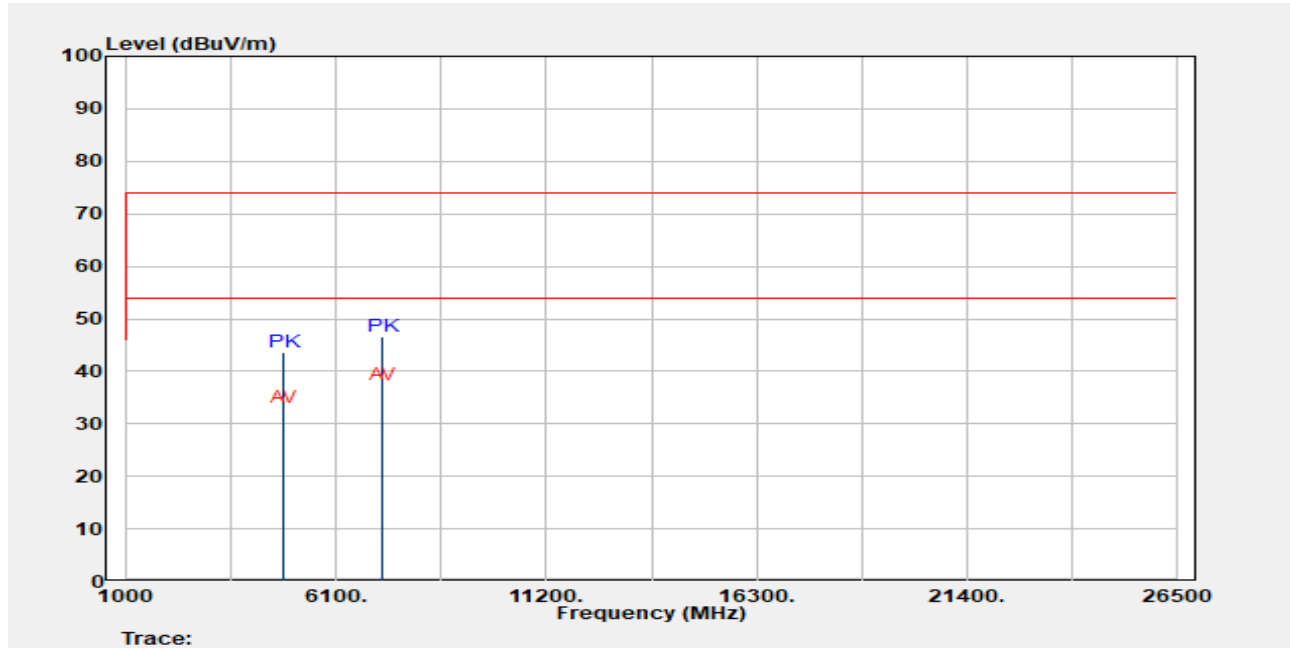

Freq. MHz	Detector Mode PK/QP/AV	Spectrum Reading Level dBμV	Factor dB	Actual FS dBμV/m	Limit @3m dBμV/m	Margin dB
4804.00	Peak	41.48	2.05	43.53	74.00	-30.47
4804.00	Average	30.99	2.05	33.04	54.00	-20.96
7206.00	Peak	39.15	7.50	46.65	74.00	-27.35
7206.00	Average	29.97	7.50	37.47	54.00	-16.53

Unless otherwise stated the results shown in this test report refer only to the sample(s) tested and such sample(s) are retained for 90 days only.

除非另有說明，此報告結果僅對測試之樣品負責，同時此樣品僅保留90天。本報告未經本公司書面許可，不可部份複製。

This document is issued by the Company subject to its General Conditions of Service printed overleaf, available on request or accessible at <http://www.sgs.com.tw/Terms-and-Conditions> and for electronic format documents, subject to Terms and Conditions for Electronic Documents at <http://www.sgs.com.tw/Terms-and-Conditions>. Attention is drawn to the limitation of liability, indemnification and jurisdiction issues defined therein. Any holder of this document is advised that information contained hereon reflects the Company's findings at the time of its intervention only and within the limits of Client's instructions, if any. The Company's sole responsibility is to its Client and this document does not exonerate parties to a transaction from exercising all their rights and obligations under the transaction documents. This document cannot be reproduced except in full, without prior written approval of the Company. Any unauthorized alteration, forgery or falsification of the content or appearance of this document is unlawful and offenders may be prosecuted to the fullest extent of the law.

Report Number :TERF2404001033ER
 Operation Mode :BLE 1M
 Test Frequency :2440 MHz
 Test Mode :Tx
 EUT Pol :E1 Plane

Test Site :SAC 2
 Test Date :2024-05-08
 Temp./Humi. :23.1°C/62%
 Antenna Pol. :Vertical
 Engineer :Eason Wang

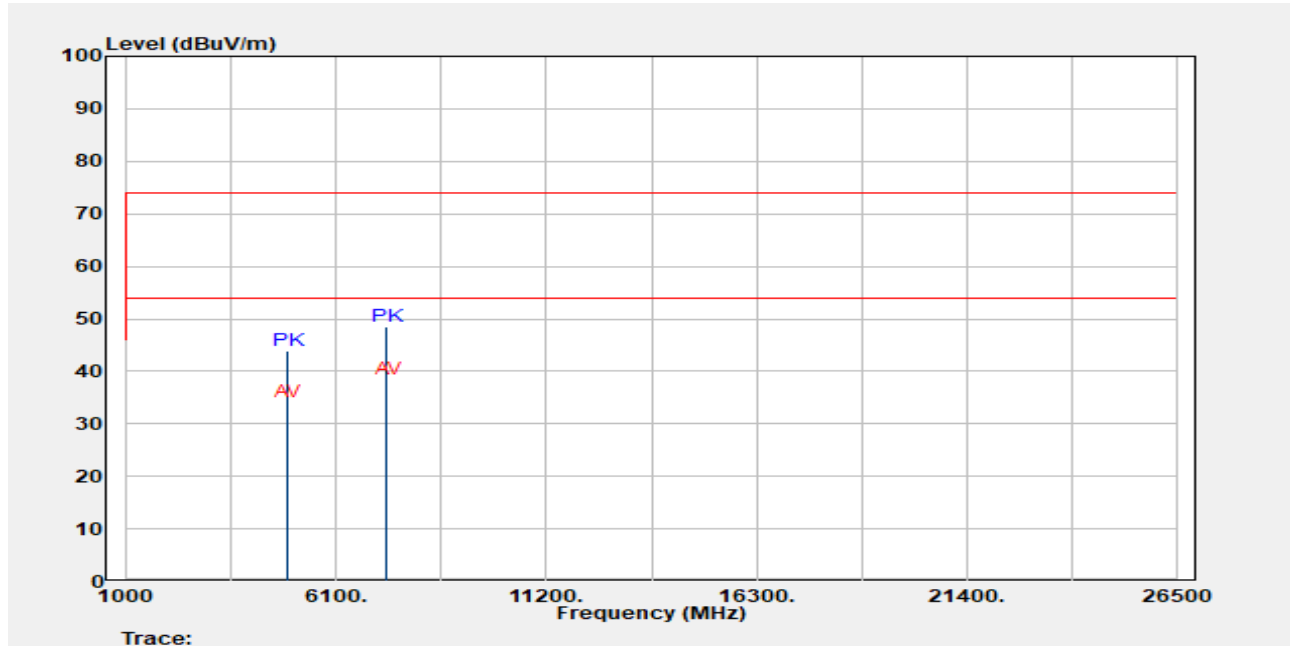

Freq. MHz	Detector Mode PK/QP/AV	Spectrum Reading Level dBμV	Factor dB	Actual FS dBμV/m	Limit @3m dBμV/m	Margin dB
4880.00	Peak	41.39	2.40	43.79	74.00	-30.21
4880.00	Average	31.77	2.40	34.17	54.00	-19.83
7320.00	Peak	40.76	7.84	48.60	74.00	-25.40
7320.00	Average	30.73	7.84	38.57	54.00	-15.43

Unless otherwise stated the results shown in this test report refer only to the sample(s) tested and such sample(s) are retained for 90 days only.

除非另有說明，此報告結果僅對測試之樣品負責，同時此樣品僅保留90天。本報告未經本公司書面許可，不可部份複製。

This document is issued by the Company subject to its General Conditions of Service printed overleaf, available on request or accessible at <http://www.sgs.com.tw/Terms-and-Conditions> and for electronic format documents, subject to Terms and Conditions for Electronic Documents at <http://www.sgs.com.tw/Terms-and-Conditions>. Attention is drawn to the limitation of liability, indemnification and jurisdiction issues defined therein. Any holder of this document is advised that information contained hereon reflects the Company's findings at the time of its intervention only and within the limits of Client's instructions, if any. The Company's sole responsibility is to its Client and this document does not exonerate parties to a transaction from exercising all their rights and obligations under the transaction documents. This document cannot be reproduced except in full, without prior written approval of the Company. Any unauthorized alteration, forgery or falsification of the content or appearance of this document is unlawful and offenders may be prosecuted to the fullest extent of the law.

Report Number :TERF2404001033ER
 Operation Mode :BLE 1M
 Test Frequency :2440 MHz
 Test Mode :Tx
 EUT Pol :E1 Plane

Test Site :SAC 2
 Test Date :2024-05-08
 Temp./Humi. :23.1°C/62%
 Antenna Pol. :Horizontal
 Engineer :Eason Wang

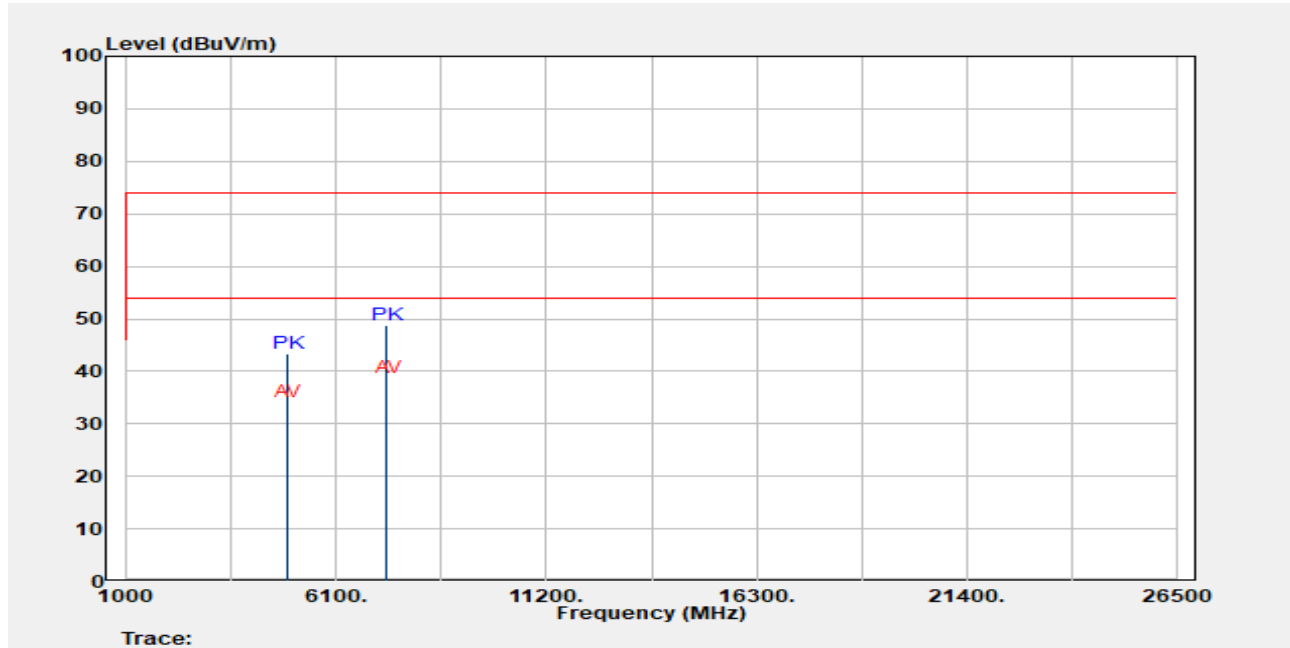

Freq. MHz	Detector Mode PK/QP/AV	Spectrum Reading Level dBμV	Factor dB	Actual FS dBμV/m	Limit @3m dBμV/m	Margin dB
4880.00	Peak	40.94	2.40	43.34	74.00	-30.66
4880.00	Average	31.63	2.40	34.03	54.00	-19.97
7320.00	Peak	40.99	7.84	48.83	74.00	-25.17
7320.00	Average	30.85	7.84	38.69	54.00	-15.31

Unless otherwise stated the results shown in this test report refer only to the sample(s) tested and such sample(s) are retained for 90 days only.

除非另有說明，此報告結果僅對測試之樣品負責，同時此樣品僅保留90天。本報告未經本公司書面許可，不可部份複製。

This document is issued by the Company subject to its General Conditions of Service printed overleaf, available on request or accessible at <http://www.sgs.com.tw/Terms-and-Conditions> and for electronic format documents, subject to Terms and Conditions for Electronic Documents at <http://www.sgs.com.tw/Terms-and-Conditions>. Attention is drawn to the limitation of liability, indemnification and jurisdiction issues defined therein. Any holder of this document is advised that information contained hereon reflects the Company's findings at the time of its intervention only and within the limits of Client's instructions, if any. The Company's sole responsibility is to its Client and this document does not exonerate parties to a transaction from exercising all their rights and obligations under the transaction documents. This document cannot be reproduced except in full, without prior written approval of the Company. Any unauthorized alteration, forgery or falsification of the content or appearance of this document is unlawful and offenders may be prosecuted to the fullest extent of the law.

JReport Number :TERF2404001033ER
 Operation Mode :BLE 1M
 Test Frequency :2480 MHz
 Test Mode :Tx
 EUT Pol :E1 Plane

Test Site :SAC 2
 Test Date :2024-05-08
 Temp./Humi. :23.1°C/62%
 Antenna Pol. :Vertical
 Engineer :Eason Wang

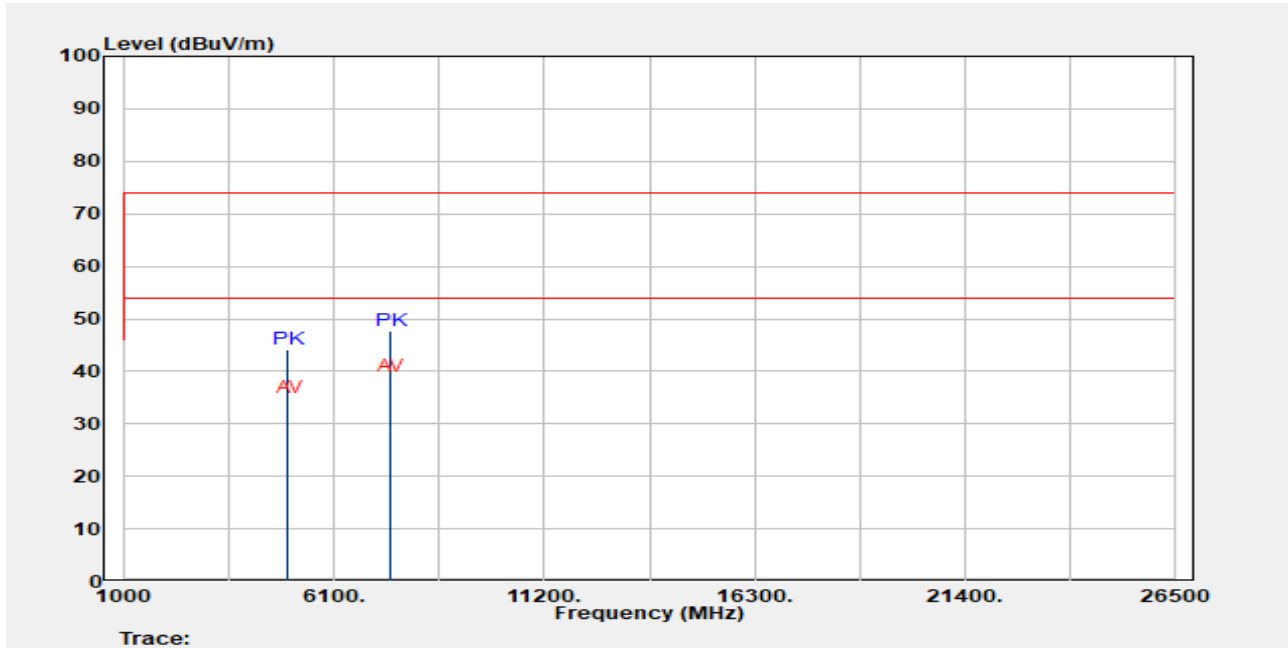

Freq. MHz	Detector Mode PK/QP/AV	Spectrum Reading Level dB μ V	Factor dB	Actual FS dB μ V/m	Limit @3m dB μ V/m	Margin dB
4960.00	Peak	41.24	2.84	44.08	74.00	-29.92
4960.00	Average	32.15	2.84	34.99	54.00	-19.01
7440.00	Peak	39.80	8.02	47.82	74.00	-26.18
7440.00	Average	31.03	8.02	39.05	54.00	-14.95

Unless otherwise stated the results shown in this test report refer only to the sample(s) tested and such sample(s) are retained for 90 days only.

除非另有說明，此報告結果僅對測試之樣品負責，同時此樣品僅保留90天。本報告未經本公司書面許可，不可部份複製。

This document is issued by the Company subject to its General Conditions of Service printed overleaf, available on request or accessible at <http://www.sgs.com.tw/Terms-and-Conditions> and for electronic format documents, subject to Terms and Conditions for Electronic Documents at <http://www.sgs.com.tw/Terms-and-Conditions>. Attention is drawn to the limitation of liability, indemnification and jurisdiction issues defined therein. Any holder of this document is advised that information contained hereon reflects the Company's findings at the time of its intervention only and within the limits of Client's instructions, if any. The Company's sole responsibility is to its Client and this document does not exonerate parties to a transaction from exercising all their rights and obligations under the transaction documents. This document cannot be reproduced except in full, without prior written approval of the Company. Any unauthorized alteration, forgery or falsification of the content or appearance of this document is unlawful and offenders may be prosecuted to the fullest extent of the law.

Report Number :TERF2404001033ER
 Operation Mode :BLE 1M
 Test Frequency :2480 MHz
 Test Mode :Tx
 EUT Pol :E1 Plane

Test Site :SAC 2
 Test Date :2024-05-08
 Temp./Humi. :23.1°C/62%
 Antenna Pol. :Horizontal
 Engineer :Eason Wang

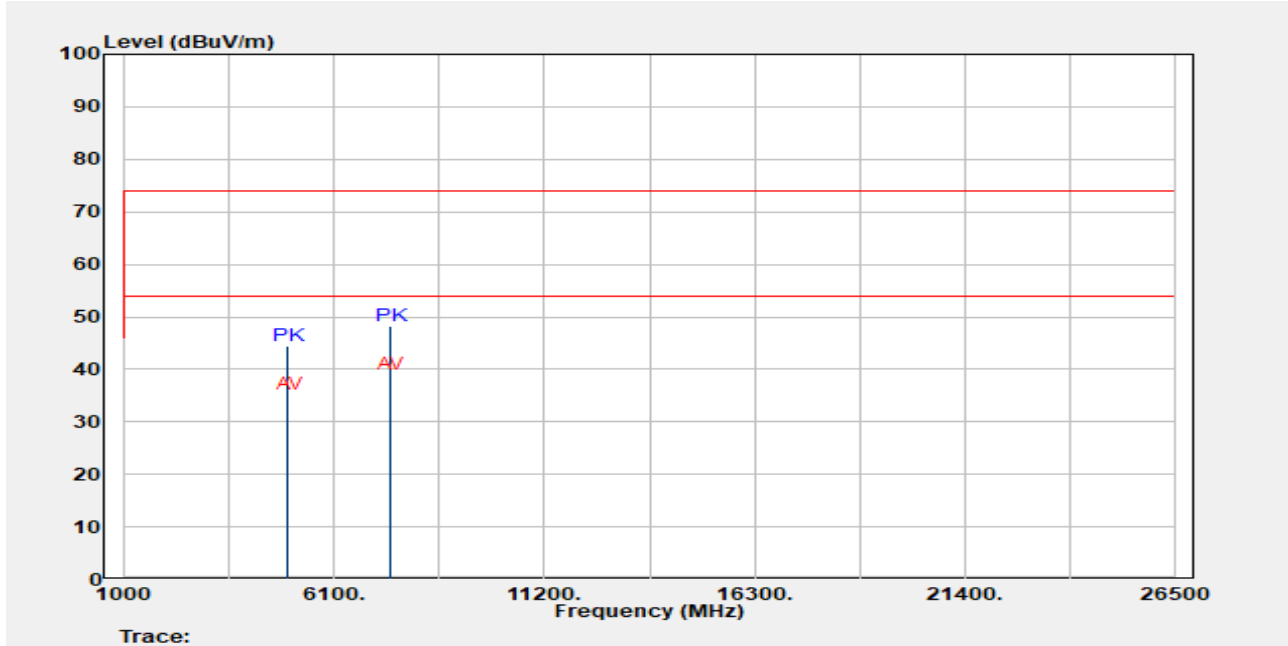

Freq. MHz	Detector Mode PK/QP/AV	Spectrum Reading Level dBμV	Factor dB	Actual FS dBμV/m	Limit @3m dBμV/m	Margin dB
4960.00	Peak	41.63	2.84	44.47	74.00	-29.53
4960.00	Average	32.40	2.84	35.24	54.00	-18.76
7440.00	Peak	40.34	8.02	48.36	74.00	-25.64
7440.00	Average	31.14	8.02	39.16	54.00	-14.84

Unless otherwise stated the results shown in this test report refer only to the sample(s) tested and such sample(s) are retained for 90 days only.

除非另有說明，此報告結果僅對測試之樣品負責，同時此樣品僅保留90天。本報告未經本公司書面許可，不可部份複製。

This document is issued by the Company subject to its General Conditions of Service printed overleaf, available on request or accessible at <http://www.sgs.com.tw/Terms-and-Conditions> and for electronic format documents, subject to Terms and Conditions for Electronic Documents at <http://www.sgs.com.tw/Terms-and-Conditions>. Attention is drawn to the limitation of liability, indemnification and jurisdiction issues defined therein. Any holder of this document is advised that information contained hereon reflects the Company's findings at the time of its intervention only and within the limits of Client's instructions, if any. The Company's sole responsibility is to its Client and this document does not exonerate parties to a transaction from exercising all their rights and obligations under the transaction documents. This document cannot be reproduced except in full, without prior written approval of the Company. Any unauthorized alteration, forgery or falsification of the content or appearance of this document is unlawful and offenders may be prosecuted to the fullest extent of the law.

Report Number :TERF2404001033ER
 Operation Mode :BLE 2M
 Test Frequency :2402 MHz
 Test Mode :Tx
 EUT Pol :E1 Plane

Test Site :SAC 2
 Test Date :2024-05-08
 Temp./Humi. :23.1°C/62%
 Antenna Pol. :Vertical
 Engineer :Eason Wang

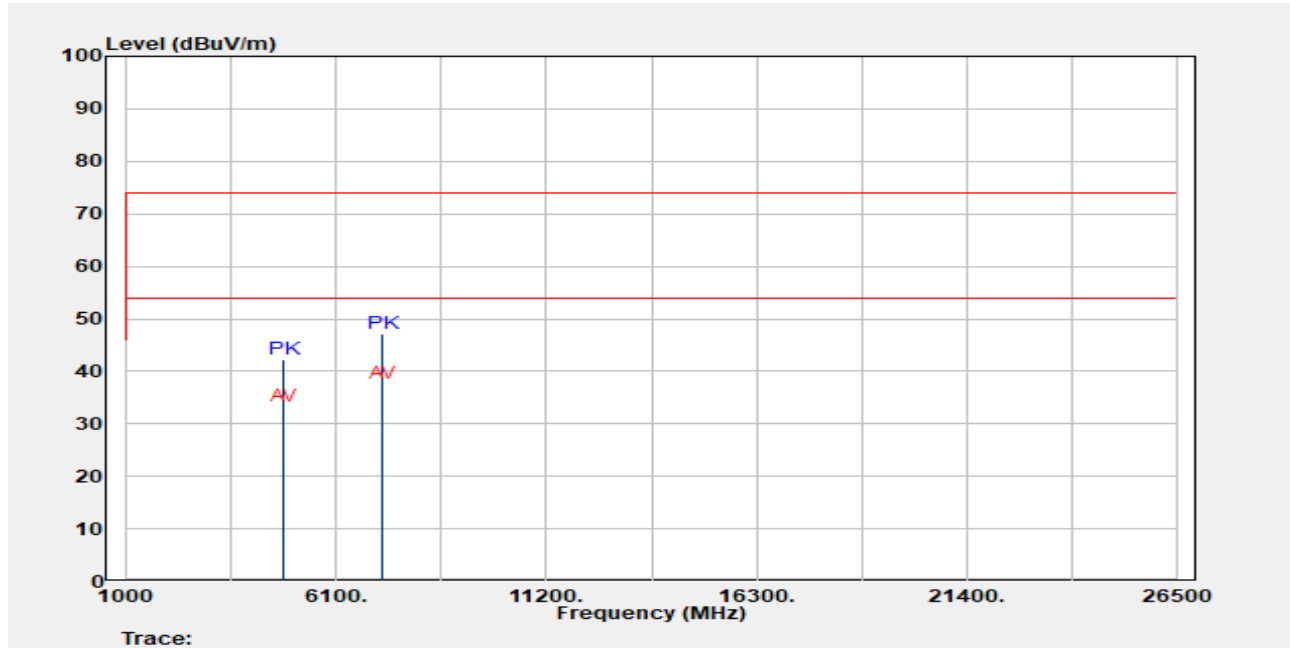

Trace:	Freq. MHz	Detector Mode PK/QP/AV	Spectrum Reading Level dBμV	Factor dB	Actual FS dBμV/m	Limit @3m dBμV/m	Margin dB
	4804.00	Peak	40.11	2.05	42.16	74.00	-31.84
	4804.00	Average	31.17	2.05	33.22	54.00	-20.78
	7206.00	Peak	39.57	7.50	47.07	74.00	-26.93
	7206.00	Average	30.26	7.50	37.76	54.00	-16.24

Unless otherwise stated the results shown in this test report refer only to the sample(s) tested and such sample(s) are retained for 90 days only.

除非另有說明，此報告結果僅對測試之樣品負責，同時此樣品僅保留90天。本報告未經本公司書面許可，不可部份複製。

This document is issued by the Company subject to its General Conditions of Service printed overleaf, available on request or accessible at <http://www.sgs.com.tw/Terms-and-Conditions> and for electronic format documents, subject to Terms and Conditions for Electronic Documents at <http://www.sgs.com.tw/Terms-and-Conditions>. Attention is drawn to the limitation of liability, indemnification and jurisdiction issues defined therein. Any holder of this document is advised that information contained hereon reflects the Company's findings at the time of its intervention only and within the limits of Client's instructions, if any. The Company's sole responsibility is to its Client and this document does not exonerate parties to a transaction from exercising all their rights and obligations under the transaction documents. This document cannot be reproduced except in full, without prior written approval of the Company. Any unauthorized alteration, forgery or falsification of the content or appearance of this document is unlawful and offenders may be prosecuted to the fullest extent of the law.

Report Number :TERF2404001033ER
 Operation Mode :BLE 2M
 Test Frequency :2402 MHz
 Test Mode :Tx
 EUT Pol :E1 Plane

Test Site :SAC 2
 Test Date :2024-05-08
 Temp./Humi. :23.1°C/62%
 Antenna Pol. :Horizontal
 Engineer :Eason Wang

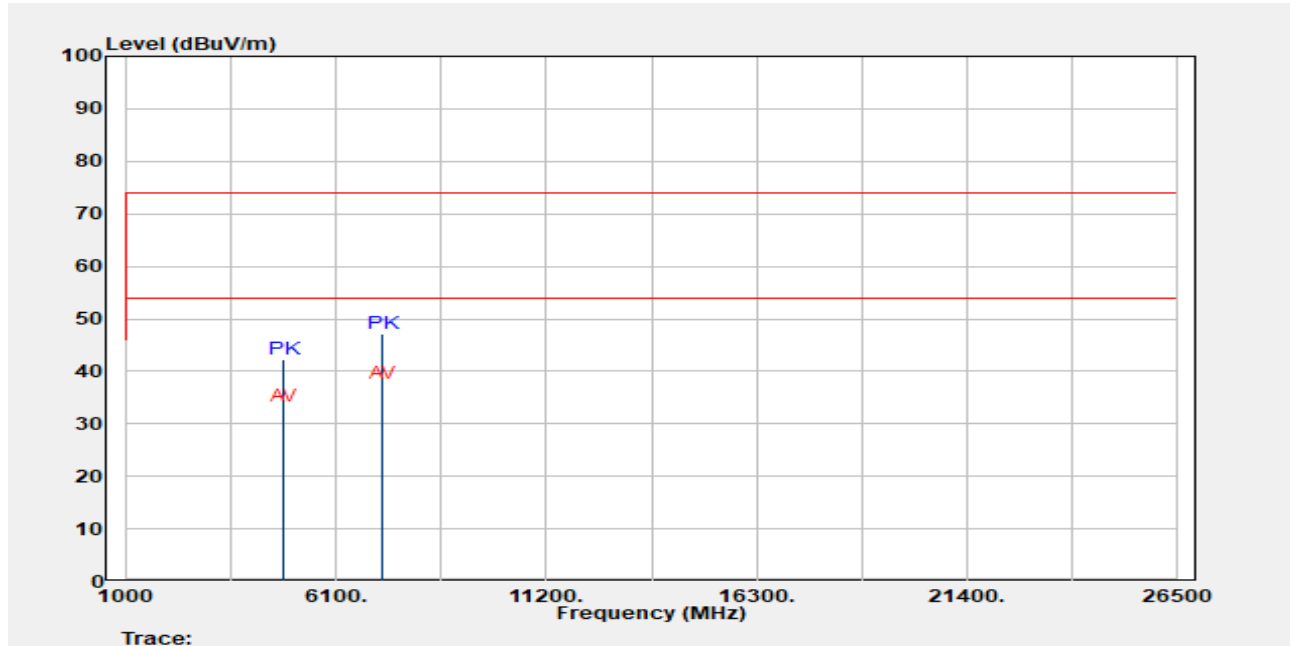

Freq. MHz	Detector Mode PK/QP/AV	Spectrum Reading Level dBμV	Factor dB	Actual FS dBμV/m	Limit @3m dBμV/m	Margin dB
4804.00	Peak	40.35	2.05	42.40	74.00	-31.60
4804.00	Average	31.22	2.05	33.27	54.00	-20.73
7206.00	Peak	39.62	7.50	47.12	74.00	-26.88
7206.00	Average	30.20	7.50	37.70	54.00	-16.30

Unless otherwise stated the results shown in this test report refer only to the sample(s) tested and such sample(s) are retained for 90 days only.

除非另有說明，此報告結果僅對測試之樣品負責，同時此樣品僅保留90天。本報告未經本公司書面許可，不可部份複製。

This document is issued by the Company subject to its General Conditions of Service printed overleaf, available on request or accessible at <http://www.sgs.com.tw/Terms-and-Conditions> and for electronic format documents, subject to Terms and Conditions for Electronic Documents at <http://www.sgs.com.tw/Terms-and-Conditions>. Attention is drawn to the limitation of liability, indemnification and jurisdiction issues defined therein. Any holder of this document is advised that information contained hereon reflects the Company's findings at the time of its intervention only and within the limits of Client's instructions, if any. The Company's sole responsibility is to its Client and this document does not exonerate parties to a transaction from exercising all their rights and obligations under the transaction documents. This document cannot be reproduced except in full, without prior written approval of the Company. Any unauthorized alteration, forgery or falsification of the content or appearance of this document is unlawful and offenders may be prosecuted to the fullest extent of the law.

Report Number :TERF2404001033ER
 Operation Mode :BLE 2M
 Test Frequency :2440 MHz
 Test Mode :Tx
 EUT Pol :E1 Plane

Test Site :SAC 2
 Test Date :2024-05-08
 Temp./Humi. :23.1°C/62%
 Antenna Pol. :Vertical
 Engineer :Eason Wang

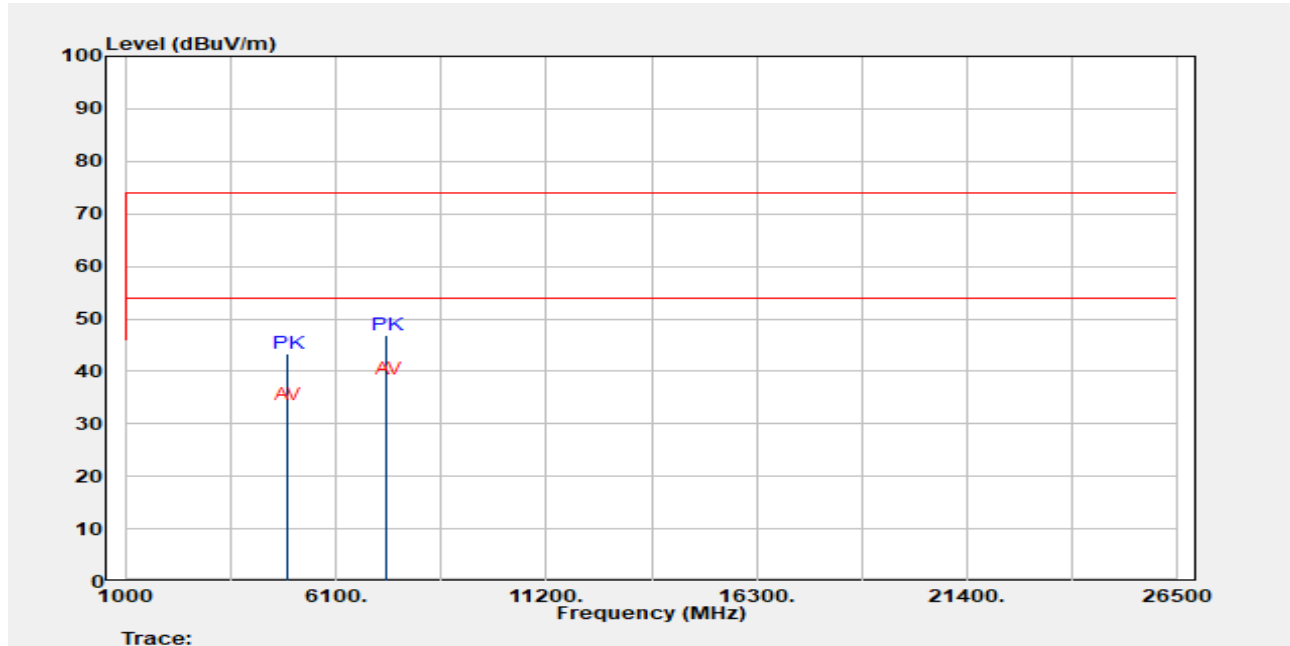

Freq. MHz	Detector Mode PK/QP/AV	Spectrum Reading Level dBμV	Factor dB	Actual FS dBμV/m	Limit @3m dBμV/m	Margin dB
4880.00	Peak	40.88	2.40	43.28	74.00	-30.72
4880.00	Average	31.31	2.40	33.71	54.00	-20.29
7320.00	Peak	39.07	7.84	46.91	74.00	-27.09
7320.00	Average	30.52	7.84	38.36	54.00	-15.64

Unless otherwise stated the results shown in this test report refer only to the sample(s) tested and such sample(s) are retained for 90 days only.

除非另有說明，此報告結果僅對測試之樣品負責，同時此樣品僅保留90天。本報告未經本公司書面許可，不可部份複製。

This document is issued by the Company subject to its General Conditions of Service printed overleaf, available on request or accessible at <http://www.sgs.com.tw/Terms-and-Conditions> and for electronic format documents, subject to Terms and Conditions for Electronic Documents at <http://www.sgs.com.tw/Terms-and-Conditions>. Attention is drawn to the limitation of liability, indemnification and jurisdiction issues defined therein. Any holder of this document is advised that information contained hereon reflects the Company's findings at the time of its intervention only and within the limits of Client's instructions, if any. The Company's sole responsibility is to its Client and this document does not exonerate parties to a transaction from exercising all their rights and obligations under the transaction documents. This document cannot be reproduced except in full, without prior written approval of the Company. Any unauthorized alteration, forgery or falsification of the content or appearance of this document is unlawful and offenders may be prosecuted to the fullest extent of the law.

Report Number :TERF2404001033ER
 Operation Mode :BLE 2M
 Test Frequency :2440 MHz
 Test Mode :Tx
 EUT Pol :E1 Plane

Test Site :SAC 2
 Test Date :2024-05-08
 Temp./Humi. :23.1°C/62%
 Antenna Pol. :Horizontal
 Engineer :Eason Wang

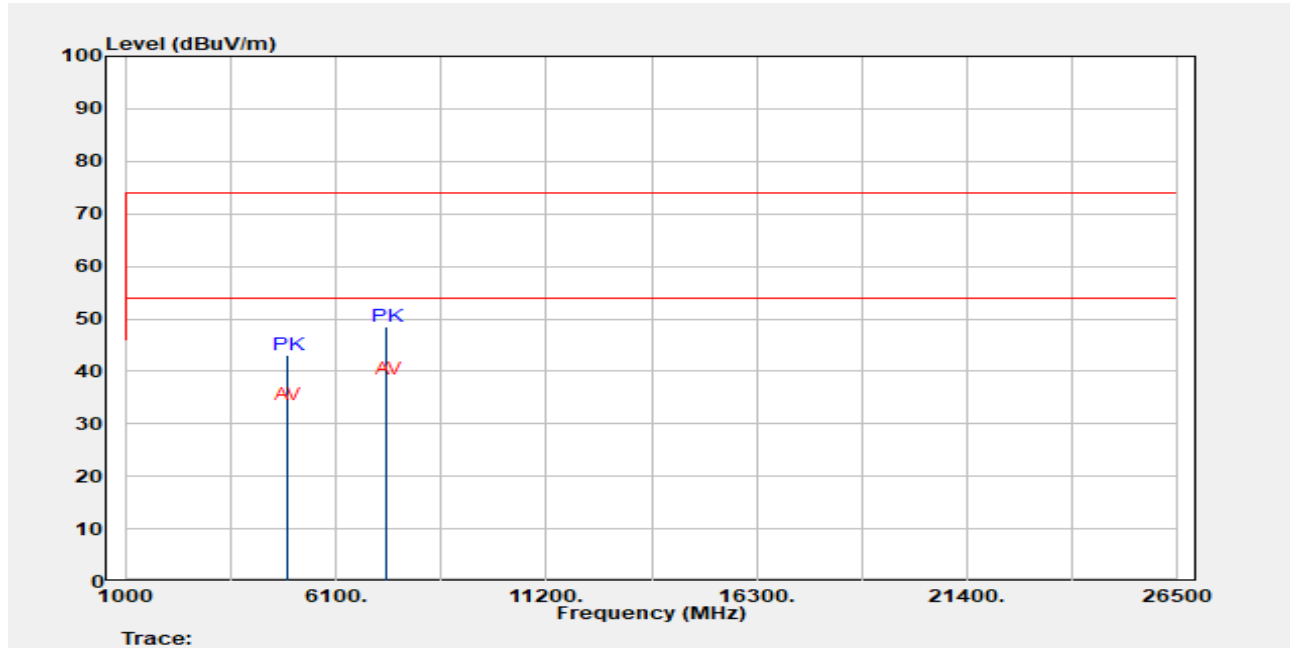

Freq. MHz	Detector Mode PK/QP/AV	Spectrum Reading Level dBμV	Factor dB	Actual FS dBμV/m	Limit @3m dBμV/m	Margin dB
4880.00	Peak	40.74	2.40	43.14	74.00	-30.86
4880.00	Average	31.32	2.40	33.72	54.00	-20.28
7320.00	Peak	40.56	7.84	48.40	74.00	-25.60
7320.00	Average	30.55	7.84	38.39	54.00	-15.61

Unless otherwise stated the results shown in this test report refer only to the sample(s) tested and such sample(s) are retained for 90 days only.

除非另有說明，此報告結果僅對測試之樣品負責，同時此樣品僅保留90天。本報告未經本公司書面許可，不可部份複製。

This document is issued by the Company subject to its General Conditions of Service printed overleaf, available on request or accessible at <http://www.sgs.com.tw/Terms-and-Conditions> and for electronic format documents, subject to Terms and Conditions for Electronic Documents at <http://www.sgs.com.tw/Terms-and-Conditions>. Attention is drawn to the limitation of liability, indemnification and jurisdiction issues defined therein. Any holder of this document is advised that information contained hereon reflects the Company's findings at the time of its intervention only and within the limits of Client's instructions, if any. The Company's sole responsibility is to its Client and this document does not exonerate parties to a transaction from exercising all their rights and obligations under the transaction documents. This document cannot be reproduced except in full, without prior written approval of the Company. Any unauthorized alteration, forgery or falsification of the content or appearance of this document is unlawful and offenders may be prosecuted to the fullest extent of the law.

Report Number :TERF2404001033ER
 Operation Mode :BLE 2M
 Test Frequency :2480 MHz
 Test Mode :Tx
 EUT Pol :E1 Plane

Test Site :SAC 2
 Test Date :2024-05-08
 Temp./Humi. :23.1°C/62%
 Antenna Pol. :Vertical
 Engineer :Eason Wang

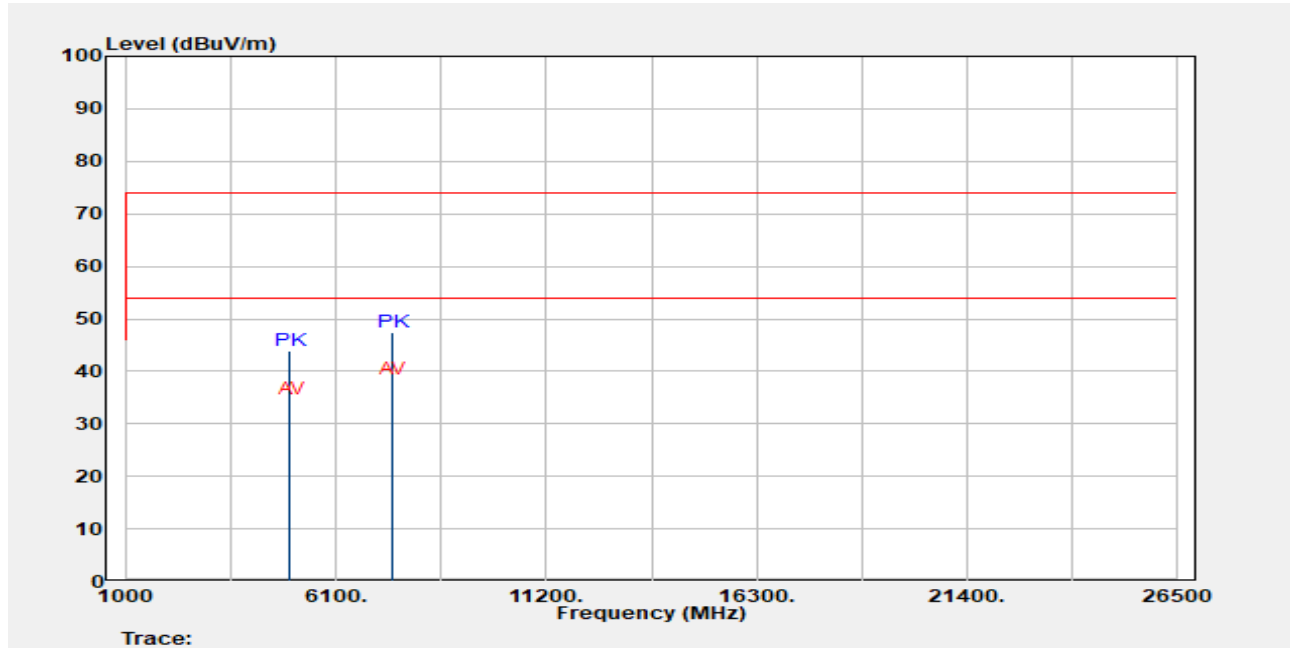

Freq. MHz	Detector Mode PK/QP/AV	Spectrum Reading Level dBμV	Factor dB	Actual FS dBμV/m	Limit @3m dBμV/m	Margin dB
4960.00	Peak	41.16	2.84	44.00	74.00	-30.00
4960.00	Average	31.76	2.84	34.60	54.00	-19.40
7440.00	Peak	39.28	8.02	47.30	74.00	-26.70
7440.00	Average	30.53	8.02	38.55	54.00	-15.45

Unless otherwise stated the results shown in this test report refer only to the sample(s) tested and such sample(s) are retained for 90 days only.

除非另有說明，此報告結果僅對測試之樣品負責，同時此樣品僅保留90天。本報告未經本公司書面許可，不可部份複製。

This document is issued by the Company subject to its General Conditions of Service printed overleaf, available on request or accessible at <http://www.sgs.com.tw/Terms-and-Conditions> and for electronic format documents, subject to Terms and Conditions for Electronic Documents at <http://www.sgs.com.tw/Terms-and-Conditions>. Attention is drawn to the limitation of liability, indemnification and jurisdiction issues defined therein. Any holder of this document is advised that information contained hereon reflects the Company's findings at the time of its intervention only and within the limits of Client's instructions, if any. The Company's sole responsibility is to its Client and this document does not exonerate parties to a transaction from exercising all their rights and obligations under the transaction documents. This document cannot be reproduced except in full, without prior written approval of the Company. Any unauthorized alteration, forgery or falsification of the content or appearance of this document is unlawful and offenders may be prosecuted to the fullest extent of the law.

Report Number :TERF2404001033ER
 Operation Mode :BLE 2M
 Test Frequency :2480 MHz
 Test Mode :Tx
 EUT Pol :E1 Plane

Test Site :SAC 2
 Test Date :2024-05-08
 Temp./Humi. :23.1°C/62%
 Antenna Pol. :Horizontal
 Engineer :Eason Wang

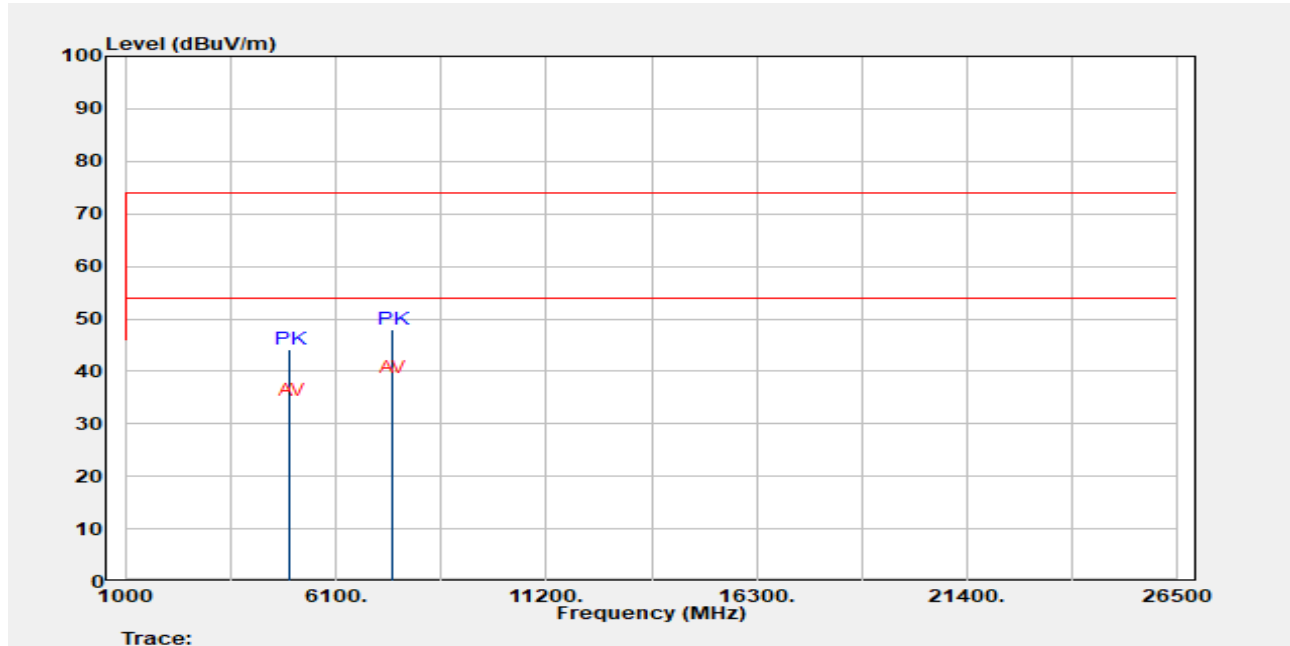

Freq. MHz	Detector Mode PK/QP/AV	Spectrum Reading Level dBμV	Factor dB	Actual FS dBμV/m	Limit @3m dBμV/m	Margin dB
4960.00	Peak	41.33	2.84	44.17	74.00	-29.83
4960.00	Average	31.52	2.84	34.36	54.00	-19.64
7440.00	Peak	39.94	8.02	47.96	74.00	-26.04
7440.00	Average	30.68	8.02	38.70	54.00	-15.30

Unless otherwise stated the results shown in this test report refer only to the sample(s) tested and such sample(s) are retained for 90 days only.

除非另有說明，此報告結果僅對測試之樣品負責，同時此樣品僅保留90天。本報告未經本公司書面許可，不可部份複製。

This document is issued by the Company subject to its General Conditions of Service printed overleaf, available on request or accessible at <http://www.sgs.com.tw/Terms-and-Conditions> and for electronic format documents, subject to Terms and Conditions for Electronic Documents at <http://www.sgs.com.tw/Terms-and-Conditions>. Attention is drawn to the limitation of liability, indemnification and jurisdiction issues defined therein. Any holder of this document is advised that information contained hereon reflects the Company's findings at the time of its intervention only and within the limits of Client's instructions, if any. The Company's sole responsibility is to its Client and this document does not exonerate parties to a transaction from exercising all their rights and obligations under the transaction documents. This document cannot be reproduced except in full, without prior written approval of the Company. Any unauthorized alteration, forgery or falsification of the content or appearance of this document is unlawful and offenders may be prosecuted to the fullest extent of the law.

Report Number :TERF2404001033ER
 Operation Mode :BLE PHY=8
 Test Frequency :2402 MHz
 Test Mode :Tx
 EUT Pol :E1 Plane

Test Site :SAC 2
 Test Date :2024-05-08
 Temp./Humi. :23.1°C/62%
 Antenna Pol. :Vertical
 Engineer :Eason Wang

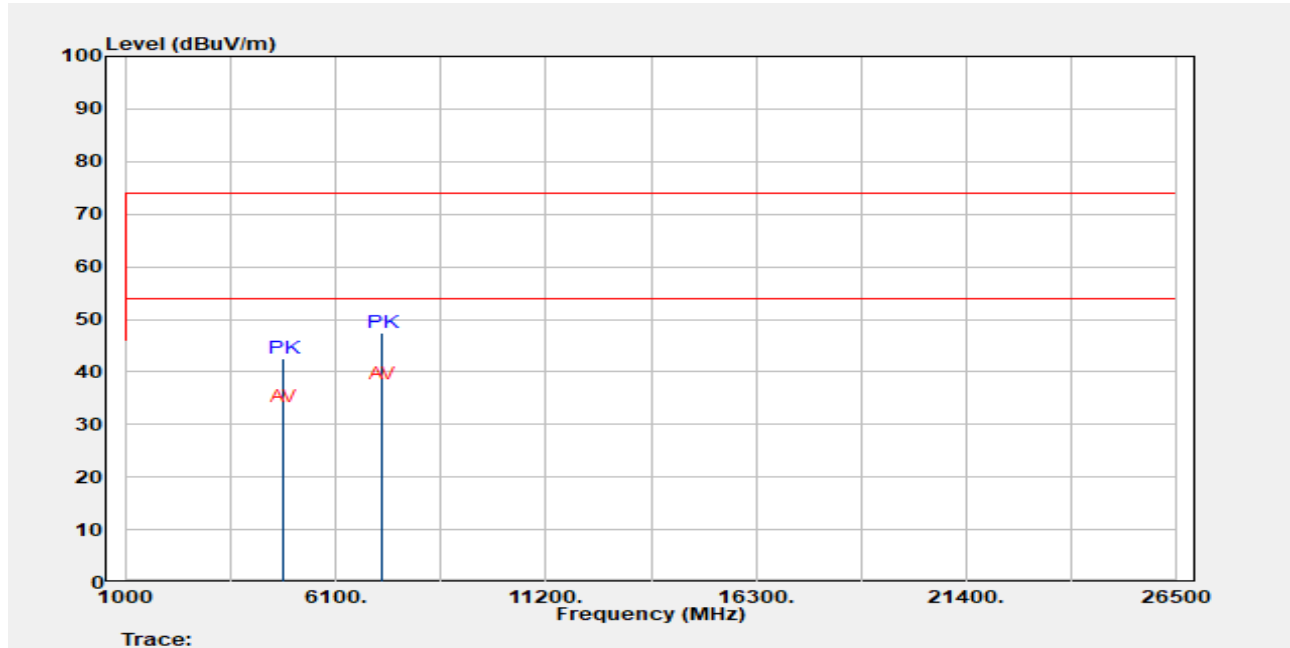

Freq. MHz	Detector Mode PK/QP/AV	Spectrum Reading Level dBuV	Factor dB	Actual FS dBuV/m	Limit @3m dBuV/m	Margin dB
4804.000	Peak	40.44	2.05	42.49	74.00	-31.51
4804.000	Average	31.29	2.05	33.34	54.00	-20.66
7206.000	Peak	39.79	7.50	47.29	74.00	-26.71
7206.000	Average	30.22	7.50	37.72	54.00	-16.28

Unless otherwise stated the results shown in this test report refer only to the sample(s) tested and such sample(s) are retained for 90 days only.

除非另有說明，此報告結果僅對測試之樣品負責，同時此樣品僅保留90天。本報告未經本公司書面許可，不可部份複製。

This document is issued by the Company subject to its General Conditions of Service printed overleaf, available on request or accessible at <http://www.sgs.com.tw/Terms-and-Conditions> and for electronic format documents, subject to Terms and Conditions for Electronic Documents at <http://www.sgs.com.tw/Terms-and-Conditions>. Attention is drawn to the limitation of liability, indemnification and jurisdiction issues defined therein. Any holder of this document is advised that information contained hereon reflects the Company's findings at the time of its intervention only and within the limits of Client's instructions, if any. The Company's sole responsibility is to its Client and this document does not exonerate parties to a transaction from exercising all their rights and obligations under the transaction documents. This document cannot be reproduced except in full, without prior written approval of the Company. Any unauthorized alteration, forgery or falsification of the content or appearance of this document is unlawful and offenders may be prosecuted to the fullest extent of the law.

Report Number :TERF2404001033ER
 Operation Mode :BLE PHY=8
 Test Frequency :2402 MHz
 Test Mode :Tx
 EUT Pol :E1 Plane

Test Site :SAC 2
 Test Date :2024-05-08
 Temp./Humi. :23.1°C/62%
 Antenna Pol. :Horizontal
 Engineer :Eason Wang

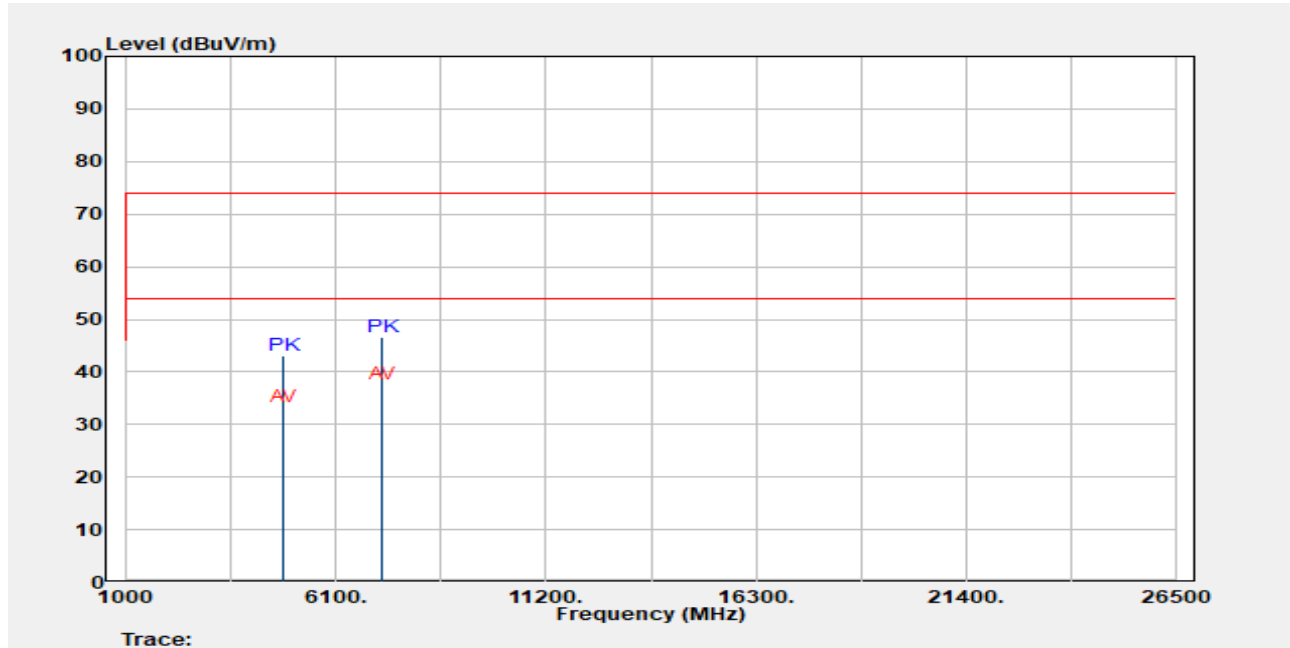

Trace:	Freq.	Detector Mode	Spectrum Reading Level	Factor	Actual FS	Limit @3m	Margin
	MHz	PK/QP/AV	dBuV	dB	dBuV/m	dBuV/m	dB
	4804.000	Peak	40.95	2.05	43.00	74.00	-31.00
	4804.000	Average	31.28	2.05	33.33	54.00	-20.67
	7206.000	Peak	39.21	7.50	46.72	74.00	-27.28
	7206.000	Average	30.28	7.50	37.78	54.00	-16.22

Unless otherwise stated the results shown in this test report refer only to the sample(s) tested and such sample(s) are retained for 90 days only.

除非另有說明，此報告結果僅對測試之樣品負責，同時此樣品僅保留90天。本報告未經本公司書面許可，不可部份複製。

This document is issued by the Company subject to its General Conditions of Service printed overleaf, available on request or accessible at <http://www.sgs.com.tw/Terms-and-Conditions> and for electronic format documents, subject to Terms and Conditions for Electronic Documents at <http://www.sgs.com.tw/Terms-and-Conditions>. Attention is drawn to the limitation of liability, indemnification and jurisdiction issues defined therein. Any holder of this document is advised that information contained hereon reflects the Company's findings at the time of its intervention only and within the limits of Client's instructions, if any. The Company's sole responsibility is to its Client and this document does not exonerate parties to a transaction from exercising all their rights and obligations under the transaction documents. This document cannot be reproduced except in full, without prior written approval of the Company. Any unauthorized alteration, forgery or falsification of the content or appearance of this document is unlawful and offenders may be prosecuted to the fullest extent of the law.

Report Number :TERF2404001033ER
 Operation Mode :BLE PHY=8
 Test Frequency :2440 MHz
 Test Mode :Tx
 EUT Pol :E1 Plane

Test Site :SAC 2
 Test Date :2024-05-08
 Temp./Humi. :23.1°C/62%
 Antenna Pol. :Vertical
 Engineer :Eason Wang

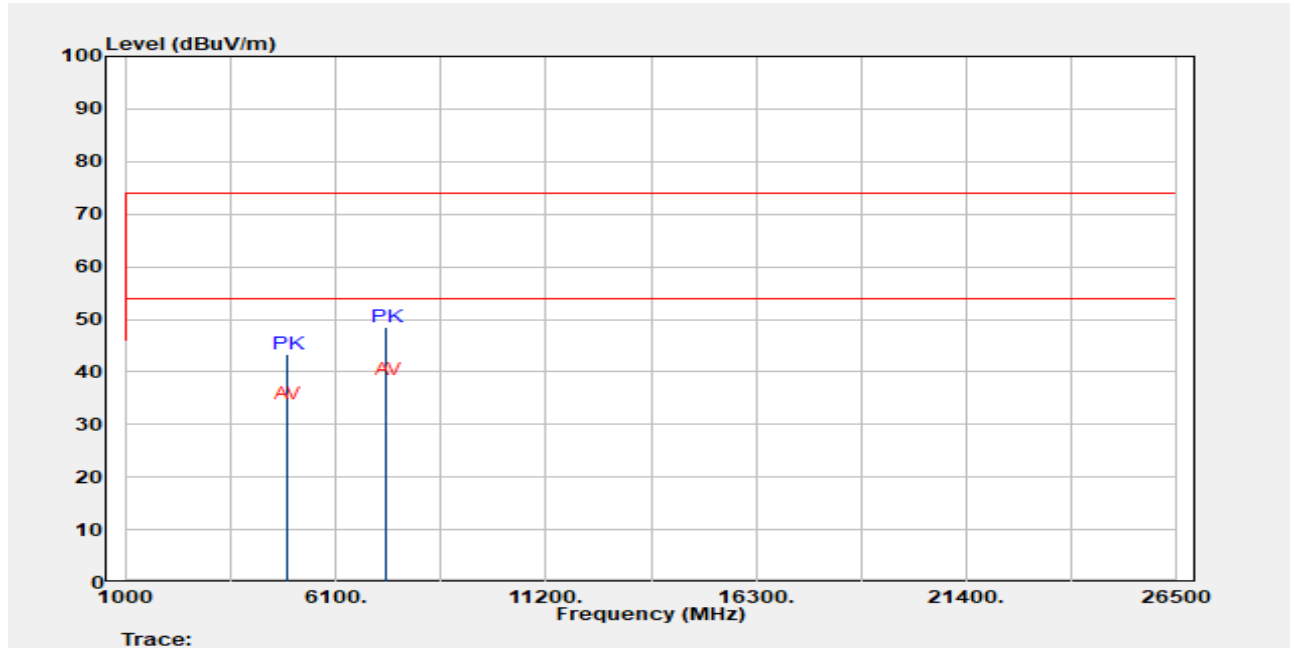

Freq. MHz	Detector Mode PK/QP/AV	Spectrum Reading Level dBμV	Factor dB	Actual FS dBμV/m	Limit @3m dBμV/m	Margin dB
4880.000	Peak	41.01	2.40	43.41	74.00	-30.59
4880.000	Average	31.39	2.40	33.79	54.00	-20.21
7320.000	Peak	40.58	7.84	48.42	74.00	-25.58
7320.000	Average	30.52	7.84	38.36	54.00	-15.64

Unless otherwise stated the results shown in this test report refer only to the sample(s) tested and such sample(s) are retained for 90 days only.

除非另有說明，此報告結果僅對測試之樣品負責，同時此樣品僅保留90天。本報告未經本公司書面許可，不可部份複製。
 This document is issued by the Company subject to its General Conditions of Service printed overleaf, available on request or accessible at <http://www.sgs.com.tw/Terms-and-Conditions> and for electronic format documents, subject to Terms and Conditions for Electronic Documents at <http://www.sgs.com.tw/Terms-and-Conditions>. Attention is drawn to the limitation of liability, indemnification and jurisdiction issues defined therein. Any holder of this document is advised that information contained hereon reflects the Company's findings at the time of its intervention only and within the limits of Client's instructions, if any. The Company's sole responsibility is to its Client and this document does not exonerate parties to a transaction from exercising all their rights and obligations under the transaction documents. This document cannot be reproduced except in full, without prior written approval of the Company. Any unauthorized alteration, forgery or falsification of the content or appearance of this document is unlawful and offenders may be prosecuted to the fullest extent of the law.

Report Number :TERF2404001033ER
 Operation Mode :BLE PHY=8
 Test Frequency :2440 MHz
 Test Mode :Tx
 EUT Pol :E1 Plane

Test Site :SAC 2
 Test Date :2024-05-08
 Temp./Humi. :23.1°C/62%
 Antenna Pol. :Horizontal
 Engineer :Eason Wang

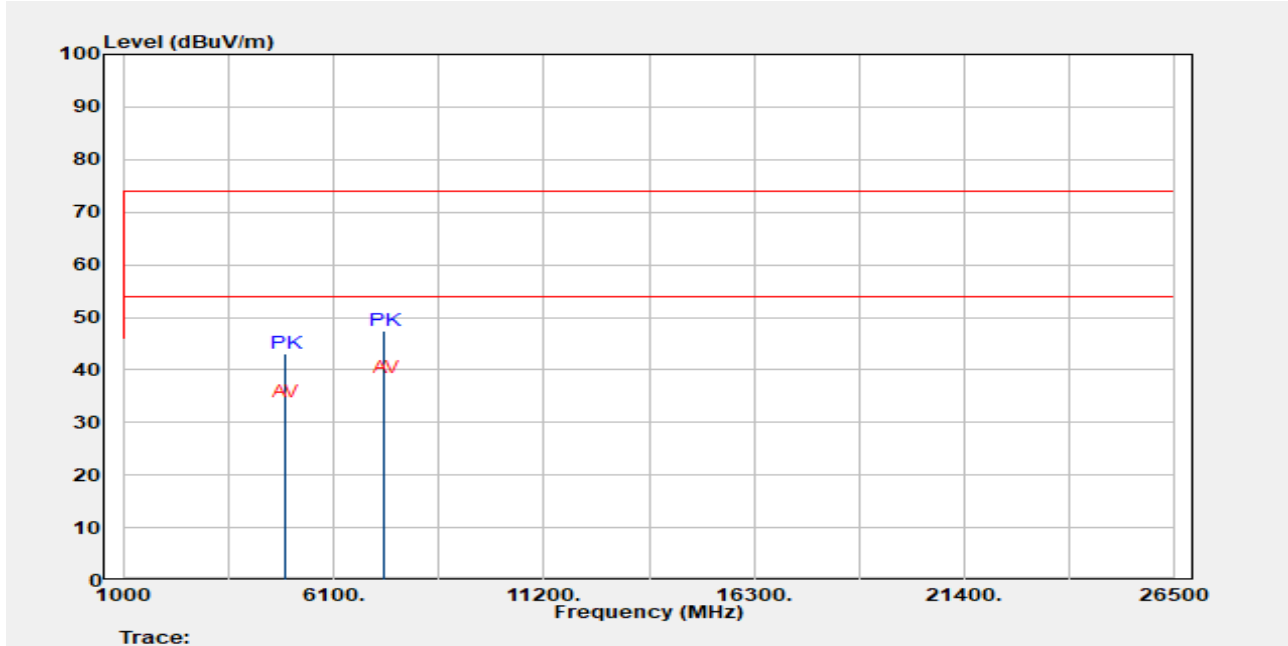

Trace:	Freq.	Detector Mode	Spectrum Reading Level	Factor	Actual FS	Limit @3m	Margin
	MHz	PK/QP/AV	dBμV	dB	dBμV/m	dBμV/m	dB
	4880.000	Peak	40.64	2.40	43.04	74.00	-30.96
	4880.000	Average	31.38	2.40	33.78	54.00	-20.22
	7320.000	Peak	39.67	7.84	47.51	74.00	-26.49
	7320.000	Average	30.63	7.84	38.47	54.00	-15.53

Unless otherwise stated the results shown in this test report refer only to the sample(s) tested and such sample(s) are retained for 90 days only.

除非另有說明，此報告結果僅對測試之樣品負責，同時此樣品僅保留90天。本報告未經本公司書面許可，不可部份複製。

This document is issued by the Company subject to its General Conditions of Service printed overleaf, available on request or accessible at <http://www.sgs.com.tw/Terms-and-Conditions> and for electronic format documents, subject to Terms and Conditions for Electronic Documents at <http://www.sgs.com.tw/Terms-and-Conditions>. Attention is drawn to the limitation of liability, indemnification and jurisdiction issues defined therein. Any holder of this document is advised that information contained hereon reflects the Company's findings at the time of its intervention only and within the limits of Client's instructions, if any. The Company's sole responsibility is to its Client and this document does not exonerate parties to a transaction from exercising all their rights and obligations under the transaction documents. This document cannot be reproduced except in full, without prior written approval of the Company. Any unauthorized alteration, forgery or falsification of the content or appearance of this document is unlawful and offenders may be prosecuted to the fullest extent of the law.

Report Number :TERF2404001033ER
 Operation Mode :BLE PHY=8
 Test Frequency :2480 MHz
 Test Mode :Tx
 EUT Pol :E1 Plane

Test Site :SAC 2
 Test Date :2024-05-08
 Temp./Humi. :23.1°C/62%
 Antenna Pol. :Vertical
 Engineer :Eason Wang

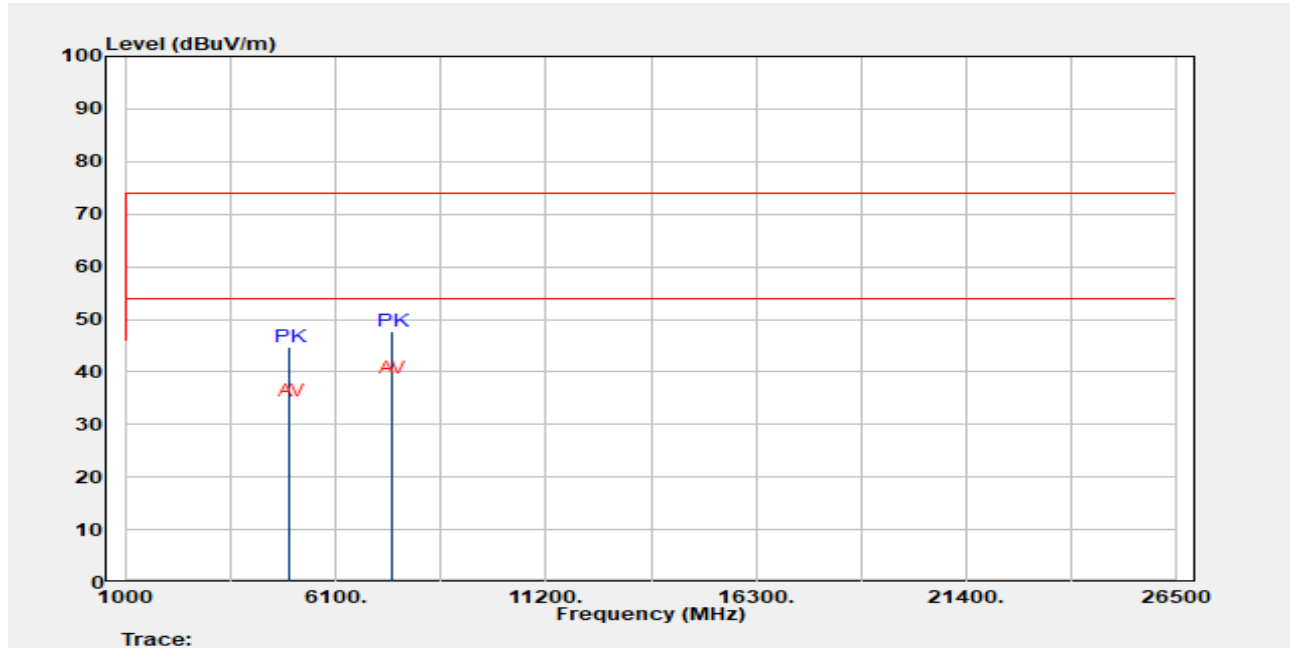

Trace:	Freq.	Detector Mode	Spectrum Reading Level	Factor	Actual FS	Limit @3m	Margin
	MHz	PK/QP/AV	dBμV	dB	dBμV/m	dBμV/m	dB
	4960.000	Peak	41.83	2.84	44.67	74.00	-29.33
	4960.000	Average	31.69	2.84	34.53	54.00	-19.47
	7440.000	Peak	39.73	8.02	47.74	74.00	-26.26
	7440.000	Average	30.69	8.02	38.71	54.00	-15.29

Unless otherwise stated the results shown in this test report refer only to the sample(s) tested and such sample(s) are retained for 90 days only.

除非另有說明，此報告結果僅對測試之樣品負責，同時此樣品僅保留90天。本報告未經本公司書面許可，不可部份複製。

This document is issued by the Company subject to its General Conditions of Service printed overleaf, available on request or accessible at <http://www.sgs.com.tw/Terms-and-Conditions> and for electronic format documents, subject to Terms and Conditions for Electronic Documents at <http://www.sgs.com.tw/Terms-and-Conditions>. Attention is drawn to the limitation of liability, indemnification and jurisdiction issues defined therein. Any holder of this document is advised that information contained hereon reflects the Company's findings at the time of its intervention only and within the limits of Client's instructions, if any. The Company's sole responsibility is to its Client and this document does not exonerate parties to a transaction from exercising all their rights and obligations under the transaction documents. This document cannot be reproduced except in full, without prior written approval of the Company. Any unauthorized alteration, forgery or falsification of the content or appearance of this document is unlawful and offenders may be prosecuted to the fullest extent of the law.

Report Number :TERF2404001033ER
 Operation Mode :BLE PHY=8
 Test Frequency :2480 MHz
 Test Mode :Tx
 EUT Pol :E1 Plane

Test Site :SAC 2
 Test Date :2024-05-08
 Temp./Humi. :23.1°C/62%
 Antenna Pol. :Horizontal
 Engineer :Eason Wang

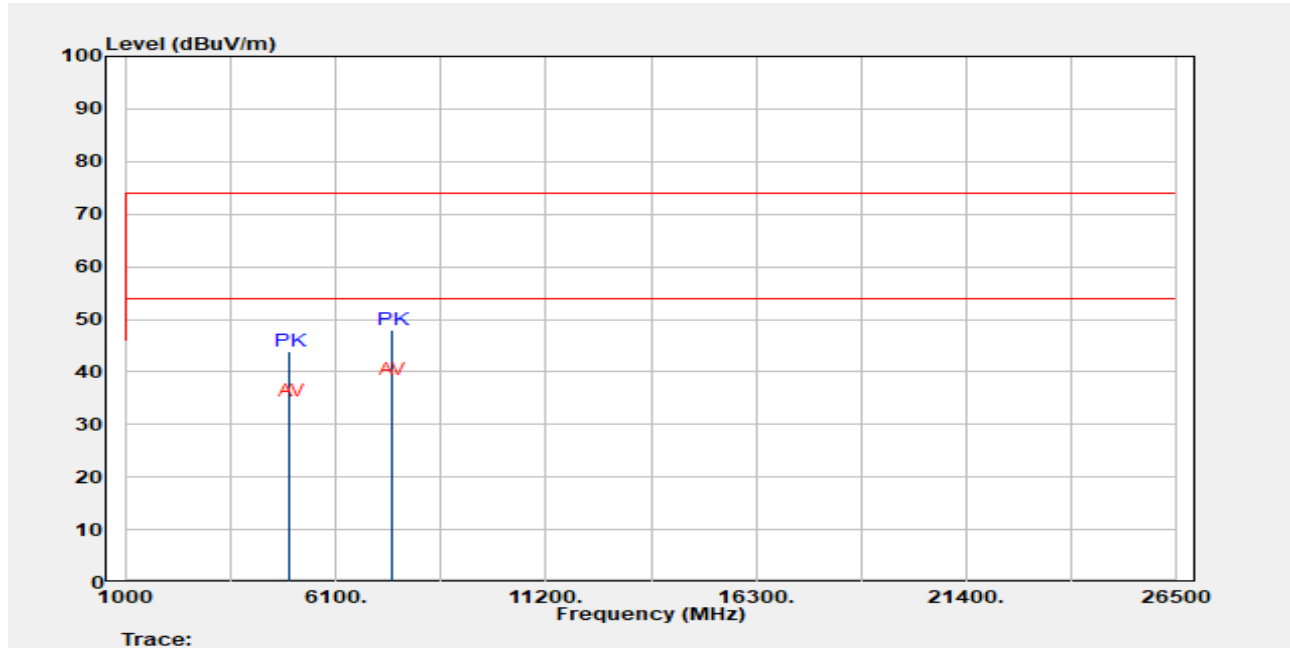

Freq. MHz	Detector Mode PK/QP/AV	Spectrum Reading Level dBuV	Factor dB	Actual FS dBuV/m	Limit @3m dBuV/m	Margin dB
4960.000	Peak	41.18	2.84	44.02	74.00	-29.98
4960.000	Average	31.53	2.84	34.37	54.00	-19.63
7440.000	Peak	39.94	8.02	47.96	74.00	-26.04
7440.000	Average	30.54	8.02	38.56	54.00	-15.44

Unless otherwise stated the results shown in this test report refer only to the sample(s) tested and such sample(s) are retained for 90 days only.

除非另有說明，此報告結果僅對測試之樣品負責，同時此樣品僅保留90天。本報告未經本公司書面許可，不可部份複製。

This document is issued by the Company subject to its General Conditions of Service printed overleaf, available on request or accessible at <http://www.sgs.com.tw/Terms-and-Conditions> and for electronic format documents, subject to Terms and Conditions for Electronic Documents at <http://www.sgs.com.tw/Terms-and-Conditions>. Attention is drawn to the limitation of liability, indemnification and jurisdiction issues defined therein. Any holder of this document is advised that information contained hereon reflects the Company's findings at the time of its intervention only and within the limits of Client's instructions, if any. The Company's sole responsibility is to its Client and this document does not exonerate parties to a transaction from exercising all their rights and obligations under the transaction documents. This document cannot be reproduced except in full, without prior written approval of the Company. Any unauthorized alteration, forgery or falsification of the content or appearance of this document is unlawful and offenders may be prosecuted to the fullest extent of the law.

Report Number :TERF2404001033ER
 Operation Mode :BLE PHY=2
 Test Frequency :2402 MHz
 Test Mode :Tx
 EUT Pol :E1 Plane

Test Site :SAC 2
 Test Date :2024-05-08
 Temp./Humi. :23.1°C/62%
 Antenna Pol. :Vertical
 Engineer :Eason Wang

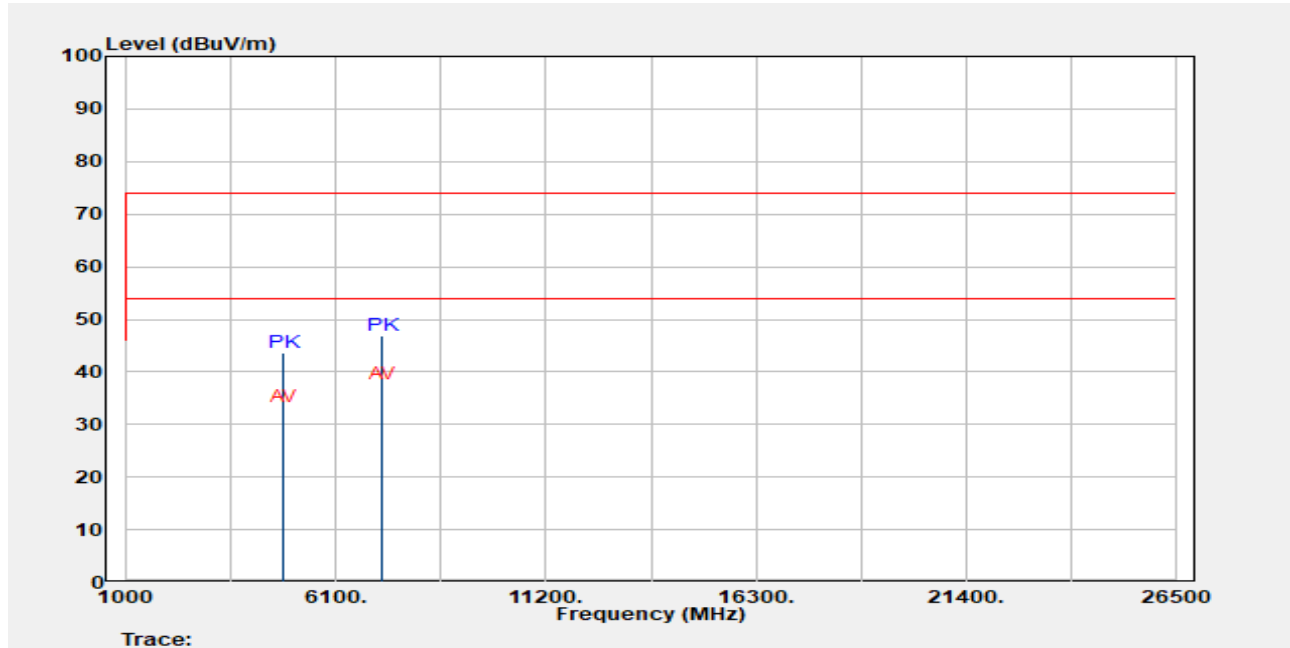

Freq. MHz	Detector Mode PK/QP/AV	Spectrum Reading Level dBuV	Factor dB	Actual FS dBuV/m	Limit @3m dBuV/m	Margin dB
4804.000	Peak	41.52	2.05	43.56	74.00	-30.44
4804.000	Average	31.24	2.05	33.29	54.00	-20.71
7206.000	Peak	39.47	7.50	46.98	74.00	-27.02
7206.000	Average	30.22	7.50	37.72	54.00	-16.28

Unless otherwise stated the results shown in this test report refer only to the sample(s) tested and such sample(s) are retained for 90 days only.

除非另有說明，此報告結果僅對測試之樣品負責，同時此樣品僅保留90天。本報告未經本公司書面許可，不可部份複製。
 This document is issued by the Company subject to its General Conditions of Service printed overleaf, available on request or accessible at <http://www.sgs.com.tw/Terms-and-Conditions> and for electronic format documents, subject to Terms and Conditions for Electronic Documents at <http://www.sgs.com.tw/Terms-and-Conditions>. Attention is drawn to the limitation of liability, indemnification and jurisdiction issues defined therein. Any holder of this document is advised that information contained hereon reflects the Company's findings at the time of its intervention only and within the limits of Client's instructions, if any. The Company's sole responsibility is to its Client and this document does not exonerate parties to a transaction from exercising all their rights and obligations under the transaction documents. This document cannot be reproduced except in full, without prior written approval of the Company. Any unauthorized alteration, forgery or falsification of the content or appearance of this document is unlawful and offenders may be prosecuted to the fullest extent of the law.

Report Number :TERF2404001033ER
 Operation Mode :BLE PHY=2
 Test Frequency :2402 MHz
 Test Mode :Tx
 EUT Pol :E1 Plane

Test Site :SAC 2
 Test Date :2024-05-08
 Temp./Humi. :23.1°C/62%
 Antenna Pol. :Horizontal
 Engineer :Eason Wang

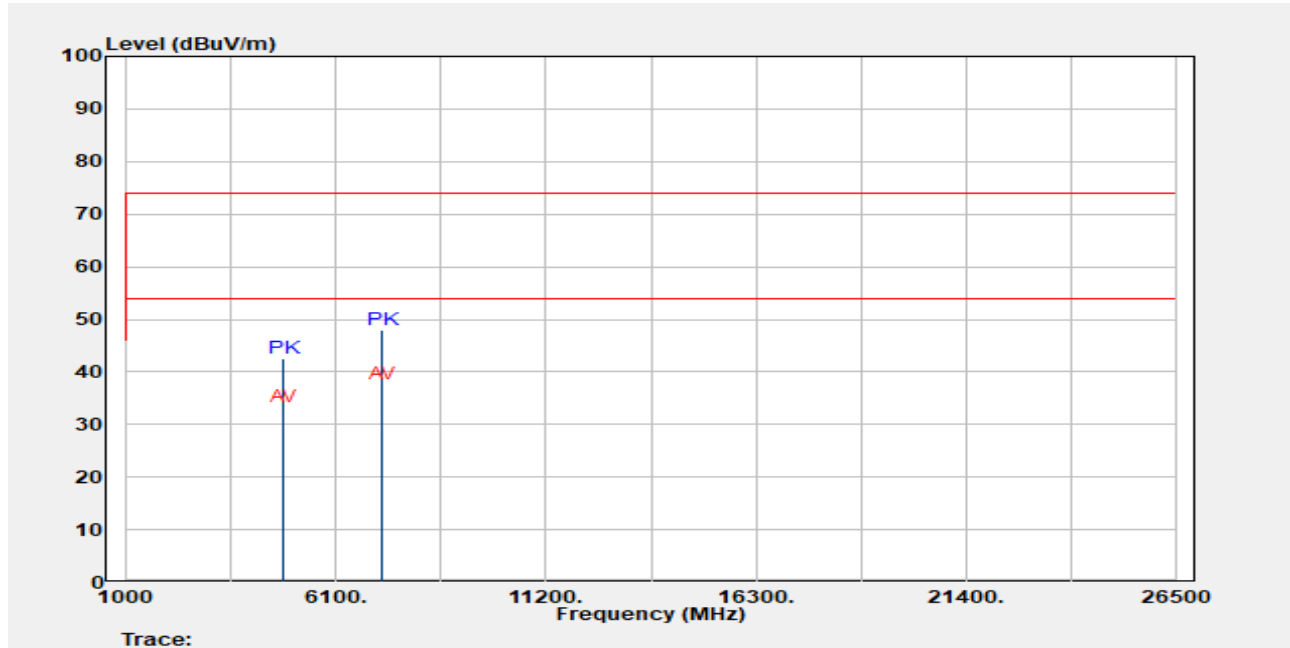

Trace:	Freq.	Detector Mode	Spectrum Reading Level	Factor	Actual FS	Limit @3m	Margin
	MHz	PK/QP/AV	dBuV	dB	dBuV/m	dBuV/m	dB
	4804.000	Peak	40.61	2.05	42.65	74.00	-31.35
	4804.000	Average	31.33	2.05	33.38	54.00	-20.62
	7206.000	Peak	40.44	7.50	47.94	74.00	-26.06
	7206.000	Average	30.27	7.50	37.77	54.00	-16.23

Unless otherwise stated the results shown in this test report refer only to the sample(s) tested and such sample(s) are retained for 90 days only.

除非另有說明，此報告結果僅對測試之樣品負責，同時此樣品僅保留90天。本報告未經本公司書面許可，不可部份複製。

This document is issued by the Company subject to its General Conditions of Service printed overleaf, available on request or accessible at <http://www.sgs.com.tw/Terms-and-Conditions> and for electronic format documents, subject to Terms and Conditions for Electronic Documents at <http://www.sgs.com.tw/Terms-and-Conditions>. Attention is drawn to the limitation of liability, indemnification and jurisdiction issues defined therein. Any holder of this document is advised that information contained hereon reflects the Company's findings at the time of its intervention only and within the limits of Client's instructions, if any. The Company's sole responsibility is to its Client and this document does not exonerate parties to a transaction from exercising all their rights and obligations under the transaction documents. This document cannot be reproduced except in full, without prior written approval of the Company. Any unauthorized alteration, forgery or falsification of the content or appearance of this document is unlawful and offenders may be prosecuted to the fullest extent of the law.

Report Number :TERF2404001033ER
 Operation Mode :BLE PHY=2
 Test Frequency :2440 MHz
 Test Mode :Tx
 EUT Pol :E1 Plane

Test Site :SAC 2
 Test Date :2024-05-08
 Temp./Humi. :23.1°C/62%
 Antenna Pol. :Vertical
 Engineer :Eason Wang

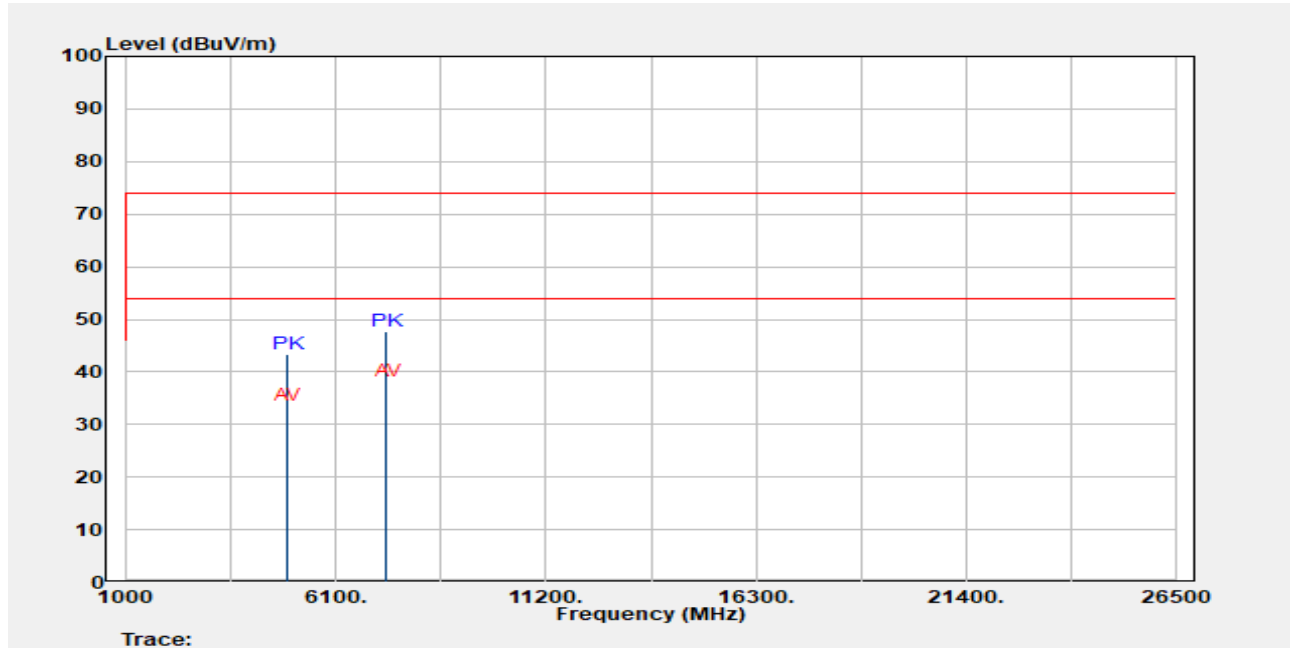

Freq. MHz	Detector Mode PK/QP/AV	Spectrum Reading Level dBuV	Factor dB	Actual FS dBuV/m	Limit @3m dBuV/m	Margin dB
4880.000	Peak	40.92	2.40	43.33	74.00	-30.67
4880.000	Average	31.27	2.40	33.67	54.00	-20.33
7320.000	Peak	39.76	7.84	47.60	74.00	-26.40
7320.000	Average	30.43	7.84	38.27	54.00	-15.73

Unless otherwise stated the results shown in this test report refer only to the sample(s) tested and such sample(s) are retained for 90 days only.

除非另有說明，此報告結果僅對測試之樣品負責，同時此樣品僅保留90天。本報告未經本公司書面許可，不可部份複製。

This document is issued by the Company subject to its General Conditions of Service printed overleaf, available on request or accessible at <http://www.sgs.com.tw/Terms-and-Conditions> and for electronic format documents, subject to Terms and Conditions for Electronic Documents at <http://www.sgs.com.tw/Terms-and-Conditions>. Attention is drawn to the limitation of liability, indemnification and jurisdiction issues defined therein. Any holder of this document is advised that information contained hereon reflects the Company's findings at the time of its intervention only and within the limits of Client's instructions, if any. The Company's sole responsibility is to its Client and this document does not exonerate parties to a transaction from exercising all their rights and obligations under the transaction documents. This document cannot be reproduced except in full, without prior written approval of the Company. Any unauthorized alteration, forgery or falsification of the content or appearance of this document is unlawful and offenders may be prosecuted to the fullest extent of the law.

Report Number :TERF2404001033ER
 Operation Mode :BLE PHY=2
 Test Frequency :2440 MHz
 Test Mode :Tx
 EUT Pol :E1 Plane

Test Site :SAC 2
 Test Date :2024-05-08
 Temp./Humi. :23.1°C/62%
 Antenna Pol. :Horizontal
 Engineer :Eason Wang

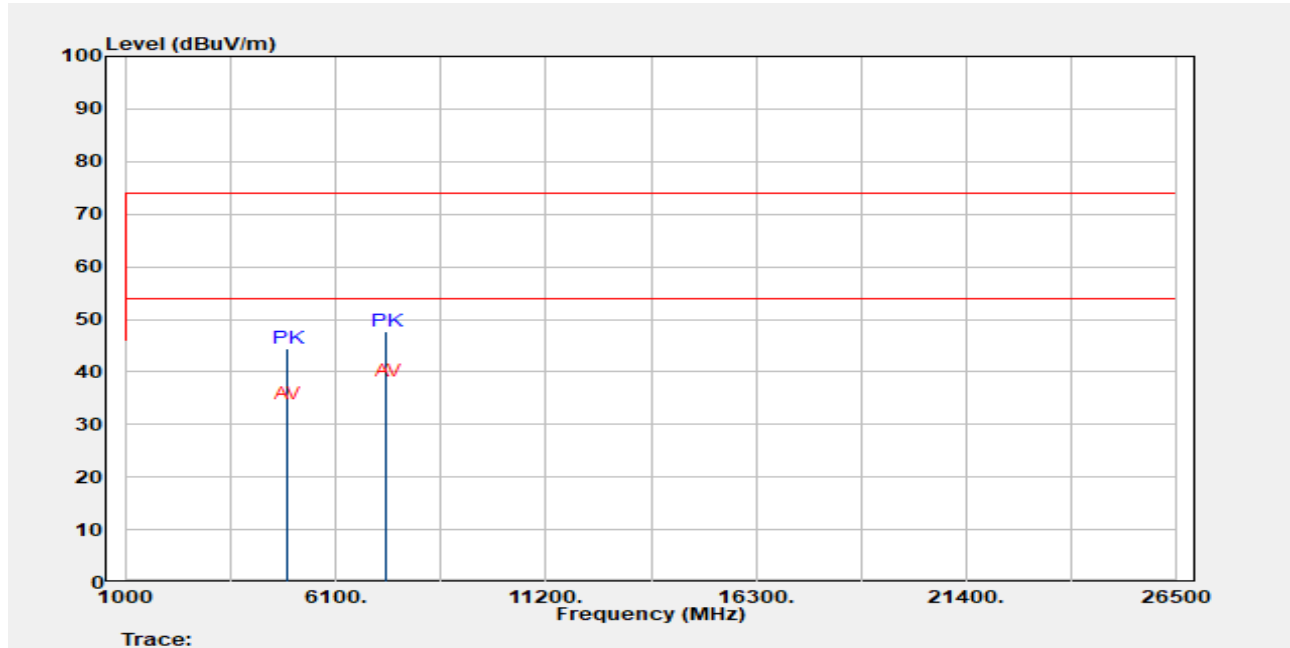

Trace:	Freq.	Detector Mode	Spectrum Reading Level	Factor	Actual FS	Limit @3m	Margin
	MHz	PK/QP/AV	dBuV	dB	dBuV/m	dBuV/m	dB
	4880.000	Peak	41.98	2.40	44.39	74.00	-29.61
	4880.000	Average	31.38	2.40	33.78	54.00	-20.22
	7320.000	Peak	39.74	7.84	47.58	74.00	-26.42
	7320.000	Average	30.50	7.84	38.34	54.00	-15.66

Unless otherwise stated the results shown in this test report refer only to the sample(s) tested and such sample(s) are retained for 90 days only.

除非另有說明，此報告結果僅對測試之樣品負責，同時此樣品僅保留90天。本報告未經本公司書面許可，不可部份複製。

This document is issued by the Company subject to its General Conditions of Service printed overleaf, available on request or accessible at <http://www.sgs.com.tw/Terms-and-Conditions> and for electronic format documents, subject to Terms and Conditions for Electronic Documents at <http://www.sgs.com.tw/Terms-and-Conditions>. Attention is drawn to the limitation of liability, indemnification and jurisdiction issues defined therein. Any holder of this document is advised that information contained hereon reflects the Company's findings at the time of its intervention only and within the limits of Client's instructions, if any. The Company's sole responsibility is to its Client and this document does not exonerate parties to a transaction from exercising all their rights and obligations under the transaction documents. This document cannot be reproduced except in full, without prior written approval of the Company. Any unauthorized alteration, forgery or falsification of the content or appearance of this document is unlawful and offenders may be prosecuted to the fullest extent of the law.

Report Number :TERF2404001033ER
 Operation Mode :BLE PHY=2
 Test Frequency :2480 MHz
 Test Mode :Tx
 EUT Pol :E1 Plane

Test Site :SAC 2
 Test Date :2024-05-08
 Temp./Humi. :23.1°C/62%
 Antenna Pol. :Vertical
 Engineer :Eason Wang

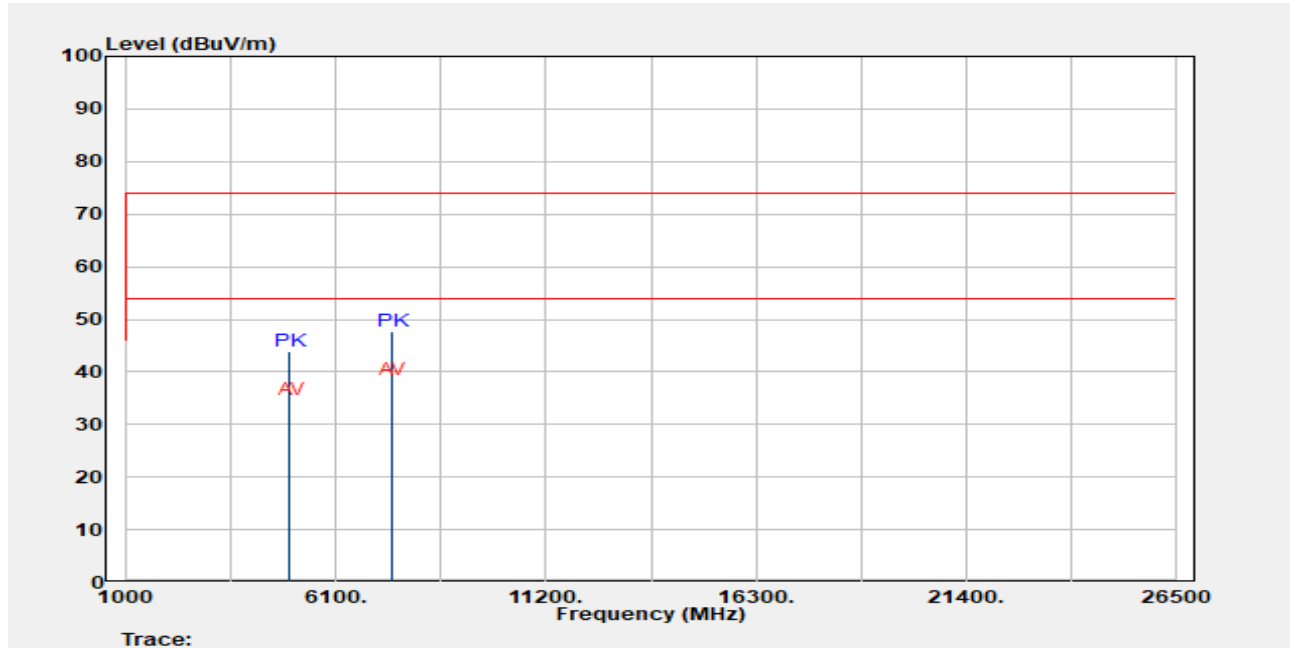

Freq. MHz	Detector Mode PK/QP/AV	Spectrum Reading Level dB μ V	Factor dB	Actual FS dB μ V/m	Limit @3m dB μ V/m	Margin dB
4960.000	Peak	41.10	2.84	43.94	74.00	-30.06
4960.000	Average	31.75	2.84	34.59	54.00	-19.41
7440.000	Peak	39.74	8.02	47.76	74.00	-26.24
7440.000	Average	30.50	8.02	38.52	54.00	-15.48

Unless otherwise stated the results shown in this test report refer only to the sample(s) tested and such sample(s) are retained for 90 days only.

除非另有說明，此報告結果僅對測試之樣品負責，同時此樣品僅保留90天。本報告未經本公司書面許可，不可部份複製。

This document is issued by the Company subject to its General Conditions of Service printed overleaf, available on request or accessible at <http://www.sgs.com.tw/Terms-and-Conditions> and for electronic format documents, subject to Terms and Conditions for Electronic Documents at <http://www.sgs.com.tw/Terms-and-Conditions>. Attention is drawn to the limitation of liability, indemnification and jurisdiction issues defined therein. Any holder of this document is advised that information contained hereon reflects the Company's findings at the time of its intervention only and within the limits of Client's instructions, if any. The Company's sole responsibility is to its Client and this document does not exonerate parties to a transaction from exercising all their rights and obligations under the transaction documents. This document cannot be reproduced except in full, without prior written approval of the Company. Any unauthorized alteration, forgery or falsification of the content or appearance of this document is unlawful and offenders may be prosecuted to the fullest extent of the law.

Report Number :TERF2404001033ER
 Operation Mode :BLE PHY=2
 Test Frequency :2480 MHz
 Test Mode :Tx
 EUT Pol :E1 Plane

Test Site :SAC 2
 Test Date :2024-05-08
 Temp./Humi. :23.1°C/62%
 Antenna Pol. :Horizontal
 Engineer :Eason Wang

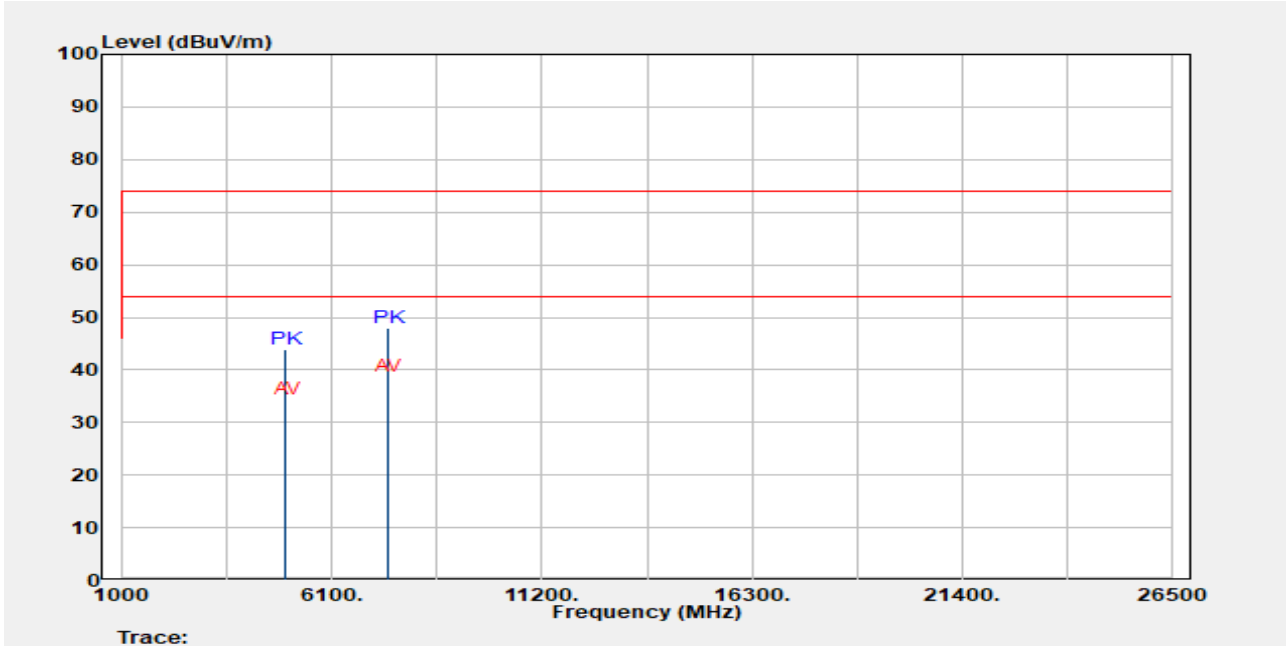

Trace:	Freq.	Detector Mode	Spectrum Reading Level	Factor	Actual FS	Limit @3m	Margin
	MHz	PK/QP/AV	dBμV	dB	dBμV/m	dBμV/m	dB
	4960.000	Peak	41.20	2.84	44.04	74.00	-29.96
	4960.000	Average	31.71	2.84	34.55	54.00	-19.45
	7440.000	Peak	39.82	8.02	47.84	74.00	-26.16
	7440.000	Average	30.67	8.02	38.69	54.00	-15.31

Unless otherwise stated the results shown in this test report refer only to the sample(s) tested and such sample(s) are retained for 90 days only.

除非另有說明，此報告結果僅對測試之樣品負責，同時此樣品僅保留90天。本報告未經本公司書面許可，不可部份複製。

This document is issued by the Company subject to its General Conditions of Service printed overleaf, available on request or accessible at <http://www.sgs.com.tw/Terms-and-Conditions> and for electronic format documents, subject to Terms and Conditions for Electronic Documents at <http://www.sgs.com.tw/Terms-and-Conditions>. Attention is drawn to the limitation of liability, indemnification and jurisdiction issues defined therein. Any holder of this document is advised that information contained hereon reflects the Company's findings at the time of its intervention only and within the limits of Client's instructions, if any. The Company's sole responsibility is to its Client and this document does not exonerate parties to a transaction from exercising all their rights and obligations under the transaction documents. This document cannot be reproduced except in full, without prior written approval of the Company. Any unauthorized alteration, forgery or falsification of the content or appearance of this document is unlawful and offenders may be prosecuted to the fullest extent of the law.

Mode: ANT8

Report Number :TERF2404001033ER
 Operation Mode :BLE 1M
 Test Frequency :2440 MHz
 Test Mode :Tx
 EUT Pol :E1 Plane

Test Site :SAC 2
 Test Date :2024-05-07
 Temp./Humi. :24.3°C/59%
 Antenna Pol. :Vertical
 Engineer :Eason Wang

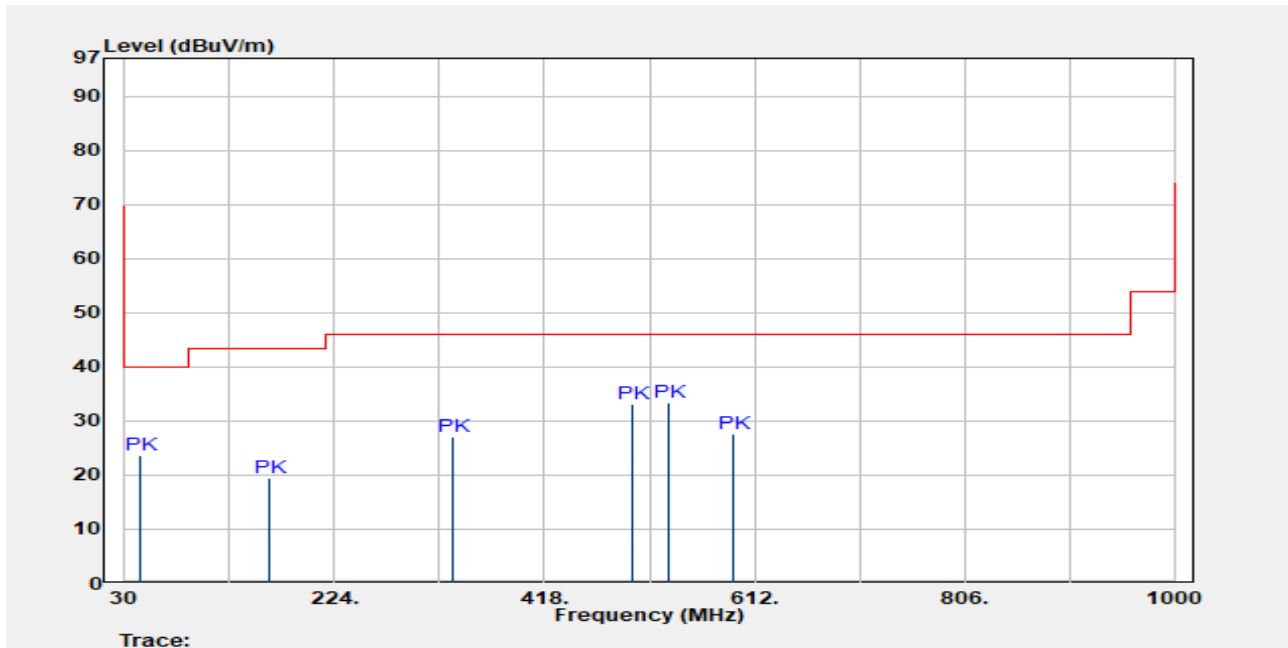

Freq. MHz	Detector Mode PK/QP/AV	Spectrum Reading Level dμV	Factor dB	Actual FS dμV/m	Limit @3m dμV/m	Margin dB
43.58	Peak	36.58	-12.89	23.69	40.00	-16.31
162.89	Peak	32.56	-13.12	19.44	43.50	-24.06
332.64	Peak	38.30	-11.19	27.11	46.00	-18.89
498.51	Peak	40.28	-7.06	33.22	46.00	-12.78
532.46	Peak	40.19	-6.78	33.41	46.00	-12.59
591.63	Peak	32.52	-4.82	27.70	46.00	-18.30

Unless otherwise stated the results shown in this test report refer only to the sample(s) tested and such sample(s) are retained for 90 days only.

除非另有說明，此報告結果僅對測試之樣品負責，同時此樣品僅保留90天。本報告未經本公司書面許可，不可部份複製。

This document is issued by the Company subject to its General Conditions of Service printed overleaf, available on request or accessible at <http://www.sgs.com.tw/Terms-and-Conditions> and for electronic format documents, subject to Terms and Conditions for Electronic Documents at <http://www.sgs.com.tw/Terms-and-Conditions>. Attention is drawn to the limitation of liability, indemnification and jurisdiction issues defined therein. Any holder of this document is advised that information contained hereon reflects the Company's findings at the time of its intervention only and within the limits of Client's instructions, if any. The Company's sole responsibility is to its Client and this document does not exonerate parties to a transaction from exercising all their rights and obligations under the transaction documents. This document cannot be reproduced except in full, without prior written approval of the Company. Any unauthorized alteration, forgery or falsification of the content or appearance of this document is unlawful and offenders may be prosecuted to the fullest extent of the law.

Report Number :TERF2404001033ER
 Operation Mode :BLE 1M
 Test Frequency :2440 MHz
 Test Mode :Tx
 EUT Pol :E1 Plane

Test Site :SAC 2
 Test Date :2024-05-07
 Temp./Humi. :24.3°C/59%
 Antenna Pol. :Horizontal
 Engineer :Eason Wang

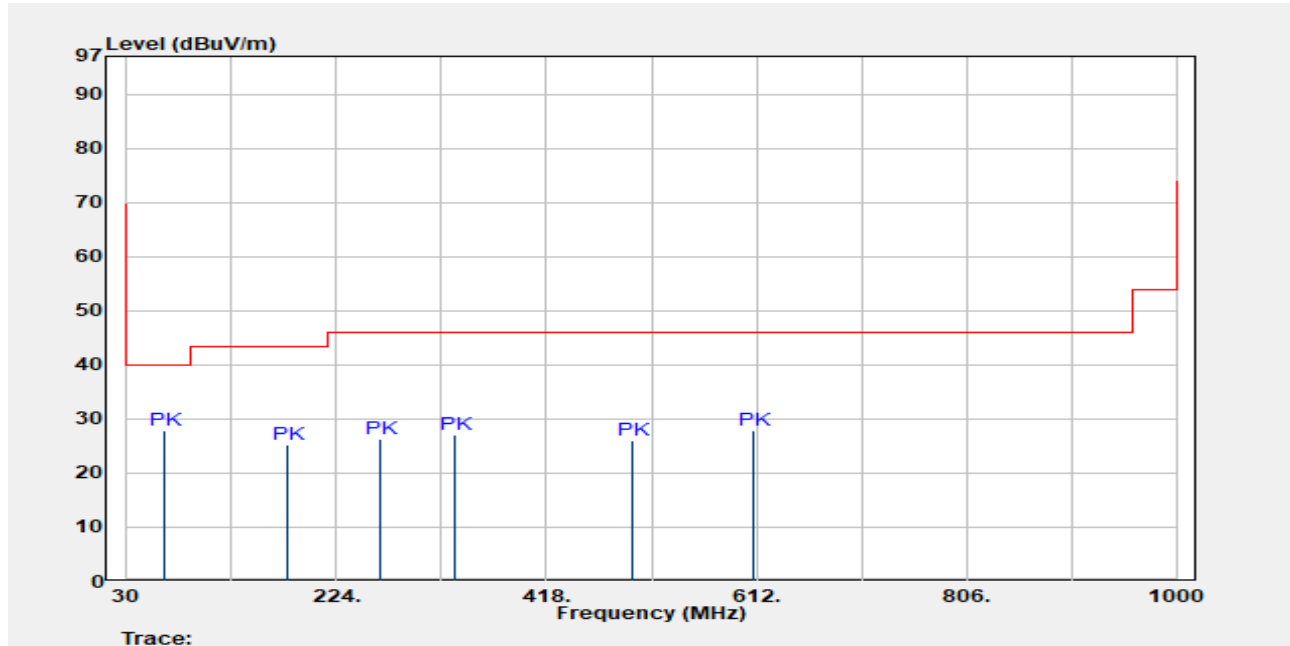

Freq. MHz	Detector Mode PK/QP/AV	Spectrum Reading Level dBμV	Factor dB	Actual FS dBμV/m	Limit @3m dBμV/m	Margin dB
64.92	Peak	42.39	-14.49	27.90	40.00	-12.10
178.41	Peak	39.31	-14.10	25.21	43.50	-18.29
264.74	Peak	39.26	-12.98	26.28	46.00	-19.72
333.61	Peak	38.34	-11.16	27.18	46.00	-18.82
497.54	Peak	33.05	-7.10	25.95	46.00	-20.05
609.09	Peak	32.42	-4.45	27.97	46.00	-18.03

Unless otherwise stated the results shown in this test report refer only to the sample(s) tested and such sample(s) are retained for 90 days only.

除非另有說明，此報告結果僅對測試之樣品負責，同時此樣品僅保留90天。本報告未經本公司書面許可，不可部份複製。

This document is issued by the Company subject to its General Conditions of Service printed overleaf, available on request or accessible at <http://www.sgs.com.tw/Terms-and-Conditions> and for electronic format documents, subject to Terms and Conditions for Electronic Documents at <http://www.sgs.com.tw/Terms-and-Conditions>. Attention is drawn to the limitation of liability, indemnification and jurisdiction issues defined therein. Any holder of this document is advised that information contained hereon reflects the Company's findings at the time of its intervention only and within the limits of Client's instructions, if any. The Company's sole responsibility is to its Client and this document does not exonerate parties to a transaction from exercising all their rights and obligations under the transaction documents. This document cannot be reproduced except in full, without prior written approval of the Company. Any unauthorized alteration, forgery or falsification of the content or appearance of this document is unlawful and offenders may be prosecuted to the fullest extent of the law.

Report Number :TERF2404001033ER
 Operation Mode :BLE 1M
 Test Frequency :2402 MHz
 Test Mode :Tx
 EUT Pol :E1 Plane

Test Site :SAC 2
 Test Date :2024-05-07
 Temp./Humi. :24.3°C/59%
 Antenna Pol. :Vertical
 Engineer :Eason Wang

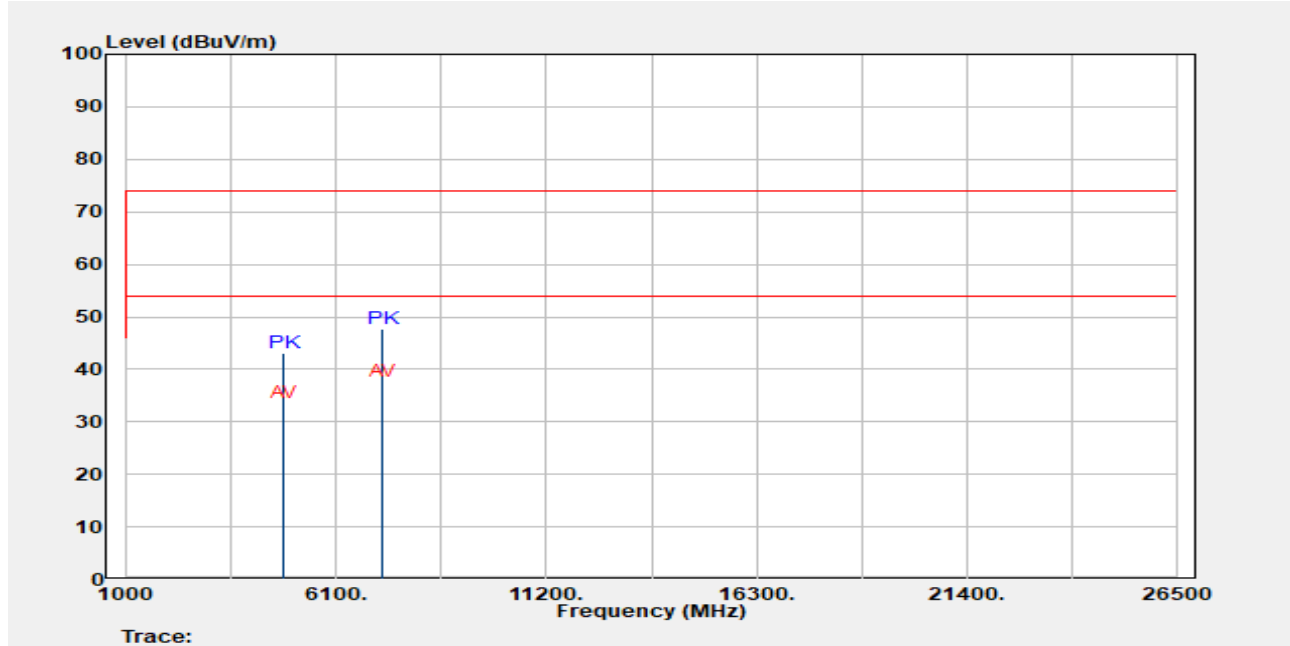

Trace:	Freq. MHz	Detector Mode PK/QP/AV	Spectrum Reading Level dBμV	Factor dB	Actual FS dBμV/m	Limit @3m dBμV/m	Margin dB
	4804.00	Peak	41.01	2.05	43.06	74.00	-30.94
	4804.00	Average	31.53	2.05	33.58	54.00	-20.42
	7206.00	Peak	40.08	7.50	47.58	74.00	-26.42
	7206.00	Average	30.20	7.50	37.70	54.00	-16.30

Unless otherwise stated the results shown in this test report refer only to the sample(s) tested and such sample(s) are retained for 90 days only.

除非另有說明，此報告結果僅對測試之樣品負責，同時此樣品僅保留90天。本報告未經本公司書面許可，不可部份複製。
 This document is issued by the Company subject to its General Conditions of Service printed overleaf, available on request or accessible at <http://www.sgs.com.tw/Terms-and-Conditions> and for electronic format documents, subject to Terms and Conditions for Electronic Documents at <http://www.sgs.com.tw/Terms-and-Conditions>. Attention is drawn to the limitation of liability, indemnification and jurisdiction issues defined therein. Any holder of this document is advised that information contained hereon reflects the Company's findings at the time of its intervention only and within the limits of Client's instructions, if any. The Company's sole responsibility is to its Client and this document does not exonerate parties to a transaction from exercising all their rights and obligations under the transaction documents. This document cannot be reproduced except in full, without prior written approval of the Company. Any unauthorized alteration, forgery or falsification of the content or appearance of this document is unlawful and offenders may be prosecuted to the fullest extent of the law.

Report Number :TERF2404001033ER
 Operation Mode :BLE 1M
 Test Frequency :2402 MHz
 Test Mode :Tx
 EUT Pol :E1 Plane

Test Site :SAC 2
 Test Date :2024-05-07
 Temp./Humi. :24.3°C/59%
 Antenna Pol. :Horizontal
 Engineer :Eason Wang

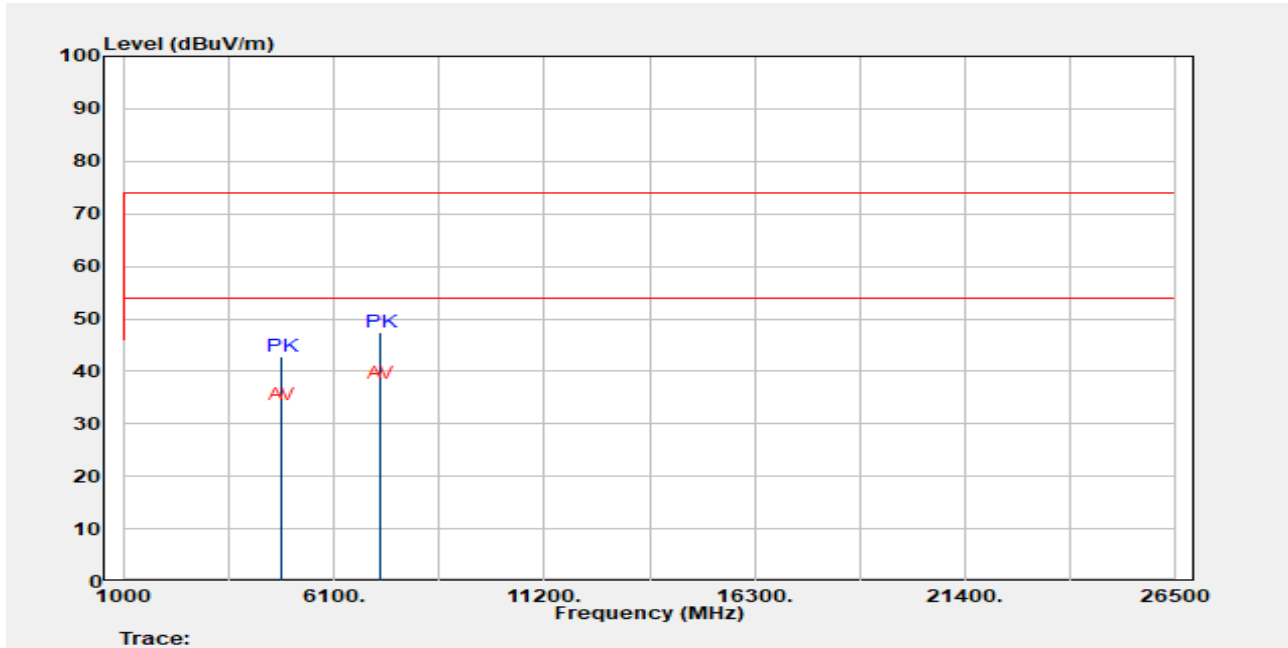

Freq. MHz	Detector Mode PK/QP/AV	Spectrum Reading Level dBμV	Factor dB	Actual FS dBμV/m	Limit @3m dBμV/m	Margin dB
4804.00	Peak	40.86	2.05	42.91	74.00	-31.09
4804.00	Average	31.47	2.05	33.52	54.00	-20.48
7206.00	Peak	39.83	7.50	47.33	74.00	-26.67
7206.00	Average	30.21	7.50	37.71	54.00	-16.29

Unless otherwise stated the results shown in this test report refer only to the sample(s) tested and such sample(s) are retained for 90 days only.

除非另有說明，此報告結果僅對測試之樣品負責，同時此樣品僅保留90天。本報告未經本公司書面許可，不可部份複製。

This document is issued by the Company subject to its General Conditions of Service printed overleaf, available on request or accessible at <http://www.sgs.com.tw/Terms-and-Conditions> and for electronic format documents, subject to Terms and Conditions for Electronic Documents at <http://www.sgs.com.tw/Terms-and-Conditions>. Attention is drawn to the limitation of liability, indemnification and jurisdiction issues defined therein. Any holder of this document is advised that information contained hereon reflects the Company's findings at the time of its intervention only and within the limits of Client's instructions, if any. The Company's sole responsibility is to its Client and this document does not exonerate parties to a transaction from exercising all their rights and obligations under the transaction documents. This document cannot be reproduced except in full, without prior written approval of the Company. Any unauthorized alteration, forgery or falsification of the content or appearance of this document is unlawful and offenders may be prosecuted to the fullest extent of the law.

Report Number :TERF2404001033ER
 Operation Mode :BLE 1M
 Test Frequency :2440 MHz
 Test Mode :Tx
 EUT Pol :E1 Plane

Test Site :SAC 2
 Test Date :2024-05-07
 Temp./Humi. :24.3°C/59%
 Antenna Pol. :Vertical
 Engineer :Eason Wang

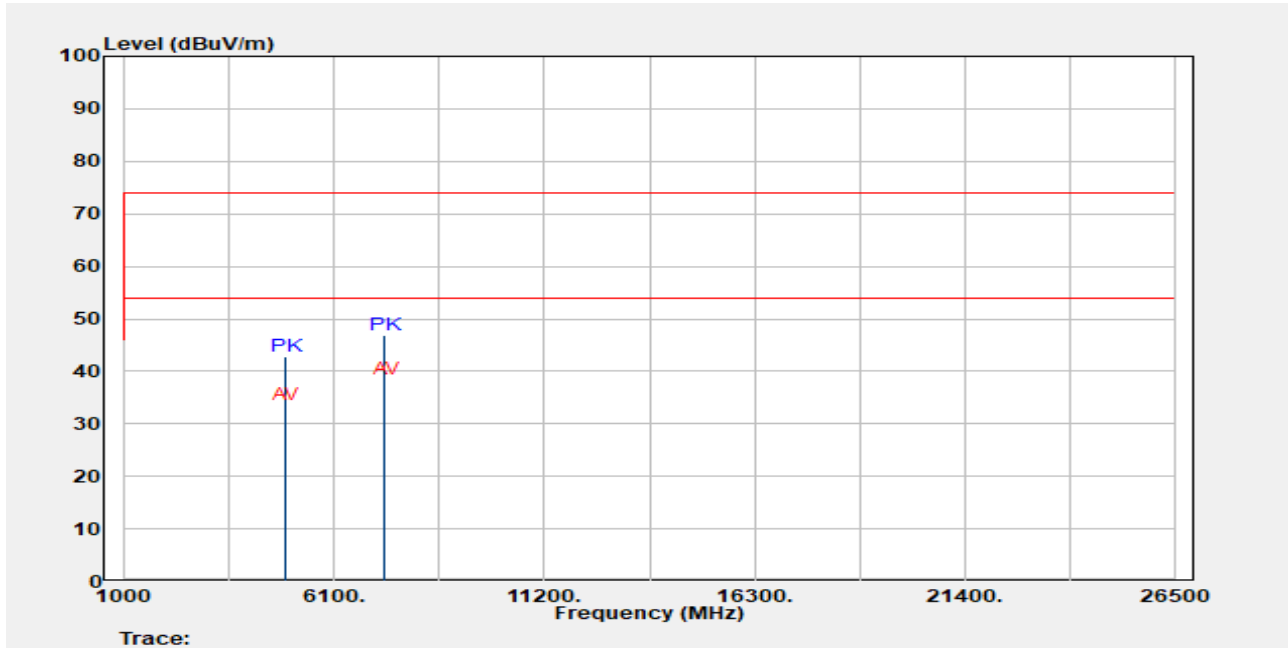

Freq. MHz	Detector Mode PK/QP/AV	Spectrum Reading Level dBμV	Factor dB	Actual FS dBμV/m	Limit @3m dBμV/m	Margin dB
4880.00	Peak	40.46	2.40	42.86	74.00	-31.14
4880.00	Average	31.32	2.40	33.72	54.00	-20.28
7320.00	Peak	39.05	7.84	46.89	74.00	-27.11
7320.00	Average	30.66	7.84	38.50	54.00	-15.50

Unless otherwise stated the results shown in this test report refer only to the sample(s) tested and such sample(s) are retained for 90 days only.

除非另有說明，此報告結果僅對測試之樣品負責，同時此樣品僅保留90天。本報告未經本公司書面許可，不可部份複製。

This document is issued by the Company subject to its General Conditions of Service printed overleaf, available on request or accessible at <http://www.sgs.com.tw/Terms-and-Conditions> and for electronic format documents, subject to Terms and Conditions for Electronic Documents at <http://www.sgs.com.tw/Terms-and-Conditions>. Attention is drawn to the limitation of liability, indemnification and jurisdiction issues defined therein. Any holder of this document is advised that information contained hereon reflects the Company's findings at the time of its intervention only and within the limits of Client's instructions, if any. The Company's sole responsibility is to its Client and this document does not exonerate parties to a transaction from exercising all their rights and obligations under the transaction documents. This document cannot be reproduced except in full, without prior written approval of the Company. Any unauthorized alteration, forgery or falsification of the content or appearance of this document is unlawful and offenders may be prosecuted to the fullest extent of the law.

Report Number :TERF2404001033ER
 Operation Mode :BLE 1M
 Test Frequency :2440 MHz
 Test Mode :Tx
 EUT Pol :E1 Plane

Test Site :SAC 2
 Test Date :2024-05-07
 Temp./Humi. :24.3°C/59%
 Antenna Pol. :Horizontal
 Engineer :Eason Wang

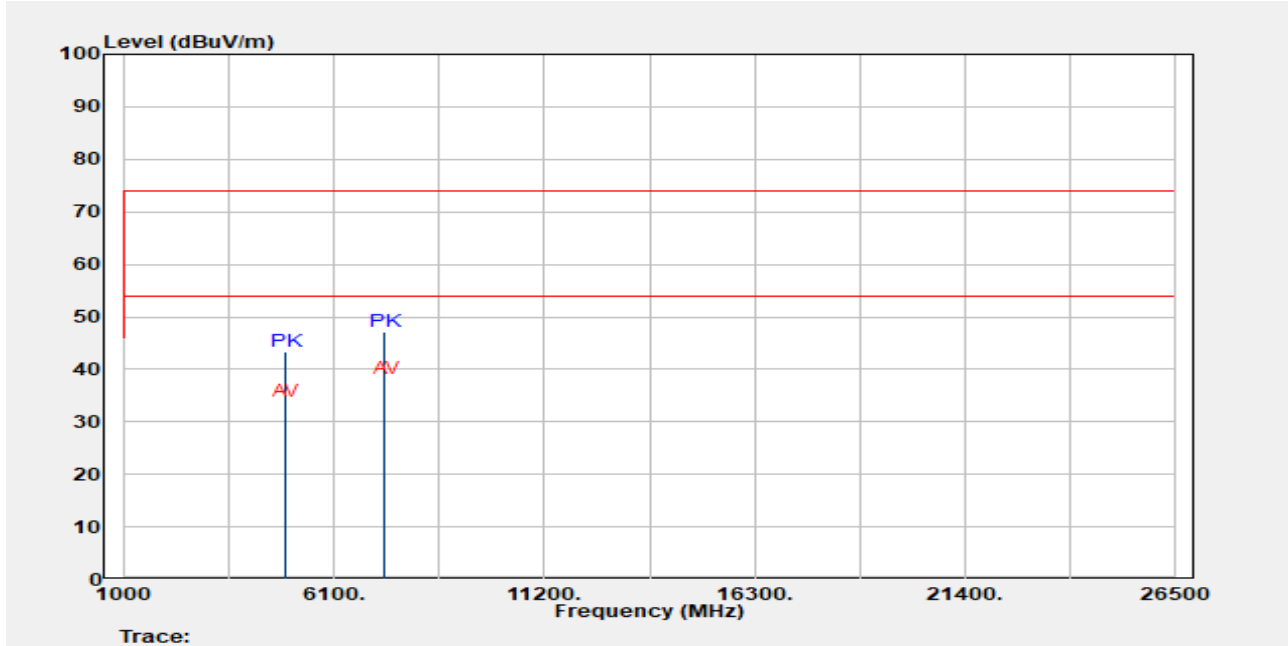

Trace:	Freq. MHz	Detector Mode PK/QP/AV	Spectrum Reading Level dBμV	Factor dB	Actual FS dBμV/m	Limit @3m dBμV/m	Margin dB
	4880.00	Peak	40.90	2.40	43.30	74.00	-30.70
	4880.00	Average	31.43	2.40	33.83	54.00	-20.17
	7320.00	Peak	39.35	7.84	47.19	74.00	-26.81
	7320.00	Average	30.46	7.84	38.30	54.00	-15.70

Unless otherwise stated the results shown in this test report refer only to the sample(s) tested and such sample(s) are retained for 90 days only.

除非另有說明，此報告結果僅對測試之樣品負責，同時此樣品僅保留90天。本報告未經本公司書面許可，不可部份複製。

This document is issued by the Company subject to its General Conditions of Service printed overleaf, available on request or accessible at <http://www.sgs.com.tw/Terms-and-Conditions> and for electronic format documents, subject to Terms and Conditions for Electronic Documents at <http://www.sgs.com.tw/Terms-and-Conditions>. Attention is drawn to the limitation of liability, indemnification and jurisdiction issues defined therein. Any holder of this document is advised that information contained hereon reflects the Company's findings at the time of its intervention only and within the limits of Client's instructions, if any. The Company's sole responsibility is to its Client and this document does not exonerate parties to a transaction from exercising all their rights and obligations under the transaction documents. This document cannot be reproduced except in full, without prior written approval of the Company. Any unauthorized alteration, forgery or falsification of the content or appearance of this document is unlawful and offenders may be prosecuted to the fullest extent of the law.

Report Number :TERF2404001033ER
 Operation Mode :BLE 1M
 Test Frequency :2480 MHz
 Test Mode :Tx
 EUT Pol :E1 Plane

Test Site :SAC 2
 Test Date :2024-05-07
 Temp./Humi. :24.3°C/59%
 Antenna Pol. :Vertical
 Engineer :Eason Wang

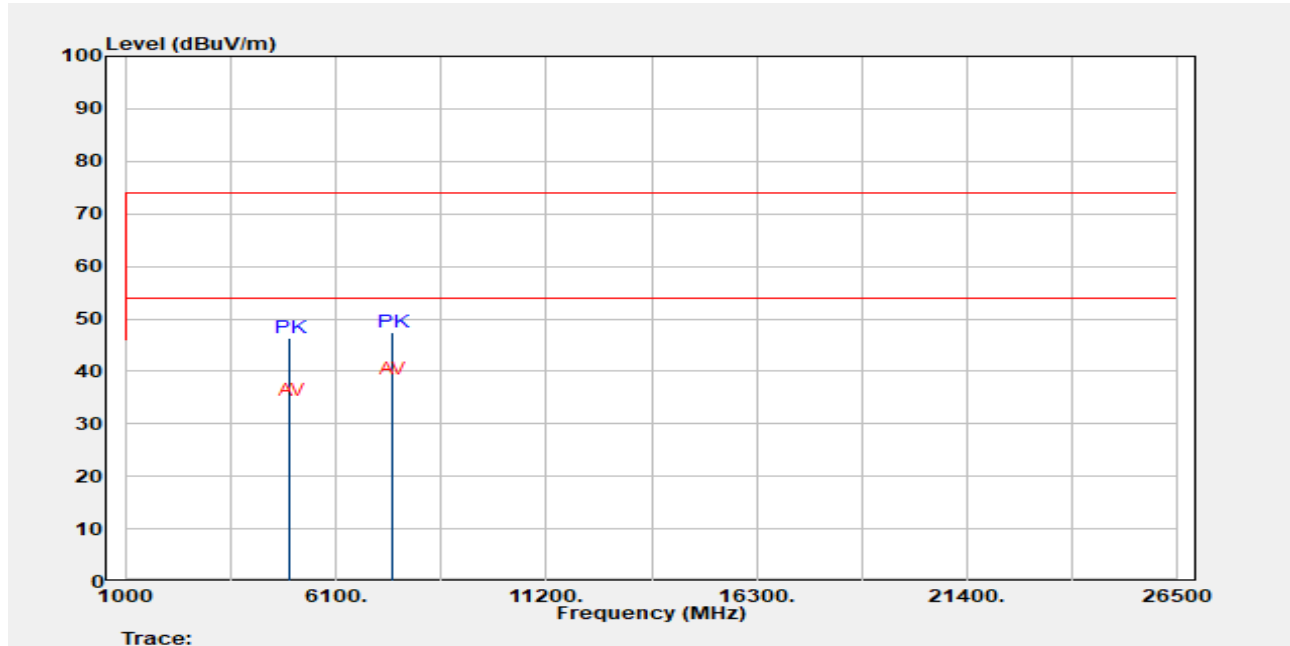

Trace:	Freq. MHz	Detector Mode PK/QP/AV	Spectrum Reading Level dBμV	Factor dB	Actual FS dBμV/m	Limit @3m dBμV/m	Margin dB
	4960.00	Peak	43.57	2.84	46.41	74.00	-27.59
	4960.00	Average	31.71	2.84	34.55	54.00	-19.45
	7440.00	Peak	39.36	8.02	47.38	74.00	-26.62
	7440.00	Average	30.60	8.02	38.62	54.00	-15.38

Unless otherwise stated the results shown in this test report refer only to the sample(s) tested and such sample(s) are retained for 90 days only.

除非另有說明，此報告結果僅對測試之樣品負責，同時此樣品僅保留90天。本報告未經本公司書面許可，不可部份複製。

This document is issued by the Company subject to its General Conditions of Service printed overleaf, available on request or accessible at <http://www.sgs.com.tw/Terms-and-Conditions> and for electronic format documents, subject to Terms and Conditions for Electronic Documents at <http://www.sgs.com.tw/Terms-and-Conditions>. Attention is drawn to the limitation of liability, indemnification and jurisdiction issues defined therein. Any holder of this document is advised that information contained hereon reflects the Company's findings at the time of its intervention only and within the limits of Client's instructions, if any. The Company's sole responsibility is to its Client and this document does not exonerate parties to a transaction from exercising all their rights and obligations under the transaction documents. This document cannot be reproduced except in full, without prior written approval of the Company. Any unauthorized alteration, forgery or falsification of the content or appearance of this document is unlawful and offenders may be prosecuted to the fullest extent of the law.

Report Number :TERF2404001033ER
 Operation Mode :BLE 1M
 Test Frequency :2480 MHz
 Test Mode :Tx
 EUT Pol :E1 Plane

Test Site :SAC 2
 Test Date :2024-05-07
 Temp./Humi. :24.3°C/59%
 Antenna Pol. :Horizontal
 Engineer :Eason Wang

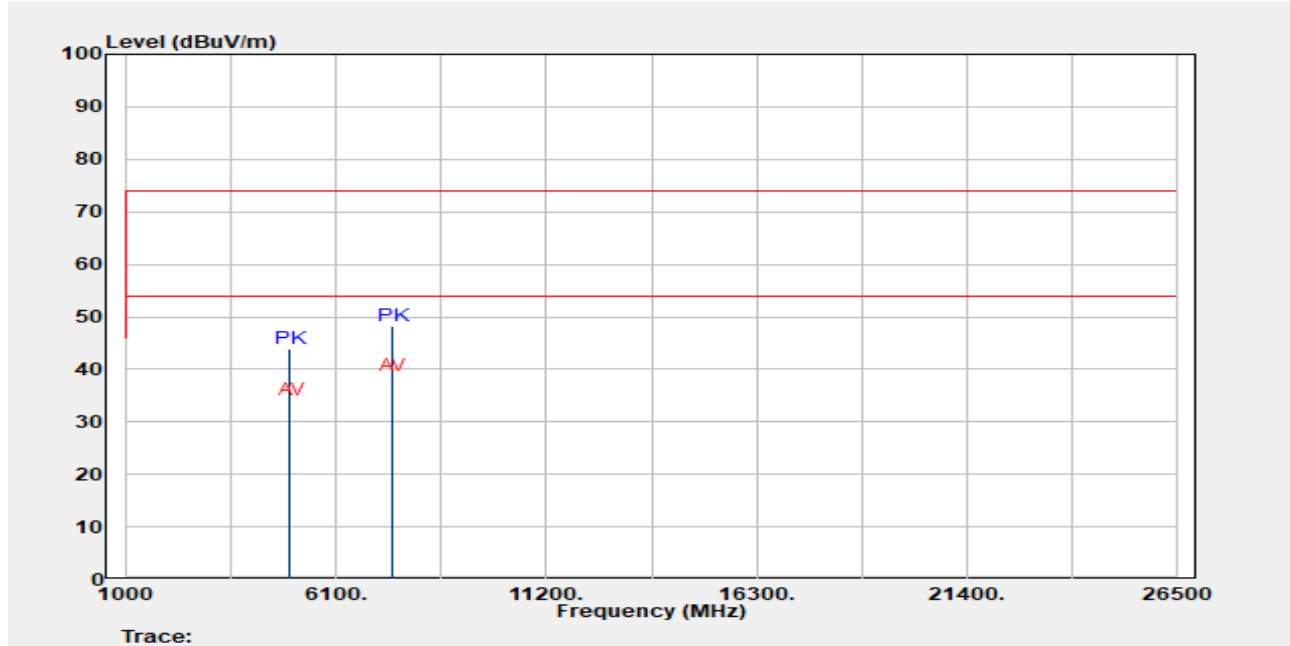

Freq. MHz	Detector Mode PK/QP/AV	Spectrum Reading Level dBμV	Factor dB	Actual FS dBμV/m	Limit @3m dBμV/m	Margin dB
4960.00	Peak	41.04	2.84	43.88	74.00	-30.12
4960.00	Average	31.38	2.84	34.22	54.00	-19.78
7440.00	Peak	40.13	8.02	48.15	74.00	-25.85
7440.00	Average	30.67	8.02	38.69	54.00	-15.31

Unless otherwise stated the results shown in this test report refer only to the sample(s) tested and such sample(s) are retained for 90 days only.

除非另有說明，此報告結果僅對測試之樣品負責，同時此樣品僅保留90天。本報告未經本公司書面許可，不可部份複製。

This document is issued by the Company subject to its General Conditions of Service printed overleaf, available on request or accessible at <http://www.sgs.com.tw/Terms-and-Conditions> and for electronic format documents, subject to Terms and Conditions for Electronic Documents at <http://www.sgs.com.tw/Terms-and-Conditions>. Attention is drawn to the limitation of liability, indemnification and jurisdiction issues defined therein. Any holder of this document is advised that information contained hereon reflects the Company's findings at the time of its intervention only and within the limits of Client's instructions, if any. The Company's sole responsibility is to its Client and this document does not exonerate parties to a transaction from exercising all their rights and obligations under the transaction documents. This document cannot be reproduced except in full, without prior written approval of the Company. Any unauthorized alteration, forgery or falsification of the content or appearance of this document is unlawful and offenders may be prosecuted to the fullest extent of the law.

Report Number :TERF2404001033ER
 Operation Mode :BLE 2M
 Test Frequency :2402 MHz
 Test Mode :Tx
 EUT Pol :E1 Plane

Test Site :SAC 2
 Test Date :2024-05-07
 Temp./Humi. :24.3°C/59%
 Antenna Pol. :Vertical
 Engineer :Eason Wang

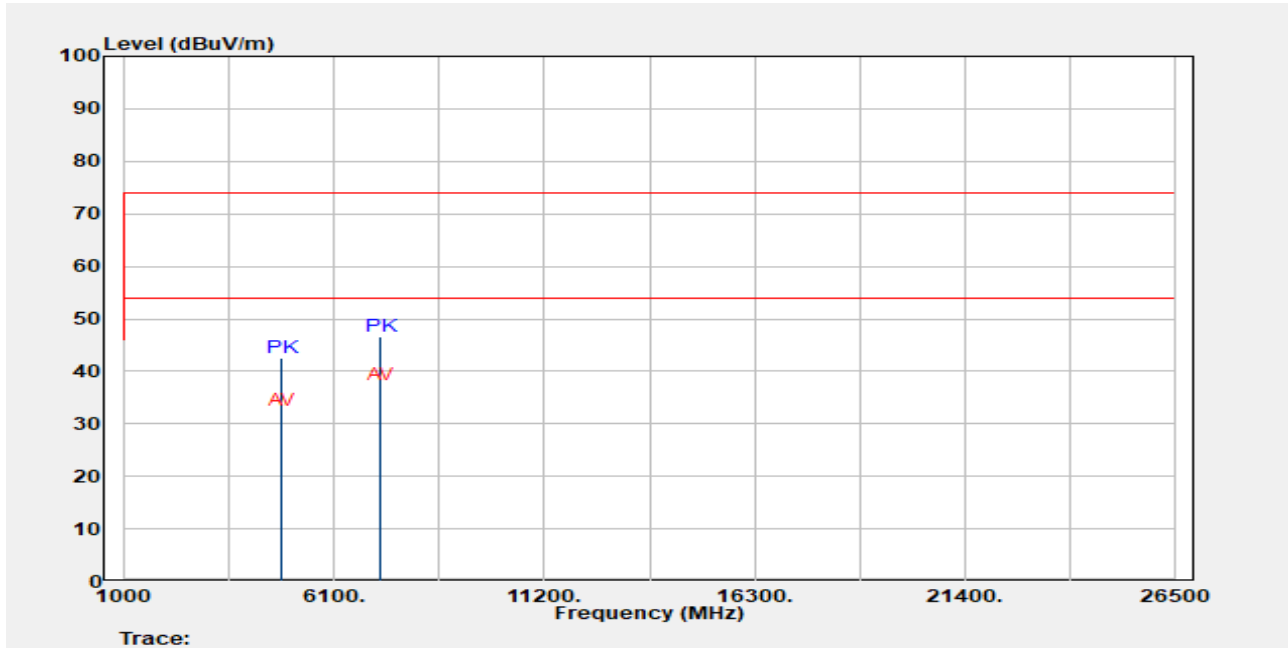

Freq. MHz	Detector Mode PK/QP/AV	Spectrum Reading Level dBμV	Factor dB	Actual FS dBμV/m	Limit @3m dBμV/m	Margin dB
4804.00	Peak	40.61	2.05	42.66	74.00	-31.34
4804.00	Average	30.54	2.05	32.59	54.00	-21.41
7206.00	Peak	39.04	7.50	46.54	74.00	-27.46
7206.00	Average	29.85	7.50	37.35	54.00	-16.65

Unless otherwise stated the results shown in this test report refer only to the sample(s) tested and such sample(s) are retained for 90 days only.

除非另有說明，此報告結果僅對測試之樣品負責，同時此樣品僅保留90天。本報告未經本公司書面許可，不可部份複製。

This document is issued by the Company subject to its General Conditions of Service printed overleaf, available on request or accessible at <http://www.sgs.com.tw/Terms-and-Conditions> and for electronic format documents, subject to Terms and Conditions for Electronic Documents at <http://www.sgs.com.tw/Terms-and-Conditions>. Attention is drawn to the limitation of liability, indemnification and jurisdiction issues defined therein. Any holder of this document is advised that information contained hereon reflects the Company's findings at the time of its intervention only and within the limits of Client's instructions, if any. The Company's sole responsibility is to its Client and this document does not exonerate parties to a transaction from exercising all their rights and obligations under the transaction documents. This document cannot be reproduced except in full, without prior written approval of the Company. Any unauthorized alteration, forgery or falsification of the content or appearance of this document is unlawful and offenders may be prosecuted to the fullest extent of the law.

Report Number :TERF2404001033ER
 Operation Mode :BLE 2M
 Test Frequency :2402 MHz
 Test Mode :Tx
 EUT Pol :E1 Plane

Test Site :SAC 2
 Test Date :2024-05-07
 Temp./Humi. :24.3°C/59%
 Antenna Pol. :Horizontal
 Engineer :Eason Wang

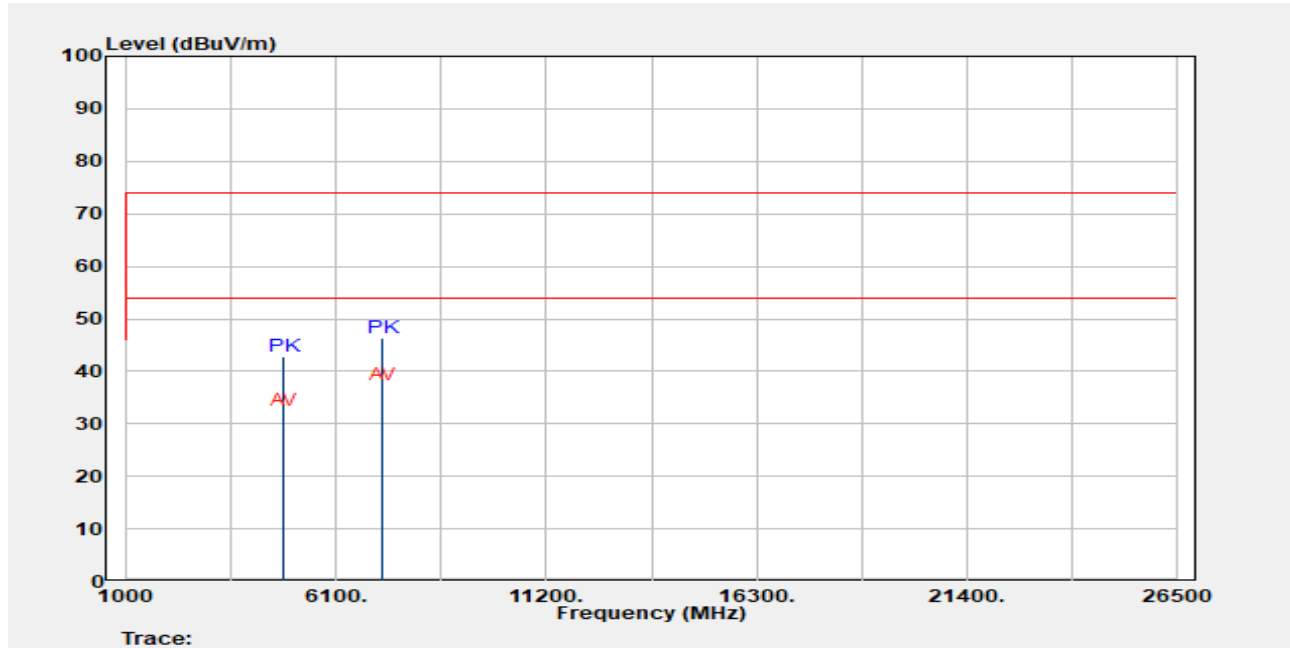

Freq. MHz	Detector Mode PK/QP/AV	Spectrum Reading Level dBμV	Factor dB	Actual FS dBμV/m	Limit @3m dBμV/m	Margin dB
4804.00	Peak	40.65	2.05	42.70	74.00	-31.30
4804.00	Average	30.59	2.05	32.64	54.00	-21.36
7206.00	Peak	38.95	7.50	46.45	74.00	-27.55
7206.00	Average	29.78	7.50	37.28	54.00	-16.72

Unless otherwise stated the results shown in this test report refer only to the sample(s) tested and such sample(s) are retained for 90 days only.

除非另有說明，此報告結果僅對測試之樣品負責，同時此樣品僅保留90天。本報告未經本公司書面許可，不可部份複製。

This document is issued by the Company subject to its General Conditions of Service printed overleaf, available on request or accessible at <http://www.sgs.com.tw/Terms-and-Conditions> and for electronic format documents, subject to Terms and Conditions for Electronic Documents at <http://www.sgs.com.tw/Terms-and-Conditions>. Attention is drawn to the limitation of liability, indemnification and jurisdiction issues defined therein. Any holder of this document is advised that information contained hereon reflects the Company's findings at the time of its intervention only and within the limits of Client's instructions, if any. The Company's sole responsibility is to its Client and this document does not exonerate parties to a transaction from exercising all their rights and obligations under the transaction documents. This document cannot be reproduced except in full, without prior written approval of the Company. Any unauthorized alteration, forgery or falsification of the content or appearance of this document is unlawful and offenders may be prosecuted to the fullest extent of the law.

Report Number :TERF2404001033ER
 Operation Mode :BLE 2M
 Test Frequency :2440 MHz
 Test Mode :Tx
 EUT Pol :E1 Plane

Test Site :SAC 2
 Test Date :2024-05-07
 Temp./Humi. :24.3°C/59%
 Antenna Pol. :Vertical
 Engineer :Eason Wang

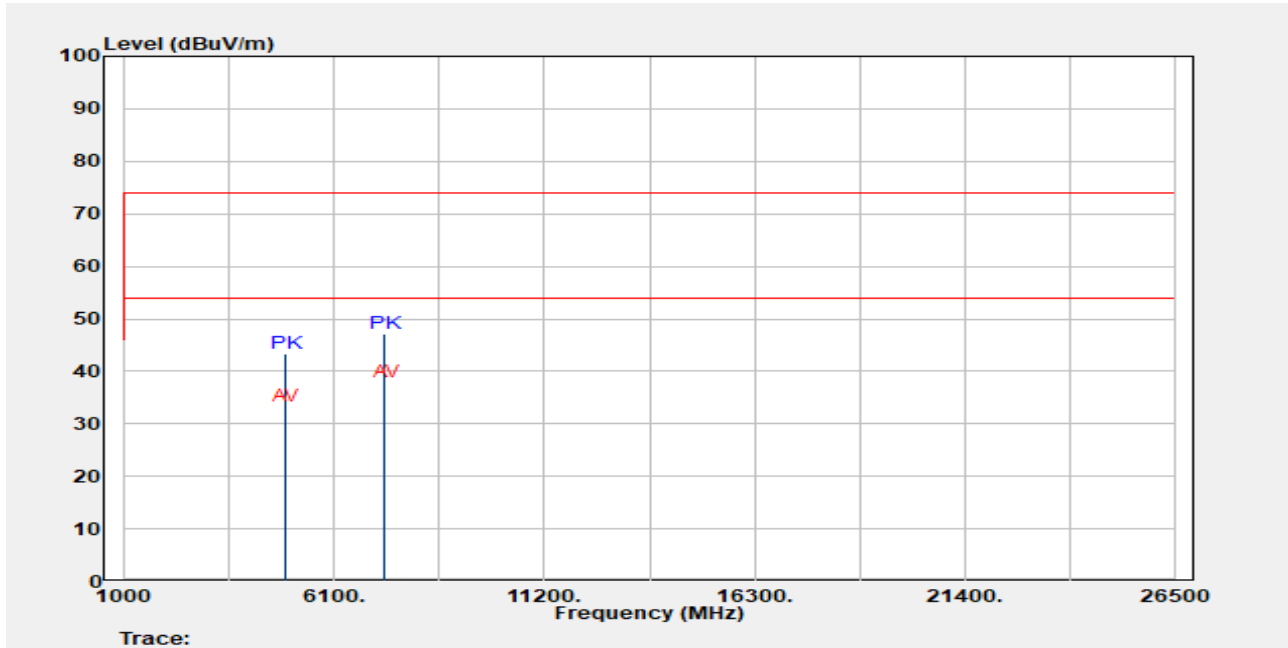

Freq. MHz	Detector Mode PK/QP/AV	Spectrum Reading Level dBμV	Factor dB	Actual FS dBμV/m	Limit @3m dBμV/m	Margin dB
4880.00	Peak	40.83	2.40	43.23	74.00	-30.77
4880.00	Average	30.92	2.40	33.32	54.00	-20.68
7320.00	Peak	39.27	7.84	47.11	74.00	-26.89
7320.00	Average	30.07	7.84	37.91	54.00	-16.09

Unless otherwise stated the results shown in this test report refer only to the sample(s) tested and such sample(s) are retained for 90 days only.

除非另有說明，此報告結果僅對測試之樣品負責，同時此樣品僅保留90天。本報告未經本公司書面許可，不可部份複製。
 This document is issued by the Company subject to its General Conditions of Service printed overleaf, available on request or accessible at <http://www.sgs.com.tw/Terms-and-Conditions> and for electronic format documents, subject to Terms and Conditions for Electronic Documents at <http://www.sgs.com.tw/Terms-and-Conditions>. Attention is drawn to the limitation of liability, indemnification and jurisdiction issues defined therein. Any holder of this document is advised that information contained hereon reflects the Company's findings at the time of its intervention only and within the limits of Client's instructions, if any. The Company's sole responsibility is to its Client and this document does not exonerate parties to a transaction from exercising all their rights and obligations under the transaction documents. This document cannot be reproduced except in full, without prior written approval of the Company. Any unauthorized alteration, forgery or falsification of the content or appearance of this document is unlawful and offenders may be prosecuted to the fullest extent of the law.

Report Number :TERF2404001033ER
 Operation Mode :BLE 2M
 Test Frequency :2440 MHz
 Test Mode :Tx
 EUT Pol :E1 Plane

Test Site :SAC 2
 Test Date :2024-05-07
 Temp./Humi. :24.3°C/59%
 Antenna Pol. :Horizontal
 Engineer :Eason Wang

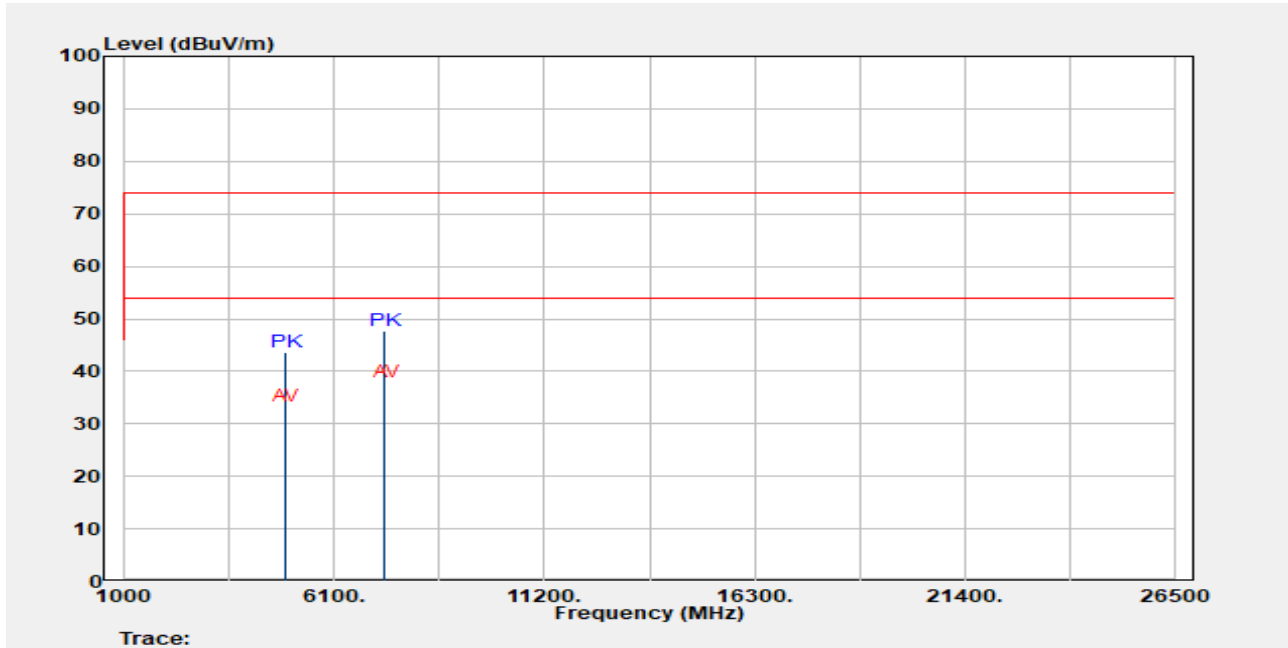

Freq. MHz	Detector Mode PK/QP/AV	Spectrum Reading Level dBμV	Factor dB	Actual FS dBμV/m	Limit @3m dBμV/m	Margin dB
4880.00	Peak	41.24	2.40	43.64	74.00	-30.36
4880.00	Average	30.89	2.40	33.29	54.00	-20.71
7320.00	Peak	39.89	7.84	47.73	74.00	-26.27
7320.00	Average	30.18	7.84	38.02	54.00	-15.98

Unless otherwise stated the results shown in this test report refer only to the sample(s) tested and such sample(s) are retained for 90 days only.

除非另有說明，此報告結果僅對測試之樣品負責，同時此樣品僅保留90天。本報告未經本公司書面許可，不可部份複製。

This document is issued by the Company subject to its General Conditions of Service printed overleaf, available on request or accessible at <http://www.sgs.com.tw/Terms-and-Conditions> and for electronic format documents, subject to Terms and Conditions for Electronic Documents at <http://www.sgs.com.tw/Terms-and-Conditions>. Attention is drawn to the limitation of liability, indemnification and jurisdiction issues defined therein. Any holder of this document is advised that information contained hereon reflects the Company's findings at the time of its intervention only and within the limits of Client's instructions, if any. The Company's sole responsibility is to its Client and this document does not exonerate parties to a transaction from exercising all their rights and obligations under the transaction documents. This document cannot be reproduced except in full, without prior written approval of the Company. Any unauthorized alteration, forgery or falsification of the content or appearance of this document is unlawful and offenders may be prosecuted to the fullest extent of the law.

Report Number :TERF2404001033ER
 Operation Mode :BLE 2M
 Test Frequency :2480 MHz
 Test Mode :Tx
 EUT Pol :E1 Plane

Test Site :SAC 2
 Test Date :2024-05-07
 Temp./Humi. :24.3°C/59%
 Antenna Pol. :Vertical
 Engineer :Eason Wang

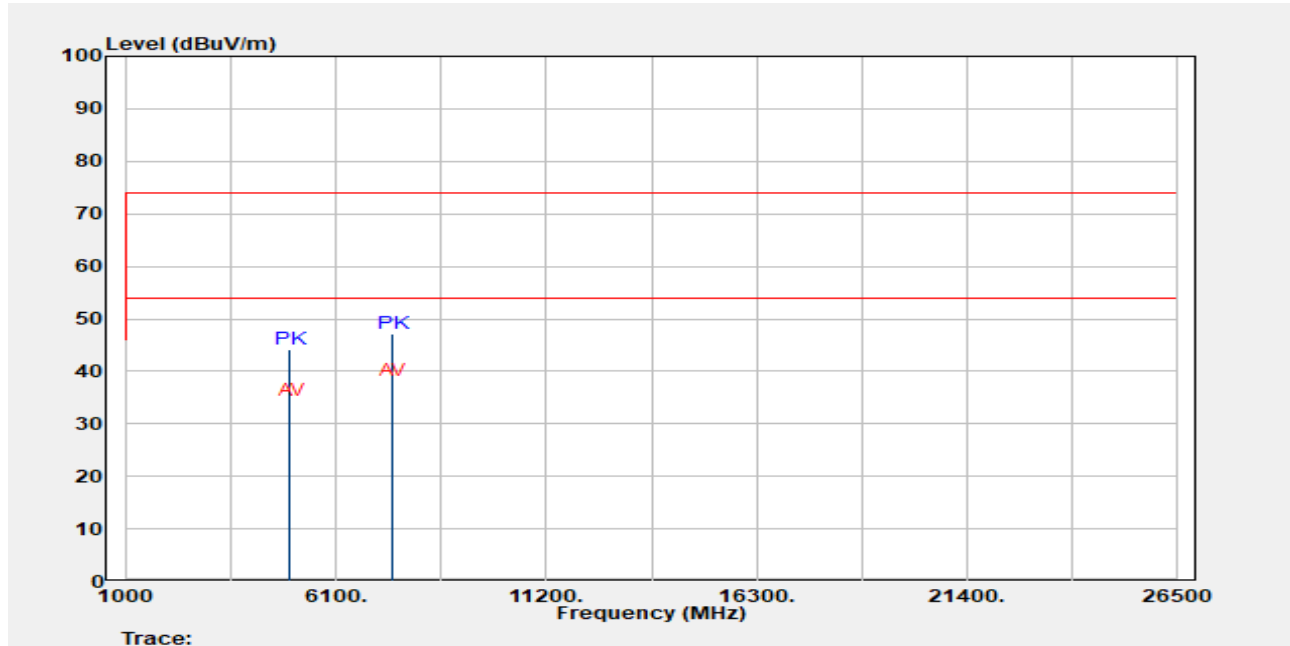

Freq. MHz	Detector Mode PK/QP/AV	Spectrum Reading Level dBμV	Factor dB	Actual FS dBμV/m	Limit @3m dBμV/m	Margin dB
4960.00	Peak	41.42	2.84	44.26	74.00	-29.74
4960.00	Average	31.55	2.84	34.39	54.00	-19.61
7440.00	Peak	39.24	8.02	47.26	74.00	-26.74
7440.00	Average	30.14	8.02	38.16	54.00	-15.84

Unless otherwise stated the results shown in this test report refer only to the sample(s) tested and such sample(s) are retained for 90 days only.

除非另有說明，此報告結果僅對測試之樣品負責，同時此樣品僅保留90天。本報告未經本公司書面許可，不可部份複製。
 This document is issued by the Company subject to its General Conditions of Service printed overleaf, available on request or accessible at <http://www.sgs.com.tw/Terms-and-Conditions> and for electronic format documents, subject to Terms and Conditions for Electronic Documents at <http://www.sgs.com.tw/Terms-and-Conditions>. Attention is drawn to the limitation of liability, indemnification and jurisdiction issues defined therein. Any holder of this document is advised that information contained hereon reflects the Company's findings at the time of its intervention only and within the limits of Client's instructions, if any. The Company's sole responsibility is to its Client and this document does not exonerate parties to a transaction from exercising all their rights and obligations under the transaction documents. This document cannot be reproduced except in full, without prior written approval of the Company. Any unauthorized alteration, forgery or falsification of the content or appearance of this document is unlawful and offenders may be prosecuted to the fullest extent of the law.

Report Number :TERF2404001033ER
 Operation Mode :BLE 2M
 Test Frequency :2480 MHz
 Test Mode :Tx
 EUT Pol :E1 Plane

Test Site :SAC 2
 Test Date :2024-05-07
 Temp./Humi. :24.3°C/59%
 Antenna Pol. :Horizontal
 Engineer :Eason Wang

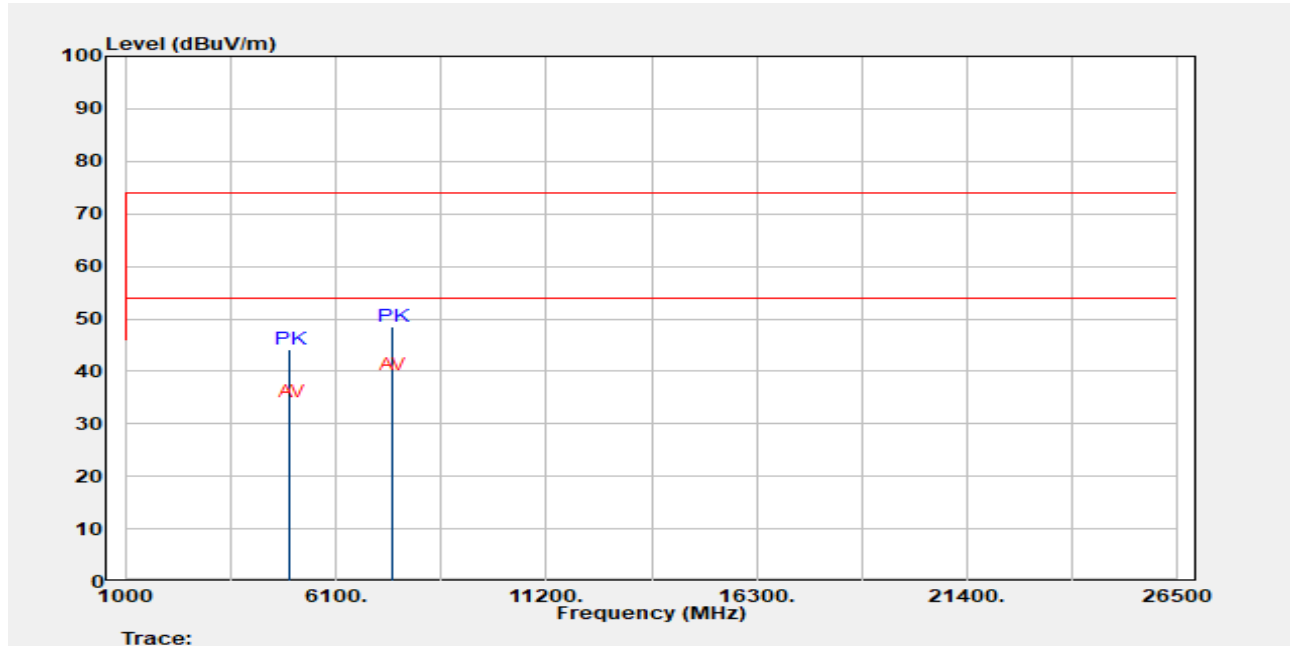

Freq. MHz	Detector Mode PK/QP/AV	Spectrum Reading Level dBμV	Factor dB	Actual FS dBμV/m	Limit @3m dBμV/m	Margin dB
4960.00	Peak	41.23	2.84	44.07	74.00	-29.93
4960.00	Average	31.34	2.84	34.18	54.00	-19.82
7440.00	Peak	40.40	8.02	48.42	74.00	-25.58
7440.00	Average	31.20	8.02	39.22	54.00	-14.78

Unless otherwise stated the results shown in this test report refer only to the sample(s) tested and such sample(s) are retained for 90 days only.

除非另有說明，此報告結果僅對測試之樣品負責，同時此樣品僅保留90天。本報告未經本公司書面許可，不可部份複製。

This document is issued by the Company subject to its General Conditions of Service printed overleaf, available on request or accessible at <http://www.sgs.com.tw/Terms-and-Conditions> and for electronic format documents, subject to Terms and Conditions for Electronic Documents at <http://www.sgs.com.tw/Terms-and-Conditions>. Attention is drawn to the limitation of liability, indemnification and jurisdiction issues defined therein. Any holder of this document is advised that information contained hereon reflects the Company's findings at the time of its intervention only and within the limits of Client's instructions, if any. The Company's sole responsibility is to its Client and this document does not exonerate parties to a transaction from exercising all their rights and obligations under the transaction documents. This document cannot be reproduced except in full, without prior written approval of the Company. Any unauthorized alteration, forgery or falsification of the content or appearance of this document is unlawful and offenders may be prosecuted to the fullest extent of the law.

Report Number :TERF2404001033ER
 Operation Mode :BLE PHY=8
 Test Frequency :2402 MHz
 Test Mode :Tx
 EUT Pol :E1 Plane

Test Site :SAC 2
 Test Date :2024-05-07
 Temp./Humi. :24.3°C/59%
 Antenna Pol. :Vertical
 Engineer :Eason Wang

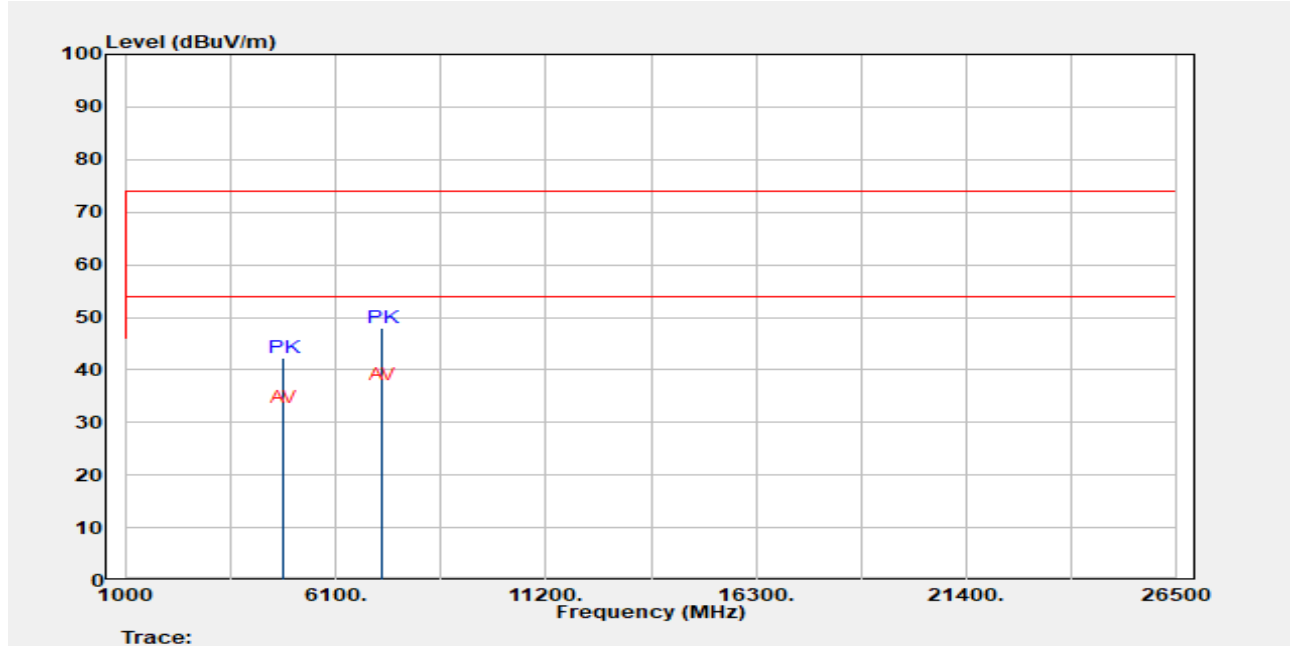

Freq. MHz	Detector Mode PK/QP/AV	Spectrum Reading Level dBμV	Factor dB	Actual FS dBμV/m	Limit @3m dBμV/m	Margin dB
4804.000	Peak	40.24	2.05	42.28	74.00	-31.72
4804.000	Average	30.62	2.05	32.67	54.00	-21.33
7206.000	Peak	40.35	7.50	47.86	74.00	-26.14
7206.000	Average	29.74	7.50	37.24	54.00	-16.76

Unless otherwise stated the results shown in this test report refer only to the sample(s) tested and such sample(s) are retained for 90 days only.

除非另有說明，此報告結果僅對測試之樣品負責，同時此樣品僅保留90天。本報告未經本公司書面許可，不可部份複製。

This document is issued by the Company subject to its General Conditions of Service printed overleaf, available on request or accessible at <http://www.sgs.com.tw/Terms-and-Conditions> and for electronic format documents, subject to Terms and Conditions for Electronic Documents at <http://www.sgs.com.tw/Terms-and-Conditions>. Attention is drawn to the limitation of liability, indemnification and jurisdiction issues defined therein. Any holder of this document is advised that information contained hereon reflects the Company's findings at the time of its intervention only and within the limits of Client's instructions, if any. The Company's sole responsibility is to its Client and this document does not exonerate parties to a transaction from exercising all their rights and obligations under the transaction documents. This document cannot be reproduced except in full, without prior written approval of the Company. Any unauthorized alteration, forgery or falsification of the content or appearance of this document is unlawful and offenders may be prosecuted to the fullest extent of the law.

Report Number :TERF2404001033ER
 Operation Mode :BLE PHY=8
 Test Frequency :2402 MHz
 Test Mode :Tx
 EUT Pol :E1 Plane

Test Site :SAC 2
 Test Date :2024-05-07
 Temp./Humi. :24.3°C/59%
 Antenna Pol. :Horizontal
 Engineer :Eason Wang

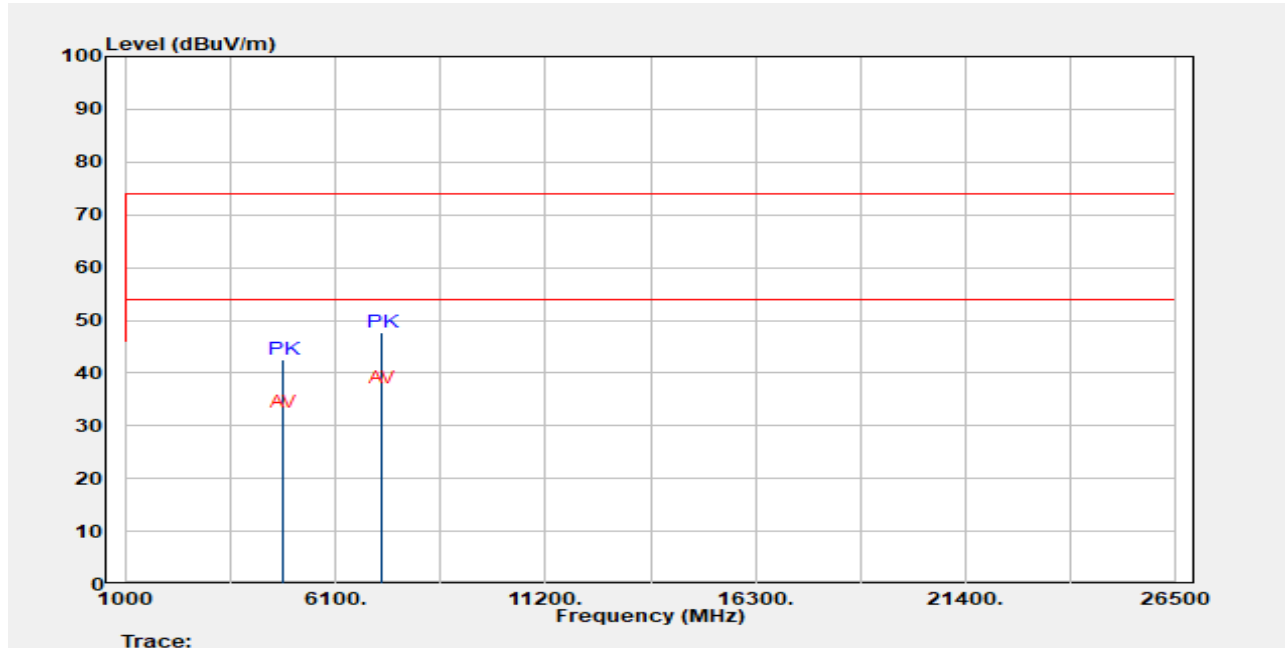

Freq. MHz	Detector Mode PK/QP/AV	Spectrum Reading Level dBμV	Factor dB	Actual FS dBμV/m	Limit @3m dBμV/m	Margin dB
4804.000	Peak	40.38	2.05	42.42	74.00	-31.58
4804.000	Average	30.57	2.05	32.62	54.00	-21.38
7206.000	Peak	40.10	7.50	47.60	74.00	-26.40
7206.000	Average	29.76	7.50	37.26	54.00	-16.74

Unless otherwise stated the results shown in this test report refer only to the sample(s) tested and such sample(s) are retained for 90 days only.

除非另有說明，此報告結果僅對測試之樣品負責，同時此樣品僅保留90天。本報告未經本公司書面許可，不可部份複製。

This document is issued by the Company subject to its General Conditions of Service printed overleaf, available on request or accessible at <http://www.sgs.com.tw/Terms-and-Conditions> and for electronic format documents, subject to Terms and Conditions for Electronic Documents at <http://www.sgs.com.tw/Terms-and-Conditions>. Attention is drawn to the limitation of liability, indemnification and jurisdiction issues defined therein. Any holder of this document is advised that information contained hereon reflects the Company's findings at the time of its intervention only and within the limits of Client's instructions, if any. The Company's sole responsibility is to its Client and this document does not exonerate parties to a transaction from exercising all their rights and obligations under the transaction documents. This document cannot be reproduced except in full, without prior written approval of the Company. Any unauthorized alteration, forgery or falsification of the content or appearance of this document is unlawful and offenders may be prosecuted to the fullest extent of the law.

Report Number :TERF2404001033ER
 Operation Mode :BLE PHY=8
 Test Frequency :2440 MHz
 Test Mode :Tx
 EUT Pol :E1 Plane

Test Site :SAC 2
 Test Date :2024-05-07
 Temp./Humi. :24.3°C/59%
 Antenna Pol. :Vertical
 Engineer :Eason Wang

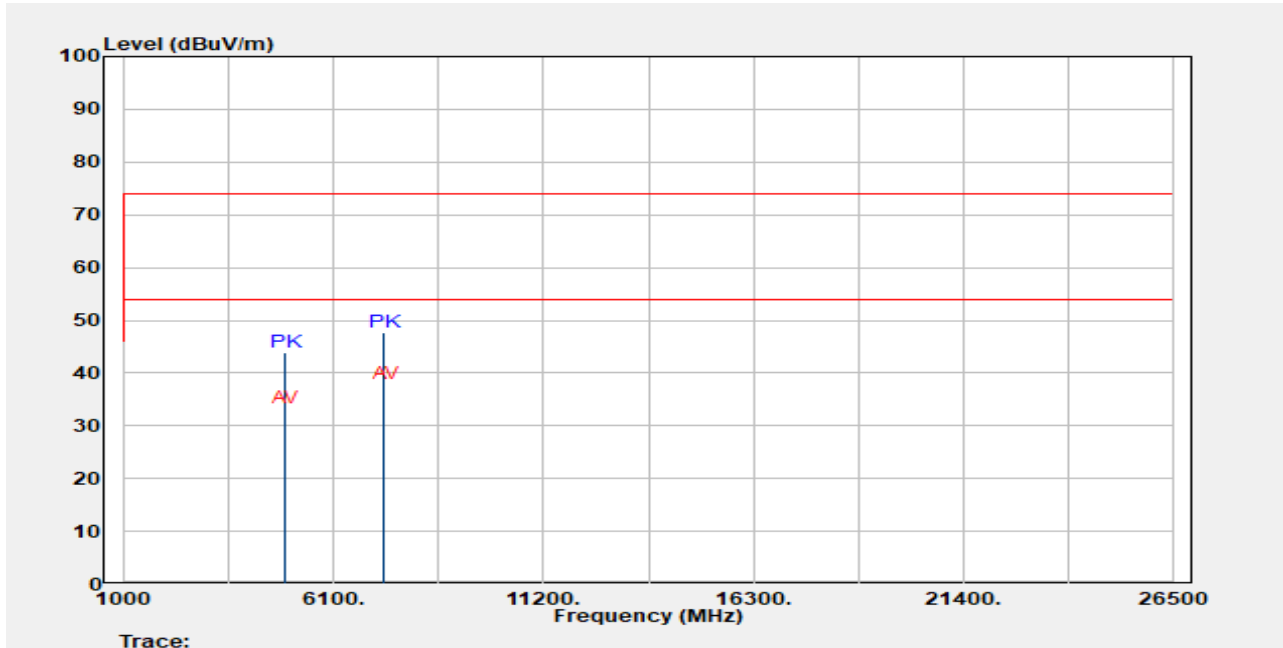

Freq. MHz	Detector Mode PK/QP/AV	Spectrum Reading Level dBμV	Factor dB	Actual FS dBμV/m	Limit @3m dBμV/m	Margin dB
4880.000	Peak	41.38	2.40	43.78	74.00	-30.22
4880.000	Average	30.81	2.40	33.21	54.00	-20.79
7320.000	Peak	39.86	7.84	47.70	74.00	-26.30
7320.000	Average	30.10	7.84	37.94	54.00	-16.06

Unless otherwise stated the results shown in this test report refer only to the sample(s) tested and such sample(s) are retained for 90 days only.

除非另有說明，此報告結果僅對測試之樣品負責，同時此樣品僅保留90天。本報告未經本公司書面許可，不可部份複製。

This document is issued by the Company subject to its General Conditions of Service printed overleaf, available on request or accessible at <http://www.sgs.com.tw/Terms-and-Conditions> and for electronic format documents, subject to Terms and Conditions for Electronic Documents at <http://www.sgs.com.tw/Terms-and-Conditions>. Attention is drawn to the limitation of liability, indemnification and jurisdiction issues defined therein. Any holder of this document is advised that information contained hereon reflects the Company's findings at the time of its intervention only and within the limits of Client's instructions, if any. The Company's sole responsibility is to its Client and this document does not exonerate parties to a transaction from exercising all their rights and obligations under the transaction documents. This document cannot be reproduced except in full, without prior written approval of the Company. Any unauthorized alteration, forgery or falsification of the content or appearance of this document is unlawful and offenders may be prosecuted to the fullest extent of the law.

Report Number :TERF2404001033ER
 Operation Mode :BLE PHY=8
 Test Frequency :2440 MHz
 Test Mode :Tx
 EUT Pol :E1 Plane

Test Site :SAC 2
 Test Date :2024-05-07
 Temp./Humi. :24.3°C/59%
 Antenna Pol. :Horizontal
 Engineer :Eason Wang

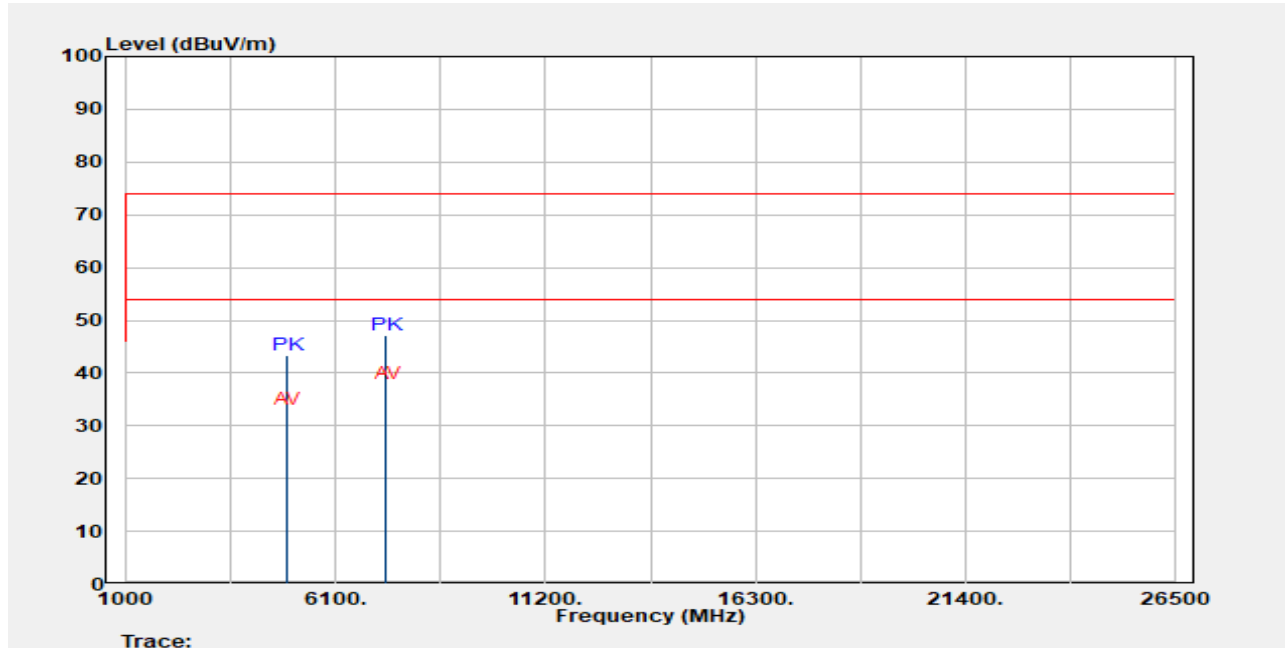

Freq. MHz	Detector Mode PK/QP/AV	Spectrum Reading Level dBμV	Factor dB	Actual FS dBμV/m	Limit @3m dBμV/m	Margin dB
4880.000	Peak	41.09	2.40	43.49	74.00	-30.51
4880.000	Average	30.77	2.40	33.17	54.00	-20.83
7320.000	Peak	39.22	7.84	47.06	74.00	-26.94
7320.000	Average	30.07	7.84	37.91	54.00	-16.09

Unless otherwise stated the results shown in this test report refer only to the sample(s) tested and such sample(s) are retained for 90 days only.

除非另有說明，此報告結果僅對測試之樣品負責，同時此樣品僅保留90天。本報告未經本公司書面許可，不可部份複製。

This document is issued by the Company subject to its General Conditions of Service printed overleaf, available on request or accessible at <http://www.sgs.com.tw/Terms-and-Conditions> and for electronic format documents, subject to Terms and Conditions for Electronic Documents at <http://www.sgs.com.tw/Terms-and-Conditions>. Attention is drawn to the limitation of liability, indemnification and jurisdiction issues defined therein. Any holder of this document is advised that information contained hereon reflects the Company's findings at the time of its intervention only and within the limits of Client's instructions, if any. The Company's sole responsibility is to its Client and this document does not exonerate parties to a transaction from exercising all their rights and obligations under the transaction documents. This document cannot be reproduced except in full, without prior written approval of the Company. Any unauthorized alteration, forgery or falsification of the content or appearance of this document is unlawful and offenders may be prosecuted to the fullest extent of the law.

Report Number :TERF2404001033ER
 Operation Mode :BLE PHY=8
 Test Frequency :2480 MHz
 Test Mode :Tx
 EUT Pol :E1 Plane

Test Site :SAC 2
 Test Date :2024-05-07
 Temp./Humi. :24.3°C/59%
 Antenna Pol. :Vertical
 Engineer :Eason Wang

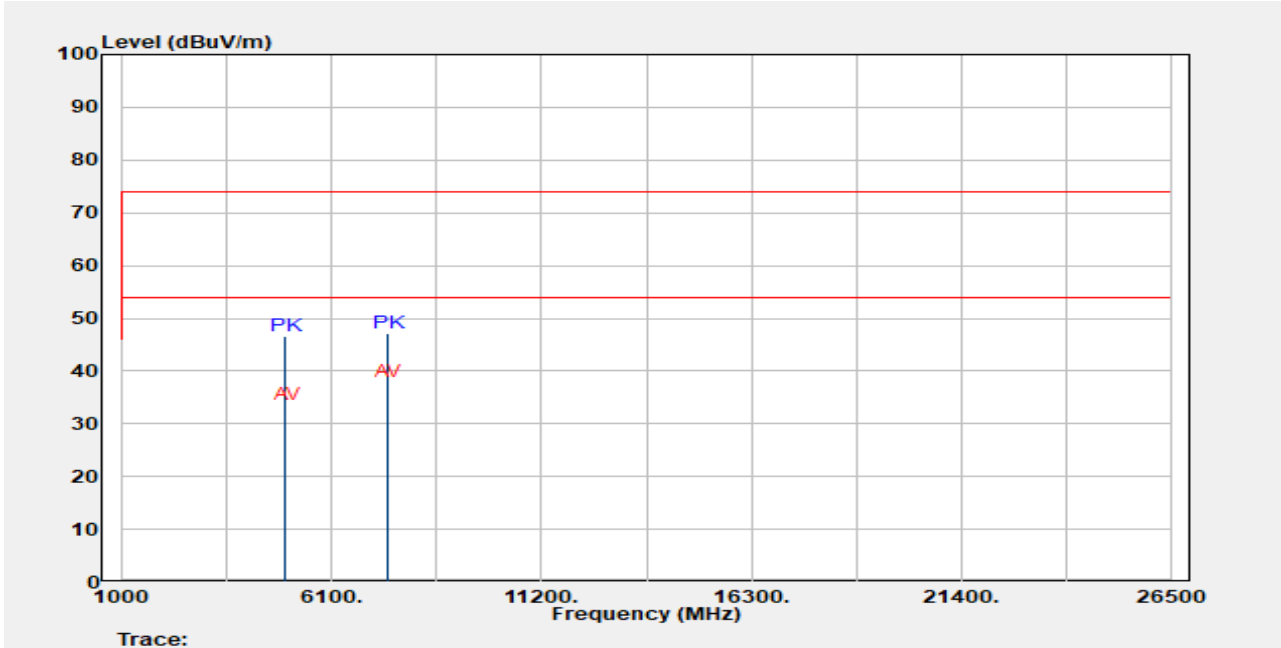

Freq. MHz	Detector Mode PK/QP/AV	Spectrum Reading Level dBμV	Factor dB	Actual FS dBμV/m	Limit @3m dBμV/m	Margin dB
4960.000	Peak	43.91	2.84	46.74	74.00	-27.26
4960.000	Average	30.85	2.84	33.69	54.00	-20.31
7440.000	Peak	39.17	8.02	47.18	74.00	-26.82
7440.000	Average	29.80	8.02	37.82	54.00	-16.18

Unless otherwise stated the results shown in this test report refer only to the sample(s) tested and such sample(s) are retained for 90 days only.

除非另有說明，此報告結果僅對測試之樣品負責，同時此樣品僅保留90天。本報告未經本公司書面許可，不可部份複製。

This document is issued by the Company subject to its General Conditions of Service printed overleaf, available on request or accessible at <http://www.sgs.com.tw/Terms-and-Conditions> and for electronic format documents, subject to Terms and Conditions for Electronic Documents at <http://www.sgs.com.tw/Terms-and-Conditions>. Attention is drawn to the limitation of liability, indemnification and jurisdiction issues defined therein. Any holder of this document is advised that information contained hereon reflects the Company's findings at the time of its intervention only and within the limits of Client's instructions, if any. The Company's sole responsibility is to its Client and this document does not exonerate parties to a transaction from exercising all their rights and obligations under the transaction documents. This document cannot be reproduced except in full, without prior written approval of the Company. Any unauthorized alteration, forgery or falsification of the content or appearance of this document is unlawful and offenders may be prosecuted to the fullest extent of the law.

Report Number :TERF2404001033ER
 Operation Mode :BLE PHY=8
 Test Frequency :2480 MHz
 Test Mode :Tx
 EUT Pol :E1 Plane

Test Site :SAC 2
 Test Date :2024-05-07
 Temp./Humi. :24.3°C/59%
 Antenna Pol. :Horizontal
 Engineer :Eason Wang

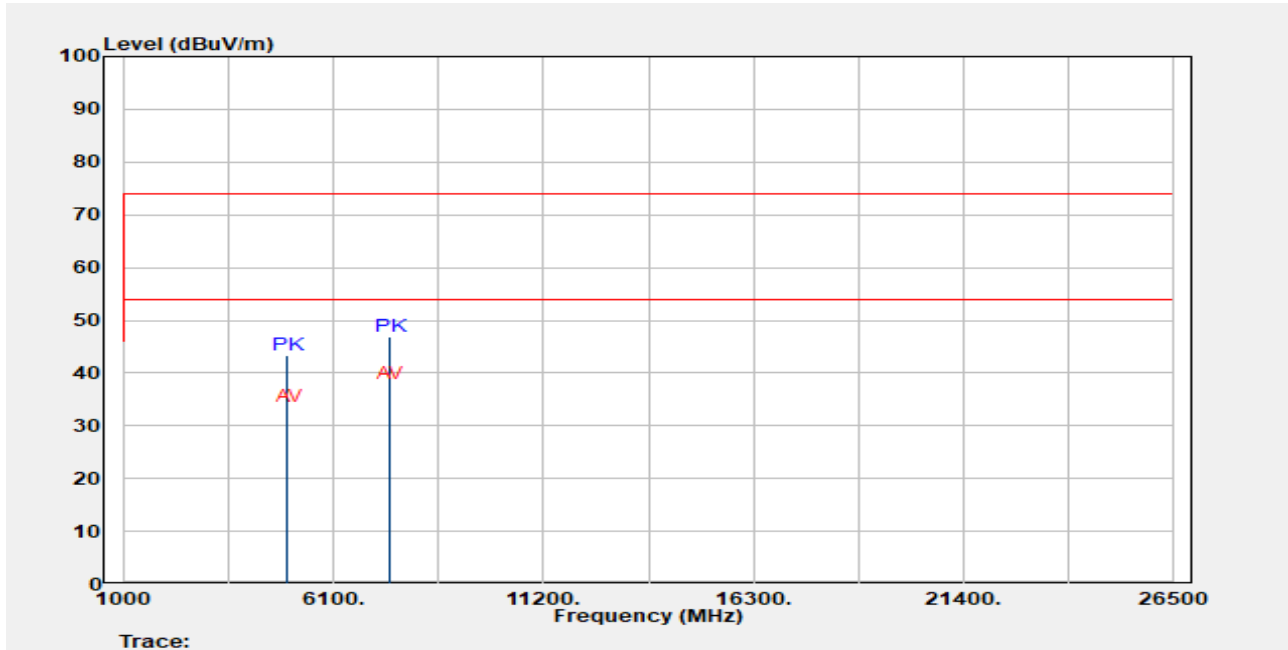

Freq. MHz	Detector Mode PK/QP/AV	Spectrum Reading Level dBμV	Factor dB	Actual FS dBμV/m	Limit @3m dBμV/m	Margin dB
4960.000	Peak	40.47	2.84	43.31	74.00	-30.69
4960.000	Average	30.89	2.84	33.73	54.00	-20.27
7440.000	Peak	38.85	8.02	46.87	74.00	-27.13
7440.000	Average	29.83	8.02	37.85	54.00	-16.15

Unless otherwise stated the results shown in this test report refer only to the sample(s) tested and such sample(s) are retained for 90 days only.

除非另有說明，此報告結果僅對測試之樣品負責，同時此樣品僅保留90天。本報告未經本公司書面許可，不可部份複製。

This document is issued by the Company subject to its General Conditions of Service printed overleaf, available on request or accessible at <http://www.sgs.com.tw/Terms-and-Conditions> and for electronic format documents, subject to Terms and Conditions for Electronic Documents at <http://www.sgs.com.tw/Terms-and-Conditions>. Attention is drawn to the limitation of liability, indemnification and jurisdiction issues defined therein. Any holder of this document is advised that information contained hereon reflects the Company's findings at the time of its intervention only and within the limits of Client's instructions, if any. The Company's sole responsibility is to its Client and this document does not exonerate parties to a transaction from exercising all their rights and obligations under the transaction documents. This document cannot be reproduced except in full, without prior written approval of the Company. Any unauthorized alteration, forgery or falsification of the content or appearance of this document is unlawful and offenders may be prosecuted to the fullest extent of the law.

Report Number :TERF2404001033ER
 Operation Mode :BLE PHY=2
 Test Frequency :2402 MHz
 Test Mode :Tx
 EUT Pol :E1 Plane

Test Site :SAC 2
 Test Date :2024-05-07
 Temp./Humi. :24.3°C/59%
 Antenna Pol. :Vertical
 Engineer :Eason Wang

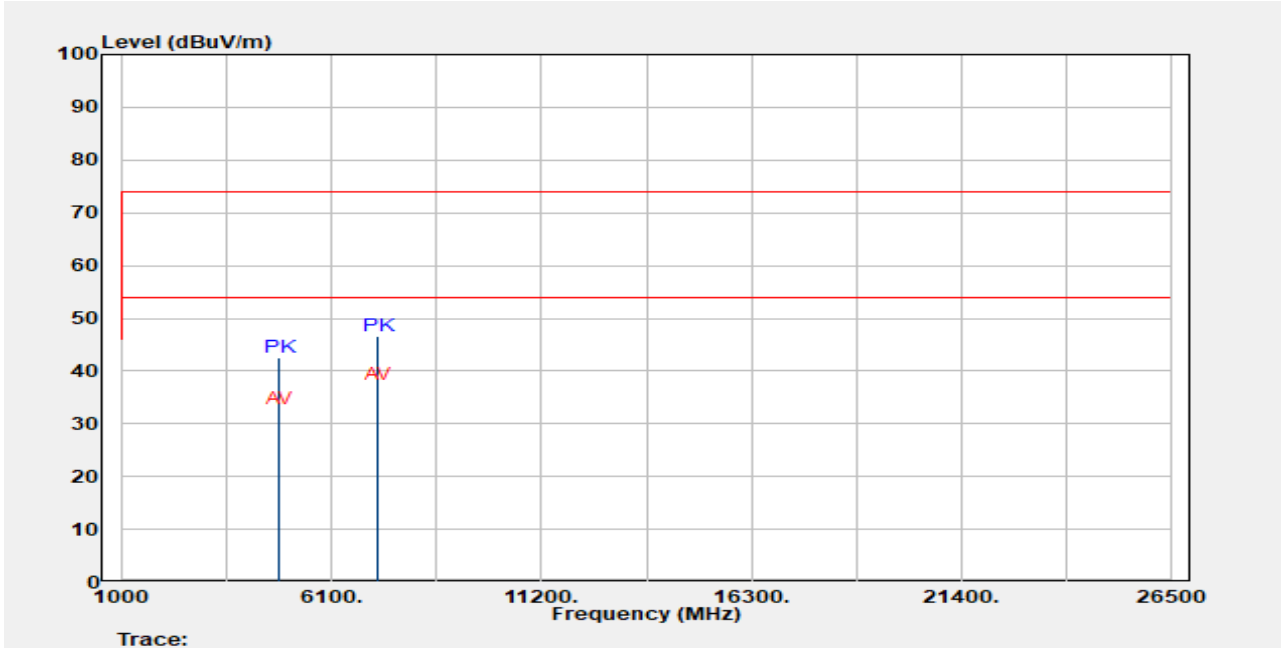

Freq. MHz	Detector Mode PK/QP/AV	Spectrum Reading Level dBuV	Factor dB	Actual FS dBuV/m	Limit @3m dBuV/m	Margin dB
4804.000	Peak	40.46	2.05	42.51	74.00	-31.49
4804.000	Average	30.65	2.05	32.70	54.00	-21.30
7206.000	Peak	39.23	7.50	46.73	74.00	-27.27
7206.000	Average	29.87	7.50	37.37	54.00	-16.63

Unless otherwise stated the results shown in this test report refer only to the sample(s) tested and such sample(s) are retained for 90 days only.

除非另有說明，此報告結果僅對測試之樣品負責，同時此樣品僅保留90天。本報告未經本公司書面許可，不可部份複製。

This document is issued by the Company subject to its General Conditions of Service printed overleaf, available on request or accessible at <http://www.sgs.com.tw/Terms-and-Conditions> and for electronic format documents, subject to Terms and Conditions for Electronic Documents at <http://www.sgs.com.tw/Terms-and-Conditions>. Attention is drawn to the limitation of liability, indemnification and jurisdiction issues defined therein. Any holder of this document is advised that information contained hereon reflects the Company's findings at the time of its intervention only and within the limits of Client's instructions, if any. The Company's sole responsibility is to its Client and this document does not exonerate parties to a transaction from exercising all their rights and obligations under the transaction documents. This document cannot be reproduced except in full, without prior written approval of the Company. Any unauthorized alteration, forgery or falsification of the content or appearance of this document is unlawful and offenders may be prosecuted to the fullest extent of the law.

Report Number :TERF2404001033ER
 Operation Mode :BLE PHY=2
 Test Frequency :2402 MHz
 Test Mode :Tx
 EUT Pol :E1 Plane

Test Site :SAC 2
 Test Date :2024-05-07
 Temp./Humi. :24.3°C/59%
 Antenna Pol. :Horizontal
 Engineer :Eason Wang

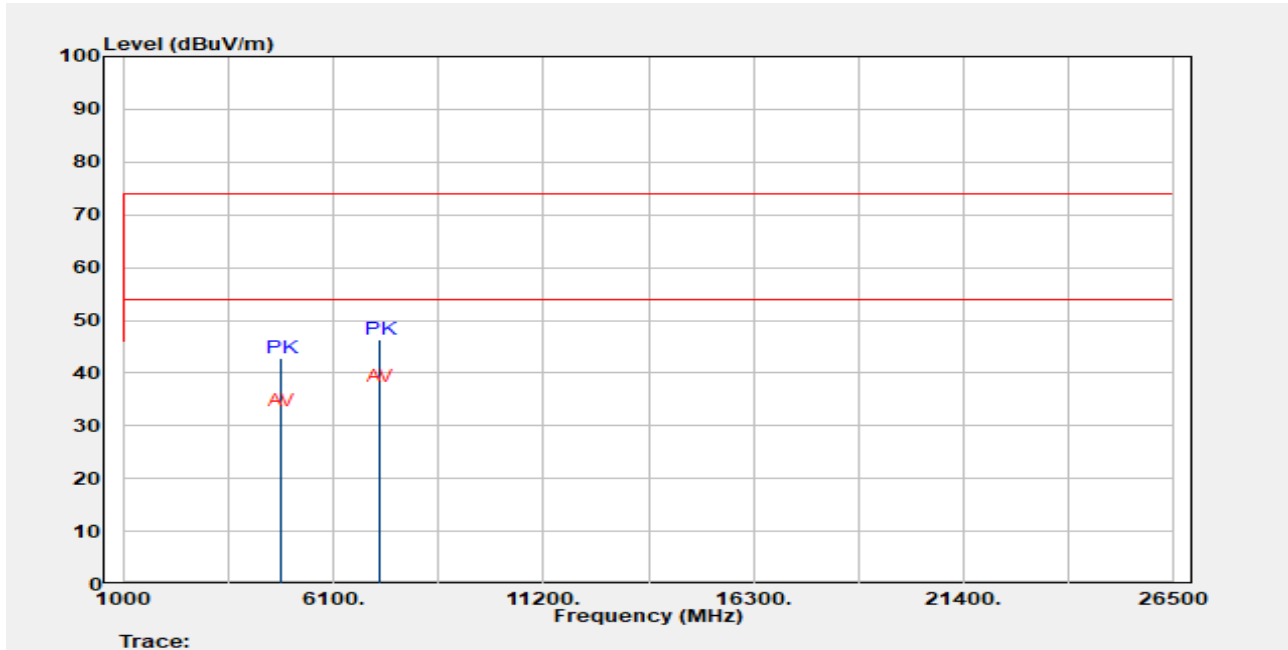

Freq. MHz	Detector Mode PK/QP/AV	Spectrum Reading Level dBμV	Factor dB	Actual FS dBμV/m	Limit @3m dBμV/m	Margin dB
4804.000	Peak	40.86	2.05	42.91	74.00	-31.09
4804.000	Average	30.71	2.05	32.76	54.00	-21.24
7206.000	Peak	38.81	7.50	46.31	74.00	-27.69
7206.000	Average	29.78	7.50	37.28	54.00	-16.72

Unless otherwise stated the results shown in this test report refer only to the sample(s) tested and such sample(s) are retained for 90 days only.

除非另有說明，此報告結果僅對測試之樣品負責，同時此樣品僅保留90天。本報告未經本公司書面許可，不可部份複製。

This document is issued by the Company subject to its General Conditions of Service printed overleaf, available on request or accessible at <http://www.sgs.com.tw/Terms-and-Conditions> and for electronic format documents, subject to Terms and Conditions for Electronic Documents at <http://www.sgs.com.tw/Terms-and-Conditions>. Attention is drawn to the limitation of liability, indemnification and jurisdiction issues defined therein. Any holder of this document is advised that information contained hereon reflects the Company's findings at the time of its intervention only and within the limits of Client's instructions, if any. The Company's sole responsibility is to its Client and this document does not exonerate parties to a transaction from exercising all their rights and obligations under the transaction documents. This document cannot be reproduced except in full, without prior written approval of the Company. Any unauthorized alteration, forgery or falsification of the content or appearance of this document is unlawful and offenders may be prosecuted to the fullest extent of the law.

Report Number :TERF2404001033ER
 Operation Mode :BLE PHY=2
 Test Frequency :2440 MHz
 Test Mode :Tx
 EUT Pol :E1 Plane

Test Site :SAC 2
 Test Date :2024-05-07
 Temp./Humi. :24.3°C/59%
 Antenna Pol. :Vertical
 Engineer :Eason Wang

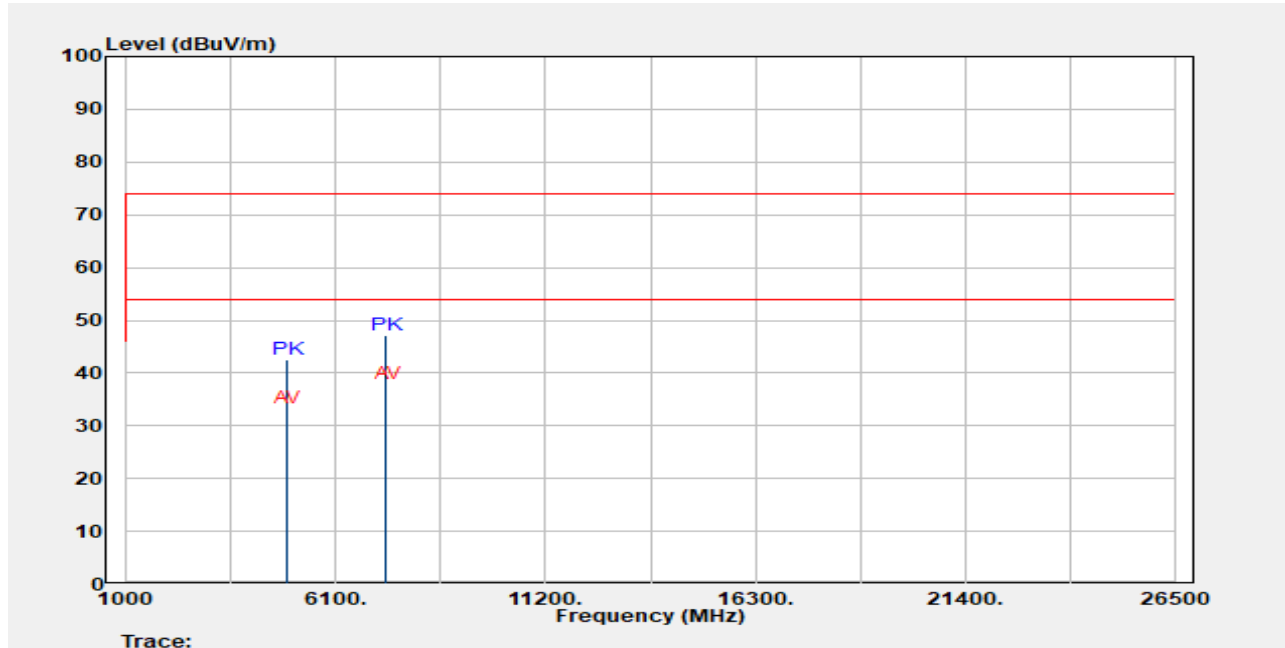

Freq. MHz	Detector Mode PK/QP/AV	Spectrum Reading Level dBμV	Factor dB	Actual FS dBμV/m	Limit @3m dBμV/m	Margin dB
4880.000	Peak	40.24	2.40	42.64	74.00	-31.36
4880.000	Average	30.82	2.40	33.22	54.00	-20.78
7320.000	Peak	39.33	7.84	47.17	74.00	-26.83
7320.000	Average	30.22	7.84	38.06	54.00	-15.94

Unless otherwise stated the results shown in this test report refer only to the sample(s) tested and such sample(s) are retained for 90 days only.

除非另有說明，此報告結果僅對測試之樣品負責，同時此樣品僅保留90天。本報告未經本公司書面許可，不可部份複製。

This document is issued by the Company subject to its General Conditions of Service printed overleaf, available on request or accessible at <http://www.sgs.com.tw/Terms-and-Conditions> and for electronic format documents, subject to Terms and Conditions for Electronic Documents at <http://www.sgs.com.tw/Terms-and-Conditions>. Attention is drawn to the limitation of liability, indemnification and jurisdiction issues defined therein. Any holder of this document is advised that information contained hereon reflects the Company's findings at the time of its intervention only and within the limits of Client's instructions, if any. The Company's sole responsibility is to its Client and this document does not exonerate parties to a transaction from exercising all their rights and obligations under the transaction documents. This document cannot be reproduced except in full, without prior written approval of the Company. Any unauthorized alteration, forgery or falsification of the content or appearance of this document is unlawful and offenders may be prosecuted to the fullest extent of the law.

Report Number :TERF2404001033ER
 Operation Mode :BLE PHY=2
 Test Frequency :2440 MHz
 Test Mode :Tx
 EUT Pol :E1 Plane

Test Site :SAC 2
 Test Date :2024-05-07
 Temp./Humi. :24.3°C/59%
 Antenna Pol. :Horizontal
 Engineer :Eason Wang

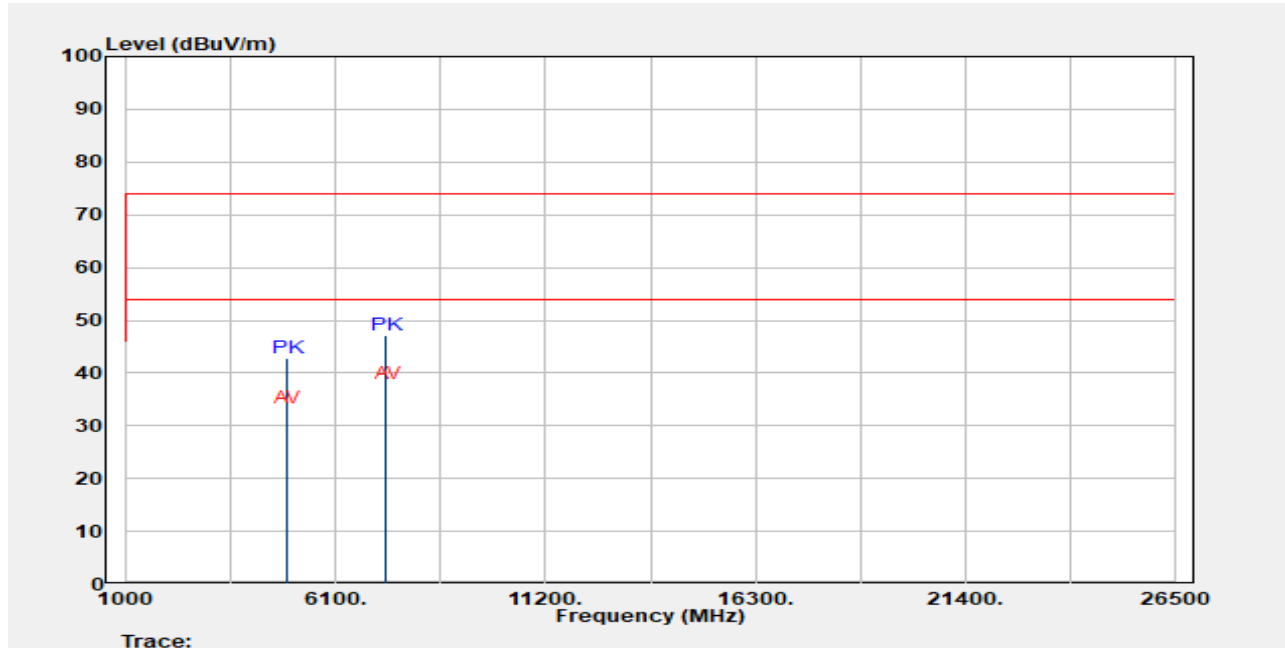

Freq. MHz	Detector Mode PK/QP/AV	Spectrum Reading Level dBuV	Factor dB	Actual FS dBuV/m	Limit @3m dBuV/m	Margin dB
4880.000	Peak	40.49	2.40	42.89	74.00	-31.11
4880.000	Average	30.97	2.40	33.37	54.00	-20.63
7320.000	Peak	39.28	7.84	47.11	74.00	-26.89
7320.000	Average	30.20	7.84	38.04	54.00	-15.96

Unless otherwise stated the results shown in this test report refer only to the sample(s) tested and such sample(s) are retained for 90 days only.

除非另有說明，此報告結果僅對測試之樣品負責，同時此樣品僅保留90天。本報告未經本公司書面許可，不可部份複製。

This document is issued by the Company subject to its General Conditions of Service printed overleaf, available on request or accessible at <http://www.sgs.com.tw/Terms-and-Conditions> and for electronic format documents, subject to Terms and Conditions for Electronic Documents at <http://www.sgs.com.tw/Terms-and-Conditions>. Attention is drawn to the limitation of liability, indemnification and jurisdiction issues defined therein. Any holder of this document is advised that information contained hereon reflects the Company's findings at the time of its intervention only and within the limits of Client's instructions, if any. The Company's sole responsibility is to its Client and this document does not exonerate parties to a transaction from exercising all their rights and obligations under the transaction documents. This document cannot be reproduced except in full, without prior written approval of the Company. Any unauthorized alteration, forgery or falsification of the content or appearance of this document is unlawful and offenders may be prosecuted to the fullest extent of the law.

Report Number :TERF2404001033ER
 Operation Mode :BLE PHY=2
 Test Frequency :2480 MHz
 Test Mode :Tx
 EUT Pol :E1 Plane

Test Site :SAC 2
 Test Date :2024-05-07
 Temp./Humi. :24.3°C/59%
 Antenna Pol. :Vertical
 Engineer :Eason Wang

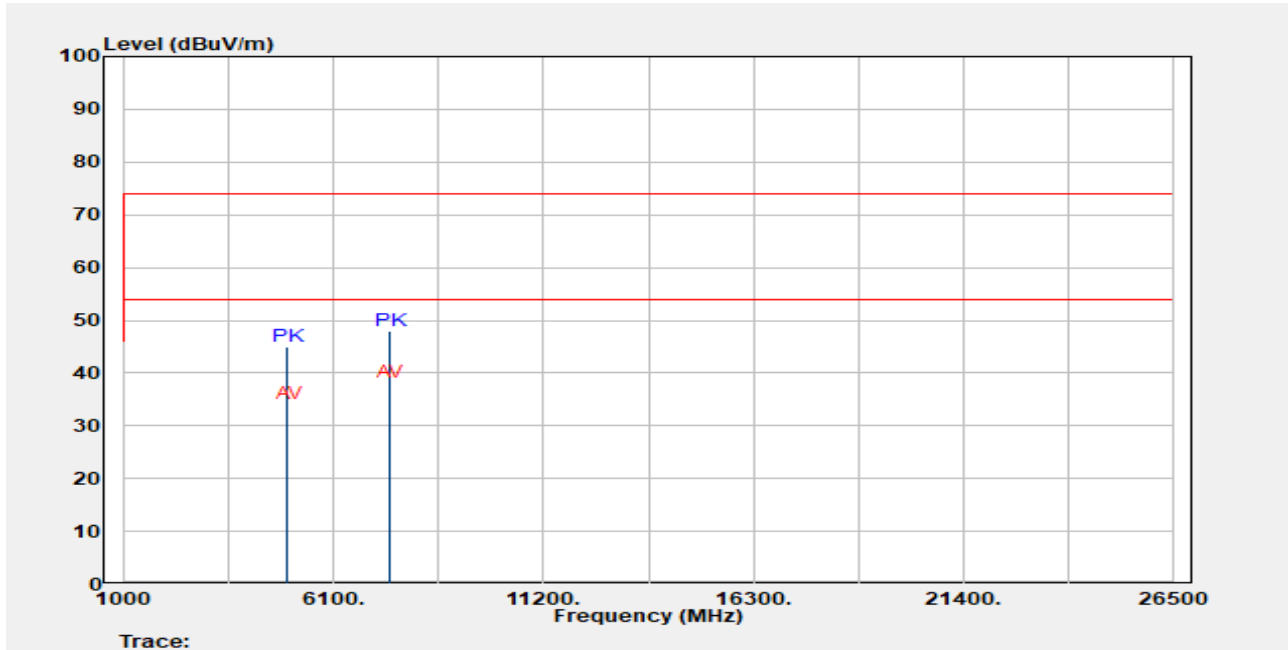

Freq. MHz	Detector Mode PK/QP/AV	Spectrum Reading Level dBμV	Factor dB	Actual FS dBμV/m	Limit @3m dBμV/m	Margin dB
4960.000	Peak	42.27	2.84	45.11	74.00	-28.89
4960.000	Average	31.39	2.84	34.23	54.00	-19.77
7440.000	Peak	40.08	8.02	48.09	74.00	-25.91
7440.000	Average	30.30	8.02	38.32	54.00	-15.68

Unless otherwise stated the results shown in this test report refer only to the sample(s) tested and such sample(s) are retained for 90 days only.

除非另有說明，此報告結果僅對測試之樣品負責，同時此樣品僅保留90天。本報告未經本公司書面許可，不可部份複製。

This document is issued by the Company subject to its General Conditions of Service printed overleaf, available on request or accessible at <http://www.sgs.com.tw/Terms-and-Conditions> and for electronic format documents, subject to Terms and Conditions for Electronic Documents at <http://www.sgs.com.tw/Terms-and-Conditions>. Attention is drawn to the limitation of liability, indemnification and jurisdiction issues defined therein. Any holder of this document is advised that information contained hereon reflects the Company's findings at the time of its intervention only and within the limits of Client's instructions, if any. The Company's sole responsibility is to its Client and this document does not exonerate parties to a transaction from exercising all their rights and obligations under the transaction documents. This document cannot be reproduced except in full, without prior written approval of the Company. Any unauthorized alteration, forgery or falsification of the content or appearance of this document is unlawful and offenders may be prosecuted to the fullest extent of the law.

Report Number :TERF2404001033ER
 Operation Mode :BLE PHY=2
 Test Frequency :2480 MHz
 Test Mode :Tx
 EUT Pol :E1 Plane

Test Site :SAC 2
 Test Date :2024-05-07
 Temp./Humi. :24.3°C/59%
 Antenna Pol. :Horizontal
 Engineer :Eason Wang

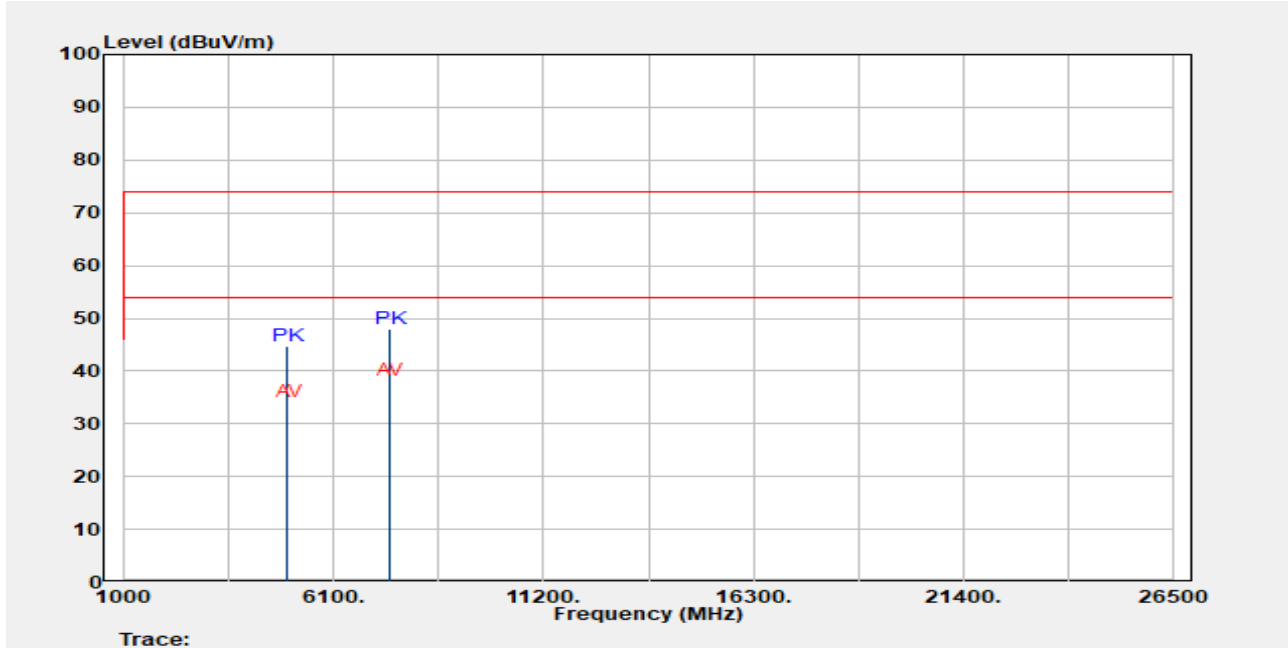

Freq. MHz	Detector Mode PK/QP/AV	Spectrum Reading Level dBμV	Factor dB	Actual FS dBμV/m	Limit @3m dBμV/m	Margin dB
4960.000	Peak	41.85	2.84	44.69	74.00	-29.31
4960.000	Average	31.38	2.84	34.22	54.00	-19.78
7440.000	Peak	39.98	8.02	47.99	74.00	-26.01
7440.000	Average	30.18	8.02	38.20	54.00	-15.80

Unless otherwise stated the results shown in this test report refer only to the sample(s) tested and such sample(s) are retained for 90 days only.

除非另有說明，此報告結果僅對測試之樣品負責，同時此樣品僅保留90天。本報告未經本公司書面許可，不可部份複製。

This document is issued by the Company subject to its General Conditions of Service printed overleaf, available on request or accessible at <http://www.sgs.com.tw/Terms-and-Conditions> and for electronic format documents, subject to Terms and Conditions for Electronic Documents at <http://www.sgs.com.tw/Terms-and-Conditions>. Attention is drawn to the limitation of liability, indemnification and jurisdiction issues defined therein. Any holder of this document is advised that information contained hereon reflects the Company's findings at the time of its intervention only and within the limits of Client's instructions, if any. The Company's sole responsibility is to its Client and this document does not exonerate parties to a transaction from exercising all their rights and obligations under the transaction documents. This document cannot be reproduced except in full, without prior written approval of the Company. Any unauthorized alteration, forgery or falsification of the content or appearance of this document is unlawful and offenders may be prosecuted to the fullest extent of the law.

12 POWER SPECTRAL DENSITY

12.1 Standard Applicable:

Per Part 15.247 (e)

The power spectral density conducted from the intentional radiator to the antenna shall not be greater than 8dBm in any 3 kHz band during any time interval of continuous transmission.

12.2 Test Setup

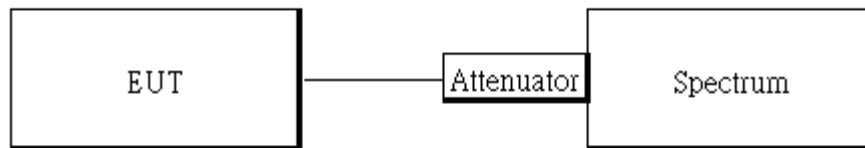

12.3 Measurement Procedure:

1. Set analyzer center frequency to DTS channel center frequency.
2. The testing follows the Measurement Procedure of FCC KDB 558074 D01 DTS Meas. Guidance.
3. Set the span to 1.5 times the DTS channel bandwidth.
4. Set the RBW = 3 kHz. & the VBW = 10 kHz
5. Detector = peak.
6. Sweep time = auto couple.
7. Trace mode = max hold.
8. Allow trace to fully stabilize.
9. Use the peak marker function to determine the maximum amplitude level.

12.4 Measurement Result:

Mode: ANT4

BLE 1M mode

Frequency (MHz)	RF Power Density (dBm/3kHz)	Maximum Limit (dBm/3kHz)	Result
2402	-8.79	8	PASS
2440	-8.75	8	PASS
2480	-8.71	8	PASS

***Note:**

1.cable loss as 0.96dB that offsets in the spectrum

Unless otherwise stated the results shown in this test report refer only to the sample(s) tested and such sample(s) are retained for 90 days only.

除非另有說明，此報告結果僅對測試之樣品負責，同時此樣品僅保留90天。本報告未經本公司書面許可，不可部份複製。

This document is issued by the Company subject to its General Conditions of Service printed overleaf, available on request or accessible at <http://www.sgs.com.tw/Terms-and-Conditions> and for electronic format documents, subject to Terms and Conditions for Electronic Documents at <http://www.sgs.com.tw/Terms-and-Conditions>. Attention is drawn to the limitation of liability, indemnification and jurisdiction issues defined therein. Any holder of this document is advised that information contained hereon reflects the Company's findings at the time of its intervention only and within the limits of Client's instructions, if any. The Company's sole responsibility is to its Client and this document does not exonerate parties to a transaction from exercising all their rights and obligations under the transaction documents. This document cannot be reproduced except in full, without prior written approval of the Company. Any unauthorized alteration, forgery or falsification of the content or appearance of this document is unlawful and offenders may be prosecuted to the fullest extent of the law.

BLE 2M mode

Frequency (MHz)	RF Power Density (dBm/3kHz)	Maximum Limit (dBm/3kHz)	Result
2402	-12.39	8	PASS
2440	-12.48	8	PASS
2480	-12.31	8	PASS

**Note:*

1.cable loss as 0.96dB that offsets in the spectrum

PHY=8 mode

Frequency (MHz)	RF Power Density (dBm/3kHz)	Maximum Limit (dBm/3kHz)	Result
2402	0.07	8	PASS
2440	0.03	8	PASS
2480	0.13	8	PASS

**Note:*

1.cable loss as 0.96dB that offsets in the spectrum

PHY=2 mode

Frequency (MHz)	RF Power Density (dBm/3kHz)	Maximum Limit (dBm/3kHz)	Result
2402	-0.04	8	PASS
2440	0.19	8	PASS
2480	0.03	8	PASS

**Note:*

1.cable loss as 0.96dB that offsets in the spectrum

Unless otherwise stated the results shown in this test report refer only to the sample(s) tested and such sample(s) are retained for 90 days only.
 除非另有說明，此報告結果僅對測試之樣品負責，同時此樣品僅保留90天。本報告未經本公司書面許可，不可部份複製。

This document is issued by the Company subject to its General Conditions of Service printed overleaf, available on request or accessible at <http://www.sgs.com.tw/Terms-and-Conditions> and for electronic format documents, subject to Terms and Conditions for Electronic Documents at <http://www.sgs.com.tw/Terms-and-Conditions>. Attention is drawn to the limitation of liability, indemnification and jurisdiction issues defined therein. Any holder of this document is advised that information contained hereon reflects the Company's findings at the time of its intervention only and within the limits of Client's instructions, if any. The Company's sole responsibility is to its Client and this document does not exonerate parties to a transaction from exercising all their rights and obligations under the transaction documents. This document cannot be reproduced except in full, without prior written approval of the Company. Any unauthorized alteration, forgery or falsification of the content or appearance of this document is unlawful and offenders may be prosecuted to the fullest extent of the law.

Mode: ANT8
BLE 1M mode

Frequency (MHz)	RF Power Density (dBm/3kHz)	Maximum Limit (dBm/3kHz)	Result
2402	-8.64	8	PASS
2440	-8.69	8	PASS
2480	-8.44	8	PASS

***Note:**
1.cable loss as 0.96dB that offsets in the spectrum
BLE 2M mode

Frequency (MHz)	RF Power Density (dBm/3kHz)	Maximum Limit (dBm/3kHz)	Result
2402	-12.25	8	PASS
2440	-12.28	8	PASS
2480	-12.37	8	PASS

***Note:**
1.cable loss as 0.96dB that offsets in the spectrum
PHY=8 mode:

Frequency (MHz)	RF Power Density (dBm/3kHz)	Maximum Limit (dBm/3kHz)	Result
2402	0.51	8	PASS
2440	0.22	8	PASS
2480	0.71	8	PASS

***Note:**
1.cable loss as 0.96dB that offsets in the spectrum

Unless otherwise stated the results shown in this test report refer only to the sample(s) tested and such sample(s) are retained for 90 days only.

除非另有說明，此報告結果僅對測試之樣品負責，同時此樣品僅保留90天。本報告未經本公司書面許可，不可部份複製。

This document is issued by the Company subject to its General Conditions of Service printed overleaf, available on request or accessible at <http://www.sgs.com.tw/Terms-and-Conditions> and for electronic format documents, subject to Terms and Conditions for Electronic Documents at <http://www.sgs.com.tw/Terms-and-Conditions>. Attention is drawn to the limitation of liability, indemnification and jurisdiction issues defined therein. Any holder of this document is advised that information contained hereon reflects the Company's findings at the time of its intervention only and within the limits of Client's instructions, if any. The Company's sole responsibility is to its Client and this document does not exonerate parties to a transaction from exercising all their rights and obligations under the transaction documents. This document cannot be reproduced except in full, without prior written approval of the Company. Any unauthorized alteration, forgery or falsification of the content or appearance of this document is unlawful and offenders may be prosecuted to the fullest extent of the law.

PHY=2 mode

Frequency (MHz)	RF Power Density (dBm/3kHz)	Maximum Limit (dBm/3kHz)	Result
2402	0.38	8	PASS
2440	0.10	8	PASS
2480	0.31	8	PASS

**Note:*

1.cable loss as 0.96dB that offsets in the spectrum

Unless otherwise stated the results shown in this test report refer only to the sample(s) tested and such sample(s) are retained for 90 days only.
 除非另有說明，此報告結果僅對測試之樣品負責，同時此樣品僅保留90天。本報告未經本公司書面許可，不可部份複製。

This document is issued by the Company subject to its General Conditions of Service printed overleaf, available on request or accessible at <http://www.sgs.com.tw/Terms-and-Conditions> and for electronic format documents, subject to Terms and Conditions for Electronic Documents at <http://www.sgs.com.tw/Terms-and-Conditions>. Attention is drawn to the limitation of liability, indemnification and jurisdiction issues defined therein. Any holder of this document is advised that information contained hereon reflects the Company's findings at the time of its intervention only and within the limits of Client's instructions, if any. The Company's sole responsibility is to its Client and this document does not exonerate parties to a transaction from exercising all their rights and obligations under the transaction documents. This document cannot be reproduced except in full, without prior written approval of the Company. Any unauthorized alteration, forgery or falsification of the content or appearance of this document is unlawful and offenders may be prosecuted to the fullest extent of the law.

ANT4_PSD_BLE 1M_LowCH00-2402MHz

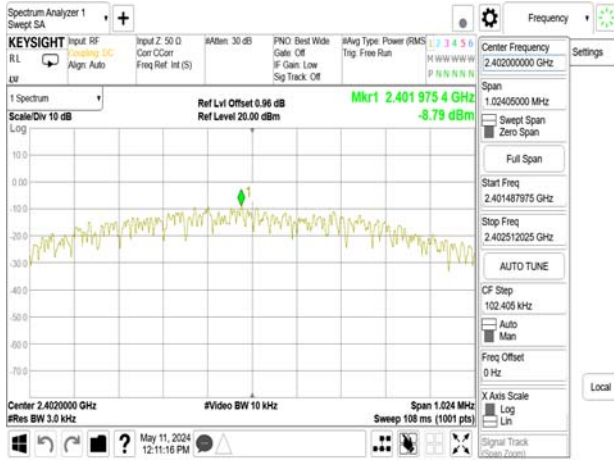

PSD_BLE 2M_LowCH00-2402MHz



PSD_BLE 1M_MidCH19-2440MHz

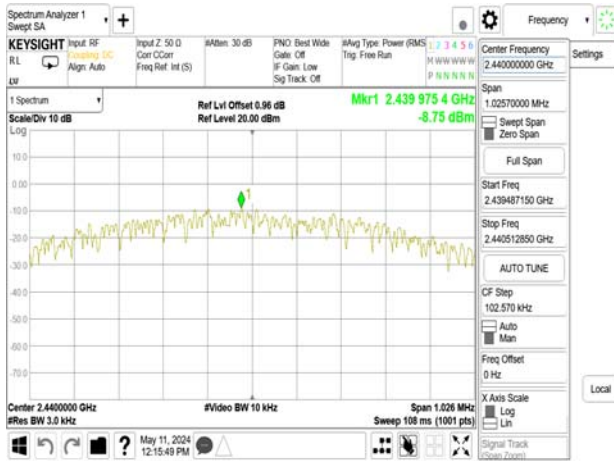

PSD_BLE 2M_MidCH19-2440MHz



PSD_BLE 1M_HighCH39-2480MHz

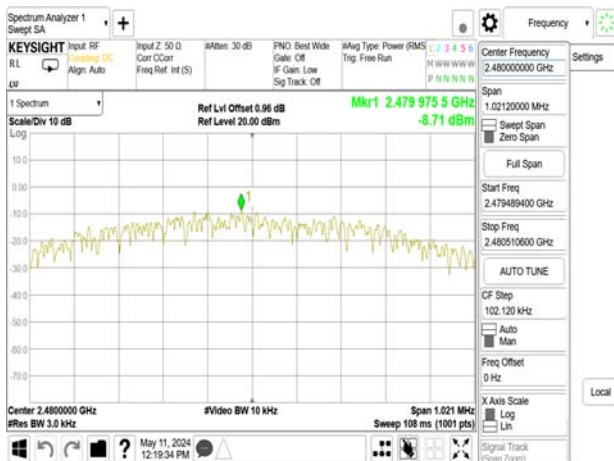

PSD_BLE 2M_HighCH39-2480MHz

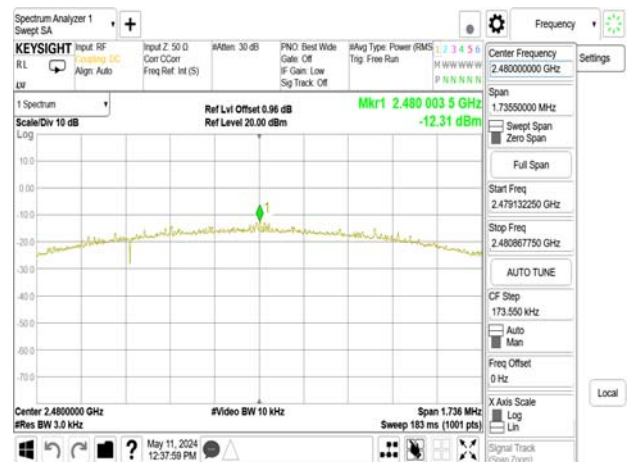

Unless otherwise stated the results shown in this test report refer only to the sample(s) tested and such sample(s) are retained for 90 days only.

除非另有說明，此報告結果僅對測試之樣品負責，同時此樣品僅保留90天。本報告未經本公司書面許可，不可部份複製。

This document is issued by the Company subject to its General Conditions of Service printed overleaf, available on request or accessible at <http://www.sgs.com.tw/Terms-and-Conditions> and for electronic format documents, subject to Terms and Conditions for Electronic Documents at <http://www.sgs.com.tw/Terms-and-Conditions>. Attention is drawn to the limitation of liability, indemnification and jurisdiction issues defined therein. Any holder of this document is advised that information contained hereon reflects the Company's findings at the time of its intervention only and within the limits of Client's instructions, if any. The Company's sole responsibility is to its Client and this document does not exonerate parties to a transaction from exercising all their rights and obligations under the transaction documents. This document cannot be reproduced except in full, without prior written approval of the Company. Any unauthorized alteration, forgery or falsification of the content or appearance of this document is unlawful and offenders may be prosecuted to the fullest extent of the law.

PSD_BLE 1M_LowCH00-2402MHz

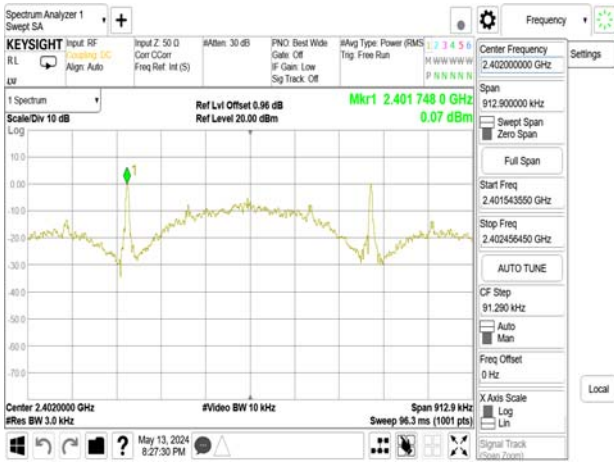

PSD_BLE 1M_LowCH00-2402MHz

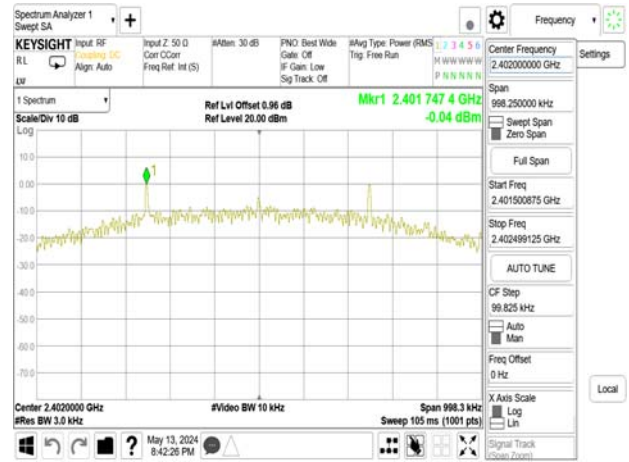

PSD_BLE 1M_MidCH19-2440MHz

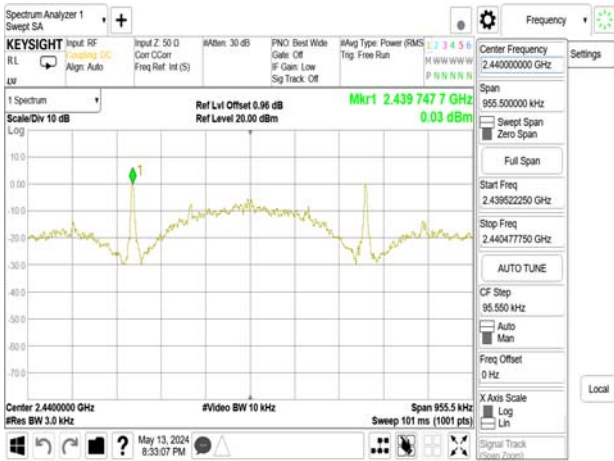

PSD_BLE 1M_MidCH19-2440MHz

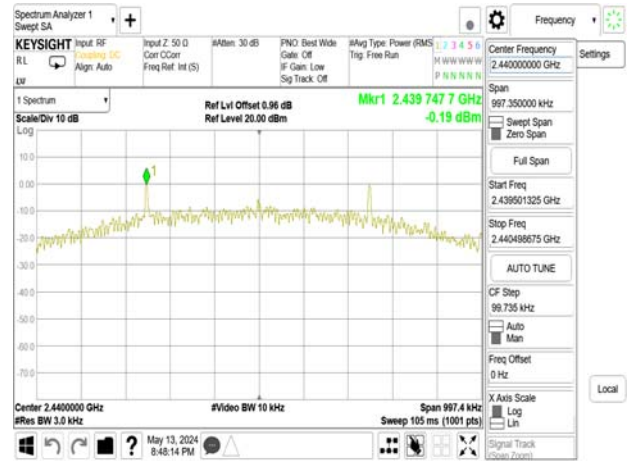

PSD_BLE 1M_HighCH39-2480MHz

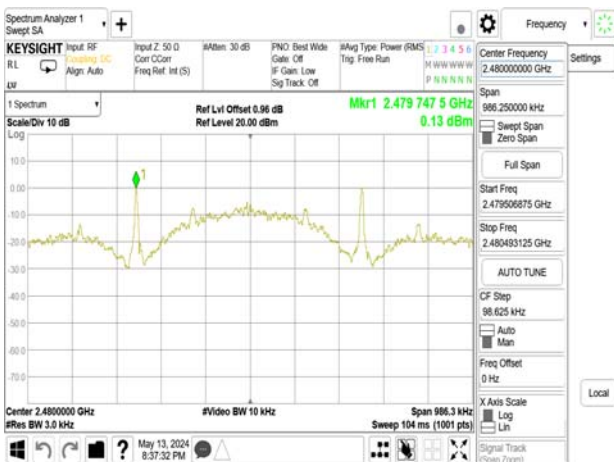

PSD_BLE 1M_HighCH39-2480MHz

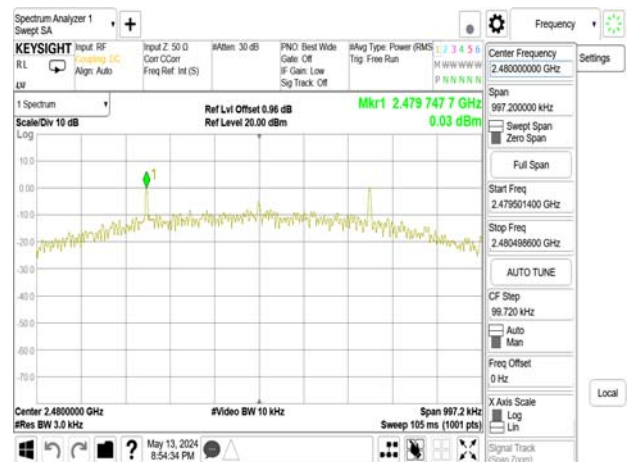

Unless otherwise stated the results shown in this test report refer only to the sample(s) tested and such sample(s) are retained for 90 days only.

除非另有說明，此報告結果僅對測試之樣品負責，同時此樣品僅保留90天。本報告未經本公司書面許可，不可部份複製。

This document is issued by the Company subject to its General Conditions of Service printed overleaf, available on request or accessible at <http://www.sgs.com.tw/Terms-and-Conditions> and for electronic format documents, subject to Terms and Conditions for Electronic Documents at <http://www.sgs.com.tw/Terms-and-Conditions>. Attention is drawn to the limitation of liability, indemnification and jurisdiction issues defined therein. Any holder of this document is advised that information contained hereon reflects the Company's findings at the time of its intervention only and within the limits of Client's instructions, if any. The Company's sole responsibility is to its Client and this document does not exonerate parties to a transaction from exercising all their rights and obligations under the transaction documents. This document cannot be reproduced except in full, without prior written approval of the Company. Any unauthorized alteration, forgery or falsification of the content or appearance of this document is unlawful and offenders may be prosecuted to the fullest extent of the law.

ANT8_PSD_BLE 1M_LowCH00-2402MHz

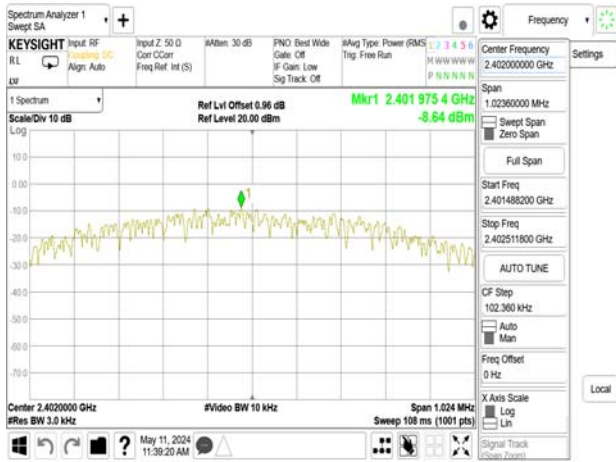

PSD_BLE 2M_LowCH00-2402MHz



PSD_BLE 1M_MidCH19-2440MHz

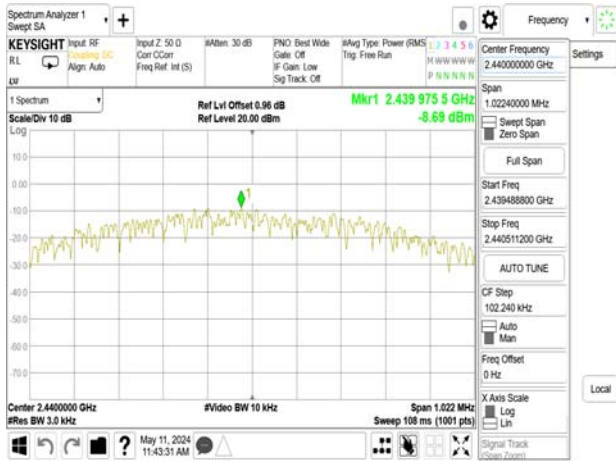

PSD_BLE 2M_MidCH19-2440MHz

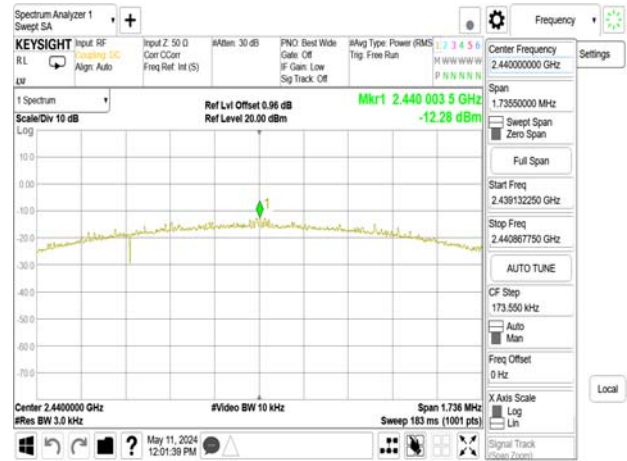

PSD_BLE 1M_HighCH39-2480MHz

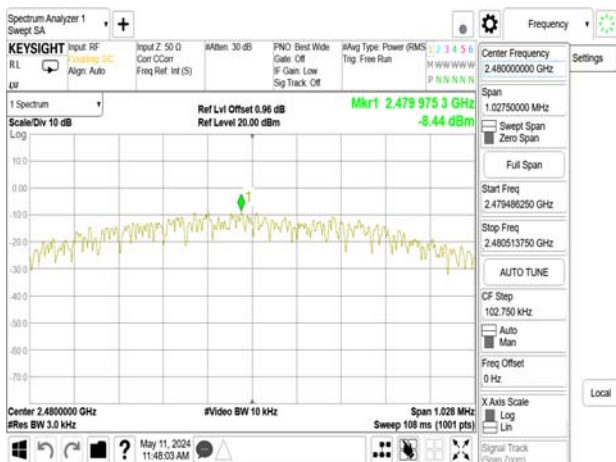

PSD_BLE 2M_HighCH39-2480MHz

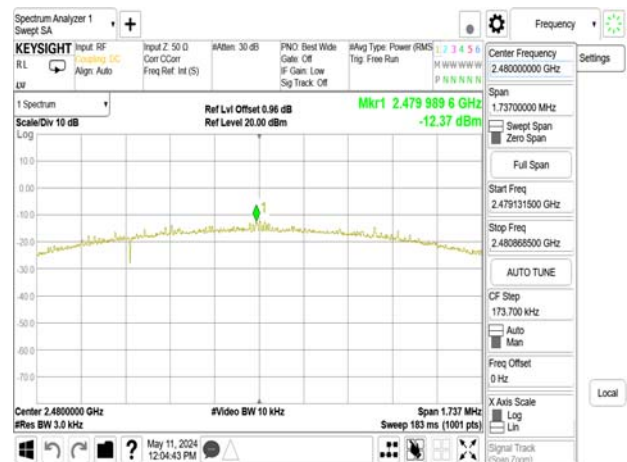

Unless otherwise stated the results shown in this test report refer only to the sample(s) tested and such sample(s) are retained for 90 days only.

除非另有說明，此報告結果僅對測試之樣品負責，同時此樣品僅保留90天。本報告未經本公司書面許可，不可部份複製。

This document is issued by the Company subject to its General Conditions of Service printed overleaf, available on request or accessible at <http://www.sgs.com.tw/Terms-and-Conditions> and for electronic format documents, subject to Terms and Conditions for Electronic Documents at <http://www.sgs.com.tw/Terms-and-Conditions>. Attention is drawn to the limitation of liability, indemnification and jurisdiction issues defined therein. Any holder of this document is advised that information contained hereon reflects the Company's findings at the time of its intervention only and within the limits of Client's instructions, if any. The Company's sole responsibility is to its Client and this document does not exonerate parties to a transaction from exercising all their rights and obligations under the transaction documents. This document cannot be reproduced except in full, without prior written approval of the Company. Any unauthorized alteration, forgery or falsification of the content or appearance of this document is unlawful and offenders may be prosecuted to the fullest extent of the law.

PSD_BLE 1M_LowCH00-2402MHz

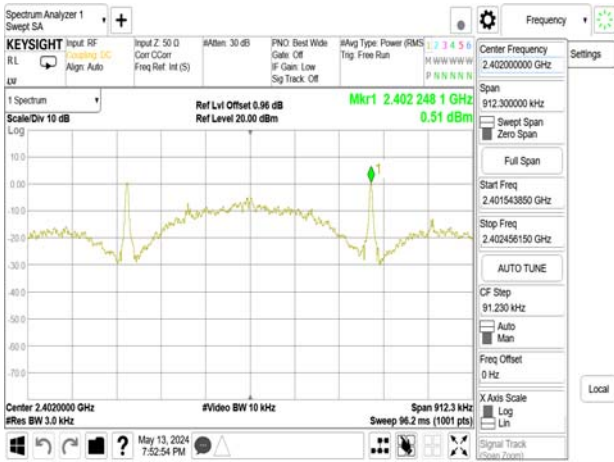

PSD_BLE 1M_LowCH00-2402MHz

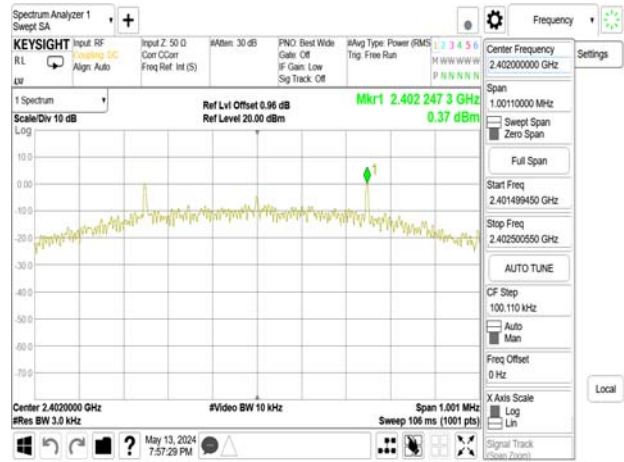

PSD_BLE 1M_MidCH19-2440MHz

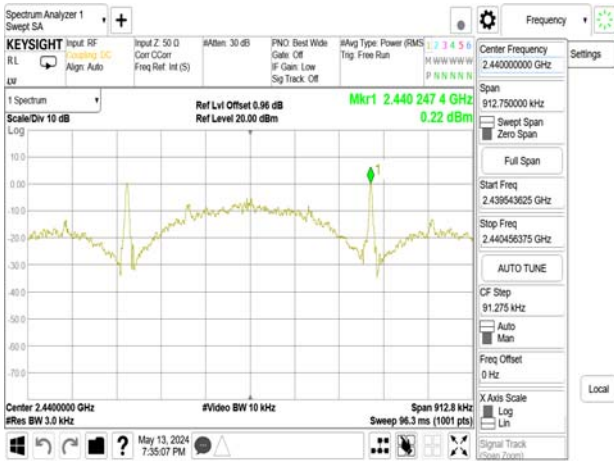

PSD_BLE 1M_MidCH19-2440MHz

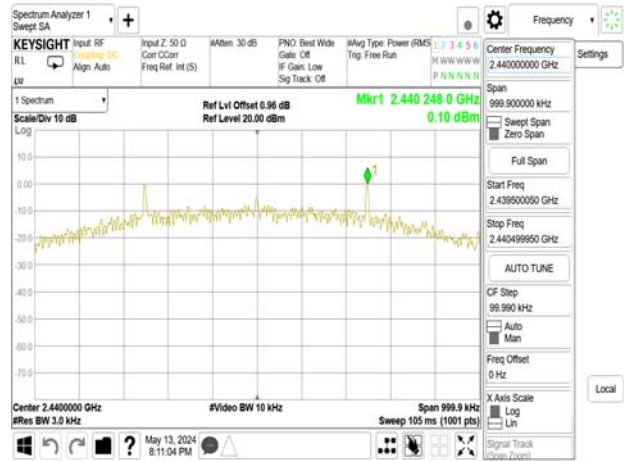

PSD_BLE 1M_HighCH39-2480MHz

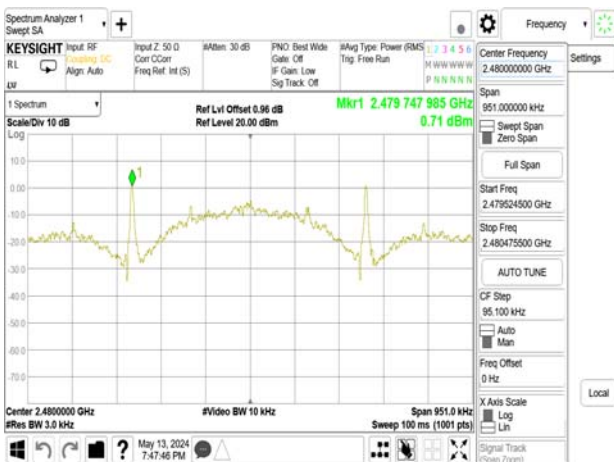

PSD_BLE 1M_HighCH39-2480MHz

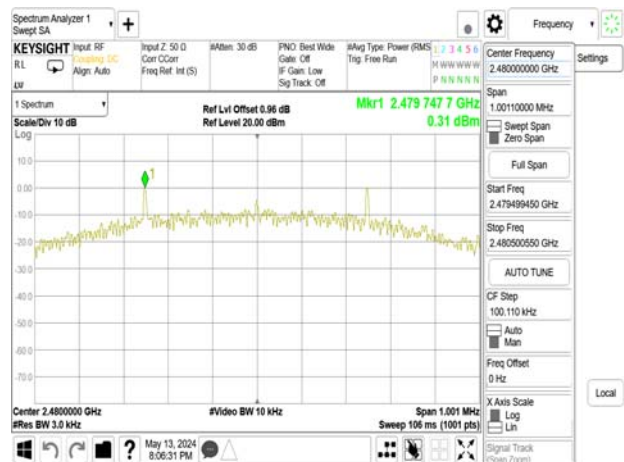

Unless otherwise stated the results shown in this test report refer only to the sample(s) tested and such sample(s) are retained for 90 days only.

除非另有說明，此報告結果僅對測試之樣品負責，同時此樣品僅保留90天。本報告未經本公司書面許可，不可部份複製。

This document is issued by the Company subject to its General Conditions of Service printed overleaf, available on request or accessible at <http://www.sgs.com.tw/Terms-and-Conditions> and for electronic format documents, subject to Terms and Conditions for Electronic Documents at <http://www.sgs.com.tw/Terms-and-Conditions>. Attention is drawn to the limitation of liability, indemnification and jurisdiction issues defined therein. Any holder of this document is advised that information contained hereon reflects the Company's findings at the time of its intervention only and within the limits of Client's instructions, if any. The Company's sole responsibility is to its Client and this document does not exonerate parties to a transaction from exercising all their rights and obligations under the transaction documents. This document cannot be reproduced except in full, without prior written approval of the Company. Any unauthorized alteration, forgery or falsification of the content or appearance of this document is unlawful and offenders may be prosecuted to the fullest extent of the law.

13 ANTENNA REQUIREMENT

13.1 Standard Applicable:

An intentional radiator shall be designed to ensure that no antenna other than that furnished by the responsible party shall be used with the device. The use of a permanently attached antenna or of an antenna that uses a unique coupling to the intentional radiator shall be considered sufficient to comply with the provisions of this section. The manufacturer may design the unit so that a broken antenna can be replaced by the user, but the use of a standard antenna jack or electrical connector is prohibited. This requirement does not apply to carrier current devices or to devices operated under the provisions of §§ 15.211, 15.213, 15.217, 15.219, 15.221, or § 15.236. Further, this requirement does not apply to intentional radiators that must be professionally installed, such as perimeter protection systems and some field disturbance sensors, or to other intentional radiators which, in accordance with § 15.31(d), must be measured at the installation site. However, the installer shall be responsible for ensuring that the proper antenna is employed so that the limits in this part are not exceeded.

13.2 Antenna Connected Construction:

The antenna complies with this requirement and no consideration of replacement. Please see EUT photo for details.

~ End of Report ~

Unless otherwise stated the results shown in this test report refer only to the sample(s) tested and such sample(s) are retained for 90 days only.
除非另有說明，此報告結果僅對測試之樣品負責，同時此樣品僅保留90天。本報告未經本公司書面許可，不可部份複製。

This document is issued by the Company subject to its General Conditions of Service printed overleaf, available on request or accessible at <http://www.sgs.com.tw/Terms-and-Conditions> and for electronic format documents, subject to Terms and Conditions for Electronic Documents at <http://www.sgs.com.tw/Terms-and-Conditions>. Attention is drawn to the limitation of liability, indemnification and jurisdiction issues defined therein. Any holder of this document is advised that information contained hereon reflects the Company's findings at the time of its intervention only and within the limits of Client's instructions, if any. The Company's sole responsibility is to its Client and this document does not exonerate parties to a transaction from exercising all their rights and obligations under the transaction documents. This document cannot be reproduced except in full, without prior written approval of the Company. Any unauthorized alteration, forgery or falsification of the content or appearance of this document is unlawful and offenders may be prosecuted to the fullest extent of the law.