

TEST REPORT FOR PD TESTING

Report No.: SRTC2023-9004(F)-23042702(S)
Product Name: Smart Phone
Applicant: Sharp Corporation
FCC ID: APYHRO00326

Reference Specification
KDB 987594
Part 2.1093
IEC/IEEE 63170
IEC/IEEE 63195-1
IEC 62479
DASY6-mmWave SYSTEM HANDBOOK
DASY6 Application Note_ Interim Procedures for SAR & PD at 6 – 10 GHz

The State Radio_monitoring_center Testing Center (SRTC)

15th Building, No.30 Shixing Street, ShijingshanDistrict, Beijing,P.R.China

Tel: 86-10-57996183 Fax: 86-10-5799638

1 GENERAL INFORMATION.....	3
1.1 Notes of the test report.....	3
1.2 Information about the testing laboratory.....	3
1.3 Applicant’s details.....	3
1.4 Manufacturer’s details.....	3
2 DESCRIPTION OF THE EQUIPMENT UNDER TEST.....	4
2.1 DUT information.....	4
2.2 Exposure Conditions.....	4
2.3 Other information.....	4
3 SPECIFICATION.....	5
4 TEST CONDITIONS.....	6
4.1 Test signal, frequencies and output power.....	6
4.2 Measurement set-up.....	6
4.3 Phantoms.....	7
4.4 Device holder.....	7
4.5 Parameter.....	8
5 RESULT SUMMARY.....	9
6 POWER RESULTS.....	10
6.1 Scenario.....	10
6.2 Average output power with tune up tolerance.....	11
6.3 System check.....	21
6.4 PD simultaneous transmission analysis.....	25
7 MEASUREMENT UNCERTAINTY.....	26
8 TEST EQUIPMENTS.....	32

1 GENERAL INFORMATION

1.1 Notes of the test report

The test report may only be reproduced or published in full. Reproduction or publication of extracts from the report requires the prior written permission of The State Radio_monitoring_center Testing Center (SRTC). The certification and accreditation identifiers used in this report shall not be applicable to the tested or calibrated samples thereof. The manufacturer shall not mark the tested samples or items (or a separate part of the item) with the identifiers of certification and accreditation to mislead relevant parties about the tested samples or items.

1.2 Information about the testing laboratory

Company:	The State Radio_monitoring_center Testing Center (SRTC)
Designation number:	CN1267
Registration number:	239125
CAB identifier	CN0049
Test lab Number	7308A
Address:	15th Building, No.30 Shixing Street, Shijingshan District, Beijing P.R.China
Contacted person:	Liu Jia
Tel:	+86 10 57996183
Fax:	+86 10 57996388
Email:	liujiaf@srtc.org.cn

1.3 Applicant's details

Company:	Sharp Corporation
Address:	1 Takumi-cho, Sakai-ku, Sakai City, Osaka 590-8522, Japan

1.4 Manufacturer's details

Company:	Sharp Corporation
Address:	1 Takumi-cho, Sakai-ku, Sakai City, Osaka 590-8522, Japan

2 DESCRIPTION OF THE EQUIPMENT UNDER TEST

2.1 DUT information

Network	Band Information
Unlicensed	WLAN6GHz UNII-5

Mode supported	Note
802.11a(6GHz)	NA
802.11ax HE20(6GHz)	NA
802.11ax HE40(6GHz)	NA
802.11ax HE80(6GHz)	NA
802.11ax HE160(6GHz)	NA

2.2 Exposure Conditions

General information

Free space: PD testing is over the air. Peak Spatially Averaged Power Density was evaluated over a area of 4cm², the limit is 10W/m² (1mW/cm²).

DUT Exposure Condition	Distance(mm)
Free space	2mm($\lambda/5$ just for verification below 10GHz)

2.3 Other information

Testing Start Date:	2023/04/28
Testing End Date:	2023/05/31
DUT IMEI:	004401231466729
DUT H/W Version:	DVT
DUT S/W Version:	A404G
Ambient Temperature:	22°C
Humidity:	35%
Note	#

Max Ambient noise and Reflections (with absorber):	$0.058\text{w/m}^2 < 0.1\text{ w/m}^2 = 0.01 * 10\text{w/m}^2$
Note:	According to IEC/IEEE63195-1 The ambient noise for any measurement shall correspond to less than -20 dB (1 %) of power density limit, The influence of reflections from objects in the laboratory shall be less than -17 dB (2 %) of the applicable power density limit.

3 SPECIFICATION

Name	Version	Title
KDB 987594	2022	UN6GHz pre-approval guidance checklist
Part 2.1093	Latest	Radio frequency radiation exposure evaluation: portable devices.
IEC/IEEE 63170	2018	Measurement procedure for the evaluation of power density related to human exposure to radio frequency fields from wireless communication devices operating between 6 GHz and 100 GHz
IEC/IEEE 63195-1	2022	Assessment of power density of human exposure to radio frequency fields from wireless devices in close proximity to the head and body (frequency range of 6 GHz to 300 GHz) – Part 1: Measurement procedure
IEC 62479	2010	Assessment of the compliance of low power electronic and electrical equipment with the basic restrictions related to human exposure to electromagnetic fields (10 MHz to 300 GHz)
DASY6-mmWave SYSTEM HANDBOOK	February 24, 2022	DASY6 MODULE mmWave SYSTEM HANDBOOK incl. SW Module mmWave 3.0(Schmid & Partner Engineering AG)
DASY6 Application Note_Interim Procedures for SAR & PD at 6 – 10 GHz	2020.10	Compliance Testing of Devices Operating between 6 – 10 GHz: Interim Procedures(Schmid & Partner Engineering AG)

4 TEST CONDITIONS

4.1 Test signal, frequencies and output power

The device was put into operation by using a call tester. Communication between the device and the call tester was established by air link. Non-signaling mode also applied. The device output power was set to maximum power level for all tests; a fully charged battery was used for every test sequence. For each wireless technology and frequency band used by the DUT, tests should be performed at the channel closest to the centre of each transmit frequency band. If the width of the transmit frequency band ($\Delta f = f_{\text{high}} - f_{\text{low}}$) exceeds 1 % of its centre frequency f_c , then the channels at the lowest and highest frequencies of the transmit band are also tested. Furthermore, if the width of the transmit band exceeds 10 % of its centre frequency, the following formula is used to determine the number of channels, N_c , to be tested (**WIFI6E PD test frequency is only for the worst case from SAR report, if WIFI6E support full band across 5925-7125MHz, at least 5 channels shall be evaluated.**)

$$N_c = \min(2 \times \text{roundup} [10 \times (f_{\text{high}} - f_{\text{low}}) / f_c] + 1, N)$$

where

- f_c is the centre frequency channel of the transmission band in Hz;
- f_{high} is the highest frequency channel of the transmission band in Hz;
- f_{low} is the lowest frequency channel of the transmission band in Hz;
- N_c is the number of channels to be tested;
- N is the total number of channels.

4.2 Measurement set-up

The system is based on a high precision robot (working range greater than 0.9m), which positions the probes with a positional repeatability of better than $\pm 0.02\text{mm}$. probe sensors are directly to the data acquisition unit. A cell controller system contains the power supply, robot controller, teaches pendant (Joystick), and remote control, is used to drive the robot motors. The PC consists of the Micron Pentium IV computer with Windows system and Measurement Software DASY, A/D interface card, monitor, mouse, and keyboard. The Stäubli Robot is connected to the cell controller to allow software manipulation of the robot. A data acquisition electronic (DAE) circuit performs the signal amplification, signal multiplexing, AD-conversion, offset measurements, mechanical surface detection, collision detection, etc. is connected to the Electro-optical coupler (EOC). The EOC performs the conversion from the optical into digital electric signal of the DAE and transfers data to the PC plug-in card. The DAE consists of a highly sensitive electrometer-grade preamplifier with auto-zeroing, a channel and gain-switching multiplexer, a fast 16 bit AD-converter and a command decoder and control logic unit. Transmission to the PC-card is accomplished through an optical Downlink for data and status information and an optical uplink for commands and clock lines. The mechanical probe mounting device includes two different sensor systems for frontal and sidewise probe contacts. They are also used for mechanical surface detection and probe collision detection. The robot uses its own controller with a built in VME-bus computer.

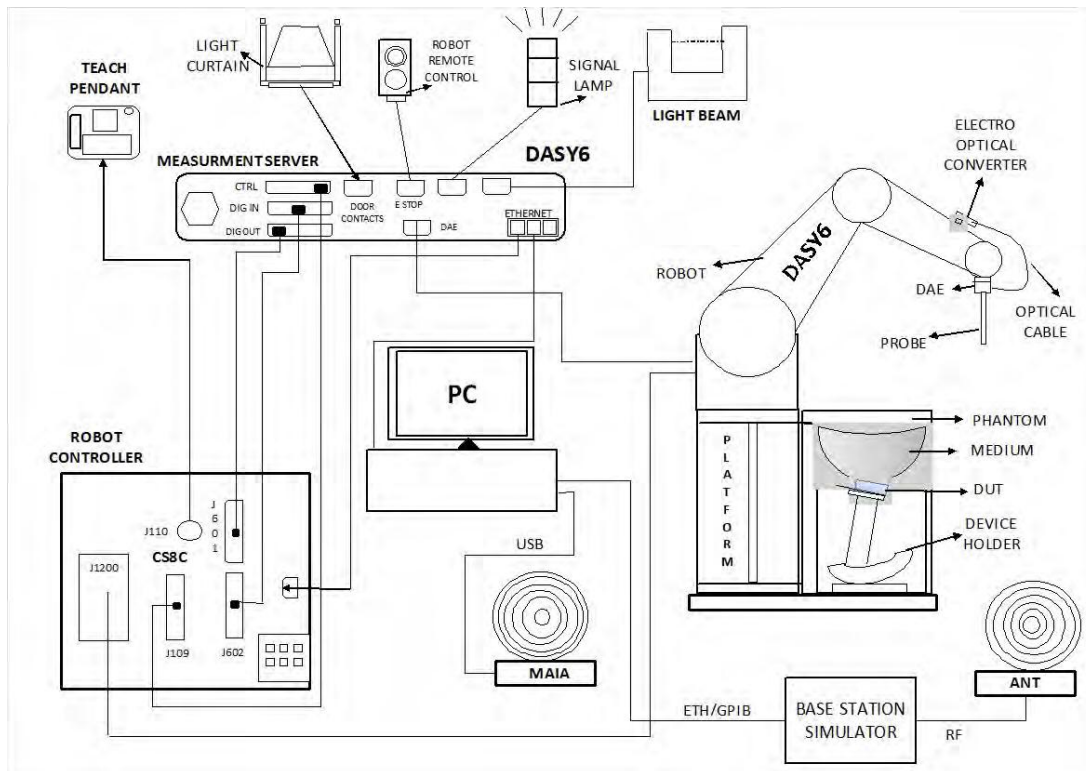

4.3 Phantoms

The mmWave Phantom approximates free-space conditions, It consists of a 40mm thick Rohacell plate used as a test bed, which has a loss tangent ($\tan\delta$) ≤ 0.05 and a relative permittivity (ϵ_r) ≤ 1.2 . High-performance RF absorbers are placed below the foam.

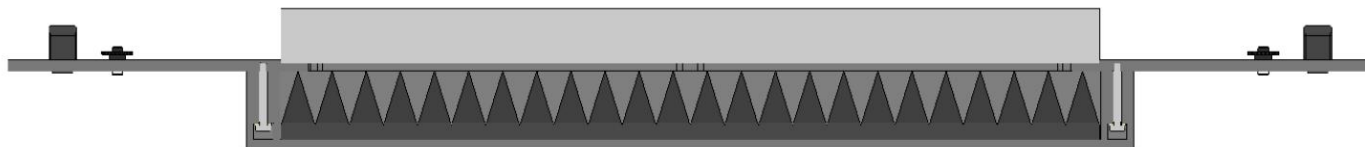

4.4 Device holder

The device was placed in the device holder (illustrated below) that is supplied by SPEAG as an integral part of the Dasy system.



4.5 Parameter

The measurement procedure consists of measuring the PD_{inc} at two different distances: $d=2mm$ (compliance distance) and $d=\lambda/5$. The grid extents should be large enough to fully capture the transmitted energy. The grid step should be fine enough to demonstrate that the integrated Power Density iPD_n varies by less than 1 dB between the $d=2mm$ and $d=\lambda/5$ measurements.

$$\text{Ratio} = iPD_n(2mm)/iPD_n(\lambda/5)$$

$$|10 \cdot \log(\text{Ratio})| < 1 \text{ dB}$$

$$l_{grid} = \begin{cases} 1.25d & \text{for } d < \lambda/10 \\ \lambda/8 & \text{for } d \geq \lambda/10 \end{cases}$$

$$\nu_{grid} \geq 2\lambda$$

Refer to manufacture analysis, system check use 10GHz source with 0.25λ grid step at 10mm distance is enough.

DUT	l_{grid}	$iPD_n/iPD_{n,\lambda}$ (dB) at evaluation distance z					
		1 mm	2 mm	5 mm	10 mm	20 mm	$\lambda/2$
SH-10G	$\lambda/4$	1.78	0.88	0.55	0.23	0.0	0.17
	$\lambda/8$	0.51	0.31	0.42	0.26	0.13	0.16
	$\lambda/16$	0.05	0.4	0.42	0.26	0.04	0.16

In order to improve the accuracy of result in Reactive Near-Field for frequency band around 6.5GHz (WIFI 6E), SRTC use the most conservative grid step $\lambda/16=0.0625\lambda$ at 2mm distance, grid step $\lambda/8=0.125\lambda$ at $\lambda/5mm$ distance.



For mmWave with higher frequency, 0.25λ grid step applied.

Frequency [GHz]	Grid step	Grid extent X/Y [mm]	Measurement points
30	$0.25 \left(\frac{\lambda}{4}\right)$	60/60	26×26
45	$0.25 \left(\frac{\lambda}{4}\right)$	42/42	28×28
60	$0.25 \left(\frac{\lambda}{4}\right)$	32.5/32.5	28×28
90	$0.25 \left(\frac{\lambda}{4}\right)$	30/30	38×38

5 RESULT SUMMARY

PD Summary

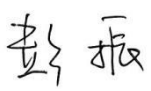
Exposure Position	Frequency Band	PD Result(W/m2)	Limit(W/m2)	Verdict
Free space (2m)	UNII-5	2.44	10	Pass

<p>This Test Report Is Approved by:</p> <p>Mr. Peng Zhen</p> 	<p>Review by:</p> <p>Mr. Li Bin</p> 
<p>Tested and issued by:</p> <p>Ms. Li Jin</p> 	<p>Approved date:</p> <p>20230606</p>

6 POWER RESULTS

6.1 Scenario

General description:

In common, there are several power change schemes based on technologies mentioned below, but different product use different method to change conducted power for relevant transmitters. These methods could be used together on both standalone and simultaneous transmission (Depends on specific scenario).

Receiver:	Triggered when receive ON/OFF
p-sensor:	Triggered when sensor ON/OFF
Hotspot:	Triggered when hotspot ON/OFF
Country code:	Triggered through MCC/A-GNSS
TA:	Time average PD based on Qualcomm

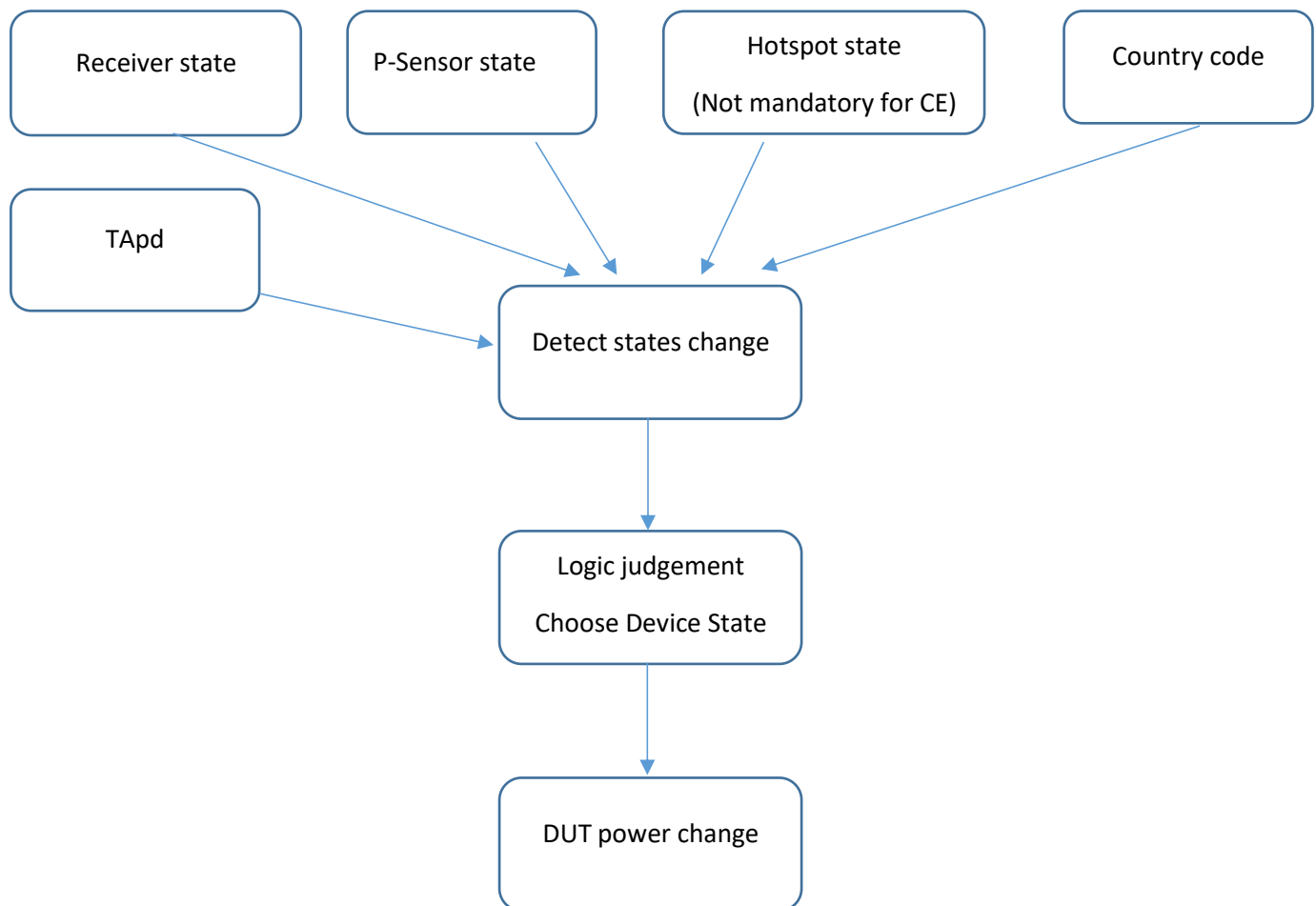

6.2 Average output power with tune up tolerance

6.2.1 WIFI6E

Unlicensed MIMO

Mode	Ant	Frequency(MHz)	Conducted power (dBm)	Tune up (dBm)
802.11a	Ant0	5955	10.10	11.0
		6175	10.08	11.0
		6415	10.89	11.0
	Ant1	5955	10.12	11.0
		6175	10.36	11.0
		6415	10.60	11.0
	MIMO	5955	13.12	14.0
		6175	13.23	14.0
		6415	13.76	14.0

Mode	Tone/Ru index	Ant	Frequency(MHz)	Conducted power (dBm)	Tune up (dBm)
802.11ax HE20	26T 0	Ant0	5955	7.13	8.0
			6175	7.53	8.0
			6415	7.56	8.0
		Ant1	5955	6.94	8.0
			6175	7.40	8.0
			6415	7.56	8.0
		MIMO	5955	10.05	11.0
			6175	10.48	11.0
			6415	10.57	11.0
	26T 4	Ant0	5955	6.87	8.0
			6175	6.86	8.0
			6415	7.02	8.0
		Ant1	5955	6.63	8.0
			6175	6.75	8.0
			6415	7.06	8.0
		MIMO	5955	9.76	11.0
			6175	9.82	11.0
			6415	10.05	11.0
	26T 8	Ant0	5955	6.84	8.0
			6175	7.26	8.0
			6415	7.50	8.0
		Ant1	5955	7.10	8.0
			6175	7.14	8.0
			6415	7.58	8.0
		MIMO	5955	9.98	11.0
			6175	10.21	11.0
			6415	10.55	11.0
	52T 37	Ant0	5955	7.10	8.0
			6175	7.17	8.0

		Ant1	6415	7.42	8.0
			5955	6.80	8.0
			6175	7.33	8.0
		MIMO	6415	7.13	8.0
			5955	9.96	11.0
			6175	10.26	11.0
	52T 39	Ant0	6415	10.29	11.0
			5955	6.81	8.0
			6175	7.21	8.0
		Ant1	6415	7.29	8.0
			5955	6.66	8.0
			6175	6.91	8.0
		MIMO	6415	7.04	8.0
			5955	9.75	11.0
			6175	10.07	11.0
52T 40	Ant0	6415	10.18	11.0	
		5955	7.03	8.0	
		6175	7.13	8.0	
	Ant1	6415	7.29	8.0	
		5955	6.90	8.0	
		6175	7.25	8.0	
	MIMO	6415	7.36	8.0	
		5955	9.98	11.0	
		6175	10.20	11.0	
106T 53	Ant0	6415	10.34	11.0	
		5955	6.98	8.0	
		6175	7.25	8.0	
	Ant1	6415	7.18	8.0	
		5955	6.93	8.0	
		6175	6.95	8.0	
	MIMO	6415	7.26	8.0	
		5955	9.97	11.0	
		6175	10.11	11.0	
106T 54	Ant0	6415	10.23	11.0	
		5955	7.02	8.0	
		6175	7.01	8.0	
	Ant1	6415	7.12	8.0	
		5955	6.77	8.0	
		6175	7.35	8.0	
	MIMO	6415	7.33	8.0	
		5955	9.91	11.0	
		6175	10.19	11.0	
242T 61	Ant0	6415	10.24	11.0	
		5955	9.81	11.0	
		6175	10.01	11.0	
	Ant1	6415	10.22	11.0	
		5955	9.77	11.0	
		6175	9.99	11.0	
			6415	10.91	11.0

		MIMO	5955	12.80	14.0
			6175	13.01	14.0
			6415	13.59	14.0

Mode	Tone/Ru index	Ant	Frequency(MHz)	Conducted power (dBm)	Tune up (dBm)
802.11ax HE40	26T 0	Ant0	5965	6.92	8.0
			6165	7.35	8.0
			6405	7.56	8.0
		Ant1	5965	7.08	8.0
			6165	7.49	8.0
			6405	7.68	8.0
		MIMO	5965	10.01	11.0
			6165	10.43	11.0
			6405	10.63	11.0
	26T 10	Ant0	5965	6.67	8.0
			6165	7.00	8.0
			6405	7.45	8.0
		Ant1	5965	6.86	8.0
			6165	6.99	8.0
			6405	7.41	8.0
		MIMO	5965	9.78	11.0
			6165	10.01	11.0
			6405	10.44	11.0
	26T 17	Ant0	5965	6.91	8.0
			6165	7.21	8.0
			6405	7.48	8.0
		Ant1	5965	7.02	8.0
			6165	7.55	8.0
			6405	7.32	8.0
		MIMO	5965	9.98	11.0
			6165	10.39	11.0
			6405	10.41	11.0
	52T 37	Ant0	5965	7.20	8.0
			6165	7.33	8.0
			6405	7.53	8.0
		Ant1	5965	7.07	8.0
			6165	7.18	8.0
			6405	7.47	8.0
		MIMO	5965	10.15	11.0
			6165	10.27	11.0
			6405	10.51	11.0
	52T 41	Ant0	5965	6.76	8.0
			6165	6.89	8.0
			6405	7.20	8.0
		Ant1	5965	6.89	8.0
			6165	6.91	8.0
			6405	7.33	8.0

		MIMO	5965	9.84	11.0	
			6165	9.91	11.0	
			6405	10.28	11.0	
	52T 44	Ant0		5965	6.82	8.0
				6165	7.40	8.0
				6405	7.35	8.0
		Ant1		5965	7.12	8.0
				6165	7.30	8.0
				6405	7.24	8.0
		MIMO		5965	9.98	11.0
				6165	10.36	11.0
				6405	10.31	11.0
	106T 53	Ant0		5965	6.79	8.0
				6165	7.53	8.0
				6405	7.72	8.0
		Ant1		5965	6.49	8.0
				6165	7.46	8.0
				6405	7.75	8.0
		MIMO		5965	9.65	11.0
				6165	10.51	11.0
				6405	10.75	11.0
	106T 55	Ant0		5965	6.86	8.0
				6165	7.17	8.0
				6405	7.43	8.0
		Ant1		5965	6.80	8.0
				6165	7.07	8.0
				6405	7.52	8.0
		MIMO		5965	9.84	11.0
				6165	10.13	11.0
				6405	10.49	11.0
106T 56	Ant0		5965	7.07	8.0	
			6165	7.34	8.0	
			6405	7.50	8.0	
	Ant1		5965	7.23	8.0	
			6165	7.11	8.0	
			6405	7.49	8.0	
	MIMO		5965	10.16	11.0	
			6165	10.24	11.0	
			6405	10.51	11.0	
242T 61	Ant0		5965	6.97	8.0	
			6165	7.27	8.0	
			6405	7.30	8.0	
	Ant1		5965	6.86	8.0	
			6165	7.32	8.0	
			6405	7.40	8.0	
	MIMO		5965	9.93	11.0	
			6165	10.31	11.0	
			6405	10.36	11.0	

	242T 62	Ant0	5965	6.50	8.0
			6165	7.14	8.0
			6405	7.19	8.0
		Ant1	5965	6.53	8.0
			6165	6.93	8.0
			6405	7.11	8.0
		MIMO	5965	9.53	11.0
			6165	10.05	11.0
			6405	10.16	11.0
	484T 65	Ant0	5965	10.76	11.0
			6165	10.29	11.0
			6405	10.21	11.0
		Ant1	5965	10.65	11.0
			6165	10.27	11.0
			6405	9.91	11.0
MIMO		5965	13.72	14.0	
		6165	13.29	14.0	
		6405	13.07	14.0	

Mode	Tone/Ru index	Ant	Frequency(MHz)	Conducted power (dBm)	Tune up (dBm)
802.11ax HE80	26T 0	Ant0	5985	6.90	8.0
			6145	6.96	8.0
			6385	7.22	8.0
		Ant1	5985	6.82	8.0
			6145	7.21	8.0
			6385	7.37	8.0
		MIMO	5985	9.87	11.0
			6145	10.10	11.0
			6385	10.31	11.0
	26T 18	Ant0	5985	6.73	8.0
			6145	6.84	8.0
			6385	7.42	8.0
		Ant1	5985	6.63	8.0
			6145	7.13	8.0
			6385	7.39	8.0
		MIMO	5985	9.69	11.0
			6145	10.00	11.0
			6385	10.42	11.0
	26T 36	Ant0	5985	6.66	8.0
			6145	6.82	8.0
			6385	7.19	8.0
		Ant1	5985	6.37	8.0
			6145	7.08	8.0
			6385	7.04	8.0
		MIMO	5985	9.53	11.0
			6145	9.96	11.0
			6385	10.13	11.0

	52T 37	Ant0	5985	6.93	8.0
			6145	7.09	8.0
			6385	7.70	8.0
		Ant1	5985	6.88	8.0
			6145	7.08	8.0
			6385	7.60	8.0
		MIMO	5985	9.92	11.0
			6145	10.10	11.0
			6385	10.66	11.0
	52T 45	Ant0	5985	6.85	8.0
			6145	6.91	8.0
			6385	7.44	8.0
		Ant1	5985	6.60	8.0
			6145	6.93	8.0
			6385	7.54	8.0
		MIMO	5985	9.74	11.0
			6145	9.93	11.0
			6385	10.50	11.0
	52T 52	Ant0	5985	6.48	8.0
			6145	7.20	8.0
			6385	7.19	8.0
		Ant1	5985	6.55	8.0
			6145	7.02	8.0
			6385	7.11	8.0
MIMO		5985	9.53	11.0	
		6145	10.12	11.0	
		6385	10.16	11.0	
106T 53	Ant0	5985	6.72	8.0	
		6145	7.28	8.0	
		6385	7.39	8.0	
	Ant1	5985	7.04	8.0	
		6145	7.29	8.0	
		6385	7.55	8.0	
	MIMO	5985	9.89	11.0	
		6145	10.30	11.0	
		6385	10.48	11.0	
106T 57	Ant0	5985	6.68	8.0	
		6145	7.00	8.0	
		6385	7.64	8.0	
	Ant1	5985	6.97	8.0	
		6145	6.81	8.0	
		6385	7.33	8.0	
	MIMO	5985	9.84	11.0	
		6145	9.92	11.0	
		6385	10.50	11.0	
106T 60	Ant0	5985	6.56	8.0	
		6145	7.00	8.0	
		6385	6.57	8.0	
	Ant1	5985	7.08	8.0	

		MIMO	6145	7.19	8.0	
			6385	6.63	8.0	
			5985	9.84	11.0	
			6145	10.11	11.0	
			6385	9.61	11.0	
			5985	7.16	8.0	
		Ant0		6145	7.71	8.0
				6385	6.30	8.0
				5985	6.90	8.0
		Ant1		6145	7.57	8.0
				6385	6.21	8.0
				5985	10.04	11.0
	MIMO		6145	10.65	11.0	
			6385	9.27	11.0	
			5985	6.95	8.0	
	242T 63	Ant0		6145	7.19	8.0
				6385	6.30	8.0
				5985	6.99	8.0
		Ant1		6145	7.07	8.0
				6385	6.63	8.0
				5985	9.98	11.0
		MIMO		6145	10.14	11.0
				6385	9.48	11.0
				5985	6.91	8.0
242T 64	Ant0		6145	6.74	8.0	
			6385	6.42	8.0	
			5985	6.85	8.0	
	Ant1		6145	6.96	8.0	
			6385	6.28	8.0	
			5985	9.89	11.0	
	MIMO		6145	9.86	11.0	
			6385	9.36	11.0	
			5985	7.13	8.0	
484T 65	Ant0		6145	7.41	8.0	
			6385	6.28	8.0	
			5985	7.04	8.0	
	Ant1		6145	7.57	8.0	
			6385	6.33	8.0	
			5985	10.10	11.0	
	MIMO		6145	10.50	11.0	
			6385	9.32	11.0	
			5985	6.81	8.0	
484T 66	Ant0		6145	6.86	8.0	
			6385	7.04	8.0	
			5985	6.96	8.0	
	Ant1		6145	7.02	8.0	
			6385	6.40	8.0	
			5985	9.90	11.0	
	MIMO		5985	9.90	11.0	

	996T 67	Ant0	6145	9.95	11.0	
			6385	9.74	11.0	
			5985	10.5	11.0	
		Ant1	6145	10.75	11.0	
			6385	10.71	11.0	
			5985	10.34	11.0	
	MIMO	6145	10.74	11.0		
		6385	10.83	11.0		
		5985	13.43	14.0		
				6145	13.76	14.0
				6385	13.78	14.0

Mode	Tone/Ru index	Ant	Frequency(MHz)	Conducted power (dBm)	Tune up (dBm)
802.11ax HE160	26T L	Ant0	6025	6.70	8.0
			6185	7.36	8.0
			6345	6.99	8.0
		Ant1	6025	6.51	8.0
			6185	7.19	8.0
			6345	7.22	8.0
		MIMO	6025	9.62	11.0
			6185	10.29	11.0
			6345	10.12	11.0
	26T H	Ant0	6025	7.05	8.0
			6185	7.53	8.0
			6345	7.84	8.0
		Ant1	6025	6.96	8.0
			6185	6.75	8.0
			6345	7.53	8.0
		MIMO	6025	10.02	11.0
			6185	10.17	11.0
			6345	10.70	11.0
	52T L	Ant0	6025	7.29	8.0
			6185	6.96	8.0
			6345	6.97	8.0
		Ant1	6025	7.45	8.0
			6185	6.85	8.0
			6345	6.92	8.0
		MIMO	6025	10.38	11.0
			6185	9.92	11.0
			6345	9.96	11.0
	52T H	Ant0	6025	7.02	8.0
			6185	6.82	8.0
			6345	7.17	8.0
		Ant1	6025	7.99	8.0
			6185	6.70	8.0
			6345	7.12	8.0
		MIMO	6025	10.54	11.0

	106T L	Ant0	6185	9.77	11.0
			6345	10.16	11.0
			6025	7.37	8.0
		Ant1	6185	7.22	8.0
			6345	7.32	8.0
			6025	7.69	8.0
			6185	7.16	8.0
			6345	7.54	8.0
			6025	10.54	11.0
	MIMO	6185	10.20	11.0	
		6345	10.44	11.0	
		6025	7.29	8.0	
	106T H	Ant0	6185	6.83	8.0
			6345	7.38	8.0
			6025	7.22	8.0
		Ant1	6185	6.88	8.0
			6345	7.27	8.0
			6025	10.27	11.0
		MIMO	6185	9.87	11.0
			6345	10.34	11.0
			6025	6.07	8.0
	242T L	Ant0	6185	7.12	8.0
			6345	7.03	8.0
			6025	6.17	8.0
		Ant1	6185	7.02	8.0
			6345	7.14	8.0
			6025	9.13	11.0
MIMO		6185	10.08	11.0	
		6345	10.10	11.0	
		6025	7.73	8.0	
242T H	Ant0	6185	6.84	8.0	
		6345	7.49	8.0	
		6025	7.76	8.0	
	Ant1	6185	6.43	8.0	
		6345	7.70	8.0	
		6025	10.76	11.0	
	MIMO	6185	9.65	11.0	
		6345	10.61	11.0	
		6025	7.40	8.0	
484T L	Ant0	6185	7.04	8.0	
		6345	7.11	8.0	
		6025	7.54	8.0	
	Ant1	6185	7.00	8.0	
		6345	7.22	8.0	
		6025	10.48	11.0	
	MIMO	6185	10.03	11.0	
		6345	10.18	11.0	
		6025	7.33	8.0	
484T H	Ant0	6185	6.69	8.0	
		6345	7.15	8.0	
		6025	7.33	8.0	

		Ant1	6025	7.55	8.0	
			6185	6.71	8.0	
			6345	7.31	8.0	
		MIMO	6025	10.45	11.0	
			6185	9.71	11.0	
			6345	10.24	11.0	
		996T L	Ant0	6025	7.24	8.0
				6185	7.39	8.0
				6345	6.41	8.0
	Ant1		6025	7.95	8.0	
			6185	7.31	8.0	
			6345	6.39	8.0	
	MIMO		6025	10.62	11.0	
			6185	10.36	11.0	
			6345	9.41	11.0	
	996T H	Ant0	6025	7.77	8.0	
			6185	6.96	8.0	
			6345	7.79	8.0	
		Ant1	6025	7.71	8.0	
			6185	7.29	8.0	
			6345	7.54	8.0	
		MIMO	6025	10.75	11.0	
			6185	10.14	11.0	
			6345	10.68	11.0	
	1992T	Ant0	6025	10.52	11.0	
			6185	10.24	11.0	
			6345	9.91	11.0	
Ant1		6025	10.7	11.0		
		6185	10.19	11.0		
		6345	10.04	11.0		
MIMO		6025	13.62	14.0		
		6185	13.23	14.0		
		6345	12.99	14.0		

6.3 System check

1)As system check requires an accurate and stable power to the source, it is recommended to power on and let the source warm up for approximately 30 min.

2)DUT Teaching: move the probe to a corner of the housing as close as possible to the surface. Record the z-coordinates in the “Teach DUT” pop-up window. Move the probe to the center of the source in the XY plane. Then slowly move the probe down to the previously recorded z-coordinate and click on “Confirm” to validate the position.

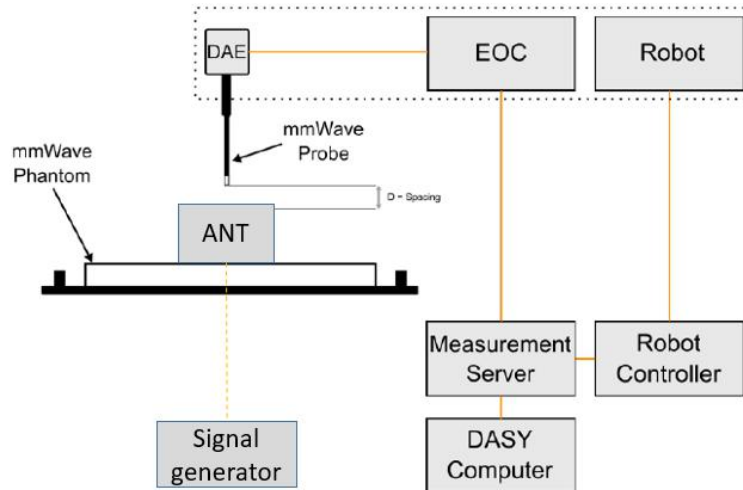

Note: Measurement accuracy can be reduced if connected to a ground pin at the backside of the robot arm, Create a measurement file with a test distance of 10mm for 10 GHz and 5.55mm (Horn build inside and 4.45mm to the outer surface) for 30 GHz and above. The sources at 30 GHz and above comprise horn antennas and very stable signal generators. The 10 GHz horn antenna has a SMA connector and can be connected to any signal generator.

Limit: The measured $psPD_{tot+}$ values is compared to the calibrated value and expected to be below 0.66 dB is 16.4%. ($psPD_{n+}$ is AvgPowerDensityIncident, $psPD_{mod+}$ is AvgPowerDensityMod)

Freq.(MHz)	Date	Measured PD (w/cm2)		Target (w/cm2)	Delta(%)	Tolerance(%)	Verdict
10000	2023/05/30	Circular 4cm2	158	151	4.64%	±16.4	Pass

Test data

The measurement procedure is summarized below:

Fast Area Scan: A measurement scan where sensor voltages are sampled continuously while the robot is moving is used to determine the radiation pattern and the E-field maximum location.

5G Scan : a fine resolution scan performed on two different planes is used to reconstruct the E and H-fields as well as the PD on the measurement plane; the average PD is derived from this measurement.

Note: The incident power density for WIFI6E must be measured for the test configuration producing the highest SAR value, and there is no need to evaluate other configuration.

Test and antenna position describe as follow:

Note: SRTC defined these positions (Back, Front, left, right, Top, Bottom) when facing the DUT screen.

The measured and reported PD values are tabulated below:

There is no additional correction factor apply to the measured value because of advanced method and uncertainty budget meet the requirement, more details please refer to uncertainty part in another file.

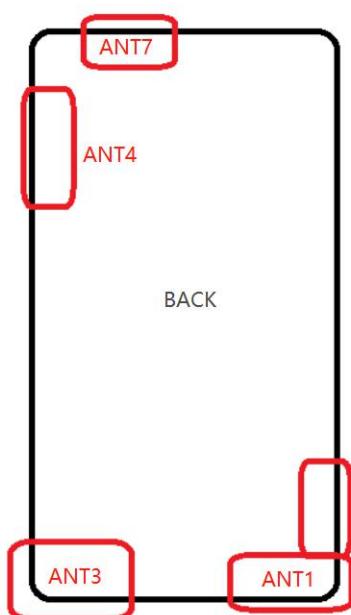

Unlicense MIMO	Position	Distances to edge (mm)	Test or not	Note
Ant4	Back	0.0	YES	BT/WIFI2.4GHz/WIFI5GHz/WIFI6GHz
	Front	8.0	YES	
	Top	9.0	YES	
	Bottom	124.0	NO	
	Left	65.0	NO	
	Right	0.0	YES	
Ant7	Back	0.0	YES	
	Front	8.0	YES	
	Top	0.0	YES	
	Bottom	151.0	NO	
	Left	43.0	NO	
	Right	6.0	YES	

The measured and reported PD values are tabulated below:

There is no additional correction factor apply to the measured value because of advanced method and uncertainty budget meet the requirement, more details please refer to uncertainty part in another file.

6.3.1 Unlicensed MIMO

Test case				Meas power (dBm)	Tune-up (dBm)	Scaling factor	Duty cycle	Duty factor	Meas PD(w/m ²)		Report PD(w/m ²)	
WLAN6GHz UNII-5	Exposure condition	Position	Frequency (MHz)						First	Second	First	Second
802.11ax HE80	2mm	Back	6175	13.76	14.00	1.06	100%	N/A	2.300	---	2.438	---
802.11ax HE80	$\lambda/5$	Back	6175	13.76	14.00	1.06	100%	N/A	1.980	---	2.099	---
802.11ax HE80	2mm	Front	6175	13.76	14.00	1.06	100%	N/A	1.230	---	1.304	---
802.11ax HE80	2mm	Right	6175	13.76	14.00	1.06	100%	N/A	0.789	---	0.836	---
802.11ax HE80	2mm	Top	6175	13.76	14.00	1.06	100%	N/A	1.160	---	1.230	---

Note1: Radio= $iPDn(2mm)/iPDn(\lambda/5) < 1$, So DASY is stable with advanced ESR method by using software version higher than 3.0.

Note2: This project actually only supports MIMO (WLAN 2.4GHz/5GHz/6GHz/Bluetooth), and users can only use MIMO. Therefore, SAR testing was only conducted on MIMO (WLAN 2.4GHz/5GHz/6GHz/Bluetooth).

6.4 PD simultaneous transmission analysis

Demonstrate applicable classification (portable/mobile/fixed) in reference to worst-case scenario use cases
Address $f > 6$ GHz RF exposure via most recent applicable KDB or TCB Workshop procedures
Address all applicable simultaneous transmission conditions using the compliance condition $TER \leq 1$, where TER (total exposure ratio) in this context is defined as:

$$TER = \sum_{k=1}^{N_s} \left(\frac{SAR_k}{SAR_{lim}} \right) + \sum_{k=1}^{N_f} \left(\frac{MPE_{field, k}}{MPE_{field, lim}} \right)^2 + \sum_{k=1}^{N_{PD}} \left(\frac{MPE_{PD, k}}{MPE_{PD, lim}} \right)$$

with N_s , N_f , and N_{PD} referring to sources requiring SAR, field-MPE, or PD-MPE, respectively, k referring to measured or estimated values for the source k , and “lim” to the corresponding applicable compliance limit

Exposure condition		Free space					
Position		Back	Front	Top	Bottom	Left	Right
WWAN_MAX Mode		DC_66A_n5A	DC_66A_n41A	---	DC_66A_n41A	LTE Band17	DC_66A_n41A
WWAN_MAX Value(W/kg)		0.823	0.559	---	1.139	0.179	0.273
BT (W/kg)		0.115	0.067	0.027	---	---	0.075
WLAN2.4GHz MIMO(W/kg)		0.098	0.049	0.082	---	---	0.108
PD(w/m2)		2.438	1.304	1.230	---	---	0.836
Reported SAR/1.6+PD/10 Summation	WWAN+PD	0.758	0.480	0.123	0.712	0.112	0.254
	WWAN+ WLAN2.4GHz MIMO+PD	0.820	0.511	0.174	0.712	0.112	0.322
	WWAN+ BT+PD	0.830	0.522	0.140	0.712	0.112	0.301

TER (MAX)= WWAN=0.830≤1

7 MEASUREMENT UNCERTAINTY

PD Absolute Uncertainty Budget for System Performance Check							
Error Description	Unc. Value (±dB)	Probab. Distri.	Div.	(c_i)	Std. Unc. (±dB)	(v_i)	v_{eff}
Uncertainty terms dependent on the measurement system							
CAL	Calibration Repeatability	0.21	N	1	1	0.21	∞
COR	Probe correction	0	R	$\sqrt{3}$	1	0	∞
FRS	Frequency response (BW ≤1 GHz)	0.20	R	$\sqrt{3}$	0	0	∞
SCC	Sensor crosscoupling	0	R	$\sqrt{3}$	1	0	∞
ISO	Isotropy	0.30	R	$\sqrt{3}$	1	0.17	∞
LIN	Linearity	0.20	R	$\sqrt{3}$	1	0.12	∞
PSC	Probe scattering	0	R	$\sqrt{3}$	1	0	∞
PPO	Probe positioning offset	0.11	R	$\sqrt{3}$	1	0.06	∞
PPR	Probe positioning repeatability	0.04	R	$\sqrt{3}$	1	0.02	∞
SMO	Sensor mechanical offset	0	R	$\sqrt{3}$	1	0	∞
PSR	Probe spatial resolution	0	R	$\sqrt{3}$	1	0	∞
FLD	Field impedance dependence	0	R	$\sqrt{3}$	1	0	∞
APD	Amplitude and phase drift	0	R	$\sqrt{3}$	1	0	∞
APN	Amplitude and phase noise	0.04	R	$\sqrt{3}$	0	0	∞
TR	Measurement area truncation	0	R	$\sqrt{3}$	1	0	∞
DAQ	Data acquisition	0.03	N	1	1	0.03	∞
SMP	Sampling	0	R	$\sqrt{3}$	1	0	∞
REC	Field reconstruction	0.60	R	$\sqrt{3}$	0.3	0.10	∞
TRA	Forward transformation	0	R	$\sqrt{3}$	1	0	∞
SCA	Power density scaling	–	R	$\sqrt{3}$	1	0	∞
SAV	Spatial averaging	0.10	R	$\sqrt{3}$	0	0	∞
SDL	System detection limit	0.04	R	$\sqrt{3}$	1	0.02	∞
Uncertainty terms dependent on the DUT and environmental factors							
PC	Probe coupling with DUT	0	R	$\sqrt{3}$	1	0	∞
MOD	Modulation response	0.40	R	$\sqrt{3}$	0	0	∞
IT	Integration time	0	R	$\sqrt{3}$	1	0	∞
RT	Response time	0	R	$\sqrt{3}$	1	0	∞
DH	Device holder influence	0.10	R	$\sqrt{3}$	0	0	∞
DA	DUT alignment	0	R	$\sqrt{3}$	1	0	∞
AC	RF ambient conditions	0.04	R	$\sqrt{3}$	1	0.02	∞
AR	Ambient Reflections	0.04	R	$\sqrt{3}$	1	0.02	∞
MSI	Immunity / secondary reception	0	R	$\sqrt{3}$	0	0	∞
DRI	Drift of the DUT	0.10	R	$\sqrt{3}$	1	0.06	∞
Combined Standard Uncertainty						0.33	∞
Expanded Standard Uncertainty (95%)						0.66	

PD Absolute Uncertainty Budget for DUT Evaluations							
Error Description		Unc. Value (±dB)	Probab. Distri.	Div.	(c_i)	Std. Unc. (±dB)	(ν_i) ν_{eff}
Uncertainty terms dependent on the measurement system							
CAL	Calibration	0.49	N	1	1	0.49	∞
COR	Probe correction	0	R	$\sqrt{3}$	1	0	∞
FRS	Frequency response (BW ≤ 1 GHz)	0.20	R	$\sqrt{3}$	1	0.12	∞
SCC	Sensor cross coupling	0	R	$\sqrt{3}$	1	0	∞
ISO	Isotropy	0.50	R	$\sqrt{3}$	1	0.29	∞
LIN	Linearity	0.20	R	$\sqrt{3}$	1	0.12	∞
PSC	Probe scattering	0	R	$\sqrt{3}$	1	0	∞
PPO	Probe positioning offset	0.30	R	$\sqrt{3}$	1	0.17	∞
PPR	Probe positioning repeatability	0.04	R	$\sqrt{3}$	1	0.02	∞
SMO	Sensor mechanical offset	0	R	$\sqrt{3}$	1	0	∞
PSR	Probe spatial resolution	0	R	$\sqrt{3}$	1	0	∞
FLD	Field impedance dependence	0	R	$\sqrt{3}$	1	0	∞
APD	Amplitude and phase drift	0	R	$\sqrt{3}$	1	0	∞
APN	Amplitude and phase noise	0.04	R	$\sqrt{3}$	1	0.02	∞
TR	Measurement area truncation	0	R	$\sqrt{3}$	1	0	∞
DAQ	Data acquisition	0.03	N	1	1	0.03	∞
SMP	Sampling	0	R	$\sqrt{3}$	1	0	∞
REC	Field reconstruction	0.60	R	$\sqrt{3}$	1	0.35	∞
TRA	FTE/MEO	0 (0.7)	R	$\sqrt{3}$	1	0(0.4)	∞
SCA	Power density scaling	–	R	$\sqrt{3}$	1	–	∞
SAV	Spatial averaging	0.10	R	$\sqrt{3}$	1	0.06	∞
SDL	System detection limit	0.04	R	$\sqrt{3}$	1	0.02	∞
Uncertainty terms dependent on the DUT and environmental factors							
PC	Probe coupling with DUT	0	R	$\sqrt{3}$	1	0	∞
MOD	Modulation response	0.40	R	$\sqrt{3}$	1	0.23	∞
IT	Integration time	0	R	$\sqrt{3}$	1	0	∞
RT	Response time	0	R	$\sqrt{3}$	1	0	∞
DH	Device holder influence	0.10	R	$\sqrt{3}$	1	0.06	∞
DA	DUT alignment	0	R	$\sqrt{3}$	1	0	∞
AC	RF ambient conditions	0.04	R	$\sqrt{3}$	1	0.02	∞
AR	Ambient reflections	0.04	R	$\sqrt{3}$	1	0.02	∞
MSI	Immunity / secondary reception	0	R	$\sqrt{3}$	1	0	∞
DRI	Drift of the DUT	–	R	$\sqrt{3}$	1	–	∞
Combined Std Uncertainty (w/ FTE/MEO)						0.75	∞
Expanded Std Uncertainty (w/ FTE/MEO)						1.50	

DASY6 Module mmWave V3.0 features the Equivalent Source Reconstruction (ESR) method to compute the incident PD values averaged over an area of 1 cm² and 4 cm². With this method, the reconstruction uncertainty (REC) is below 0.6 dB for $d > \lambda/25$, corresponding to a test distance of 2mm at 6 GHz. The above-mentioned REC value is valid if the following conditions on the grid resolution (ℓ_{grid}) and grid extent (ν_{grid}) are met:

$$\ell_{\text{grid}} = \begin{cases} 1.25d & \text{for } d < \lambda/10 \\ \lambda/8 & \text{for } d \geq \lambda/10 \end{cases}$$

$$\nu_{\text{grid}} \geq 2\lambda$$

SRTC use Dasy6 version3 and above conditions are met, the uncertainty budgets given above can be used without any further adjustments.

Note: if test with Evaluations with PTP-PR (Software version Earlier than V3.0), The REC UNCERTAINTY must be evaluated. It is strongly recommended to use Method of ESR based on DASY6 mmWave V3.0.

PD Relative Uncertainty Budget System Performance Check							
Error Description		Unc. Value (\pm dB)	Probab. Distri.	Div.	(c_i)	Std. Unc. (\pm dB)	(v_i) v_{eff}
Uncertainty terms dependent on the measurement system							
CAL	Calibration Repeatability	0.21	N	1	0	0	∞
COR	Probe correction	0	R	$\sqrt{3}$	1	0	∞
FRS	Frequency response (BW \leq 1 GHz)	0.20	R	$\sqrt{3}$	0	0	∞
SCC	Sensor crosscoupling	0	R	$\sqrt{3}$	1	0	∞
ISO	Isotropy	0.30	R	$\sqrt{3}$	1	0.17	∞
LIN	Linearity	0.20	R	$\sqrt{3}$	0	0	∞
PSC	Probe scattering	0	R	$\sqrt{3}$	1	0	∞
PPO	Probe positioning offset	0.11	R	$\sqrt{3}$	1	0.06	∞
PPR	Probe positioning repeatability	0.04	R	$\sqrt{3}$	1	0.02	∞
SMO	Sensor mechanical offset	0	R	$\sqrt{3}$	1	0	∞
PSR	Probe spatial resolution	0	R	$\sqrt{3}$	1	0	∞
FLD	Field impedance dependence	0	R	$\sqrt{3}$	1	0	∞
APD	Amplitude and phase drift	0	R	$\sqrt{3}$	1	0	∞
APN	Amplitude and phase noise	0.04	R	$\sqrt{3}$	0	0	∞
TR	Measurement area truncation	0	R	$\sqrt{3}$	1	0	∞
DAQ	Data acquisition	0.03	N	1	1	0.03	∞
SMP	Sampling	0	R	$\sqrt{3}$	1	0	∞
REC	Field reconstruction	0.60	R	$\sqrt{3}$	0.15	0.05	∞
TRA	Forward transformation	0	R	$\sqrt{3}$	1	0	∞
SCA	Power density scaling	–	R	$\sqrt{3}$	1	0	∞
SAV	Spatial averaging	0.10	R	$\sqrt{3}$	0	0	∞
SDL	System detection limit	0.04	R	$\sqrt{3}$	1	0.02	∞
Uncertainty terms dependent on the DUT and environmental factors							
PC	Probe coupling with DUT	0	R	$\sqrt{3}$	1	0	∞
MOD	Modulation response	0.40	R	$\sqrt{3}$	0	0	∞
IT	Integration time	0	R	$\sqrt{3}$	1	0	∞
RT	Response time	0	R	$\sqrt{3}$	1	0	∞
DH	Device holder influence	0.10	R	$\sqrt{3}$	0	0	∞
DA	DUT alignment	0	R	$\sqrt{3}$	1	0	∞
AC	RF ambient conditions	0.04	R	$\sqrt{3}$	1	0.02	∞
AR	Ambient Reflections	0.04	R	$\sqrt{3}$	1	0.02	∞
MSI	Immunity / secondary reception	0	R	$\sqrt{3}$	0	0	∞
DRI	Drift of the DUT	0.10	R	$\sqrt{3}$	1	0.06	∞
Combined Standard Uncertainty						0.20	∞
Expanded Standard Uncertainty (95%)						0.40	

PD Relative Uncertainty Budget for DUT Evaluations							
Error Description		Unc. Value (±dB)	Probab. Distri.	Div.	(c_i)	Std. Unc. (±dB)	(ν_i) ν_{eff}
Uncertainty terms dependent on the measurement system							
CAL	Calibration	0.49	N	1	0	0.0	∞
COR	Probe correction	0	R	$\sqrt{3}$	1	0	∞
FRS	Frequency response (BW ≤ 1 GHz)	0.20	R	$\sqrt{3}$	0	0.0	∞
SCC	Sensor cross coupling	0	R	$\sqrt{3}$	1	0	∞
ISO	Isotropy	0.50	R	$\sqrt{3}$	0.5	0.14	∞
LIN	Linearity	0.20	R	$\sqrt{3}$	0.5	0.06	∞
PSC	Probe scattering	0	R	$\sqrt{3}$	1	0	∞
PPO	Probe positioning offset	0.30	R	$\sqrt{3}$	0	0.0	∞
PPR	Probe positioning repeatability	0.04	R	$\sqrt{3}$	1	0.02	∞
SMO	Sensor mechanical offset	0	R	$\sqrt{3}$	1	0	∞
PSR	Probe spatial resolution	0	R	$\sqrt{3}$	1	0	∞
FLD	Field impedance dependence	0	R	$\sqrt{3}$	1	0	∞
APD	Amplitude and phase drift	0	R	$\sqrt{3}$	1	0	∞
APN	Amplitude and phase noise	0.04	R	$\sqrt{3}$	1	0.02	∞
TR	Measurement area truncation	0	R	$\sqrt{3}$	1	0	∞
DAQ	Data acquisition	0.03	N	1	1	0.03	∞
SMP	Sampling	0	R	$\sqrt{3}$	1	0	∞
REC	Field reconstruction	0.6	R	$\sqrt{3}$	0.5	0.17	∞
TRA	FTE/MEO	0 (0.7)	R	$\sqrt{3}$	0.5	0 (0.20)	∞
SCA	Power density scaling	–	R	$\sqrt{3}$	1	–	∞
SAV	Spatial averaging	0.10	R	$\sqrt{3}$	1	0.06	∞
SDL	System detection limit	0.04	R	$\sqrt{3}$	1	0.02	∞
Uncertainty terms dependent on the DUT and environmental factors							
PC	Probe coupling with DUT	0	R	$\sqrt{3}$	1	0	∞
MOD	Modulation response	0.40	R	$\sqrt{3}$	1	0.23	∞
IT	Integration time	0	R	$\sqrt{3}$	1	0	∞
RT	Response time	0	R	$\sqrt{3}$	1	0	∞
DH	Device holder influence	0.10	R	$\sqrt{3}$	0	0.0	∞
DA	DUT alignment	0	R	$\sqrt{3}$	1	0	∞
AC	RF ambient conditions	0.04	R	$\sqrt{3}$	1	0.02	∞
AR	Ambient reflections	0.04	R	$\sqrt{3}$	1	0.02	∞
MSI	Immunity / secondary reception	0	R	$\sqrt{3}$	1	0	∞
DRI	Drift of the DUT	–	R	$\sqrt{3}$	1	–	∞
Combined Std Uncertainty (w/ FTE/MEO)						0.42	∞
Expanded Std Uncertainty (w/ FTE/MEO)						0.84	

According to IEC 62479, a **relative uncertainty** (expanded) of 30 % is used for a number of EMF assessment methods. Therefore this level of relative uncertainty is used as a default maximum in this generic standard. The uncertainty values specified for each EMF assessment method are the maximum allowed uncertainties. If the uncertainty value >30 %, Test result shall be corrected.

For DASY6 PD **Relative Uncertainty** Budget System Performance Check mentioned above:

Expanded Standard Uncertainty=0.4dB=1.096 numeric, 9.6%<30%. So there is no need to make the correction, and measured data adopt as final result.

For DASY6 PD **Relative Uncertainty** Budget for DUT Evaluations mentioned above:

Expanded Standard Uncertainty=0.84dB=1.213 numeric, 21.3%<30%. So there is no need to make the correction, and measured data adopt as final result.

Note: Relative uncertainty is the percentage based on reference value, it's different from absolute uncertainty. It is very important to distinguish these two items and flowing the post-processing necessary.

8 TEST EQUIPMENTS

The measurements were performed using an automated near-field scanning system, DASYS, manufactured by Schmid & Partner Engineering AG (SPEAG) in Switzerland, all the components and supplement devices listed below.

Test Equipment	Model	Serial Number	Calibration date	Calibration due data
DAE	DAE4	546	2022/09/15	2023/09/14
mmWave probe	EUmmWV4	9603	2022/10/25	2023/10/24
Dipole Validation Kit	Verification source10GHz	2015	2021/11/29	2023/11/28
Dipole Validation Kit	Verification source30GHz	1092	2021/11/29	2023/11/28
Dipole Validation Kit	Verification source45GHz	1002	2021/11/29	2023/11/28

Test Equipment	Model	Serial Number
Signal Generator	E8257dD	MY46522016
Power meter	E4417A	MY45101004
Power Sensor	E9300B	MY41496001
Power Sensor	E9300B	MY41496003

Software	Version
cDASY6mmWave	3.0.0.841