

TEST REPORT FOR WLAN TESTING

Report No.: SRTC2023-9004(F)-23032901(R)

Product Name: Smart Phone

Product ID: APYHRO00325

Applicant: Sharp Corporation

Manufacturer: Sharp Corporation

Specification: FCC Part 15 Subpart E (2022)

ANSI C63.10 (2013)

FCC ID: APYHRO00325

The State Radio_monitoring_center Testing Center (SRTC)

15th Building, No.30Shixing Street, Shijingshan District, Beijing, P.R.China

Tel: 86-10-57996183 Fax: 86-10-5799638

CONTENTS

1. GENERAL INFORMATION	2
1.1 Notes of the test report.....	2
1.2 Information about the testing laboratory	2
1.3 Applicant’s details.....	2
1.4 Manufacturer’s details.....	2
1.5 Test Environment	3
2. DESCRIPTION OF THE DEVICE UNDER TEST	4
2.1Final Equipment Build Status.....	4
2.2Wireless Technology and Frequency Range.....	4
2.3 Support Equipment	6
2.4 Note	6
3 REFERENCE SPECIFICATION	8
4 KEY TO NOTES AND RESULT CODES	8
5. RESULT SUMMARY	9
6 TEST RESULT.....	11
6.1 26dB Bandwidth and 99% Bandwidth	11
6.2 Maximum Conducted Output Power.....	12
6.3 Maximum Power Spectral Density.....	13
6.4 In-Band Emissions.....	14
6.5 Contention Based Protocol	15
6.6 Undesirable Emissions and Unwanted Radiated Emission Measurement.....	16
6.7 AC Power line Conducted Emission.....	20
7 MEASUREMENT UNCERTAINTIES	21
8 TEST EQUIPMENTS	22
APPENDIX A – TEST DATA OF CONDUCTED EMISSION	23
APPENDIX B – TEST DATA OF RADIATED EMISSION	23

1. GENERAL INFORMATION

1.1 Notes of the test report

The test report may only be reproduced or published in full. Reproduction or publication of extracts from the report requires the prior written permission of The State Radio_monitoring_center Testing Center (SRTC). The test results relate only to individual items of the samples which have been tested. The certification and accreditation identifiers used in this report shall not be applicable to the tested or calibrated samples thereof. The manufacturer shall not mark the tested samples or items (or a separate part of the item) with the identifiers of certification and accreditation to mislead relevant parties about the tested samples or items.

1.2 Information about the testing laboratory

Company:	The State Radio_monitoring_center Testing Center (SRTC)
Test Site 1:	15th Building, No.30 Shixing Street, Shijingshan District
Test Site 2:	No.80, Zhaojiachang, Beizang, Daxing District
City:	Beijing
Country or Region:	P.R.China
Contacted person:	Liu Jia
Tel:	+86 10 57996183
Fax:	+86 10 57996388
Email:	liuji@srhc.org.cn
Designation Number:	CN1267
Registration number:	239125

1.3 Applicant's details

Company:	Sharp Corporation
Address:	1 Takumi-cho, Sakai-ku, Sakai City, Osaka 590-8522, Japan

1.4 Manufacturer's details

Company:	Sharp Corporation
Address:	1 Takumi-cho, Sakai-ku, Sakai City, Osaka 590-8522, Japan

1.5 Test Environment

Date of Receipt of test sample at SRTC:	2023-03-29
Testing Start Date:	2023-03-30
Testing End Date:	2023-05-04

Environmental Data:	Temperature (°C)	Humidity (%)
Ambient	25	40
Maximum Extreme	55	---
Minimum Extreme	-10	---

Normal Supply Voltage (V d.c.):	4.0
Maximum Extreme Supply Voltage (V d.c.):	4.0
Minimum Extreme Supply Voltage (V d.c.):	3.7

2. DESCRIPTION OF THE DEVICE UNDER TEST

2.1 Final Equipment Build Status

Frequency Band(s):	U-NII-5:5945MHz-6425MHz
Modulation Type:	802.11a 802.11ax (HE20/HE40/HE80/HE160)
RU Type	Full RU Partial RU
Antenna Type:	PIFA
Antenna Gain:	ANT4: 0 dBi ANT8: -1.3 dBi
Directional Gain:	0dBi(for Power) 2.38dBi(for PSD)
Power Supply:	Battery/DC supply
Software Revision:	NA
Hardware Revision:	PVT(Remodeled to the equivalent of MP products)
IMEI:	004401231335569

2.2 Wireless Technology and Frequency Range

Wireless Technology		Bandwidth	Channel	Frequency(MHz)
Wi-Fi	U-NII-5	20	1	5955
			5	5975
			9	5995
			13	6015
			17	6035
			21	6055
			25	6075
			29	6095
			33	6115
			37	6135
			41	6155
			45	6175
			49	6195
			53	6215
			57	6235
			61	6255
			65	6275
			69	6295
			73	6315
			77	6335
		81	6355	
		85	6375	
		89	6395	
		93	6415	
		40	3	5965
			11	6005
			19	6045
			27	6085
			35	6125
			43	6165
			51	6205
			59	6245
			67	6285
			75	6325
		80	7	5985
			23	6065
			39	6145
			55	6225
			71	6305
			87	6385
		160	15	6025
			47	6185
				79

2.3 Support Equipment

The following support equipment was used to exercise the DUT during testing:

N/A

2.4 Note

Automatically Discontinue Transmission

Description	The device shall automatically discontinue transmission in case of either absence of information to transmit or operational failure. These provisions are not intended to preclude the transmission of control or signaling information or the use of repetitive codes used by certain digital technologies to complete frame or burst intervals. Applicants shall include in their application for equipment authorization to describe how this requirement is met.
Result	While the EUT is not transmitting any information, the EUT can automatically discontinue transmission and become standby mode for power saving. The EUT can detect the controlling signal of ACK message transmitting from remote device and verify whether it shall resend or discontinue transmission.

Antenna requirement (FCC part 15.203)

An intentional radiator antenna shall be designed to ensure that no antenna other than that furnished by the responsible party can be used with the device. The use of a permanently attached antenna or of an antenna that uses a unique coupling to the intentional radiator shall be considered sufficient to comply with the provisions of this section.

- The antenna(s) of the EUT are permanently attached.
- There are no provisions for connection to an external antenna.

Note: The antenna provides to the EUT, please refer to the following table:

Brand	Model	Antenna gain	Frequency Bands	Antenna type	Conn ecter Type
N/A	N/A	ANT4: 0 dBi ANT8: -1.3dBi	U-NII-5:5945MHz-6425MHz	PIFA	N/A

Note1: Manufacturers ensure that their designs will not be modified by the user or third party's arbitrary antenna parameters and performance. The EUT complies with the requirement of §15.203.

Note2: The antenna gain is provided by the customer and involved in the calculation and influence of the test results. Our laboratory takes the value declared by the customer as the criterion, and the customer is responsible for the antenna gain value. Manufacturers ensure that their designs will not be modified by the user or third party's arbitrary antenna parameters and performance.

NOTE3: Refer to section F of 662911 D01, Categorization as Correlated or Completely Uncorrelated:

Correlated signals include, but are not limited to, signals transmitted in any of the following modes:

- *Any transmit beamforming mode*, whether fixed or adaptive (e.g., phased array modes, closed loop MIMO modes, Transmitter Adaptive Antenna modes, Maximum Ratio Transmission (MRT) modes, and Statistical Eigen Beamforming (EBF) modes).
- *Cyclic Delay Diversity (CDD) modes, also known as Cyclic Shift Diversity (CSD)* (including modes for 802.11n and later devices to communicate with legacy 802.11 devices). In CDD modes, the same digital data is carried by each transmit antenna, but with different cyclic delays. The signals are highly correlated at any one frequency, though not necessarily at zero time delay. In particular, correlations tend to be high over the bandwidths specified for in-band PSD measurements in FCC rule parts that require reductions in PSD when directional gain exceeds a threshold.

Completely uncorrelated signals include those transmitted in the following modes, if they are not combined with any correlated modes, such as beamforming:

- Space Time Block Codes (STBC) or Space Time Codes (STC) for which different digital data is carried by each transmit antenna during any symbol period (e.g., WiMAX Matrix A [Alamouti coding]).
- Spatial Multiplexing MIMO (SM-MIMO), for which independent data streams are sent to each transmit antenna (e.g., WiMAX Matrix B). WiMAX Matrix C, which adds diversity, also produces uncorrelated transmit signals.

EUT is CDD MODE。 the output signals are Correlated。

For CDD transmissions directional gain is calculated as:

a) For power, the directional gain GANT is set equal to the antenna having the highest gain, i.e..

Directional gain = GANT MAX (Ant.1 Gain, Ant.2 Gain. ...) + Array Gain, where Array Gain = 0 dB (i.e., no array gain) for NANT < 4

b) For PSD, the directional gain calculation is following.

Directional gain = $10 \log[(10^{G1/10} + 10^{G2/10} + \dots + 10^{GN/10})^2/N_{ANT}]$ dBi

3 REFERENCE SPECIFICATION

Specification	Version	Title
FCC part 15 Subpart E	2022	Unlicensed national information infrastructure devices
ANSI C63.10	2013	Standard of Procedures for Compliance Testing of Unlicensed Wireless Devices
KDB 644545 D03	August 14, 2014	Guidance for IEEE std 802.11actm devices emission testing
KDB 905462 D03	August 22, 2016	U-NII client devices without radar detection capability
KDB 905462 D02	April 8, 2016	Compliance measurement procedures for unlicensed-national information infrastructure devices operating in the 5250-5350 MHz and 5470-5725 MHz bands incorporating dynamic frequency selection
KDB 662911 D01	October 31, 2013	Emissions testing of transmitters with multiple outputs in the same band
KDB 789033 D02	December 14, 2017	Guidelines for compliance testing of unlicensed national information infrastructure (U-NII) devices part 15, subpart e
KDB 987594 D02	February 04, 2021	Guidelines for compliance testing of unlicensed national information infrastructure 6 Ghz (U-Nii) devices Part 15, Subpart E.

4 KEY TO NOTES AND RESULT CODES

The following are the definition of the test result.

Code	Meaning
PASS	Test result shows that the requirements of the relevant specification have been met.
FAIL	Test result shows that the requirements of the relevant specification have not been met.
NT	Normal Temperature
NV	Nominal voltage
HV	High voltage
LV	Low voltage

5. RESULT SUMMARY

No.	Test case	FCC reference	Verdict	Test Site
(1)	26dB Bandwidth and 99% Bandwidth	15.407(a)(10)	Pass	1
(2)	Maximum Conducted Output Power	15.407(a)(10)	Pass	1
(3)	Maximum Power Spectral Density	15.407(a)(10)	Pass	1
(4)	In-Band Emissions	15.407(b)(6)	Pass	1
(5)	Contention Based Protocol	15.407(d)(6)	Pass	1

Test Site 1: 15th Building, No.30 Shixing Street, Shijingshan District

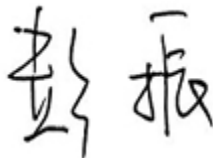
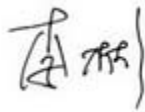
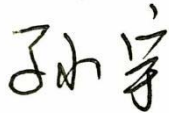
This Test Report Is Approved by: Mr. Peng Zhen 	Review by: Mr. Li Bin 
Tested and Issued by: Mr. Sun Yu 	Approved date: 20230609

No.	Test case	FCC reference	Verdict	Test Site
(6)	Undesirable Emissions and Unwanted Radiated Emission Measurement	15.205 15.407(b)(5) 15.407(b)(7),(8)	Pass	2
(7)	AC Power line Conducted Emission	15.407(b)(8)	Pass	2

Test Site 2: No.80, Zhaojiachang, Beizang, Daxing District

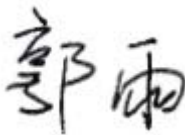
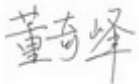
This Test Report Is Approved by: Mr. Liu Wei 	Review by: Mr. Guo Yu 
Tested and Issued by: Mr. Dong Qifeng 	Approved date: 20230609

6 TEST RESULT

6.1 26dB Bandwidth and 99% Bandwidth

6.1.1 Test limit

The maximum transmitter channel 26 dB bandwidth for U-NII devices in the 5.925-7.125 GHz band is 320MHz. 99% of the occupied bandwidth of any channel must be contained within each of its respective U-NII sub bands.

6.1.2 Test Procedure Used

ANSI C63.10-2013 – Section 12.4
KDB 789033 D02 v02r01 – Section C
KDB 987594 D02

6.1.3 Test Settings

1. The signal analyzers' automatic bandwidth measurement capability was used to perform the 26dB bandwidth measurement. The "X" dB bandwidth parameter was set to $X = 26$. The automatic bandwidth measurement function also has the capability of simultaneously measuring the 99% occupied bandwidth. The bandwidth measurement was not influenced by any intermediate power nulls in the fundamental emission.
2. RBW = approximately 1% of the emission bandwidth
3. VBW > 3 x RBW
4. Detector = Peak
5. Trace mode = max hold

6.1.4 Test Setup

The EUT and measurement equipment were set up as shown in the diagram below.

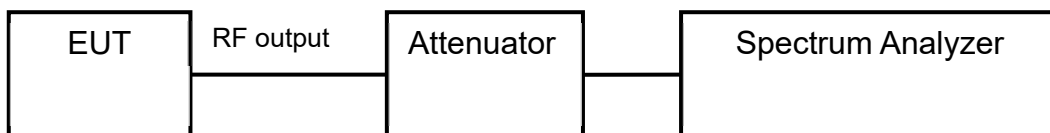

6.1.5 Test result

The test results are shown in Appendix A.

6.2 Maximum Conducted Output Power

6.2.1 Test limit

In the 5.925 – 7.125GHz band, the maximum e.i.r.p. is 24 dBm.

6.2.2 Test Procedure Used

KDB 987594 -Section E

KDB 789033 - Section E.3.b

ANSI C63.10-2013 – Section 12.3.3

KDB 662911 D01, D02 (Multiple Transmitter Output)

6.2.3 Test Settings

Average power measurements were performed only when the EUT was transmitting at its maximum power control level using a broadband power meter with a pulse sensor. The power meter implemented triggering and gating capabilities which were set up such that power measurements were recorded only during the ON time of the transmitter. The trace was averaged over 100 traces to obtain the final measured average power.

6.2.4 Test Setup

The EUT and measurement equipment were set up as shown in the diagram below.

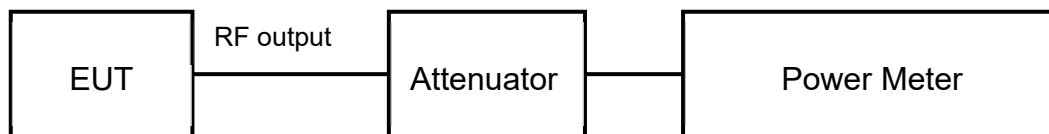

6.2.5 Test result

The test results are shown in Appendix A.

6.3 Maximum Power Spectral Density

6.3.1 Test limit

In the 5.925 – 7.125GHz band, the maximum power spectral density must not exceed -1 dBm e.i.r.p. in any 1 MHz band.

6.3.2 Test Procedure Used

ANSI C63.10-2013 – Section 12.3.2.2

KDB 789033 D02 v02r01 – Section F

ANSI C63.10-2013 – Section 14.3.2.2 Measure-and-Sum Technique

KDB 662911 v02r01 – Section E)2) Measure-and-Sum Technique.

6.3.3 Test Settings

- (1) Analyzer was set to the center frequency of the UNII channel under investigation
- (2) Span was set to encompass the entire emission bandwidth of the signal
- (3) Set RBW = 1 MHz, VBW = 3MHz
- (4) Number of sweep points > 2 x (span/RBW)
- (5) Sweep time = auto
- (6) Detector = power averaging (RMS)
- (7) Trigger was set to free run for all modes
- (8) Trace was averaged over 100 sweeps
- (9) The peak search function of the spectrum analyzer was used to find the peak of the spectrum.

6.3.4 Test Setup

The EUT and measurement equipment were set up as shown in the diagram below.

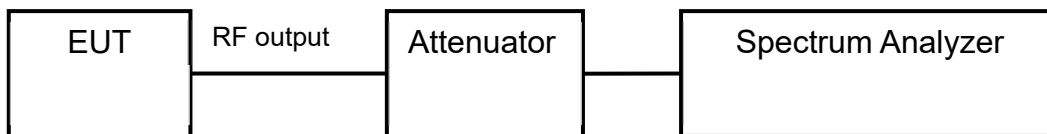

6.3.5 Test result

The test results are shown in Appendix A.

6.4 In-Band Emissions

6.4.1 Test limit

Suppressed by 20 dB at 1 MHz outside of the channel edge. (The channel edge is defined as the 26-dB point on either side of the carrier center frequency.)

Suppressed by 28 dB at one channel bandwidth from the channel center.

Suppressed by 40 dB at one- and one-half times the channel bandwidth from the channel center.

6.2.2 Test Procedure Used

KDB 987594 -Section J

6.2.3 Test Settings

(1) Measure the power spectral density (which will be used for emissions mask reference) using the following procedure:

a Set the span to encompass the entire 26 dB EBW of the signal.

b Set RBW = same RBW used for 26 dB EBW measurement.

c Set VBW \geq 3X RBW

d Number of points in sweep \geq [2 X span / RBW].

e Sweep time = auto.

f Detector = RMS (i.e., power averaging)

g Trace average at least 100 traces in power averaging (rms) mode.

h Use the peak search function on the instrument to find the peak of the spectrum.

(2) For the purposes of developing the emission mask, the channel bandwidth is defined as the 26 dB EBW.

(3) Clear trace.

(4) Trace average at least 100 traces in power averaging (rms) mode.

(5) Adjust the reference level as necessary so that the crest of the channel touches the top of the emission mask.

6.2.4 Test Setup

The EUT and measurement equipment were set up as shown in the diagram below.

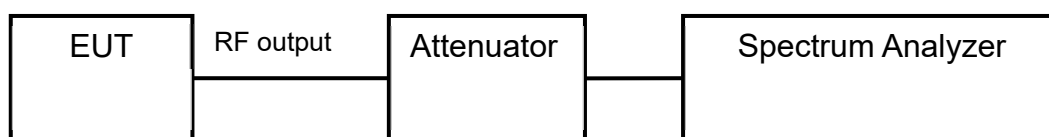

6.2.5 Test result

The test results are shown in Appendix A.

6.5 Contention Based Protocol

6.5.1 Test limit

Devices must detect co-channel energy with 90% or greater certainty.

6.5.2 Test Procedure Used

KDB 987594 -Section I

6.5.3 Test Settings

- (1) Configure the EUT to transmit with a constant duty cycle.
- (2) Set the operating parameters of the EUT including power level, operating frequency, modulation and bandwidth.
- (3) Set the signal analyzer center frequency to the nominal EEUT channel center frequency. The span range of the signal analyzer shall be between two times and five times the OBW of the EUT.
- (4) Monitoring the signal analyzer 2, verify the EUT is operating and transmitting with the parameters set at step two.
- (5) Using an AWGN signal source, generate (but do not transmit, i.e., RF OFF) a 10 MHz-wide AWGN signal. Use Table 1 to determine the center frequency of the 10 MHz AWGN signal relative to the EUT's channel bandwidth and center frequency.
- (6) Set the AWGN signal power to an extremely low level (more than 20 dB below the -62 dBm threshold). Connect the AWGN signal source, via a 3-dB splitter, to the signal analyzer 1 and the EUT as shown in Figure 2.
- (7) Transmit the AWGN signal (RF ON) and verify its characteristics on the signal analyzer 1.
- (8) Monitor the signal analyzer 2 to verify if the AWGN signal has been detected and the EUT has ceased transmission. If the EUT continues to transmit, then incrementally increase the AWGN signal power level until the EUT stops transmitting.
- (9) (Including all losses in the RF paths) Determine and record the AWGN signal power level (at the EUT's antenna port) at which the EUT ceased transmission. Repeat the procedure at least 10 times to verify the EUT can detect an AWGN signal with 90% (or better) level of certainty.
- (10) Refer to Table 1 to determine number of times the detection threshold testing needs to be repeated. If testing is required more than once, then go back to step 5, choose a different center frequency for the AWGN signal and repeat the process.

6.5.4 Test Setup

The EUT and measurement equipment were set up as shown in the diagram below.

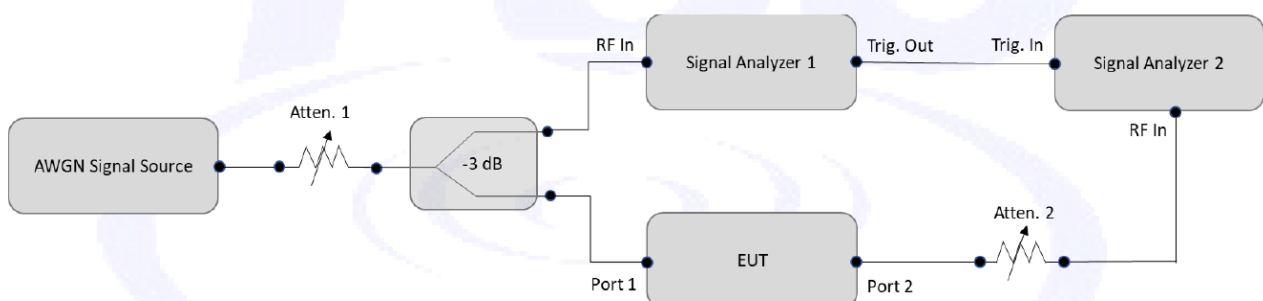

6.5.5 Test result

The test results are shown in Appendix A.

6.6 Undesirable Emissions and Unwanted Radiated Emission Measurement

6.6.1 Test Description

All out of band radiated spurious emissions are measured with a spectrum analyzer connected to a receive antenna while the EUT is operating at maximum power and at the appropriate frequencies. Only the radiated emissions of the configuration that produced the worst case emissions are reported in this section.

6.6.2 Test limit

FCC Part15.205, 15.209,;

In addition, radiated emissions which fall in the restricted bands, as defined in Section 15.205(a), must also comply with the radiated emission limits specified in Section 15.209(a) (see Section 15.205(c)). All out of band emissions appearing in a restricted band as specified in Section 15.205 of the Title 47 CFR must not exceed the limits shown in below Table per Section 15.209. The spectrum shall be investigated from the lowest radio frequency signal generated in the device

Frequency [MHz]	Field strength [$\mu\text{V/m}$]	Measured Distance [meters]
0.009~0.490	2400/F(kHz)	300
0.490~1.705	24000/F(kHz)	30
1.705~30.0	30	30
30~88	100	3
88~216	150	3
216~960	200	3
Above 960	500	3

Radiated Limits

FCC Part15.35(b):

There is also a limit on the radio frequency emissions, as measured using instrumentation with a peak detector function, corresponding to 20 dB above the maximum permitted average limit

Used conversion factor: Limit (dB $\mu\text{V/m}$) = 20 log (Limit ($\mu\text{V/m}$)/1 $\mu\text{V/m}$)

Frequency [MHz]	Detector	Unit (dB $\mu\text{V/m}$)
30~88	Quasi-peak	40.0
88~216	Quasi-peak	43.5
216~960	Quasi-peak	46.0
960~1000	Quasi-peak	54.0
1000~5th harmonic of the highest frequency or 40GHz, whichever is lower	Average	54.0
	Peak	74.0

Conversion Radiated limits

6.6.3 Test Procedure Used

KDB 789033 D02 v02r01, Sections G.3, G.4, G.5, and G.6.

For Radiated emission below 30MHz

- a. The EUT was placed on the top of a rotating table 0.8 meters above the ground at chamber room. The table was rotated 360 degrees to determine the position of the highest radiation.
- b. The EUT was set 3 meters away from the interference-receiving antenna, which was mounted on the top of a variable-height antenna tower.
- c. Both X and Y axes of the antenna are set to make the measurement.
- d. For each suspected emission, the EUT was arranged to its worst case and the rotatable table was turned from 0 degrees to 360 degrees to find the maximum reading.
- e. The test-receiver system was set to Quasi-Peak Detect Function and recorded the reading with Maximum Hold Mode.

NOTE:

1. The resolution bandwidth and video bandwidth of test receiver/spectrum analyzer complied the following setting:

Frequency	RBW
9-150kHz	200-300Hz
0.15-30MHz	9-10kHz

Signals below 30MHz are not recorded in the report because they are lower than the limits by more than 20dB.

For Radiated emission above 30MHz

- a. The EUT was placed on the top of a rotating table 0.8 meters (for 30MHz ~ 1GHz) / 1.5 meters (for above 1GHz) above the ground in chamber room for test. The table was rotated 360 degrees to determine the position of the highest radiation.
- b. The EUT was set 3 meters away from the interference-receiving antenna, which was mounted on the top of a variable-height antenna tower.
- c. The height of antenna is varied from one meter to four meters above the ground to determine the maximum value of the field strength. Both horizontal and vertical polarizations of the antenna are set to make the measurement.
- d. For each suspected emission, the EUT was arranged to its worst case and then the antenna was tuned to heights from 1 meter to 4 meters and the rotatable table was turned from 0 degrees to 360 degrees to find the maximum reading.
- e. The test-receiver system was set to quasi-peak detect function and recorded the reading with Maximum Hold Mode when the test frequency is below 1 GHz.
- f. The test-receiver system was set to peak and average detector and recorded the reading with Maximum Hold Mode when the test frequency is above 1 GHz. If the peak reading value also meets average limit, measurement with the average detector is unnecessary.

For the radiated emission test above 1GHz:

Place the measurement antenna away from each area of the EUT determined to be a source of emissions at the specified measurement distance, while keeping the measurement antenna aimed at the source of emissions at each frequency of significant

emissions, with polarization oriented for maximum response. The measurement antenna may have to be higher or lower than the EUT, depending on the radiation pattern of the emission and staying aimed at the emission source for receiving the maximum signal. The final measurement antenna elevation shall be that which maximizes the emissions. The measurement antenna elevation for maximum emissions shall be restricted to a range of heights of from 1 m to 4 m above the ground or reference ground plane.

NOTE:

1. The resolution bandwidth and video bandwidth of test receiver/spectrum analyzer is 120kHz for Quasi-peak detection (QP) at frequency below 1GHz.
2. The resolution bandwidth of test receiver/spectrum analyzer is 1 MHz and the video bandwidth is 3 MHz for Peak detection (PK) at frequency above 1GHz.
3. The resolution bandwidth of test receiver/spectrum analyzer is 1 MHz and the video bandwidth is 3 MHz for Average detection (AV) at frequency above 1GHz. If duty cycle of test signal is < 98%, the duty factor need added to measured value.
4. All modes of operation were investigated and the worst-case emissions are reported.

6.6.4 Test Settings

Frequency	Detector
< 1000MHz	Quasi-peak
>1000MHz	Peak and average

Frequency	RBW
9-150kHz	200-300Hz
0.15-30MHz	9-10kHz
30-1000MHz	100-120kHz
>1000MHz	1MHz

6.6.5 Radiated emission below 30MHz

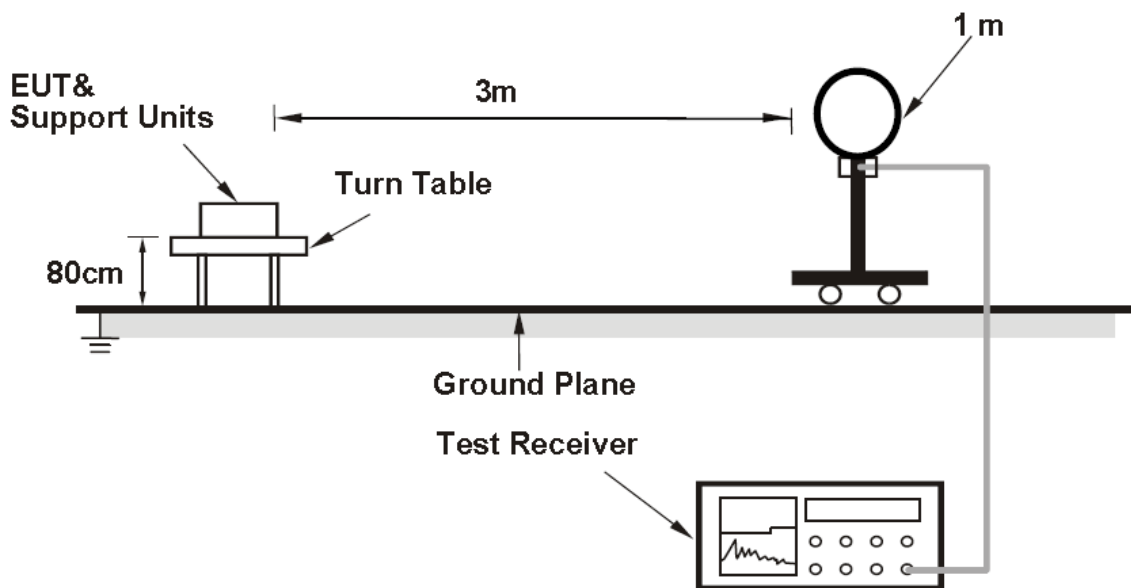

For Radiated emission 30MHz to 1GHz

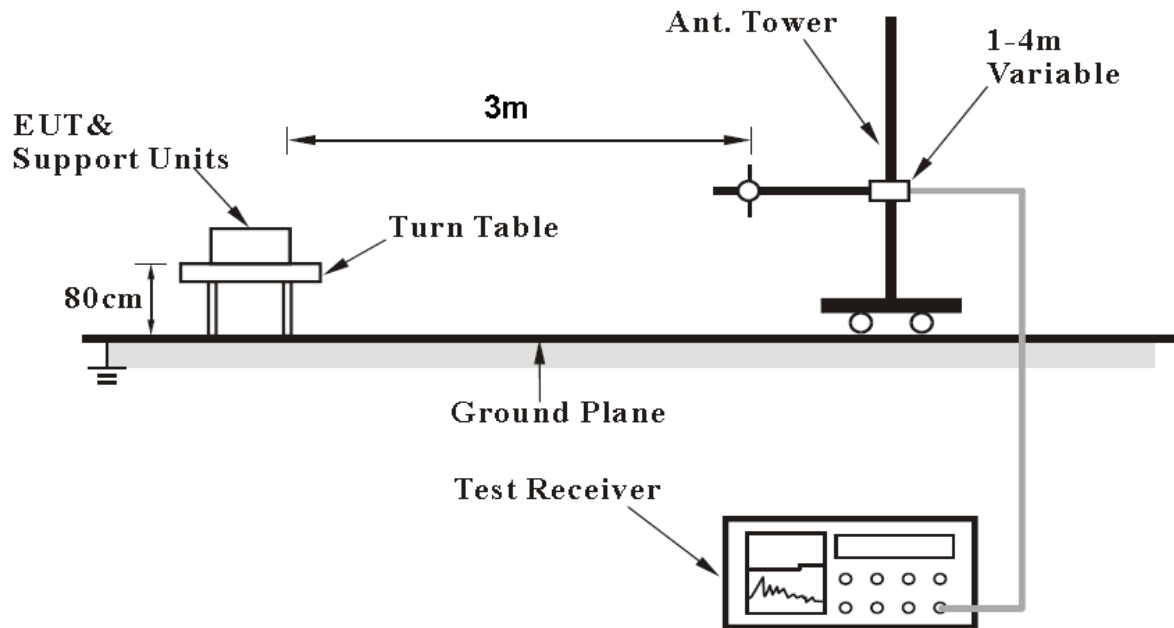

For Radiated emission above 1GHz

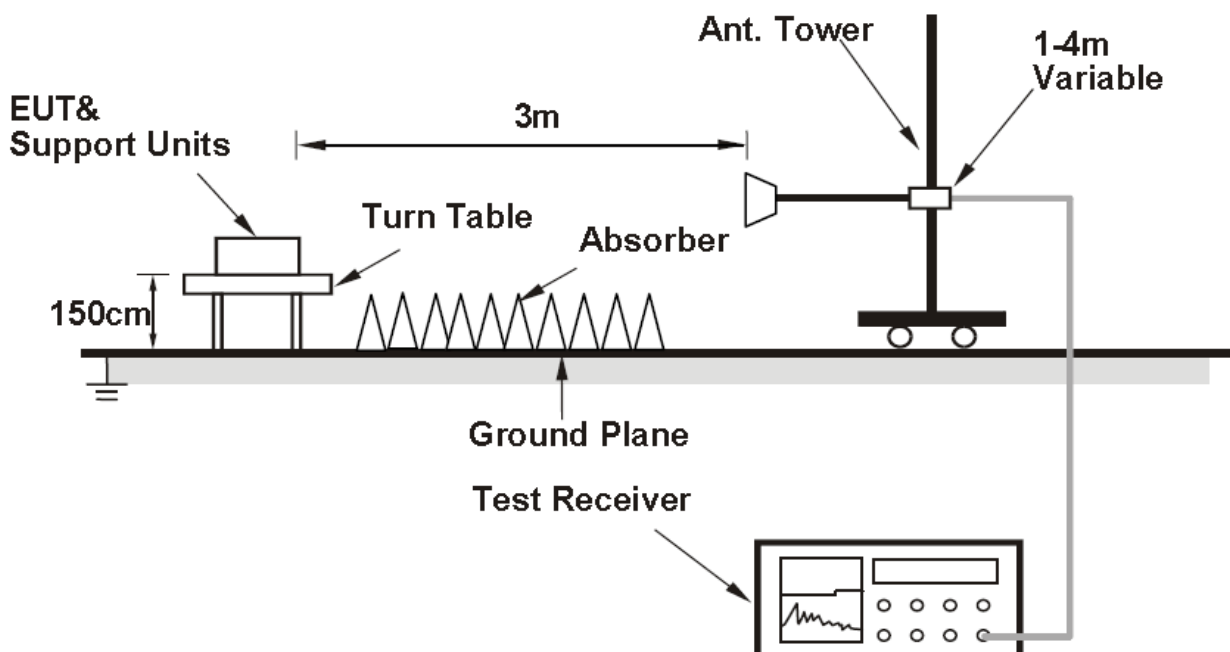

6.6.6 Test result

The test results are shown in Appendix B.

6.7 AC Power line Conducted Emission

6.7.1 Test limit

FCC Part 15.207(a) ,

Frequency of Emission (MHz)	Conducted Limit (dBuV)	
	Quasi-peak	Average
0.15-0.5	66 to 56 *	56 to 46 *
0.5-5	56	46
5-30	60	50

* Decreases with the logarithm of the frequency.

The measurement is made according to ANSI C63.10-2013

6.7.2 Test result

The test results are shown in Appendix B.

7 MEASUREMENT UNCERTAINTIES

Items	Uncertainty	
6dB Bandwidth	3kHz	
Peak power output	0.67dB	
Transmitter Power Spectral Density	0.75dB	
Band edge compliance	1.20dB	
Conducted Out of band emission measurement	30MHz~1GHz	2.83dB
	1GHz~12.75GHz	2.50dB
	12.75GHz~25GHz	2.75dB
Spurious Radiated Emissions	30MHz~200MHz	4.88dB
	200MHz~1GHz	4.87dB
	1GHz~18GHz	4.58dB
	18GHz~40GHz	4.35dB
AC Power line Conducted Emission	3.92dB	

8 TEST EQUIPMENTS

No.	Name/ Model	Manufacturer	S/N	Cal date	Cal Due date
1.	Spectrum Analyzer / FSV	ROHDE & SCHWARZ	101065	2022.06.21	2023.06.20
2.	Signal Analyzer / N9020A	Agilent	MY48010771	2022.05.18	2023.05.17
3.	Bluetooth Test Set / MT8852B	Anritsu	1329003	2022.06.21	2023.06.20
4.	Power Divider / 11667A	HP	19632	2022.06.21	2023.06.20
5.	Signal Generator / SMBV100A	R&S	260910	2022.06.21	2023.06.20
6.	Temperature chamber / SH241	ESPEC	92013758	2022.06.21	2023.06.20
7.	Fully-Anechoic Chamber / 12.65m×8.03m×7.50m	FRANKONIA	----	----	----
8.	Semi-Anechoic/Chamber / 23.18m×16.88m×9.60m	FRANKONIA	---	----	----
9.	Turn table Diameter:1m	FRANKONIA	----	----	----
10.	Turn table Diameter:5m	FRANKONIA	----	----	----
11.	Antenna master FAC(MA4.0)	MATURO	----	----	----
12.	Antenna master SAC(MA4.0)	MATURO	----	----	----
13.	Shielding room / 9.080m×5.255m×3.525m	FRANKONIA	----	----	----
14.	Double-Ridged Waveguide Horn Antenna / HF 907	R&S	100512	2022.06.21	2023.06.20
15.	Double-Ridged Waveguide Horn Antenna / HF 907	R&S	100513	2022.06.21	2023.06.20
16.	Ultra log antenna / HL562	R&S	100016	2022.06.21	2023.06.20
17.	Receive antenna /3160-09	SCHWARZ-BECK	002058-002	2022.06.21	2023.06.20
18.	EMI test receiver	R&S	101574	2022.06.21	2023.06.20
19.	ESR3 EMI test receiver	R&S	102361	2023.04.12	2024.04.11
20.	Receive antenna / HL562	R&S	100167	2022.06.21	2023.06.20
21.	ENV216 AMN	R&S	101881	2022.06.21	2023.06.20
22.	WLAN AP WIA3300-20 (FCC ID: 2AHKT-WIA3300-20)	SKSpruce	8152017060700339	---	---
23.	Notebook E470c	Lenovo	PF10UZW7	---	---
24.	Horn antenna / SAS-574	A.H.SYSTEMS	2581	2023.03.06	2025.03.05
25.	Loop antenna / HFH2-Z2	R&S	100340	2022.08.21	2023.08.20
26.	VULB 9163 Ultra log test antenna	SCHWARZ-BECK	867	2021.05.29	2023.05.28
27.	Loop Antenna	R&S	100340	2022.08.21	2023.08.20
28.	Double Ridge Waveguide Horn Antenna	A.H.SYSTEMS	2581	2023.03.05	2025.03.05
29.	FCC auto test system / RT9200BW-2	Radiosky	V2.05	/	/
30.	EMI test software / EMC32	R&S	V10.20.01	/	/
31.	Power Meter E4416A	Agilent	MY52370013	2023.03.06	2024.03.05
32.	Power Sensor E9323A	Agilent	MY52150008	2023.03.06	2024.03.05

APPENDIX A – TEST DATA OF CONDUCTED EMISSION

Please refer to the attachment.

APPENDIX B – TEST DATA OF RADIATED EMISSION

Please refer to the attachment.