

TEST REPORT FOR UWB TESTING

Report No.: SRTC2023-9003(F)-0011

Product Name: Smart Phone

Product Model: APYHRO00325

Applicant: Sharp Corporation

Manufacturer: Sharp Corporation

Specification: FCC Part 15, Subpart F(2022)

The State Radio_monitoring_center Testing Center (SRTC)

15th Building, No.30, Shixing Street, Shijingshan District, Beijing, P.R.China

Tel: 86-10-57996183 Fax: 86-10-57996388

CONTENTS

<u>1. GENERAL INFORMATION</u>	2
1.1 NOTES OF THE TEST REPORT	2
1.2 INFORMATION ABOUT THE TESTING LABORATORY	2
1.3 APPLICANT’S DETAILS	2
1.4 MANUFACTURER’S DETAILS	2
1.5 TEST ENVIRONMENT	2
<u>2. DESCRIPTION OF THE DEVICE UNDER TEST</u>	3
<u>3. REFERENCE SPECIFICATION</u>	4
<u>4. KEY TO NOTES AND RESULT CODES</u>	4
<u>5.RESULT SUMMARY</u>	5
<u>6.TEST RESULT</u>	5
6.1 ANTENNA REQUIREMENT (15.203)	6
6.2 OPERATIONAL REQUIREMENTS OF THE DEVICE UNDER TEST (15.519 (A)).....	6
6.3 UWB BANDWIDTH (15.503 (A) (D), 15.519 (B)).....	6
6.4 AVERAGE TRANSMIT POWER (15.519 (C))	7
6.5 PEAK POWER DENSITY (15.519 (E)).....	8
6.6 SPURIOUS RADIATED EMISSIONS (SECTION 15.519 (C) 15.209 15.205).....	9
6.7 SPURIOUS RADIATED EMISSIONS IN GPS BANDS (15.519 (D)).....	11
6.8 SHUTDOWN TIMING REQUIREMENTS (SECTION 15.519(A)(1))	12
6.9 CONDUCTED EMISSIONS(SECTION 15.521)	13
<u>7. TEST EQUIPMENTS</u>	15
<u>APPENDIX A – TEST DATA</u>	16

1. GENERAL INFORMATION

1.1 Notes of the test report

The test report may only be reproduced or published in full. Reproduction or publication of extracts from the report requires the prior written permission of The State Radio_monitoring_center Testing Center (SRTC). The test results relate only to individual items of the samples which have been tested. The certification and accreditation identifiers used in this report shall not be applicable to the tested or calibrated samples thereof. The manufacturer shall not mark the tested samples or items (or a separate part of the item) with the identifiers of certification and accreditation to mislead relevant parties about the tested samples or items.

1.2 Information about the testing laboratory

Company:	The State Radio_monitoring_center Testing Center (SRTC)
Test Site 1:	15th Building, No.30 Shixing Street, Shijingshan District
Test Site 2:	No.80, Zhaojiachang, Beizang, Daxing District
City:	Beijing
Country or Region:	P.R.China
Contacted person:	Liu Jia
Tel:	+86 10 57996183
Fax:	+86 10 57996388
Email:	liujiaf@srtc.org.cn
Registration number:	239125

1.3 Applicant's details

Company:	Sharp Corporation
Address:	1 Takumi-cho, Sakai-ku, Sakai City, Osaka 590-8522, Japan

1.4 Manufacturer's details

Company:	Sharp Corporation
Address:	1 Takumi-cho, Sakai-ku, Sakai City, Osaka 590-8522, Japan

1.5 Test Environment

Date of Receipt of test sample at SRTC:	2023.4.24	
Testing Start Date:	2023.4.24	
Testing End Date:	2023.4.27	
Environmental Data:	Temperature (°C)	Humidity (%)
Ambient	23.8	39.4
Normal Supply Voltage (V d.c.):	4	

2. DESCRIPTION OF THE DEVICE UNDER TEST

Frequency Range	7737.6-8236.8MHz
Modulation	BPM/BPSK
PIFA	Integral (permanent fixed antenna, which may be built-in, designed as an indispensable part of EUT)
Power Supply	Battery
Rated Power Supply Voltage	4V
Device type	<input type="checkbox"/> ground penetrating radars and wall imaging systems
	<input type="checkbox"/> through-wall imaging systems
	<input type="checkbox"/> surveillance systems
	<input type="checkbox"/> medical imaging systems
	<input type="checkbox"/> vehicular radar systems
	<input type="checkbox"/> indoor UWB systems
	<input checked="" type="checkbox"/> hand held UWB systems
	<input type="checkbox"/> all UWB devices
HW Version	PVT(Remodeled to the equivalent of MP products)
SW Version	/
Device Type	Handheld device

Frequency(MHz)	Max Gain (dBi)
7737.6-8236.8	1.0

3. REFERENCE SPECIFICATION

Specification	Version	Title
FCC 47 CFR Part F	2022	Radio Frequency Devices; Subpart F –Ultra Wide Band Devices
ANSI C63.10	2013	American National Standard for Testing Unlicensed Wireless Devices
ANSI C63.4	2014	American National Standards for Methods of Measurement of Radio-Noise Emissions from Low-Voltage Electrical and Electronic Equipment in the Range of 9 kHz to 40 GHz
KDB 393764 D01 UWB FAQ v02	January 29, 2018	Ultra-Wideband (UWB) Devices frequently asked questions

4. KEY TO NOTES AND RESULT CODES

Code	Meaning
PASS	Test result shows that the requirements of the relevant specification have been met.
FAIL	Test result shows that the requirements of the relevant specification have not been met.
N/T	Test case is not tested.
NTC	Nominal voltage, Normal Temperature

5.RESULT SUMMARY

No.	Test case	FCC reference	Verdict
1	Antenna Requirement	15.203	Pass
2	Operational Requirements of the Device under Test	15.519 (a)	Pass
3	UWB Bandwidth	15.503 (a) (d) 15.519 (b)	Pass
4	Average TransmitPower	15.519 (c)	Pass
5	Peak Power Density	15.519 (e)	Pass
6	Spurious Radiated Emissions	15.519 (c) 15.209	Pass
7	Spurious Radiated Emissions in GPS Bands	15.519 (d)	Pass
8	Shutdown Timing Requirements	15.519 (a)(1)	Pass
9	Conducted Emissions	15.521	Pass

Test Site 2: No.80, Zhaojiachang, Beizang, Daxing District

Approved By: Mr. Guo Yu Vice director of the test department 郭雨	Checked By: Mr. Liu Jian 刘建
Tested by: Mr. Jiang Yi Test engineer 姜毅	Issued date: 2023.5.12

6.TEST RESULT

6.1 Antenna Requirement (15.203)

6.1.1 Requirement:

An intentional radiator shall be designed to ensure that no antenna other than that furnished by the responsible party shall be used with the device. The use of a permanently attached antenna or of an antenna that uses a unique coupling to the intentional radiator shall be considered sufficient to comply.

6.1.2 Result:

Compliant, the antenna utilized by the device is fixed to the module.

6.2 Operational Requirements of the Device under Test (15.519 (a))

6.2.1 Requirement:

(2) The use of antennas mounted on outdoor structures, e.g., antennas mounted on the outside of a building or on a telephone pole, or any fixed outdoors infrastructure is prohibited. Antennas may be mounted only on the hand held UWB device.

(3) UWB devices operating under the provisions of this section may operate indoors or outdoors.

6.2.2 Result:

Compliant.

6.3 UWB Bandwidth (15.503 (a) (d), 15.519 (b))

6.3.1 Requirement:

For the purpose of this subpart, the UWB bandwidth is the frequency band bounded by the points that are 10 dB below the highest radiated emission, as based on the complete transmission system including the antenna. The upper boundary is designated fH and the lower boundary is designated fL. The frequency at which the highest radiated emission occurs is designated fM.

An intentional radiator that, at any point in time, has a fractional bandwidth equal to or greater than 0.20 or has a UWB bandwidth equal to or greater than 500 MHz, regardless of the fractional bandwidth.

The UWB bandwidth of a device operating under the provisions of this section must be contained between 3100 MHz and 10,600 MHz.

6.3.2 Test Procedure

The UWB Bandwidth is measured conducted, while EUT is operating in transmission mode at the appropriate center frequency. The Resolution Bandwidth was set to 1MHz RBW IAW ANSI C63.10 Section 10.1.

Testing was performed under ambient conditions at nominal voltage.

6.3.3 Test Setup:

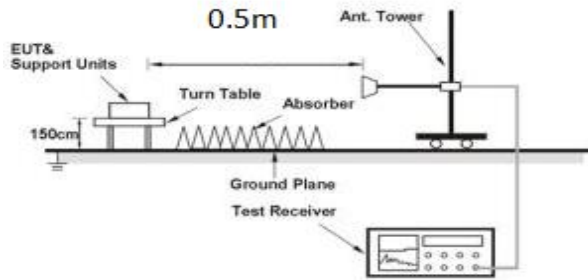

6.3.4 Result:

APPENDIX A – TEST DATA – A.1.

6.4 Average Transmit Power (15.519 (c))

6.4.1 Requirement:

The radiated emissions above 960 MHz from a device operating under the provisions of this section shall not exceed the following average limits when measured using a resolution bandwidth of 1 MHz:

Frequency (MHz)	EIRP (dBm)
3100 - 10600	-41.3

6.4.2 Test Procedure

The Average Transmit Power is measured radiated, at a 3-meter distance, while EUT is operating in transmission mode at the appropriate center frequency. The emissions are recorded and maximized as a function of azimuth by rotation through 360° with a spectrum analyzer in max hold mode. The Resolution Bandwidth was set to 1MHz RBW IAW 15.519(c).

Testing was performed under ambient conditions at nominal voltage.

6.4.3 Test Setup

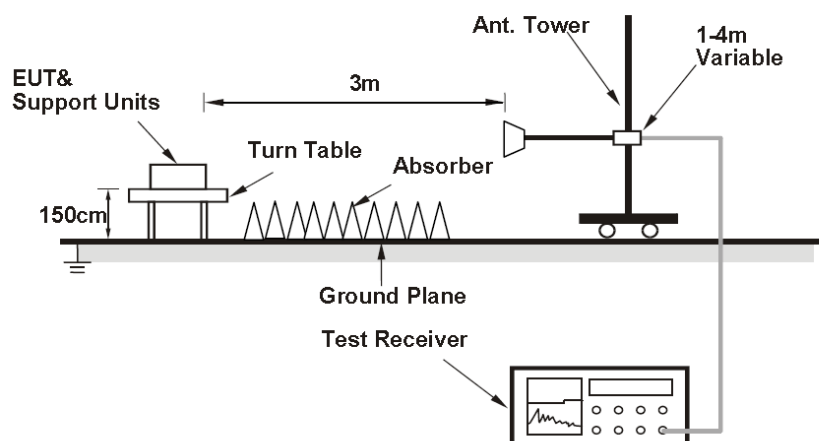

6.4.4 Result:

APPENDIX A – TEST DATA – A.2.

6.5 Peak Power Density (15.519 (e))

6.5.1 Requirement:

There is a limit on the peak level of the emissions contained within a 50 MHz bandwidth entered on the frequency at which the highest radiated emission occurs, f_M . That limit is 0 dBm EIRP.

6.5.2 Test Procedure

The Peak Power Density is measured radiated, at a 3-meter distance, while EUT is operating in transmission mode at the appropriate center frequency. The emissions are recorded and maximized as a function of azimuth by rotation through 360° with a spectrum analyzer in max hold mode. The Resolution Bandwidth was set to 50MHz RBW IAW ANSI C63.10 Section 10.3.6.

Testing was performed under ambient conditions at nominal voltage.

6.5.3 Test Setup

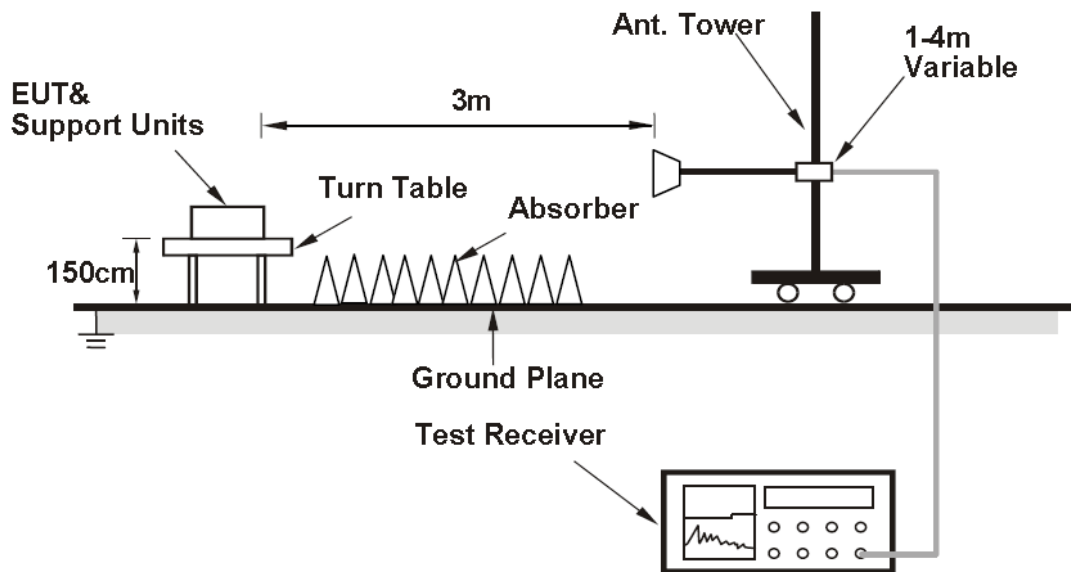

6.5.4 Result:

APPENDIX A – TEST DATA – A.3.

6.6 Spurious Radiated Emissions (Section 15.519 (c) 15.209 15.205)

6.6.1 Requirement:

The radiated emissions at or below 960 MHz from a device operating under the provisions of this section shall not exceed the emission levels in § 15.209. The radiated emissions above 960 MHz from a device operating under the provisions of this section shall not exceed the following average limits when measured using a resolution bandwidth of 1 MHz:

Frequency (MHz)	EIRPat 3 Meters (dBm)	Field strength at 3 Meters (dBμV/m)	Field strength at 0.5 Meters (dBμV/m)
960 - 1610	-75.3	19.9	35.56
1610 - 1990	-63.3	31.9	47.56
1990 - 3100	-61.3	33.9	49.56
3100 - 10600	-41.3	53.9	69.56
Above 10600	-61.3	33.9	49.56

Field Strength Calculation

Field strength at 3 Meters (dBμV/m) = EIRPat 3 Meters(dBm) + 95.2

Field strength at 0.5 Meters(dBμV/m) = Field strength at 3 Meters(dBμV/m)- 20log(0.5m/3m)

All out of band emissions appearing in a restricted band as specified in Section 15.205 of the Title 47 CFR must not exceed the limits shown in below Table per Section 15.209. The spectrum shall be investigated from the lowest radio frequency signal generated in the device

Frequency (MHz)	Field strength (μV/m)	Measured Distance (meters)
0.009~0.490	2400/F(kHz)	300
0.490~1.705	24000/F(kHz)	30
1.705~30.0	30	30
30~88	100	3
88~216	150	3
216~960	200	3

Radiated Limits

There is also a limit on the radio frequency emissions, as measured using instrumentation with a peak detector function, corresponding to 20 dB above the maximum permitted average limit

Used conversion factor: Limit (dBμV/m) = 20 log (Limit (μV/m)/1μV/m)

Frequency (MHz)	Detector	Unit (dBμV/m)
30~88	Quasi-peak	40.0
88~216	Quasi-peak	43.5
216~960	Quasi-peak	46.0

Conversion Radiated limits

6.6.2 Test Procedure

Radiated emissions for restricted bands below 1 GHz are measured in the semi-anechoic chamber at a 3-meter distance on every azimuth in both horizontal and vertical polarities.

Radiated emissions for restricted bands above 1 GHz are measured in the full-anechoic chamber at a 0.5-meter distance on every azimuth in both horizontal and vertical polarities.

The emissions are recorded and maximized as a function of azimuth by rotation through 360° with a spectrum analyzer in max hold mode. Depending on the frequency band spanned a notch filter was used

to remove the fundamental frequency. The highest emissions relative to the limit are listed for each frequency spanned.

Measurements on any restricted band frequency or frequencies above 1 GHz are based on the use of measurement instrumentation employing peak and average detectors. All measurements were performed using a resolution bandwidth of 1 MHz.

6.6.3 Test Setup

For Radiated emission below 30MHz

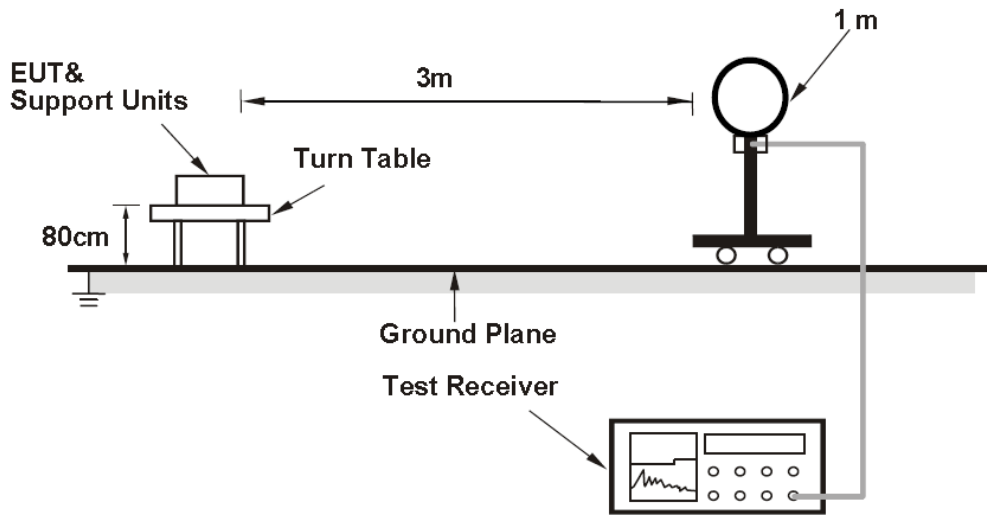

For Radiated emission 30MHz to 1GHz

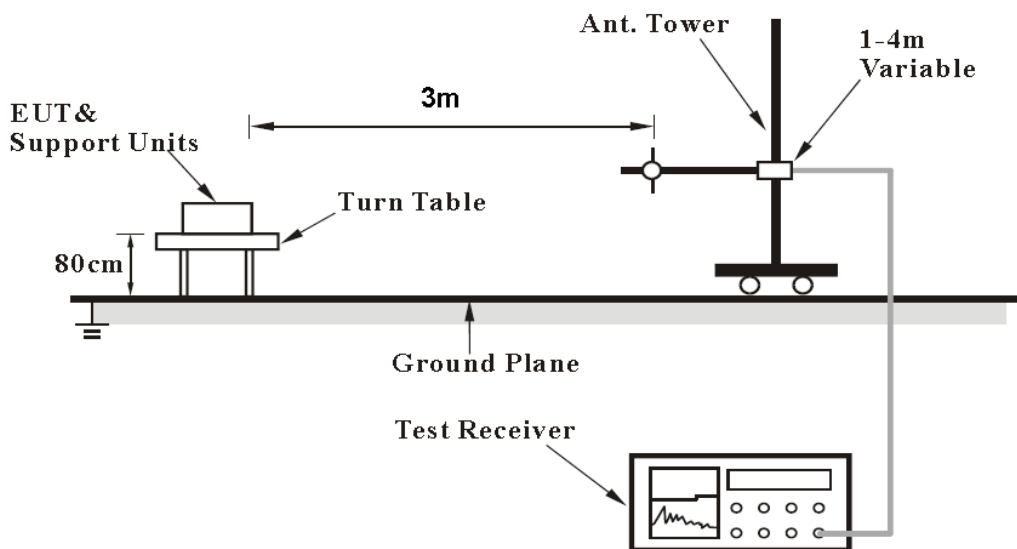

For Radiated emission above 1GHz

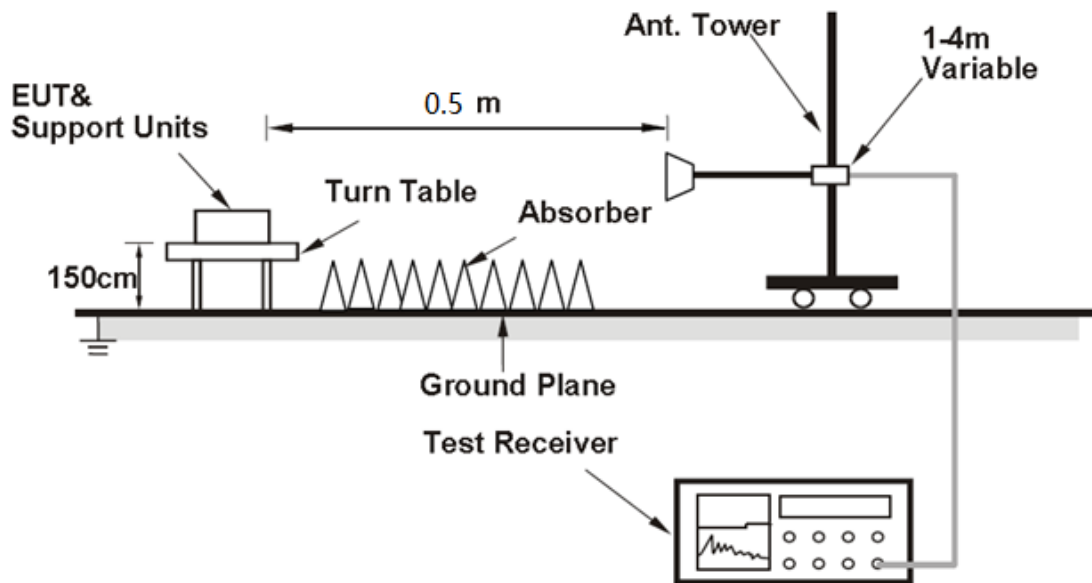

6.6.4 Result:
APPENDIX A – TEST DATA – A.4..

6.7 Spurious Radiated Emissions in GPS Bands (15.519 (d))

6.7.1 Requirement:

In addition to the radiated emission limits specified in the table in paragraph (c) of this section, UWB transmitters operating under the provisions of this section shall not exceed the following average limits when measured using a resolution bandwidth of no less than 1 kHz:

Frequency (MHz)	EIRP (dBm)	Field strength at 3 Meters (dBμV/m)	Field strength at 0.5 Meters (dBμV/m)
1164 - 1240	-85.3	9.9	25.46
1559 - 1610	-85.3	9.9	25.46

Field Strength Calculation

Field strength at 3 Meters (dBμV/m) = EIRP at 3 Meters (dBm) + 95.2

Field strength at 0.5 Meters (dBμV/m) = Field strength at 3 Meters (dBμV/m) - 20log(0.5m/3m)

6.7.2 Test Procedure

Radiated emissions for restricted bands above 1 GHz are measured in the anechoic chamber at a 0.5-meter distance on every azimuth in both horizontal and vertical polarities.

The emissions are recorded and maximized as a function of azimuth by rotation through 360° with a spectrum analyzer in max hold mode. Depending on the frequency band spanned a notch filter was used to remove the fundamental frequency. The highest emissions relative to the limit are listed for each frequency spanned.

Measurements on any restricted band frequency or frequencies above 1 GHz are based on the use of measurement instrumentation employing peak and average detectors. All measurements were performed using a resolution bandwidth of 1 kHz.

6.7.3 Test Setup

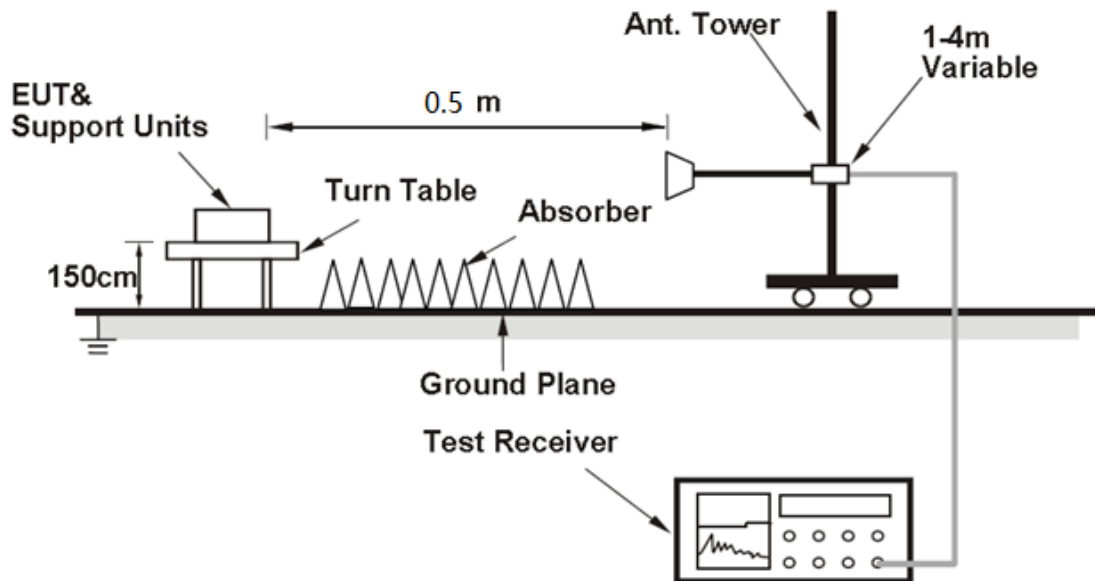

6.7.4 Result:

APPENDIX A – TEST DATA – A.5.

6.8 Shutdown Timing Requirements (Section 15.519(a)(1))

6.8.1 Requirement:

A UWB device operating under the provisions of this section shall transmit only when it is sending information to an associated receiver. The UWB intentional radiator shall cease transmission within 10 seconds unless it receives an acknowledgement from the associated receiver that its transmission is being received. An acknowledgment of reception must continue to be received by the UWB intentional radiator at least every 10 seconds or the UWB device must cease transmitting.

6.8.2 Test Procedure

The Shutdown Timing is measured radiated, while EUT is operating in normal work mode. The Resolution Bandwidth was set to 1MHz RBW IAW ANSI C63.10 Section 10.3.6.

Testing was performed under ambient conditions at nominal voltage.

6.8.3 Test Setup

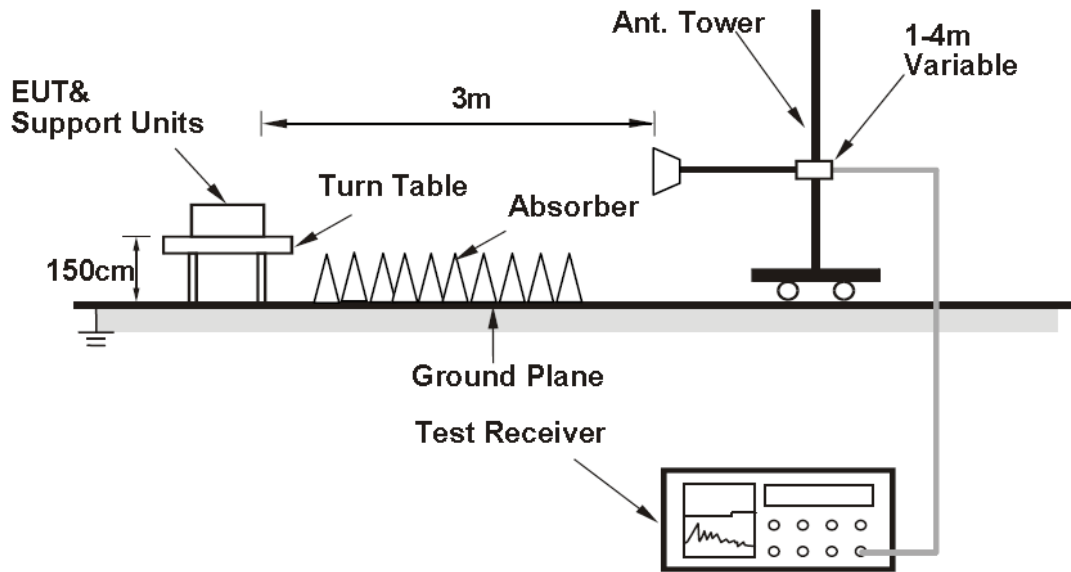

6.8.4 Result:
APPENDIX A – TEST DATA – A.6.

6.9 Conducted Emissions(Section 15.521)

6.9.1 Test Setup with charger:

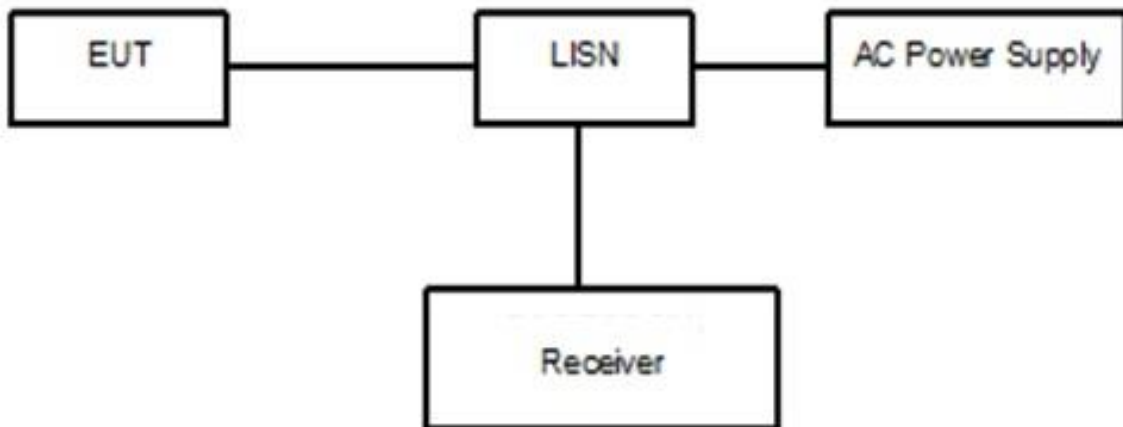

6.9.2 Test Procedure:

The EUT is placed on a non-metallic table 0.8m above the horizontal metal reference ground plane. The EUT is connected with LISN via the charger and Charging dock. The LISN is connected to the reference ground. Open the following functions of EUT: Alarm clock.

The test set-up and the test methods are performed according to ANSI C63.4:2014. Then start the test software EMC32. Sweep the whole frequency band through the range from 150 KHz to 30 MHz with RBW 9kHz, VBW 30kHz. The measurement should be done for both L line and N line. During pre-test, the receiver uses both peak detector and average detector. And the final test, the receiver uses both average detector and Quasi-peak detector.

The data of cable loss has been calibrated in full testing frequency range before the testing.

6.9.3 Limit:

Frequency of Emission(MHz)	Limits(dB μ V)	
	Quasi-peak	Average
0.15~0.5	66 to 56*	56 to 46*
0.5~5	56	46
5~30	60	50

Note: * Decreases with the logarithm of the frequency

6.9.4 Result:

APPENDIX A – TEST DATA – A.7.

7. TEST EQUIPMENTS

No	Name/ Model	Manufacturer	S/N	Cal Due date	Cal date
1.	Spectrum Analyzer FSU	ROHDE&SCHW ARZ	200357	2024.03.19	2023.03.20
2.	12.65m×8.03m×7.50m Fully-Anechoic Chamber	FRANKONIA	----	2023.09.05	2018.09.06
3.	23.18m×16.88m×9.60m Semi-Anechoic Chamber	FRANKONIA	----	2023.09.05	2018.09.06
4.	Turn table Diameter:1m	HD	----	----	----
5.	Turn table Diameter:5m	HD	----	----	----
6.	Antenna master FAC(MA4.0)	MATURO	----	----	----
7.	Antenna master SAC(MA4.0)	MATURO	----	----	----
8.	9.080m×5.255m×3.525m Shielding room	FRANKONIA	----	2023.09.05	2018.09.06
9.	HF 907 Double-Ridged Waveguide Horn Antenna	R&S	100512	2025.05.13	2023.05.12
10.	HF 907 Double-Ridged Waveguide Horn Antenna	R&S	100513	2025.05.13	2023.05.12
11.	VULB 9163 Ultra log test antenna	schwarzbeck	867	2023.05.28	2021.05.29
12.	SAS-574 Horn Antenna	schwarzbeck	535	2023.06.19	2021.06.20
13.	ENV216 AMN	R&S	3560.6550.12	2023.06.19	2022.06.20
14.	ESW EMI test receiver	R&S	101574	2023.06.19	2022.06.20
15.	ESR3EMI test receiver	R&S	102361	2024.03.11	2023.03.12
16.	EMC32EMI test software	R&S	V10.20.10	----	----

APPENDIX A – TEST DATA

A.1 UWB Bandwidth

Test Frequency (MHz)	Test Results (MHz)	Verdict
7987.2	507.7	Pass

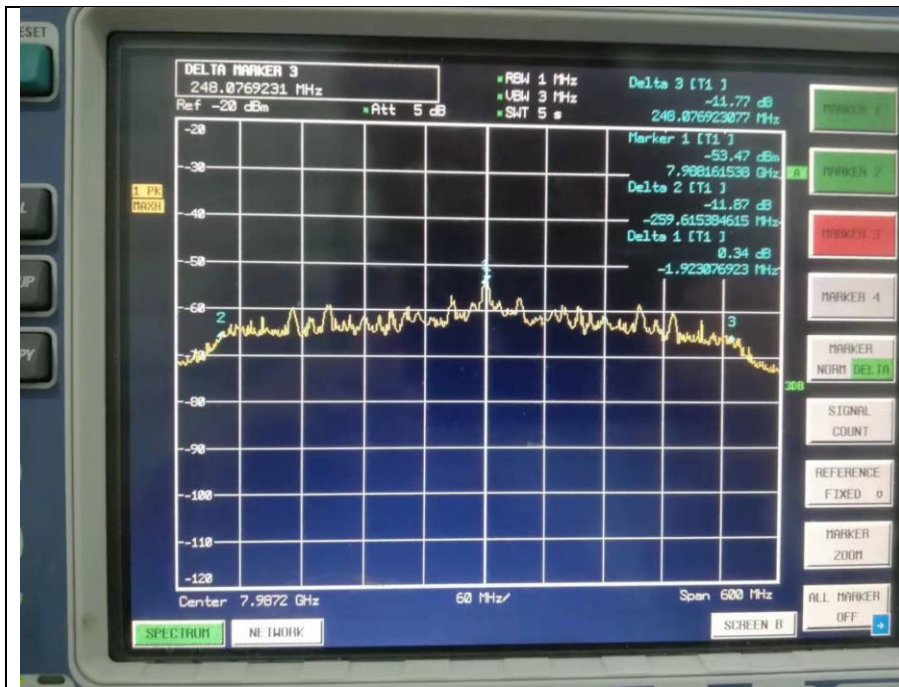

A.2 Average Transmit Power

Frequency (MHz)	Reading Average (dBm)	Measured EIRP (dBm)	Limit (dBm)	Margin (dB)	Polarity	Verdict
7987.2	-60.17	-51.77	-41.30	10.47	V	Pass

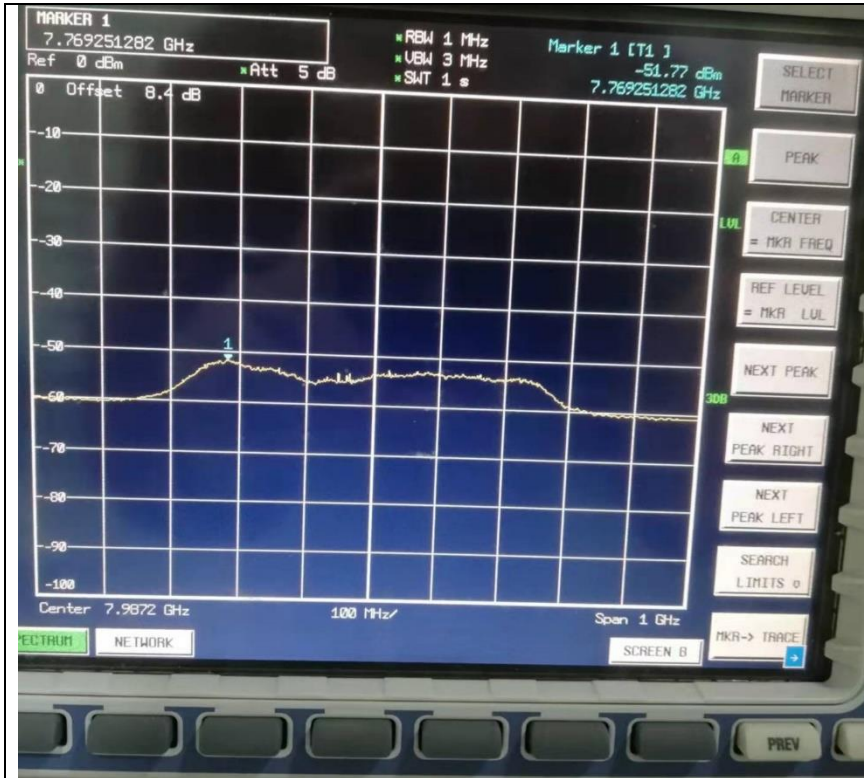

A.3 Peak Power Density

Frequency (MHz)	Reading MaxPeak (dBm)	MaxPeak (dBm)	Limit (dBm)	Margin (dB)	Polarity	Verdict
7987.2	-28.26	-19.86	0	19.86	V	Pass

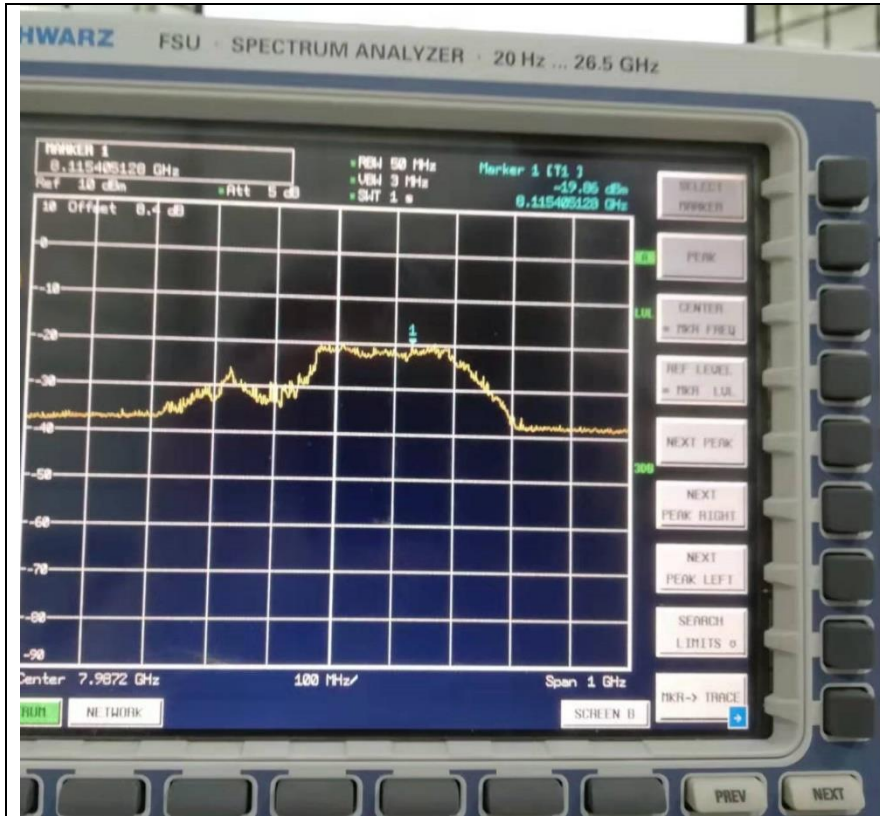

A.4 Spurious Radiated Emissions

Test Frequency (MHz)	Frequency (MHz)	Verdict
7987.2	0.009 – 30	Pass
	30 – 960	Pass
	960 – 1000	Pass
	1000 - 18000	Pass
	18000 - 40000	Pass

Note: There were no emissions below 30 MHz found within 20dB of the limit.

EMC32 Report

Full Spectrum

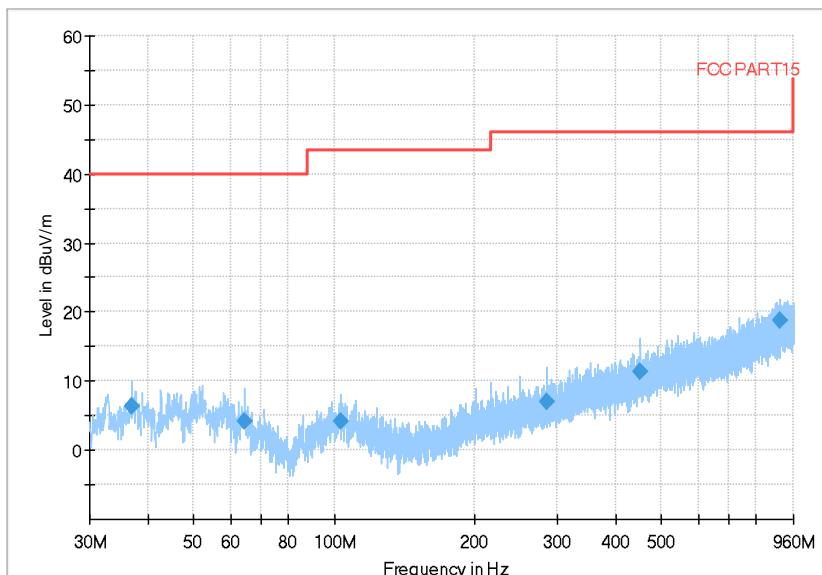

Final_Result

Frequency (MHz)	QuasiPeak (dBμV/m)	MaxPeak (dBμV/m)	Limit (dBμV/m)	Margin (dB)	Meas. Time (ms)	Bandwidth (kHz)	Height (cm)	Pol
36.882000	6.45	---	40.00	33.55	10.0	120.000	100.0	V
64.317000	4.13	---	40.00	35.87	10.0	120.000	100.0	V
103.423500	4.28	---	43.50	39.22	10.0	120.000	100.0	V
284.773500	6.97	---	46.00	39.03	10.0	120.000	100.0	V
452.638500	11.29	---	46.00	34.71	10.0	120.000	100.0	V
895.086000	18.89	---	46.00	27.11	10.0	120.000	100.0	V

30 – 960 MHz

Note: The spectrum from 960MHz to 18GHz is investigated with the EUT set to transmit at the lowest, middle and highest channels with the highest output power. From 30MHz to 960MHz, emissions were performed with the EUT set to transmit at the channel with the highest PSD as worst-case scenario.

EMC32 Report

Full Spectrum

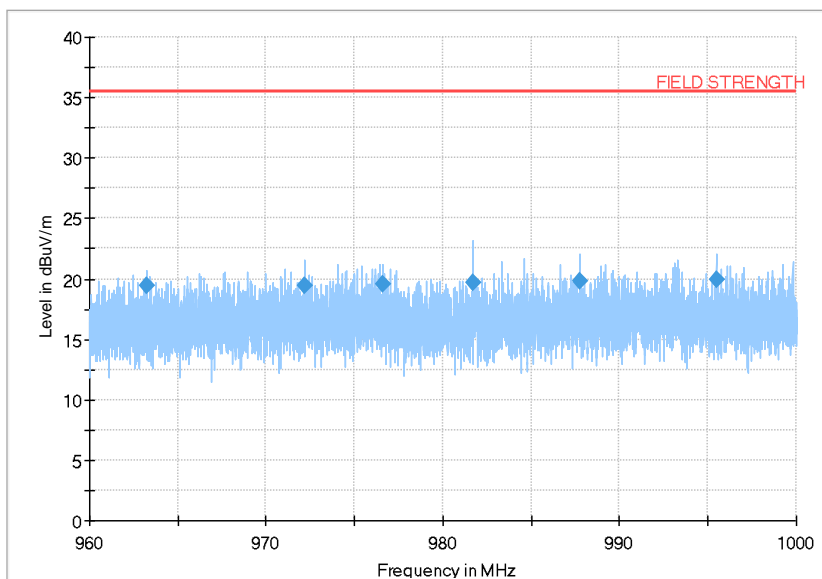

Final_Result

Frequency (MHz)	QuasiPeak (dBμV/m)	MaxPeak (dBμV/m)	Limit (dBμV/m)	Margin (dB)	Meas. Time (ms)	Bandwidth (kHz)	Height (cm)	Pol
963.214000	19.44	---	35.56	16.12	10.0	120.000	100.0	V
972.204000	19.46	---	35.56	16.10	10.0	120.000	100.0	V
976.598000	19.55	---	35.56	16.01	10.0	120.000	100.0	V
981.682000	19.63	---	35.56	15.93	10.0	120.000	100.0	V
987.780000	19.79	---	35.56	15.77	10.0	120.000	100.0	V
995.450000	19.91	---	35.56	15.65	10.0	120.000	100.0	V

960 – 1000 MHz

EMC32 Report

Full Spectrum

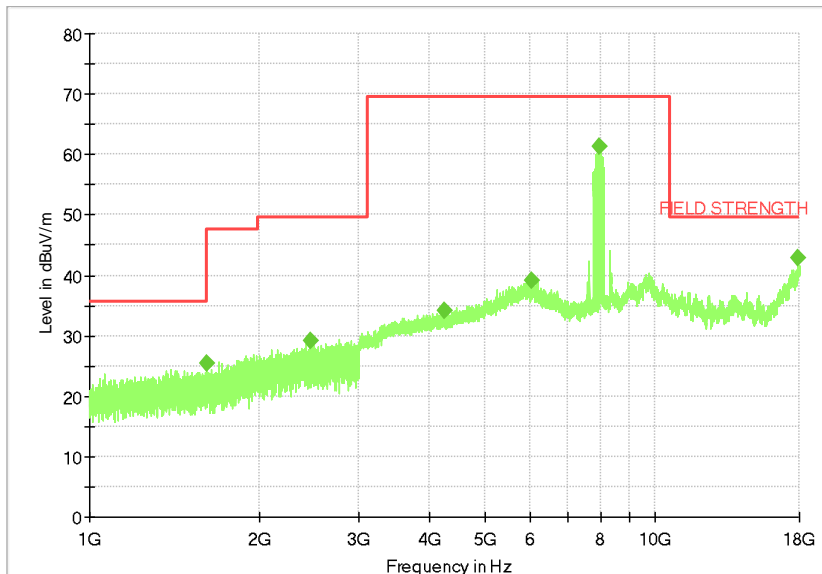

Final_Result

Frequency (MHz)	Average (dBμV/m)	Limit (dBμV/m)	Margin (dB)	Meas. Time (ms)	Bandwidth (kHz)	Height (cm)	Pol	Azimuth (deg)
1610.500000	25.42	35.56	10.14	100.0	1000.000	100.0	V	0.0
2452.000000	28.04	49.56	21.52	100.0	1000.000	100.0	V	0.0
4238.000000	32.09	69.56	37.47	100.0	1000.000	100.0	V	0.0
6070.500000	38.89	69.56	30.67	100.0	1000.000	100.0	V	0.0
7978.000000	61.49	69.56	8.07	100.0	1000.000	100.0	V	0.0
17930.000000	42.43	49.56	7.13	100.0	1000.000	100.0	V	0.0

1 -18 GHz

EMC32 Report

Full Spectrum

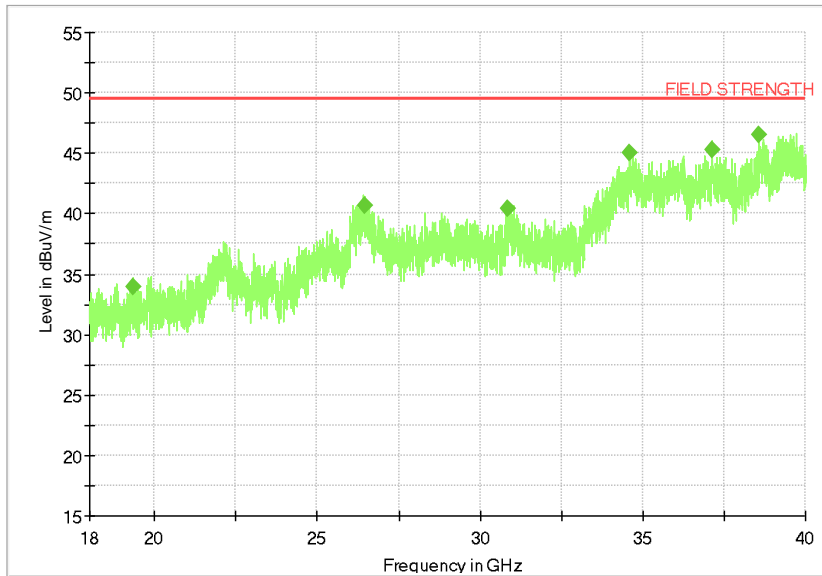

Critical_Freqs

Frequency (MHz)	MaxPeak (dBμV/m)	Average (dBμV/m)	Limit (dBμV/m)	Margin (dB)	Meas. Time (ms)	Bandwidth (kHz)	Height (cm)	Pol
19324.400000	---	33.95	60.00	26.05	100.0	1000.000	100.0	V
26465.600000	---	40.73	60.00	19.27	100.0	1000.000	100.0	V
30861.200000	---	40.47	60.00	19.53	100.0	1000.000	100.0	V
34601.200000	---	45.05	60.00	14.95	100.0	1000.000	100.0	V
37126.800000	---	45.26	60.00	14.74	100.0	1000.000	100.0	V
38556.800000	---	46.57	60.00	13.43	100.0	1000.000	100.0	V

18 -40 GHz

Note: In the event that no emissions are observed in the aforementioned frequency bands, report the minimum sensitivity (noise floor) of the measurement system in these bands (i.e., show that the measurement system is capable of detecting emissions down to the level indicated by the applicable emissions limit)

A.5 Spurious Radiated Emissions in GPS Bands

Test Frequency (MHz)	Frequency (MHz)	Verdict
7987.2	1164 - 1240	Pass
	1559 - 1610	Pass

EMC32 Report

Full Spectrum

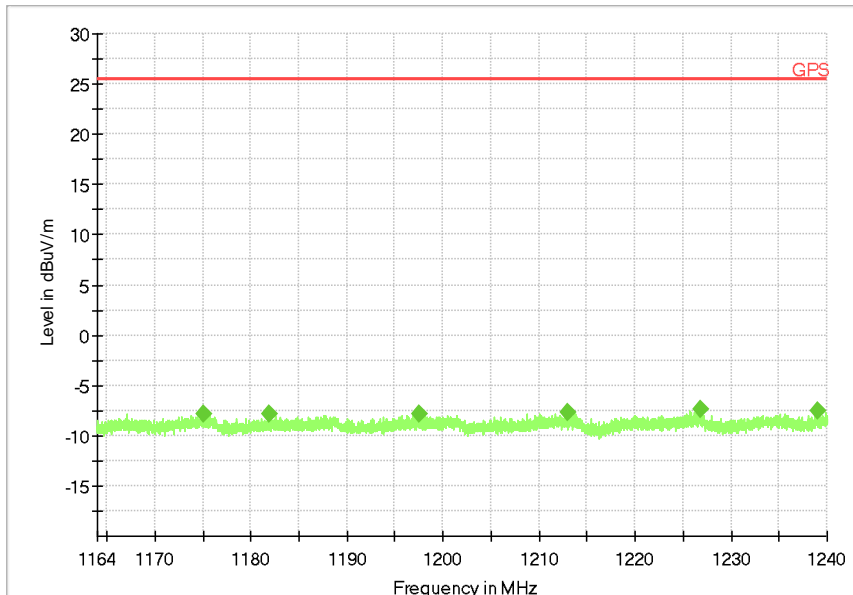

Final Result

Frequency (MHz)	Average (dBuV/m)	Limit (dBuV/m)	Margin (dB)	Meas. Time (ms)	Bandwidth (kHz)	Height (cm)	Pol	Azimuth (deg)
1175.673600	-7.60	25.46	33.06	100.0	1.000	100.0	V	0.0
1186.002000	-7.41	25.46	32.87	100.0	1.000	100.0	V	0.0
1200.328000	-7.88	25.46	33.34	100.0	1.000	100.0	V	0.0
1213.856000	-7.90	25.46	33.36	100.0	1.000	100.0	V	0.0
1226.069200	-7.79	25.46	33.25	100.0	1.000	100.0	V	0.0
1233.973200	-7.71	25.46	33.17	100.0	1.000	100.0	V	0.0

1164 – 1240 MHz

EMC32 Report

Full Spectrum

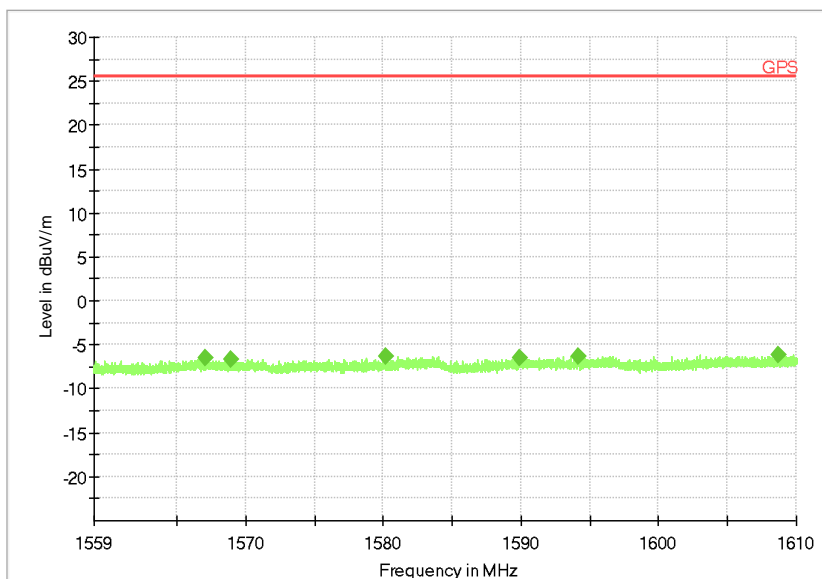

Final_Result

Frequency (MHz)	Average (dBμV/m)	Limit (dBμV/m)	Margin (dB)	Meas. Time (ms)	Bandwidth (kHz)	Height (cm)	Pol	Azimuth (deg)
1580.144600	-6.32	25.46	31.78	100.0	1.000	100.0	V	0.0
1589.880500	-6.43	25.46	31.89	100.0	1.000	100.0	V	0.0
1567.114100	-6.51	25.46	31.97	100.0	1.000	100.0	V	0.0
1568.888900	-6.62	25.46	32.08	100.0	1.000	100.0	V	0.0
1594.144100	-6.29	25.46	31.75	100.0	1.000	100.0	V	0.0
1608.725000	-6.18	25.46	31.64	100.0	1.000	100.0	V	0.0

1559 – 1610 MHz

A.6 Shutdown Timing Requirements

Test Frequency (MHz)	Shutdown Time (s)
7987.2	1.92ms

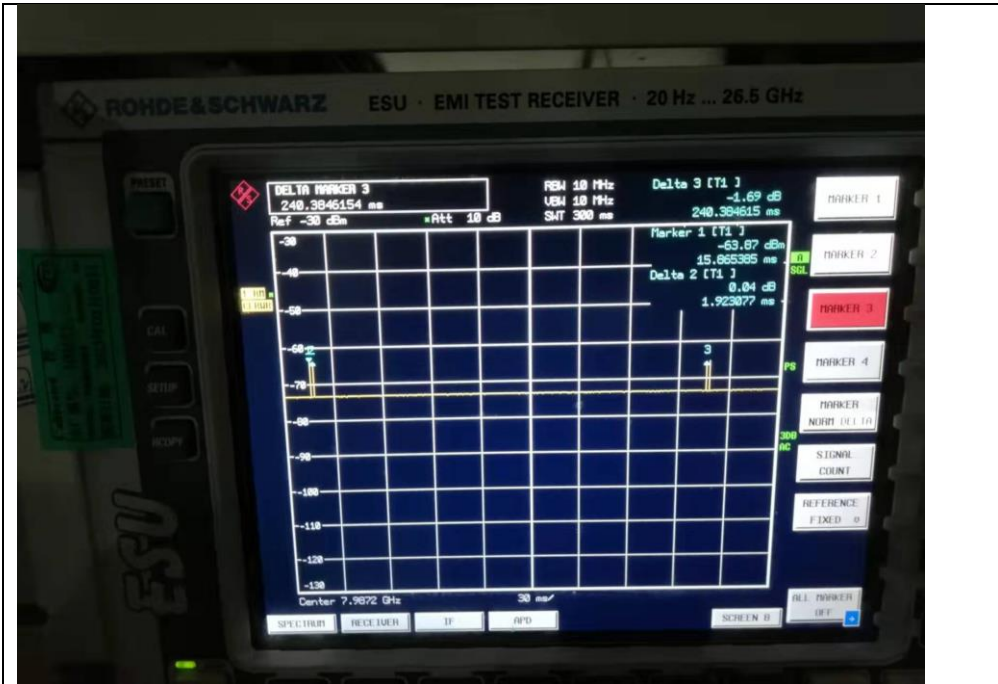

The manufacturer defines that UWB stops transmitting immediately after a connection is not established.

A.7 Conducted emission

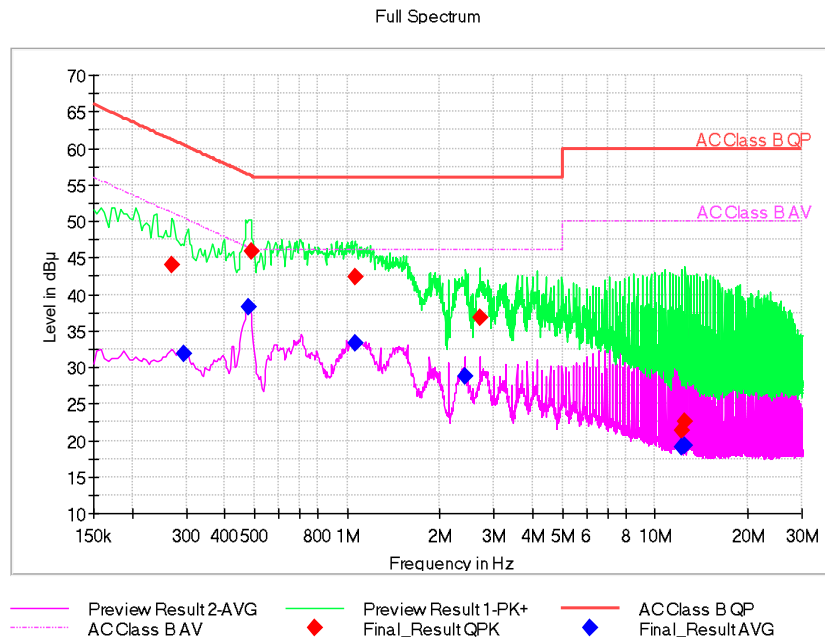

Conducted emission L&N Line Voltage: 120VAC

Frequency (MHz)	QuasiPeak (dBμV)	Average (dBμV)	Limit (dBμV)	Margin (dB)	Line	Corr. (dB)	P _{mea} QuasiPeak (dBμV)	P _{mea} Average (dBμV)
0.269400	43.94	---	61.14	17.20	L1	29.8	14.14	---
0.294986	---	31.77	50.38	18.61	N	29.8	---	1.97
0.478350	---	38.17	46.37	8.20	L1	29.8	---	8.37
0.486879	45.89	---	56.22	10.33	N	29.8	16.09	---
1.058293	42.37	---	56.00	13.63	L1	29.8	12.57	---
1.058293	---	33.39	46.00	12.61	L1	29.8	---	3.59
2.422864	---	28.74	46.00	17.26	N	29.8	---	-1.06
2.704307	36.79	---	56.00	19.21	N	29.9	6.89	---
12.256307	21.42	---	60.00	38.58	N	30	-8.58	---
12.256307	---	18.98	50.00	31.02	N	30	---	-11.02
12.542014	---	19.36	50.00	30.64	N	30	---	-10.64
12.542014	22.50	---	60.00	37.50	N	30	-7.5	---

Full Spectrum

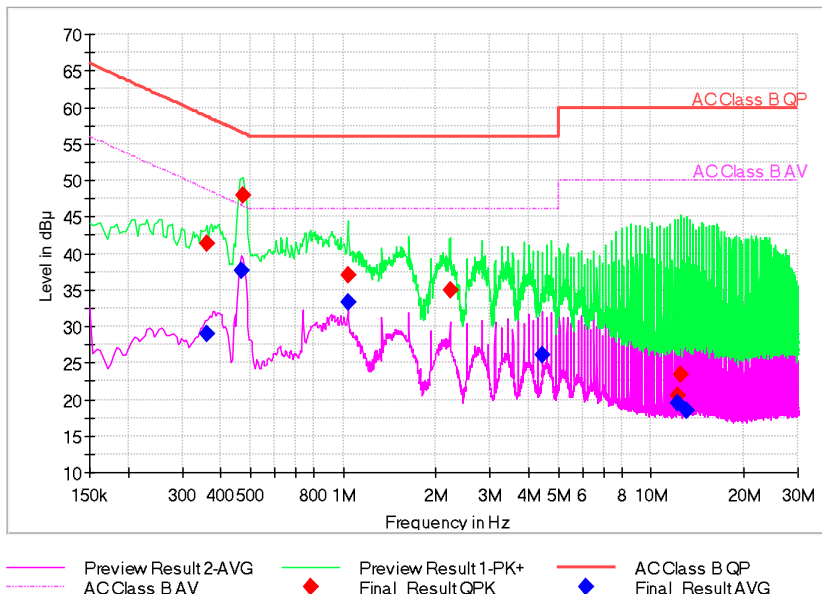

Conducted emission L&N Line Voltage: 240VAC

Frequency (MHz)	QuasiPeak (dBμV)	Average (dBμV)	Limit (dBμV)	Margin (dB)	Line	Corr. (dB)	P _{mea} QuasiPeak (dBμV)	P _{mea} Average (dBμV)
0.35895	---	28.87	48.75	19.88	N	29.8	---	-0.93
0.35895	41.24	---	58.75	17.51	L1	29.8	11.44	---
0.46982	---	37.61	46.52	8.91	N	29.8	---	7.81
0.47409	47.96	---	56.44	8.48	N	29.8	18.16	---
1.03697	---	33.24	46	12.76	N	29.8	---	3.44
1.03697	36.91	---	56	19.09	N	29.8	7.11	---
2.22244	34.89	---	56	21.11	N	29.8	5.09	---
4.4484	---	26.17	46	19.83	N	29.9	---	-3.73
12.1625	20.54	---	60	39.46	N	30	-9.46	---
12.1625	---	19.47	50	30.53	N	30	---	-10.53
12.461	23.42	---	60	36.58	N	30	-6.58	---
13.0537	---	18.36	50	31.64	N	30	---	-11.64

---End of Test Report---