



# TEST REPORT

## CERTIFICATE OF CONFORMITY

**Standards:** 47 CFR FCC Part 15, Subpart B, Class B  
**ANSI C63.4:2014**

**Report No.:** FDBGTL-WTW-P22070227

**FCC ID:** APYHRO00316

**Received Date:** Jul. 08, 2022

**Test Date:** Jul. 20 ~ Jul. 23, 2022

**Issued Date:** Aug. 25, 2022

**Applicant:** SHARP Corporation Mobile Communication BU

**Address:** 2-13-1 Iida Hachihonmatsu Higashi-hiroshima City, Hiroshima 730-0192, Japan

**Manufacturer:** Sharp Corporation

**Address:** 1 Takumi-cho, Sakai-ku, Sakai City, Osaka 590-8522, Japan

**Issued By:** Bureau Veritas Consumer Products Services (H.K.) Ltd., Taoyuan Branch  
Lin Kou Laboratories

**Lab Address:** No. 47-2, 14th Ling, Chia Pau Vil., Lin Kou Dist., New Taipei City, Taiwan

**Test Location:** No. 19, Hwa Ya 2nd Rd., Wen Hwa Vil., Kwei Shan Dist., Taoyuan City  
33383, TAIWAN

**FCC Registration /** 328930 / TW1050

**Designation Number:**

**Approved by :**

  
\_\_\_\_\_  
Ace Wu / Project Engineer

**Date:** Aug. 25, 2022

This test report consists of 29 pages in total. It may be duplicated completely for legal use with the approval of the applicant. It should not be reproduced except in full, without the written approval of our laboratory. The test results in the report only apply to the tested sample. The test results in this report are traceable to the national or international standards.



Prepared by : Vida Chen / Specialist

This report is governed by, and incorporates by reference, the Conditions of Testing as posted at the date of issuance of this report at <http://www.bureauveritas.com/home/about-us/our-business/cps/about-us/terms-conditions/> and is intended for your exclusive use. Any copying or replication of this report to or for any other person or entity, or use of our name or trademark, is permitted only with our prior written permission. This report sets forth our findings solely with respect to the test samples identified herein. The results set forth in this report are not indicative or representative of the quality or characteristics of the lot from which a test sample was taken or any similar or identical product unless specifically and expressly noted. Our report includes all of the tests requested by you and the results thereof based upon the information that you provided to us. Measurement uncertainty is only provided upon request for accredited tests. Statements of conformity are based on simple acceptance criteria without taking measurement uncertainty into account, unless otherwise requested in writing. You have 60 days from date of issuance of this report to notify us of any material error or omission caused by our negligence or if you require measurement uncertainty; provided, however, that such notice shall be in writing and shall specifically address the issue you wish to raise. A failure to raise such issue within the prescribed time shall constitute your unqualified acceptance of the completeness of this report. the tests conducted and the correctness of the report contents.

## Table of Contents

<b>Release Control Record</b> .....	<b>3</b>
<b>1 Certification</b> .....	<b>4</b>
<b>2 Summary of Test Results</b> .....	<b>5</b>
2.1 Measurement Uncertainty .....	5
2.2 Modification Record.....	5
<b>3 General Information</b> .....	<b>6</b>
3.1 Description of EUT .....	6
3.2 Primary Clock Frequencies of Internal Source .....	6
3.3 Features of EUT .....	6
3.4 Operating Modes of EUT and Determination of Worst Case Operating Mode .....	7
3.5 Test Program Used and Operation Descriptions.....	9
3.6 Connection Diagram of EUT and Peripheral Devices.....	10
3.7 Configuration of Peripheral Devices and Cable Connections .....	10
<b>4 Test Instruments</b> .....	<b>11</b>
4.1 Conducted Emissions from Power Ports.....	11
4.2 Radiated Emissions up to 1 GHz .....	12
4.3 Radiated Emissions above 1 GHz .....	13
<b>5 Limits of Test Items</b> .....	<b>14</b>
5.1 Conducted Emissions from Power Ports.....	14
5.2 Radiated Emissions up to 1 GHz .....	14
5.3 Radiated Emissions above 1 GHz .....	14
<b>6 Test Arrangements</b> .....	<b>15</b>
6.1 Conducted Emissions from Power Ports.....	15
6.2 Radiated Emissions up to 1 GHz .....	16
6.3 Radiated Emissions above 1 GHz .....	17
<b>7 Test Results of Emission</b> .....	<b>18</b>
7.1 Conducted Emissions from Power Ports.....	18
7.2 Radiated Emissions up to 1 GHz .....	22
7.3 Radiated Emissions above 1 GHz .....	24
<b>8 Pictures of Test Arrangements</b> .....	<b>28</b>
<b>9 Information of the Testing Laboratories</b> .....	<b>29</b>



### Release Control Record

Issue No.	Description	Date Issued
FDBGTL-WTW-P22070227	Original release.	Aug. 25, 2022

## 1 Certification

**Product:** Smart Phone

**Brand:** SHARP

**FCC ID:** APYHRO00316

**Sample Status:** Engineering sample

**Applicant:** SHARP Corporation Mobile Communication BU

**Test Date:** Jul. 20 ~ Jul. 23, 2022

**Standards:** 47 CFR FCC Part 15, Subpart B, Class B  
ANSI C63.4:2014

The above equipment has been tested by **Bureau Veritas Consumer Products Services (H.K.) Ltd., Taoyuan Branch**, and found compliance with the requirement of the above standards. The test record, data evaluation & Equipment Under Test (EUT) configurations represented herein are true and accurate accounts of the measurements of the sample's EMC characteristics under the conditions specified in this report.

## 2 Summary of Test Results

FCC Part 15 Clause	Test Item	Result/Remarks	Verdict
15.107	Conducted Emissions from Power Ports	Minimum passing Class B margin is -7.77 dB at 0.18519 MHz	Pass
15.109	Radiated Emissions up to 1 GHz	Minimum passing Class B margin is -4.97 dB at 456.19 MHz	Pass
	Radiated Emissions above 1 GHz	Minimum passing Class B margin is -14.62 dB at 5939.57 MHz	Pass

Note: Determining compliance based on the results of the compliance measurement, not taking into account measurement instrumentation uncertainty.

### 2.1 Measurement Uncertainty

Where relevant, the following measurement uncertainty levels have been estimated for tests performed on the EUT:

Measurement	Frequency	Expanded Uncertainty (k=2) ( $\pm$ )
Conducted Emissions at mains ports	150kHz ~ 30MHz	2.79 dB
Radiated Emissions up to 1 GHz	30MHz ~ 1GHz	4.14 dB
Radiated Emissions above 1 GHz	Above 1GHz	5.04 dB

The other instruments specified are routine verified to remain within the calibrated levels, no measurement uncertainty is required to be calculated.

### 2.2 Modification Record

There were no modifications required for compliance.

### 3 General Information

#### 3.1 Description of EUT

Product	Smart Phone
Brand	SHARP
FCC ID	APYHRO00316
Sample Status	Engineering sample
Operating Software	N/A
Power Supply Rating	3.87Vdc (battery) 5Vdc (Adapter)
Accessory Device	Refer to note
Cable Supplied	NA

Note: The EUT contains the following support units.

Product	Brand	Model	Description
Adapter	Salom	XN-2QC25	I/P: 100-240Vac, 50/60Hz, 0.2A O/P: 5.0Vdc, 800mA
Battery	NA	NA	3.87Vdc, Rated 4870mAh (18.9Wh), Typ. 5000mAh (19.4Wh)
Wireless Charge	au	0102PUA	--
USB Cable For Wireless Charge	Maxell Corporation	WP-PD21WH	0.9m shielding cable with one core
Headset	Ambibio	AB-HI02JS	--
USB to Type-C cable	Luxshare-ICT	L6KU2007-CS-H	0.95m shielding cable without core

#### 3.2 Primary Clock Frequencies of Internal Source

The highest frequency generated or used within the EUT or on which the EUT operates or tunes is 5GHz provided by SHARP Corporation Mobile Communication BU, for detailed internal source, please refer to the manufacturer's specifications.

#### 3.3 Features of EUT

The tests reported herein were performed according to the method specified by SHARP Corporation Mobile Communication BU, for detailed feature description, please refer to the manufacturer's specifications or user's manual.

### 3.4 Operating Modes of EUT and Determination of Worst Case Operating Mode

The EUT consumes adapter of rating 100-240Vac, 50/60Hz and battery of rating 3.87Vdc.

For Radiated emission test, the EUT has been pre-tested under following test modes, and test mode 5 was the worst case for final test.

Mode	Test Condition
1	GSM 850 Link + BT Link + WLAN 2.4G Link + GPS Rx + NFC Link + Headset + USB Cable + Adapter, 120Vac/60Hz
2	WCDMA B2 Link + BT Link + WLAN 5G Link + Front Camera REC + NFC Link + Headset + USB Cable + Adapter, 120Vac/60Hz
3	LTE B2 Link + BT Link + WLAN 5G Link + Back Camera REC + NFC Link + Headset + USB Cable + Adapter, 120Vac/60Hz
4	LTE B41 Link + BT Link + WLAN 5G Link + Play REC + NFC Link + Headset + USB Cable + Adapter, 120Vac/60Hz
5	LTE B5 Idle + BT Link + WLAN 5G Link + NFC Link + Headset + USB Cable + NB Link, 120Vac/60Hz
6	LTE B5 Idle + BT Link + WLAN 5G Link + Headset + Qi Wireless Charger, 120Vac/60Hz
7	GSM 850 Rx (Low Channel) + Headset + USB Cable + Adapter, 120Vac/60Hz
8	GSM 850 Rx (Middle Channel) + Headset + USB Cable + Adapter, 120Vac/60Hz
9	GSM 850 Rx (High Channel) + Headset + USB Cable + Adapter, 120Vac/60Hz
10	WCDMA B5 Rx (Low Channel) + Headset + USB Cable + Adapter, 120Vac/60Hz
11	WCDMA B5 Rx (Middle Channel) + Headset + USB Cable + Adapter, 120Vac/60Hz
12	WCDMA B5 Rx (High Channel) + Headset + USB Cable + Adapter, 120Vac/60Hz
13	LTE B5 Rx (Low Channel) + Headset + USB Cable + Adapter, 120Vac/60Hz
14	LTE B5 Rx (Middle Channel) + Headset + USB Cable + Adapter, 120Vac/60Hz
15	LTE B5 Rx (High Channel) + Headset + USB Cable + Adapter, 120Vac/60Hz
16	LTE B12 Rx (Low Channel) + Headset + USB Cable + Adapter, 120Vac/60Hz
17	LTE B12 Rx (Middle Channel) + Headset + USB Cable + Adapter, 120Vac/60Hz
18	LTE B12 Rx (High Channel) + Headset + USB Cable + Adapter, 120Vac/60Hz
19	LTE B13 Rx (Low Channel) + Headset + USB Cable + Adapter, 120Vac/60Hz
20	LTE B13 Rx (Middle Channel) + Headset + USB Cable + Adapter, 120Vac/60Hz
21	LTE B13 Rx (High Channel) + Headset + USB Cable + Adapter, 120Vac/60Hz
22	LTE B17 Rx (Low Channel) + Headset + USB Cable + Adapter, 120Vac/60Hz
23	LTE B17 Rx (Middle Channel) + Headset + USB Cable + Adapter, 120Vac/60Hz
24	LTE B17 Rx (High Channel) + Headset + USB Cable + Adapter, 120Vac/60Hz
25	LTE B5 Idle + BT Link + WLAN 5G Link + NFC Link + Headset + USB Cable + NB Link (X-Axis), 120Vac/60Hz
26	LTE B5 Idle + BT Link + WLAN 5G Link + NFC Link + Headset + USB Cable + NB Link (Y-Axis), 120Vac/60Hz

For Conducted emission test, the EUT has been pre-tested under following test modes, and test mode 25 was the worst case for final test.

Mode	Test Condition
1	GSM 850 Link + BT Link + WLAN 2.4G Link + GPS Rx + NFC Link + Headset + USB Cable + Adapter, 120Vac/60Hz
2	WCDMA B2 Link + BT Link + WLAN 5G Link + Front Camera REC + NFC Link + Headset + USB Cable + Adapter, 120Vac/60Hz
3	LTE B2 Link + BT Link + WLAN 2.4G Link + Back Camera REC + NFC Link + Headset + USB Cable + Adapter, 120Vac/60Hz
4	LTE B41 Link + BT Link + WLAN 2.4G Link + Play REC + NFC Link + Headset + USB Cable + Adapter, 120Vac/60Hz
5	LTE B5 Idle + BT Link + WLAN 2.4G Link + NFC Link + Headset + USB Cable + NB Link, 120Vac/60Hz
6	LTE B5 Idle + BT Link + WLAN 2.4G Link + Headset + Qi Wireless Charger, 120Vac/60Hz
7	GSM 850 Rx (Low Channel) + Headset + USB Cable + Adapter, 120Vac/60Hz
8	GSM 850 Rx (Middle Channel) + Headset + USB Cable + Adapter, 120Vac/60Hz
9	GSM 850 Rx (High Channel) + Headset + USB Cable + Adapter, 120Vac/60Hz
10	WCDMA B5 Rx (Low Channel) + Headset + USB Cable + Adapter, 120Vac/60Hz
11	WCDMA B5 Rx (Middle Channel) + Headset + USB Cable + Adapter, 120Vac/60Hz
12	WCDMA B5 Rx (High Channel) + Headset + USB Cable + Adapter, 120Vac/60Hz
13	LTE B5 Rx (Low Channel) + Headset + USB Cable + Adapter, 120Vac/60Hz
14	LTE B5 Rx (Middle Channel) + Headset + USB Cable + Adapter, 120Vac/60Hz
15	LTE B5 Rx (High Channel) + Headset + USB Cable + Adapter, 120Vac/60Hz
16	LTE B12 Rx (Low Channel) + Headset + USB Cable + Adapter, 120Vac/60Hz
17	LTE B12 Rx (Middle Channel) + Headset + USB Cable + Adapter, 120Vac/60Hz
18	LTE B12 Rx (High Channel) + Headset + USB Cable + Adapter, 120Vac/60Hz
19	LTE B13 Rx (Low Channel) + Headset + USB Cable + Adapter, 120Vac/60Hz
20	LTE B13 Rx (Middle Channel) + Headset + USB Cable + Adapter, 120Vac/60Hz
21	LTE B13 Rx (High Channel) + Headset + USB Cable + Adapter, 120Vac/60Hz
22	LTE B17 Rx (Low Channel) + Headset + USB Cable + Adapter, 120Vac/60Hz
23	LTE B17 Rx (Middle Channel) + Headset + USB Cable + Adapter, 120Vac/60Hz
24	LTE B17 Rx (High Channel) + Headset + USB Cable + Adapter, 120Vac/60Hz
25	LTE B5 Idle + BT Link + WLAN 2.4G Link + NFC Link + Headset + USB Cable + NB Link, 240Vac/60Hz
<p>Note: There are both AC 240V/60Hz and AC 120V/60Hz to be pre-tested then AC 240V/60Hz has the highest emission value.</p>	



Test modes are presented in the report as below.

Mode	Test Condition
Conducted emission test	
Mode 25	LTE B5 Idle + BT Link + WLAN 2.4G Link + NFC Link + Headset + USB Cable + NB Link, 240Vac/60Hz
Radiated emission up to 1GHz test	
Mode 5	LTE B5 Idle + BT Link + WLAN 5G Link + NFC Link + Headset + USB Cable + NB Link, 120Vac/60Hz
Radiated emission above 1GHz test	
Mode 5	LTE B5 Idle + BT Link + WLAN 5G Link + NFC Link + Headset + USB Cable + NB Link, 120Vac/60Hz

### 3.5 Test Program Used and Operation Descriptions

- a. The EUT was powered from Notebook.
- b. The EUT linked with BT earphone via BT function.
- c. The EUT sent audio signal to the Headset.
- d. The NFC function was activated.
- e. The EUT communicated data with Radio Communication Analyzer and AP, which acted as communication partners.

### 3.6 Connection Diagram of EUT and Peripheral Devices

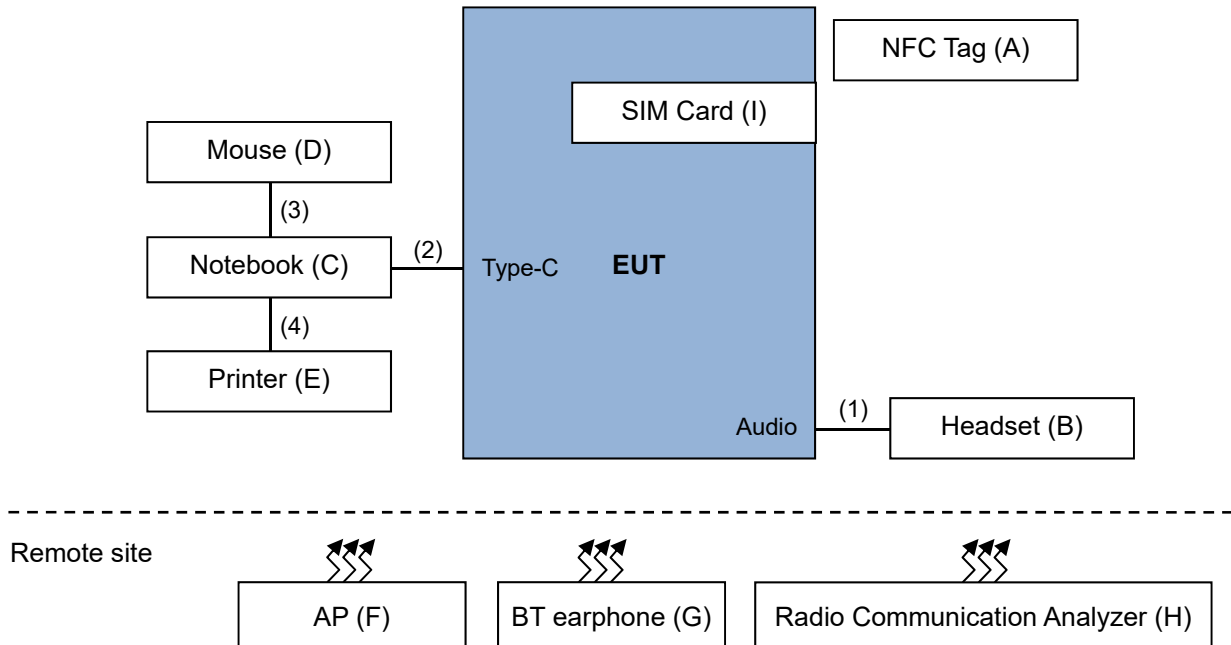

### 3.7 Configuration of Peripheral Devices and Cable Connections

ID	Product	Brand	Model No.	Serial No.	FCC ID	Remarks
A.	NFC Tag	SONY	NA	NA	NA	-
B.	Headset	Ambibio	AB-HI02JS	NA	NA	Provided by client
C.	Notebook	DELL	Latitude 5501	F42VP13	FCC DoC Approved	-
D.	Mouse	DELL	MOCZUL	CN-049TWY-PRC00-79E-02F4	FCC DoC Approved	-
E.	Printer	EPSON	T22	MEEZ070388	FCC DoC Approved	-
F.	AP	D-LINK	DIR-815	PVK21B5000399	KA21R815A1	-
G.	BT earphone	ELECOM	LBT-MPHS400	NA	NA	-
H.	Radio Communication Analyzer	Anritsu	MT8820C	6201010284	NA	-
I.	SIM Card	R&S	NA	NA	NA	-

Note:

1. All power cords of the above support units are non-shielded (1.8m).
2. Items F-H acted as communication partners to transfer data.

ID	Descriptions	Qty.	Length (m)	Shielding (Yes/No)	Cores (Qty.)	Remarks
1.	Audio cable	1	1.14	N	0	Provided by client
2.	USB to Type-C cable	1	0.95	Y	0	Provided by client
3.	USB cable	1	1.8	Y	0	-
4.	USB cable	1	1.8	Y	0	-

## 4 Test Instruments

The calibration interval of the all test instruments are 12 months and the calibrations are traceable to NML/ROC and NIST/USA.

### 4.1 Conducted Emissions from Power Ports

Description & Manufacturer	Model No.	Serial No.	Cal. Date	Cal. Due
Test Receiver ROHDE & SCHWARZ	ESCI	100613	Dec. 03, 2021	Dec. 02, 2022
RF signal cable Woken	5D-FB	Cable-cond1-01	Jan. 15, 2022	Jan. 14, 2023
LISN ROHDE & SCHWARZ (EUT)	ENV216	101826	Mar. 14, 2022	Mar. 13, 2023
LISN ROHDE & SCHWARZ (Peripheral)	ESH3-Z5	100311	Sep. 07, 2021	Sep. 06, 2022
Software ADT	BV ADT_Cond_ V7.3.7.4	NA	NA	NA

- Note: 1. The test was performed in HwaYa Shielded Room 1 (Conduction 1).  
 2. The VCCI Site Registration No. is C-12040.  
 3. Test Date: 2022/7/20

#### 4.2 Radiated Emissions up to 1 GHz

Description & Manufacturer	Model No.	Serial No.	Cal. Date	Cal. Due
Test Receiver ESR3 R&S	ESR3	102412	Jan. 22, 2022	Jan. 21, 2023
Test Receiver ROHDE & SCHWARZ (H)	ESR	101264	Apr. 11, 2022	Apr. 10, 2023
BILOG Antenna SCHWARZBECK (V)	VULB9168	9168-148	Oct. 19, 2021	Oct. 18, 2022
BILOG Antenna SCHWARZBECK (H)	VULB9168	9168-156	Oct. 19, 2021	Oct. 18, 2022
Preamplifier Sonoma (V)	310N	352924	May 14, 2022	May 13, 2023
Preamplifier Sonoma (H)	310N	352923	May 14, 2022	May 13, 2023
RF signal cable (with 5dB PAD) Times (V)	LMR-600 (18M) +LMR-400 (7M)	CABLE-CH1 (VER) -01	Sep. 04, 2021	Sep. 03, 2022
RF signal cable (with 5dB PAD) Times (H)	LMR-600 (11.8M) +LMR-400 (7M)	CABLE-CH1 (HOR) -01	Sep. 04, 2021	Sep. 03, 2022
Software BV ADT	BV ADT_Radiated_ V8.7.08	NA	NA	NA
Antenna Tower (V)	MFA-440	9707	NA	NA
Antenna Tower (H)	MFA-440	970705	NA	NA
Turn Table	DS430	50303	NA	NA
Controller (V)	MF7802	074	NA	NA
Controller (H)	MF7802	08093	NA	NA

- Note: 1. The test was performed in HwaYa Chamber 1.  
 2. The VCCI Site Registration No. is R-11893.  
 3. The test site validated date: 2021/8/07 (NSA).  
 4. Test Date: 2022/7/23

### 4.3 Radiated Emissions above 1 GHz

Description & Manufacturer	Model No.	Serial No.	Cal. Date	Cal. Due
Spectrum Analyzer Agilent	E4446A	MY51100039	Dec. 07, 2021	Dec. 06, 2022
PXA S Analyzer KEYSIGHT	N9030B	MY57141885	Jun. 01, 2022	May 31, 2023
BILOG Antenna SCHWARZBECK	VULB9168	9168-149	Oct. 29, 2021	Oct. 28, 2022
RF signal cable (with 5dB PAD) Times	LMR-400 (18M)	CABLE-CH2-01	May 14, 2022	May 13, 2023
HORN Antenna (with 4dB PAD) SCHWARZBECK	BBHA 9120 D	9120D-405	Nov. 14, 2021	Nov. 13, 2022
Pre-Amplifier Agilent (Above 1GHz)	8449B	3008A01961	Sep. 04, 2021	Sep. 03, 2022
Software BV ADT	BV ADT_Radiated_ V8.7.08	NA	NA	NA
Antenna Tower BV ADT	AT100	AT93021702	NA	NA
Turn Table BV ADT	TT100	TT93021702	NA	NA
Controller BV ADT	SC100	SC93021702	NA	NA
BandPass Filter (2.4G) MICRO-TRONICS	BRM17690-01	003	Sep. 04, 2021	Sep. 03, 2022
BandPass Filter (5G) MICRO-TRONICS	BRM50716-01	G011	Sep. 04, 2021	Sep. 03, 2022
RF Coaxial Cable EMCI	EMC102-KM-KM-1000	170819	Sep. 04, 2021	Sep. 03, 2022
RF Coaxial Cable Rosnol	K1K50-UP0279- K1K50-3000	181129-1	Sep. 04, 2021	Sep. 03, 2022
RF Coaxial Cable JUNFLON+EMC	JUNFLON+EMC104- SM-SM-6000	Cable-CH2- 02(MWX3221308 G003+130710)	Jan. 15, 2022	Jan. 14, 2023
Fix tool for Boresight antenna	BAF-01	2	NA	NA
Pre-amplifier (18GHz-40GHz) EMC	EMC184045B	980175	Sep. 04, 2021	Sep. 03, 2022
HORN Antenna (with 3dB PAD) SCHWARZBECK	BBHA 9170	148	Nov. 14, 2021	Nov. 13, 2022

- Note: 1. The test was performed in HwaYa Chamber 2 (966 Chamber 1).  
 2. The VCCI Site Registration No. is G-10018.  
 3. The test site validated date: 2022/1/8 (VSWR)  
 4. Test Date: 2022/7/22

## 5 Limits of Test Items

### 5.1 Conducted Emissions from Power Ports

Frequency (MHz)	Class A (dBuV)		Class B (dBuV)	
	Quasi-peak	Average	Quasi-peak	Average
0.15 - 0.5	79	66	66 - 56	56 - 46
0.5 - 5.0	73	60	56	46
5.0 - 30.0	73	60	60	50

Notes: 1. The lower limit shall apply at the transition frequencies.  
 2. The limit decreases linearly with the logarithm of the frequency in the range of 0.15 to 0.50 MHz.

### 5.2 Radiated Emissions up to 1 GHz

Radiated Emissions Limits at 10 meters (dB $\mu$ V/m)				
Frequencies (MHz)	FCC Part 15B, Class A	FCC Part 15B, Class B	CISPR 22, Class A	CISPR 22, Class B
30-88	39	29.5	40	30
88-216	43.5	33.1		
216-230	46.4	35.6		
230-960				
960-1000	49.5	43.5	47	37

Radiated Emissions Limits at 3 meters (dB $\mu$ V/m)				
Frequencies (MHz)	FCC Part 15B, Class A	FCC Part 15B, Class B	CISPR 22, Class A	CISPR 22, Class B
30-88	49.5	40	50.5	40.5
88-216	54	43.5		
216-230	56.9	46		
230-960				
960-1000	60	54	57.5	47.5

Notes: 1. The lower limit shall apply at the transition frequencies.

### 5.3 Radiated Emissions above 1 GHz

Frequency Range (For unintentional radiators)

Highest frequency generated or used in the device or on which the device operates or tunes (MHz)	Upper frequency of measurement range (MHz)
Below 1.705	30
1.705-108	1000
108-500	2000
500-1000	5000
Above 1000	5th harmonic of the highest frequency or 40GHz, whichever is lower

Radiated Emissions Limits at 3 meters (dB $\mu$ V/m)		
Frequency range	Class A	Class B
Above 1GHz	Avg: 60 Peak: 80	Avg: 54 Peak: 74

Notes: 1. These limit levels apply for a measurement distance of 3 m. If using a different measurement distance, the measured levels shall be extrapolated to the 3 m limit distance using a factor of 20 dB per decade of distance. The measurement distance shall place the measurement antenna in the far field of the ITE or digital apparatus under test.



## 6.2 Radiated Emissions up to 1 GHz

- For the table-top EUT is placed on a 0.8 meter to the top of rotating table; for the the floor standing EUT shall be insulated (by insulation of 12 mm) from the horizontal reference ground plane. The rotating table is rotated 360 degrees to determine the position of the highest radiation. If the equipment requires a dedicated ground connection, this shall be provided and bonded to the RGP.
- The EUT was set 10 meters away from the interference-receiving antenna, which was mounted on the top of a variable-height antenna tower.
- The antenna is a broadband antenna, and its height is varied from one meter to four meters above the ground to determine the maximum value of the field strength. Both horizontal and vertical polarizations of the antenna are set to make the measurement.
- For each suspected emission, the EUT was arranged to its worst case and then the antenna was tuned to heights from 1 meter to 4 meters and the rotatable table was turned from 0 degrees to 360 degrees to find the maximum reading.
- The test-receiver system was set to quasi-peak detect function and specified bandwidth with maximum hold mode when the test frequency is up to 1 GHz.

Note: The resolution bandwidth and video bandwidth of test receiver/spectrum analyzer is 120kHz for quasi-peak detection (QP) at frequency up to 1GHz.

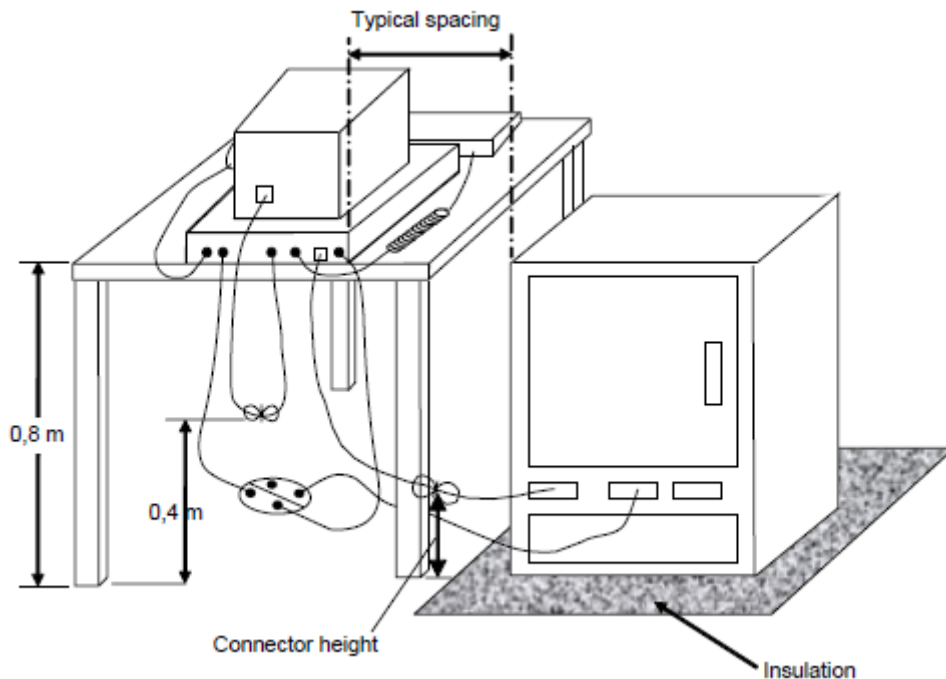

For the actual test configuration, please refer to the related Item – Photographs of the Test Configuration.



### 6.3 Radiated Emissions above 1 GHz

- For the table-top EUT is placed on a 0.8 meter to the top of rotating table; for the the floor standing EUT shall be insulated (by insulation of 12 mm) from the horizontal reference ground plane. The rotating table is rotated 360 degrees to determine the position of the highest radiation. If the equipment requires a dedicated ground connection, this shall be provided and bonded to the RGP.
- The EUT was set  $d = 3$  meters for 1 GHz to 18 GHz and  $d = 1.5$  meters for 18 GHz to 40 GHz away from the interference-receiving antenna, which was mounted on the top of a variable-height antenna tower.
- The height of antenna can be varied from one meter to four meters, the height of adjustment depends on the EUT height and the antenna 3dB beamwidth both, to detect the maximum value of the field strength. Both horizontal and vertical polarizations of the antenna are set to make the measurement.
- For each suspected emission, the EUT was arranged to its worst case and then the antenna was tuned to heights and the rotatable table was turned from 0 degrees to 360 degrees to find the maximum reading.
- The spectrum analyzer system was set to peak and average detects function and specified bandwidth with maximum hold mode when the test frequency is above 1 GHz.

Note: The resolution bandwidth of test receiver/spectrum analyzer is 1MHz and video bandwidth is 3MHz for Peak detection (PK) at frequency above 1GHz. The resolution bandwidth of test receiver/spectrum analyzer is 1 MHz for Average detection (AV) at frequency above 1GHz.

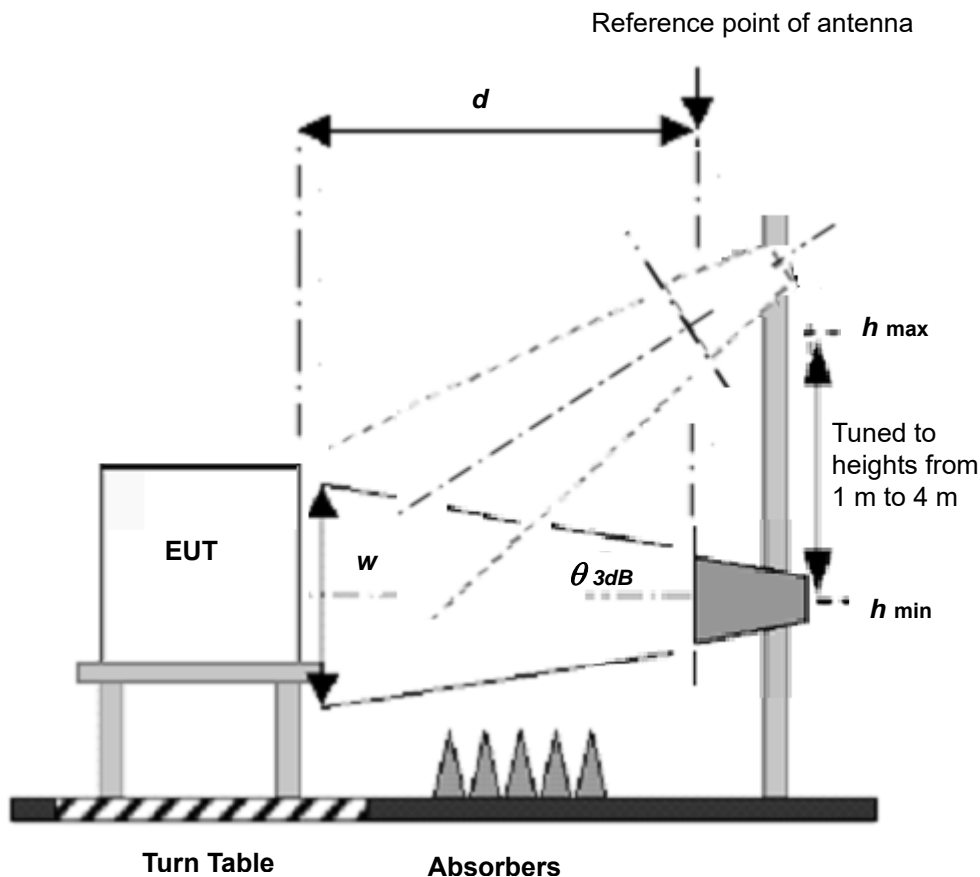

For the actual test configuration, please refer to the related item – Photographs of the Test Configuration.

## 7 Test Results of Emission

### 7.1 Conducted Emissions from Power Ports

Frequency Range	150 kHz ~ 30 MHz	Detector Function & Resolution Bandwidth	Quasi-Peak (QP) / Average (AV), 9kHz
Input Power	240 Vac, 60 Hz	Environmental Conditions	24°C, 76% RH
Tested by	Jim Lee		

Phase Of Power : Line (L)										
No	Frequency (MHz)	Correction Factor (dB)	Reading Value (dBuV)		Emission Level (dBuV)		Limit (dBuV)		Margin (dB)	
			Q.P.	AV.	Q.P.	AV.	Q.P.	AV.	Q.P.	AV.
1	0.15800	9.62	40.91	11.13	50.53	20.75	65.57	55.57	-15.04	-34.82
2	0.18519	9.63	46.20	33.05	55.83	42.68	64.25	54.25	-8.42	-11.57
3	0.24200	9.65	40.80	30.04	50.45	39.69	62.03	52.03	-11.58	-12.34
4	0.29800	9.66	37.77	23.31	47.43	32.97	60.30	50.30	-12.87	-17.33
5	0.37000	9.68	35.22	26.09	44.90	35.77	58.50	48.50	-13.60	-12.73
6	0.49400	9.69	32.60	24.43	42.29	34.12	56.10	46.10	-13.81	-11.98
7	1.67800	9.71	25.88	16.66	35.59	26.37	56.00	46.00	-20.41	-19.63
8	2.58200	9.73	26.90	14.13	36.63	23.86	56.00	46.00	-19.37	-22.14
9	4.20600	9.75	26.80	21.05	36.55	30.80	56.00	46.00	-19.45	-15.20
+10X	13.56000	9.83	41.33	41.08	51.16	50.91	-	-	-	-

Remarks:

1. Q.P. and AV. are abbreviations of quasi-peak and average individually.
2. The emission levels of other frequencies were very low against the limit.
3. Margin value = Emission level – Limit value
4. Correction factor = Insertion loss + Cable loss
5. Emission Level = Correction Factor + Reading Value
6. No. 10 is NFC signal inductive with measurement system. Please see test result for EUT with a suitable dummy load.

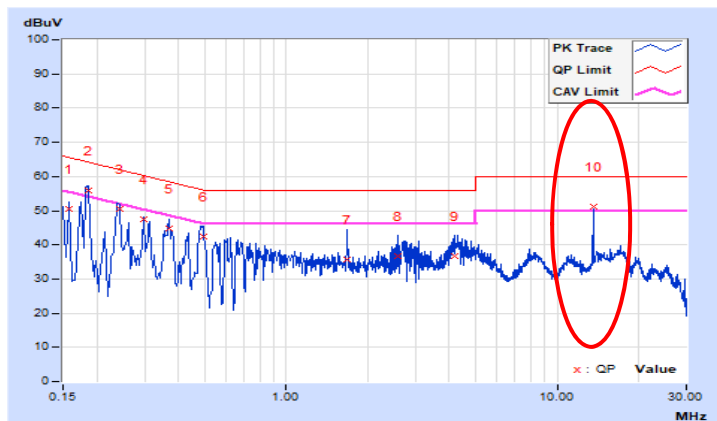

Frequency Range	150 kHz ~ 30 MHz	Detector Function & Resolution Bandwidth	Quasi-Peak (QP) / Average (AV), 9kHz
Input Power	240 Vac, 60 Hz	Environmental Conditions	24°C, 76% RH
Tested by	Jim Lee		

Phase Of Power : Neutral (N)										
No	Frequency (MHz)	Correction Factor (dB)	Reading Value (dBuV)		Emission Level (dBuV)		Limit (dBuV)		Margin (dB)	
			Q.P.	AV.	Q.P.	AV.	Q.P.	AV.	Q.P.	AV.
1	0.15000	9.62	41.81	15.75	51.43	25.37	66.00	56.00	-14.57	-30.63
<b>2</b>	<b>0.18519</b>	<b>9.63</b>	<b>46.85</b>	<b>33.57</b>	<b>56.48</b>	<b>43.20</b>	<b>64.25</b>	<b>54.25</b>	<b>-7.77</b>	<b>-11.05</b>
3	0.23800	9.65	40.26	23.68	49.91	33.33	62.17	52.17	-12.26	-18.84
4	0.31400	9.67	36.61	20.41	46.28	30.08	59.86	49.86	-13.58	-19.78
5	0.37000	9.68	34.54	20.82	44.22	30.50	58.50	48.50	-14.28	-18.00
6	0.43800	9.69	33.94	20.71	43.63	30.40	57.10	47.10	-13.47	-16.70
7	0.53800	9.69	31.03	19.00	40.72	28.69	56.00	46.00	-15.28	-17.31
8	4.47400	9.75	27.76	21.40	37.51	31.15	56.00	46.00	-18.49	-14.85
9	13.56000	9.85	31.96	30.91	41.81	40.76	60.00	50.00	-18.19	-9.24

Remarks:

1. Q.P. and AV. are abbreviations of quasi-peak and average individually.
2. The emission levels of other frequencies were very low against the limit.
3. Margin value = Emission level – Limit value
4. Correction factor = Insertion loss + Cable loss
5. Emission Level = Correction Factor + Reading Value

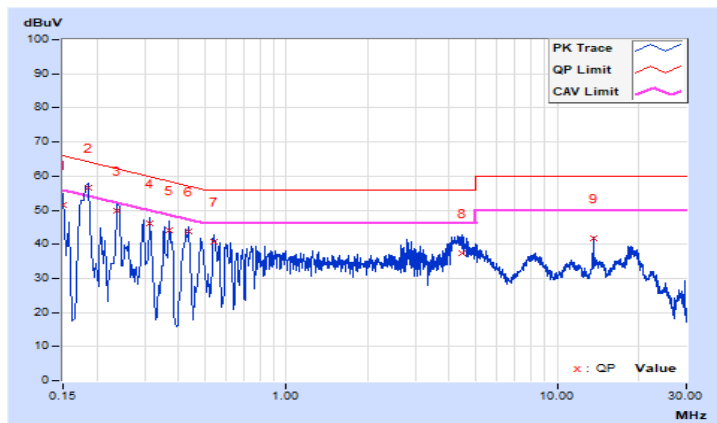

Test with Suitable Dummy Load

Frequency Range	150 kHz ~ 30 MHz	Detector Function & Resolution Bandwidth	Quasi-Peak (QP) / Average (AV), 9kHz
Input Power	240 Vac, 60 Hz	Environmental Conditions	24°C, 76% RH
Tested by	Jim Lee		

Phase Of Power : Line (L)										
No	Frequency (MHz)	Correction Factor (dB)	Reading Value (dBuV)		Emission Level (dBuV)		Limit (dBuV)		Margin (dB)	
			Q.P.	AV.	Q.P.	AV.	Q.P.	AV.	Q.P.	AV.
1	0.17800	9.63	46.13	30.57	55.76	40.20	64.58	54.58	-8.82	-14.38
2	0.20200	9.64	36.77	14.67	46.41	24.31	63.53	53.53	-17.12	-29.22
3	0.25000	9.65	42.29	27.31	51.94	36.96	61.76	51.76	-9.82	-14.80
4	0.29800	9.66	39.00	24.46	48.66	34.12	60.30	50.30	-11.64	-16.18
5	0.36600	9.68	36.66	25.53	46.34	35.21	58.59	48.59	-12.25	-13.38
6	0.42200	9.69	32.11	24.63	41.80	34.32	57.41	47.41	-15.61	-13.09
7	4.87000	9.76	29.72	20.29	39.48	30.05	56.00	46.00	-16.52	-15.95
8	13.56000	9.83	21.86	16.08	31.69	25.91	60.00	50.00	-28.31	-24.09

Remarks:

1. Q.P. and AV. are abbreviations of quasi-peak and average individually.
2. The emission levels of other frequencies were very low against the limit.
3. Margin value = Emission level – Limit value
4. Correction factor = Insertion loss + Cable loss
5. Emission Level = Correction Factor + Reading Value

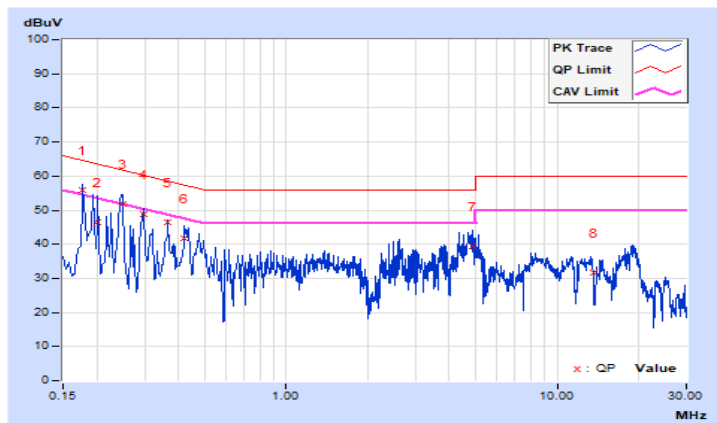

Frequency Range	150 kHz ~ 30 MHz	Detector Function & Resolution Bandwidth	Quasi-Peak (QP) / Average (AV), 9kHz
Input Power	240 Vac, 60 Hz	Environmental Conditions	24°C, 76% RH
Tested by	Jim Lee		

Phase Of Power : Neutral (N)										
No	Frequency (MHz)	Correction Factor (dB)	Reading Value (dBuV)		Emission Level (dBuV)		Limit (dBuV)		Margin (dB)	
			Q.P.	AV.	Q.P.	AV.	Q.P.	AV.	Q.P.	AV.
1	0.15000	9.62	42.17	21.44	51.79	31.06	66.00	56.00	-14.21	-24.94
2	0.16405	9.63	40.68	18.63	50.31	28.26	65.26	55.26	-14.95	-27.00
3	0.18519	9.63	45.33	34.55	54.96	44.18	64.25	54.25	-9.29	-10.07
4	0.25400	9.65	37.48	22.82	47.13	32.47	61.63	51.63	-14.50	-19.16
5	0.30600	9.67	37.79	26.75	47.46	36.42	60.08	50.08	-12.62	-13.66
6	0.37400	9.68	36.82	25.76	46.50	35.44	58.41	48.41	-11.91	-12.97
7	0.49000	9.69	33.49	25.55	43.18	35.24	56.17	46.17	-12.99	-10.93
8	4.63800	9.76	28.29	21.64	38.05	31.40	56.00	46.00	-17.95	-14.60
9	13.56000	9.85	24.26	18.00	34.11	27.85	60.00	50.00	-25.89	-22.15

Remarks:

1. Q.P. and AV. are abbreviations of quasi-peak and average individually.
2. The emission levels of other frequencies were very low against the limit.
3. Margin value = Emission level – Limit value
4. Correction factor = Insertion loss + Cable loss
5. Emission Level = Correction Factor + Reading Value

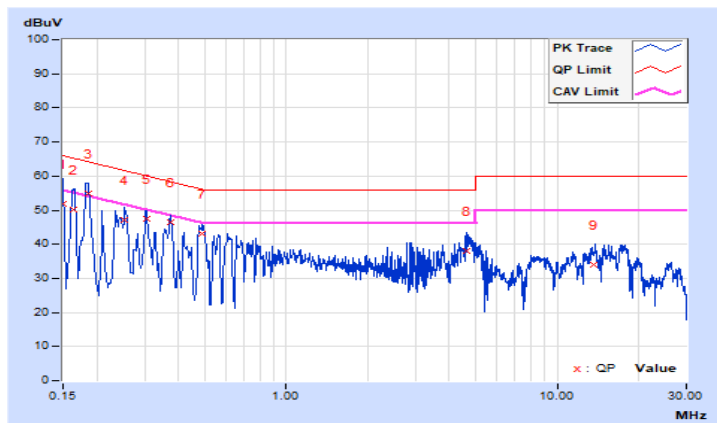

## 7.2 Radiated Emissions up to 1 GHz

Frequency Range	30 MHz ~ 1 GHz	Detector Function & Resolution Bandwidth	Quasi-Peak (QP), 120 kHz
Tested By	Rolan Zheng	Environmental Conditions	21°C, 65% RH

Antenna Polarity & Test Distance : Horizontal at 10 m								
No	Frequency (MHz)	Emission Level (dBuV/m)	Limit (dBuV/m)	Margin (dB)	Antenna Height (m)	Table Angle (Degree)	Raw Value (dBuV)	Correction Factor (dB/m)
1	51.15	17.23 QP	30.00	-12.77	1.50 H	134	29.98	-12.75
2	166.10	24.20 QP	30.00	-5.80	4.00 H	281	37.70	-13.50
3	219.35	23.23 QP	30.00	-6.77	4.00 H	318	39.22	-15.99
4	231.24	25.24 QP	37.00	-11.76	4.00 H	324	40.99	-15.75
5	268.73	22.59 QP	37.00	-14.41	3.00 H	222	35.97	-13.38
6	456.14	23.52 QP	37.00	-13.48	2.00 H	122	31.93	-8.41
7	773.59	26.44 QP	37.00	-10.56	3.00 H	317	28.40	-1.96

### Remarks:

1. Emission Level(dBuV/m) = Raw Value(dBuV) + Correction Factor(dB/m)
2. Correction Factor(dB/m) = Antenna Factor (dB/m) + Cable Factor (dB) – Pre-Amplifier Factor (dB)
3. The other emission levels were very low against the limit.
4. Margin value = Emission level – Limit value

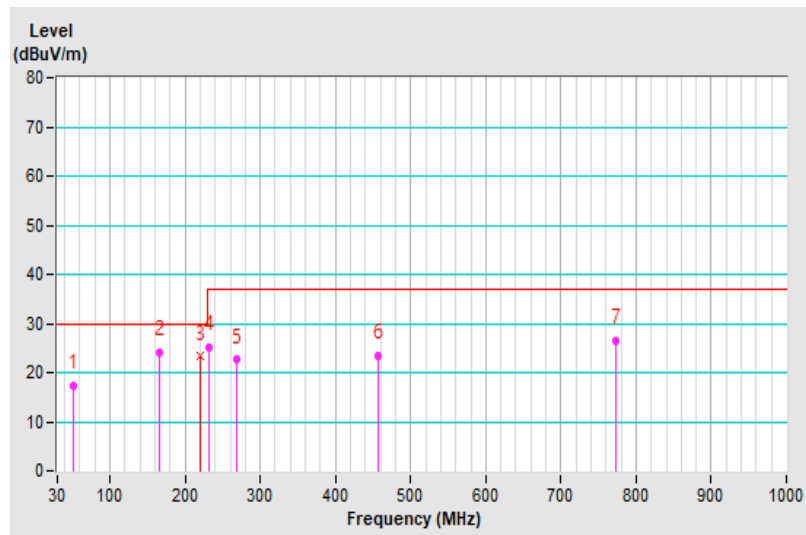

Frequency Range	30 MHz ~ 1 GHz	Detector Function & Resolution Bandwidth	Quasi-Peak (QP), 120 kHz
Tested By	Rolan Zheng	Environmental Conditions	21°C, 65% RH

Antenna Polarity & Test Distance : Vertical at 10 m								
No	Frequency (MHz)	Emission Level (dBuV/m)	Limit (dBuV/m)	Margin (dB)	Antenna Height (m)	Table Angle (Degree)	Raw Value (dBuV)	Correction Factor (dB/m)
1	48.72	22.14 QP	30.00	-7.86	1.00 V	168	35.28	-13.14
2	105.95	23.75 QP	30.00	-6.25	2.50 V	81	41.03	-17.28
3	131.90	24.95 QP	30.00	-5.05	2.00 V	200	39.90	-14.95
4	164.01	24.33 QP	30.00	-5.67	1.00 V	149	37.66	-13.33
5	197.24	23.66 QP	30.00	-6.34	1.50 V	124	39.62	-15.96
6	232.59	23.02 QP	37.00	-13.98	1.00 V	130	38.46	-15.44
<b>7</b>	<b>456.19</b>	<b>32.03 QP</b>	<b>37.00</b>	<b>-4.97</b>	<b>3.50 V</b>	<b>300</b>	<b>39.90</b>	<b>-7.87</b>

Remarks:

1. Emission Level(dBuV/m) = Raw Value(dBuV) + Correction Factor(dB/m)
2. Correction Factor(dB/m) = Antenna Factor (dB/m) + Cable Factor (dB) – Pre-Amplifier Factor (dB)
3. The other emission levels were very low against the limit.
4. Margin value = Emission level – Limit value

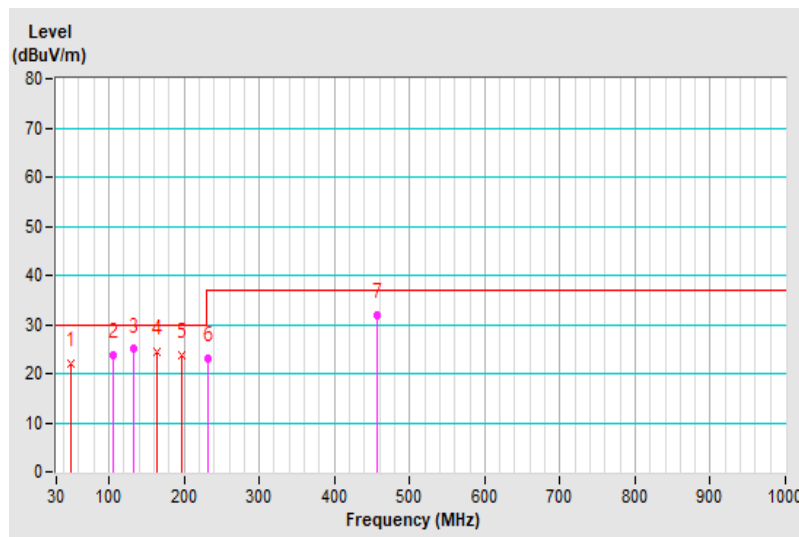

### 7.3 Radiated Emissions above 1 GHz

Frequency Range	1GHz ~ 18GHz	Detector Function & Resolution Bandwidth	Peak (PK) / Average (AV), 1MHz
Tested By	Fox Chang	Environmental Conditions	23°C, 63% RH

Antenna Polarity & Test Distance : Horizontal at 3 m								
No	Frequency (MHz)	Emission Level (dBuV/m)	Limit (dBuV/m)	Margin (dB)	Antenna Height (m)	Table Angle (Degree)	Raw Value (dBuV)	Correction Factor (dB/m)
1	2857.53	46.80 PK	74.00	-27.20	1.28 H	149	41.88	4.92
2	2857.53	34.37 AV	54.00	-19.63	1.28 H	149	29.45	4.92
3	4592.60	49.85 PK	74.00	-24.15	1.00 H	311	40.50	9.35
4	4592.60	36.85 AV	54.00	-17.15	1.00 H	311	27.50	9.35
5	5939.57	50.71 PK	74.00	-23.29	1.40 H	120	37.67	13.04
<b>6</b>	<b>5939.57</b>	<b>39.38 AV</b>	<b>54.00</b>	<b>-14.62</b>	<b>1.40 H</b>	<b>120</b>	<b>26.34</b>	<b>13.04</b>

Remarks:

1. Emission Level(dBuV/m) = Raw Value(dBuV) + Correction Factor(dB/m)
2. Correction Factor(dB/m) = Antenna Factor (dB/m) + Cable Factor (dB) – Pre-Amplifier Factor (dB)
3. The other emission levels were very low against the limit.
4. Margin value = Emission level – Limit value

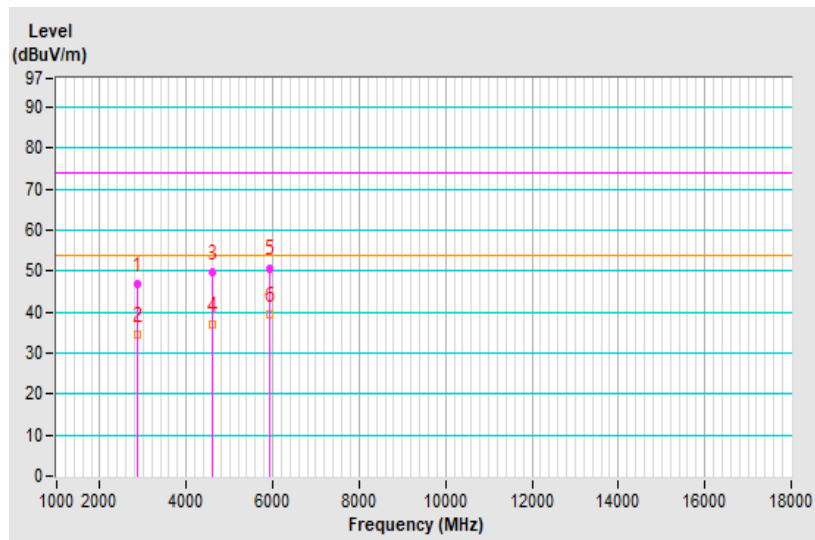



Frequency Range	1GHz ~ 18GHz	Detector Function & Resolution Bandwidth	Peak (PK) / Average (AV), 1MHz
Tested By	Fox Chang	Environmental Conditions	23°C, 63% RH

Antenna Polarity & Test Distance : Vertical at 3 m								
No	Frequency (MHz)	Emission Level (dBuV/m)	Limit (dBuV/m)	Margin (dB)	Antenna Height (m)	Table Angle (Degree)	Raw Value (dBuV)	Correction Factor (dB/m)
1	2220.36	44.68 PK	74.00	-29.32	1.35 V	263	40.74	3.94
2	2220.36	33.34 AV	54.00	-20.66	1.35 V	263	29.40	3.94
3	2975.83	46.57 PK	74.00	-27.43	1.00 V	348	41.54	5.03
4	2975.83	34.08 AV	54.00	-19.92	1.00 V	348	29.05	5.03
5	4098.64	48.64 PK	74.00	-25.36	1.20 V	42	40.70	7.94
6	4098.64	36.15 AV	54.00	-17.85	1.20 V	42	28.21	7.94

Remarks:

1. Emission Level(dBuV/m) = Raw Value(dBuV) + Correction Factor(dB/m)
2. Correction Factor(dB/m) = Antenna Factor (dB/m) + Cable Factor (dB) – Pre-Amplifier Factor (dB)
3. The other emission levels were very low against the limit.
4. Margin value = Emission level – Limit value

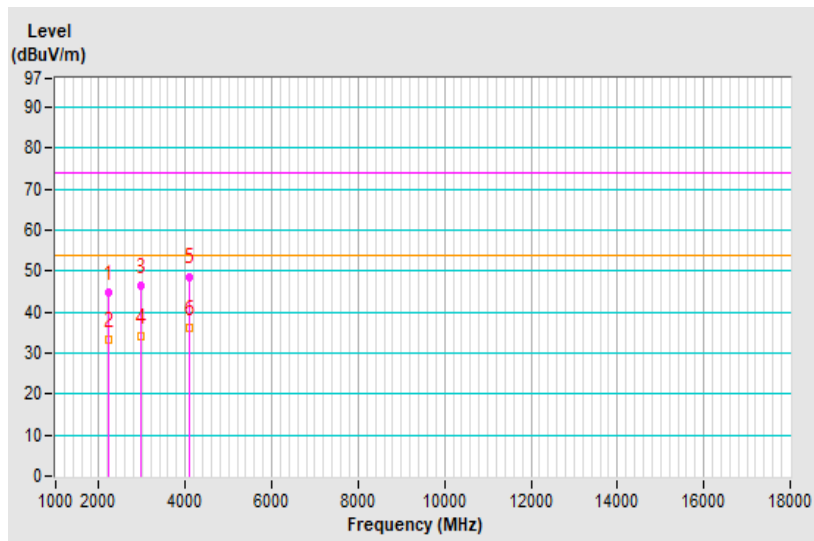

Frequency Range	18GHz ~ 30GHz	Detector Function & Resolution Bandwidth	Peak (PK) / Average (AV), 1MHz
Tested By	Fox Chang	Environmental Conditions	23°C, 63% RH

Antenna Polarity & Test Distance : Horizontal at 1.5 m								
No	Frequency (MHz)	Emission Level (dBuV/m)	Limit (dBuV/m)	Margin (dB)	Antenna Height (m)	Table Angle (Degree)	Raw Value (dBuV)	Correction Factor (dB/m)
1	24320.62	57.15 PK	80.00	-22.85	1.00 H	74	53.66	3.49
2	24320.62	38.69 AV	60.00	-21.31	1.00 H	74	35.20	3.49

Remarks:

1. Emission Level(dBuV/m) = Raw Value(dBuV) + Correction Factor(dB/m)
2. Correction Factor(dB/m) = Antenna Factor (dB/m) + Cable Factor (dB) – Pre-Amplifier Factor (dB)
3. The other emission levels were very low against the limit.
4. Margin value = Emission level – Limit value

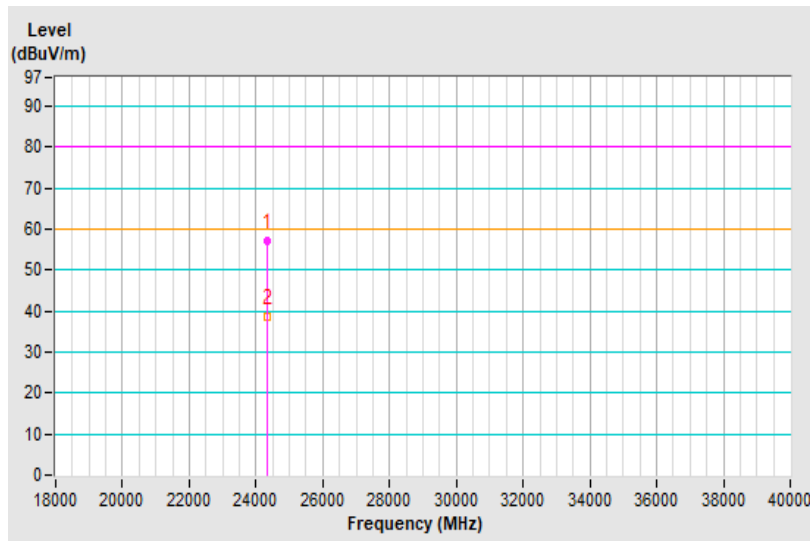

Frequency Range	18GHz ~ 30GHz	Detector Function & Resolution Bandwidth	Peak (PK) / Average (AV), 1MHz
Tested By	Fox Chang	Environmental Conditions	23°C, 63% RH

Antenna Polarity & Test Distance : Vertical at 1.5 m								
No	Frequency (MHz)	Emission Level (dBuV/m)	Limit (dBuV/m)	Margin (dB)	Antenna Height (m)	Table Angle (Degree)	Raw Value (dBuV)	Correction Factor (dB/m)
1	24312.83	56.00 PK	80.00	-24.00	1.00 V	181	52.49	3.51
2	24312.83	37.81 AV	60.00	-22.19	1.00 V	181	34.30	3.51

Remarks:

1. Emission Level(dBuV/m) = Raw Value(dBuV) + Correction Factor(dB/m)
2. Correction Factor(dB/m) = Antenna Factor (dB/m) + Cable Factor (dB) – Pre-Amplifier Factor (dB)
3. The other emission levels were very low against the limit.
4. Margin value = Emission level – Limit value

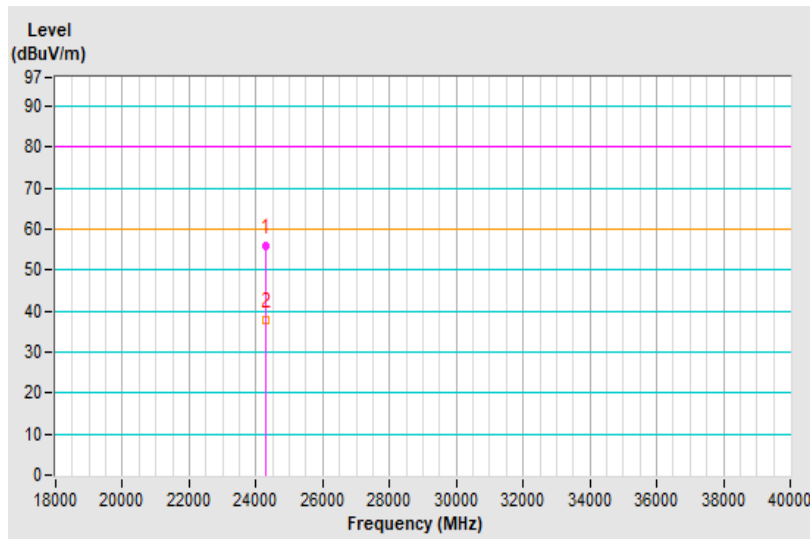

## 8 Pictures of Test Arrangements

Please refer to the attached file (Test Setup Photo).



## 9 Information of the Testing Laboratories

We, Bureau Veritas Consumer Products Services (H.K.) Ltd., Taoyuan Branch, were founded in 1988 to provide our best service in EMC, Radio, Telecom and Safety consultation. Our laboratories are accredited and approved according to ISO/IEC 17025.

If you have any comments, please feel free to contact us at the following:

**Lin Kou EMC/RF Lab**

Tel: 886-2-26052180

Fax: 886-2-26051924

**Hsin Chu EMC/RF/Telecom Lab**

Tel: 886-3-6668565

Fax: 886-3-6668323

**Hwa Ya EMC/RF/Safety Lab**

Tel: 886-3-3183232

Fax: 886-3-3270892

**Email:** [service.adt@tw.bureauveritas.com](mailto:service.adt@tw.bureauveritas.com)

**Web Site:** [www.bureauveritas-adt.com](http://www.bureauveritas-adt.com)

The address and road map of all our labs can be found in our web site also.

--- END ---