

# TEST REPORT

---

Report No.: SRTC2021-9003(F)-0044  
Product Name: Mobile phone  
Applicant: Sharp Corporation  
Manufacturer: Sharp Corporation  
Specification: FCC Part15B (Certification)  
(2020 edition)  
ANSI C63.4-2014  
FCC ID: APYHRO00301

The State Radio\_monitoring\_center Testing Center (SRTC)  
15th Building, No.30 Shixing Street, Shijingshan District,  
Beijing, China

Tel: 86-10-57996183 Fax: 86-10-57996388

---

## CONTENTS

1. General information .....	3
1.1 Notes of the test report.....	3
1.2 Information about the testing laboratory .....	3
1.3 Applicant's details.....	3
1.4 Manufacturer's details .....	3
1.5 Application details.....	3
1.6 Reference specification .....	4
1.7 Information of EUT .....	4
1.7.1 General information .....	4
1.7.2 EUT details.....	5
1.7.3 Auxiliary equipment details.....	5
2. Test information .....	7
2.1 Summary of the test results.....	7
2.2 Test result .....	8
2.2.1 Conducted Emissions-FCC Part15.107.....	8
2.2.2 Radiated Emissions-FCC Part15.109.....	16
2.3. List of test equipments .....	27

## 1. General information

### 1.1 Notes of the test report

The test report may only be reproduced or published in full. Reproduction or publication of extracts from the report requires the prior written permission of The State Radio\_monitoring\_center Testing Center (SRTC).

The test results relate only to individual items of the samples which have been tested.

### 1.2 Information about the testing laboratory

Company: The State Radio\_monitoring\_center Testing Center (SRTC)  
Address: 15th Building, No.30 Shixing Street, Shijingshan District  
Testing location: No.80, Zhaojiachang, BeizangCun, Daxing District, Beijing, China.  
City: Beijing  
Country or Region: China  
Contacted person: Liu Jia  
Tel: +86 10 57996183  
Fax: +86 10 57996388  
Email: liujiaf@srtc.org.cn

### 1.3 Applicant's details

Company: Sharp Corporation  
Address: 1 Takumi-cho, Sakai-ku, Sakai City,Osaka 590-8522,Japan  
City: Osaka  
Country or Region: Japan  
Contacted person: Mr.Masaaki Nishikawa  
Tel: +81-50-5433-4157  
Email: ---

### 1.4 Manufacturer's details

Company: Sharp Corporation  
Address: 1 Takumi-cho, Sakai-ku, Sakai City,Osaka 590-8522,Japan  
City: Osaka  
Country or Region: Japan  
Contacted person: Mr.Masaaki Nishikawa  
Tel: +81-50-5433-4157  
Email: ---

### 1.5 Application details

Date of reception of test sample: 26<sup>th</sup> August 2021

Date of test: 26<sup>th</sup> August 2021 to 18<sup>th</sup> September 2021

## 1.6 Reference specification

FCC Part 15B, 2020 (Certification)

## 1.7 Information of EUT

### 1.7.1 General information

Product Name of EUT	Mobile phone
FCC ID	APYHRO00301
Frequency Range	GSM: GSM850 / DCS1900 WCDMA: FDD II / FDD V LTE: FDD 2/ FDD 5/FDD 12 / FDD 17/TDD 38/ TDD 41 Bluetooth: 2.4~2.4835GHz WiFi: 2.4~2.4835GHz 5.15-5.35GHz/5.475-5.725GHz 5.725GHz-5.85GHz NFC: 13.56MHz
Power Supply	Charger/Battery
Nominal Voltage	4V
Extreme Temperature	Lowest: -10°C Highest: +55°C
Extreme Voltage	Minimum: 3.7V Maximum: 4V
HW Version	DVT(Remodeled to the equivalent of MP products)
SW Version	A8060

### 1.7.2 EUT details

No.	Product Name	IMEI
EUT1	Mobile phone	1#:004401230471035/004401230481034 2#: 004401230471217/004401230481216 3#: 004401230474708

Note1: As the applicant of this model, [Sharp Corporation] declares that the product has three the suppliers of memory / two the suppliers of NFC.

Main Supply: 1#: 004401230471035/004401230481034

Part Name	Model Name	supplier
memory	/	Sumsung
NFC	SN110P	/

Secondary Supply: 2#:004401230471217/004401230481216

Part Name	Model Name	supplier
memory	/	SK Hynix
NFC	SN100F	/

Third Supply: 3#: 004401230474708

Part Name	Model Name	supplier
memory	/	Micron
NFC	SN110P	/

### 1.7.3 Auxiliary equipment details

AE (Auxiliary Equipment) 1#: Charger

Manufacturer	DVE
Model Number	DSA-10PF06-05 FUS
Input Voltage	100V-240V AC
Output Voltage	5V DC

AE (Auxiliary Equipment) 2#: Battery

Manufacturer	Amperex Tchchnology Limited
Model Number	UBATIA305AFN2

AE (Auxiliary Equipment) 3#: USB cable

Manufacturer	Kingpower
Model Number	K201-05130-00

---

AE (Auxiliary Equipment) 4#: Headset



Manufacturer	Panasonic
Model Number	RP-HJS150-K

Note1: In this report, the result exercised by the EUT1, EUT2 and EUT3, charger AE1, the Battery AE2 , the USB cable AE3 and the Headset AE4.

## 2. Test information

### 2.1 Summary of the test results

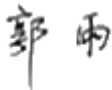
No.	Test case	FCC reference	Verdict
1	Conducted emissions	15.107	Pass
2	Radiated emissions	15.109	Pass

Approved By: Mr. Liu Wei Director of the test department  	Checked By: Mr. Guo Yu Vice director of the test department  
Tested by: Mr. Lv Youyou Test engineer  	Issued date:  2021.09.23

## 2.2 Test result

### 2.2.1 Conducted Emissions-FCC Part15.107

Ambient condition:

Temperature	Relative humidity	Pressure
23.4°C	40.5%	100.9kPa

Test Setup with charger:

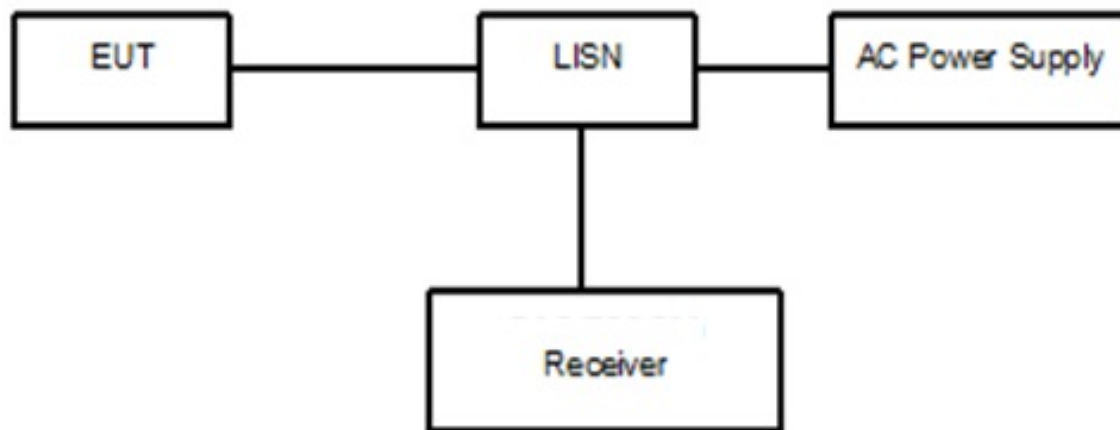

Figure 1

Test Procedure:

The EUT is placed on a non-metallic table 0.8m above the horizontal metal reference ground plane. The EUT is connected with LISN via the charger. The LISN is connected to the reference ground.

The test set-up and the test methods are performed according to ANSI C63.4:2014.

Then start the test software EMC32. Sweep the whole frequency band through the range from 150 KHz to 30 MHz with RBW 9kHz, VBW 30kHz. The measurement should be done for both L line and N line. During pre-test, the receiver uses both peak detector and average detector. And the final test, the receiver uses both average detector and Quasi-peak detector.

The data of cable loss has been calibrated in full testing frequency range before the testing.



Test Setup with laptop:

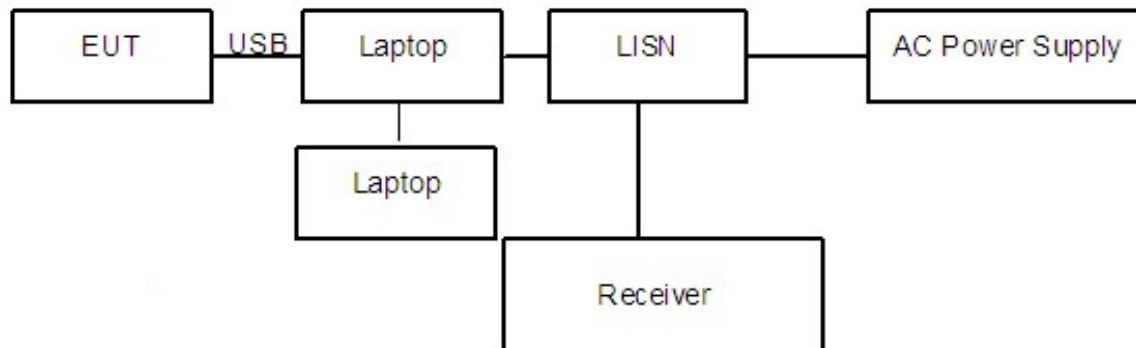

Figure 2

Test Procedure:

The EUT is placed on a non-metallic table 0.8m above the horizontal metal reference ground plane. The accessories of the EUT are connected with the EUT such as headset etc. The EUT was connected with a laptop via the USB cable and was charged. The laptop's LAN port is connected with another laptop via cable. And the data transferring between two laptops is maintained.

The AC main power supply of the laptop is connected to LISN and LISN is connected to the reference ground. The test set-up and the test methods are performed according to ANSI C63.4:2014.

Then start the test software EMC32. Sweep the whole frequency band through the range from 150 KHz to 30 MHz. The measurement should be done for both L line and N line. During pre-test, the receiver uses both peak detector and average detector. And the final test, the receiver uses both average detector and Quasi-peak detector.

The data of cable loss has been calibrated in full testing frequency range before the testing.

A “reference path loss” Corr.(dB) is established and the  $L_{cable+ATT+VDF}$  is the attenuation of “reference path loss”, and including the cable loss, the attenuation of the attenuator, the voltage division factor of AMN.

The measurement results are obtained as described below:

$$P_{result} = P_{mea} + Corr.(dB)$$

Sample calculation:  $(23.31dB\mu V) = (-6.39 dB\mu V) + (29.7 dB)$ , the corresponding frequency is 0.162793MHz.

Limit:

Frequency of Emission(MHz)	Limits(dB $\mu$ V)	
	Quasi-peak	Average
0.15~0.5	66 to 56*	56 to 46*
0.5~5	56	46
5~30	60	50

Note: \* Decreases with the logarithm of the frequency

Test result:

Noise Level of the Measuring Instrument

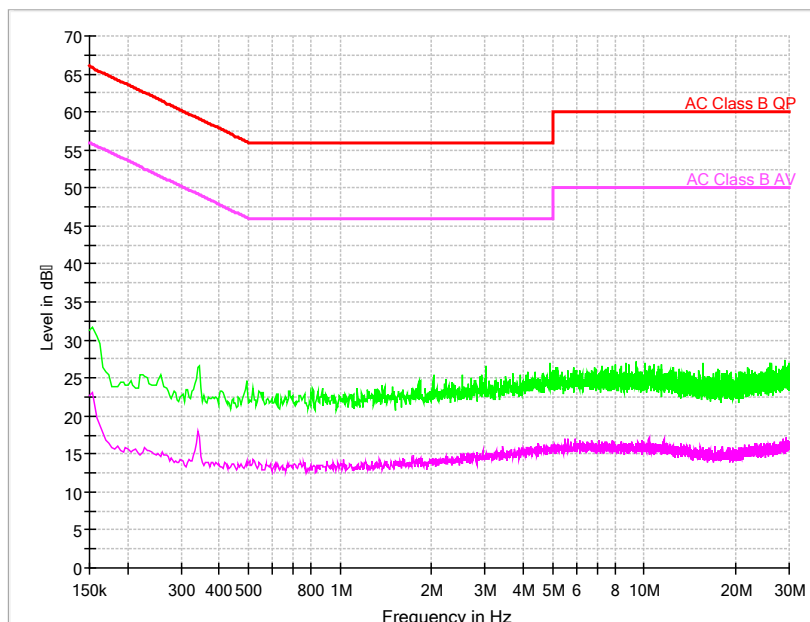

Pic1. Conducted emission L and N Line

EUT1+charger:

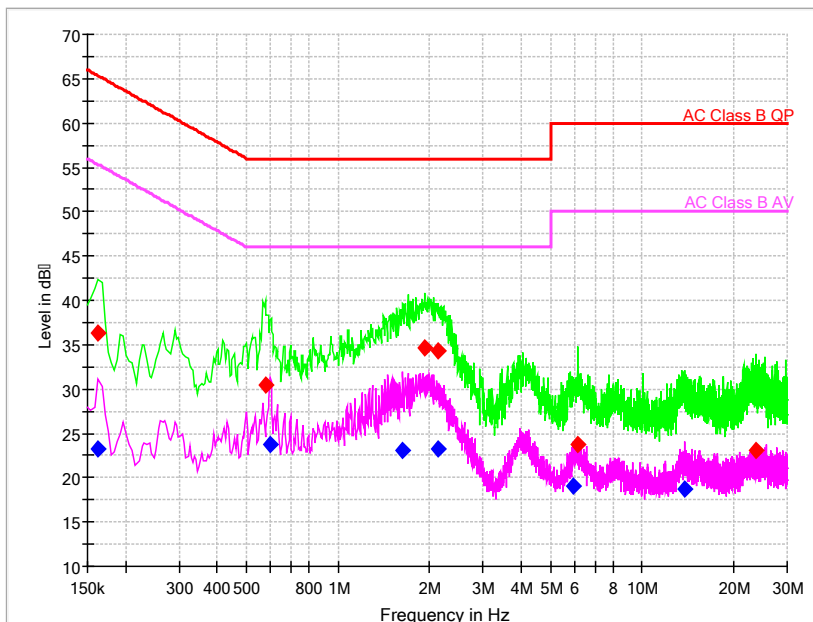

Pic2. Conducted emission L&N Line Voltage: 120VAC

Frequency (MHz)	QuasiPeak (dBμV)	Average (dBμV)	Limit (dBμV)	Margin (dB)	Line	Corr. (dB)	P <sub>mea</sub> QuasiPeak (dBμV)	P <sub>mea</sub> Average (dBμV)
0.162793	---	23.31	55.32	32.01	L1	29.7	---	-6.39
0.162793	36.39	---	65.32	28.93	L1	29.7	6.69	---
0.576429	30.53	---	56.00	25.47	L1	29.7	0.83	---
0.597750	---	23.75	46.00	22.25	L1	29.7	---	-5.95
1.629707	---	23.00	46.00	23.00	L1	29.8	---	-6.8
1.923943	34.63	---	56.00	21.37	N	29.8	4.83	---
2.128629	34.25	---	56.00	21.75	L1	29.8	4.45	---
2.137157	---	23.31	46.00	22.69	L1	29.8	---	-6.49
5.945164	---	19.10	50.00	30.90	L1	29.8	---	-10.7
6.115736	23.67	---	60.00	36.34	L1	29.8	-6.13	---
13.753071	---	18.78	50.00	31.22	L1	30.0	---	-11.22
23.765614	23.08	---	60.00	36.92	L1	30.5	-7.42	---

EUT1+charger:

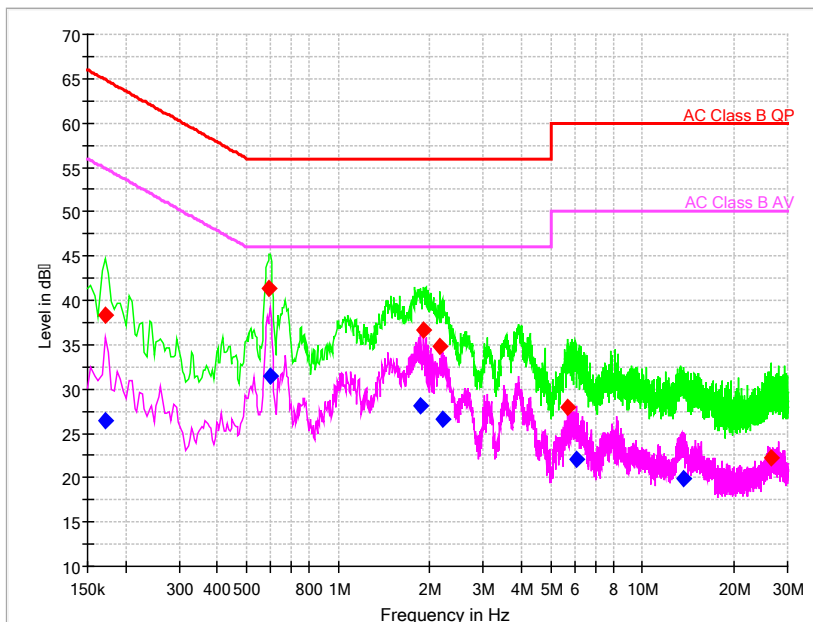

Pic3. Conducted emission L&N Line Voltage: 240VAC

Frequency (MHz)	QuasiPeak (dBμV)	Average (dBμV)	Limit (dBμV)	Margin (dB)	Line	Corr. (dB)	P <sub>mea</sub> QuasiPeak (dBμV)	P <sub>mea</sub> Average (dBμV)
0.171321	---	26.48	54.90	28.42	L1	29.7	---	-3.22
0.171321	38.37	---	64.90	26.53	L1	29.7	8.67	---
0.593486	41.26	---	56.00	14.74	L1	29.7	11.56	---
0.597750	---	31.38	46.00	14.62	L1	29.7	---	1.68
1.868507	---	28.14	46.00	17.86	L1	29.8	---	-1.66
1.902621	36.66	---	56.00	19.34	L1	29.8	6.86	---
2.162743	34.73	---	56.00	21.27	L1	29.8	4.93	---
2.201121	---	26.59	46.00	19.41	N	29.8	---	-3.21
5.685043	27.91	---	60.00	32.09	L1	29.8	-1.89	---
6.085886	---	22.00	50.00	28.00	L1	29.8	---	-7.8
13.625143	---	19.81	50.00	30.19	L1	30.0	---	-10.19
26.477700	22.20	---	60.00	37.80	L1	30.5	-8.3	---

EUT2+charger:

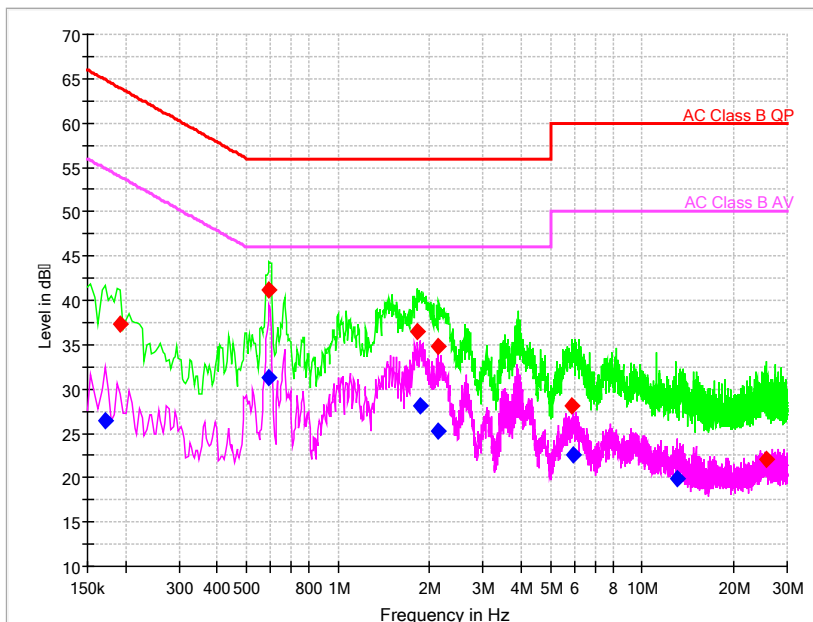

Pic4. Conducted emission L&N Line Voltage: 240VAC

Frequency (MHz)	QuasiPeak (dB $\mu$ V)	Average (dB $\mu$ V)	Limit (dB $\mu$ V)	Margin (dB)	Line	Corr. (dB)	P <sub>mea</sub> QuasiPeak (dB $\mu$ V)	P <sub>mea</sub> Average (dB $\mu$ V)
0.171321	---	26.40	54.90	28.50	L1	29.7	---	-3.3
0.192643	37.35	---	63.92	26.57	N	29.7	7.65	---
0.593486	---	31.24	46.00	14.76	L1	29.7	---	1.54
0.593486	41.10	---	56.00	14.90	L1	29.7	11.4	---
1.825864	36.54	---	56.00	19.46	L1	29.8	6.74	---
1.859979	---	28.08	46.00	17.92	L1	29.8	---	-1.72
2.137157	---	25.19	46.00	20.81	L1	29.8	---	-4.61
2.141421	34.84	---	56.00	21.16	L1	29.8	5.04	---
5.847086	28.02	---	60.00	31.98	L1	29.8	-1.78	---
5.962221	---	22.57	50.00	27.43	L1	29.8	---	-7.23
13.079314	---	19.86	50.00	30.14	L1	30.0	---	-10.14
25.684543	22.10	---	60.00	37.90	L1	30.5	-8.4	---

EUT1+Laptop:

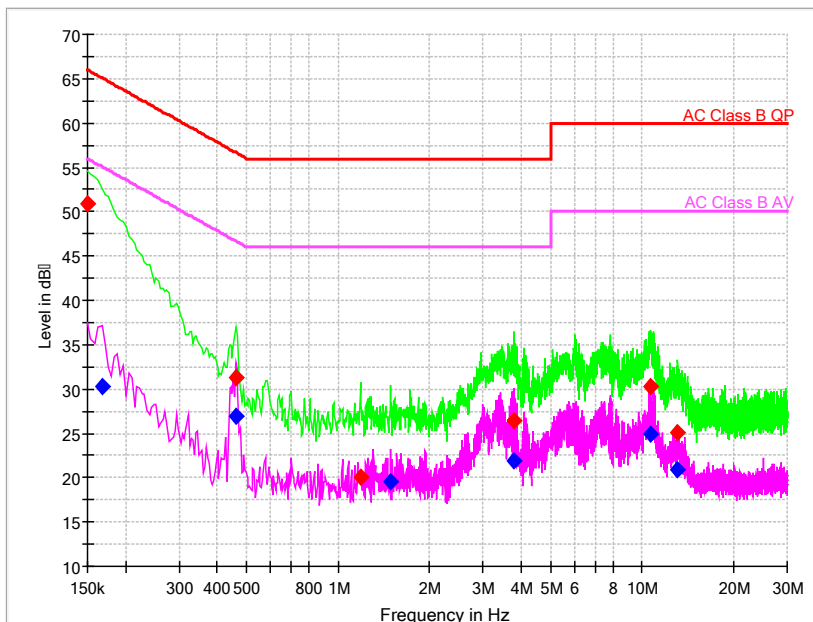

Pic5. Conducted emission L&N Line

Frequency (MHz)	QuasiPeak (dBμV)	Average (dBμV)	Limit (dBμV)	Margin (dB)	Line	Corr. (dB)	Pme a Quas	Pme a Aver
0.150000	50.86	---	66.00	15.14	L1	29.7	21.1	---
0.167057	---	30.30	55.11	24.81	L1	29.7	---	0.6
0.461293	---	26.95	46.67	19.71	L1	29.7	---	-2.75
0.461293	31.24	---	56.67	25.43	L1	29.7	1.54	---
1.186221	20.05	---	56.00	35.95	L1	29.8	-9.75	---
1.484721	---	19.57	46.00	26.44	L1	29.8	---	-10.2
3.804493	26.37	---	56.00	29.63	L1	29.8	-3.43	---
3.804493	---	21.93	46.00	24.07	L1	29.8	---	-7.87
10.627350	---	24.92	50.00	25.08	N	29.9	---	-4.98
10.691314	30.22	---	60.00	29.78	L1	29.9	0.32	---
13.019614	---	20.95	50.00	29.05	L1	30.0	---	-9.05
13.121957	25.14	---	60.00	34.86	L1	30.0	-4.86	---

EUT3+Laptop:

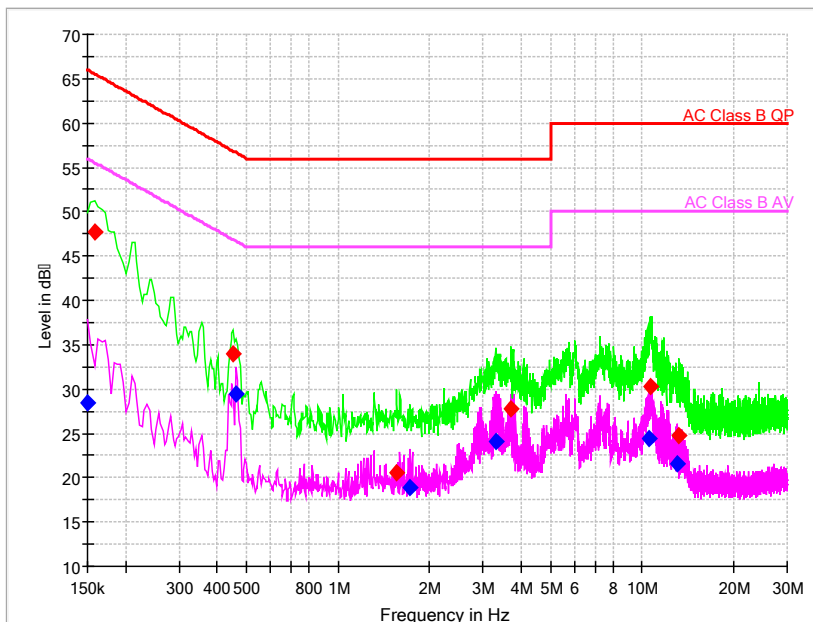

Pic6. Conducted emission L&N Line

Frequency (MHz)	QuasiPeak (dBμV)	Average (dBμV)	Limit (dBμV)	Margin (dB)	Line	Corr. (dB)	Pme a Quas	Pme a Aver
0.150000	---	28.42	56.00	27.58	L1	29.7	---	-1.28
0.158529	47.67	---	65.54	17.87	L1	29.7	17.9	---
0.452764	33.91	---	56.82	22.91	L1	29.7	4.21	---
0.461293	---	29.48	46.67	17.19	L1	29.7	---	-0.22
1.552950	20.56	---	56.00	35.44	L1	29.8	-9.24	---
1.727786	---	18.81	46.00	27.19	L1	29.8	---	-10.9
3.301307	---	24.00	46.00	22.00	L1	29.8	---	-5.8
3.714943	27.80	---	56.00	28.20	L1	29.8	-2	---
10.512214	---	24.38	50.00	25.62	N	29.9	---	-5.52
10.652936	30.33	---	60.00	29.67	L1	29.9	0.43	---
13.015350	---	21.57	50.00	28.43	L1	30.0	---	-8.43
13.224300	24.67	---	60.00	35.33	L1	30.0	-5.33	---

## 2.2.2 Radiated Emissions-FCC Part15.109

Ambient condition:

Temperature	Relative humidity	Pressure
26.4°C	40.1%	100.8kPa

Test Setup:

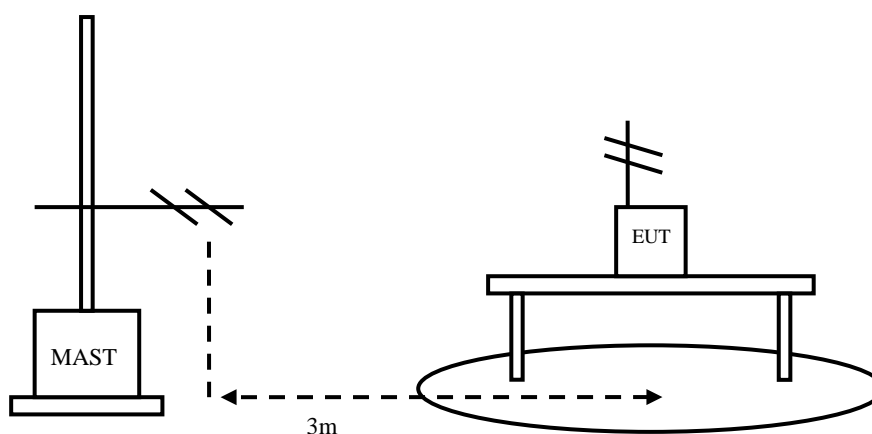

Figure 3

Test Procedure:

EUT+Charger:

The EUT should be placed on a non-metallic table 80cm above the ground plane. The receive antennas shall be moved from 1 to 4 meters. The distance between EUT and receive antenna should be 3 meters.

The EUT should work in idle mode. The accessories of the EUT are connected with the EUT such as headset etc. Open the following functions of EUT: Camera, flash lamp, GPS and video. The test set-up and the test methods are performed according to ANSI C63.4:2014.

Then start the test software EMC32. Sweep the whole frequency band through the range from 30MHz to 1GHz, using receive log period antenna VULB 9163.

During the test, the height of receive antenna shall be moved from 1 to 4 meters, and the antenna shall be performed under horizontal and vertical polarization. The turn table shall be rotated from 0 to 360 degrees for detecting the maximum of radiated spurious signal level. The measurements shall be repeated with orthogonal polarization of the test antenna. The EUT is laid in two modes as follow: 1. put the EUT in horizontal direction; 2. put the EUT in vertical direction.

The data of cable loss and antenna factor have been calibrated in full testing frequency range before the testing. All test results are performed with max hold at the horizontal and vertical polarity.

RBW=120kHz, VBW=300kHz, when the test frequency: 30MHz<f<1GHz



RBW=1MHz, VBW=3MHz, when the test frequency:  $f > 1\text{GHz}$

EUT+Laptop:

The EUT should be placed on a non-metallic table 80cm above the ground plane. The receive antennas shall be moved from 1 to 4 meters. The distance between EUT and receive antenna should be 3 meters.

The accessories of the EUT are connected with the EUT such as headset etc. The EUT was connected with a laptop via the USB cable and transferred the data by copying large files from laptop to the EUT. The test set-up and the test methods are performed according to ANSI C63.4:2014

Then start the test software EMC32. Sweep the whole frequency band through the range from 30MHz to 1GHz, using receive log period antenna VULB 9163.

During the test, the height of receive antenna shall be moved from 1 to 4 meters, and the antenna shall be performed under horizontal and vertical polarization. The turn table shall be rotated from 0 to 360 degrees for detecting the maximum of radiated spurious signal level. The measurements shall be repeated with orthogonal polarization of the test antenna. The EUT is laid in two modes as follow: 1. put the EUT in horizontal direction; 2. put the EUT in vertical direction.

The data of cable loss and antenna factor have been calibrated in full testing frequency range before the testing.

A “reference path loss” is established and the  $A_{Rpl}$  is the attenuation of “reference path loss”, and including the gain of receive antenna, the gain of the preamplifier, the cable loss.

The measurement results are obtained as described below:

$$\text{Result} = P_{\text{mea}} + A_{Rpl}$$

Sample calculation:  $(11.38 \text{ dB}\mu\text{V/m}) = (31.58 \text{ dB}\mu\text{V}) + (-20.2 \text{ dB/m})$ , the corresponding frequency is 33.831500MHz.

Limit:

Frequency of Emission(MHz)	Limits	
	Detector	Unit (dB $\mu$ V/m)
30~88	Quasi-peak	40
88~216	Quasi-peak	43.5
216~960	Quasi-peak	46
960~1000	Quasi-peak	54
1000~5th harmonic of the highest frequency or 40GHz, whichever is lower	Average	54
	Peak	74

Test result:

EUT1+charger:

Frequency(MHz)	Result(dBuV/m)	A <sub>Rpl</sub> (dB/m)	P <sub>mea</sub> (dBuV)	Polarity
33.831500	11.38	-20.2	31.58	V
70.594500	12.81	-22.2	35.01	V
72.777000	13.48	-22.8	36.28	V
168.807000	16.76	-21.7	38.46	V
183.793500	20.64	-20.5	41.14	V
946.068000	19.21	-2.8	22.01	V

EUT2+charger:

Frequency(MHz)	Result(dBuV/m)	A <sub>Rpl</sub> (dB/m)	P <sub>mea</sub> (dBuV)	Polarity
30.000000	9.06	-21.3	30.36	V
70.594500	12.71	-22.2	34.91	V
75.056500	13.51	-23.3	36.81	V
171.814000	17.23	-21.6	38.83	V
180.495500	19.57	-21.0	40.57	V
951.742500	19.03	-2.7	21.73	V

EUT1+Laptop:

Frequency(MHz)	Result(dBuV/m)	A <sub>Rpl</sub> (dB/m)	P <sub>mea</sub> (dBuV)	Polarity
47.460000	14.72	-17.7	32.42	V
56.578000	8.46	-18.4	26.86	V
167.982500	15.14	-21.8	36.94	V
215.949000	24.67	-18.5	43.17	V
359.994000	30.35	-14.1	44.45	V
799.986000	23.53	-5.2	28.73	V

EUT3+ Laptop:

Frequency(MHz)	Result(dBuV/m)	A <sub>Rpl</sub> (dB/m)	P <sub>mea</sub> (dBuV)	Polarity
49.739500	8.93	-17.5	26.43	V
55.850500	7.71	-18.3	26.01	V
167.982500	15.55	-21.8	37.35	V
215.949000	24.02	-18.5	42.52	V
359.994000	30.36	-14.1	44.46	V
799.986000	23.87	-5.2	29.07	V

EUT1+charger: refer to Pic7 to Pic10

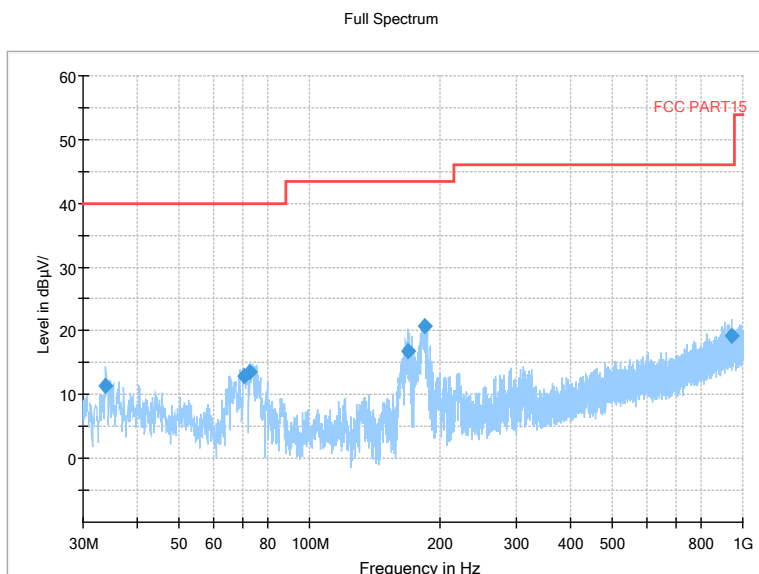

Pic7. Radiated emission (30MHz – 1GHz)

Note: The test data in the graph includes two polarizations: horizontal and vertical

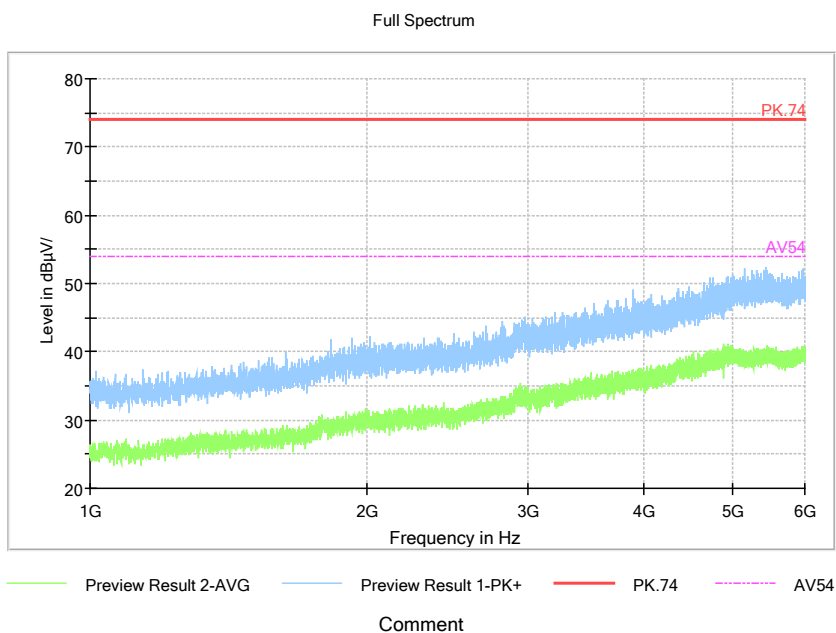

Pic8. Radiated emission (1GHz –6GHz)

Note: The test data in the graph includes two polarizations: horizontal and vertical

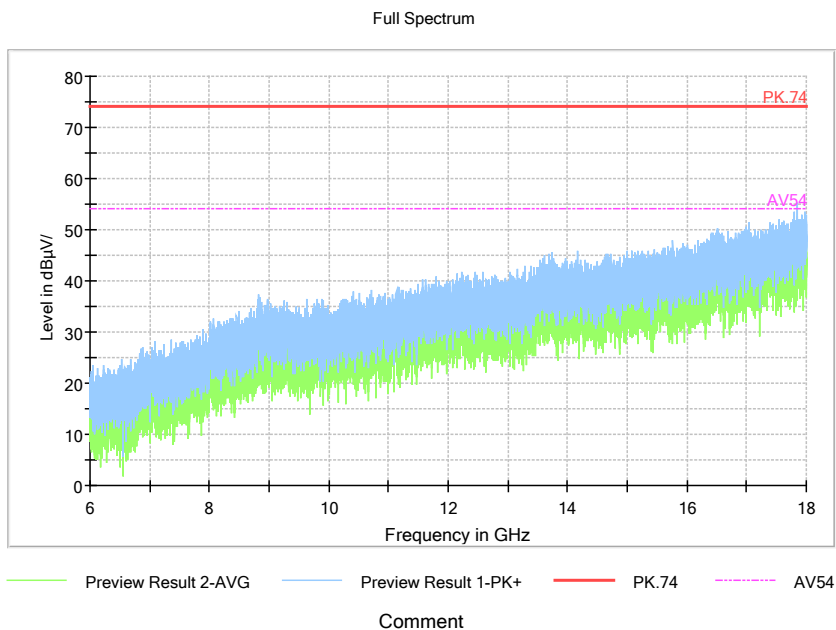

Pic9. Radiated emission (6GHz –18GHz)

Note: The test data in the graph includes two polarizations: horizontal and vertical

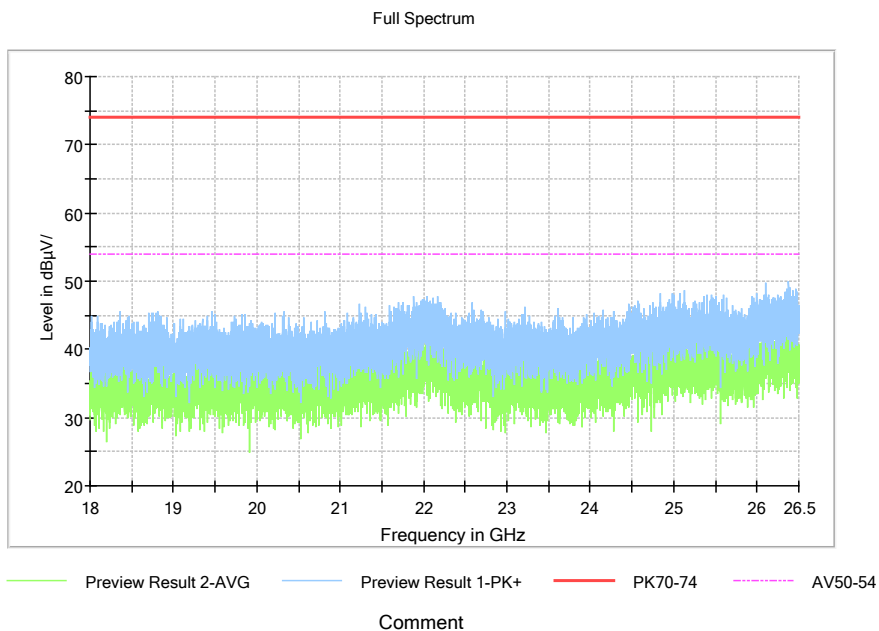

Pic10. Radiated emission (18GHz –26GHz)

Note: The test data in the graph includes two polarizations: horizontal and vertical

EUT2+charger: refer to Pic11 to Pic14

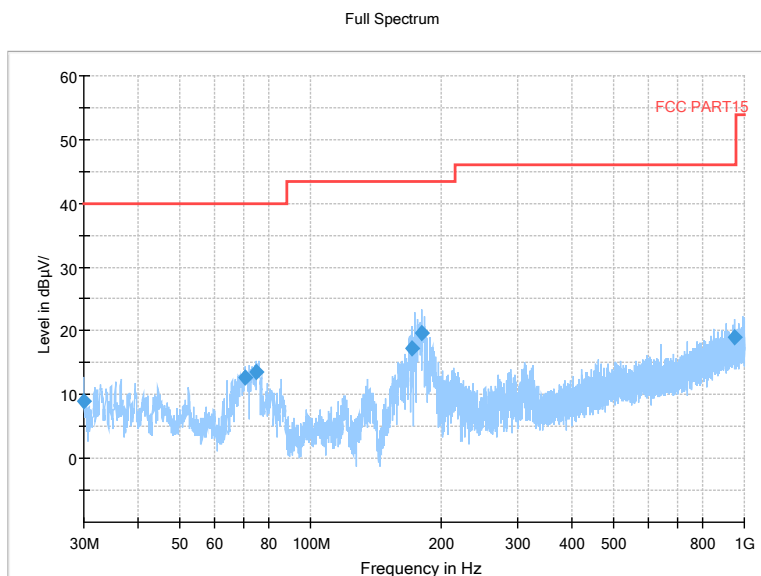

Pic11. Radiated emission (30MHz – 1GHz)

Note: The test data in the graph includes two polarizations: horizontal and vertical

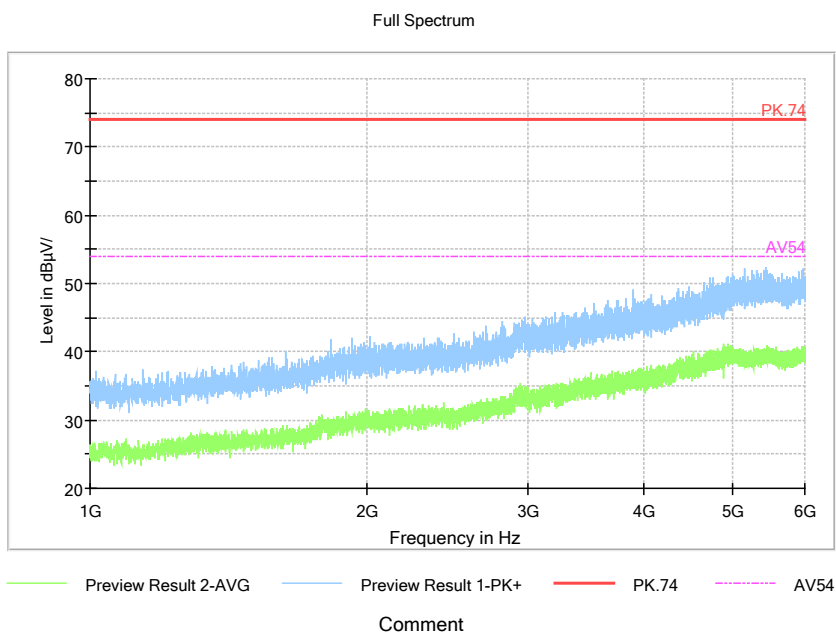

Pic12. Radiated emission (1GHz –6GHz)

Note: The test data in the graph includes two polarizations: horizontal and vertical

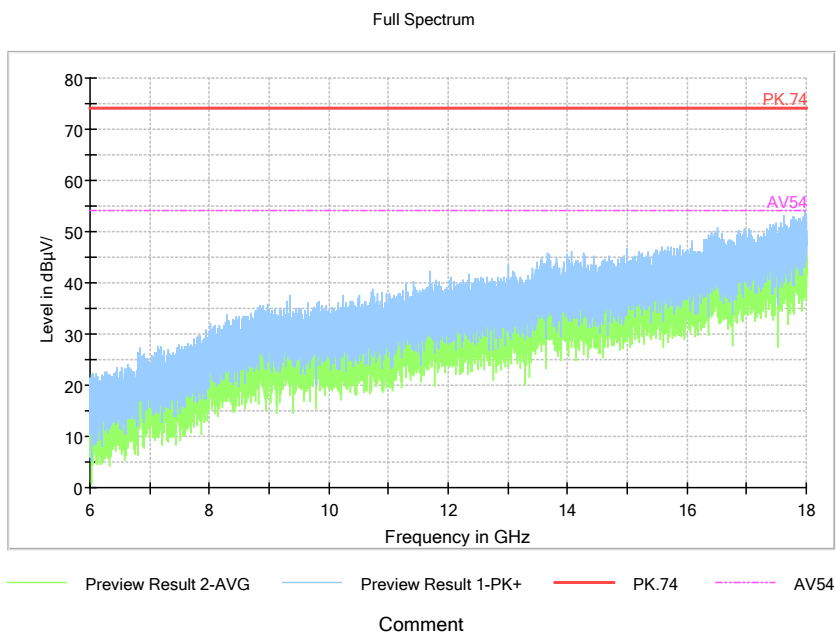

Pic13. Radiated emission (6GHz –18GHz)

Note: The test data in the graph includes two polarizations: horizontal and vertical



Pic14. Radiated emission (18GHz –26GHz)

Note: The test data in the graph includes two polarizations: horizontal and vertical

EUT1+ Laptop: refer to Pic15 to Pic18

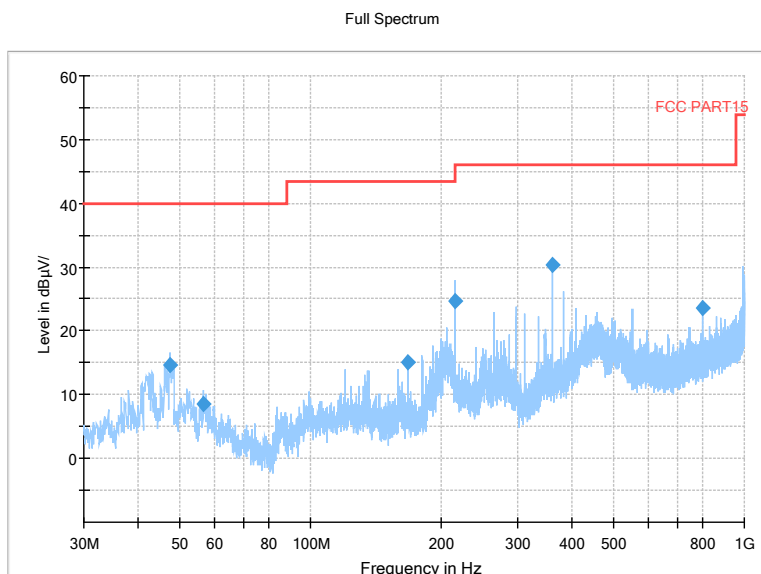

Pic15. Radiated emission (30MHz – 1GHz)

Note: The test data in the graph includes two polarizations: horizontal and vertical

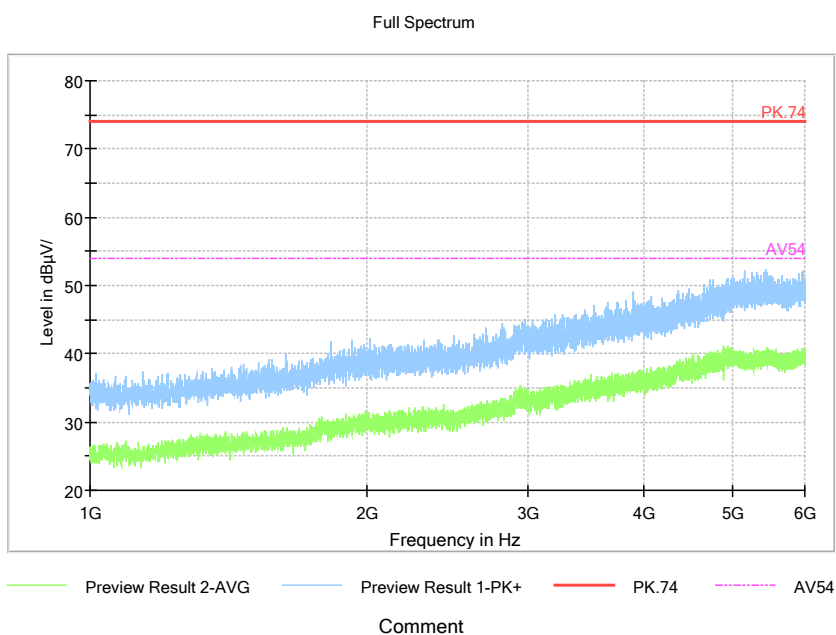

Pic16. Radiated emission (1GHz –6GHz)

Note: The test data in the graph includes two polarizations: horizontal and vertical

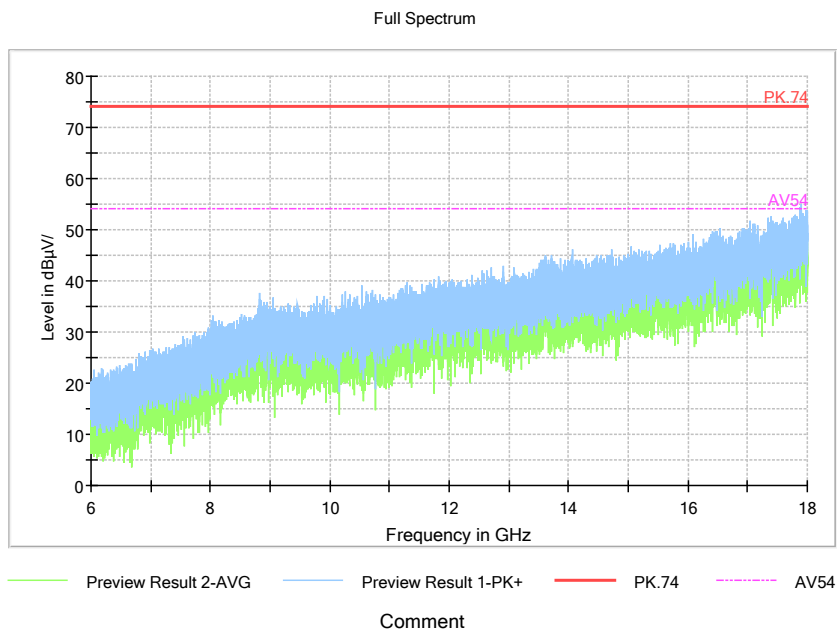

Pic17. Radiated emission (6GHz –18GHz)

Note: The test data in the graph includes two polarizations: horizontal and vertical

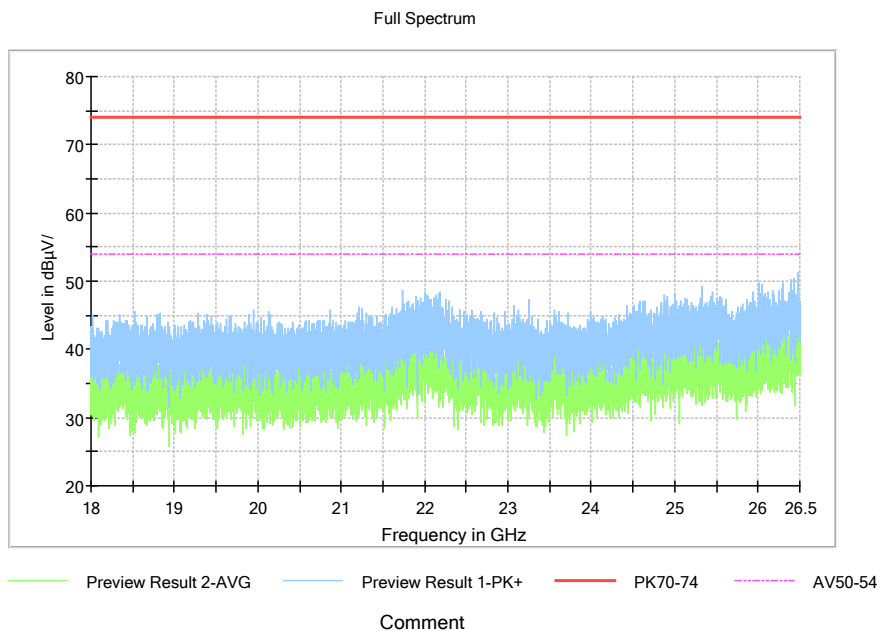

Pic18. Radiated emission (18GHz –26GHz)

Note: The test data in the graph includes two polarizations: horizontal and vertical



EUT3+Laptop: refer to Pic19 to Pic22

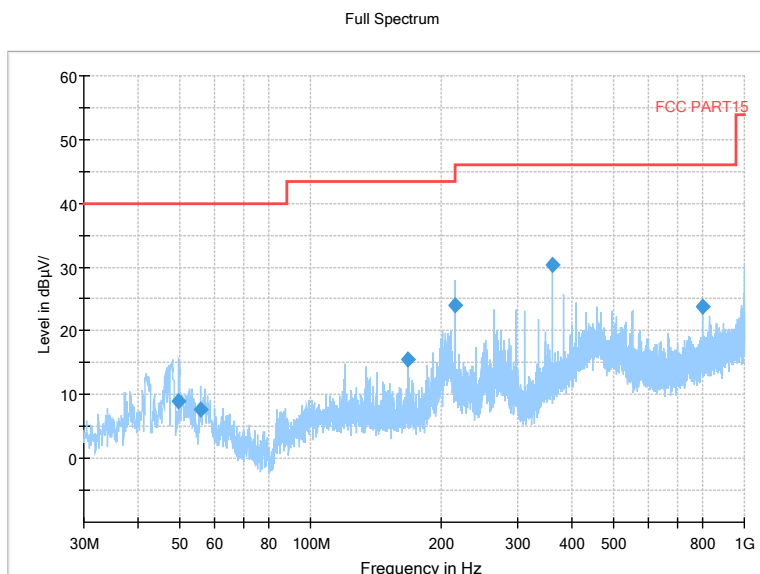

Pic19. Radiated emission (30MHz – 1GHz)

Note: The test data in the graph includes two polarizations: horizontal and vertical

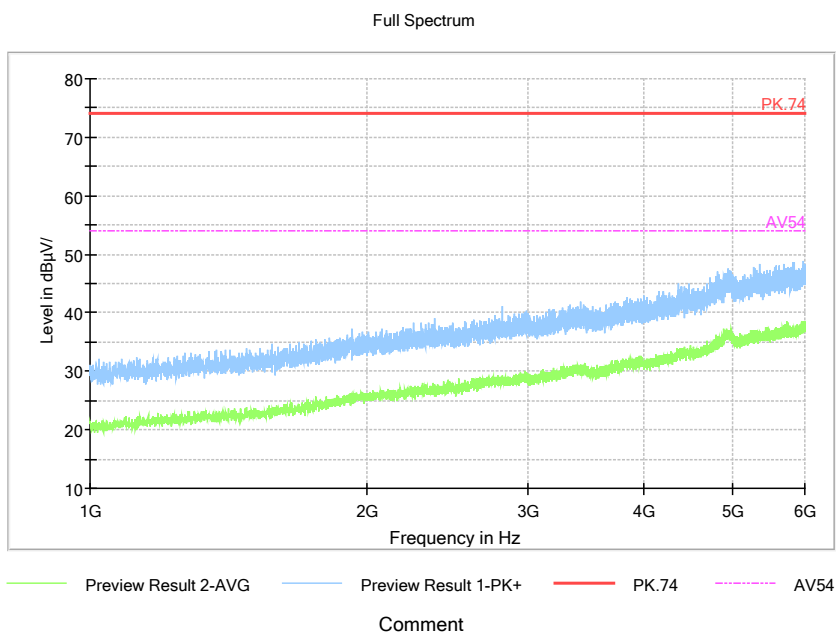

Pic20. Radiated emission (1GHz –6GHz)

Note: The test data in the graph includes two polarizations: horizontal and vertical

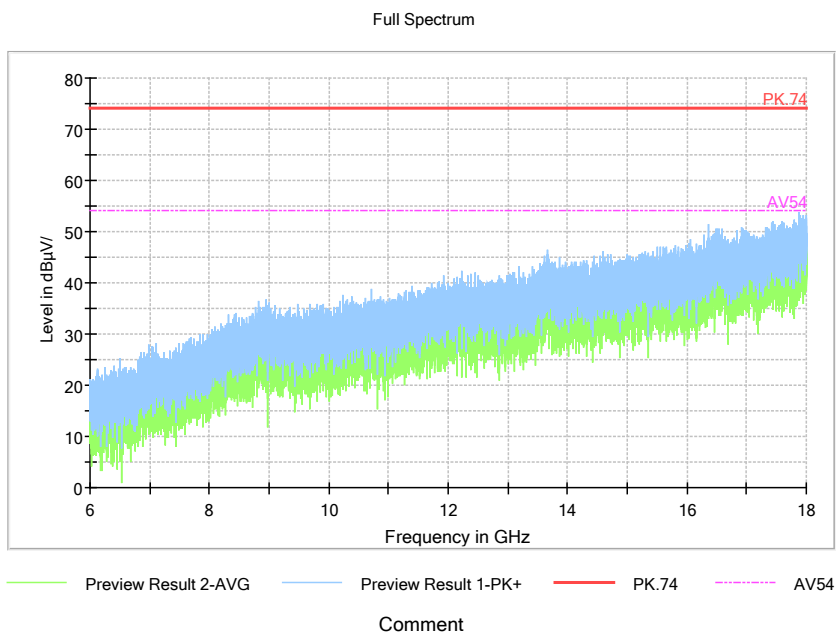

**Pic21. Radiated emission (6GHz –18GHz)**

Note: The test data in the graph includes two polarizations: horizontal and vertical

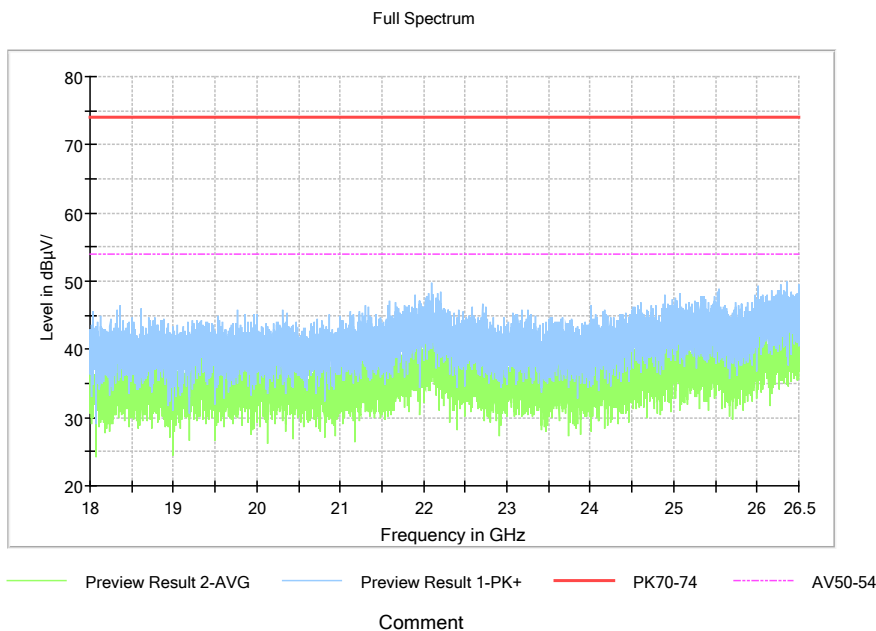

**Pic22. Radiated emission (18GHz –26GHz)**

Note: The test data in the graph includes two polarizations: horizontal and vertical

### 2.3. List of test equipments

No.	Name/Model	Manufacturer	S/N	Calibration Due Date	Calibration Date
1	23.18m×16.88m×9.60mS emi-AnechoicChamber	FRANKONIA	-----	2023.09.05	2018.09.06
2	ESW EMI test receiver	R&S	101574	2022.06.19	2021.06.20
3	ESR3 EMI test receiver	R&S	102361	2022.04.11	2021.04.12
4	9.080m×5.255m×3.525m Shielding room	FRANKONIA	-----	2023.09.05	2018.09.06
5	VULB 9163 Ultra log test antenna	schwarzbeck	867	2023.05.28	2021.05.29
6	HF 907 Double-Ridged Waveguide Horn Antenna	R&S	100512	2023.05.12	2021.05.13
7	SAS-574 Horn Antenna	schwarzbeck	535	2023.06.19	2021.06.20
8	ENV216 AMN	R&S	3560.6550. 12	2022.06.19	2021.06.20
9	EMC32EMI test software	R&S	-----	-----	-----

-----The end-----