

ELECTROMAGNETIC EMISSIONS COMPLIANCE REPORT

OF

FCC Applicant: Sharp Corporation, Mobile Communication B.U.
2-13-1, Hachihonmatsu-lida, Higashi-hiroshima-shi, Hiroshima, 739-0192, Japan

FCC Manufacturer: Sharp Corporation
1 Takumi-cho, Sakai-ku, Sakai City, Osaka 590-8522, Japan

Product Name: Smart phone

Report Number: ER/2020/C0010-01

FCC ID APYHRO00293

FCC Rule Part: 2 , 22H & 24E & 27 C

Issue Date: February 1, 2021

Date of Test: December 9, 2020 - January 14, 2021

Date of EUT Received: December 9, 2020

We hereby certify that:

The above equipment was tested by SGS Taiwan Ltd. Central RF Lab The test data, data evaluation, test procedures, and equipment configurations shown in this report were made in accordance with the procedures given in ANSI C63.26-2015 and the energy emitted by the sample EUT tested as described in this report is in compliance with conducted and radiated emission limits.

The test results of this report relate only to the tested sample identified in this report.

Approved By: _____



Jim Chang / Manager



Unless otherwise stated the results shown in this test report refer only to the sample(s) tested and such sample(s) are retained for 90 days only.

除非另有說明，此報告結果僅對測試之樣品負責，同時此樣品僅保留90天。本報告未經本公司書面許可，不可部份複製。

This document is issued by the Company subject to its General Conditions of Service printed overleaf, available on request or accessible at <http://www.sgs.com.tw/Terms-and-Conditions> and for electronic format documents, subject to Terms and Conditions for Electronic Documents at <http://www.sgs.com.tw/Terms-and-Conditions>. Attention is drawn to the limitation of liability, indemnification and jurisdiction issues defined therein. Any holder of this document is advised that information contained hereon reflects the Company's findings at the time of its intervention only and within the limits of Client's instructions, if any. The Company's sole responsibility is to its Client and this document does not exonerate parties to a transaction from exercising all their rights and obligations under the transaction documents. This document cannot be reproduced except in full, without prior written approval of the Company. Any unauthorized alteration, forgery or falsification of the content or appearance of this document is unlawful and offenders may be prosecuted to the fullest extent of the law.

Revision History

Report Number	Revision	Description	Issue Date	Remark
ER/2020/C0010	Rev.00	Original.	January 27, 2021	Revised By: Karen Huang
ER/2020/C0010-01	Rev.01	Added LTE B41 Diversity Antenna test plots	February 1, 2021	Revised By: Karen Huang

Note:

- 1、Disclaimer
Antenna information is provided by the applicant, test results of this report are applicable to the sample EUT received.
- 2、Measurement results in the original test report **ER/2020/C0010** are fully leveraged in this test report with new evaluation on LTE B41 Diversity Antenna to demonstrate compliance.

Unless otherwise stated the results shown in this test report refer only to the sample(s) tested and such sample(s) are retained for 90 days only.

除非另有說明，此報告結果僅對測試之樣品負責，同時此樣品僅保留90天。本報告未經本公司書面許可，不可部份複製。

This document is issued by the Company subject to its General Conditions of Service printed overleaf, available on request or accessible at <http://www.sgs.com.tw/Terms-and-Conditions> and for electronic format documents, subject to Terms and Conditions for Electronic Documents at <http://www.sgs.com.tw/Terms-and-Conditions>. Attention is drawn to the limitation of liability, indemnification and jurisdiction issues defined therein. Any holder of this document is advised that information contained hereon reflects the Company's findings at the time of its intervention only and within the limits of Client's instructions, if any. The Company's sole responsibility is to its Client and this document does not exonerate parties to a transaction from exercising all their rights and obligations under the transaction documents. This document cannot be reproduced except in full, without prior written approval of the Company. Any unauthorized alteration, forgery or falsification of the content or appearance of this document is unlawful and offenders may be prosecuted to the fullest extent of the law.

Contents

1	GENERAL PRODUCT INFORMATION	4
2	SYSTEM TEST CONFIGURATION	10
3	SUMMARY OF TEST RESULTS	13
4	DESCRIPTION OF TEST MODES	14
5	MEASUREMENT UNCERTAINTY	17
6	MAXMUM OUTPUT POWER	18
7	OCCUPIED BANDWIDTH MEASUREMENT	47
8	OUT OF BAND EMISSION AT ANTENNA TERMINALS	89
9	FIELD STRENGTH OF SPURIOUS RADIATION MEASUREMENT.....	115
10	FREQUENCY STABILITY MEASUREMENT	180
11	PEAK TO AVERAGE RATIO	186

Unless otherwise stated the results shown in this test report refer only to the sample(s) tested and such sample(s) are retained for 90 days only.

除非另有說明，此報告結果僅對測試之樣品負責，同時此樣品僅保留90天。本報告未經本公司書面許可，不可部份複製。

This document is issued by the Company subject to its General Conditions of Service printed overleaf, available on request or accessible at <http://www.sgs.com.tw/Terms-and-Conditions> and for electronic format documents, subject to Terms and Conditions for Electronic Documents at <http://www.sgs.com.tw/Terms-and-Conditions>. Attention is drawn to the limitation of liability, indemnification and jurisdiction issues defined therein. Any holder of this document is advised that information contained hereon reflects the Company's findings at the time of its intervention only and within the limits of Client's instructions, if any. The Company's sole responsibility is to its Client and this document does not exonerate parties to a transaction from exercising all their rights and obligations under the transaction documents. This document cannot be reproduced except in full, without prior written approval of the Company. Any unauthorized alteration, forgery or falsification of the content or appearance of this document is unlawful and offenders may be prosecuted to the fullest extent of the law.

1 GENERAL PRODUCT INFORMATION

1.1 Product Description

General:

Product Name:	Smart phone
Hardware Version:	DVT
Software Version:	N/A
Power Supply:	3.85 Vdc from Rechargeable Li-polymer Battery
Antenna Designation:	Inverted-F Antenna, Gain: -4.2dBi (GSM/GPRS 800, WCDMA B5, LTE B5) -2.3dBi (GSM/GPRS 1900, WCDMA B2, LTE B2) -6.7dBi (LTE B7) -3.5dBi (LTE B38, LTE B41)
IMEI:	004401230171056 / 004401230171411 / 004401230172013 / 004401230171056 / 004401230171288

Unless otherwise stated the results shown in this test report refer only to the sample(s) tested and such sample(s) are retained for 90 days only.

除非另有說明，此報告結果僅對測試之樣品負責，同時此樣品僅保留90天。本報告未經本公司書面許可，不可部份複製。

This document is issued by the Company subject to its General Conditions of Service printed overleaf, available on request or accessible at <http://www.sgs.com.tw/Terms-and-Conditions> and for electronic format documents, subject to Terms and Conditions for Electronic Documents at <http://www.sgs.com.tw/Terms-and-Conditions>. Attention is drawn to the limitation of liability, indemnification and jurisdiction issues defined therein. Any holder of this document is advised that information contained hereon reflects the Company's findings at the time of its intervention only and within the limits of Client's instructions, if any. The Company's sole responsibility is to its Client and this document does not exonerate parties to a transaction from exercising all their rights and obligations under the transaction documents. This document cannot be reproduced except in full, without prior written approval of the Company. Any unauthorized alteration, forgery or falsification of the content or appearance of this document is unlawful and offenders may be prosecuted to the fullest extent of the law.

1.2 Operation Frequency Range

Operating Frequency (MHz)	
GSM/GPRS 850	824.2 - 848.8
GSM/GPRS 1900	1850.2 - 1909.8

Operating Frequency (MHz)	
WCDMA / HSPA+ Band II	1852.4 - 1907.6
WCDMA / HSPA+ Band V	826.4 - 846.6

LTE Band 2			
BW (MHz)	Operation Frequency (MHz)		
1.4	1850.7	-	1909.3
3	1851.5	-	1908.5
5	1852.5	-	1907.5
10	1855.0	-	1905.0
15	1857.5	-	1902.5
20	1860.0	-	1900.0

LTE Band 5			
BW (MHz)	Operation Frequency (MHz)		
1.4	824.7	-	848.3
3	825.5	-	847.5
5	826.5	-	846.5
10	829.0	-	844.0

LTE Band 7			
BW (MHz)	Operation Frequency (MHz)		
5	2502.5	-	2567.5
10	2505.0	-	2565.0
15	2507.5	-	2562.5
20	2510.0	-	2560.0

LTE Band 38			
BW (MHz)	Operation Frequency (MHz)		
5	2572.5	-	2617.5
10	2575.0	-	2615.0
15	2577.5	-	2612.5
20	2580.0	-	2610.0

LTE Band 41			
BW (MHz)	Operation Frequency (MHz)		
5	2498.5	-	2687.5
10	2501.0	-	2685.0
15	2503.5	-	2682.5
20	2506.0	-	2680.0

Unless otherwise stated the results shown in this test report refer only to the sample(s) tested and such sample(s) are retained for 90 days only.

除非另有說明，此報告結果僅對測試之樣品負責，同時此樣品僅保留90天。本報告未經本公司書面許可，不可部份複製。

This document is issued by the Company subject to its General Conditions of Service printed overleaf, available on request or accessible at <http://www.sgs.com.tw/Terms-and-Conditions> and for electronic format documents, subject to Terms and Conditions for Electronic Documents at <http://www.sgs.com.tw/Terms-and-Conditions>. Attention is drawn to the limitation of liability, indemnification and jurisdiction issues defined therein. Any holder of this document is advised that information contained hereon reflects the Company's findings at the time of its intervention only and within the limits of Client's instructions, if any. The Company's sole responsibility is to its Client and this document does not exonerate parties to a transaction from exercising all their rights and obligations under the transaction documents. This document cannot be reproduced except in full, without prior written approval of the Company. Any unauthorized alteration, forgery or falsification of the content or appearance of this document is unlawful and offenders may be prosecuted to the fullest extent of the law.

1.3 Type of Emission & Max ERP/EIRP Power Measurement Result:

	ERP / EIRP (dBm)		W	99%	Type of Emission
GSM 850	26.07	ERP	0.405	0.2444	244KGXW
GPRS 850	26.03	ERP	0.401	0.2456	246KGXW
GSM 1900	27.45	EIRP	0.556	0.2487	249KGXW
GPRS 1900	27.42	EIRP	0.552	0.2430	243KGXW
	ERP / EIRP (dBm)		W	99%	Type of Emission
WCDMA Band II	20.78	EIRP	0.120	4.1709	4M17F9W
HSDPA Band II	19.85	EIRP	0.097	4.1541	4M15F9W
HSUPA Band II	19.79	EIRP	0.095	4.1497	4M15F9W
WCDMA Band V	18.24	ERP	0.067	4.1486	4M15F9W
HSDPA Band V	17.27	ERP	0.053	4.1483	4M15F9W
HSUPA Band V	17.25	ERP	0.053	4.1423	4M14F9W

LTE Band	BW	Modulation	ERP / EIRP (dBm)		(W)	99%	Type of Emission
2	1.4	QPSK	19.81	EIRP	0.096	1.0950	1M10G7D
		16QAM	19.33	EIRP	0.086	1.0972	1M10D7W
		64QAM	18.57	EIRP	0.072	1.0964	1M10D7W
2	3	QPSK	19.87	EIRP	0.097	2.6985	2M70G7D
		16QAM	18.87	EIRP	0.077	2.6995	2M70D7W
		64QAM	18.26	EIRP	0.067	2.7006	2M70D7W
2	5	QPSK	19.95	EIRP	0.099	4.5012	4M50G7D
		16QAM	18.92	EIRP	0.078	4.5015	4M50D7W
		64QAM	18.26	EIRP	0.067	4.5127	4M51D7W
2	10	QPSK	20.05	EIRP	0.101	9.0282	9M03G7D
		16QAM	19.12	EIRP	0.082	8.9758	8M98D7W
		64QAM	18.47	EIRP	0.070	9.0067	9M01D7W
2	15	QPSK	20.08	EIRP	0.102	13.513	13M5G7D
		16QAM	19.19	EIRP	0.083	13.492	13M5D7W
		64QAM	18.32	EIRP	0.068	13.486	13M5D7W
2	20	QPSK	20.19	EIRP	0.104	17.987	18M0G7D
		16QAM	19.54	EIRP	0.090	18.022	18M0D7W
		64QAM	18.44	EIRP	0.070	17.988	18M0D7W

Unless otherwise stated the results shown in this test report refer only to the sample(s) tested and such sample(s) are retained for 90 days only.

除非另有說明，此報告結果僅對測試之樣品負責，同時此樣品僅保留90天。本報告未經本公司書面許可，不可部份複製。

This document is issued by the Company subject to its General Conditions of Service printed overleaf, available on request or accessible at <http://www.sgs.com.tw/Terms-and-Conditions> and for electronic format documents, subject to Terms and Conditions for Electronic Documents at <http://www.sgs.com.tw/Terms-and-Conditions>. Attention is drawn to the limitation of liability, indemnification and jurisdiction issues defined therein. Any holder of this document is advised that information contained hereon reflects the Company's findings at the time of its intervention only and within the limits of Client's instructions, if any. The Company's sole responsibility is to its Client and this document does not exonerate parties to a transaction from exercising all their rights and obligations under the transaction documents. This document cannot be reproduced except in full, without prior written approval of the Company. Any unauthorized alteration, forgery or falsification of the content or appearance of this document is unlawful and offenders may be prosecuted to the fullest extent of the law.

LTE Band	BW	Modulation	ERP / EIRP (dBm)		(W)	99%	Type of Emission
5	1.4	QPSK	16.82	ERP	0.048	1.0950	1M10G7D
		16QAM	16.31	ERP	0.043	1.0977	1M10D7W
		64QAM	15.34	ERP	0.034	1.0963	1M10D7W
5	3	QPSK	16.86	ERP	0.049	2.6979	2M70G7D
		16QAM	16.36	ERP	0.043	2.7011	2M70D7W
		64QAM	15.20	ERP	0.033	2.7013	2M70D7W
5	5	QPSK	16.88	ERP	0.049	4.4968	4M50G7D
		16QAM	16.18	ERP	0.041	4.4962	4M50D7W
		64QAM	15.24	ERP	0.033	4.5088	4M51D7W
5	10	QPSK	16.93	ERP	0.049	9.0087	9M01G7D
		16QAM	16.44	ERP	0.044	8.9552	8M96D7W
		64QAM	15.37	ERP	0.034	8.9771	8M98D7W
LTE Band	BW	Modulation	ERP / EIRP (dBm)		(W)	99%	Type of Emission
7	5	QPSK	16.50	EIRP	0.045	4.5019	4M50G7D
		16QAM	16.12	EIRP	0.041	4.5033	4M50D7W
		64QAM	14.67	EIRP	0.029	4.5075	4M51D7W
7	10	QPSK	16.54	EIRP	0.045	9.0187	9M02G7D
		16QAM	15.82	EIRP	0.038	8.9788	8M98D7W
		64QAM	14.57	EIRP	0.029	8.9972	9M00D7W
7	15	QPSK	16.51	EIRP	0.045	13.488	13M5G7D
		16QAM	16.04	EIRP	0.040	13.480	13M5D7W
		64QAM	14.65	EIRP	0.029	13.475	13M5D7W
7	20	QPSK	16.56	EIRP	0.045	17.974	18M0G7D
		16QAM	15.94	EIRP	0.039	18.005	18M0D7W
		64QAM	14.58	EIRP	0.029	17.976	18M0D7W

Unless otherwise stated the results shown in this test report refer only to the sample(s) tested and such sample(s) are retained for 90 days only.

除非另有說明，此報告結果僅對測試之樣品負責，同時此樣品僅保留90天。本報告未經本公司書面許可，不可部份複製。

This document is issued by the Company subject to its General Conditions of Service printed overleaf, available on request or accessible at <http://www.sgs.com.tw/Terms-and-Conditions> and for electronic format documents, subject to Terms and Conditions for Electronic Documents at <http://www.sgs.com.tw/Terms-and-Conditions>. Attention is drawn to the limitation of liability, indemnification and jurisdiction issues defined therein. Any holder of this document is advised that information contained hereon reflects the Company's findings at the time of its intervention only and within the limits of Client's instructions, if any. The Company's sole responsibility is to its Client and this document does not exonerate parties to a transaction from exercising all their rights and obligations under the transaction documents. This document cannot be reproduced except in full, without prior written approval of the Company. Any unauthorized alteration, forgery or falsification of the content or appearance of this document is unlawful and offenders may be prosecuted to the fullest extent of the law.

LTE Band	BW	Modulation	ERP / EIRP (dBm)		(W)	99%	Type of Emission
38	5	QPSK	19.63	EIRP	0.092	4.5106	4M51G7D
		16QAM	18.94	EIRP	0.078	4.5073	4M51D7W
		64QAM	17.68	EIRP	0.059	4.5079	4M51D7W
38	10	QPSK	19.68	EIRP	0.093	8.9962	9M00G7D
		16QAM	18.81	EIRP	0.076	8.9838	8M98D7W
		64QAM	17.69	EIRP	0.059	8.9973	9M00D7W
38	15	QPSK	19.65	EIRP	0.092	13.511	13M5G7D
		16QAM	18.77	EIRP	0.075	13.492	13M5D7W
		64QAM	17.73	EIRP	0.059	13.488	13M5D7W
38	20	QPSK	19.74	EIRP	0.094	17.968	18M0G7D
		16QAM	18.88	EIRP	0.077	18.009	18M0D7W
		64QAM	17.76	EIRP	0.060	17.967	18M0D7W
LTE Band	BW	Modulation	ERP / EIRP (dBm)		(W)	99%	Type of Emission
41	5	QPSK	20.12	EIRP	0.103	4.5151	4M52G7D
		16QAM	19.27	EIRP	0.085	4.5067	4M51D7W
		64QAM	18.45	EIRP	0.070	4.5103	4M51D7W
41	10	QPSK	20.06	EIRP	0.101	9.0055	9M01G7D
		16QAM	19.33	EIRP	0.086	8.9796	8M98D7W
		64QAM	18.57	EIRP	0.072	8.9872	8M99D7W
41	15	QPSK	20.19	EIRP	0.104	13.491	13M5G7D
		16QAM	19.34	EIRP	0.086	13.509	13M5D7W
		64QAM	18.41	EIRP	0.069	13.463	13M5D7W
41	20	QPSK	20.12	EIRP	0.103	17.961	18M0G7D
		16QAM	19.28	EIRP	0.085	17.974	18M0D7W
		64QAM	18.46	EIRP	0.070	17.980	18M0D7W

Unless otherwise stated the results shown in this test report refer only to the sample(s) tested and such sample(s) are retained for 90 days only.

除非另有說明，此報告結果僅對測試之樣品負責，同時此樣品僅保留90天。本報告未經本公司書面許可，不可部份複製。

This document is issued by the Company subject to its General Conditions of Service printed overleaf, available on request or accessible at <http://www.sgs.com.tw/Terms-and-Conditions> and for electronic format documents, subject to Terms and Conditions for Electronic Documents at <http://www.sgs.com.tw/Terms-and-Conditions>. Attention is drawn to the limitation of liability, indemnification and jurisdiction issues defined therein. Any holder of this document is advised that information contained hereon reflects the Company's findings at the time of its intervention only and within the limits of Client's instructions, if any. The Company's sole responsibility is to its Client and this document does not exonerate parties to a transaction from exercising all their rights and obligations under the transaction documents. This document cannot be reproduced except in full, without prior written approval of the Company. Any unauthorized alteration, forgery or falsification of the content or appearance of this document is unlawful and offenders may be prosecuted to the fullest extent of the law.

1.4 Test Methodology of Applied Standards

FCC 47 CFR Part 2, 22H, 24E, 27C

ANSI C63.26-2015

KDB971168 D01 Power Meas license Digital System v03r01

KDB941225 D01 SAR test for 3G devices v03r01 (SAR Measurement Procedures for 3G Devices, WCDMA / HSPA) was used for EUT and Base station setting.

KDB412172 D01 Determining ERP and EIRP v01r01

TS 151 010-1 is used to set, and measure the output power.

1.5 Test Facility

SGS Taiwan Ltd. Central RF Lab (TAF code 3702)

No.134, Wu Kung Road, New Taipei Industrial Park, Wuku District, New Taipei City, Taiwan 24803

FCC Designation number: TW0027

1.6 Special Accessories

No special accessories were used during testing.

1.7 Equipment Modifications

There was no modifications incorporated into the EUT.

1.8 Radiated Emission Test Sites For Measurements From 9 kHz To 30 MHz

Radiated emission below 30MHz is measured in a 9m*9m*6m semi-anechoic chamber, the measurements correspond to those obtained at an open-field test site.

There is a comparison data of both open-field test site and semi-Anechoic chamber, and the result came out very similar.

Unless otherwise stated the results shown in this test report refer only to the sample(s) tested and such sample(s) are retained for 90 days only.

除非另有說明，此報告結果僅對測試之樣品負責，同時此樣品僅保留90天。本報告未經本公司書面許可，不可部份複製。

This document is issued by the Company subject to its General Conditions of Service printed overleaf, available on request or accessible at <http://www.sgs.com.tw/Terms-and-Conditions> and for electronic format documents, subject to Terms and Conditions for Electronic Documents at <http://www.sgs.com.tw/Terms-and-Conditions>. Attention is drawn to the limitation of liability, indemnification and jurisdiction issues defined therein. Any holder of this document is advised that information contained hereon reflects the Company's findings at the time of its intervention only and within the limits of Client's instructions, if any. The Company's sole responsibility is to its Client and this document does not exonerate parties to a transaction from exercising all their rights and obligations under the transaction documents. This document cannot be reproduced except in full, without prior written approval of the Company. Any unauthorized alteration, forgery or falsification of the content or appearance of this document is unlawful and offenders may be prosecuted to the fullest extent of the law.

2 SYSTEM TEST CONFIGURATION

2.1 EUT Configuration

The EUT configuration for testing is installed on RF field strength measurement to meet the Commissions requirement and operating in a manner which intends to maximize its emission characteristics in a continuous normal application.

2.2 EUT Exercise

The EUT (Transmitter) was operated in the continuous transmission mode employed with the simulator of the Base Station that fixates at test default channels to fix the Tx frequency which was for the purpose of the measurements.

2.3 Test Procedure

2.3.1 Conducted Measurement at Antenna Port

The EUT is placed on a table which is 0.8 m above ground plane. A low loss of RF cable was used to connect the antenna port of EUT to measurement equipment.

2.3.2 Radiated Emissions (ERP/EIRP)

The EUT is placed on a turn table, for emission measurements below 1 GHz is 0.8 m above ground plane, for emission measurements above 1 GHz, the table height shall be 1.5 m. The turn table shall rotate 360 degrees to determine the position of maximum emission level. EUT is set 3m away from the receiving antenna which varied from 1m to 4m to find out the highest emission. And also, each emission was to be maximized by changing the polarization of receiving antenna both Horizontal and Vertical. In order to find out the max. emission, the relative positions of this hand-held transmitter (EUT) was rotated through three orthogonal axes and measurement procedures for electric field radiated emissions above 1 GHz the EUT measurement is to be made “while keeping the antenna in the ‘cone of radiation’ from that area and pointed at the area both in azimuth and elevation, with polarization oriented for maximum response.” is still within the 3dB illumination BW of the measurement antenna.

2.4 Measurement Results Explanation Example

For all conducted test items:

The offset level is set in the spectrum analyzer to compensate the RF cable loss and attenuation factor between EUT conducted port and spectrum analyzer. With the offset compensation, the spectrum analyzer reading level is exactly EUT RF output level.

Note:

The spectrum analyzer offset is derived from RF cable loss and attenuator factor.

Following shows an offset computation in physical test.

	RF cable loss (dB)	Attenuation factor(dB)	offset(dB)
LB(1GHz below)	4.03	10	14.03
MB(1GHz - 2GHz)	4.54	10	14.54
MB(2GHz - 3GHz)	4.87	10	14.87

Unless otherwise stated the results shown in this test report refer only to the sample(s) tested and such sample(s) are retained for 90 days only.

除非另有說明，此報告結果僅對測試之樣品負責，同時此樣品僅保留90天。本報告未經本公司書面許可，不可部份複製。

This document is issued by the Company subject to its General Conditions of Service printed overleaf, available on request or accessible at <http://www.sgs.com.tw/Terms-and-Conditions> and for electronic format documents, subject to Terms and Conditions for Electronic Documents at <http://www.sgs.com.tw/Terms-and-Conditions>. Attention is drawn to the limitation of liability, indemnification and jurisdiction issues defined therein. Any holder of this document is advised that information contained hereon reflects the Company's findings at the time of its intervention only and within the limits of Client's instructions, if any. The Company's sole responsibility is to its Client and this document does not exonerate parties to a transaction from exercising all their rights and obligations under the transaction documents. This document cannot be reproduced except in full, without prior written approval of the Company. Any unauthorized alteration, forgery or falsification of the content or appearance of this document is unlawful and offenders may be prosecuted to the fullest extent of the law.

2.5 Final Amplifier Voltage and Current Information:

Test Mode	DC voltage (V)	DC current (mA)
GSM 850	3.85	577
GSM 1900		492
WCDMA B2		567
WCDMA B5		570
LTE Band 2		645
LTE Band 5		646
LTE Band 7		635
LTE Band 38		649
LTE Band 41		647

Unless otherwise stated the results shown in this test report refer only to the sample(s) tested and such sample(s) are retained for 90 days only.

除非另有說明，此報告結果僅對測試之樣品負責，同時此樣品僅保留90天。本報告未經本公司書面許可，不可部份複製。

This document is issued by the Company subject to its General Conditions of Service printed overleaf, available on request or accessible at <http://www.sgs.com.tw/Terms-and-Conditions> and for electronic format documents, subject to Terms and Conditions for Electronic Documents at <http://www.sgs.com.tw/Terms-and-Conditions>. Attention is drawn to the limitation of liability, indemnification and jurisdiction issues defined therein. Any holder of this document is advised that information contained hereon reflects the Company's findings at the time of its intervention only and within the limits of Client's instructions, if any. The Company's sole responsibility is to its Client and this document does not exonerate parties to a transaction from exercising all their rights and obligations under the transaction documents. This document cannot be reproduced except in full, without prior written approval of the Company. Any unauthorized alteration, forgery or falsification of the content or appearance of this document is unlawful and offenders may be prosecuted to the fullest extent of the law.

2.6 Configuration of Tested System

Fig. 2-1 Configuration of Tested System (Fixed Channel-Conducted)

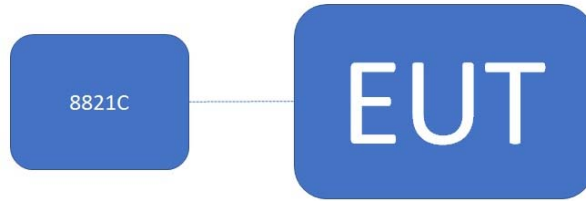

Table 2-1 Equipment Used in

Item	Equipment	Mfr/Brand	Model/ Type No.	Series No.	Data Cable	Power Cord
1.	Radio Communication Analyser	Anritsu	MT8821C	6261786084	shielded	Un-shielded

Unless otherwise stated the results shown in this test report refer only to the sample(s) tested and such sample(s) are retained for 90 days only.

除非另有說明，此報告結果僅對測試之樣品負責，同時此樣品僅保留90天。本報告未經本公司書面許可，不可部份複製。

This document is issued by the Company subject to its General Conditions of Service printed overleaf, available on request or accessible at <http://www.sgs.com.tw/Terms-and-Conditions> and for electronic format documents, subject to Terms and Conditions for Electronic Documents at <http://www.sgs.com.tw/Terms-and-Conditions>. Attention is drawn to the limitation of liability, indemnification and jurisdiction issues defined therein. Any holder of this document is advised that information contained hereon reflects the Company's findings at the time of its intervention only and within the limits of Client's instructions, if any. The Company's sole responsibility is to its Client and this document does not exonerate parties to a transaction from exercising all their rights and obligations under the transaction documents. This document cannot be reproduced except in full, without prior written approval of the Company. Any unauthorized alteration, forgery or falsification of the content or appearance of this document is unlawful and offenders may be prosecuted to the fullest extent of the law.

3 SUMMARY OF TEST RESULTS

FCC Rules	Description Of Test	Result
§2.1046(a)	RF Power Output	Compliant
§22.913(a)(5) §24.232(c) §27.50(h)(2)	ERP/ EIRP measurement	Compliant
§2.1049(h)	99% & 26dB Occupied Bandwidth	Compliant
§2.1051 §22.917(a)(b) §24.238(a) §27.53(m)(4)	Out of Band Emissions at Antenna Terminals and Band Edge / Emission mask requirements	Compliant
§2.1053 §22.917(a) §24.238(a) §27.53(m)(2)	Field Strength of Spurious Radiation	Compliant
§24.232(d) §27.50(a)(1)(B)	Peak to Average Ratio	Compliant
§2.1055(a)(1) §22.355 §24.235 §27.54	Frequency Stability	Compliant

Unless otherwise stated the results shown in this test report refer only to the sample(s) tested and such sample(s) are retained for 90 days only.

除非另有說明，此報告結果僅對測試之樣品負責，同時此樣品僅保留90天。本報告未經本公司書面許可，不可部份複製。

This document is issued by the Company subject to its General Conditions of Service printed overleaf, available on request or accessible at <http://www.sgs.com.tw/Terms-and-Conditions> and for electronic format documents, subject to Terms and Conditions for Electronic Documents at <http://www.sgs.com.tw/Terms-and-Conditions>. Attention is drawn to the limitation of liability, indemnification and jurisdiction issues defined therein. Any holder of this document is advised that information contained hereon reflects the Company's findings at the time of its intervention only and within the limits of Client's instructions, if any. The Company's sole responsibility is to its Client and this document does not exonerate parties to a transaction from exercising all their rights and obligations under the transaction documents. This document cannot be reproduced except in full, without prior written approval of the Company. Any unauthorized alteration, forgery or falsification of the content or appearance of this document is unlawful and offenders may be prosecuted to the fullest extent of the law.

4 DESCRIPTION OF TEST MODES

4.1 The Worst Test Modes and Channel Details

1. The EUT has been tested under operating condition.
2. Pre-Scan has been conducted to determine the worst-case mode from all possible combinations between available modulations, data rates, X(E1)Y(E2)Z(H) axis and antenna ports. The worst case was found as listed below. Following channel(s) was (were) selected for the final test as listed below:

BAND	H PLAN	E1 PLAN	E2 PLAN
GSM/GPRS 850	V		
GSM/GPRS 1900	V		
WCDMA/HSPA Band II	V		
WCDMA/HSPA Band V	V		
LTE Band 2	V		
LTE Band 5	V		
LTE Band 7	V		
LTE Bnad 38	V		
LTE Band 41	V		

Unless otherwise stated the results shown in this test report refer only to the sample(s) tested and such sample(s) are retained for 90 days only.

除非另有說明，此報告結果僅對測試之樣品負責，同時此樣品僅保留90天。本報告未經本公司書面許可，不可部份複製。

This document is issued by the Company subject to its General Conditions of Service printed overleaf, available on request or accessible at <http://www.sgs.com.tw/Terms-and-Conditions> and for electronic format documents, subject to Terms and Conditions for Electronic Documents at <http://www.sgs.com.tw/Terms-and-Conditions>. Attention is drawn to the limitation of liability, indemnification and jurisdiction issues defined therein. Any holder of this document is advised that information contained hereon reflects the Company's findings at the time of its intervention only and within the limits of Client's instructions, if any. The Company's sole responsibility is to its Client and this document does not exonerate parties to a transaction from exercising all their rights and obligations under the transaction documents. This document cannot be reproduced except in full, without prior written approval of the Company. Any unauthorized alteration, forgery or falsification of the content or appearance of this document is unlawful and offenders may be prosecuted to the fullest extent of the law.

4.2 Measurement Configuration

Test Items	GSM Bands	Test Channel		
		L	M	H
ERP	850	v	v	v
EIRP	1900	v	v	v
FREQUENCY STABILITY	850	-	v	-
	1900	-	v	-
OCCUPIED BANDWIDTH	850	v	v	v
	1900	v	v	v
PEAK TO AVERAGE RATIO	850	v	v	v
	1900	v	v	v
BAND EDGE	850	v	-	v
	1900	v	-	v
CONDCUDED EMISSION	850	v	v	v
	1900	v	v	v
RADIATED EMISSION	850	v	v	v
	1900	v	v	v

Test Items	WCDMA / HSPA Bands	Test Channel		
		L	M	H
ERP	Band V	v	v	v
EIRP	Bnad II	v	v	v
FREQUENCY STABILITY	Bnad II	-	v	-
	Band V	-	v	-
OCCUPIED BANDWIDTH	Bnad II	v	v	v
	Band V	v	v	v
PEAK TO AVERAGE RATIO	Bnad II	v	v	v
	Band V	v	v	v
BAND EDGE	Bnad II	v	-	v
	Band V	v	-	v
CONDCUDED EMISSION	Bnad II	v	v	v
	Band V	v	v	v
RADIATED EMISSION	Bnad II	v	v	v
	Band V	v	v	v

Test Items	Band	Test Channel			Bandwidth (MHz)						Modulation			RB #			
		L	M	H	1.4	3	5	10	15	20	QPSK	16QAM	64QAM	1	Half	Full	
Max. Output Power	2	v	v	v	v	v	v	v	v	v	v	v	v	v	v	v	v
	5	v	v	v	v	v	v	v	-	-	v	v	v	v	v	v	v
	7	v	v	v	-	-	v	v	v	v	v	v	v	v	v	v	v
	38	v	v	v	-	-	v	v	v	v	v	v	v	v	v	v	v
	41	v	v	v	-	-	v	v	v	v	v	v	v	v	v	v	v
Frequency Stability	2	-	v	-				v			v	-	-	-	-	-	v
	5	-	v	-				v	-	-	v	-	-	-	-	-	v
	7	-	v	-	-	-		v			v	-	-	-	-	-	v
	38	-	v	-	-	-		v			v	-	-	-	-	-	v
	41	-	v	-	-	-		v			v	-	-	-	-	-	v
26dB and 99% Bandwidth	2	v	v	v	v	v	v	v	v	v	v	v	v	-	-	v	
	5	v	v	v	v	v	v	v	-	-	v	v	v	-	-	v	
	7	v	v	v	-	-	v	v	v	v	v	v	v	-	-	v	
	38	v	v	v	-	-	v	v	v	v	v	v	v	-	-	v	
	41	v	v	v	-	-	v	v	v	v	v	v	v	-	-	v	
Peak-to-Average Ratio	2	v	v	v	v	v	v	v	v	v			v	-	-	v	
	5	v	v	v	v	v	v	v	-	-			v	-	-	v	
	7	v	v	v	-	-	v	v	v	v			v	-	-	v	
	38	v	v	v	-	-	v	v	v	v			v	-	-	v	
	41	v	v	v	-	-	v	v	v	v			v	-	-	v	

Unless otherwise stated the results shown in this test report refer only to the sample(s) tested and such sample(s) are retained for 90 days only.

除非另有說明，此報告結果僅對測試之樣品負責，同時此樣品僅保留90天。本報告未經本公司書面許可，不可部份複製。

This document is issued by the Company subject to its General Conditions of Service printed overleaf, available on request or accessible at <http://www.sgs.com.tw/Terms-and-Conditions> and for electronic format documents, subject to Terms and Conditions for Electronic Documents at <http://www.sgs.com.tw/Terms-and-Conditions>. Attention is drawn to the limitation of liability, indemnification and jurisdiction issues defined therein. Any holder of this document is advised that information contained hereon reflects the Company's findings at the time of its intervention only and within the limits of Client's instructions, if any. The Company's sole responsibility is to its Client and this document does not exonerate parties to a transaction from exercising all their rights and obligations under the transaction documents. This document cannot be reproduced except in full, without prior written approval of the Company. Any unauthorized alteration, forgery or falsification of the content or appearance of this document is unlawful and offenders may be prosecuted to the fullest extent of the law.

Test Items	Band	Test Channel			Bandwidth (MHz)						Modulation			RB #		
		L	M	H	1.4	3	5	10	15	20	QPSK	16QAM	64QAM	1	Half	Full
Band Edge	2	v	-	v	v	v	v	v	v	v	v	-	-	v	v	v
	5	v	-	v	v	v	v	v	-	-	v	-	-	v	v	v
	7	v	-	v	-	-	v	v	v	v	v	-	-	v	v	v
	38	v	-	v	-	-	v	v	v	v	v	-	-	v	v	v
	41	v	-	v	-	-	v	v	v	v	v	-	-	v	v	v
Conducted Emission	2	v	v	v	v	v	v	v	v	v	v	-	-	v	-	-
	5	v	v	v	v	v	v	v	-	-	v	-	-	v	-	-
	7	v	v	v	-	-	v	v	v	v	v	-	-	v	-	-
	38	v	v	v	-	-	v	v	v	v	v	-	-	v	-	-
	41	v	v	v	-	-	v	v	v	v	v	-	-	v	-	-
Test Items	Band	Test Channel			Bandwidth (MHz)						Modulation			RB #		
		L	M	H	1.4	3	5	10	15	20	QPSK	16QAM	64QAM	1	Half	Full
Radiated Emission	2	v	v	v						v	v			v		
	5	v	v	v				v	-	-	v			v		
	7	v	v	v	-	-				v	v			v		
	38	v	v	v	-	-				v	v			v		
	41	v	v	v	-	-				v	v			v		

Unless otherwise stated the results shown in this test report refer only to the sample(s) tested and such sample(s) are retained for 90 days only.

除非另有說明，此報告結果僅對測試之樣品負責，同時此樣品僅保留90天。本報告未經本公司書面許可，不可部份複製。

This document is issued by the Company subject to its General Conditions of Service printed overleaf, available on request or accessible at <http://www.sgs.com.tw/Terms-and-Conditions> and for electronic format documents, subject to Terms and Conditions for Electronic Documents at <http://www.sgs.com.tw/Terms-and-Conditions>. Attention is drawn to the limitation of liability, indemnification and jurisdiction issues defined therein. Any holder of this document is advised that information contained hereon reflects the Company's findings at the time of its intervention only and within the limits of Client's instructions, if any. The Company's sole responsibility is to its Client and this document does not exonerate parties to a transaction from exercising all their rights and obligations under the transaction documents. This document cannot be reproduced except in full, without prior written approval of the Company. Any unauthorized alteration, forgery or falsification of the content or appearance of this document is unlawful and offenders may be prosecuted to the fullest extent of the law.

5 MEASUREMENT UNCERTAINTY

Test Items	Uncertainty
RF Power Output	+/- 1 dB
ERP/ EIRP measurement	Vertical Polarization = +/- 3dB Horizontal Polarization = +/- 3dB
99% Occupied Bandwidth	+/- 1.54 Hz
Out of Band Emissions at Antenna Terminals and Band Edge	+/- 1.69 dB
Peak to Average Ratio	+/- 1 dB
Frequency Stability vs. Temperature	+/- 1.54 Hz
Frequency Stability vs. Voltage	+/- 1.54 Hz
Temperature	+/- 0.4 °C
Humidity	+/- 3.5 %
DC / AC Power Source	DC= +/- 1%, AC= +/- 1%

Radiated Spurious Emission Measurement Uncertainty		
Polarization: Vertical	+/- 2.64 dB	9kHz~30MHz: +2.3dB
	+/- 4.93 dB	30MHz - 1000MHz: +/- 3.37dB
	+/- 4.81 dB	1GHz - 18GHz: +/- 4.04dB
	+/- 4.52 dB	18GHz - 40GHz: +/- 4.04dB
Polarization: Horizontal	+/- 2.64 dB	9kHz~30MHz: +2.3dB
	+/- 4.45 dB	30MHz - 1000MHz: +/- 4.22dB
	+/- 4.81 dB	1GHz - 18GHz: +/- 4.08dB
	+/- 4.52 dB	18GHz - 40GHz: +/- 4.08dB

This uncertainty represents an expanded uncertainty expressed at approximately the 95% confidence level using a coverage factor of k=2.

Unless otherwise stated the results shown in this test report refer only to the sample(s) tested and such sample(s) are retained for 90 days only.

除非另有說明，此報告結果僅對測試之樣品負責，同時此樣品僅保留90天。本報告未經本公司書面許可，不可部份複製。

This document is issued by the Company subject to its General Conditions of Service printed overleaf, available on request or accessible at <http://www.sgs.com.tw/Terms-and-Conditions> and for electronic format documents, subject to Terms and Conditions for Electronic Documents at <http://www.sgs.com.tw/Terms-and-Conditions>. Attention is drawn to the limitation of liability, indemnification and jurisdiction issues defined therein. Any holder of this document is advised that information contained hereon reflects the Company's findings at the time of its intervention only and within the limits of Client's instructions, if any. The Company's sole responsibility is to its Client and this document does not exonerate parties to a transaction from exercising all their rights and obligations under the transaction documents. This document cannot be reproduced except in full, without prior written approval of the Company. Any unauthorized alteration, forgery or falsification of the content or appearance of this document is unlawful and offenders may be prosecuted to the fullest extent of the law.

6 MAXMUM OUTPUT POWER

6.1 Standard Applicable

A base station simulator was used to establish communication with the EUT. Its parameters were set to transmit the maximum power on the EUT. The measured power in the radio frequency on the transmitter output terminals.

6.1.1 ERP/EIRP LIMIT

According to FCC §2.1046

FCC 22.913(a)

(5) mobile transmitters and auxiliary test transmitters must not exceed 7 watts.

FCC 24.232(c)

Mobile and portable stations are limited to 2 W EIRP.

FCC 27, 50(h)

(2) Mobile and other user stations transmitting in the BRS and EBS bands are limited to 2 W EIRP.

Unless otherwise stated the results shown in this test report refer only to the sample(s) tested and such sample(s) are retained for 90 days only.

除非另有說明，此報告結果僅對測試之樣品負責，同時此樣品僅保留90天。本報告未經本公司書面許可，不可部份複製。

This document is issued by the Company subject to its General Conditions of Service printed overleaf, available on request or accessible at <http://www.sgs.com.tw/Terms-and-Conditions> and for electronic format documents, subject to Terms and Conditions for Electronic Documents at <http://www.sgs.com.tw/Terms-and-Conditions>. Attention is drawn to the limitation of liability, indemnification and jurisdiction issues defined therein. Any holder of this document is advised that information contained hereon reflects the Company's findings at the time of its intervention only and within the limits of Client's instructions, if any. The Company's sole responsibility is to its Client and this document does not exonerate parties to a transaction from exercising all their rights and obligations under the transaction documents. This document cannot be reproduced except in full, without prior written approval of the Company. Any unauthorized alteration, forgery or falsification of the content or appearance of this document is unlawful and offenders may be prosecuted to the fullest extent of the law.

6.2 Test Set-up

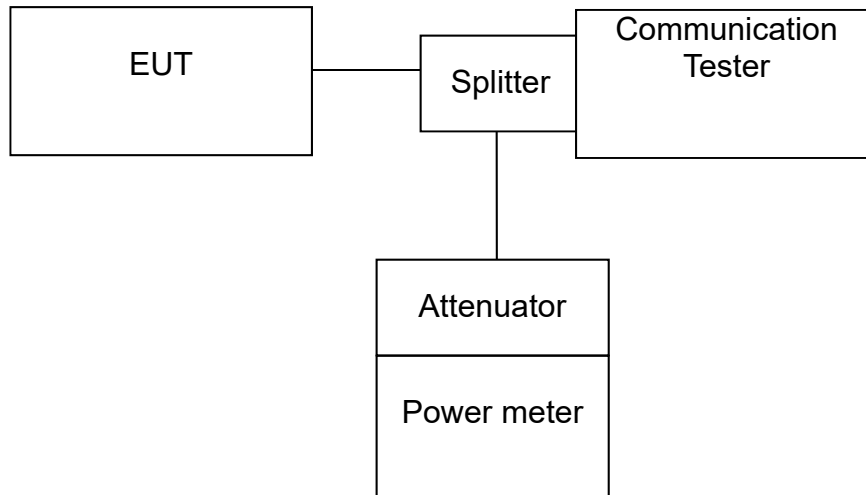

Note: Measurement setup for testing on Antenna connector

6.3 Output Power Measurement Applicable Guidance

The transmitter output was connected to a calibrated attenuator, the other end of which was connected to a power meter. Transmitter output was read off the power meter in dBm. The power output at the transmitter antenna port was determined by adding the value of the attenuator to the power meter reading. TS 151 010-1 is reference to conduct the test measurement of output power.

The Procedure of KDB941225 (SAR Measurement Procedures for 3G devices, (WCDMA/HSPA) was used for EUT and Base station setting. RMC 12.2kps is used for this testing, and KDB 971168 D01 Power Meas License Digital System as the supplemental test methodology to adjust the proper setting obtaining the measurement results.

All LTE bands conducted average power is obtained from the simulator telecommunication test set.

Unless otherwise stated the results shown in this test report refer only to the sample(s) tested and such sample(s) are retained for 90 days only.

除非另有說明，此報告結果僅對測試之樣品負責，同時此樣品僅保留90天。本報告未經本公司書面許可，不可部份複製。

This document is issued by the Company subject to its General Conditions of Service printed overleaf, available on request or accessible at <http://www.sgs.com.tw/Terms-and-Conditions> and for electronic format documents, subject to Terms and Conditions for Electronic Documents at <http://www.sgs.com.tw/Terms-and-Conditions>. Attention is drawn to the limitation of liability, indemnification and jurisdiction issues defined therein. Any holder of this document is advised that information contained hereon reflects the Company's findings at the time of its intervention only and within the limits of Client's instructions, if any. The Company's sole responsibility is to its Client and this document does not exonerate parties to a transaction from exercising all their rights and obligations under the transaction documents. This document cannot be reproduced except in full, without prior written approval of the Company. Any unauthorized alteration, forgery or falsification of the content or appearance of this document is unlawful and offenders may be prosecuted to the fullest extent of the law.

6.4 Determining ERP and/or EIRP from conducted RF output power measurements

According to KDB 412172 D01 Power Approach,

$$EIRP = P_T + G_T - L_C,$$

$$ERP = EIRP - 2.15,$$

Where:

- ERP or EIRP = effective radiated power or equivalent isotropically radiated power (expressed in the same units as P_T , typically dBW, dBm, or power spectral density (PSD)²), relative to either a dipole antenna (ERP) or an isotropic antenna (EIRP);
- P_T = transmitter output power, expressed in dBW, dBm, or PSD;
- G_T = gain of the transmitting antenna, in dBd (ERP) or dBi (EIRP);
- L_C = signal attenuation in the connecting cable between the transmitter and antenna, in dB.

6.5 Measurement Equipment Used

Conducted Emission (measured at antenna port) Test Site					
EQUIPMENT TYPE	MFR	MODEL NUMBER	SERIAL NUMBER	LAST CAL.	CAL DUE.
DC Power Supply	Agilent	E3640A	KR93300208	08/19/2020	08/18/2021
Radio Communication Analyser	Anritsu	MT8815B	6200711454	04/01/2020	03/31/2021
Attenuator	Mini-Circuit	BW-S10W2+	2	01/02/2020	01/01/2021
Radio Communication Analyser	Anritsu	MT8821C	6261786084	01/18/2020	01/17/2021

Unless otherwise stated the results shown in this test report refer only to the sample(s) tested and such sample(s) are retained for 90 days only.

除非另有說明，此報告結果僅對測試之樣品負責，同時此樣品僅保留90天。本報告未經本公司書面許可，不可部份複製。

This document is issued by the Company subject to its General Conditions of Service printed overleaf, available on request or accessible at <http://www.sgs.com.tw/Terms-and-Conditions> and for electronic format documents, subject to Terms and Conditions for Electronic Documents at <http://www.sgs.com.tw/Terms-and-Conditions>. Attention is drawn to the limitation of liability, indemnification and jurisdiction issues defined therein. Any holder of this document is advised that information contained hereon reflects the Company's findings at the time of its intervention only and within the limits of Client's instructions, if any. The Company's sole responsibility is to its Client and this document does not exonerate parties to a transaction from exercising all their rights and obligations under the transaction documents. This document cannot be reproduced except in full, without prior written approval of the Company. Any unauthorized alteration, forgery or falsification of the content or appearance of this document is unlawful and offenders may be prosecuted to the fullest extent of the law.

6.6 GSM Measurement Results

GSM/GPRS (GMSK; 8-PSK) Result:

EUT Mode	Freq. (MHz)	CH	Conducted Avg. Power (dBm)	Antenna Gain (dBi)	ERP (dBm)	EIRP (dBm)	Limit (dBm)	Margin (dB)
GSM 850	824.2	128	32.40	-4.20	26.05	28.20	38.50	-10.30
	836.6	190	32.42	-4.20	26.07	28.22	38.50	-10.28
	848.8	251	32.30	-4.20	25.95	28.10	38.50	-10.40
GSM 1900	1850.2	512	29.75	-2.30	25.30	27.45	33.00	-5.55
	1880.0	661	29.70	-2.30	25.25	27.40	33.00	-5.60
	1909.8	810	29.68	-2.30	25.23	27.38	33.00	-5.62
GPRS 850	824.2	128	32.36	-4.20	26.01	28.16	38.50	-10.34
	836.6	190	32.38	-4.20	26.03	28.18	38.50	-10.32
	848.8	251	32.28	-4.20	25.93	28.08	38.50	-10.42
GPRS 1900	1850.2	512	29.72	-2.30	25.27	27.42	33.00	-5.58
	1880.0	661	29.67	-2.30	25.22	27.37	33.00	-5.63
	1909.8	810	29.65	-2.30	25.20	27.35	33.00	-5.65

EUT Mode	Frequency (MHz)	CH	Average Burst Power (1DN 1UP) Class 8 (dBm)	Average Burst Power (1DN 2UP) Class 10 (dBm)	Average Burst Power (1DN 3UP) Class 12 (dBm)	Average Burst Power (1DN 4UP) Class 12 (dBm)
GPRS 850	824.2	128	32.36	30.03	28.34	26.90
	836.6	190	32.38	30.12	28.38	26.92
	848.8	251	32.28	30.10	28.33	27.82
GPRS 1900	1850.2	512	29.72	26.79	24.93	24.40
	1880.0	661	29.67	26.78	24.90	24.46
	1909.8	810	29.65	26.99	25.13	24.63

Unless otherwise stated the results shown in this test report refer only to the sample(s) tested and such sample(s) are retained for 90 days only.

除非另有說明，此報告結果僅對測試之樣品負責，同時此樣品僅保留90天。本報告未經本公司書面許可，不可部份複製。

This document is issued by the Company subject to its General Conditions of Service printed overleaf, available on request or accessible at <http://www.sgs.com.tw/Terms-and-Conditions> and for electronic format documents, subject to Terms and Conditions for Electronic Documents at <http://www.sgs.com.tw/Terms-and-Conditions>. Attention is drawn to the limitation of liability, indemnification and jurisdiction issues defined therein. Any holder of this document is advised that information contained hereon reflects the Company's findings at the time of its intervention only and within the limits of Client's instructions, if any. The Company's sole responsibility is to its Client and this document does not exonerate parties to a transaction from exercising all their rights and obligations under the transaction documents. This document cannot be reproduced except in full, without prior written approval of the Company. Any unauthorized alteration, forgery or falsification of the content or appearance of this document is unlawful and offenders may be prosecuted to the fullest extent of the law.

6.7 WCDMA & HSPA Measurement Results:

The following tests were completed according to the test requirements outlined in section 5.2 of the 3GPP TS34.121-1 specification. The EUT supports power Class 3, which has a nominal maximum output power of **25 dBm**. RMC 12.2kps is used for this testing.

WCDMA/HSUPA/HSDPA Band II Result:

EUT Mode	Freq. (MHz)	CH	Conducted Avg. Power (dBm)	Antenna Gain (dBi)	ERP (dBm)	EIRP (dBm)	Limit (dBm)	Margin (dB)
WCDMA	1852.4	9262	22.90	-2.30	18.45	20.60	33.00	-12.40
	1880.0	9400	22.95	-2.30	18.50	20.65	33.00	-12.35
	1907.6	9538	23.08	-2.30	18.63	20.78	33.00	-12.22
HSDPA	1852.4	9262	21.93	-2.30	17.48	19.63	33.00	-13.37
	1880.0	9400	21.94	-2.30	17.49	19.64	33.00	-13.36
	1907.6	9538	22.15	-2.30	17.70	19.85	33.00	-13.15
HSUPA	1852.4	9262	21.86	-2.30	17.41	19.56	33.00	-13.44
	1880.0	9400	21.87	-2.30	17.42	19.57	33.00	-13.43
	1907.6	9538	22.09	-2.30	17.64	19.79	33.00	-13.21

WCDMA/HSUPA/HSDPA Band V Result:

EUT Mode	Freq. (MHz)	CH	Conducted Avg. Power (dBm)	Antenna Gain (dBi)	ERP (dBm)	EIRP (dBm)	Limit (dBm)	Margin (dB)
WCDMA	826.4	4132	24.55	-4.20	18.20	20.35	38.50	-18.15
	836.6	4183	24.59	-4.20	18.24	20.39	38.50	-18.11
	846.6	4233	24.53	-4.20	18.18	20.33	38.50	-18.17
HSDPA	826.4	4132	23.62	-4.20	17.27	19.42	38.50	-19.08
	836.6	4183	23.62	-4.20	17.27	19.42	38.50	-19.08
	846.6	4233	23.56	-4.20	17.21	19.36	38.50	-19.14
HSUPA	826.4	4132	23.60	-4.20	17.25	19.40	38.50	-19.10
	836.6	4183	23.60	-4.20	17.25	19.40	38.50	-19.10
	846.6	4233	23.56	-4.20	17.21	19.36	38.50	-19.14

Unless otherwise stated the results shown in this test report refer only to the sample(s) tested and such sample(s) are retained for 90 days only.

除非另有說明，此報告結果僅對測試之樣品負責，同時此樣品僅保留90天。本報告未經本公司書面許可，不可部份複製。

This document is issued by the Company subject to its General Conditions of Service printed overleaf, available on request or accessible at <http://www.sgs.com.tw/Terms-and-Conditions> and for electronic format documents, subject to Terms and Conditions for Electronic Documents at <http://www.sgs.com.tw/Terms-and-Conditions>. Attention is drawn to the limitation of liability, indemnification and jurisdiction issues defined therein. Any holder of this document is advised that information contained hereon reflects the Company's findings at the time of its intervention only and within the limits of Client's instructions, if any. The Company's sole responsibility is to its Client and this document does not exonerate parties to a transaction from exercising all their rights and obligations under the transaction documents. This document cannot be reproduced except in full, without prior written approval of the Company. Any unauthorized alteration, forgery or falsification of the content or appearance of this document is unlawful and offenders may be prosecuted to the fullest extent of the law.

6.7.1 HSPA (HSDPA & HSUPA) Release 6:

The following 4 Sub-Tests were completed according to the test requirements outlined in section 5.2A of the 3GPP TS34.121-1 specification. All TX RMS power requirements for Power Class 3 were met according to table 5.2AA.5 and 5.2B.5 All UE channels and power ratio's are set according to table C10.1.4 & C11.1.3 in the 3GPP TS34.121-1. RMC 12.2kps is used for this testing.

6.7.2 HSDPA SUB-TEST Setting

Table C.10.1.4: β values for transmitter characteristics tests with HS-DPCCH(FOR HSDPA)

Sub-test	β_c	β_d	β_d (SF)	β_c/β_d	β_{HS} (Note 1, Note 2)	CM (dB) (Note 3)	MPR (dB) (Note 3)	RMC (Kbps)
1	2/15	15/15	64	2/15	4/15	0.0	0.0	12.2
2	12/15 (Note 4)	15/15 (Note 4)	64	12/15 (Note 4)	24/15	1.0	0.0	12.2
3	15/15	8/15	64	15/8	30/15	1.5	0.5	12.2
4	15/15	4/15	64	15/4	30/15	1.5	0.5	12.2

Note: The recommended HSDPA MPRs are implemented as per following sub-tests.

Mode	Sub test	Avg. Power (dBm) Channel		
		9262.00	9400.00	9538.00
HSDPA II	1	21.93	21.94	22.15
	2	21.39	21.44	21.64
	3	21.45	21.46	21.67
	4	21.40	21.44	21.58

Mode	Sub test	Avg. Power (dBm) Channel		
		4132.00	4183.00	4233.00
HSDPA V	1	23.62	23.62	23.56
	2	23.06	23.10	23.06
	3	23.09	23.08	23.04
	4	23.08	23.11	23.09

Unless otherwise stated the results shown in this test report refer only to the sample(s) tested and such sample(s) are retained for 90 days only.

除非另有說明，此報告結果僅對測試之樣品負責，同時此樣品僅保留90天。本報告未經本公司書面許可，不可部份複製。

This document is issued by the Company subject to its General Conditions of Service printed overleaf, available on request or accessible at <http://www.sgs.com.tw/Terms-and-Conditions> and for electronic format documents, subject to Terms and Conditions for Electronic Documents at <http://www.sgs.com.tw/Terms-and-Conditions>. Attention is drawn to the limitation of liability, indemnification and jurisdiction issues defined therein. Any holder of this document is advised that information contained hereon reflects the Company's findings at the time of its intervention only and within the limits of Client's instructions, if any. The Company's sole responsibility is to its Client and this document does not exonerate parties to a transaction from exercising all their rights and obligations under the transaction documents. This document cannot be reproduced except in full, without prior written approval of the Company. Any unauthorized alteration, forgery or falsification of the content or appearance of this document is unlawful and offenders may be prosecuted to the fullest extent of the law.

6.7.3 HSPA SUB-TEST Setting

Table C.11.1.3: β values for transmitter characteristics tests with HS-DPCCH and E-DCH(FOR HSUPA)

Sub-test	β_c	β_d	β_d (SF)	β_c/β_d	β_{HS}	β_{ec}	β_{ed}	β_{ed} (SF)	β_{ed} (Code s)	CM (dB)	MPR (dB)	AG Index	E-TFCI	RMC (Kbps)
1	11/15 (Note 3)	15/15 (Note 3)	64	11/15 (Note 3)	22/15	209/225	1309/225	4	1	1.0	0.0	20	75	12.2
2	6/15	15/15	64	6/15	12/15	12/15	94/75	4	1	3.0	2.0	12	67	12.2
3	15/15	9/15	64	15/9	30/15	30/15	β_{ed1} : 47/15 β_{ed2} : 47/15	4 4	2	2.0	1.0	15	92	12.2
4	2/15	15/15	64	2/15	4/15	2/15	56/75	4	1	3.0	2.0	17	71	12.2
5	15/15 (Note 4)	15/15 (Note 4)	64	15/15 (Note 4)	30/15	24/15	134/15	4	1	1.0	0.0	21	81	12.2

Note: The recommended HSUPA MPRs are implemented as per following sub-tests.

Mode	Sub test	Avg. Power (dBm) Channel		
		9262.00	9400.00	9538.00
HSUPA II	1	21.86	21.87	22.09
	2	19.88	19.89	20.03
	3	20.84	20.92	21.05
	4	19.87	19.90	20.06
	5	21.89	21.91	20.38

Mode	Sub test	Avg. Power (dBm) Channel		
		4132.00	4183.00	4233.00
HSUPA V	1	23.60	23.60	23.56
	2	21.56	21.60	21.52
	3	22.59	22.57	22.52
	4	21.55	21.58	21.54
	5	23.57	23.60	23.56

6.7.4 WCDMA/HSDPA/HSUPA band II, IV, V

The EUT output power was controlled by simulator and enter max rated power 24dBm. The EUT is going to be set to max output power to 24dBm then record the read. The min. power was measures by a function key "minimum power" then record the read. It is -52.3dBm. The power variation can be 0.1dB step by setting.

Unless otherwise stated the results shown in this test report refer only to the sample(s) tested and such sample(s) are retained for 90 days only.

除非另有說明，此報告結果僅對測試之樣品負責，同時此樣品僅保留90天。本報告未經本公司書面許可，不可部份複製。

This document is issued by the Company subject to its General Conditions of Service printed overleaf, available on request or accessible at <http://www.sgs.com.tw/Terms-and-Conditions> and for electronic format documents, subject to Terms and Conditions for Electronic Documents at <http://www.sgs.com.tw/Terms-and-Conditions>. Attention is drawn to the limitation of liability, indemnification and jurisdiction issues defined therein. Any holder of this document is advised that information contained hereon reflects the Company's findings at the time of its intervention only and within the limits of Client's instructions, if any. The Company's sole responsibility is to its Client and this document does not exonerate parties to a transaction from exercising all their rights and obligations under the transaction documents. This document cannot be reproduced except in full, without prior written approval of the Company. Any unauthorized alteration, forgery or falsification of the content or appearance of this document is unlawful and offenders may be prosecuted to the fullest extent of the law.

6.8 LTE Measurement Results:

Antenna gain (dBi)		-2.3							
LTE Band 2_Uplink frequency band : 1850 to 1910 MHz									
BW (MHz)	UL Channel	Frequency (MHz)	Modulation	RB Size	RB Offset	Conducted Average (dBm)	EIRP Average (dBm)	EIRP Limit (dBm)	Margin (dB)
1.4	18607	1850.7	QPSK	1	0	21.89	19.59	33	-13.41
				1	5	21.88	19.58	33	-13.42
				3	2	22.07	19.77	33	-13.23
				6	0	21.04	18.74	33	-14.26
	18900	1880	QPSK	1	0	21.86	19.56	33	-13.44
				1	5	21.89	19.59	33	-13.41
				3	2	21.91	19.61	33	-13.39
				6	0	21.03	18.73	33	-14.27
	19193	1909.3	QPSK	1	0	22.02	19.72	33	-13.28
				1	5	22.02	19.72	33	-13.28
				3	2	22.11	19.81	33	-13.19
				6	0	21.13	18.83	33	-14.17
	18607	1850.7	16QAM	1	0	21.63	19.33	33	-13.67
				1	5	21.00	18.70	33	-14.3
				3	2	21.14	18.84	33	-14.16
				6	0	20.21	17.91	33	-15.09
	18900	1880	16QAM	1	0	21.47	19.17	33	-13.83
				1	5	21.46	19.16	33	-13.84
				3	2	21.03	18.73	33	-14.27
				6	0	20.00	17.70	33	-15.3
	19193	1909.3	16QAM	1	0	21.08	18.78	33	-14.22
				1	5	21.37	19.07	33	-13.93
				3	2	21.29	18.99	33	-14.01
				6	0	20.19	17.89	33	-15.11
	18607	1850.7	64QAM	1	0	20.05	17.75	33	-15.25
				1	5	20.32	18.02	33	-14.98
				3	2	20.38	18.08	33	-14.92
	18900	1880	64QAM	1	0	19.98	17.68	33	-15.32
				1	5	20.04	17.74	33	-15.26
				1	5	20.10	17.80	33	-15.2
	19193	1909.3	64QAM	3	2	20.02	17.72	33	-15.28
				6	0	19.99	17.69	33	-15.31
				1	0	20.02	17.72	33	-15.28
	18607	1850.7	64QAM	1	5	20.87	18.57	33	-14.43
				3	2	20.16	17.86	33	-15.14
				6	0	19.98	17.68	33	-15.32

Unless otherwise stated the results shown in this test report refer only to the sample(s) tested and such sample(s) are retained for 90 days only.

除非另有說明，此報告結果僅對測試之樣品負責，同時此樣品僅保留90天。本報告未經本公司書面許可，不可部份複製。

This document is issued by the Company subject to its General Conditions of Service printed overleaf, available on request or accessible at <http://www.sgs.com.tw/Terms-and-Conditions> and for electronic format documents, subject to Terms and Conditions for Electronic Documents at <http://www.sgs.com.tw/Terms-and-Conditions>. Attention is drawn to the limitation of liability, indemnification and jurisdiction issues defined therein. Any holder of this document is advised that information contained hereon reflects the Company's findings at the time of its intervention only and within the limits of Client's instructions, if any. The Company's sole responsibility is to its Client and this document does not exonerate parties to a transaction from exercising all their rights and obligations under the transaction documents. This document cannot be reproduced except in full, without prior written approval of the Company. Any unauthorized alteration, forgery or falsification of the content or appearance of this document is unlawful and offenders may be prosecuted to the fullest extent of the law.

Antenna gain (dBi)		-2.3							
LTE Band 2_Uplink frequency band : 1850 to 1910 MHz									
BW (MHz)	UL Channel	Frequency (MHz)	Modulation	RB Size	RB Offset	Conducted Average (dBm)	EIRP Average (dBm)	EIRP Limit (dBm)	Margin (dB)
3	18615	1851.5	QPSK	1	0	21.78	19.48	33	-13.52
				1	14	21.81	19.51	33	-13.49
				8	4	21.07	18.77	33	-14.23
				15	0	21.03	18.73	33	-14.27
	18900	1880	QPSK	1	0	21.98	19.68	33	-13.32
				1	14	22.09	19.79	33	-13.21
				8	4	21.11	18.81	33	-14.19
				15	0	21.06	18.76	33	-14.24
	19185	1908.5	QPSK	1	0	21.95	19.65	33	-13.35
				1	14	22.17	19.87	33	-13.13
				8	4	20.98	18.68	33	-14.32
				15	0	21.03	18.73	33	-14.27
	18615	1851.5	16QAM	1	0	21.04	18.74	33	-14.26
				1	14	21.03	18.73	33	-14.27
				8	4	19.96	17.66	33	-15.34
				15	0	19.90	17.60	33	-15.4
	18900	1880	16QAM	1	0	21.04	18.74	33	-14.26
				1	14	21.11	18.81	33	-14.19
				8	4	20.16	17.86	33	-15.14
				15	0	20.10	17.80	33	-15.2
	19185	1908.5	16QAM	1	0	21.11	18.81	33	-14.19
				1	14	21.17	18.87	33	-14.13
				8	4	20.07	17.77	33	-15.23
				15	0	20.02	17.72	33	-15.28
	18615	1851.5	64QAM	1	0	20.56	18.26	33	-14.74
				1	14	19.97	17.67	33	-15.33
				8	4	18.98	16.68	33	-16.32
				15	0	19.15	16.85	33	-16.15
	18900	1880	64QAM	1	0	20.03	17.73	33	-15.27
				1	14	20.35	18.05	33	-14.95
				8	4	19.16	16.86	33	-16.14
				15	0	18.98	16.68	33	-16.32
	19185	1908.5	64QAM	1	0	20.29	17.99	33	-15.01
				1	14	20.29	17.99	33	-15.01
				8	4	19.35	17.05	33	-15.95
				15	0	19.36	17.06	33	-15.94

Unless otherwise stated the results shown in this test report refer only to the sample(s) tested and such sample(s) are retained for 90 days only.

除非另有說明，此報告結果僅對測試之樣品負責，同時此樣品僅保留90天。本報告未經本公司書面許可，不可部份複製。

This document is issued by the Company subject to its General Conditions of Service printed overleaf, available on request or accessible at <http://www.sgs.com.tw/Terms-and-Conditions> and for electronic format documents, subject to Terms and Conditions for Electronic Documents at <http://www.sgs.com.tw/Terms-and-Conditions>. Attention is drawn to the limitation of liability, indemnification and jurisdiction issues defined therein. Any holder of this document is advised that information contained hereon reflects the Company's findings at the time of its intervention only and within the limits of Client's instructions, if any. The Company's sole responsibility is to its Client and this document does not exonerate parties to a transaction from exercising all their rights and obligations under the transaction documents. This document cannot be reproduced except in full, without prior written approval of the Company. Any unauthorized alteration, forgery or falsification of the content or appearance of this document is unlawful and offenders may be prosecuted to the fullest extent of the law.

Antenna gain (dBi)		-2.3							
LTE Band 2_Uplink frequency band : 1850 to 1910 MHz									
BW (MHz)	UL Channel	Frequency (MHz)	Modulation	RB Size	RB Offset	Conducted Average (dBm)	EIRP Average (dBm)	EIRP Limit (dBm)	Margin (dB)
5	18625	1852.5	QPSK	1	0	21.85	19.55	33	-13.45
				1	24	21.88	19.58	33	-13.42
				12	6	21.08	18.78	33	-14.22
				25	0	21.08	18.78	33	-14.22
	18900	1880	QPSK	1	0	21.99	19.69	33	-13.31
				1	24	22.15	19.85	33	-13.15
				12	6	21.14	18.84	33	-14.16
				25	0	21.06	18.76	33	-14.24
	19175	1907.5	QPSK	1	0	21.97	19.67	33	-13.33
				1	24	22.25	19.95	33	-13.05
				12	6	21.06	18.76	33	-14.24
				25	0	21.09	18.79	33	-14.21
	18625	1852.5	16QAM	1	0	21.05	18.75	33	-14.25
				1	24	21.05	18.75	33	-14.25
				12	6	20.03	17.73	33	-15.27
				25	0	19.99	17.69	33	-15.31
	18900	1880	16QAM	1	0	21.13	18.83	33	-14.17
				1	24	21.19	18.89	33	-14.11
				12	6	20.19	17.89	33	-15.11
				25	0	20.19	17.89	33	-15.11
	19175	1907.5	16QAM	1	0	21.16	18.86	33	-14.14
				1	24	21.22	18.92	33	-14.08
				12	6	20.14	17.84	33	-15.16
				25	0	20.11	17.81	33	-15.19
	18625	1852.5	64QAM	1	0	20.56	18.26	33	-14.74
				1	24	20.13	17.83	33	-15.17
				12	6	19.15	16.85	33	-16.15
				25	0	19.09	16.79	33	-16.21
	18900	1880	64QAM	1	0	19.98	17.68	33	-15.32
				1	24	20.32	18.02	33	-14.98
				12	6	19.34	17.04	33	-15.96
				25	0	19.06	16.76	33	-16.24
	19175	1907.5	64QAM	1	0	20.03	17.73	33	-15.27
				1	24	20.01	17.71	33	-15.29
				12	6	19.31	17.01	33	-15.99
				25	0	19.28	16.98	33	-16.02

Unless otherwise stated the results shown in this test report refer only to the sample(s) tested and such sample(s) are retained for 90 days only.

除非另有說明，此報告結果僅對測試之樣品負責，同時此樣品僅保留90天。本報告未經本公司書面許可，不可部份複製。

This document is issued by the Company subject to its General Conditions of Service printed overleaf, available on request or accessible at <http://www.sgs.com.tw/Terms-and-Conditions> and for electronic format documents, subject to Terms and Conditions for Electronic Documents at <http://www.sgs.com.tw/Terms-and-Conditions>. Attention is drawn to the limitation of liability, indemnification and jurisdiction issues defined therein. Any holder of this document is advised that information contained hereon reflects the Company's findings at the time of its intervention only and within the limits of Client's instructions, if any. The Company's sole responsibility is to its Client and this document does not exonerate parties to a transaction from exercising all their rights and obligations under the transaction documents. This document cannot be reproduced except in full, without prior written approval of the Company. Any unauthorized alteration, forgery or falsification of the content or appearance of this document is unlawful and offenders may be prosecuted to the fullest extent of the law.

Antenna gain (dBi)									
-2.3									
LTE Band 2_Uplink frequency band : 1850 to 1910 MHz									
BW (MHz)	UL Channel	Frequency (MHz)	Modulation	RB Size	RB Offset	Conducted Average (dBm)	EIRP Average (dBm)	EIRP Limit (dBm)	Margin (dB)
10	18650	1855	QPSK	1	0	22.06	19.76	33	-13.24
				1	49	22.00	19.70	33	-13.3
				25	12	21.16	18.86	33	-14.14
				50	0	21.24	18.94	33	-14.06
	18900	1880	QPSK	1	0	22.20	19.90	33	-13.1
				1	49	22.22	19.92	33	-13.08
				25	12	21.35	19.05	33	-13.95
				50	0	21.21	18.91	33	-14.09
	19150	1905	QPSK	1	0	22.17	19.87	33	-13.13
				1	49	22.35	20.05	33	-12.95
				25	12	21.22	18.92	33	-14.08
				50	0	21.24	18.94	33	-14.06
	18650	1855	16QAM	1	0	21.13	18.83	33	-14.17
				1	49	21.22	18.92	33	-14.08
				25	12	20.23	17.93	33	-15.07
				50	0	20.15	17.85	33	-15.15
	18900	1880	16QAM	1	0	21.24	18.94	33	-14.06
				1	49	21.31	19.01	33	-13.99
				25	12	20.33	18.03	33	-14.97
				50	0	20.30	18.00	33	-15
	19150	1905	16QAM	1	0	21.40	19.10	33	-13.9
				1	49	21.42	19.12	33	-13.88
				25	12	20.22	17.92	33	-15.08
				50	0	20.19	17.89	33	-15.11
	18650	1855	64QAM	1	0	20.77	18.47	33	-14.53
				1	49	19.96	17.66	33	-15.34
				25	12	19.21	16.91	33	-16.09
				50	0	19.15	16.85	33	-16.15
	18900	1880	64QAM	1	0	20.07	17.77	33	-15.23
				1	49	20.40	18.10	33	-14.9
				25	12	19.06	16.76	33	-16.24
				50	0	18.95	16.65	33	-16.35
	19150	1905	64QAM	1	0	19.99	17.69	33	-15.31
				1	49	20.16	17.86	33	-15.14
				25	12	19.21	16.91	33	-16.09
				50	0	19.33	17.03	33	-15.97

Unless otherwise stated the results shown in this test report refer only to the sample(s) tested and such sample(s) are retained for 90 days only.

除非另有說明，此報告結果僅對測試之樣品負責，同時此樣品僅保留90天。本報告未經本公司書面許可，不可部份複製。

This document is issued by the Company subject to its General Conditions of Service printed overleaf, available on request or accessible at <http://www.sgs.com.tw/Terms-and-Conditions> and for electronic format documents, subject to Terms and Conditions for Electronic Documents at <http://www.sgs.com.tw/Terms-and-Conditions>. Attention is drawn to the limitation of liability, indemnification and jurisdiction issues defined therein. Any holder of this document is advised that information contained hereon reflects the Company's findings at the time of its intervention only and within the limits of Client's instructions, if any. The Company's sole responsibility is to its Client and this document does not exonerate parties to a transaction from exercising all their rights and obligations under the transaction documents. This document cannot be reproduced except in full, without prior written approval of the Company. Any unauthorized alteration, forgery or falsification of the content or appearance of this document is unlawful and offenders may be prosecuted to the fullest extent of the law.

Antenna gain (dBi)		-2.3							
LTE Band 2_Uplink frequency band : 1850 to 1910 MHz									
BW (MHz)	UL Channel	Frequency (MHz)	Modulation	RB Size	RB Offset	Conducted Average (dBm)	EIRP Average (dBm)	EIRP Limit (dBm)	Margin (dB)
15	18675	1857.5	QPSK	1	0	22.06	19.76	33	-13.24
				1	74	22.09	19.79	33	-13.21
				36	18	21.26	18.96	33	-14.04
				75	0	21.26	18.96	33	-14.04
	18900	1880	QPSK	1	0	22.29	19.99	33	-13.01
				1	74	22.31	20.01	33	-12.99
				36	18	21.36	19.06	33	-13.94
				75	0	21.28	18.98	33	-14.02
	19125	1902.5	QPSK	1	0	22.20	19.90	33	-13.1
				1	74	22.38	20.08	33	-12.92
				36	18	21.30	19.00	33	-14
				75	0	21.32	19.02	33	-13.98
	18675	1857.5	16QAM	1	0	21.22	18.92	33	-14.08
				1	74	21.23	18.93	33	-14.07
				36	18	20.26	17.96	33	-15.04
				75	0	20.20	17.90	33	-15.1
	18900	1880	16QAM	1	0	21.31	19.01	33	-13.99
				1	74	21.36	19.06	33	-13.94
				36	18	20.39	18.09	33	-14.91
				75	0	20.33	18.03	33	-14.97
	19125	1902.5	16QAM	1	0	21.40	19.10	33	-13.9
				1	74	21.49	19.19	33	-13.81
				36	18	20.30	18.00	33	-15
				75	0	20.28	17.98	33	-15.02
	18675	1857.5	64QAM	1	0	20.62	18.32	33	-14.68
				1	74	19.96	17.66	33	-15.34
				36	18	19.10	16.80	33	-16.2
				75	0	19.08	16.78	33	-16.22
	18900	1880	64QAM	1	0	19.99	17.69	33	-15.31
				1	74	20.56	18.26	33	-14.74
				36	18	19.03	16.73	33	-16.27
				75	0	19.32	17.02	33	-15.98
	19125	1902.5	64QAM	1	0	20.07	17.77	33	-15.23
				1	74	20.09	17.79	33	-15.21
				36	18	19.28	16.98	33	-16.02
				75	0	19.31	17.01	33	-15.99

Unless otherwise stated the results shown in this test report refer only to the sample(s) tested and such sample(s) are retained for 90 days only.

除非另有說明，此報告結果僅對測試之樣品負責，同時此樣品僅保留90天。本報告未經本公司書面許可，不可部份複製。

This document is issued by the Company subject to its General Conditions of Service printed overleaf, available on request or accessible at <http://www.sgs.com.tw/Terms-and-Conditions> and for electronic format documents, subject to Terms and Conditions for Electronic Documents at <http://www.sgs.com.tw/Terms-and-Conditions>. Attention is drawn to the limitation of liability, indemnification and jurisdiction issues defined therein. Any holder of this document is advised that information contained hereon reflects the Company's findings at the time of its intervention only and within the limits of Client's instructions, if any. The Company's sole responsibility is to its Client and this document does not exonerate parties to a transaction from exercising all their rights and obligations under the transaction documents. This document cannot be reproduced except in full, without prior written approval of the Company. Any unauthorized alteration, forgery or falsification of the content or appearance of this document is unlawful and offenders may be prosecuted to the fullest extent of the law.

Antenna gain (dBi)		-2.3							
LTE Band 2_Uplink frequency band : 1850 to 1910 MHz									
BW (MHz)	UL Channel	Frequency (MHz)	Modulation	RB Size	RB Offset	Conducted Average (dBm)	EIRP Average (dBm)	EIRP Limit (dBm)	Margin (dB)
20	18700	1860	QPSK	1	0	22.34	20.04	33	-12.96
				1	99	22.16	19.86	33	-13.14
				50	25	21.37	19.07	33	-13.93
				100	0	21.48	19.18	33	-13.82
	18900	1880	QPSK	1	0	22.17	19.87	33	-13.13
				1	99	22.45	20.15	33	-12.85
				50	25	21.34	19.04	33	-13.96
				100	0	21.39	19.09	33	-13.91
	19100	1900	QPSK	1	0	22.29	19.99	33	-13.01
				1	99	22.49	20.19	33	-12.81
				50	25	21.46	19.16	33	-13.84
				100	0	21.59	19.29	33	-13.71
	18700	1860	16QAM	1	0	21.84	19.54	33	-13.46
				1	99	21.29	18.99	33	-14.01
				50	25	20.27	17.97	33	-15.03
				100	0	20.40	18.10	33	-14.9
	18900	1880	16QAM	1	0	21.23	18.93	33	-14.07
				1	99	21.57	19.27	33	-13.73
				50	25	20.35	18.05	33	-14.95
				100	0	20.34	18.04	33	-14.96
	19100	1900	16QAM	1	0	21.32	19.02	33	-13.98
				1	99	21.31	19.01	33	-13.99
				50	25	20.51	18.21	33	-14.79
				100	0	20.45	18.15	33	-14.85
	18700	1860	64QAM	1	0	20.74	18.44	33	-14.56
				1	99	19.94	17.64	33	-15.36
				50	25	18.92	16.62	33	-16.38
				100	0	19.26	16.96	33	-16.04
	18900	1880	64QAM	1	0	19.87	17.57	33	-15.43
				1	99	20.50	18.20	33	-14.8
				50	25	19.32	17.02	33	-15.98
				100	0	19.07	16.77	33	-16.23
	19100	1900	64QAM	1	0	20.31	18.01	33	-14.99
				1	99	20.26	17.96	33	-15.04
				50	25	19.36	17.06	33	-15.94
				100	0	19.12	16.82	33	-16.18

Unless otherwise stated the results shown in this test report refer only to the sample(s) tested and such sample(s) are retained for 90 days only.

除非另有說明，此報告結果僅對測試之樣品負責，同時此樣品僅保留90天。本報告未經本公司書面許可，不可部份複製。

This document is issued by the Company subject to its General Conditions of Service printed overleaf, available on request or accessible at <http://www.sgs.com.tw/Terms-and-Conditions> and for electronic format documents, subject to Terms and Conditions for Electronic Documents at <http://www.sgs.com.tw/Terms-and-Conditions>. Attention is drawn to the limitation of liability, indemnification and jurisdiction issues defined therein. Any holder of this document is advised that information contained hereon reflects the Company's findings at the time of its intervention only and within the limits of Client's instructions, if any. The Company's sole responsibility is to its Client and this document does not exonerate parties to a transaction from exercising all their rights and obligations under the transaction documents. This document cannot be reproduced except in full, without prior written approval of the Company. Any unauthorized alteration, forgery or falsification of the content or appearance of this document is unlawful and offenders may be prosecuted to the fullest extent of the law.

Antenna gain (dBi) -4.2

LTE Band 5_Uplink frequency band : 824 to 849 MHz										
BW (MHz)	UL Channel	Frequency (MHz)	Modulation	RB Size	RB Offset	Conducted Average (dBm)	ERP Average (dBm)	EIRP Average (dBm)	ERP Limit (dBm)	Margin (dB)
1.4	20407	824.7	QPSK	1	0	23.14	16.79	18.94	38.45	-21.66
				1	5	23.12	16.77	18.92	38.45	-21.68
				3	2	23.12	16.77	18.92	38.45	-21.68
				6	0	22.21	15.86	18.01	38.45	-22.59
	20525	836.5	QPSK	1	0	22.99	16.64	18.79	38.45	-21.81
				1	5	23.11	16.76	18.91	38.45	-21.69
				3	2	23.17	16.82	18.97	38.45	-21.63
				6	0	22.16	15.81	17.96	38.45	-22.64
	20643	848.3	QPSK	1	0	23.12	16.77	18.92	38.45	-21.68
				1	5	23.01	16.66	18.81	38.45	-21.79
				3	2	23.13	16.78	18.93	38.45	-21.67
				6	0	22.17	15.82	17.97	38.45	-22.63
	20407	824.7	16QAM	1	0	22.66	16.31	18.46	38.45	-22.14
				1	5	22.28	15.93	18.08	38.45	-22.52
				3	2	22.29	15.94	18.09	38.45	-22.51
				6	0	21.29	14.94	17.09	38.45	-23.51
	20525	836.5	16QAM	1	0	22.45	16.10	18.25	38.45	-22.35
				1	5	22.17	15.82	17.97	38.45	-22.63
				3	2	22.26	15.91	18.06	38.45	-22.54
				6	0	21.32	14.97	17.12	38.45	-23.48
	20643	848.3	16QAM	1	0	22.29	15.94	18.09	38.45	-22.51
				1	5	22.28	15.93	18.08	38.45	-22.52
				3	2	22.26	15.91	18.06	38.45	-22.54
				6	0	21.34	14.99	17.14	38.45	-23.46
	20407	824.7	64QAM	1	0	21.41	15.06	17.21	38.45	-23.39
				1	5	21.06	14.71	16.86	38.45	-23.74
				3	2	20.38	14.03	16.18	38.45	-24.42
				6	0	20.28	13.93	16.08	38.45	-24.52
	20525	836.5	64QAM	1	0	21.16	14.81	16.96	38.45	-23.64
				1	5	20.82	14.47	16.62	38.45	-23.98
				3	2	20.27	13.92	16.07	38.45	-24.53
				6	0	19.87	13.52	15.67	38.45	-24.93
	20643	848.3	64QAM	1	0	21.69	15.34	17.49	38.45	-23.11
				1	5	21.08	14.73	16.88	38.45	-23.72
				3	2	20.12	13.77	15.92	38.45	-24.68
				6	0	20.24	13.89	16.04	38.45	-24.56

Unless otherwise stated the results shown in this test report refer only to the sample(s) tested and such sample(s) are retained for 90 days only.

除非另有說明，此報告結果僅對測試之樣品負責，同時此樣品僅保留90天。本報告未經本公司書面許可，不可部份複製。

This document is issued by the Company subject to its General Conditions of Service printed overleaf, available on request or accessible at <http://www.sgs.com.tw/Terms-and-Conditions> and for electronic format documents, subject to Terms and Conditions for Electronic Documents at <http://www.sgs.com.tw/Terms-and-Conditions>. Attention is drawn to the limitation of liability, indemnification and jurisdiction issues defined therein. Any holder of this document is advised that information contained hereon reflects the Company's findings at the time of its intervention only and within the limits of Client's instructions, if any. The Company's sole responsibility is to its Client and this document does not exonerate parties to a transaction from exercising all their rights and obligations under the transaction documents. This document cannot be reproduced except in full, without prior written approval of the Company. Any unauthorized alteration, forgery or falsification of the content or appearance of this document is unlawful and offenders may be prosecuted to the fullest extent of the law.

Antenna gain (dBi)		-4.2								
LTE Band 5_Uplink frequency band : 824 to 849 MHz										
BW (MHz)	UL Channel	Frequency (MHz)	Modulation	RB Size	RB Offset	Conducted Average (dBm)	ERP Average (dBm)	EIRP Average (dBm)	ERP Limit (dBm)	Margin (dB)
3	20415	825.5	QPSK	1	0	23.20	16.85	19.00	38.45	-21.60
				1	14	23.12	16.77	18.92	38.45	-21.68
				8	4	22.29	15.94	18.09	38.45	-22.51
				15	0	22.26	15.91	18.06	38.45	-22.54
	20525	836.5	QPSK	1	0	23.21	16.86	19.01	38.45	-21.59
				1	14	23.19	16.84	18.99	38.45	-21.61
				8	4	22.36	16.01	18.16	38.45	-22.44
				15	0	22.22	15.87	18.02	38.45	-22.58
	20635	847.5	QPSK	1	0	23.17	16.82	18.97	38.45	-21.63
				1	14	23.09	16.74	18.89	38.45	-21.71
				8	4	22.21	15.86	18.01	38.45	-22.59
				15	0	22.31	15.96	18.11	38.45	-22.49
	20415	825.5	16QAM	1	0	22.52	16.17	18.32	38.45	-22.28
				1	14	22.71	16.36	18.51	38.45	-22.09
				8	4	21.38	15.03	17.18	38.45	-23.42
				15	0	21.33	14.98	17.13	38.45	-23.47
	20525	836.5	16QAM	1	0	22.43	16.08	18.23	38.45	-22.37
				1	14	22.36	16.01	18.16	38.45	-22.44
				8	4	21.42	15.07	17.22	38.45	-23.38
				15	0	21.20	14.85	17.00	38.45	-23.60
	20635	847.5	16QAM	1	0	22.48	16.13	18.28	38.45	-22.32
				1	14	22.48	16.13	18.28	38.45	-22.32
				8	4	21.28	14.93	17.08	38.45	-23.52
				15	0	21.32	14.97	17.12	38.45	-23.48
	20415	825.5	64QAM	1	0	21.42	15.07	17.22	38.45	-23.38
				1	14	20.94	14.59	16.74	38.45	-23.86
				8	4	20.39	14.04	16.19	38.45	-24.41
				15	0	20.25	13.90	16.05	38.45	-24.55
	20525	836.5	64QAM	1	0	21.25	14.90	17.05	38.45	-23.55
				1	14	21.18	14.83	16.98	38.45	-23.62
				8	4	20.26	13.91	16.06	38.45	-24.54
				15	0	19.88	13.53	15.68	38.45	-24.92
	20635	847.5	64QAM	1	0	21.55	15.20	17.35	38.45	-23.25
				1	14	20.80	14.45	16.60	38.45	-24.00
				8	4	20.19	13.84	15.99	38.45	-24.61
				15	0	20.26	13.91	16.06	38.45	-24.54

Unless otherwise stated the results shown in this test report refer only to the sample(s) tested and such sample(s) are retained for 90 days only.

除非另有說明，此報告結果僅對測試之樣品負責，同時此樣品僅保留90天。本報告未經本公司書面許可，不可部份複製。

This document is issued by the Company subject to its General Conditions of Service printed overleaf, available on request or accessible at <http://www.sgs.com.tw/Terms-and-Conditions> and for electronic format documents, subject to Terms and Conditions for Electronic Documents at <http://www.sgs.com.tw/Terms-and-Conditions>. Attention is drawn to the limitation of liability, indemnification and jurisdiction issues defined therein. Any holder of this document is advised that information contained hereon reflects the Company's findings at the time of its intervention only and within the limits of Client's instructions, if any. The Company's sole responsibility is to its Client and this document does not exonerate parties to a transaction from exercising all their rights and obligations under the transaction documents. This document cannot be reproduced except in full, without prior written approval of the Company. Any unauthorized alteration, forgery or falsification of the content or appearance of this document is unlawful and offenders may be prosecuted to the fullest extent of the law.

Antenna gain (dBi)		-4.2								
LTE Band 5_Uplink frequency band : 824 to 849 MHz										
BW (MHz)	UL Channel	Frequency (MHz)	Modulation	RB Size	RB Offset	Conducted Average (dBm)	ERP Average (dBm)	EIRP Average (dBm)	ERP Limit (dBm)	Margin (dB)
5	20425	826.5	QPSK	1	0	23.21	16.86	19.01	38.45	-21.59
				1	24	23.18	16.83	18.98	38.45	-21.62
				12	6	22.31	15.96	18.11	38.45	-22.49
				25	0	22.32	15.97	18.12	38.45	-22.48
	20525	836.5	QPSK	1	0	23.13	16.78	18.93	38.45	-21.67
				1	24	23.23	16.88	19.03	38.45	-21.57
				12	6	22.24	15.89	18.04	38.45	-22.56
				25	0	22.24	15.89	18.04	38.45	-22.56
	20625	846.5	QPSK	1	0	23.20	16.85	19.00	38.45	-21.60
				1	24	23.17	16.82	18.97	38.45	-21.63
				12	6	22.26	15.91	18.06	38.45	-22.54
				25	0	22.22	15.87	18.02	38.45	-22.58
	20425	826.5	16QAM	1	0	22.51	16.16	18.31	38.45	-22.29
				1	24	22.53	16.18	18.33	38.45	-22.27
				12	6	21.34	14.99	17.14	38.45	-23.46
				25	0	21.39	15.04	17.19	38.45	-23.41
	20525	836.5	16QAM	1	0	22.47	16.12	18.27	38.45	-22.33
				1	24	22.37	16.02	18.17	38.45	-22.43
				12	6	21.28	14.93	17.08	38.45	-23.52
				25	0	21.28	14.93	17.08	38.45	-23.52
	20625	846.5	16QAM	1	0	22.30	15.95	18.10	38.45	-22.50
				1	24	22.13	15.78	17.93	38.45	-22.67
				12	6	21.22	14.87	17.02	38.45	-23.58
				25	0	21.38	15.03	17.18	38.45	-23.42
	20425	826.5	64QAM	1	0	21.29	14.94	17.09	38.45	-23.51
				1	24	20.96	14.61	16.76	38.45	-23.84
				12	6	20.18	13.83	15.98	38.45	-24.62
				25	0	20.09	13.74	15.89	38.45	-24.71
	20525	836.5	64QAM	1	0	21.27	14.92	17.07	38.45	-23.53
				1	24	20.81	14.46	16.61	38.45	-23.99
				12	6	20.32	13.97	16.12	38.45	-24.48
				25	0	20.08	13.73	15.88	38.45	-24.72
	20625	846.5	64QAM	1	0	21.59	15.24	17.39	38.45	-23.21
				1	24	21.17	14.82	16.97	38.45	-23.63
				12	6	20.01	13.66	15.81	38.45	-24.79
				25	0	19.95	13.60	15.75	38.45	-24.85

Unless otherwise stated the results shown in this test report refer only to the sample(s) tested and such sample(s) are retained for 90 days only.

除非另有說明，此報告結果僅對測試之樣品負責，同時此樣品僅保留90天。本報告未經本公司書面許可，不可部份複製。

This document is issued by the Company subject to its General Conditions of Service printed overleaf, available on request or accessible at <http://www.sgs.com.tw/Terms-and-Conditions> and for electronic format documents, subject to Terms and Conditions for Electronic Documents at <http://www.sgs.com.tw/Terms-and-Conditions>. Attention is drawn to the limitation of liability, indemnification and jurisdiction issues defined therein. Any holder of this document is advised that information contained hereon reflects the Company's findings at the time of its intervention only and within the limits of Client's instructions, if any. The Company's sole responsibility is to its Client and this document does not exonerate parties to a transaction from exercising all their rights and obligations under the transaction documents. This document cannot be reproduced except in full, without prior written approval of the Company. Any unauthorized alteration, forgery or falsification of the content or appearance of this document is unlawful and offenders may be prosecuted to the fullest extent of the law.

Antenna gain (dBi)		-4.2								
LTE Band 5_Uplink frequency band : 824 to 849 MHz										
BW (MHz)	UL Channel	Frequency (MHz)	Modulation	RB Size	RB Offset	Conducted Average (dBm)	ERP Average (dBm)	EIRP Average (dBm)	ERP Limit (dBm)	Margin (dB)
10	20450	829	QPSK	1	0	23.14	16.79	18.94	38.45	-21.66
				1	49	23.17	16.82	18.97	38.45	-21.63
				25	12	22.38	16.03	18.18	38.45	-22.42
				50	0	22.42	16.07	18.22	38.45	-22.38
	20525	836.5	QPSK	1	0	23.16	16.81	18.96	38.45	-21.64
				1	49	23.05	16.70	18.85	38.45	-21.75
				25	12	22.26	15.91	18.06	38.45	-22.54
				50	0	22.36	16.01	18.16	38.45	-22.44
	20600	844	QPSK	1	0	23.07	16.72	18.87	38.45	-21.73
				1	49	23.28	16.93	19.08	38.45	-21.52
				25	12	22.38	16.03	18.18	38.45	-22.42
				50	0	22.33	15.98	18.13	38.45	-22.47
	20450	829	16QAM	1	0	22.47	16.12	18.27	38.45	-22.33
				1	49	22.21	15.86	18.01	38.45	-22.59
				25	12	21.40	15.05	17.20	38.45	-23.40
				50	0	21.34	14.99	17.14	38.45	-23.46
	20525	836.5	16QAM	1	0	22.28	15.93	18.08	38.45	-22.52
				1	49	22.18	15.83	17.98	38.45	-22.62
				25	12	21.41	15.06	17.21	38.45	-23.39
				50	0	21.18	14.83	16.98	38.45	-23.62
	20600	844	16QAM	1	0	22.79	16.44	18.59	38.45	-22.01
				1	49	22.18	15.83	17.98	38.45	-22.62
				25	12	21.32	14.97	17.12	38.45	-23.48
				50	0	21.29	14.94	17.09	38.45	-23.51
	20450	829	64QAM	1	0	21.15	14.80	16.95	38.45	-23.65
				1	49	21.02	14.67	16.82	38.45	-23.78
				25	12	20.36	14.01	16.16	38.45	-24.44
				50	0	20.25	13.90	16.05	38.45	-24.55
	20525	836.5	64QAM	1	0	21.14	14.79	16.94	38.45	-23.66
				1	49	21.14	14.79	16.94	38.45	-23.66
				25	12	20.16	13.81	15.96	38.45	-24.64
				50	0	20.06	13.71	15.86	38.45	-24.74
	20600	844	64QAM	1	0	21.72	15.37	17.52	38.45	-23.08
				1	49	21.12	14.77	16.92	38.45	-23.68
				25	12	20.10	13.75	15.90	38.45	-24.70
				50	0	20.04	13.69	15.84	38.45	-24.76

Unless otherwise stated the results shown in this test report refer only to the sample(s) tested and such sample(s) are retained for 90 days only.

除非另有說明，此報告結果僅對測試之樣品負責，同時此樣品僅保留90天。本報告未經本公司書面許可，不可部份複製。

This document is issued by the Company subject to its General Conditions of Service printed overleaf, available on request or accessible at <http://www.sgs.com.tw/Terms-and-Conditions> and for electronic format documents, subject to Terms and Conditions for Electronic Documents at <http://www.sgs.com.tw/Terms-and-Conditions>. Attention is drawn to the limitation of liability, indemnification and jurisdiction issues defined therein. Any holder of this document is advised that information contained hereon reflects the Company's findings at the time of its intervention only and within the limits of Client's instructions, if any. The Company's sole responsibility is to its Client and this document does not exonerate parties to a transaction from exercising all their rights and obligations under the transaction documents. This document cannot be reproduced except in full, without prior written approval of the Company. Any unauthorized alteration, forgery or falsification of the content or appearance of this document is unlawful and offenders may be prosecuted to the fullest extent of the law.

LTE Band 7_Uplink frequency band : 2500 to 2570 MHz									
BW (MHz)	UL Channel	Frequency (MHz)	Modulation	RB Size	RB Offset	Conducted Average (dBm)	EIRP Average (dBm)	EIRP Limit (dBm)	Margin (dB)
5	20775	2502.5	QPSK	1	0	22.97	16.27	33	-16.73
				1	24	22.97	16.27	33	-16.73
				12	6	22.11	15.41	33	-17.59
				25	0	22.10	15.40	33	-17.6
	21100	2535	QPSK	1	0	23.06	16.36	33	-16.64
				1	24	23.20	16.50	33	-16.5
				12	6	22.34	15.64	33	-17.36
				25	0	22.22	15.52	33	-17.48
	21375	2567.5	QPSK	1	0	23.15	16.45	33	-16.55
				1	24	23.14	16.44	33	-16.56
				12	6	22.30	15.60	33	-17.4
				25	0	22.30	15.60	33	-17.4
	20775	2502.5	16QAM	1	0	22.20	15.50	33	-17.5
				1	24	22.68	15.98	33	-17.02
				12	6	21.09	14.39	33	-18.61
				25	0	21.06	14.36	33	-18.64
	21100	2535	16QAM	1	0	21.97	15.27	33	-17.73
				1	24	22.31	15.61	33	-17.39
				12	6	21.23	14.53	33	-18.47
				25	0	21.18	14.48	33	-18.52
	21375	2567.5	16QAM	1	0	22.29	15.59	33	-17.41
				1	24	22.82	16.12	33	-16.88
				12	6	21.37	14.67	33	-18.33
				25	0	21.22	14.52	33	-18.48
	20775	2502.5	64QAM	1	0	20.85	14.15	33	-18.85
				1	24	20.60	13.90	33	-19.1
				12	6	19.99	13.29	33	-19.71
				25	0	20.00	13.30	33	-19.7
	21100	2535	64QAM	1	0	20.81	14.11	33	-18.89
				1	24	21.37	14.67	33	-18.33
				12	6	19.93	13.23	33	-19.77
				25	0	19.87	13.17	33	-19.83
	21375	2567.5	64QAM	1	0	20.79	14.09	33	-18.91
				1	24	20.57	13.87	33	-19.13
				12	6	20.04	13.34	33	-19.66
				25	0	19.86	13.16	33	-19.84

Unless otherwise stated the results shown in this test report refer only to the sample(s) tested and such sample(s) are retained for 90 days only.

除非另有說明，此報告結果僅對測試之樣品負責，同時此樣品僅保留90天。本報告未經本公司書面許可，不可部份複製。

This document is issued by the Company subject to its General Conditions of Service printed overleaf, available on request or accessible at <http://www.sgs.com.tw/Terms-and-Conditions> and for electronic format documents, subject to Terms and Conditions for Electronic Documents at <http://www.sgs.com.tw/Terms-and-Conditions>. Attention is drawn to the limitation of liability, indemnification and jurisdiction issues defined therein. Any holder of this document is advised that information contained hereon reflects the Company's findings at the time of its intervention only and within the limits of Client's instructions, if any. The Company's sole responsibility is to its Client and this document does not exonerate parties to a transaction from exercising all their rights and obligations under the transaction documents. This document cannot be reproduced except in full, without prior written approval of the Company. Any unauthorized alteration, forgery or falsification of the content or appearance of this document is unlawful and offenders may be prosecuted to the fullest extent of the law.

Antenna gain (dBi)		-6.7							
LTE Band 7_Uplink frequency band : 2500 to 2570 MHz									
BW (MHz)	UL Channel	Frequency (MHz)	Modulation	RB Size	RB Offset	Conducted Average (dBm)	EIRP Average (dBm)	EIRP Limit (dBm)	Margin (dB)
10	20800	2505	QPSK	1	0	23.14	16.44	33	-16.56
				1	49	23.10	16.40	33	-16.6
				25	12	22.11	15.41	33	-17.59
				50	0	22.06	15.36	33	-17.64
	21100	2535	QPSK	1	0	23.03	16.33	33	-16.67
				1	49	23.24	16.54	33	-16.46
				25	12	22.15	15.45	33	-17.55
				50	0	22.09	15.39	33	-17.61
	21350	2565	QPSK	1	0	23.02	16.32	33	-16.68
				1	49	23.15	16.45	33	-16.55
				25	12	22.32	15.62	33	-17.38
				50	0	22.27	15.57	33	-17.43
	20800	2505	16QAM	1	0	22.28	15.58	33	-17.42
				1	49	22.29	15.59	33	-17.41
				25	12	21.18	14.48	33	-18.52
				50	0	21.17	14.47	33	-18.53
	21100	2535	16QAM	1	0	22.10	15.40	33	-17.6
				1	49	22.39	15.69	33	-17.31
				25	12	21.22	14.52	33	-18.48
				50	0	21.17	14.47	33	-18.53
	21350	2565	16QAM	1	0	22.39	15.69	33	-17.31
				1	49	22.52	15.82	33	-17.18
				25	12	21.22	14.52	33	-18.48
				50	0	21.16	14.46	33	-18.54
	20800	2505	64QAM	1	0	21.14	14.44	33	-18.56
				1	49	20.79	14.09	33	-18.91
				25	12	19.91	13.21	33	-19.79
				50	0	20.10	13.40	33	-19.6
	21100	2535	64QAM	1	0	21.02	14.32	33	-18.68
				1	49	21.27	14.57	33	-18.43
				25	12	19.97	13.27	33	-19.73
				50	0	19.96	13.26	33	-19.74
	21350	2565	64QAM	1	0	21.04	14.34	33	-18.66
				1	49	20.78	14.08	33	-18.92
				25	12	19.85	13.15	33	-19.85
				50	0	20.08	13.38	33	-19.62

Unless otherwise stated the results shown in this test report refer only to the sample(s) tested and such sample(s) are retained for 90 days only.

除非另有說明，此報告結果僅對測試之樣品負責，同時此樣品僅保留90天。本報告未經本公司書面許可，不可部份複製。

This document is issued by the Company subject to its General Conditions of Service printed overleaf, available on request or accessible at <http://www.sgs.com.tw/Terms-and-Conditions> and for electronic format documents, subject to Terms and Conditions for Electronic Documents at <http://www.sgs.com.tw/Terms-and-Conditions>. Attention is drawn to the limitation of liability, indemnification and jurisdiction issues defined therein. Any holder of this document is advised that information contained hereon reflects the Company's findings at the time of its intervention only and within the limits of Client's instructions, if any. The Company's sole responsibility is to its Client and this document does not exonerate parties to a transaction from exercising all their rights and obligations under the transaction documents. This document cannot be reproduced except in full, without prior written approval of the Company. Any unauthorized alteration, forgery or falsification of the content or appearance of this document is unlawful and offenders may be prosecuted to the fullest extent of the law.

Antenna gain (dBi)		-6.7							
LTE Band 7_Uplink frequency band : 2500 to 2570 MHz									
BW (MHz)	UL Channel	Frequency (MHz)	Modulation	RB Size	RB Offset	Conducted Average (dBm)	EIRP Average (dBm)	EIRP Limit (dBm)	Margin (dB)
15	20825	2507.5	QPSK	1	0	22.76	16.06	33	-16.94
				1	74	23.11	16.41	33	-16.59
				36	18	22.07	15.37	33	-17.63
				75	0	21.96	15.26	33	-17.74
	21100	2535	QPSK	1	0	22.95	16.25	33	-16.75
				1	74	23.21	16.51	33	-16.49
				36	18	22.11	15.41	33	-17.59
				75	0	22.05	15.35	33	-17.65
	21375	2562.5	QPSK	1	0	22.90	16.20	33	-16.8
				1	74	23.21	16.51	33	-16.49
				36	18	22.16	15.46	33	-17.54
				75	0	22.16	15.46	33	-17.54
	20825	2507.5	16QAM	1	0	22.16	15.46	33	-17.54
				1	74	22.41	15.71	33	-17.29
				36	18	21.05	14.35	33	-18.65
				75	0	21.10	14.40	33	-18.6
	21100	2535	16QAM	1	0	22.50	15.80	33	-17.2
				1	74	22.74	16.04	33	-16.96
				36	18	21.11	14.41	33	-18.59
				75	0	21.06	14.36	33	-18.64
	21375	2562.5	16QAM	1	0	22.27	15.57	33	-17.43
				1	74	22.73	16.03	33	-16.97
				36	18	21.23	14.53	33	-18.47
				75	0	21.18	14.48	33	-18.52
	20825	2507.5	64QAM	1	0	20.96	14.26	33	-18.74
				1	74	20.89	14.19	33	-18.81
				36	18	20.03	13.33	33	-19.67
				75	0	19.94	13.24	33	-19.76
	21100	2535	64QAM	1	0	20.99	14.29	33	-18.71
				1	74	21.35	14.65	33	-18.35
				36	18	19.89	13.19	33	-19.81
				75	0	19.92	13.22	33	-19.78
	21375	2562.5	64QAM	1	0	21.04	14.34	33	-18.66
				1	74	20.74	14.04	33	-18.96
				36	18	20.08	13.38	33	-19.62
				75	0	20.09	13.39	33	-19.61

Unless otherwise stated the results shown in this test report refer only to the sample(s) tested and such sample(s) are retained for 90 days only.

除非另有說明，此報告結果僅對測試之樣品負責，同時此樣品僅保留90天。本報告未經本公司書面許可，不可部份複製。

This document is issued by the Company subject to its General Conditions of Service printed overleaf, available on request or accessible at <http://www.sgs.com.tw/Terms-and-Conditions> and for electronic format documents, subject to Terms and Conditions for Electronic Documents at <http://www.sgs.com.tw/Terms-and-Conditions>. Attention is drawn to the limitation of liability, indemnification and jurisdiction issues defined therein. Any holder of this document is advised that information contained hereon reflects the Company's findings at the time of its intervention only and within the limits of Client's instructions, if any. The Company's sole responsibility is to its Client and this document does not exonerate parties to a transaction from exercising all their rights and obligations under the transaction documents. This document cannot be reproduced except in full, without prior written approval of the Company. Any unauthorized alteration, forgery or falsification of the content or appearance of this document is unlawful and offenders may be prosecuted to the fullest extent of the law.

Antenna gain (dBi)		-6.7							
LTE Band 7_Uplink frequency band : 2500 to 2570 MHz									
BW (MHz)	UL Channel	Frequency (MHz)	Modulation	RB Size	RB Offset	Conducted Average (dBm)	EIRP Average (dBm)	EIRP Limit (dBm)	Margin (dB)
20	20850	2510	QPSK	1	0	22.94	16.24	33	-16.76
				1	99	23.25	16.55	33	-16.45
				50	25	22.19	15.49	33	-17.51
				100	0	22.19	15.49	33	-17.51
	21100	2535	QPSK	1	0	23.04	16.34	33	-16.66
				1	99	23.26	16.56	33	-16.44
				50	25	22.22	15.52	33	-17.48
				100	0	22.16	15.46	33	-17.54
	21350	2560	QPSK	1	0	22.89	16.19	33	-16.81
				1	99	23.14	16.44	33	-16.56
				50	25	22.20	15.50	33	-17.5
				100	0	22.16	15.46	33	-17.54
	20850	2510	16QAM	1	0	22.60	15.90	33	-17.1
				1	99	22.64	15.94	33	-17.06
				50	25	21.16	14.46	33	-18.54
				100	0	21.17	14.47	33	-18.53
	21100	2535	16QAM	1	0	22.51	15.81	33	-17.19
				1	99	22.40	15.70	33	-17.3
				50	25	21.08	14.38	33	-18.62
				100	0	21.09	14.39	33	-18.61
	21350	2560	16QAM	1	0	22.42	15.72	33	-17.28
				1	99	22.18	15.48	33	-17.52
				50	25	21.16	14.46	33	-18.54
				100	0	21.13	14.43	33	-18.57
	20850	2510	64QAM	1	0	20.89	14.19	33	-18.81
				1	99	20.56	13.86	33	-19.14
				50	25	19.84	13.14	33	-19.86
				100	0	20.23	13.53	33	-19.47
	21100	2535	64QAM	1	0	20.81	14.11	33	-18.89
				1	99	21.28	14.58	33	-18.42
				50	25	19.87	13.17	33	-19.83
				100	0	19.90	13.20	33	-19.8
21350	2560	64QAM	1	0	20.91	14.21	33	-18.79	
			1	99	20.62	13.92	33	-19.08	
			50	25	20.03	13.33	33	-19.67	
			100	0	20.04	13.34	33	-19.66	

Unless otherwise stated the results shown in this test report refer only to the sample(s) tested and such sample(s) are retained for 90 days only.

除非另有說明，此報告結果僅對測試之樣品負責，同時此樣品僅保留90天。本報告未經本公司書面許可，不可部份複製。

This document is issued by the Company subject to its General Conditions of Service printed overleaf, available on request or accessible at <http://www.sgs.com.tw/Terms-and-Conditions> and for electronic format documents, subject to Terms and Conditions for Electronic Documents at <http://www.sgs.com.tw/Terms-and-Conditions>. Attention is drawn to the limitation of liability, indemnification and jurisdiction issues defined therein. Any holder of this document is advised that information contained hereon reflects the Company's findings at the time of its intervention only and within the limits of Client's instructions, if any. The Company's sole responsibility is to its Client and this document does not exonerate parties to a transaction from exercising all their rights and obligations under the transaction documents. This document cannot be reproduced except in full, without prior written approval of the Company. Any unauthorized alteration, forgery or falsification of the content or appearance of this document is unlawful and offenders may be prosecuted to the fullest extent of the law.

Antenna gain (dBi)

-3.5

LTE Band 38_Uplink frequency band : 2570 to 2620 MHz

BW (MHz)	UL Channel	Frequency (MHz)	Modulation	RB Size	RB Offset	Conducted Average (dBm)	EIRP Average (dBm)	EIRP Limit (dBm)	Margin (dB)
5	37775	2572.5	QPSK	1	0	23.12	19.62	33	-13.38
				1	24	23.04	19.54	33	-13.46
				12	6	22.18	18.68	33	-14.32
				25	0	22.24	18.74	33	-14.26
	38000	2595	QPSK	1	0	23.12	19.62	33	-13.38
				1	24	23.12	19.62	33	-13.38
				12	6	22.23	18.73	33	-14.27
				25	0	22.21	18.71	33	-14.29
	38225	2617.5	QPSK	1	0	23.13	19.63	33	-13.37
				1	24	22.93	19.43	33	-13.57
				12	6	22.06	18.56	33	-14.44
				25	0	22.17	18.67	33	-14.33
	37775	2572.5	16QAM	1	0	22.37	18.87	33	-14.13
				1	24	22.44	18.94	33	-14.06
				12	6	21.12	17.62	33	-15.38
				25	0	21.16	17.66	33	-15.34
	38000	2595	16QAM	1	0	22.39	18.89	33	-14.11
				1	24	22.43	18.93	33	-14.07
				12	6	21.18	17.68	33	-15.32
				25	0	21.21	17.71	33	-15.29
	38225	2617.5	16QAM	1	0	22.39	18.89	33	-14.11
				1	24	22.07	18.57	33	-14.43
				12	6	21.14	17.64	33	-15.36
				25	0	21.19	17.69	33	-15.31
	37775	2572.5	64QAM	1	0	21.10	17.60	33	-15.4
				1	24	21.02	17.52	33	-15.48
				12	6	19.95	16.45	33	-16.55
				25	0	20.30	16.80	33	-16.2
	38000	2595	64QAM	1	0	21.18	17.68	33	-15.32
				1	24	20.99	17.49	33	-15.51
				12	6	19.85	16.35	33	-16.65
				25	0	20.05	16.55	33	-16.45
	38225	2617.5	64QAM	1	0	21.07	17.57	33	-15.43
				1	24	21.02	17.52	33	-15.48
				12	6	20.02	16.52	33	-16.48
				25	0	20.09	16.59	33	-16.41

Unless otherwise stated the results shown in this test report refer only to the sample(s) tested and such sample(s) are retained for 90 days only.

除非另有說明，此報告結果僅對測試之樣品負責，同時此樣品僅保留90天。本報告未經本公司書面許可，不可部份複製。

This document is issued by the Company subject to its General Conditions of Service printed overleaf, available on request or accessible at <http://www.sgs.com.tw/Terms-and-Conditions> and for electronic format documents, subject to Terms and Conditions for Electronic Documents at <http://www.sgs.com.tw/Terms-and-Conditions>. Attention is drawn to the limitation of liability, indemnification and jurisdiction issues defined therein. Any holder of this document is advised that information contained hereon reflects the Company's findings at the time of its intervention only and within the limits of Client's instructions, if any. The Company's sole responsibility is to its Client and this document does not exonerate parties to a transaction from exercising all their rights and obligations under the transaction documents. This document cannot be reproduced except in full, without prior written approval of the Company. Any unauthorized alteration, forgery or falsification of the content or appearance of this document is unlawful and offenders may be prosecuted to the fullest extent of the law.

Antenna gain (dBi)		-3.5							
LTE Band 38_Uplink frequency band : 2570 to 2620 MHz									
BW (MHz)	UL Channel	Frequency (MHz)	Modulation	RB Size	RB Offset	Conducted Average (dBm)	EIRP Average (dBm)	EIRP Limit (dBm)	Margin (dB)
10	37800	2575	QPSK	1	0	23.08	19.58	33	-13.42
				1	49	22.94	19.44	33	-13.56
				25	12	22.12	18.62	33	-14.38
				50	0	22.24	18.74	33	-14.26
	38000	2595	QPSK	1	0	23.12	19.62	33	-13.38
				1	49	23.18	19.68	33	-13.32
				25	12	22.18	18.68	33	-14.32
	38200	2615	QPSK	50	0	22.21	18.71	33	-14.29
				1	0	22.96	19.46	33	-13.54
				1	49	22.97	19.47	33	-13.53
	37800	2575	16QAM	25	12	22.22	18.72	33	-14.28
				50	0	22.14	18.64	33	-14.36
				1	0	22.07	18.57	33	-14.43
	38000	2595	16QAM	1	49	22.26	18.76	33	-14.24
				25	12	21.32	17.82	33	-15.18
				50	0	21.35	17.85	33	-15.15
	38200	2615	16QAM	1	0	22.14	18.64	33	-14.36
				1	49	22.05	18.55	33	-14.45
				25	12	21.17	17.67	33	-15.33
	37800	2575	16QAM	50	0	21.12	17.62	33	-15.38
				1	0	22.31	18.81	33	-14.19
				1	49	22.15	18.65	33	-14.35
	38000	2595	64QAM	25	12	21.06	17.56	33	-15.44
				50	0	21.11	17.61	33	-15.39
				1	0	21.19	17.69	33	-15.31
	38200	2615	64QAM	1	49	21.17	17.67	33	-15.33
				25	12	20.23	16.73	33	-16.27
				50	0	20.11	16.61	33	-16.39
	37800	2575	64QAM	1	0	21.11	17.61	33	-15.39
				1	49	20.92	17.42	33	-15.58
				25	12	20.16	16.66	33	-16.34
	38000	2595	64QAM	50	0	19.96	16.46	33	-16.54
				1	0	21.13	17.63	33	-15.37
				1	49	20.94	17.44	33	-15.56
	38200	2615	64QAM	25	12	20.22	16.72	33	-16.28
				50	0	19.88	16.38	33	-16.62

Unless otherwise stated the results shown in this test report refer only to the sample(s) tested and such sample(s) are retained for 90 days only.

除非另有說明，此報告結果僅對測試之樣品負責，同時此樣品僅保留90天。本報告未經本公司書面許可，不可部份複製。

This document is issued by the Company subject to its General Conditions of Service printed overleaf, available on request or accessible at <http://www.sgs.com.tw/Terms-and-Conditions> and for electronic format documents, subject to Terms and Conditions for Electronic Documents at <http://www.sgs.com.tw/Terms-and-Conditions>. Attention is drawn to the limitation of liability, indemnification and jurisdiction issues defined therein. Any holder of this document is advised that information contained hereon reflects the Company's findings at the time of its intervention only and within the limits of Client's instructions, if any. The Company's sole responsibility is to its Client and this document does not exonerate parties to a transaction from exercising all their rights and obligations under the transaction documents. This document cannot be reproduced except in full, without prior written approval of the Company. Any unauthorized alteration, forgery or falsification of the content or appearance of this document is unlawful and offenders may be prosecuted to the fullest extent of the law.

Antenna gain (dBi)		-3.5							
LTE Band 38_Uplink frequency band : 2570 to 2620 MHz									
BW (MHz)	UL Channel	Frequency (MHz)	Modulation	RB Size	RB Offset	Conducted Average (dBm)	EIRP Average (dBm)	EIRP Limit (dBm)	Margin (dB)
15	37825	2577.5	QPSK	1	0	23.13	19.63	33	-13.37
				1	74	23.04	19.54	33	-13.46
				36	19	22.20	18.70	33	-14.3
				75	0	22.31	18.81	33	-14.19
	38000	2595	QPSK	1	0	23.15	19.65	33	-13.35
				1	74	23.07	19.57	33	-13.43
				36	19	22.15	18.65	33	-14.35
				75	0	22.27	18.77	33	-14.23
	38175	2612.5	QPSK	1	0	23.04	19.54	33	-13.46
				1	74	22.80	19.30	33	-13.7
				36	19	22.11	18.61	33	-14.39
				75	0	22.04	18.54	33	-14.46
	37825	2577.5	16QAM	1	0	22.19	18.69	33	-14.31
				1	74	22.18	18.68	33	-14.32
				36	19	21.23	17.73	33	-15.27
				75	0	21.27	17.77	33	-15.23
	38000	2595	16QAM	1	0	22.27	18.77	33	-14.23
				1	74	22.16	18.66	33	-14.34
				36	19	21.10	17.60	33	-15.4
				75	0	21.27	17.77	33	-15.23
	38175	2612.5	16QAM	1	0	22.19	18.69	33	-14.31
				1	74	22.09	18.59	33	-14.41
				36	19	21.08	17.58	33	-15.42
				75	0	21.15	17.65	33	-15.35
	37825	2577.5	64QAM	1	0	21.17	17.67	33	-15.33
				1	74	20.92	17.42	33	-15.58
				36	19	20.22	16.72	33	-16.28
				75	0	20.06	16.56	33	-16.44
	38000	2595	64QAM	1	0	21.23	17.73	33	-15.27
				1	74	21.08	17.58	33	-15.42
				36	19	19.95	16.45	33	-16.55
				75	0	19.99	16.49	33	-16.51
	38175	2612.5	64QAM	1	0	21.06	17.56	33	-15.44
				1	74	21.00	17.50	33	-15.5
				36	19	20.07	16.57	33	-16.43
				75	0	19.98	16.48	33	-16.52

Unless otherwise stated the results shown in this test report refer only to the sample(s) tested and such sample(s) are retained for 90 days only.

除非另有說明，此報告結果僅對測試之樣品負責，同時此樣品僅保留90天。本報告未經本公司書面許可，不可部份複製。

This document is issued by the Company subject to its General Conditions of Service printed overleaf, available on request or accessible at <http://www.sgs.com.tw/Terms-and-Conditions> and for electronic format documents, subject to Terms and Conditions for Electronic Documents at <http://www.sgs.com.tw/Terms-and-Conditions>. Attention is drawn to the limitation of liability, indemnification and jurisdiction issues defined therein. Any holder of this document is advised that information contained hereon reflects the Company's findings at the time of its intervention only and within the limits of Client's instructions, if any. The Company's sole responsibility is to its Client and this document does not exonerate parties to a transaction from exercising all their rights and obligations under the transaction documents. This document cannot be reproduced except in full, without prior written approval of the Company. Any unauthorized alteration, forgery or falsification of the content or appearance of this document is unlawful and offenders may be prosecuted to the fullest extent of the law.

Antenna gain (dBi)		-3.5							
LTE Band 38_Uplink frequency band : 2570 to 2620 MHz									
BW (MHz)	UL Channel	Frequency (MHz)	Modulation	RB Size	RB Offset	Conducted Average (dBm)	EIRP Average (dBm)	EIRP Limit (dBm)	Margin (dB)
20	37850	2580	QPSK	1	0	23.19	19.69	33	-13.31
				1	99	22.94	19.44	33	-13.56
				50	25	22.22	18.72	33	-14.28
				100	0	22.24	18.74	33	-14.26
	38000	2595	QPSK	1	0	23.24	19.74	33	-13.26
				1	99	22.98	19.48	33	-13.52
				50	25	22.13	18.63	33	-14.37
				100	0	22.29	18.79	33	-14.21
	38150	2610	QPSK	1	0	23.17	19.67	33	-13.33
				1	99	23.04	19.54	33	-13.46
				50	25	22.17	18.67	33	-14.33
				100	0	22.26	18.76	33	-14.24
	37850	2580	16QAM	1	0	22.30	18.80	33	-14.2
				1	99	22.23	18.73	33	-14.27
				50	25	21.30	17.80	33	-15.2
				100	0	21.33	17.83	33	-15.17
	38000	2595	16QAM	1	0	22.38	18.88	33	-14.12
				1	99	22.24	18.74	33	-14.26
				50	25	21.18	17.68	33	-15.32
				100	0	21.22	17.72	33	-15.28
	38150	2610	16QAM	1	0	22.31	18.81	33	-14.19
				1	99	22.08	18.58	33	-14.42
				50	25	21.23	17.73	33	-15.27
				100	0	21.20	17.70	33	-15.3
	37850	2580	64QAM	1	0	20.98	17.48	33	-15.52
				1	99	20.96	17.46	33	-15.54
				50	25	20.21	16.71	33	-16.29
				100	0	20.28	16.78	33	-16.22
	38000	2595	64QAM	1	0	21.26	17.76	33	-15.24
				1	99	21.08	17.58	33	-15.42
				50	25	20.04	16.54	33	-16.46
				100	0	19.83	16.33	33	-16.67
	38150	2610	64QAM	1	0	20.96	17.46	33	-15.54
				1	99	20.83	17.33	33	-15.67
				50	25	19.91	16.41	33	-16.59
				100	0	19.95	16.45	33	-16.55

Unless otherwise stated the results shown in this test report refer only to the sample(s) tested and such sample(s) are retained for 90 days only.

除非另有說明，此報告結果僅對測試之樣品負責，同時此樣品僅保留90天。本報告未經本公司書面許可，不可部份複製。

This document is issued by the Company subject to its General Conditions of Service printed overleaf, available on request or accessible at <http://www.sgs.com.tw/Terms-and-Conditions> and for electronic format documents, subject to Terms and Conditions for Electronic Documents at <http://www.sgs.com.tw/Terms-and-Conditions>. Attention is drawn to the limitation of liability, indemnification and jurisdiction issues defined therein. Any holder of this document is advised that information contained hereon reflects the Company's findings at the time of its intervention only and within the limits of Client's instructions, if any. The Company's sole responsibility is to its Client and this document does not exonerate parties to a transaction from exercising all their rights and obligations under the transaction documents. This document cannot be reproduced except in full, without prior written approval of the Company. Any unauthorized alteration, forgery or falsification of the content or appearance of this document is unlawful and offenders may be prosecuted to the fullest extent of the law.

Antenna gain (dBi) -3.5									
LTE Band 41_Uplink frequency band : 2496 to 2690 MHz									
BW (MHz)	UL Channel	Frequency (MHz)	Modulation	RB Size	RB Offset	Conducted Average (dBm)	EIRP Average (dBm)	EIRP Limit (dBm)	Margin (dB)
5	39675	2498.5	QPSK	1	0	22.11	18.61	33	-14.39
				1	24	21.99	18.49	33	-14.51
				12	6	21.17	17.67	33	-15.33
				25	0	21.10	17.60	33	-15.4
	40620	2593	QPSK	1	0	23.49	19.99	33	-13.01
				1	24	23.62	20.12	33	-12.88
				12	6	22.70	19.20	33	-13.8
				25	0	22.77	19.27	33	-13.73
	41565	2687.5	QPSK	1	0	21.99	18.49	33	-14.51
				1	24	22.14	18.64	33	-14.36
				12	6	21.04	17.54	33	-15.46
				25	0	21.09	17.59	33	-15.41
	39675	2498.5	16QAM	1	0	21.16	17.66	33	-15.34
				1	24	21.09	17.59	33	-15.41
				12	6	20.09	16.59	33	-16.41
				25	0	20.18	16.68	33	-16.32
	40620	2593	16QAM	1	0	22.77	19.27	33	-13.73
				1	24	22.74	19.24	33	-13.76
				12	6	21.60	18.10	33	-14.9
				25	0	21.79	18.29	33	-14.71
	41565	2687.5	16QAM	1	0	21.32	17.82	33	-15.18
				1	24	21.11	17.61	33	-15.39
				12	6	19.95	16.45	33	-16.55
				25	0	20.17	16.67	33	-16.33
	39675	2498.5	64QAM	1	0	19.36	15.86	33	-17.14
				1	24	20.39	16.89	33	-16.11
				12	6	19.41	15.91	33	-17.09
				25	0	19.44	15.94	33	-17.06
	40620	2593	64QAM	1	0	21.80	18.30	33	-14.7
				1	24	21.95	18.45	33	-14.55
				12	6	20.86	17.36	33	-15.64
				25	0	21.00	17.50	33	-15.5
	41565	2687.5	64QAM	1	0	20.35	16.85	33	-16.15
				1	24	20.21	16.71	33	-16.29
				12	6	19.52	16.02	33	-16.98
				25	0	19.26	15.76	33	-17.24

Unless otherwise stated the results shown in this test report refer only to the sample(s) tested and such sample(s) are retained for 90 days only.

除非另有說明，此報告結果僅對測試之樣品負責，同時此樣品僅保留90天。本報告未經本公司書面許可，不可部份複製。

This document is issued by the Company subject to its General Conditions of Service printed overleaf, available on request or accessible at <http://www.sgs.com.tw/Terms-and-Conditions> and for electronic format documents, subject to Terms and Conditions for Electronic Documents at <http://www.sgs.com.tw/Terms-and-Conditions>. Attention is drawn to the limitation of liability, indemnification and jurisdiction issues defined therein. Any holder of this document is advised that information contained hereon reflects the Company's findings at the time of its intervention only and within the limits of Client's instructions, if any. The Company's sole responsibility is to its Client and this document does not exonerate parties to a transaction from exercising all their rights and obligations under the transaction documents. This document cannot be reproduced except in full, without prior written approval of the Company. Any unauthorized alteration, forgery or falsification of the content or appearance of this document is unlawful and offenders may be prosecuted to the fullest extent of the law.

Antenna gain (dBi)		-3.5							
LTE Band 41_Uplink frequency band : 2496 to 2690 MHz									
BW (MHz)	UL Channel	Frequency (MHz)	Modulation	RB Size	RB Offset	Conducted Average (dBm)	EIRP Average (dBm)	EIRP Limit (dBm)	Margin (dB)
10	39700	2501	QPSK	1	0	21.98	18.48	33	-14.52
				1	49	22.02	18.52	33	-14.48
				25	12	21.16	17.66	33	-15.34
				50	0	21.17	17.67	33	-15.33
	40620	2593	QPSK	1	0	23.51	20.01	33	-12.99
				1	49	23.56	20.06	33	-12.94
				25	12	22.60	19.10	33	-13.9
				50	0	22.79	19.29	33	-13.71
	41540	2685	QPSK	1	0	22.05	18.55	33	-14.45
				1	49	22.12	18.62	33	-14.38
				25	12	21.03	17.53	33	-15.47
				50	0	21.04	17.54	33	-15.46
	39700	2501	16QAM	1	0	21.09	17.59	33	-15.41
				1	49	21.06	17.56	33	-15.44
				25	12	20.10	16.60	33	-16.4
				50	0	20.15	16.65	33	-16.35
	40620	2593	16QAM	1	0	22.70	19.20	33	-13.8
				1	49	22.83	19.33	33	-13.67
				25	12	21.71	18.21	33	-14.79
				50	0	21.88	18.38	33	-14.62
	41540	2685	16QAM	1	0	21.29	17.79	33	-15.21
				1	49	21.11	17.61	33	-15.39
				25	12	20.02	16.52	33	-16.48
				50	0	20.27	16.77	33	-16.23
	39700	2501	64QAM	1	0	20.13	16.63	33	-16.37
				1	49	20.32	16.82	33	-16.18
				25	12	19.29	15.79	33	-17.21
				50	0	19.32	15.82	33	-17.18
	40620	2593	64QAM	1	0	22.07	18.57	33	-14.43
				1	49	22.02	18.52	33	-14.48
				25	12	21.06	17.56	33	-15.44
				50	0	20.79	17.29	33	-15.71
	41540	2685	64QAM	1	0	20.35	16.85	33	-16.15
				1	49	20.06	16.56	33	-16.44
				25	12	19.32	15.82	33	-17.18
				50	0	19.46	15.96	33	-17.04

Unless otherwise stated the results shown in this test report refer only to the sample(s) tested and such sample(s) are retained for 90 days only.

除非另有說明，此報告結果僅對測試之樣品負責，同時此樣品僅保留90天。本報告未經本公司書面許可，不可部份複製。

This document is issued by the Company subject to its General Conditions of Service printed overleaf, available on request or accessible at <http://www.sgs.com.tw/Terms-and-Conditions> and for electronic format documents, subject to Terms and Conditions for Electronic Documents at <http://www.sgs.com.tw/Terms-and-Conditions>. Attention is drawn to the limitation of liability, indemnification and jurisdiction issues defined therein. Any holder of this document is advised that information contained hereon reflects the Company's findings at the time of its intervention only and within the limits of Client's instructions, if any. The Company's sole responsibility is to its Client and this document does not exonerate parties to a transaction from exercising all their rights and obligations under the transaction documents. This document cannot be reproduced except in full, without prior written approval of the Company. Any unauthorized alteration, forgery or falsification of the content or appearance of this document is unlawful and offenders may be prosecuted to the fullest extent of the law.

Antenna gain (dBi) -3.5									
LTE Band 41_Uplink frequency band : 2496 to 2690 MHz									
BW (MHz)	UL Channel	Frequency (MHz)	Modulation	RB Size	RB Offset	Conducted Average (dBm)	EIRP Average (dBm)	EIRP Limit (dBm)	Margin (dB)
15	39725	2503.5	QPSK	1	0	22.12	18.62	33	-14.38
				1	74	22.05	18.55	33	-14.45
				36	18	21.20	17.70	33	-15.3
				75	0	21.21	17.71	33	-15.29
	40620	2593	QPSK	1	0	23.62	20.12	33	-12.88
				1	74	23.69	20.19	33	-12.81
				36	18	22.73	19.23	33	-13.77
				75	0	22.84	19.34	33	-13.66
	41515	2682.5	QPSK	1	0	22.09	18.59	33	-14.41
				1	74	22.20	18.70	33	-14.3
				36	18	21.11	17.61	33	-15.39
				75	0	21.12	17.62	33	-15.38
	39725	2503.5	16QAM	1	0	21.24	17.74	33	-15.26
				1	74	21.19	17.69	33	-15.31
				36	18	20.20	16.70	33	-16.3
				75	0	20.26	16.76	33	-16.24
	40620	2593	16QAM	1	0	22.83	19.33	33	-13.67
				1	74	22.84	19.34	33	-13.66
				36	18	21.73	18.23	33	-14.77
				75	0	21.89	18.39	33	-14.61
	41515	2682.5	16QAM	1	0	21.34	17.84	33	-15.16
				1	74	21.17	17.67	33	-15.33
				36	18	20.05	16.55	33	-16.45
				75	0	20.29	16.79	33	-16.21
	39725	2503.5	64QAM	1	0	20.19	16.69	33	-16.31
				1	74	20.45	16.95	33	-16.05
				36	18	19.46	15.96	33	-17.04
				75	0	19.43	15.93	33	-17.07
	40620	2593	64QAM	1	0	21.76	18.26	33	-14.74
				1	74	21.91	18.41	33	-14.59
				36	18	20.91	17.41	33	-15.59
				75	0	21.11	17.61	33	-15.39
	41515	2682.5	64QAM	1	0	20.33	16.83	33	-16.17
				1	74	20.06	16.56	33	-16.44
				36	18	19.48	15.98	33	-17.02
				75	0	19.13	15.63	33	-17.37

Unless otherwise stated the results shown in this test report refer only to the sample(s) tested and such sample(s) are retained for 90 days only.

除非另有說明，此報告結果僅對測試之樣品負責，同時此樣品僅保留90天。本報告未經本公司書面許可，不可部份複製。

This document is issued by the Company subject to its General Conditions of Service printed overleaf, available on request or accessible at <http://www.sgs.com.tw/Terms-and-Conditions> and for electronic format documents, subject to Terms and Conditions for Electronic Documents at <http://www.sgs.com.tw/Terms-and-Conditions>. Attention is drawn to the limitation of liability, indemnification and jurisdiction issues defined therein. Any holder of this document is advised that information contained hereon reflects the Company's findings at the time of its intervention only and within the limits of Client's instructions, if any. The Company's sole responsibility is to its Client and this document does not exonerate parties to a transaction from exercising all their rights and obligations under the transaction documents. This document cannot be reproduced except in full, without prior written approval of the Company. Any unauthorized alteration, forgery or falsification of the content or appearance of this document is unlawful and offenders may be prosecuted to the fullest extent of the law.

Antenna gain (dBi) -3.5									
LTE Band 41_Uplink frequency band : 2496 to 2690 MHz									
BW (MHz)	UL Channel	Frequency (MHz)	Modulation	RB Size	RB Offset	Conducted Average (dBm)	EIRP Average (dBm)	EIRP Limit (dBm)	Margin (dB)
20	39750	2506	QPSK	1	0	22.09	18.59	33	-14.41
				1	99	22.08	18.58	33	-14.42
				50	25	21.26	17.76	33	-15.24
				100	0	21.31	17.81	33	-15.19
	40620	2593	QPSK	1	0	23.62	20.12	33	-12.88
				1	99	23.59	20.09	33	-12.91
				50	25	22.76	19.26	33	-13.74
				100	0	22.86	19.36	33	-13.64
	41490	2680	QPSK	1	0	22.10	18.60	33	-14.4
				1	99	21.98	18.48	33	-14.52
				50	25	21.12	17.62	33	-15.38
				100	0	21.21	17.71	33	-15.29
	39750	2506	16QAM	1	0	21.22	17.72	33	-15.28
				1	99	21.23	17.73	33	-15.27
				50	25	20.22	16.72	33	-16.28
				100	0	20.37	16.87	33	-16.13
	40620	2593	16QAM	1	0	22.78	19.28	33	-13.72
				1	99	22.76	19.26	33	-13.74
				50	25	21.83	18.33	33	-14.67
				100	0	21.84	18.34	33	-14.66
	41490	2680	16QAM	1	0	21.36	17.86	33	-15.14
				1	99	21.13	17.63	33	-15.37
				50	25	20.30	16.80	33	-16.2
				100	0	20.17	16.67	33	-16.33
	39750	2506	64QAM	1	0	20.21	16.71	33	-16.29
				1	99	20.38	16.88	33	-16.12
				50	25	19.28	15.78	33	-17.22
				100	0	19.58	16.08	33	-16.92
	40620	2593	64QAM	1	0	21.94	18.44	33	-14.56
				1	99	21.96	18.46	33	-14.54
				50	25	21.00	17.50	33	-15.5
				100	0	20.97	17.47	33	-15.53
	41490	2680	64QAM	1	0	20.50	17.00	33	-16
				1	99	20.38	16.88	33	-16.12
				50	25	19.30	15.80	33	-17.2
				100	0	19.37	15.87	33	-17.13

Unless otherwise stated the results shown in this test report refer only to the sample(s) tested and such sample(s) are retained for 90 days only.

除非另有說明，此報告結果僅對測試之樣品負責，同時此樣品僅保留90天。本報告未經本公司書面許可，不可部份複製。

This document is issued by the Company subject to its General Conditions of Service printed overleaf, available on request or accessible at <http://www.sgs.com.tw/Terms-and-Conditions> and for electronic format documents, subject to Terms and Conditions for Electronic Documents at <http://www.sgs.com.tw/Terms-and-Conditions>. Attention is drawn to the limitation of liability, indemnification and jurisdiction issues defined therein. Any holder of this document is advised that information contained hereon reflects the Company's findings at the time of its intervention only and within the limits of Client's instructions, if any. The Company's sole responsibility is to its Client and this document does not exonerate parties to a transaction from exercising all their rights and obligations under the transaction documents. This document cannot be reproduced except in full, without prior written approval of the Company. Any unauthorized alteration, forgery or falsification of the content or appearance of this document is unlawful and offenders may be prosecuted to the fullest extent of the law.

7 OCCUPIED BANDWIDTH MEASUREMENT

7.1 Standard Applicable

The occupied bandwidth is the frequency bandwidth such that, below its lower and above its upper frequency limits, the mean powers radiated are each equal to 0.5 percent of the total mean power.

7.2 Test Set-up

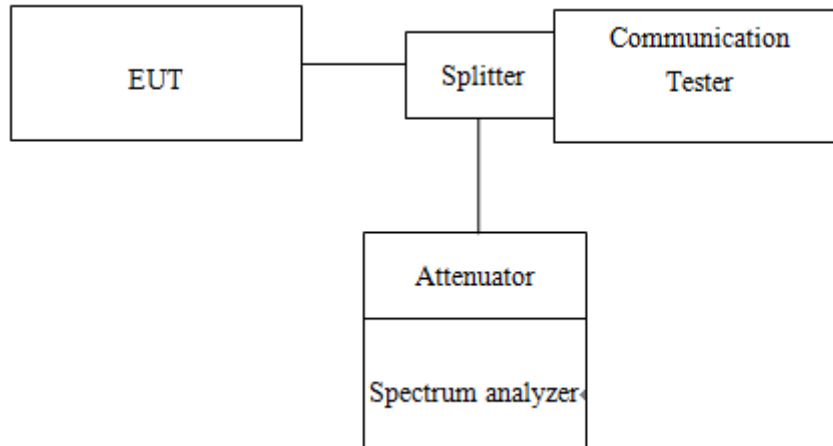

7.3 Measurement Procedure

99% & 26dB Bandwidth with detector peak

The EUT's output RF connector was connected with a short cable to the spectrum analyzer, RBW was set to about 1% of emission BW, VBW= 3 times RBW, -26dBc display line was placed on the screen (or 26dB bandwidth), the occupied bandwidth is the delta frequency between the two points where the display line intersects the signal trace. Then set RBW to 99% bandwidth, RBW= 1%, VBW= 3 * RBW, with span > 2 * Signal BW, set % Power = 99%.

Unless otherwise stated the results shown in this test report refer only to the sample(s) tested and such sample(s) are retained for 90 days only.

除非另有說明，此報告結果僅對測試之樣品負責，同時此樣品僅保留90天。本報告未經本公司書面許可，不可部份複製。

This document is issued by the Company subject to its General Conditions of Service printed overleaf, available on request or accessible at <http://www.sgs.com.tw/Terms-and-Conditions> and for electronic format documents, subject to Terms and Conditions for Electronic Documents at <http://www.sgs.com.tw/Terms-and-Conditions>. Attention is drawn to the limitation of liability, indemnification and jurisdiction issues defined therein. Any holder of this document is advised that information contained hereon reflects the Company's findings at the time of its intervention only and within the limits of Client's instructions, if any. The Company's sole responsibility is to its Client and this document does not exonerate parties to a transaction from exercising all their rights and obligations under the transaction documents. This document cannot be reproduced except in full, without prior written approval of the Company. Any unauthorized alteration, forgery or falsification of the content or appearance of this document is unlawful and offenders may be prosecuted to the fullest extent of the law.

7.4 Measurement Equipment Used

Conducted Emission (measured at antenna port) Test Site					
EQUIPMENT TYPE	MFR	MODEL NUMBER	SERIAL NUMBER	LAST CAL.	CAL DUE.
PXA Spectrum Analyzer	Agilent	N9030A	MY53120760	04/21/2020	04/20/2021
DC Power Supply	Agilent	E3640A	KR93300208	08/19/2020	08/18/2021
Radio Communication Analyser	Anritsu	MT8815B	6200711454	04/01/2020	03/31/2021
Temperature Chamber	TERCHY	MHG-120LF	911009	05/20/2020	05/19/2021
Attenuator	Mini-Circuit	BW-S10W2+	2	01/02/2020	01/01/2021
DC Block	Mini-Circuits	BLK-18-S+	1	01/02/2020	01/01/2021
Splitter	RF-LAMBAD	RFLT2W1G18G	11-JSPF412-018	01/02/2020	01/01/2021
Radio Communication Analyser	Anritsu	MT8821C	6261786084	01/18/2020	01/17/2021

7.5 Measurement Result

Freq. (MHz)	CH	99% BW (MHz)		26 dB BW (MHz)	
		GSM 850	GPRS 850	GSM 850	GPRS 850
824.2	128	0.24208	0.24286	0.3145	0.3074
836.6	190	0.24438	0.24564	0.3131	0.3145
848.8	251	0.24234	0.24472	0.3187	0.3215
Freq. (MHz)	CH	99% BW (MHz)		26 dB BW (MHz)	
		GSM 1900	GPRS 1900	GSM 1900	GPRS 1900
1850.2	512	0.24576	0.24045	0.3179	0.3153
1880.0	661	0.24868	0.24240	0.3190	0.3097
1909.8	810	0.24581	0.24296	0.3200	0.3154

Freq. (MHz)	CH	99% BW (MHz)			26 dB BW (MHz)		
		WCDMA II	HSDPA II	HSUPA II	WCDMA II	HSDPA II	HSUPA II
1852.40	9262	4.15250	4.15260	4.14710	4.704	4.708	4.693
1880.00	9400	4.14900	4.15000	4.14260	4.688	4.690	4.678
1907.60	9538	4.17090	4.15410	4.14970	4.696	4.671	4.688

Unless otherwise stated the results shown in this test report refer only to the sample(s) tested and such sample(s) are retained for 90 days only.

除非另有說明，此報告結果僅對測試之樣品負責，同時此樣品僅保留90天。本報告未經本公司書面許可，不可部份複製。

This document is issued by the Company subject to its General Conditions of Service printed overleaf, available on request or accessible at <http://www.sgs.com.tw/Terms-and-Conditions> and for electronic format documents, subject to Terms and Conditions for Electronic Documents at <http://www.sgs.com.tw/Terms-and-Conditions>. Attention is drawn to the limitation of liability, indemnification and jurisdiction issues defined therein. Any holder of this document is advised that information contained hereon reflects the Company's findings at the time of its intervention only and within the limits of Client's instructions, if any. The Company's sole responsibility is to its Client and this document does not exonerate parties to a transaction from exercising all their rights and obligations under the transaction documents. This document cannot be reproduced except in full, without prior written approval of the Company. Any unauthorized alteration, forgery or falsification of the content or appearance of this document is unlawful and offenders may be prosecuted to the fullest extent of the law.

Freq. (MHz)	CH	99% BW (MHz)			26 dB BW (MHz)		
		WCDMA V	HSDPA V	HSUPA V	WCDMA V	HSDPA V	HSUPA V
826.40	4132	4.14860	4.13990	4.12490	4.682	4.675	4.683
836.60	4183	4.14350	4.14830	4.13610	4.693	4.690	4.693
846.60	4233	4.14350	4.13630	4.14230	4.697	4.669	4.679

LTE BAND 2 Channel bandwidth: 1.4MHz							
Freq. (MHz)	CH	99% BW (MHz)			26 dB BW (MHz)		
		QPSK	16QAM	64QAM	QPSK	16QAM	64QAM
1850.7	18607	1.0950	1.0969	1.0963	1.241	1.238	1.239
1880.0	18900	1.0949	1.0969	1.0964	1.240	1.239	1.235
1909.3	19193	1.0950	1.0972	1.0957	1.240	1.240	1.238

LTE BAND 2 Channel bandwidth: 3MHz							
Freq. (MHz)	CH	99% BW (MHz)			26 dB BW (MHz)		
		QPSK	16QAM	64QAM	QPSK	16QAM	64QAM
1851.5	18615	2.6972	2.6986	2.7006	2.989	3.012	2.992
1880.0	18900	2.6985	2.6992	2.7005	2.983	3.017	2.986
1908.5	19185	2.6971	2.6995	2.6985	2.991	3.012	2.996

LTE BAND 2 Channel bandwidth: 5MHz							
Freq. (MHz)	CH	99% BW (MHz)			26 dB BW (MHz)		
		QPSK	16QAM	64QAM	QPSK	16QAM	64QAM
1852.5	18625	4.5005	4.5015	4.5111	4.993	4.975	4.970
1880.0	18900	4.5012	4.4962	4.5081	5.012	4.983	4.962
1907.5	19175	4.4998	4.5003	4.5127	5.007	4.980	4.987

LTE BAND 2 Channel bandwidth: 10MHz							
Freq. (MHz)	CH	99% BW (MHz)			26 dB BW (MHz)		
		QPSK	16QAM	64QAM	QPSK	16QAM	64QAM
1855.0	18650	9.0235	8.9758	8.9964	9.843	9.751	9.820
1880.0	18900	9.0282	8.9731	9.0067	9.870	9.798	9.880
1905.0	19150	9.0235	8.9755	9.0044	9.844	9.807	9.880

LTE BAND 2 Channel bandwidth: 15MHz							
Freq. (MHz)	CH	99% BW (MHz)			26 dB BW (MHz)		
		QPSK	16QAM	64QAM	QPSK	16QAM	64QAM
1857.5	18675	13.478	13.456	13.458	14.657	14.814	15.403
1880.0	18900	13.513	13.492	13.486	20.689	15.569	19.146
1902.5	19125	13.468	13.464	13.455	14.718	14.693	14.709

LTE BAND 2 Channel bandwidth: 20MHz							
Freq. (MHz)	CH	99% BW (MHz)			26 dB BW (MHz)		
		QPSK	16QAM	64QAM	QPSK	16QAM	64QAM
1860.0	18700	17.822	17.948	17.933	18.939	20.161	19.501
1880.0	18900	17.987	18.022	17.988	19.595	23.204	19.558
1900.0	19100	17.933	17.936	17.969	20.871	19.921	19.545

LTE BAND 5 Channel bandwidth: 1.4MHz							
Freq. (MHz)	CH	99% BW (MHz)			26 dB BW (MHz)		
		QPSK	16QAM	64QAM	QPSK	16QAM	64QAM
824.7	20407	1.0930	1.0951	1.0963	1.238	1.236	1.236
836.5	20525	1.0950	1.0977	1.0962	1.241	1.238	1.232
848.3	20643	1.0940	1.0955	1.0955	1.239	1.239	1.235

LTE BAND 5 Channel bandwidth: 3MHz							
Freq. (MHz)	CH	99% BW (MHz)			26 dB BW (MHz)		
		QPSK	16QAM	64QAM	QPSK	16QAM	64QAM
825.5	20415	2.6969	2.7011	2.7013	2.984	3.012	2.987
836.5	20525	2.6979	2.6988	2.7000	2.993	2.999	2.986
847.5	20635	2.6964	2.6973	2.6972	2.996	3.008	2.987

LTE BAND 5 Channel bandwidth: 5MHz							
Freq. (MHz)	CH	99% BW (MHz)			26 dB BW (MHz)		
		QPSK	16QAM	64QAM	QPSK	16QAM	64QAM
826.5	20425	4.4968	4.4937	4.5009	4.996	4.973	4.988
836.5	20525	4.4955	4.4962	4.5088	4.981	4.940	4.967
846.5	20625	4.4924	4.4915	4.5031	4.975	4.963	4.965

LTE BAND 5 Channel bandwidth: 10MHz							
Freq. (MHz)	CH	99% BW (MHz)			26 dB BW (MHz)		
		QPSK	16QAM	64QAM	QPSK	16QAM	64QAM
829.0	20450	9.0087	8.9552	8.9771	9.894	9.793	9.821
836.5	20525	9.0055	8.9505	8.9764	9.817	9.781	9.829
844.0	20600	8.9909	8.9491	8.9687	9.809	9.757	9.759

Unless otherwise stated the results shown in this test report refer only to the sample(s) tested and such sample(s) are retained for 90 days only.

除非另有說明，此報告結果僅對測試之樣品負責，同時此樣品僅保留90天。本報告未經本公司書面許可，不可部份複製。

This document is issued by the Company subject to its General Conditions of Service printed overleaf, available on request or accessible at <http://www.sgs.com.tw/Terms-and-Conditions> and for electronic format documents, subject to Terms and Conditions for Electronic Documents at <http://www.sgs.com.tw/Terms-and-Conditions>. Attention is drawn to the limitation of liability, indemnification and jurisdiction issues defined therein. Any holder of this document is advised that information contained hereon reflects the Company's findings at the time of its intervention only and within the limits of Client's instructions, if any. The Company's sole responsibility is to its Client and this document does not exonerate parties to a transaction from exercising all their rights and obligations under the transaction documents. This document cannot be reproduced except in full, without prior written approval of the Company. Any unauthorized alteration, forgery or falsification of the content or appearance of this document is unlawful and offenders may be prosecuted to the fullest extent of the law.

LTE BAND 7 Channel bandwidth: 5MHz								LTE BAND 7 Channel bandwidth: 10MHz							
Freq. (MHz)	CH	99% BW (MHz)			26 dB BW (MHz)			Freq. (MHz)	CH	99% BW (MHz)			26 dB BW (MHz)		
		QPSK	16QAM	64QAM	QPSK	16QAM	64QAM			QPSK	16QAM	64QAM	QPSK	16QAM	64QAM
2502.5	20775	4.5019	4.4986	4.5067	4.986	4.998	4.970	2505.0	20800	9.0187	8.9686	8.9866	9.842	9.788	9.810
2535.0	21100	4.4987	4.5033	4.5075	4.992	4.996	4.977	2535.0	21100	9.0186	8.9788	8.9924	9.847	9.758	9.856
2567.5	21425	4.4997	4.5004	4.5019	4.996	5.007	4.973	2565.0	21400	9.0185	8.9751	8.9972	9.844	9.795	9.869

LTE BAND 7 Channel bandwidth: 15MHz								LTE BAND 7 Channel bandwidth: 20MHz							
Freq. (MHz)	CH	99% BW (MHz)			26 dB BW (MHz)			Freq. (MHz)	CH	99% BW (MHz)			26 dB BW (MHz)		
		QPSK	16QAM	64QAM	QPSK	16QAM	64QAM			QPSK	16QAM	64QAM	QPSK	16QAM	64QAM
2507.5	20825	13.458	13.459	13.454	14.769	14.795	14.765	2510.0	20850	17.944	17.955	17.970	19.414	22.170	19.561
2535.0	21100	13.488	13.479	13.475	14.699	20.475	14.722	2535.0	21100	17.974	17.991	17.970	23.073	21.648	19.506
2562.5	21375	13.477	13.480	13.459	14.733	16.787	14.689	2560.0	21350	17.955	18.005	17.976	19.546	20.969	19.577

LTE BAND 38 Channel bandwidth: 5MHz								LTE BAND 38 Channel bandwidth: 10MHz							
Freq. (MHz)	CH	99% BW (MHz)			26 dB BW (MHz)			Freq. (MHz)	CH	99% BW (MHz)			26 dB BW (MHz)		
		QPSK	16QAM	64QAM	QPSK	16QAM	64QAM			QPSK	16QAM	64QAM	QPSK	16QAM	64QAM
2572.5	37775	4.5014	4.5061	4.5079	5.102	5.182	4.943	2575.0	37800	8.9738	8.9777	8.9835	9.894	9.927	10.252
2595.0	38000	4.5080	4.5055	4.4993	5.151	5.151	4.942	2595.0	38000	8.9962	8.9838	8.9945	9.706	9.760	10.325
2617.5	38225	4.5106	4.5073	4.5048	5.137	5.206	4.958	2615.0	38200	8.9896	8.9735	8.9973	9.876	10.083	10.060

LTE BAND 38 Channel bandwidth: 15MHz								LTE BAND 38 Channel bandwidth: 20MHz							
Freq. (MHz)	CH	99% BW (MHz)			26 dB BW (MHz)			Freq. (MHz)	CH	99% BW (MHz)			26 dB BW (MHz)		
		QPSK	16QAM	64QAM	QPSK	16QAM	64QAM			QPSK	16QAM	64QAM	QPSK	16QAM	64QAM
2577.5	37825	13.502	13.488	13.460	15.848	14.835	14.870	2580.0	37850	17.958	18.009	17.966	19.513	21.449	20.352
2595.0	38000	13.511	13.485	13.488	15.571	15.392	15.021	2595.0	38000	17.968	17.949	17.966	20.877	20.484	20.106
2612.5	38175	13.510	13.492	13.474	15.134	15.037	14.950	2610.0	38150	17.963	17.963	17.967	19.498	20.551	20.756

LTE BAND 41 Channel bandwidth: 5MHz								LTE BAND 41 Channel bandwidth: 10MHz							
Freq. (MHz)	CH	99% BW (MHz)			26 dB BW (MHz)			Freq. (MHz)	CH	99% BW (MHz)			26 dB BW (MHz)		
		QPSK	16QAM	64QAM	QPSK	16QAM	64QAM			QPSK	16QAM	64QAM	QPSK	16QAM	64QAM
2498.5	39675	4.5085	4.5044	4.5071	5.115	5.159	4.954	2501.0	39700	8.9815	8.9759	8.9872	10.217	9.741	10.043
2593.0	40620	4.5151	4.5067	4.5010	5.142	5.231	4.942	2593.0	40620	9.0055	8.9796	8.9759	9.911	9.890	9.940
2687.5	41565	4.5142	4.5010	4.5103	5.127	5.228	4.941	2685.0	41540	9.0034	8.9783	8.9868	9.935	9.789	10.095

LTE BAND 41 Channel bandwidth: 15MHz								LTE BAND 41 Channel bandwidth: 20MHz							
Freq. (MHz)	CH	99% BW (MHz)			26 dB BW (MHz)			Freq. (MHz)	CH	99% BW (MHz)			26 dB BW (MHz)		
		QPSK	16QAM	64QAM	QPSK	16QAM	64QAM			QPSK	16QAM	64QAM	QPSK	16QAM	64QAM
2503.5	39725	13.481	13.484	13.462	15.372	14.765	14.807	2506.0	39750	17.952	17.940	17.955	20.095	19.666	20.644
2593.0	40620	13.491	13.509	13.463	16.667	19.430	16.037	2593.0	40620	17.961	17.930	17.980	19.873	19.983	21.644
2682.5	41515	13.465	13.493	13.450	15.383	14.762	15.207	2680.0	41490	17.926	17.974	17.949	20.482	20.307	21.174

Unless otherwise stated the results shown in this test report refer only to the sample(s) tested and such sample(s) are retained for 90 days only.

除非另有說明，此報告結果僅對測試之樣品負責，同時此樣品僅保留90天。本報告未經本公司書面許可，不可部份複製。

This document is issued by the Company subject to its General Conditions of Service printed overleaf, available on request or accessible at <http://www.sgs.com.tw/Terms-and-Conditions> and for electronic format documents, subject to Terms and Conditions for Electronic Documents at <http://www.sgs.com.tw/Terms-and-Conditions>. Attention is drawn to the limitation of liability, indemnification and jurisdiction issues defined therein. Any holder of this document is advised that information contained hereon reflects the Company's findings at the time of its intervention only and within the limits of Client's instructions, if any. The Company's sole responsibility is to its Client and this document does not exonerate parties to a transaction from exercising all their rights and obligations under the transaction documents. This document cannot be reproduced except in full, without prior written approval of the Company. Any unauthorized alteration, forgery or falsification of the content or appearance of this document is unlawful and offenders may be prosecuted to the fullest extent of the law.

GSM_850MHz_LowCH128-824.2

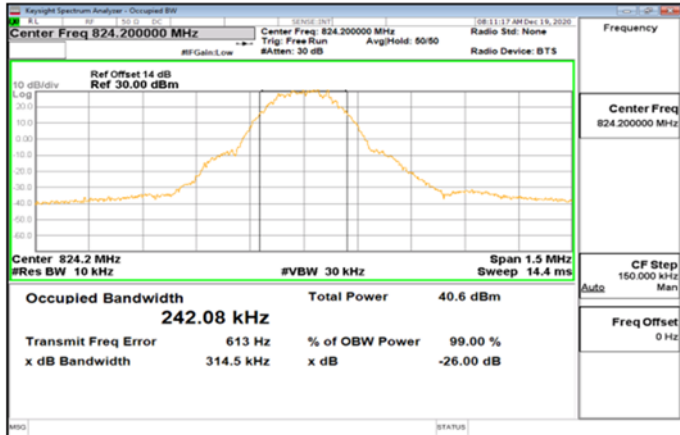

GRPS_850MHz_LowCH128-824.2

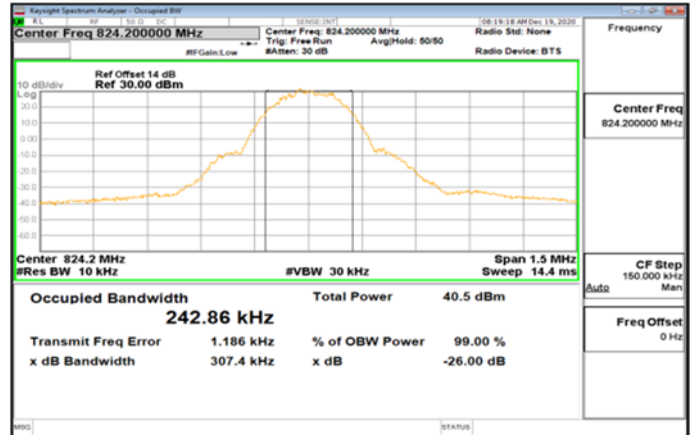

GSM_850MHz_MidCH190-836.6

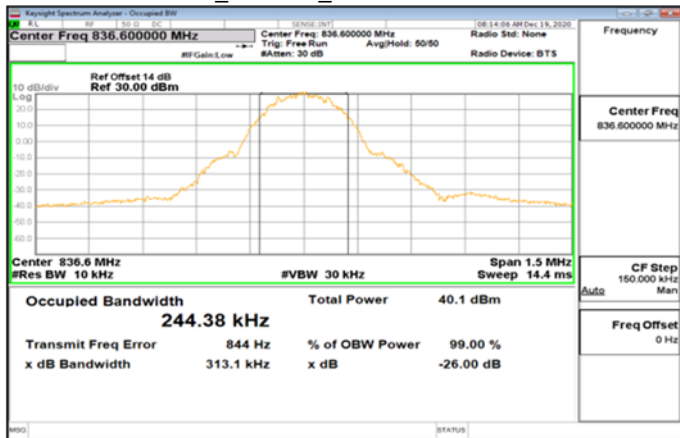

GRPS_850MHz_MidCH190-836.6

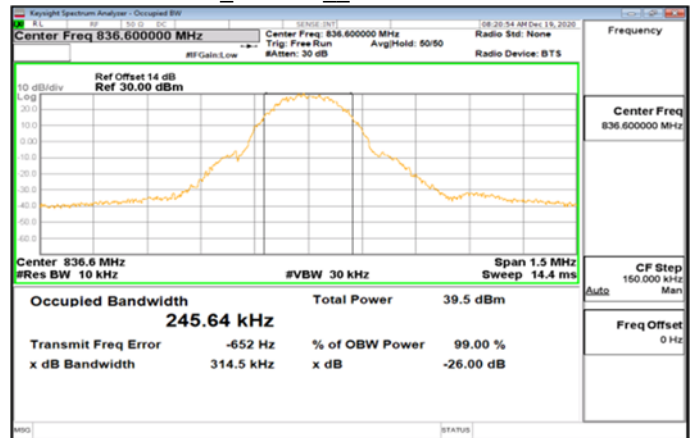

GSM_850MHz_HighCH251-848.8

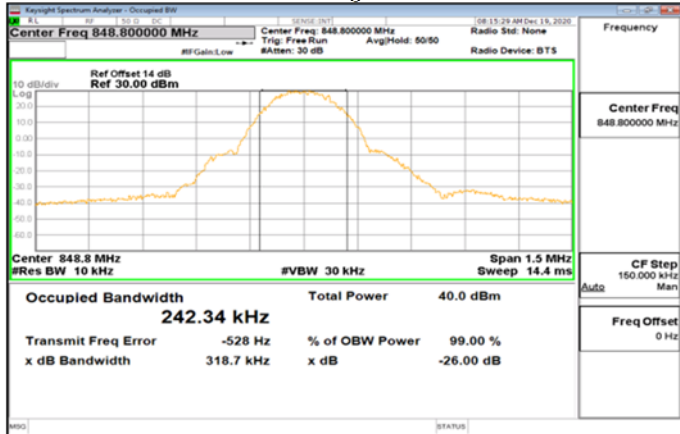

GRPS_850MHz_HighCH251-848.8

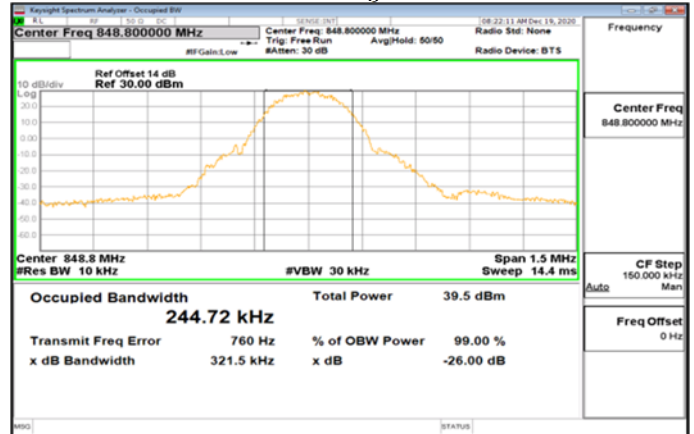

Unless otherwise stated the results shown in this test report refer only to the sample(s) tested and such sample(s) are retained for 90 days only.

除非另有說明，此報告結果僅對測試之樣品負責，同時此樣品僅保留90天。本報告未經本公司書面許可，不可部份複製。

This document is issued by the Company subject to its General Conditions of Service printed overleaf, available on request or accessible at <http://www.sgs.com.tw/Terms-and-Conditions> and for electronic format documents, subject to Terms and Conditions for Electronic Documents at <http://www.sgs.com.tw/Terms-and-Conditions>. Attention is drawn to the limitation of liability, indemnification and jurisdiction issues defined therein. Any holder of this document is advised that information contained herein reflects the Company's findings at the time of its intervention only and within the limits of Client's instructions, if any. The Company's sole responsibility is to its Client and this document does not exonerate parties to a transaction from exercising all their rights and obligations under the transaction documents. This document cannot be reproduced except in full, without prior written approval of the Company. Any unauthorized alteration, forgery or falsification of the content or appearance of this document is unlawful and offenders may be prosecuted to the fullest extent of the law.

GSM_1900MHz_LowCH512-1850.2

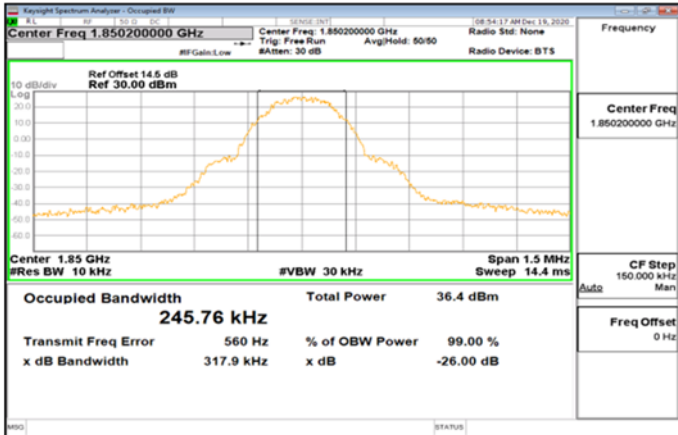

GPRS_1900MHz_LowCH512-1850.2

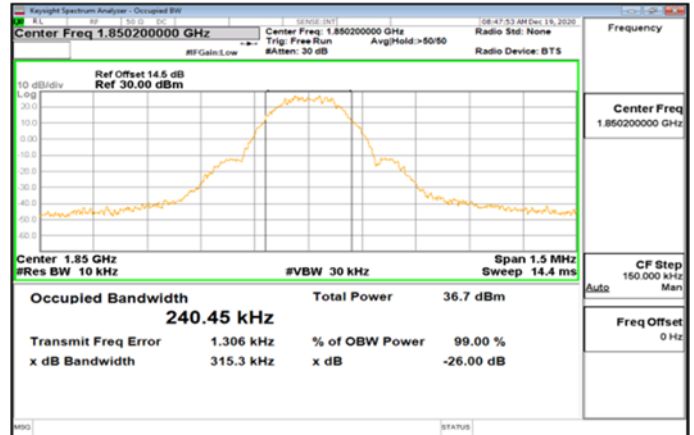

GSM_1900MHz_MidCH661-1880

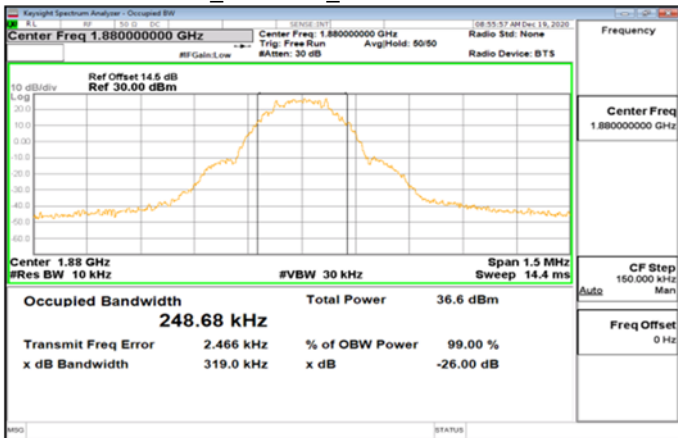

GPRS_1900MHz_MidCH661-1880

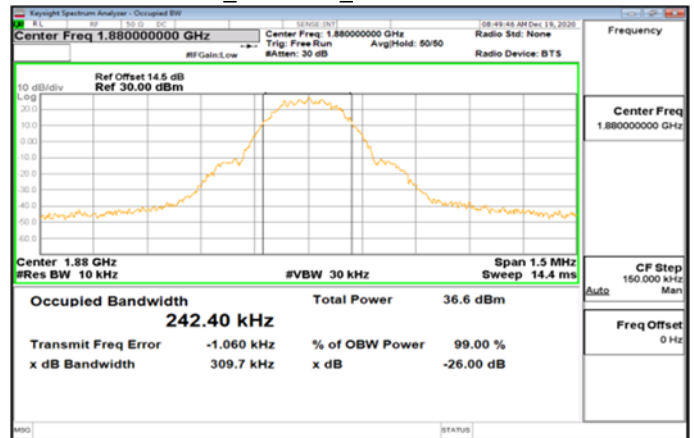

GSM_1900MHz_HighCH810-1909.8

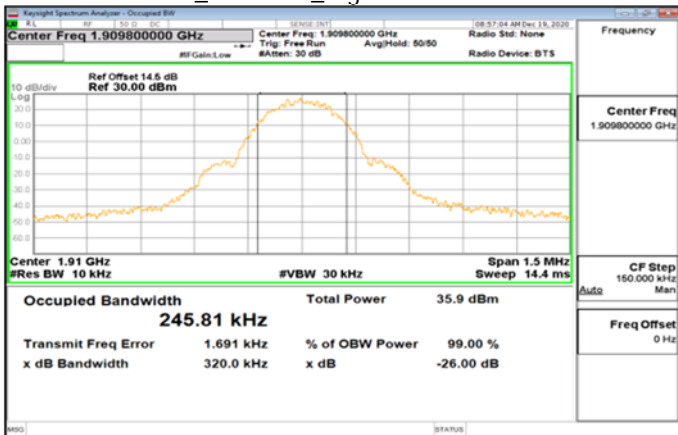

GPRS_1900MHz_HighCH810-1909.8

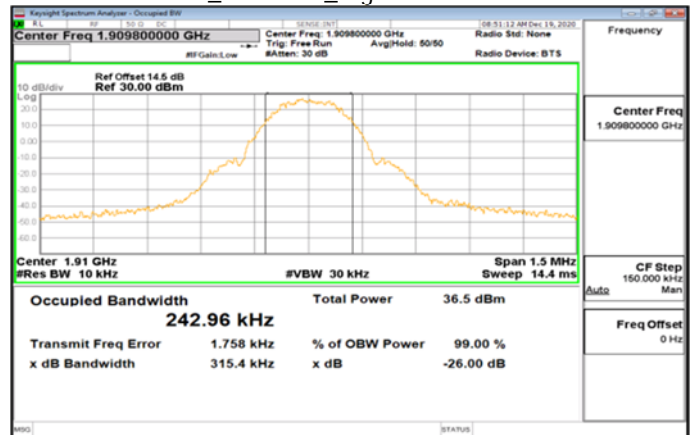

Unless otherwise stated the results shown in this test report refer only to the sample(s) tested and such sample(s) are retained for 90 days only.

除非另有說明，此報告結果僅對測試之樣品負責，同時此樣品僅保留90天。本報告未經本公司書面許可，不可部份複製。

This document is issued by the Company subject to its General Conditions of Service printed overleaf, available on request or accessible at <http://www.sgs.com.tw/Terms-and-Conditions> and for electronic format documents, subject to Terms and Conditions for Electronic Documents at <http://www.sgs.com.tw/Terms-and-Conditions>. Attention is drawn to the limitation of liability, indemnification and jurisdiction issues defined therein. Any holder of this document is advised that information contained herein reflects the Company's findings at the time of its intervention only and within the limits of Client's instructions, if any. The Company's sole responsibility is to its Client and this document does not exonerate parties to a transaction from exercising all their rights and obligations under the transaction documents. This document cannot be reproduced except in full, without prior written approval of the Company. Any unauthorized alteration, forgery or falsification of the content or appearance of this document is unlawful and offenders may be prosecuted to the fullest extent of the law.

WCDMA_B2_LowCH9262-1852.4

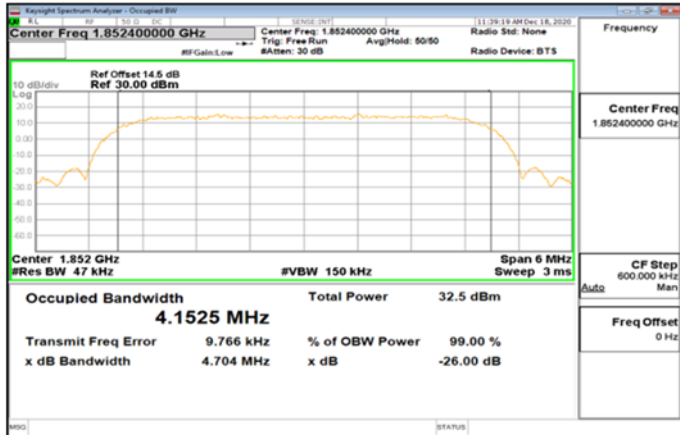

HSDPA_B2_LowCH9262-1852.4

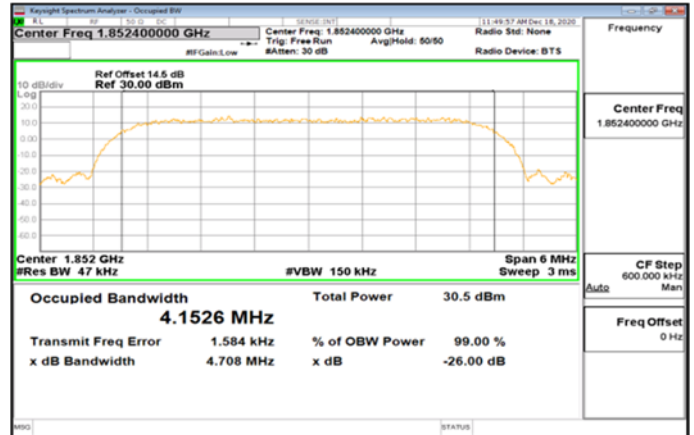

WCDMA_B2_MidCH9400-1880

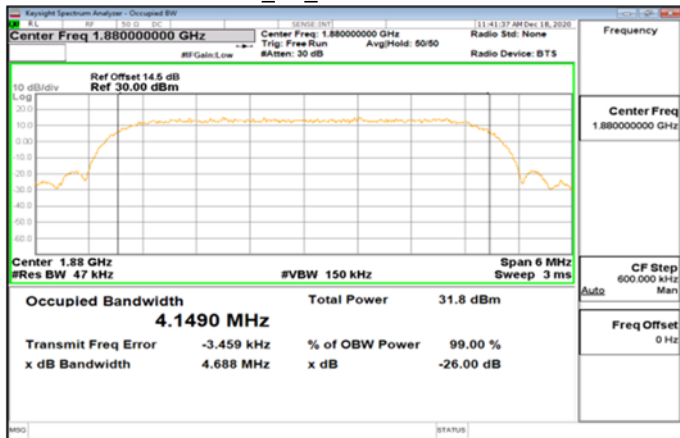

HSDPA_B2_MidCH9400-1880

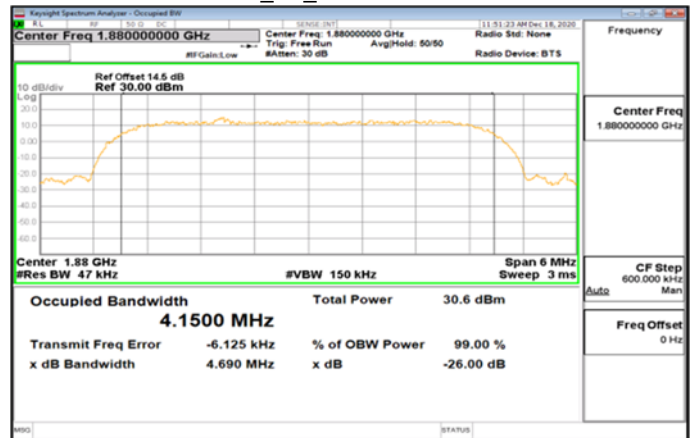

WCDMA_B2_HighCH9538-1907.6

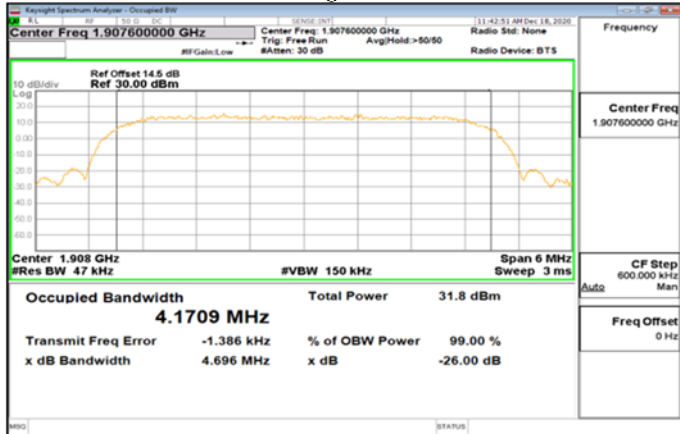

HSDPA_B2_HighCH9538-1907.6

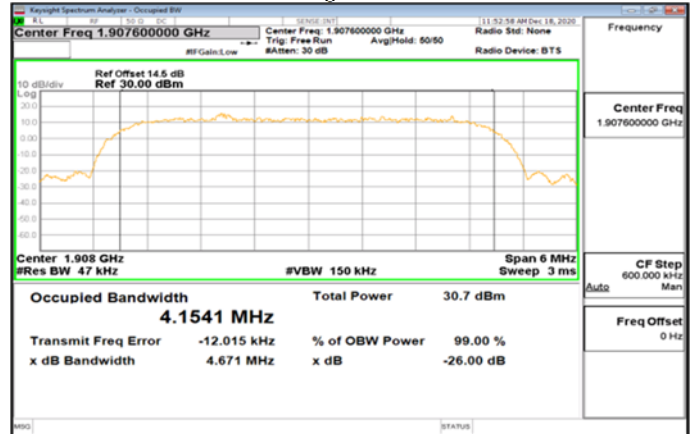

Unless otherwise stated the results shown in this test report refer only to the sample(s) tested and such sample(s) are retained for 90 days only.

除非另有說明，此報告結果僅對測試之樣品負責，同時此樣品僅保留90天。本報告未經本公司書面許可，不可部份複製。

This document is issued by the Company subject to its General Conditions of Service printed overleaf, available on request or accessible at <http://www.sgs.com.tw/Terms-and-Conditions> and for electronic format documents, subject to Terms and Conditions for Electronic Documents at <http://www.sgs.com.tw/Terms-and-Conditions>. Attention is drawn to the limitation of liability, indemnification and jurisdiction issues defined therein. Any holder of this document is advised that information contained herein reflects the Company's findings at the time of its intervention only and within the limits of Client's instructions, if any. The Company's sole responsibility is to its Client and this document does not exonerate parties to a transaction from exercising all their rights and obligations under the transaction documents. This document cannot be reproduced except in full, without prior written approval of the Company. Any unauthorized alteration, forgery or falsification of the content or appearance of this document is unlawful and offenders may be prosecuted to the fullest extent of the law.

HSDPA_B5_LowCH4132-826.4

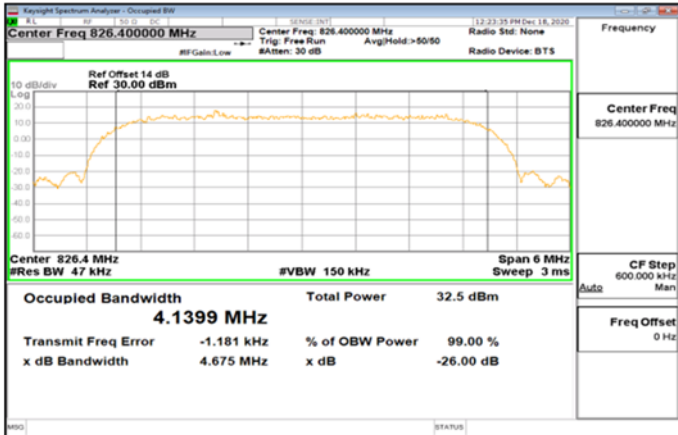

HSUPA_B5_LowCH4132-826.4

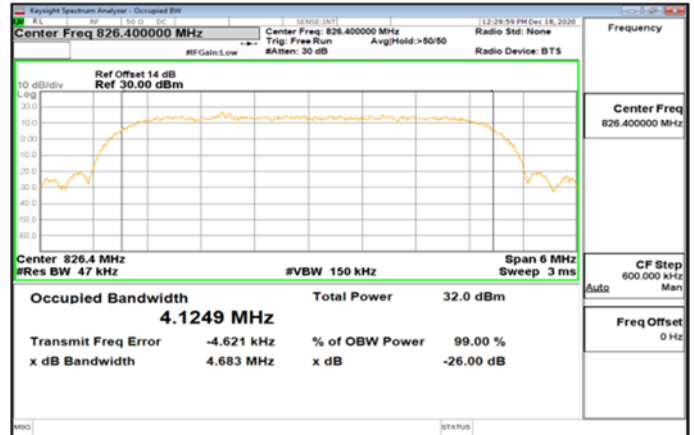

HSDPA_B5_MidCH4183-836.6

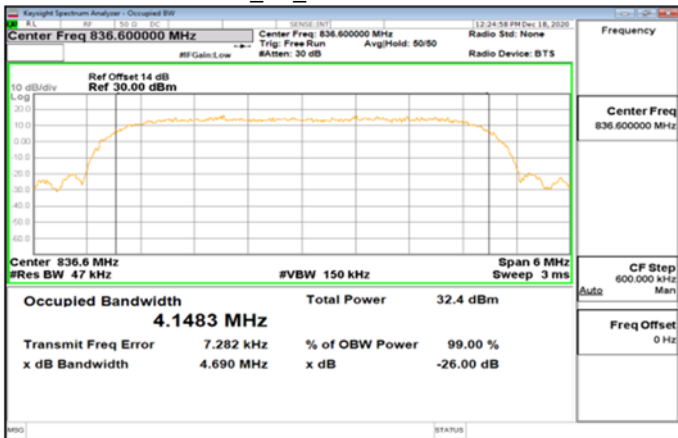

HSUPA_B5_MidCH4183-836.6

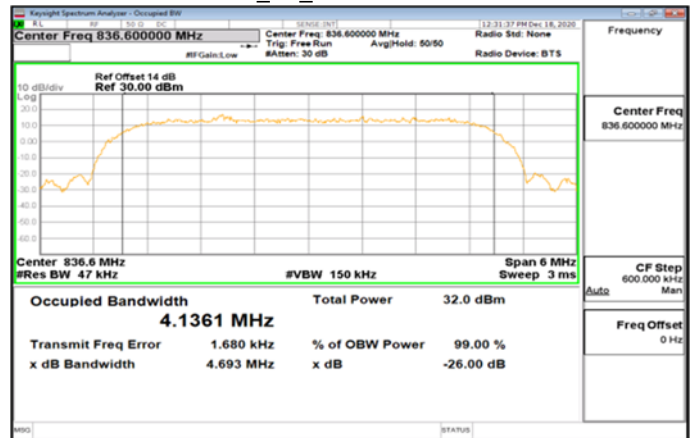

HSDPA_B5_HighCH4233-846.6

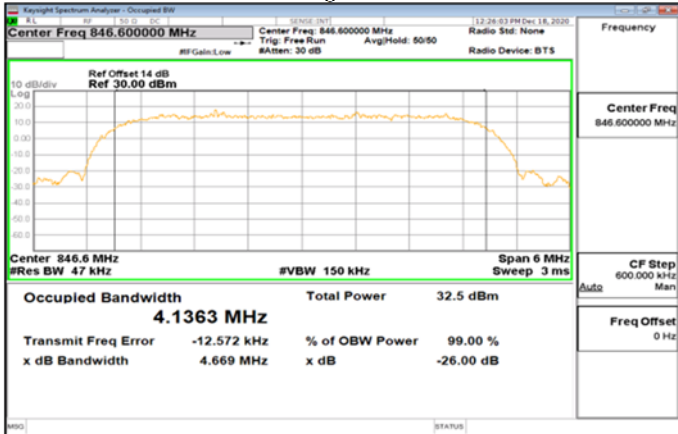

HSUPA_B5_HighCH4233-846.6

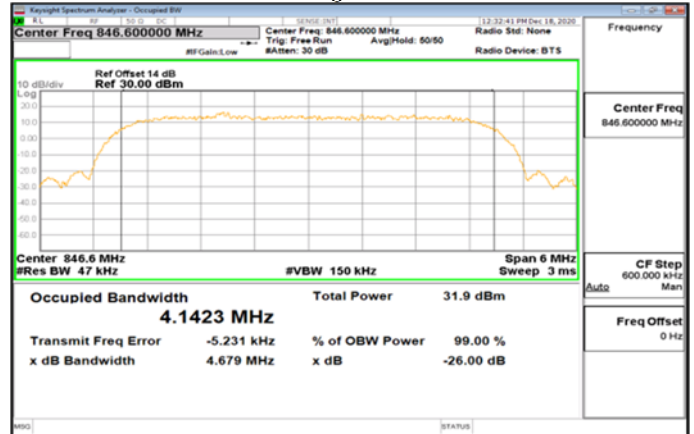

Unless otherwise stated the results shown in this test report refer only to the sample(s) tested and such sample(s) are retained for 90 days only.

除非另有說明，此報告結果僅對測試之樣品負責，同時此樣品僅保留90天。本報告未經本公司書面許可，不可部份複製。

This document is issued by the Company subject to its General Conditions of Service printed overleaf, available on request or accessible at <http://www.sgs.com.tw/Terms-and-Conditions> and for electronic format documents, subject to Terms and Conditions for Electronic Documents at <http://www.sgs.com.tw/Terms-and-Conditions>. Attention is drawn to the limitation of liability, indemnification and jurisdiction issues defined therein. Any holder of this document is advised that information contained herein reflects the Company's findings at the time of its intervention only and within the limits of Client's instructions, if any. The Company's sole responsibility is to its Client and this document does not exonerate parties to a transaction from exercising all their rights and obligations under the transaction documents. This document cannot be reproduced except in full, without prior written approval of the Company. Any unauthorized alteration, forgery or falsification of the content or appearance of this document is unlawful and offenders may be prosecuted to the fullest extent of the law.

Band2_1_4MHz_QPSK_6_0_Main_LowCH18607-1850.7

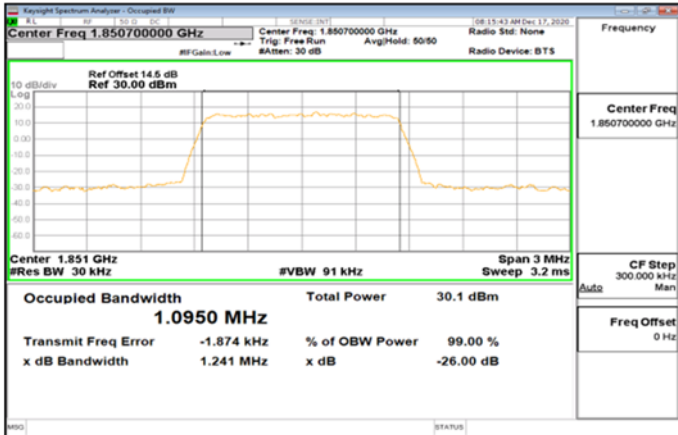

Band2_1_4MHz_16QAM_6_0_Main_LowCH18607-1850.7

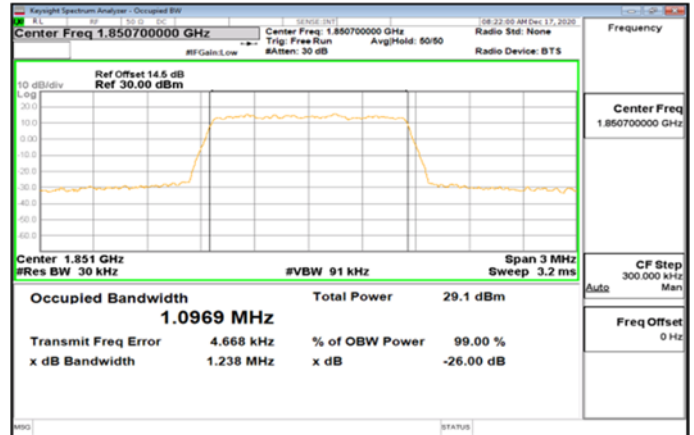

Band2_1_4MHz_QPSK_6_0_Main_MidCH18900-1880

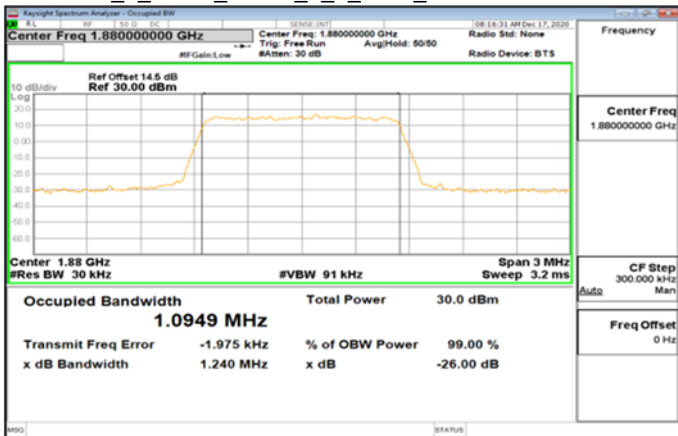

Band2_1_4MHz_16QAM_6_0_Main_MidCH18900-1880

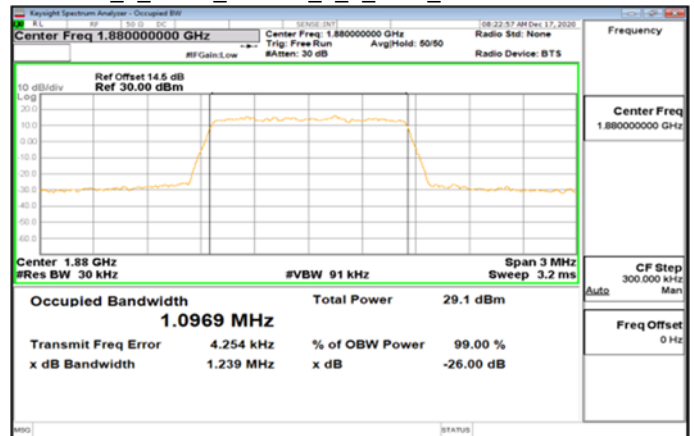

Band2_1_4MHz_QPSK_6_0_Main_HighCH19193-1909.3

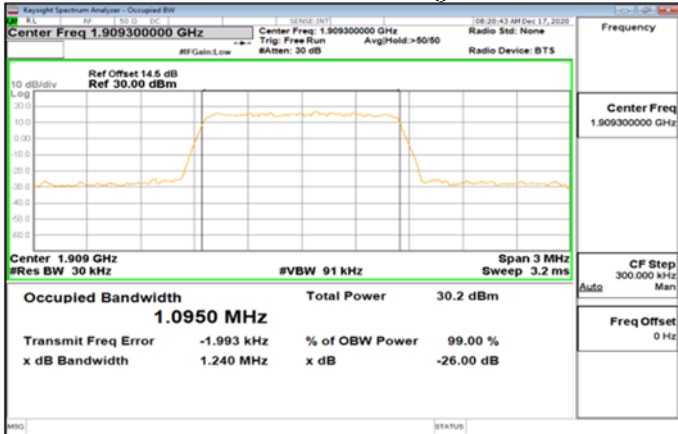

Band2_1_4MHz_16QAM_6_0_Main_HighCH19193-1909.3

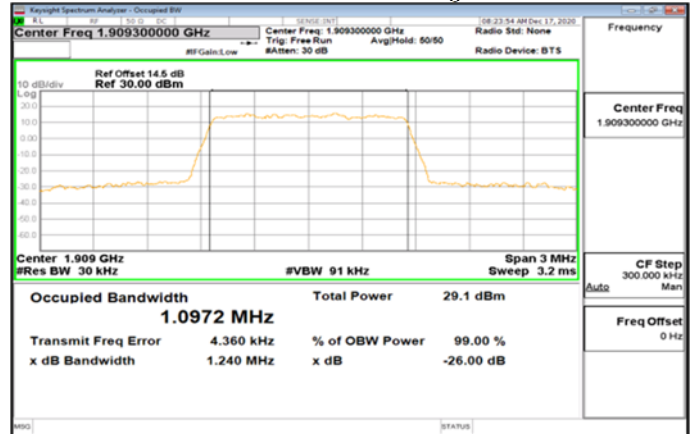

Unless otherwise stated the results shown in this test report refer only to the sample(s) tested and such sample(s) are retained for 90 days only.

除非另有說明，此報告結果僅對測試之樣品負責，同時此樣品僅保留90天。本報告未經本公司書面許可，不可部份複製。

This document is issued by the Company subject to its General Conditions of Service printed overleaf, available on request or accessible at <http://www.sgs.com.tw/Terms-and-Conditions> and for electronic format documents, subject to Terms and Conditions for Electronic Documents at <http://www.sgs.com.tw/Terms-and-Conditions>. Attention is drawn to the limitation of liability, indemnification and jurisdiction issues defined therein. Any holder of this document is advised that information contained herein reflects the Company's findings at the time of its intervention only and within the limits of Client's instructions, if any. The Company's sole responsibility is to its Client and this document does not exonerate parties to a transaction from exercising all their rights and obligations under the transaction documents. This document cannot be reproduced except in full, without prior written approval of the Company. Any unauthorized alteration, forgery or falsification of the content or appearance of this document is unlawful and offenders may be prosecuted to the fullest extent of the law.

Band2_1_4MHz_64QAM_6_0_Main_LowCH18607-1850.7

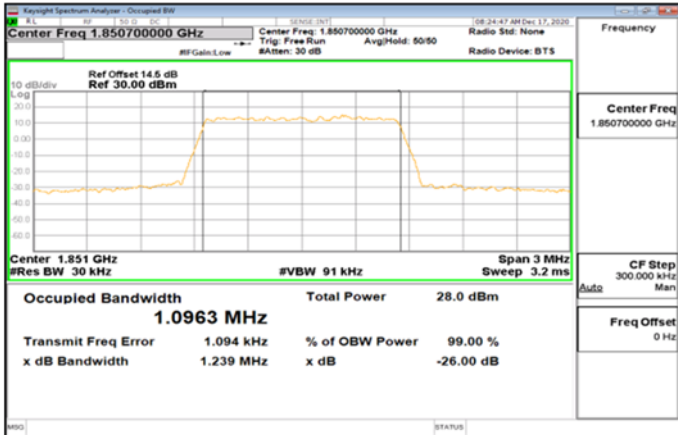

Band2_3MHz_QPSK_15_0_Main_LowCH18615-1851.5

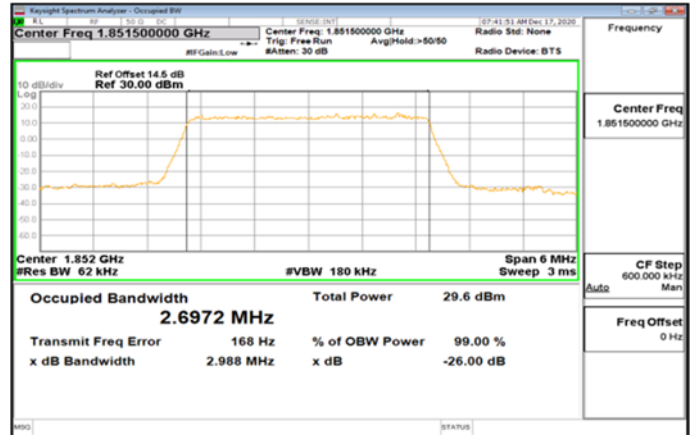

Band2_1_4MHz_64QAM_6_0_Main_MidCH18900-1880

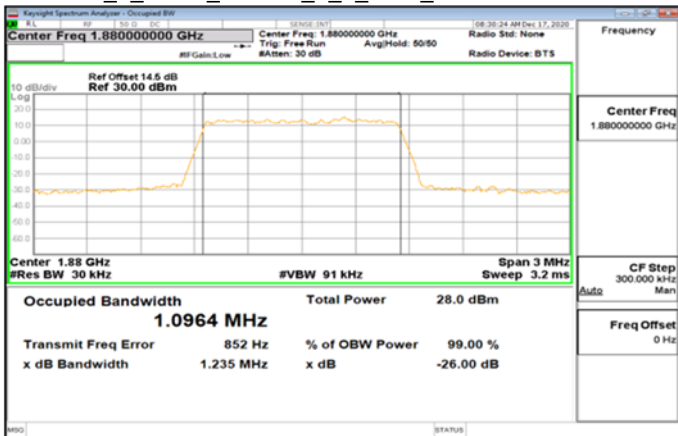

Band2_3MHz_QPSK_15_0_Main_MidCH18900-1880

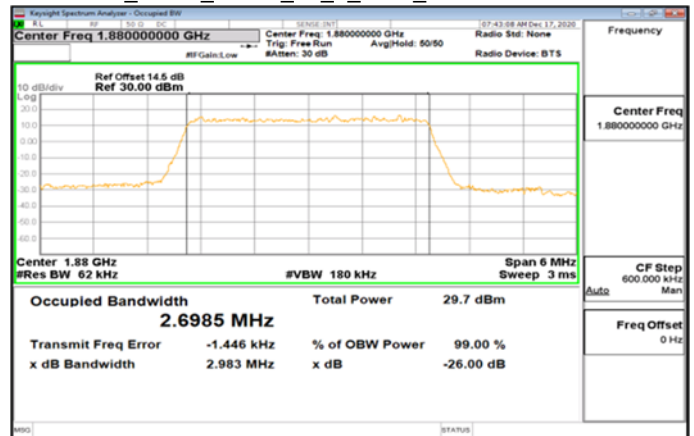

Band2_1_4MHz_64QAM_6_0_Main_HighCH19193-1909.3

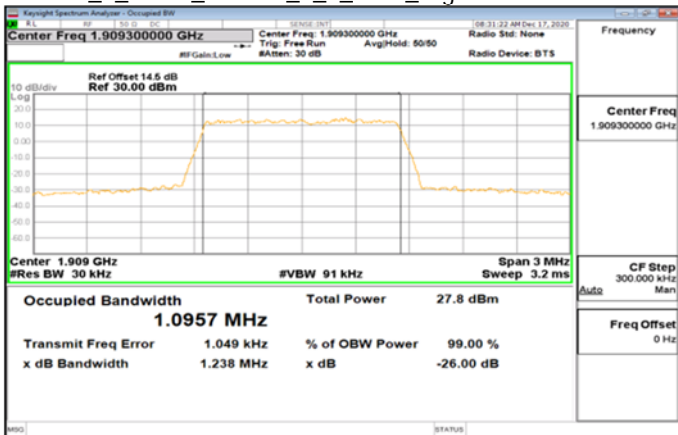

Band2_3MHz_QPSK_15_0_Main_HighCH19185-1908.5

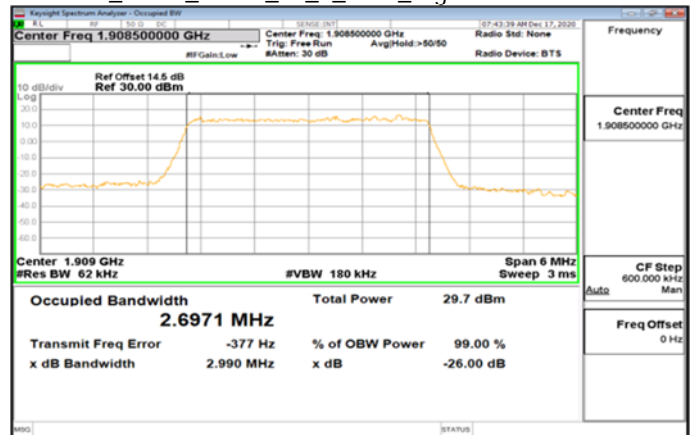

Unless otherwise stated the results shown in this test report refer only to the sample(s) tested and such sample(s) are retained for 90 days only.

除非另有說明，此報告結果僅對測試之樣品負責，同時此樣品僅保留90天。本報告未經本公司書面許可，不可部份複製。

This document is issued by the Company subject to its General Conditions of Service printed overleaf, available on request or accessible at <http://www.sgs.com.tw/Terms-and-Conditions> and for electronic format documents, subject to Terms and Conditions for Electronic Documents at <http://www.sgs.com.tw/Terms-and-Conditions>. Attention is drawn to the limitation of liability, indemnification and jurisdiction issues defined therein. Any holder of this document is advised that information contained herein reflects the Company's findings at the time of its intervention only and within the limits of Client's instructions, if any. The Company's sole responsibility is to its Client and this document does not exonerate parties to a transaction from exercising all their rights and obligations under the transaction documents. This document cannot be reproduced except in full, without prior written approval of the Company. Any unauthorized alteration, forgery or falsification of the content or appearance of this document is unlawful and offenders may be prosecuted to the fullest extent of the law.

Band2_3MHz_16QAM_15_0_Main_LowCH18615-1851.5

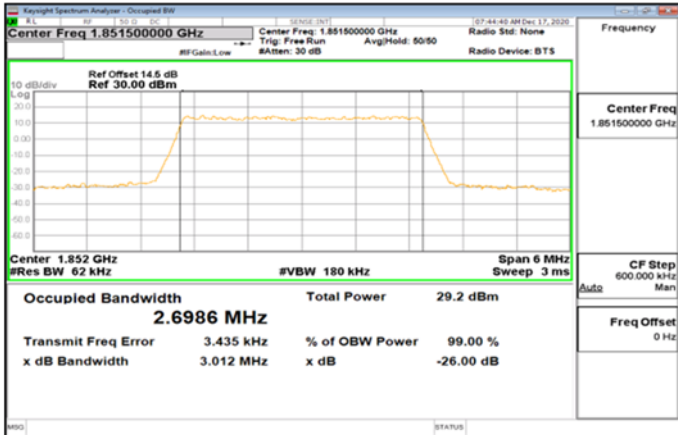

Band2_3MHz_64QAM_15_0_Main_LowCH18615-1851.5

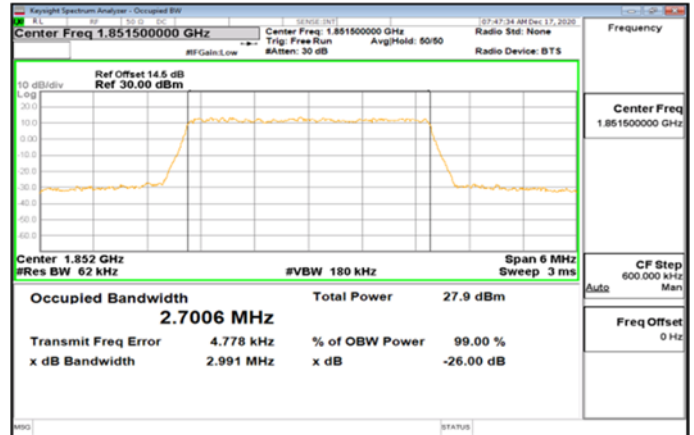

Band2_3MHz_16QAM_15_0_Main_MidCH18900-1880

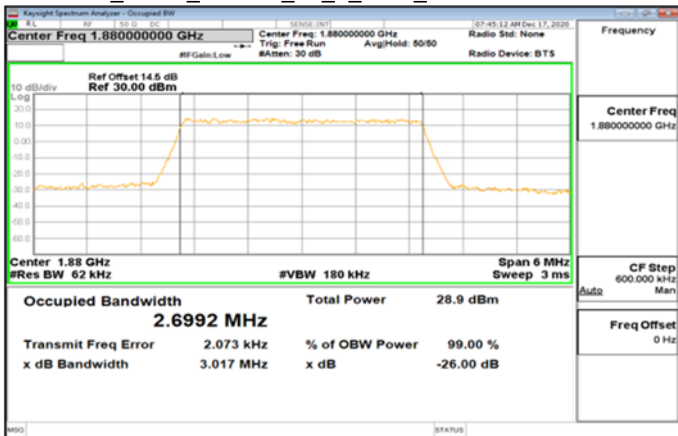

Band2_3MHz_64QAM_15_0_Main_MidCH18900-1880

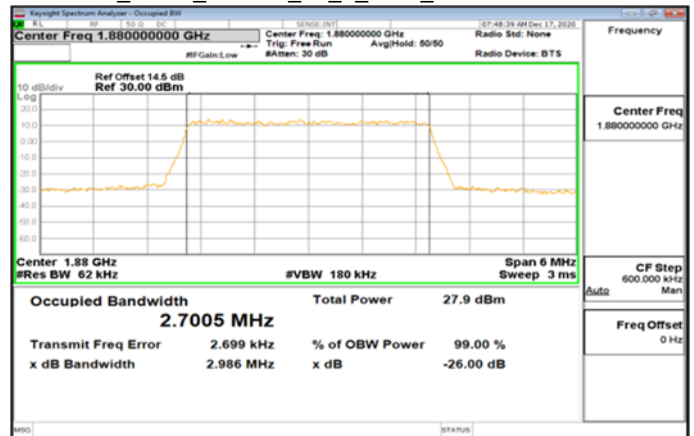

Band2_3MHz_16QAM_15_0_Main_HighCH19185-1908.5

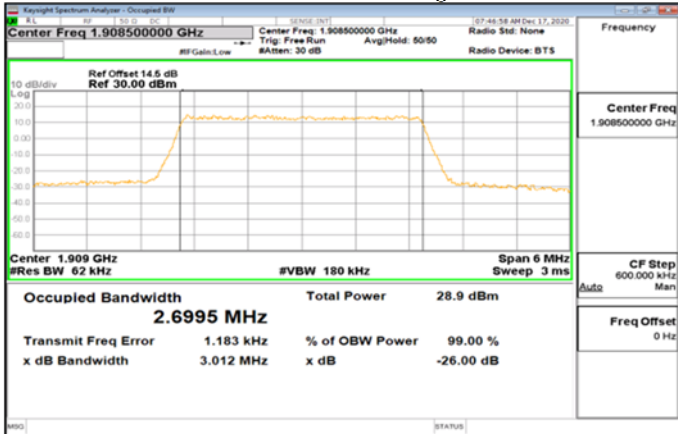

Band2_3MHz_64QAM_15_0_Main_HighCH19185-1908.5

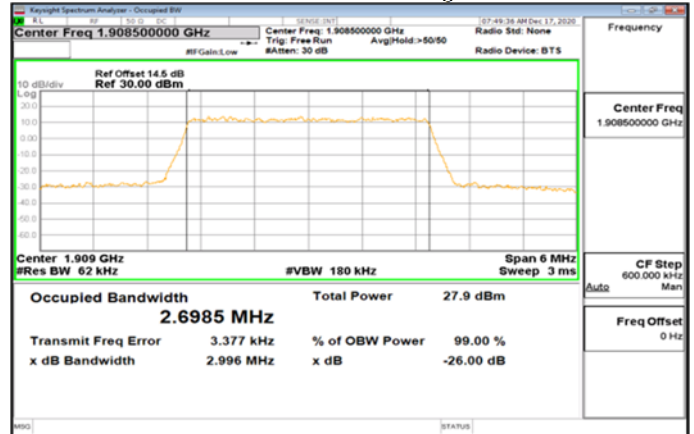

Unless otherwise stated the results shown in this test report refer only to the sample(s) tested and such sample(s) are retained for 90 days only.

除非另有說明，此報告結果僅對測試之樣品負責，同時此樣品僅保留90天。本報告未經本公司書面許可，不可部份複製。

This document is issued by the Company subject to its General Conditions of Service printed overleaf, available on request or accessible at <http://www.sgs.com.tw/Terms-and-Conditions> and for electronic format documents, subject to Terms and Conditions for Electronic Documents at <http://www.sgs.com.tw/Terms-and-Conditions>. Attention is drawn to the limitation of liability, indemnification and jurisdiction issues defined therein. Any holder of this document is advised that information contained herein reflects the Company's findings at the time of its intervention only and within the limits of Client's instructions, if any. The Company's sole responsibility is to its Client and this document does not exonerate parties to a transaction from exercising all their rights and obligations under the transaction documents. This document cannot be reproduced except in full, without prior written approval of the Company. Any unauthorized alteration, forgery or falsification of the content or appearance of this document is unlawful and offenders may be prosecuted to the fullest extent of the law.

Band2_5MHz_QPSK_25_0_Main_LowCH18625-1852.5

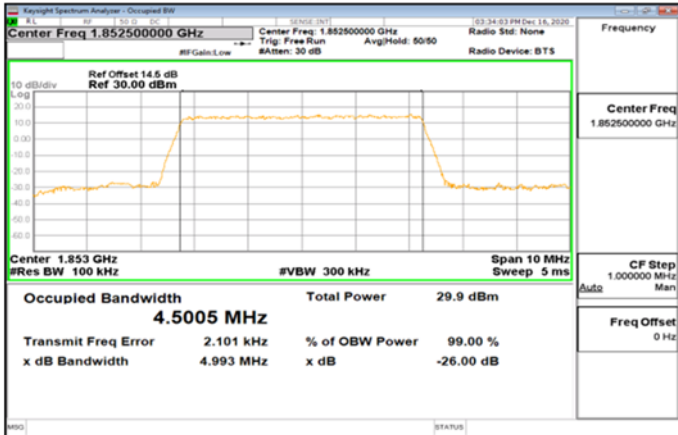

Band2_5MHz_16QAM_25_0_Main_LowCH18625-1852.5

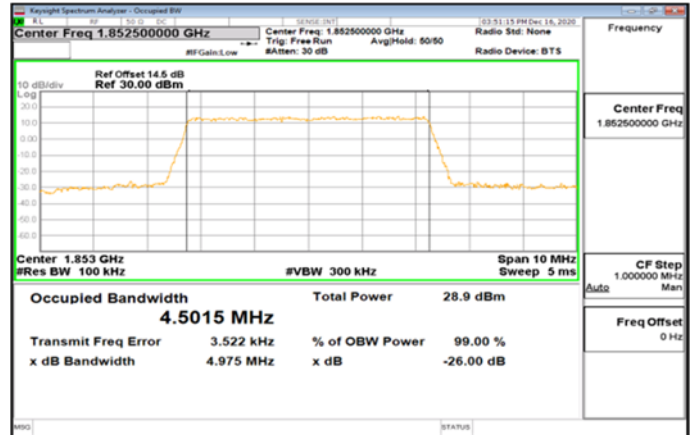

Band2_5MHz_QPSK_25_0_Main_MidCH18900-1880

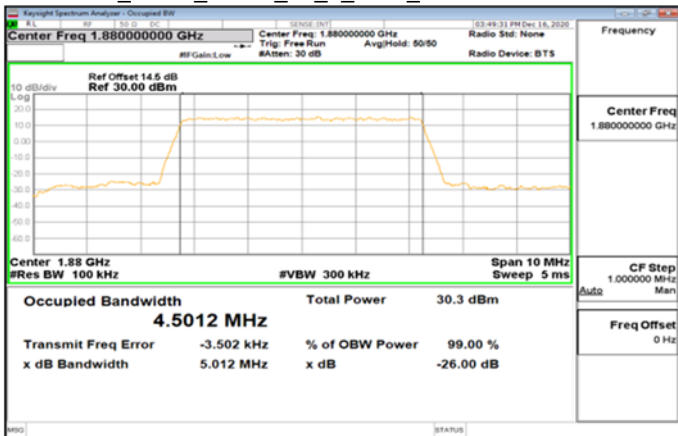

Band2_5MHz_16QAM_25_0_Main_MidCH18900-1880

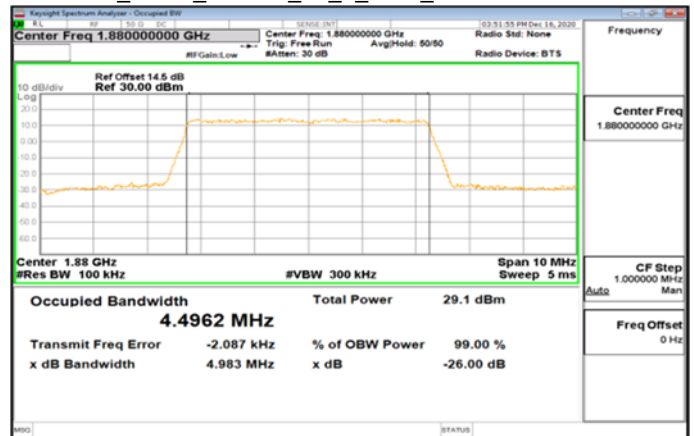

Band2_5MHz_QPSK_25_0_Main_HighCH19175-1907.5

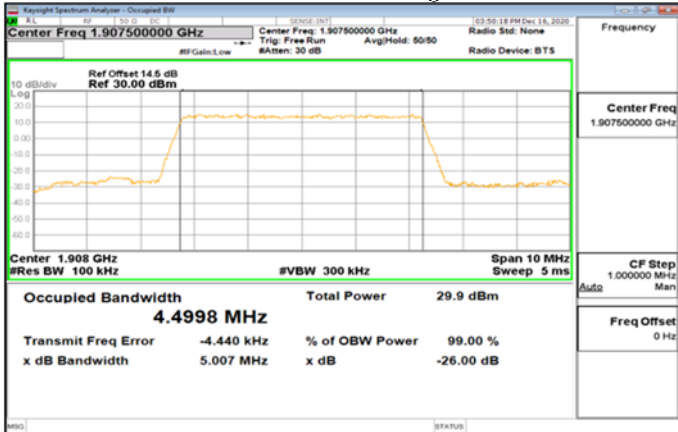

Band2_5MHz_16QAM_25_0_Main_HighCH19175-1907.5

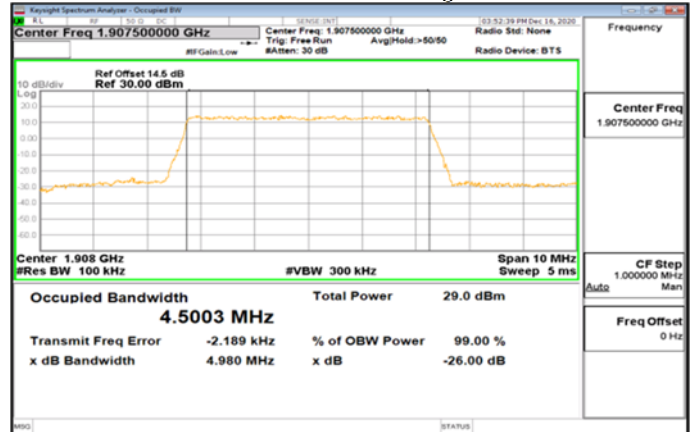

Unless otherwise stated the results shown in this test report refer only to the sample(s) tested and such sample(s) are retained for 90 days only.

除非另有說明，此報告結果僅對測試之樣品負責，同時此樣品僅保留90天。本報告未經本公司書面許可，不可部份複製。

This document is issued by the Company subject to its General Conditions of Service printed overleaf, available on request or accessible at <http://www.sgs.com.tw/Terms-and-Conditions> and for electronic format documents, subject to Terms and Conditions for Electronic Documents at <http://www.sgs.com.tw/Terms-and-Conditions>. Attention is drawn to the limitation of liability, indemnification and jurisdiction issues defined therein. Any holder of this document is advised that information contained herein reflects the Company's findings at the time of its intervention only and within the limits of Client's instructions, if any. The Company's sole responsibility is to its Client and this document does not exonerate parties to a transaction from exercising all their rights and obligations under the transaction documents. This document cannot be reproduced except in full, without prior written approval of the Company. Any unauthorized alteration, forgery or falsification of the content or appearance of this document is unlawful and offenders may be prosecuted to the fullest extent of the law.

Band2_5MHz_64QAM_25_0_Main_LowCH18625-1852.5

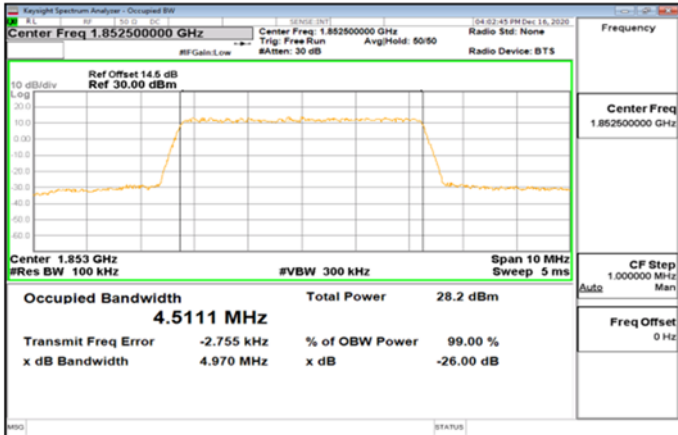

Band2_10MHz_QPSK_50_0_Main_LowCH18650-1855

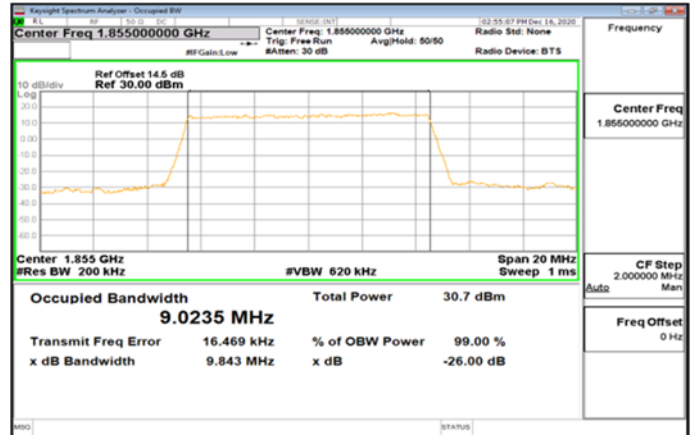

Band2_5MHz_64QAM_25_0_Main_MidCH18900-1880

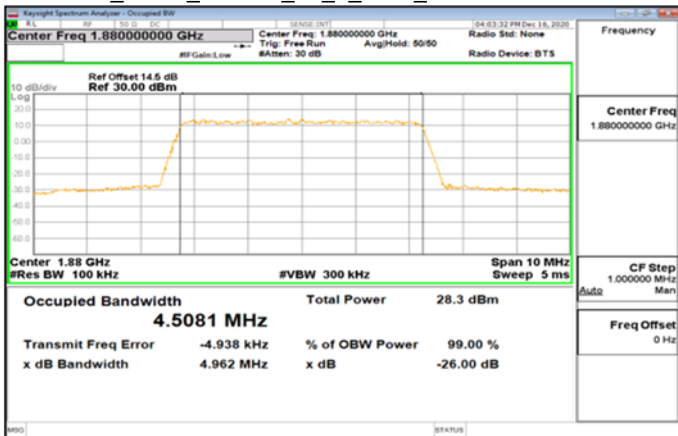

Band2_10MHz_QPSK_50_0_Main_MidCH18900-1880

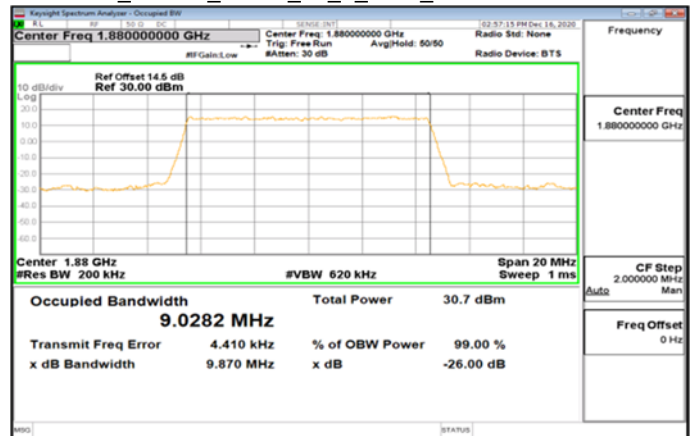

Band2_5MHz_64QAM_25_0_Main_HighCH19175-1907.5

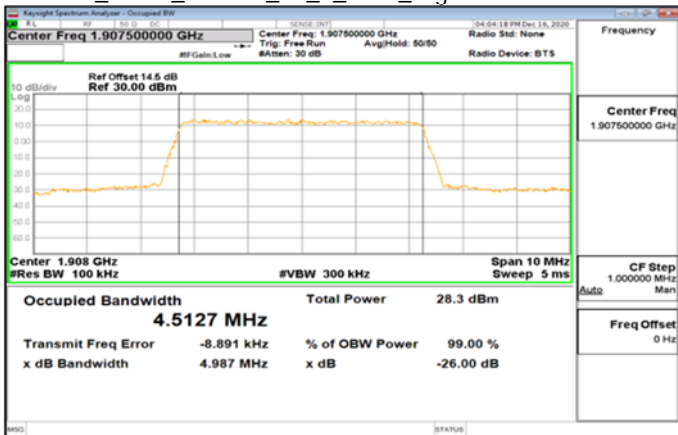

Band2_10MHz_QPSK_50_0_Main_HighCH19150-1905

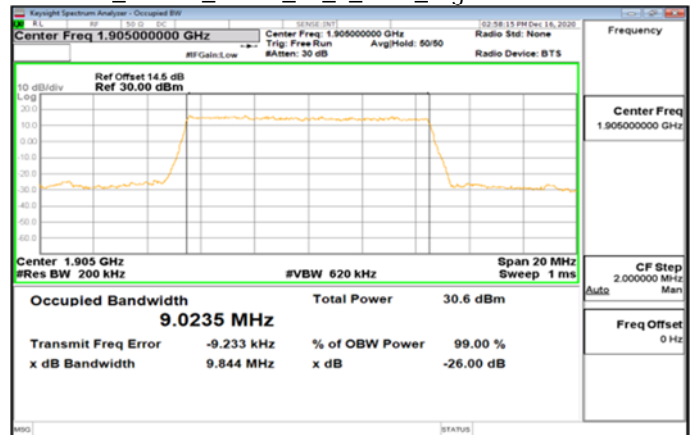

Unless otherwise stated the results shown in this test report refer only to the sample(s) tested and such sample(s) are retained for 90 days only.

除非另有說明，此報告結果僅對測試之樣品負責，同時此樣品僅保留90天。本報告未經本公司書面許可，不可部份複製。

This document is issued by the Company subject to its General Conditions of Service printed overleaf, available on request or accessible at <http://www.sgs.com.tw/Terms-and-Conditions> and for electronic format documents, subject to Terms and Conditions for Electronic Documents at <http://www.sgs.com.tw/Terms-and-Conditions>. Attention is drawn to the limitation of liability, indemnification and jurisdiction issues defined therein. Any holder of this document is advised that information contained herein reflects the Company's findings at the time of its intervention only and within the limits of Client's instructions, if any. The Company's sole responsibility is to its Client and this document does not exonerate parties to a transaction from exercising all their rights and obligations under the transaction documents. This document cannot be reproduced except in full, without prior written approval of the Company. Any unauthorized alteration, forgery or falsification of the content or appearance of this document is unlawful and offenders may be prosecuted to the fullest extent of the law.

