

ELECTROMAGNETIC EMISSIONS COMPLIANCE REPORT

OF

FCC Applicant: Sharp Corporation, Mobile Communication B.U.
2-13-1, Hachihonmatsu-lida, Higashi-hiroshima-shi, Hiroshima,
739-0192, Japan

FCC Manufacturer: Sharp Corporation
1 Takumi-cho, Sakai-ku, Sakai City, Osaka 590-8522, Japan

Product Name: Smart phone

Report Number: ER/2020/B0118

FCC ID APYHRO00292

FCC Rule Part: 2 , 22H & 24E & 27 C

Issue Date: January 27, 2021

Date of Test: November 24, 2020 - December 18, 2020

Date of EUT Received: November 24, 2020

We hereby certify that:

The above equipment was tested by SGS Taiwan Ltd. Central RF Lab The test data, data evaluation, test procedures, and equipment configurations shown in this report were made in accordance with the procedures given in ANSI C63.26-2015 and the energy emitted by the sample EUT tested as described in this report is in compliance with conducted and radiated emission limits.

The test results of this report relate only to the tested sample identified in this report.

Approved By: _____



Blue Yang / Asst. Manager



Unless otherwise stated the results shown in this test report refer only to the sample(s) tested and such sample(s) are retained for 90 days only.

除非另有說明，此報告結果僅對測試之樣品負責，同時此樣品僅保留90天。本報告未經本公司書面許可，不可部份複製。

This document is issued by the Company subject to its General Conditions of Service printed overleaf, available on request or accessible at <http://www.sgs.com.tw/Terms-and-Conditions> and for electronic format documents, subject to Terms and Conditions for Electronic Documents at <http://www.sgs.com.tw/Terms-and-Conditions>. Attention is drawn to the limitation of liability, indemnification and jurisdiction issues defined therein. Any holder of this document is advised that information contained hereon reflects the Company's findings at the time of its intervention only and within the limits of Client's instructions, if any. The Company's sole responsibility is to its Client and this document does not exonerate parties to a transaction from exercising all their rights and obligations under the transaction documents. This document cannot be reproduced except in full, without prior written approval of the Company. Any unauthorized alteration, forgery or falsification of the content or appearance of this document is unlawful and offenders may be prosecuted to the fullest extent of the law.

Revision History

Report Number	Revision	Description	Issue Date	Remark
ER/2020/B0118	Rev.00	Original.	January 27, 2021	Revised By: Violetta Tang

Note:

1、Disclaimer

Antenna information is provided by the applicant, test results of this report are applicable to the sample EUT received.

Unless otherwise stated the results shown in this test report refer only to the sample(s) tested and such sample(s) are retained for 90 days only.

除非另有說明，此報告結果僅對測試之樣品負責，同時此樣品僅保留90天。本報告未經本公司書面許可，不可部份複製。

This document is issued by the Company subject to its General Conditions of Service printed overleaf, available on request or accessible at <http://www.sgs.com.tw/Terms-and-Conditions> and for electronic format documents, subject to Terms and Conditions for Electronic Documents at <http://www.sgs.com.tw/Terms-and-Conditions>. Attention is drawn to the limitation of liability, indemnification and jurisdiction issues defined therein. Any holder of this document is advised that information contained hereon reflects the Company's findings at the time of its intervention only and within the limits of Client's instructions, if any. The Company's sole responsibility is to its Client and this document does not exonerate parties to a transaction from exercising all their rights and obligations under the transaction documents. This document cannot be reproduced except in full, without prior written approval of the Company. Any unauthorized alteration, forgery or falsification of the content or appearance of this document is unlawful and offenders may be prosecuted to the fullest extent of the law.

Contents

1	GENERAL PRODUCT INFORMATION.....	4
2	SYSTEM TEST CONFIGURATION.....	8
3	SUMMARY OF TEST RESULTS.....	11
4	DESCRIPTION OF TEST MODES.....	12
5	MEASUREMENT UNCERTAINTY.....	15
6	MAXMUM OUTPUT POWER.....	16
7	OCCUPIED BANDWIDTH MEASUREMENT.....	40
8	OUT OF BAND EMISSION AT ANTENNA TERMINALS.....	74
9	FIELD STRENGTH OF SPURIOUS RADIATION MEASUREMENT.....	95
10	FREQUENCY STABILITY MEASUREMENT.....	148
11	PEAK TO AVERAGE RATIO.....	154

Unless otherwise stated the results shown in this test report refer only to the sample(s) tested and such sample(s) are retained for 90 days only.

除非另有說明，此報告結果僅對測試之樣品負責，同時此樣品僅保留90天。本報告未經本公司書面許可，不可部份複製。

This document is issued by the Company subject to its General Conditions of Service printed overleaf, available on request or accessible at <http://www.sgs.com.tw/Terms-and-Conditions> and for electronic format documents, subject to Terms and Conditions for Electronic Documents at <http://www.sgs.com.tw/Terms-and-Conditions>. Attention is drawn to the limitation of liability, indemnification and jurisdiction issues defined therein. Any holder of this document is advised that information contained hereon reflects the Company's findings at the time of its intervention only and within the limits of Client's instructions, if any. The Company's sole responsibility is to its Client and this document does not exonerate parties to a transaction from exercising all their rights and obligations under the transaction documents. This document cannot be reproduced except in full, without prior written approval of the Company. Any unauthorized alteration, forgery or falsification of the content or appearance of this document is unlawful and offenders may be prosecuted to the fullest extent of the law.

1 GENERAL PRODUCT INFORMATION

1.1 Product Description

General:

Product Name:	Smart phone
Hardware Version:	DVT
Software Version:	N/A
Power Supply:	3.85 Vdc from Rechargeable Li-polymer Battery
Antenna Designation:	Inverted-F Antenna, Gain: -4.2dBi (GSM/GPRS 800, WCDMA B5, LTE B5) -4.3dBi (GSM/GPRS 1900) -4.8dBi (LTE B12, LTE B17) -3.9dBi (LTE B38, LTE B41)
IMEI:	004401230121341/004401230120731/004401230120921 004401230120475/004401230120574/004401230122307

Unless otherwise stated the results shown in this test report refer only to the sample(s) tested and such sample(s) are retained for 90 days only.

除非另有說明，此報告結果僅對測試之樣品負責，同時此樣品僅保留90天。本報告未經本公司書面許可，不可部份複製。

This document is issued by the Company subject to its General Conditions of Service printed overleaf, available on request or accessible at <http://www.sgs.com.tw/Terms-and-Conditions> and for electronic format documents, subject to Terms and Conditions for Electronic Documents at <http://www.sgs.com.tw/Terms-and-Conditions>. Attention is drawn to the limitation of liability, indemnification and jurisdiction issues defined therein. Any holder of this document is advised that information contained hereon reflects the Company's findings at the time of its intervention only and within the limits of Client's instructions, if any. The Company's sole responsibility is to its Client and this document does not exonerate parties to a transaction from exercising all their rights and obligations under the transaction documents. This document cannot be reproduced except in full, without prior written approval of the Company. Any unauthorized alteration, forgery or falsification of the content or appearance of this document is unlawful and offenders may be prosecuted to the fullest extent of the law.

1.2 Operation Frequency Range

Operating Frequency (MHz)	
GSM/GPRS 850	824.2 - 848.8
GSM/GPRS 1900	1850.2 - 1909.8

Operating Frequency (MHz)	
WCDMA / HSPA+ Band V	826.4 - 846.6

LTE Band 5	
BW (MHz)	Operation Frequency (MHz)
1.4	824.7 - 848.3
3	825.5 - 847.5
5	826.5 - 846.5
10	829.0 - 844.0

LTE Band 38	
BW (MHz)	Operation Frequency (MHz)
5	2572.5 - 2617.5
10	2575.0 - 2615.0
15	2577.5 - 2612.5
20	2580.0 - 2610.0

LTE Band 12	
BW (MHz)	Operation Frequency (MHz)
1.4	699.7 - 715.3
3	700.5 - 714.5
5	701.5 - 713.5
10	704.0 - 711.0

LTE Band 41	
BW (MHz)	Operation Frequency (MHz)
5	2498.5 - 2687.5
10	2501.0 - 2685.0
15	2503.5 - 2682.5
20	2506.0 - 2680.0

LTE Band 17	
BW (MHz)	Operation Frequency (MHz)
5	706.5 - 713.5
10	709.0 - 711.0

Unless otherwise stated the results shown in this test report refer only to the sample(s) tested and such sample(s) are retained for 90 days only.

除非另有說明，此報告結果僅對測試之樣品負責，同時此樣品僅保留90天。本報告未經本公司書面許可，不可部份複製。

This document is issued by the Company subject to its General Conditions of Service printed overleaf, available on request or accessible at <http://www.sgs.com.tw/Terms-and-Conditions> and for electronic format documents, subject to Terms and Conditions for Electronic Documents at <http://www.sgs.com.tw/Terms-and-Conditions>. Attention is drawn to the limitation of liability, indemnification and jurisdiction issues defined therein. Any holder of this document is advised that information contained hereon reflects the Company's findings at the time of its intervention only and within the limits of Client's instructions, if any. The Company's sole responsibility is to its Client and this document does not exonerate parties to a transaction from exercising all their rights and obligations under the transaction documents. This document cannot be reproduced except in full, without prior written approval of the Company. Any unauthorized alteration, forgery or falsification of the content or appearance of this document is unlawful and offenders may be prosecuted to the fullest extent of the law.

1.3 Type of Emission & Max ERP/EIRP Power Measurement Result:

	ERP / EIRP (dBm)		W	99%	Type of Emission
GSM 850	26.56	ERP	0.453	0.2457	246KGXW
GPRS 850	26.54	ERP	0.451	0.2473	247KGXW
GSM 1900	25.65	EIRP	0.367	0.2478	248KGXW
GPRS 1900	25.61	EIRP	0.364	0.2462	246KGXW
	ERP / EIRP (dBm)		W	99%	Type of Emission
WCDMA Band V	18.04	ERP	0.064	4.1454	4M15F9W
HSDPA Band V	17.06	ERP	0.051	4.1400	4M14F9W
HSUPA Band V	17.08	ERP	0.051	4.1445	4M14F9W

LTE Band	BW	Modulation	ERP / EIRP (dBm)		(W)	99%	Type of Emission
5	1.4	QPSK	16.82	ERP	0.048	1.0950	G7D
		16QAM	16.37	ERP	0.043	1.0976	D7W
		64QAM	14.80	ERP	0.030	1.0966	D7W
5	3	QPSK	16.94	ERP	0.049	2.6989	G7D
		16QAM	16.38	ERP	0.043	2.7003	D7W
		64QAM	14.87	ERP	0.031	2.7017	D7W
5	5	QPSK	16.92	ERP	0.049	4.4999	G7D
		16QAM	16.43	ERP	0.044	4.4997	D7W
		64QAM	14.83	ERP	0.030	4.5072	D7W
5	10	QPSK	17.05	ERP	0.051	9.0027	G7D
		16QAM	16.34	ERP	0.043	8.9506	D7W
		64QAM	14.88	ERP	0.031	8.9910	D7W
LTE Band	BW	Modulation	ERP / EIRP (dBm)		(W)	99%	Type of Emission
12	1.4	QPSK	16.33	ERP	0.043	1.0958	G7D
		16QAM	15.82	ERP	0.038	1.0976	D7W
		64QAM	14.37	ERP	0.027	1.0962	D7W
12	3	QPSK	16.43	ERP	0.044	2.7030	G7D
		16QAM	15.80	ERP	0.038	2.7014	D7W
		64QAM	14.38	ERP	0.027	2.7140	D7W
12	5	QPSK	16.41	ERP	0.044	4.5089	G7D
		16QAM	15.76	ERP	0.038	4.5063	D7W
		64QAM	14.36	ERP	0.027	4.5194	D7W
12	10	QPSK	16.94	ERP	0.049	9.0487	G7D
		16QAM	16.05	ERP	0.040	8.9867	D7W
		64QAM	14.44	ERP	0.028	9.0174	D7W
LTE Band	BW	Modulation	ERP / EIRP (dBm)		(W)	99%	Type of Emission
17	5	QPSK	16.39	ERP	0.044	4.5066	G7D
		16QAM	16.03	ERP	0.040	4.4974	D7W
		64QAM	14.33	ERP	0.027	4.5172	D7W
17	10	QPSK	16.54	ERP	0.045	8.9698	G7D
		16QAM	15.57	ERP	0.036	8.9167	D7W
		64QAM	14.41	ERP	0.028	8.9433	D7W

LTE Band	BW	Modulation	ERP / EIRP (dBm)		(W)	99%	Type of Emission
38	5	QPSK	18.79	EIRP	0.076	4.5110	G7D
		16QAM	17.96	EIRP	0.063	4.5027	D7W
		64QAM	17.19	EIRP	0.052	4.5085	D7W
38	10	QPSK	19.07	EIRP	0.081	8.9990	G7D
		16QAM	18.19	EIRP	0.066	8.9826	D7W
		64QAM	17.21	EIRP	0.053	9.0015	D7W
38	15	QPSK	19.25	EIRP	0.084	13.517	G7D
		16QAM	18.40	EIRP	0.069	13.516	D7W
		64QAM	17.26	EIRP	0.053	13.479	D7W
38	20	QPSK	19.44	EIRP	0.088	17.959	G7D
		16QAM	18.73	EIRP	0.075	17.972	D7W
		64QAM	17.26	EIRP	0.053	17.993	D7W
LTE Band	BW	Modulation	ERP / EIRP (dBm)		(W)	99%	Type of Emission
41	5	QPSK	19.71	EIRP	0.094	4.5102	G7D
		16QAM	19.20	EIRP	0.083	4.5078	D7W
		64QAM	18.11	EIRP	0.065	4.5137	D7W
41	10	QPSK	19.65	EIRP	0.092	9.0047	G7D
		16QAM	18.83	EIRP	0.076	8.9811	D7W
		64QAM	18.02	EIRP	0.063	8.9912	D7W
41	15	QPSK	19.77	EIRP	0.095	13.510	G7D
		16QAM	18.82	EIRP	0.076	13.505	D7W
		64QAM	18.13	EIRP	0.065	13.475	D7W
41	20	QPSK	19.89	EIRP	0.097	17.970	G7D
		16QAM	19.15	EIRP	0.082	17.955	D7W
		64QAM	18.06	EIRP	0.064	17.965	D7W

Unless otherwise stated the results shown in this test report refer only to the sample(s) tested and such sample(s) are retained for 90 days only.

除非另有說明，此報告結果僅對測試之樣品負責，同時此樣品僅保留90天。本報告未經本公司書面許可，不可部份複製。

This document is issued by the Company subject to its General Conditions of Service printed overleaf, available on request or accessible at <http://www.sgs.com.tw/Terms-and-Conditions> and for electronic format documents, subject to Terms and Conditions for Electronic Documents at <http://www.sgs.com.tw/Terms-and-Conditions>. Attention is drawn to the limitation of liability, indemnification and jurisdiction issues defined therein. Any holder of this document is advised that information contained hereon reflects the Company's findings at the time of its intervention only and within the limits of Client's instructions, if any. The Company's sole responsibility is to its Client and this document does not exonerate parties to a transaction from exercising all their rights and obligations under the transaction documents. This document cannot be reproduced except in full, without prior written approval of the Company. Any unauthorized alteration, forgery or falsification of the content or appearance of this document is unlawful and offenders may be prosecuted to the fullest extent of the law.

1.4 Test Methodology of Applied Standards

FCC 47 CFR Part 2, 22H, 24E, 27C

ANSI C63.26-2015

KDB971168 D01 Power Meas license Digital System v03r01

KDB941225 D01 SAR test for 3G devices v03r01 (SAR Measurement Procedures for 3G Devices, WCDMA / HSPA) was used for EUT and Base station setting.

KDB412172 D01 Determining ERP and EIRP v01r01

TS 151 010-1 is used to set, and measure the output power.

1.5 Test Facility

SGS Taiwan Ltd. Central RF Lab (TAF code 3702)

No.134, Wu Kung Road, New Taipei Industrial Park, Wuku District, New Taipei City, Taiwan 24803

FCC Designation number: TW0027

1.6 Special Accessories

No special accessories were used during testing.

1.7 Equipment Modifications

There was no modifications incorporated into the EUT.

1.8 Radiated Emission Test Sites For Measurements From 9 kHz To 30 MHz

Radiated emission below 30MHz is measured in a 9m*9m*6m semi-anechoic chamber, the measurements correspond to those obtained at an open-field test site.

There is a comparison data of both open-field test site and semi-Anechoic chamber, and the result came out very similar.

Unless otherwise stated the results shown in this test report refer only to the sample(s) tested and such sample(s) are retained for 90 days only.

除非另有說明，此報告結果僅對測試之樣品負責，同時此樣品僅保留90天。本報告未經本公司書面許可，不可部份複製。

This document is issued by the Company subject to its General Conditions of Service printed overleaf, available on request or accessible at <http://www.sgs.com.tw/Terms-and-Conditions> and for electronic format documents, subject to Terms and Conditions for Electronic Documents at <http://www.sgs.com.tw/Terms-and-Conditions>. Attention is drawn to the limitation of liability, indemnification and jurisdiction issues defined therein. Any holder of this document is advised that information contained hereon reflects the Company's findings at the time of its intervention only and within the limits of Client's instructions, if any. The Company's sole responsibility is to its Client and this document does not exonerate parties to a transaction from exercising all their rights and obligations under the transaction documents. This document cannot be reproduced except in full, without prior written approval of the Company. Any unauthorized alteration, forgery or falsification of the content or appearance of this document is unlawful and offenders may be prosecuted to the fullest extent of the law.

2 SYSTEM TEST CONFIGURATION

2.1 EUT Configuration

The EUT configuration for testing is installed on RF field strength measurement to meet the Commissions requirement and operating in a manner which intends to maximize its emission characteristics in a continuous normal application.

2.2 EUT Exercise

The EUT (Transmitter) was operated in the continuous transmission mode employed with the simulator of the Base Station that fixates at test default channels to fix the Tx frequency which was for the purpose of the measurements.

2.3 Test Procedure

2.3.1 Conducted Measurement at Antenna Port

The EUT is placed on a table which is 0.8 m above ground plane. A low loss of RF cable was used to connect the antenna port of EUT to measurement equipment.

2.3.2 Radiated Emissions (ERP/EIRP)

The EUT is placed on a turn table, for emission measurements below 1 GHz is 0.8 m above ground plane, for emission measurements above 1 GHz, the table height shall be 1.5 m. The turn table shall rotate 360 degrees to determine the position of maximum emission level. EUT is set 3m away from the receiving antenna which varied from 1m to 4m to find out the highest emission. And also, each emission was to be maximized by changing the polarization of receiving antenna both Horizontal and Vertical. In order to find out the max. emission, the relative positions of this hand-held transmitter (EUT) was rotated through three orthogonal axes and measurement procedures for electric field radiated emissions above 1 GHz the EUT measurement is to be made “while keeping the antenna in the ‘cone of radiation’ from that area and pointed at the area both in azimuth and elevation, with polarization oriented for maximum response.” is still within the 3dB illumination BW of the measurement antenna.

Unless otherwise stated the results shown in this test report refer only to the sample(s) tested and such sample(s) are retained for 90 days only.

除非另有說明，此報告結果僅對測試之樣品負責，同時此樣品僅保留90天。本報告未經本公司書面許可，不可部份複製。

This document is issued by the Company subject to its General Conditions of Service printed overleaf, available on request or accessible at <http://www.sgs.com.tw/Terms-and-Conditions> and for electronic format documents, subject to Terms and Conditions for Electronic Documents at <http://www.sgs.com.tw/Terms-and-Conditions>. Attention is drawn to the limitation of liability, indemnification and jurisdiction issues defined therein. Any holder of this document is advised that information contained hereon reflects the Company's findings at the time of its intervention only and within the limits of Client's instructions, if any. The Company's sole responsibility is to its Client and this document does not exonerate parties to a transaction from exercising all their rights and obligations under the transaction documents. This document cannot be reproduced except in full, without prior written approval of the Company. Any unauthorized alteration, forgery or falsification of the content or appearance of this document is unlawful and offenders may be prosecuted to the fullest extent of the law.

2.4 Measurement Results Explanation Example

For all conducted test items:

The offset level is set in the spectrum analyzer to compensate the RF cable loss and attenuation factor between EUT conducted port and spectrum analyzer. With the offset compensation, the spectrum analyzer reading level is exactly EUT RF output level.

Note:

The spectrum analyzer offset is derived from RF cable loss and attenuator factor.

Following shows an offset computation in physical test.

2G/3G:

	RF cable loss (dB)	Attenuation factor(dB)	offset(dB)
Low Band (Below 1GHz)	4.03	10	14.03
High Band (Above 1 GHz)	4.54	10	14.54

LTE:

	RF cable loss (dB)	Attenuation factor(dB)	offset(dB)
Low Band (Below 1GHz)	4.03	10	14.03
Middle Band (1 GHz - 2 GHz)	4.54	10	14.54
Middle Band (2 GHz - 3 GHz)	4.87	10	14.87

2.5 Final Amplifier Voltage and Current Information:

Test Mode	DC voltage (V)	DC current (mA)
GSM 850	3.85	944
GSM 1900		888
HSUPA B5		930
LTE Band 5		1268
LTE Band 12		1267
LTE Band 17		1269
LTE Band 38		1257
LTE Band 41		1254

Unless otherwise stated the results shown in this test report refer only to the sample(s) tested and such sample(s) are retained for 90 days only.

除非另有說明，此報告結果僅對測試之樣品負責，同時此樣品僅保留90天。本報告未經本公司書面許可，不可部份複製。

This document is issued by the Company subject to its General Conditions of Service printed overleaf, available on request or accessible at <http://www.sgs.com.tw/Terms-and-Conditions> and for electronic format documents, subject to Terms and Conditions for Electronic Documents at <http://www.sgs.com.tw/Terms-and-Conditions>. Attention is drawn to the limitation of liability, indemnification and jurisdiction issues defined therein. Any holder of this document is advised that information contained hereon reflects the Company's findings at the time of its intervention only and within the limits of Client's instructions, if any. The Company's sole responsibility is to its Client and this document does not exonerate parties to a transaction from exercising all their rights and obligations under the transaction documents. This document cannot be reproduced except in full, without prior written approval of the Company. Any unauthorized alteration, forgery or falsification of the content or appearance of this document is unlawful and offenders may be prosecuted to the fullest extent of the law.

2.6 Configuration of Tested System

Fig. 2-1 Configuration of Tested System (Fixed Channel-Conducted)

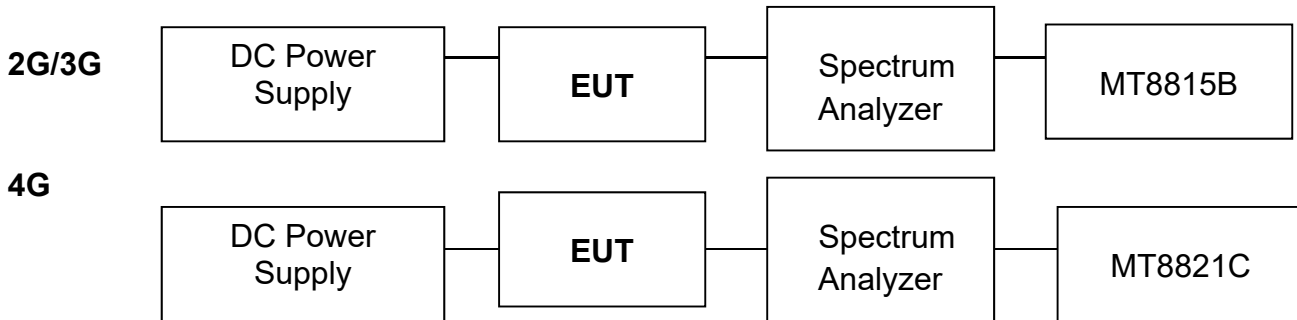

Fig. 2-2 Configuration of Tested System (Fixed Channel-Radiated)

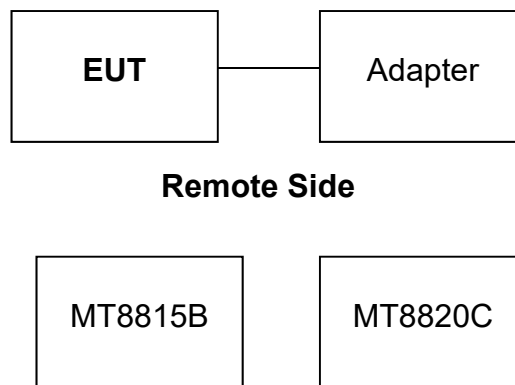

Table 2-1 Equipment Used in

Item	Equipment	Mfr/Brand	Model/ Type No.	Series No.	Data Cable	Power Cord
1.	Radio Communication Analyzer	Anritsu	MT8815B	6200711454	shielded	Un-shielded
2.	Radio Communication Analyzer	Anritsu	MT8821C	6261786084	shielded	Un-shielded
3.	Radio Communication Analyzer	Anritsu	MT8820C	6200711454	shielded	Un-shielded

Unless otherwise stated the results shown in this test report refer only to the sample(s) tested and such sample(s) are retained for 90 days only.

除非另有說明，此報告結果僅對測試之樣品負責，同時此樣品僅保留90天。本報告未經本公司書面許可，不可部份複製。

This document is issued by the Company subject to its General Conditions of Service printed overleaf, available on request or accessible at <http://www.sgs.com.tw/Terms-and-Conditions> and for electronic format documents, subject to Terms and Conditions for Electronic Documents at <http://www.sgs.com.tw/Terms-and-Conditions>. Attention is drawn to the limitation of liability, indemnification and jurisdiction issues defined therein. Any holder of this document is advised that information contained hereon reflects the Company's findings at the time of its intervention only and within the limits of Client's instructions, if any. The Company's sole responsibility is to its Client and this document does not exonerate parties to a transaction from exercising all their rights and obligations under the transaction documents. This document cannot be reproduced except in full, without prior written approval of the Company. Any unauthorized alteration, forgery or falsification of the content or appearance of this document is unlawful and offenders may be prosecuted to the fullest extent of the law.

3 SUMMARY OF TEST RESULTS

FCC Rules	Description Of Test	Result
§2.1046(a)	RF Power Output	Compliant
§22.913(a)(5) §24.232(c) §27.50(c)(9) §27.50(h)(2)	ERP/ EIRP measurement	Compliant
§2.1049(h)	99% & 26dB Occupied Bandwidth	Compliant
§2.1051 §22.917(a) §24.238(a) §27.53(g) §27.53(m)(4)(6)	Out of Band Emissions at Antenna Terminals and Band Edge / Emission mask requirements	Compliant
§2.1053 §22.917(a) §24.238(a) §27.53(g) §27.53(m)(2)	Field Strength of Spurious Radiation	Compliant
§27.50(a)(1)(B)	Peak to Average Ratio	Compliant
§2.1055(a)(1) §22.355 §24.235 §27.54	Frequency Stability	Compliant

Unless otherwise stated the results shown in this test report refer only to the sample(s) tested and such sample(s) are retained for 90 days only.

除非另有說明，此報告結果僅對測試之樣品負責，同時此樣品僅保留90天。本報告未經本公司書面許可，不可部份複製。

This document is issued by the Company subject to its General Conditions of Service printed overleaf, available on request or accessible at <http://www.sgs.com.tw/Terms-and-Conditions> and for electronic format documents, subject to Terms and Conditions for Electronic Documents at <http://www.sgs.com.tw/Terms-and-Conditions>. Attention is drawn to the limitation of liability, indemnification and jurisdiction issues defined therein. Any holder of this document is advised that information contained hereon reflects the Company's findings at the time of its intervention only and within the limits of Client's instructions, if any. The Company's sole responsibility is to its Client and this document does not exonerate parties to a transaction from exercising all their rights and obligations under the transaction documents. This document cannot be reproduced except in full, without prior written approval of the Company. Any unauthorized alteration, forgery or falsification of the content or appearance of this document is unlawful and offenders may be prosecuted to the fullest extent of the law.

4 DESCRIPTION OF TEST MODES

4.1 The Worst Test Modes and Channel Details

1. The EUT has been tested under operating condition.
2. Pre-Scan has been conducted to determine the worst-case mode from all possible combinations between available modulations, data rates, X(E1)Y(E2)Z(H) axis and antenna ports. The worst case was found as listed below. Following channel(s) was (were) selected for the final test as listed below:

BAND	H PLAN	E1 PLAN	E2 PLAN
GSM/GPRS 850	V		
GSM/GPRS 1900	V		
WCDMA/HSPA Band V	V		
LTE Band 5	V		
LTE Band 12	V		
LTE Band 17	V		
LTE Band 38	V		
LTE Band 41	V		

Unless otherwise stated the results shown in this test report refer only to the sample(s) tested and such sample(s) are retained for 90 days only.

除非另有說明，此報告結果僅對測試之樣品負責，同時此樣品僅保留90天。本報告未經本公司書面許可，不可部份複製。

This document is issued by the Company subject to its General Conditions of Service printed overleaf, available on request or accessible at <http://www.sgs.com.tw/Terms-and-Conditions> and for electronic format documents, subject to Terms and Conditions for Electronic Documents at <http://www.sgs.com.tw/Terms-and-Conditions>. Attention is drawn to the limitation of liability, indemnification and jurisdiction issues defined therein. Any holder of this document is advised that information contained hereon reflects the Company's findings at the time of its intervention only and within the limits of Client's instructions, if any. The Company's sole responsibility is to its Client and this document does not exonerate parties to a transaction from exercising all their rights and obligations under the transaction documents. This document cannot be reproduced except in full, without prior written approval of the Company. Any unauthorized alteration, forgery or falsification of the content or appearance of this document is unlawful and offenders may be prosecuted to the fullest extent of the law.

4.2 Measurement Configuration

Test Items	GSM Bands	Test Channel		
		L	M	H
ERP	850	v	v	v
EIRP	1900	v	v	v
FREQUENCY STABILITY	850	-	v	-
	1900	-	v	-
OCCUPIED BANDWIDTH	850	v	v	v
	1900	v	v	v
PEAK TO AVERAGE RATIO	850	v	v	v
	1900	v	v	v
BAND EDGE	850	v	-	v
	1900	v	-	v
CONDCUDED EMISSION	850	v	v	v
	1900	v	v	v
RADIATED EMISSION	850	v	v	v
	1900	v	v	v

Test Items	WCDMA / HSPA Bands	Test Channel		
		L	M	H
ERP	Band V	v	v	v
FREQUENCY STABILITY	Band V	-	v	-
OCCUPIED BANDWIDTH	Band V	v	v	v
PEAK TO AVERAGE	Band V	v	v	v
BAND EDGE	Band V	v	-	v
CONDCUDED EMISSION	Band V	v	v	v
RADIATED EMISSION	Band V	v	v	v

Test Items	Band	Test Channel			Bandwidth (MHz)						Modulation			RB #		
		L	M	H	1.4	3	5	10	15	20	QPSK	16QAM	64QAM	1	Half	Full
Max. Output Power	5	v	v	v	v	v	v	v	-	-	v	v	v	v	v	v
	12	v	v	v	v	v	v	v	-	-	v	v	v	v	v	v
	17	v	v	v	-	-	v	v	-	-	v	v	v	v	v	v
	38	v	v	v	-	-	v	v	v	v	v	v	v	v	v	v
	41	v	v	v	-	-	v	v	v	v	v	v	v	v	v	v
Frequency Stability	5	-	v	-				v	-	-	v	-	-	-	-	v
	12	-	v	-				v	-	-	v	-	-	-	-	v
	17	-	v	-	-	-		v	-	-	v	-	-	-	-	v
	38	-	v	-	-	-		v			v	-	-	-	-	v
	41	-	v	-	-	-		v			v	-	-	-	-	v
Test Items	Band	Test Channel			Bandwidth (MHz)						Modulation			RB #		
		L	M	H	1.4	3	5	10	15	20	QPSK	16QAM	64QAM	1	Half	Full
26dB and 99% Bandwidth	5	v	v	v	v	v	v	v	-	-	v	v	v	-	-	v
	12	v	v	v	v	v	v	v	-	-	v	v	v	-	-	v
	17	v	v	v	-	-	v	v	-	-	v	v	v	-	-	v
	38	v	v	v	-	-	v	v	v	v	v	v	v	-	-	v
	41	v	v	v	-	-	v	v	v	v	v	v	v	-	-	v
Peak-to-Average Ratio	5	v	v	v	v	v	v	v	-	-			v	-	-	v
	12	v	v	v	v	v	v	v	-	-			v	-	-	v
	17	v	v	v	-	-	v	v	-	-			v	-	-	v
	38	v	v	v	-	-	v	v	v	v			v	-	-	v
	41	v	v	v	-	-	v	v	v	v			v	-	-	v

Unless otherwise stated the results shown in this test report refer only to the sample(s) tested and such sample(s) are retained for 90 days only.

除非另有說明，此報告結果僅對測試之樣品負責，同時此樣品僅保留90天。本報告未經本公司書面許可，不可部份複製。

This document is issued by the Company subject to its General Conditions of Service printed overleaf, available on request or accessible at <http://www.sgs.com.tw/Terms-and-Conditions> and for electronic format documents, subject to Terms and Conditions for Electronic Documents at <http://www.sgs.com.tw/Terms-and-Conditions>. Attention is drawn to the limitation of liability, indemnification and jurisdiction issues defined therein. Any holder of this document is advised that information contained hereon reflects the Company's findings at the time of its intervention only and within the limits of Client's instructions, if any. The Company's sole responsibility is to its Client and this document does not exonerate parties to a transaction from exercising all their rights and obligations under the transaction documents. This document cannot be reproduced except in full, without prior written approval of the Company. Any unauthorized alteration, forgery or falsification of the content or appearance of this document is unlawful and offenders may be prosecuted to the fullest extent of the law.

Test Items	Band	Test Channel			Bandwidth (MHz)						Modulation			RB #		
		L	M	H	1.4	3	5	10	15	20	QPSK	16QAM	64QAM	1	Half	Full
Band Edge	5	v	-	v	-	-	-	v	-	-	v	-	-	v	v	v
	12	v	-	v	-	-	-	v	-	-	v	-	-	v	v	v
	17	v	-	v	-	-	-	v	-	-	v	-	-	v	v	v
	38	v	-	v	-	-	-	-	-	v	v	-	-	v	v	v
	41	v	-	v	-	-	-	-	-	v	v	-	-	v	v	v
Conducted Emission	5	v	v	v	-	-	-	v	-	-	v	-	-	v	-	-
	12	v	v	v	-	-	-	v	-	-	v	-	-	v	-	-
	17	v	v	v	-	-	-	v	-	-	v	-	-	v	-	-
	38	v	v	v	-	-	-	-	-	v	v	-	-	v	-	-
	41	v	v	v	-	-	-	-	-	v	v	-	-	v	-	-
Test Items	Band	Test Channel			Bandwidth (MHz)						Modulation			RB #		
		L	M	H	1.4	3	5	10	15	20	QPSK	16QAM	64QAM	1	Half	Full
Radiated Emission	5	v	v	v				v	-	-	v			v		
	12	v	v	v				v	-	-	v			v		
	17	v	v	v	-	-		v	-	-	v			v		
	38	v	v	v	-	-				v	v			v		
	41	v	v	v	-	-				v	v			v		

Unless otherwise stated the results shown in this test report refer only to the sample(s) tested and such sample(s) are retained for 90 days only.

除非另有說明，此報告結果僅對測試之樣品負責，同時此樣品僅保留90天。本報告未經本公司書面許可，不可部份複製。

This document is issued by the Company subject to its General Conditions of Service printed overleaf, available on request or accessible at <http://www.sgs.com.tw/Terms-and-Conditions> and for electronic format documents, subject to Terms and Conditions for Electronic Documents at <http://www.sgs.com.tw/Terms-and-Conditions>. Attention is drawn to the limitation of liability, indemnification and jurisdiction issues defined therein. Any holder of this document is advised that information contained hereon reflects the Company's findings at the time of its intervention only and within the limits of Client's instructions, if any. The Company's sole responsibility is to its Client and this document does not exonerate parties to a transaction from exercising all their rights and obligations under the transaction documents. This document cannot be reproduced except in full, without prior written approval of the Company. Any unauthorized alteration, forgery or falsification of the content or appearance of this document is unlawful and offenders may be prosecuted to the fullest extent of the law.

5 MEASUREMENT UNCERTAINTY

Test Items	Uncertainty
RF Power Output	+/- 1.10 dB
ERP/ EIRP measurement	Vertical Polarization = +/- 4.74dB Horizontal Polarization = +/- 4.62dB
99% Occupied Bandwidth	+/- 5.19 Hz
Out of Band Emissions at Antenna Terminals and Band Edge	+/- 0.70 dB
Peak to Average Ratio	+/- 0.70 dB
Frequency Stability vs. Temperature	+/- 5.19 Hz
Frequency Stability vs. Voltage	+/- 5.19 Hz
Temperature	+/- 0.65 °C
Humidity	+/- 4.6 %
DC / AC Power Source	DC= +/- 0.13%, AC= +/- 0.2%

Radiated Spurious Emission:

Measurement uncertainty (Polarization : Vertical)	9kHz – 30MHz: +/- 2.87 dB
	30MHz - 180MHz: +/- 3.37dB
	180MHz -417MHz: +/- 3.19dB
	0.417GHz-1GHz: +/- 3.19dB
	1GHz - 18GHz: +/- 4.04dB
	18GHz - 40GHz: +/- 4.04dB

Measurement uncertainty (Polarization : Horizontal)	9kHz – 30MHz: +/- 2.87 dB
	30MHz - 167MHz: +/- 4.22dB
	167MHz -500MHz: +/- 3.44dB
	0.5GHz-1GHz: +/- 3.39dB
	1GHz - 18GHz: +/- 4.08dB
	18GHz - 40GHz: +/- 4.08dB

This uncertainty represents an expanded uncertainty expressed at approximately the 95% confidence level using a coverage factor of k=2.

Unless otherwise stated the results shown in this test report refer only to the sample(s) tested and such sample(s) are retained for 90 days only.

除非另有說明，此報告結果僅對測試之樣品負責，同時此樣品僅保留90天。本報告未經本公司書面許可，不可部份複製。

This document is issued by the Company subject to its General Conditions of Service printed overleaf, available on request or accessible at <http://www.sgs.com.tw/Terms-and-Conditions> and for electronic format documents, subject to Terms and Conditions for Electronic Documents at <http://www.sgs.com.tw/Terms-and-Conditions>. Attention is drawn to the limitation of liability, indemnification and jurisdiction issues defined therein. Any holder of this document is advised that information contained hereon reflects the Company's findings at the time of its intervention only and within the limits of Client's instructions, if any. The Company's sole responsibility is to its Client and this document does not exonerate parties to a transaction from exercising all their rights and obligations under the transaction documents. This document cannot be reproduced except in full, without prior written approval of the Company. Any unauthorized alteration, forgery or falsification of the content or appearance of this document is unlawful and offenders may be prosecuted to the fullest extent of the law.

6 MAXMUM OUTPUT POWER

6.1 Standard Applicable

A base station simulator was used to establish communication with the EUT. Its parameters were set to transmit the maximum power on the EUT. The measured power in the radio frequency on the transmitter output terminals.

6.1.1 ERP/EIRP LIMIT

According to FCC §2.1046

FCC 22.913(a) LTE 5

(5) mobile transmitters and auxiliary test transmitters must not exceed 7 watts.

FCC 27.50(c) LTE 12 / 17

(9) Control and mobile stations in the 698-746 MHz band are limited to 30 watts ERP.

FCC 27, 50(h) LTE 38 / 41

(2) Mobile and other user stations transmitting in the BRS and EBS bands are limited to 2 W EIRP.

6.2 Test Set-up

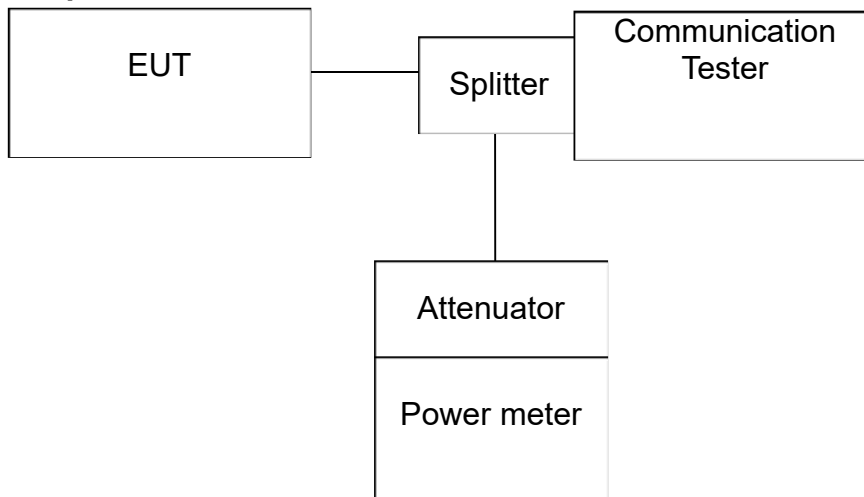

Note: Measurement setup for testing on Antenna connector

6.3 Output Power Measurement Applicable Guidance

The transmitter output was connected to a calibrated attenuator, the other end of which was connected to a power meter. Transmitter output was read off the power meter in dBm. The power output at the transmitter antenna port was determined by adding the value of the attenuator to the power meter reading. TS 151 010-1 is reference to conduct the test measurement of output power. The Procedure of KDB941225 (SAR Measurement Procedures for 3G devices, (WCDMA/HSPA) was used for EUT and Base station setting. RMC 12.2kps is used for this testing, and KDB 971168 D01 Power Meas License Digital System as the supplemental test methodology to adjust the proper setting obtaining the measurement results. All LTE bands conducted average power is obtained from the simulator telecommunication test set.

Unless otherwise stated the results shown in this test report refer only to the sample(s) tested and such sample(s) are retained for 90 days only.

除非另有說明，此報告結果僅對測試之樣品負責，同時此樣品僅保留90天。本報告未經本公司書面許可，不可部份複製。

This document is issued by the Company subject to its General Conditions of Service printed overleaf, available on request or accessible at <http://www.sgs.com.tw/Terms-and-Conditions> and for electronic format documents, subject to Terms and Conditions for Electronic Documents at <http://www.sgs.com.tw/Terms-and-Conditions>. Attention is drawn to the limitation of liability, indemnification and jurisdiction issues defined therein. Any holder of this document is advised that information contained hereon reflects the Company's findings at the time of its intervention only and within the limits of Client's instructions, if any. The Company's sole responsibility is to its Client and this document does not exonerate parties to a transaction from exercising all their rights and obligations under the transaction documents. This document cannot be reproduced except in full, without prior written approval of the Company. Any unauthorized alteration, forgery or falsification of the content or appearance of this document is unlawful and offenders may be prosecuted to the fullest extent of the law.

6.4 Determining ERP and/or EIRP from conducted RF output power measurements

According to KDB 412172 D01 Power Approach,

$$EIRP = P_T + G_T - L_C,$$

$$ERP = EIRP - 2.15,$$

Where:

ERP or EIRP = effective radiated power or equivalent isotropically radiated power (expressed in the same units as P_T , typically dBW, dBm, or power spectral density (PSD)², relative to either a dipole antenna (ERP) or an isotropic antenna (EIRP);

P_T = transmitter output power, expressed in dBW, dBm, or PSD;

G_T = gain of the transmitting antenna, in dBd (ERP) or dBi (EIRP);

L_C = signal attenuation in the connecting cable between the transmitter and antenna, in dB.

6.5 Measurement Equipment Used

Conducted Emission (measured at antenna port) Test Site					
EQUIPMENT TYPE	MFR	MODEL NUMBER	SERIAL NUMBER	LAST CAL.	CAL DUE.
DC Power Supply	Agilent	E3640A	MY40000811	12/23/2019	12/22/2020
Radio Communication Analyzer	Anritsu	MT8815B	6200711454	04/01/2020	03/31/2021
Radio Communication Analyzer	Anritsu	MT8821C	6261786084	01/18/2020	01/17/2021
Attenuator	Mini-Circuit	BW-S10W2+	2	01/02/2020	01/01/2021

Unless otherwise stated the results shown in this test report refer only to the sample(s) tested and such sample(s) are retained for 90 days only.

除非另有說明，此報告結果僅對測試之樣品負責，同時此樣品僅保留90天。本報告未經本公司書面許可，不可部份複製。

This document is issued by the Company subject to its General Conditions of Service printed overleaf, available on request or accessible at <http://www.sgs.com.tw/Terms-and-Conditions> and for electronic format documents, subject to Terms and Conditions for Electronic Documents at <http://www.sgs.com.tw/Terms-and-Conditions>. Attention is drawn to the limitation of liability, indemnification and jurisdiction issues defined therein. Any holder of this document is advised that information contained hereon reflects the Company's findings at the time of its intervention only and within the limits of Client's instructions, if any. The Company's sole responsibility is to its Client and this document does not exonerate parties to a transaction from exercising all their rights and obligations under the transaction documents. This document cannot be reproduced except in full, without prior written approval of the Company. Any unauthorized alteration, forgery or falsification of the content or appearance of this document is unlawful and offenders may be prosecuted to the fullest extent of the law.

6.6 GSM Measurement Results

GSM/GPRS/EDGE (GMSK; 8-PSK) Result:

EUT Mode	Freq. (MHz)	CH	Conducted Avg. Power (dBm)	Antenna Gain (dBi)	ERP (dBm)	EIRP (dBm)	Limit (dBm)	Margin (dB)
GSM 850	824.2	128	32.91	-4.20	26.56	28.71	38.50	-9.79
	836.6	190	32.34	-4.20	25.99	28.14	38.50	-10.36
	848.8	251	32.41	-4.20	26.06	28.21	38.50	-10.29
GSM 1900	1850.2	512	29.95	-4.30	23.50	25.65	33.00	-7.35
	1880.0	661	29.85	-4.30	23.40	25.55	33.00	-7.45
	1909.8	810	29.83	-4.30	23.38	25.53	33.00	-7.47
GPRS 850	824.2	128	32.89	-4.20	26.54	28.69	38.50	-9.81
	836.6	190	32.31	-4.20	25.96	28.11	38.50	-10.39
	848.8	251	32.37	-4.20	26.02	28.17	38.50	-10.33
GPRS 1900	1850.2	512	29.91	-4.30	23.46	25.61	33.00	-7.39
	1880.0	661	29.82	-4.30	23.37	25.52	33.00	-7.48
	1909.8	810	29.79	-4.30	23.34	25.49	33.00	-7.51

EUT Mode	Frequency (MHz)	CH	Average Burst Power (1DN 1UP) Class 8 (dBm)	Average Burst Power (1DN 2UP) Class 10 (dBm)	Average Burst Power (1DN 3UP) Class 12 (dBm)	Average Burst Power (1DN 4UP) Class 12 (dBm)
GPRS 850	824.2	128	32.89	29.72	27.77	27.23
	836.6	190	32.31	29.52	27.64	27.27
	848.8	251	32.37	29.62	27.66	27.31
GPRS 1900	1850.2	512	29.91	27.02	24.84	24.14
	1880.0	661	29.82	26.71	24.55	23.98
	1909.8	810	29.79	26.59	24.64	23.97

Unless otherwise stated the results shown in this test report refer only to the sample(s) tested and such sample(s) are retained for 90 days only.

除非另有說明，此報告結果僅對測試之樣品負責，同時此樣品僅保留90天。本報告未經本公司書面許可，不可部份複製。

This document is issued by the Company subject to its General Conditions of Service printed overleaf, available on request or accessible at <http://www.sgs.com.tw/Terms-and-Conditions> and for electronic format documents, subject to Terms and Conditions for Electronic Documents at <http://www.sgs.com.tw/Terms-and-Conditions>. Attention is drawn to the limitation of liability, indemnification and jurisdiction issues defined therein. Any holder of this document is advised that information contained hereon reflects the Company's findings at the time of its intervention only and within the limits of Client's instructions, if any. The Company's sole responsibility is to its Client and this document does not exonerate parties to a transaction from exercising all their rights and obligations under the transaction documents. This document cannot be reproduced except in full, without prior written approval of the Company. Any unauthorized alteration, forgery or falsification of the content or appearance of this document is unlawful and offenders may be prosecuted to the fullest extent of the law.

6.7 WCDMA & HSPA Measurement Results:

The following tests were completed according to the test requirements outlined in section 5.2 of the 3GPP TS34.121-1 specification. The EUT supports power Class 3, which has a nominal maximum output power of **25dBm**. RMC 12.2kps is used for this testing.

WCDMA/HSUPA/HSDPA Band V Result:

EUT Mode	Freq. (MHz)	CH	Conducted Avg. Power (dBm)	Antenna Gain (dBi)	ERP (dBm)	EIRP (dBm)	Limit (dBm)	Margin (dB)
WCDMA	826.4	4132	24.37	-4.20	18.02	20.17	38.50	-18.33
	836.6	4183	24.36	-4.20	18.01	20.16	38.50	-18.34
	846.6	4233	24.39	-4.20	18.04	20.19	38.50	-18.31
HSDPA	826.4	4132	23.40	-4.20	17.05	19.20	38.50	-19.30
	836.6	4183	23.38	-4.20	17.03	19.18	38.50	-19.32
	846.6	4233	23.41	-4.20	17.06	19.21	38.50	-19.29
HSUPA	826.4	4132	23.41	-4.20	17.06	19.21	38.50	-19.29
	836.6	4183	23.43	-4.20	17.08	19.23	38.50	-19.27
	846.6	4233	23.42	-4.20	17.07	19.22	38.50	-19.28

Unless otherwise stated the results shown in this test report refer only to the sample(s) tested and such sample(s) are retained for 90 days only.

除非另有說明，此報告結果僅對測試之樣品負責，同時此樣品僅保留90天。本報告未經本公司書面許可，不可部份複製。

This document is issued by the Company subject to its General Conditions of Service printed overleaf, available on request or accessible at <http://www.sgs.com.tw/Terms-and-Conditions> and for electronic format documents, subject to Terms and Conditions for Electronic Documents at <http://www.sgs.com.tw/Terms-and-Conditions>. Attention is drawn to the limitation of liability, indemnification and jurisdiction issues defined therein. Any holder of this document is advised that information contained hereon reflects the Company's findings at the time of its intervention only and within the limits of Client's instructions, if any. The Company's sole responsibility is to its Client and this document does not exonerate parties to a transaction from exercising all their rights and obligations under the transaction documents. This document cannot be reproduced except in full, without prior written approval of the Company. Any unauthorized alteration, forgery or falsification of the content or appearance of this document is unlawful and offenders may be prosecuted to the fullest extent of the law.

6.7.1 **HSPA (HSDPA & HSUPA) Release 6:**

The following 4 Sub-Tests were completed according to the test requirements outlined in section 5.2A of the 3GPP TS34.121-1 specification. All TX RMS power requirements for Power Class 3 were met according to table 5.2AA.5 and 5.2B.5 All UE channels and power ratio's are set according to table C10.1.4 & C11.1.3 in the 3GPP TS34.121-1. RMC 12.2kps is used for this testing.

6.7.2 **HSDPA SUB-TEST Setting**

Table C.10.1.4: β values for transmitter characteristics tests with HS-DPCCH(FOR HSDPA)

Sub-test	β_c	β_d	β_d (SF)	β_c/β_d	β_{HS} (Note 1, Note 2)	CM (dB) (Note 3)	MPR (dB) (Note 3)	RMC (Kbps)
1	2/15	15/15	64	2/15	4/15	0.0	0.0	12.2
2	12/15 (Note 4)	15/15 (Note 4)	64	12/15 (Note 4)	24/15	1.0	0.0	12.2
3	15/15	8/15	64	15/8	30/15	1.5	0.5	12.2
4	15/15	4/15	64	15/4	30/15	1.5	0.5	12.2

Note: The recommended HSDPA MPRs are implemented as per following sub-tests.

Mode	Sub test	Avg. Power (dBm)		
		Channel		
		4132.00	4183.00	4233.00
HSDPA V	1	23.40	23.38	23.41
	2	22.90	22.89	22.91
	3	22.89	22.87	22.89
	4	22.86	22.85	22.88

Unless otherwise stated the results shown in this test report refer only to the sample(s) tested and such sample(s) are retained for 90 days only.

除非另有說明，此報告結果僅對測試之樣品負責，同時此樣品僅保留90天。本報告未經本公司書面許可，不可部份複製。

This document is issued by the Company subject to its General Conditions of Service printed overleaf, available on request or accessible at <http://www.sgs.com.tw/Terms-and-Conditions> and for electronic format documents, subject to Terms and Conditions for Electronic Documents at <http://www.sgs.com.tw/Terms-and-Conditions>. Attention is drawn to the limitation of liability, indemnification and jurisdiction issues defined therein. Any holder of this document is advised that information contained hereon reflects the Company's findings at the time of its intervention only and within the limits of Client's instructions, if any. The Company's sole responsibility is to its Client and this document does not exonerate parties to a transaction from exercising all their rights and obligations under the transaction documents. This document cannot be reproduced except in full, without prior written approval of the Company. Any unauthorized alteration, forgery or falsification of the content or appearance of this document is unlawful and offenders may be prosecuted to the fullest extent of the law.

6.7.3 HSPA SUB-TEST Setting

Table C.11.1.3: β values for transmitter characteristics tests with HS-DPCCH and E-DCH(FOR HSUPA)

Sub-test	β_c	β_d	β_d (SF)	β_c/β_d	β_{HS}	β_{ec}	β_{ed}	β_{ed} (SF)	β_{ed} (Code s)	CM (dB)	MPR (dB)	AG Index	E-TFCI	RMC (Kbps)
1	11/15 (Note 3)	15/15 (Note 3)	64	11/15 (Note 3)	22/15	209/225	1309/225	4	1	1.0	0.0	20	75	12.2
2	6/15	15/15	64	6/15	12/15	12/15	94/75	4	1	3.0	2.0	12	67	12.2
3	15/15	9/15	64	15/9	30/15	30/15	β_{ed1} : 47/15 β_{ed2} : 47/15	4 4	2	2.0	1.0	15	92	12.2
4	2/15	15/15	64	2/15	4/15	2/15	56/75	4	1	3.0	2.0	17	71	12.2
5	15/15 (Note 4)	15/15 (Note 4)	64	15/15 (Note 4)	30/15	24/15	134/15	4	1	1.0	0.0	21	81	12.2

Note: The recommended HSUPA MPRs are implemented as per following sub-tests.

Mode	Sub test	Avg. Power (dBm)		
		Channel		
		4132.00	4183.00	4233.00
HSUPA V	1	23.41	23.43	23.42
	2	21.43	21.41	21.39
	3	22.43	22.41	22.42
	4	21.41	21.41	21.44
	5	23.42	23.51	23.41

6.7.4 WCDMA/HSDPA/HSUPA band V

The EUT output power was controlled by simulator and enter max rated power 24dBm. The EUT is going to be set to max output power to 24dBm then record the read. The min. power was measures by a function key “minimum power” then record the read. It is -52.3dBm. The power variation can be 0.1dB step by setting.

6.7.5 Minimum Communications Power Measurement PCS 1900 band

PCL	0	1	2	3	4	5	6	7	8
Output power (dBm)	30.47	29.12	27.16	25.1	22.94	20.86	18.84	17.03	14.9

PCL	9	10	11	12	13	14	15
Output power (dBm)	12.82	10.85	8.84	6.86	4.82	2.8	1.23

Unless otherwise stated the results shown in this test report refer only to the sample(s) tested and such sample(s) are retained for 90 days only.

除非另有說明，此報告結果僅對測試之樣品負責，同時此樣品僅保留90天。本報告未經本公司書面許可，不可部份複製。

This document is issued by the Company subject to its General Conditions of Service printed overleaf, available on request or accessible at <http://www.sgs.com.tw/Terms-and-Conditions> and for electronic format documents, subject to Terms and Conditions for Electronic Documents at <http://www.sgs.com.tw/Terms-and-Conditions>. Attention is drawn to the limitation of liability, indemnification and jurisdiction issues defined therein. Any holder of this document is advised that information contained hereon reflects the Company's findings at the time of its intervention only and within the limits of Client's instructions, if any. The Company's sole responsibility is to its Client and this document does not exonerate parties to a transaction from exercising all their rights and obligations under the transaction documents. This document cannot be reproduced except in full, without prior written approval of the Company. Any unauthorized alteration, forgery or falsification of the content or appearance of this document is unlawful and offenders may be prosecuted to the fullest extent of the law.

6.8 LTE Measurement Results:

Antenna gain (dBi) **-4.2**

LTE Band 5_Uplink frequency band : 824 to 849 MHz										
BW (MHz)	UL Channel	Frequency (MHz)	Modulation	RB Size	RB Offset	Conducted Average (dBm)	ERP Average (dBm)	EIRP Average (dBm)	ERP Limit (dBm)	Margin (dB)
1.4	20407	824.7	QPSK	1	0	23.12	16.77	18.92	38.45	-21.68
				1	5	23.10	16.75	18.90	38.45	-21.70
				3	2	23.15	16.80	18.95	38.45	-21.65
				6	0	22.13	15.78	17.93	38.45	-22.67
	20525	836.5	QPSK	1	0	23.06	16.71	18.86	38.45	-21.74
				1	5	23.09	16.74	18.89	38.45	-21.71
				3	2	23.16	16.81	18.96	38.45	-21.64
				6	0	22.19	15.84	17.99	38.45	-22.61
	20643	848.3	QPSK	1	0	23.02	16.67	18.82	38.45	-21.78
				1	5	22.99	16.64	18.79	38.45	-21.81
				3	2	23.17	16.82	18.97	38.45	-21.63
				6	0	22.11	15.76	17.91	38.45	-22.69
	20407	824.7	16QAM	1	0	22.72	16.37	18.52	38.45	-22.08
				1	5	22.29	15.94	18.09	38.45	-22.51
				3	2	22.08	15.73	17.88	38.45	-22.72
				6	0	21.21	14.86	17.01	38.45	-23.59
	20525	836.5	16QAM	1	0	22.31	15.96	18.11	38.45	-22.49
				1	5	22.15	15.80	17.95	38.45	-22.65
				3	2	22.11	15.76	17.91	38.45	-22.69
				6	0	21.13	14.78	16.93	38.45	-23.67
	20643	848.3	16QAM	1	0	22.41	16.06	18.21	38.45	-22.39
				1	5	22.25	15.90	18.05	38.45	-22.55
				3	2	21.99	15.64	17.79	38.45	-22.81
				6	0	21.21	14.86	17.01	38.45	-23.59
	20407	824.7	64QAM	1	0	21.15	14.80	16.95	38.45	-23.65
				1	5	21.04	14.69	16.84	38.45	-23.76
				3	2	20.39	14.04	16.19	38.45	-24.41
				6	0	19.94	13.59	15.74	38.45	-24.86
	20525	836.5	64QAM	1	0	21.11	14.76	16.91	38.45	-23.69
				1	5	20.97	14.62	16.77	38.45	-23.83
				3	2	20.49	14.14	16.29	38.45	-24.31
				6	0	19.90	13.55	15.70	38.45	-24.90
	20643	848.3	64QAM	1	0	20.92	14.57	16.72	38.45	-23.88
				1	5	20.91	14.56	16.71	38.45	-23.89
				3	2	20.41	14.06	16.21	38.45	-24.39
				6	0	19.85	13.50	15.65	38.45	-24.95

Unless otherwise stated the results shown in this test report refer only to the sample(s) tested and such sample(s) are retained for 90 days only.

除非另有說明，此報告結果僅對測試之樣品負責，同時此樣品僅保留90天。本報告未經本公司書面許可，不可部份複製。

This document is issued by the Company subject to its General Conditions of Service printed overleaf, available on request or accessible at <http://www.sgs.com.tw/Terms-and-Conditions> and for electronic format documents, subject to Terms and Conditions for Electronic Documents at <http://www.sgs.com.tw/Terms-and-Conditions>. Attention is drawn to the limitation of liability, indemnification and jurisdiction issues defined therein. Any holder of this document is advised that information contained hereon reflects the Company's findings at the time of its intervention only and within the limits of Client's instructions, if any. The Company's sole responsibility is to its Client and this document does not exonerate parties to a transaction from exercising all their rights and obligations under the transaction documents. This document cannot be reproduced except in full, without prior written approval of the Company. Any unauthorized alteration, forgery or falsification of the content or appearance of this document is unlawful and offenders may be prosecuted to the fullest extent of the law.

Antenna gain (dBi)		-4.2								
LTE Band 5_Uplink frequency band : 824 to 849 MHz										
BW (MHz)	UL Channel	Frequency (MHz)	Modulation	RB Size	RB Offset	Conducted Average (dBm)	ERP Average (dBm)	EIRP Average (dBm)	ERP Limit (dBm)	Margin (dB)
3	20415	825.5	QPSK	1	0	23.20	16.85	19.00	38.45	-21.60
				1	14	23.07	16.72	18.87	38.45	-21.73
				8	4	22.28	15.93	18.08	38.45	-22.52
				15	0	22.27	15.92	18.07	38.45	-22.53
	20525	836.5	QPSK	1	0	23.17	16.82	18.97	38.45	-21.63
				1	14	23.21	16.86	19.01	38.45	-21.59
				8	4	22.31	15.96	18.11	38.45	-22.49
				15	0	22.18	15.83	17.98	38.45	-22.62
	20635	847.5	QPSK	1	0	23.29	16.94	19.09	38.45	-21.51
				1	14	23.19	16.84	18.99	38.45	-21.61
				8	4	22.21	15.86	18.01	38.45	-22.59
				15	0	22.23	15.88	18.03	38.45	-22.57
	20415	825.5	16QAM	1	0	22.19	15.84	17.99	38.45	-22.61
				1	14	22.46	16.11	18.26	38.45	-22.34
				8	4	21.22	14.87	17.02	38.45	-23.58
				15	0	21.12	14.77	16.92	38.45	-23.68
	20525	836.5	16QAM	1	0	22.73	16.38	18.53	38.45	-22.07
				1	14	22.54	16.19	18.34	38.45	-22.26
				8	4	21.28	14.93	17.08	38.45	-23.52
				15	0	21.19	14.84	16.99	38.45	-23.61
	20635	847.5	16QAM	1	0	22.22	15.87	18.02	38.45	-22.58
				1	14	22.43	16.08	18.23	38.45	-22.37
				8	4	21.17	14.82	16.97	38.45	-23.63
				15	0	21.29	14.94	17.09	38.45	-23.51
	20415	825.5	64QAM	1	0	21.22	14.87	17.02	38.45	-23.58
				1	14	21.15	14.80	16.95	38.45	-23.65
				8	4	20.18	13.83	15.98	38.45	-24.62
				15	0	19.91	13.56	15.71	38.45	-24.89
	20525	836.5	64QAM	1	0	21.13	14.78	16.93	38.45	-23.67
				1	14	21.01	14.66	16.81	38.45	-23.79
				8	4	20.13	13.78	15.93	38.45	-24.67
				15	0	19.94	13.59	15.74	38.45	-24.86
	20635	847.5	64QAM	1	0	21.09	14.74	16.89	38.45	-23.71
				1	14	21.02	14.67	16.82	38.45	-23.78
				8	4	20.03	13.68	15.83	38.45	-24.77
				15	0	19.91	13.56	15.71	38.45	-24.89

Unless otherwise stated the results shown in this test report refer only to the sample(s) tested and such sample(s) are retained for 90 days only.

除非另有說明，此報告結果僅對測試之樣品負責，同時此樣品僅保留90天。本報告未經本公司書面許可，不可部份複製。

This document is issued by the Company subject to its General Conditions of Service printed overleaf, available on request or accessible at <http://www.sgs.com.tw/Terms-and-Conditions> and for electronic format documents, subject to Terms and Conditions for Electronic Documents at <http://www.sgs.com.tw/Terms-and-Conditions>. Attention is drawn to the limitation of liability, indemnification and jurisdiction issues defined therein. Any holder of this document is advised that information contained hereon reflects the Company's findings at the time of its intervention only and within the limits of Client's instructions, if any. The Company's sole responsibility is to its Client and this document does not exonerate parties to a transaction from exercising all their rights and obligations under the transaction documents. This document cannot be reproduced except in full, without prior written approval of the Company. Any unauthorized alteration, forgery or falsification of the content or appearance of this document is unlawful and offenders may be prosecuted to the fullest extent of the law.

Antenna gain (dBi)		-4.2								
LTE Band 5_Uplink frequency band : 824 to 849 MHz										
BW (MHz)	UL Channel	Frequency (MHz)	Modulation	RB Size	RB Offset	Conducted Average (dBm)	ERP Average (dBm)	EIRP Average (dBm)	ERP Limit (dBm)	Margin (dB)
5	20425	826.5	QPSK	1	0	23.27	16.92	19.07	38.45	-21.53
				1	24	23.21	16.86	19.01	38.45	-21.59
				12	6	22.20	15.85	18.00	38.45	-22.60
				25	0	22.29	15.94	18.09	38.45	-22.51
	20525	836.5	QPSK	1	0	23.11	16.76	18.91	38.45	-21.69
				1	24	23.21	16.86	19.01	38.45	-21.59
				12	6	22.25	15.90	18.05	38.45	-22.55
				25	0	22.28	15.93	18.08	38.45	-22.52
	20625	846.5	QPSK	1	0	23.23	16.88	19.03	38.45	-21.57
				1	24	23.20	16.85	19.00	38.45	-21.60
				12	6	22.23	15.88	18.03	38.45	-22.57
				25	0	22.15	15.80	17.95	38.45	-22.65
	20425	826.5	16QAM	1	0	22.72	16.37	18.52	38.45	-22.08
				1	24	22.10	15.75	17.90	38.45	-22.70
				12	6	21.16	14.81	16.96	38.45	-23.64
				25	0	21.37	15.02	17.17	38.45	-23.43
	20525	836.5	16QAM	1	0	22.78	16.43	18.58	38.45	-22.02
				1	24	22.20	15.85	18.00	38.45	-22.60
				12	6	21.31	14.96	17.11	38.45	-23.49
				25	0	21.18	14.83	16.98	38.45	-23.62
	20625	846.5	16QAM	1	0	22.71	16.36	18.51	38.45	-22.09
				1	24	22.46	16.11	18.26	38.45	-22.34
				12	6	21.32	14.97	17.12	38.45	-23.48
				25	0	21.23	14.88	17.03	38.45	-23.57
	20425	826.5	64QAM	1	0	21.18	14.83	16.98	38.45	-23.62
				1	24	21.16	14.81	16.96	38.45	-23.64
				12	6	20.15	13.80	15.95	38.45	-24.65
				25	0	19.91	13.56	15.71	38.45	-24.89
	20525	836.5	64QAM	1	0	21.16	14.81	16.96	38.45	-23.64
				1	24	21.04	14.69	16.84	38.45	-23.76
				12	6	20.05	13.70	15.85	38.45	-24.75
				25	0	19.86	13.51	15.66	38.45	-24.94
	20625	846.5	64QAM	1	0	21.05	14.70	16.85	38.45	-23.75
				1	24	20.92	14.57	16.72	38.45	-23.88
				12	6	19.96	13.61	15.76	38.45	-24.84
				25	0	19.90	13.55	15.70	38.45	-24.90

Unless otherwise stated the results shown in this test report refer only to the sample(s) tested and such sample(s) are retained for 90 days only.

除非另有說明，此報告結果僅對測試之樣品負責，同時此樣品僅保留90天。本報告未經本公司書面許可，不可部份複製。

This document is issued by the Company subject to its General Conditions of Service printed overleaf, available on request or accessible at <http://www.sgs.com.tw/Terms-and-Conditions> and for electronic format documents, subject to Terms and Conditions for Electronic Documents at <http://www.sgs.com.tw/Terms-and-Conditions>. Attention is drawn to the limitation of liability, indemnification and jurisdiction issues defined therein. Any holder of this document is advised that information contained hereon reflects the Company's findings at the time of its intervention only and within the limits of Client's instructions, if any. The Company's sole responsibility is to its Client and this document does not exonerate parties to a transaction from exercising all their rights and obligations under the transaction documents. This document cannot be reproduced except in full, without prior written approval of the Company. Any unauthorized alteration, forgery or falsification of the content or appearance of this document is unlawful and offenders may be prosecuted to the fullest extent of the law.

Antenna gain (dBi)		-4.2								
LTE Band 5_Uplink frequency band : 824 to 849 MHz										
BW (MHz)	UL Channel	Frequency (MHz)	Modulation	RB Size	RB Offset	Conducted Average (dBm)	ERP Average (dBm)	EIRP Average (dBm)	ERP Limit (dBm)	Margin (dB)
10	20450	829	QPSK	1	0	23.10	16.75	18.90	38.45	-21.70
				1	49	23.37	17.02	19.17	38.45	-21.43
				25	12	22.25	15.90	18.05	38.45	-22.55
				50	0	22.25	15.90	18.05	38.45	-22.55
	20525	836.5	QPSK	1	0	23.40	17.05	19.20	38.45	-21.40
				1	49	23.21	16.86	19.01	38.45	-21.59
				25	12	22.26	15.91	18.06	38.45	-22.54
				50	0	22.24	15.89	18.04	38.45	-22.56
	20600	844	QPSK	1	0	23.25	16.90	19.05	38.45	-21.55
				1	49	23.19	16.84	18.99	38.45	-21.61
				25	12	22.16	15.81	17.96	38.45	-22.64
				50	0	22.14	15.79	17.94	38.45	-22.66
	20450	829	16QAM	1	0	22.35	16.00	18.15	38.45	-22.45
				1	49	22.55	16.20	18.35	38.45	-22.25
				25	12	21.33	14.98	17.13	38.45	-23.47
				50	0	21.23	14.88	17.03	38.45	-23.57
	20525	836.5	16QAM	1	0	22.28	15.93	18.08	38.45	-22.52
				1	49	22.31	15.96	18.11	38.45	-22.49
				25	12	21.26	14.91	17.06	38.45	-23.54
				50	0	21.26	14.91	17.06	38.45	-23.54
	20600	844	16QAM	1	0	22.13	15.78	17.93	38.45	-22.67
				1	49	22.69	16.34	18.49	38.45	-22.11
				25	12	21.25	14.90	17.05	38.45	-23.55
				50	0	21.21	14.86	17.01	38.45	-23.59
	20450	829	64QAM	1	0	21.23	14.88	17.03	38.45	-23.57
				1	49	21.17	14.82	16.97	38.45	-23.63
				25	12	20.19	13.84	15.99	38.45	-24.61
				50	0	20.03	13.68	15.83	38.45	-24.77
	20525	836.5	64QAM	1	0	21.23	14.88	17.03	38.45	-23.57
				1	49	21.07	14.72	16.87	38.45	-23.73
				25	12	20.14	13.79	15.94	38.45	-24.66
				50	0	19.99	13.64	15.79	38.45	-24.81
	20600	844	64QAM	1	0	21.12	14.77	16.92	38.45	-23.68
				1	49	21.03	14.68	16.83	38.45	-23.77
				25	12	20.11	13.76	15.91	38.45	-24.69
				50	0	20.02	13.67	15.82	38.45	-24.78

Unless otherwise stated the results shown in this test report refer only to the sample(s) tested and such sample(s) are retained for 90 days only.

除非另有說明，此報告結果僅對測試之樣品負責，同時此樣品僅保留90天。本報告未經本公司書面許可，不可部份複製。

This document is issued by the Company subject to its General Conditions of Service printed overleaf, available on request or accessible at <http://www.sgs.com.tw/Terms-and-Conditions> and for electronic format documents, subject to Terms and Conditions for Electronic Documents at <http://www.sgs.com.tw/Terms-and-Conditions>. Attention is drawn to the limitation of liability, indemnification and jurisdiction issues defined therein. Any holder of this document is advised that information contained hereon reflects the Company's findings at the time of its intervention only and within the limits of Client's instructions, if any. The Company's sole responsibility is to its Client and this document does not exonerate parties to a transaction from exercising all their rights and obligations under the transaction documents. This document cannot be reproduced except in full, without prior written approval of the Company. Any unauthorized alteration, forgery or falsification of the content or appearance of this document is unlawful and offenders may be prosecuted to the fullest extent of the law.

Antenna gain (dBi)		-4.8		LTE Band 12_Uplink frequency band : 699 to 716 MHz						
BW (MHz)	UL Channel	Frequency (MHz)	Modulation	RB Size	RB Offset	Conducted Average (dBm)	ERP Average (dBm)	EIRP Average (dBm)	ERP Limit (dBm)	Margin (dB)
1.4	23017	699.7	QPSK	1	0	23.18	16.23	18.38	34.77	-18.54
				1	5	23.22	16.27	18.42	34.77	-18.50
				3	2	23.23	16.28	18.43	34.77	-18.49
				6	0	22.34	15.39	17.54	34.77	-19.38
	23095	707.5	QPSK	1	0	23.11	16.16	18.31	34.77	-18.61
				1	5	23.28	16.33	18.48	34.77	-18.44
				3	2	23.22	16.27	18.42	34.77	-18.50
				6	0	22.26	15.31	17.46	34.77	-19.46
	23173	715.5	QPSK	1	0	23.13	16.18	18.33	34.77	-18.59
				1	5	23.12	16.17	18.32	34.77	-18.60
				3	2	23.22	16.27	18.42	34.77	-18.50
				6	0	22.24	15.29	17.44	34.77	-19.48
	23017	699.7	16QAM	1	0	22.77	15.82	17.97	34.77	-18.95
				1	5	22.68	15.73	17.88	34.77	-19.04
				3	2	22.27	15.32	17.47	34.77	-19.45
				6	0	21.34	14.39	16.54	34.77	-20.38
	23095	707.5	16QAM	1	0	22.28	15.33	17.48	34.77	-19.44
				1	5	22.32	15.37	17.52	34.77	-19.40
				3	2	22.43	15.48	17.63	34.77	-19.29
				6	0	21.33	14.38	16.53	34.77	-20.39
	23173	715.5	16QAM	1	0	22.33	15.38	17.53	34.77	-19.39
				1	5	22.15	15.20	17.35	34.77	-19.57
				3	2	22.25	15.30	17.45	34.77	-19.47
				6	0	21.38	14.43	16.58	34.77	-20.34
	23017	699.7	64QAM	1	0	21.26	14.31	16.46	34.77	-20.46
				1	5	21.26	14.31	16.46	34.77	-20.46
				3	2	20.41	13.46	15.61	34.77	-21.31
				6	0	20.14	13.19	15.34	34.77	-21.58
	23095	707.5	64QAM	1	0	21.32	14.37	16.52	34.77	-20.40
				1	5	21.21	14.26	16.41	34.77	-20.51
				3	2	20.52	13.57	15.72	34.77	-21.20
				6	0	20.10	13.15	15.30	34.77	-21.62
	23173	715.5	64QAM	1	0	21.07	14.12	16.27	34.77	-20.65
				1	5	21.22	14.27	16.42	34.77	-20.50
				3	2	20.44	13.49	15.64	34.77	-21.28
				6	0	20.08	13.13	15.28	34.77	-21.64

Unless otherwise stated the results shown in this test report refer only to the sample(s) tested and such sample(s) are retained for 90 days only.

除非另有說明，此報告結果僅對測試之樣品負責，同時此樣品僅保留90天。本報告未經本公司書面許可，不可部份複製。

This document is issued by the Company subject to its General Conditions of Service printed overleaf, available on request or accessible at <http://www.sgs.com.tw/Terms-and-Conditions> and for electronic format documents, subject to Terms and Conditions for Electronic Documents at <http://www.sgs.com.tw/Terms-and-Conditions>. Attention is drawn to the limitation of liability, indemnification and jurisdiction issues defined therein. Any holder of this document is advised that information contained hereon reflects the Company's findings at the time of its intervention only and within the limits of Client's instructions, if any. The Company's sole responsibility is to its Client and this document does not exonerate parties to a transaction from exercising all their rights and obligations under the transaction documents. This document cannot be reproduced except in full, without prior written approval of the Company. Any unauthorized alteration, forgery or falsification of the content or appearance of this document is unlawful and offenders may be prosecuted to the fullest extent of the law.

Antenna gain (dBi)		-4.8								
LTE Band 12_Uplink frequency band : 699 to 716 MHz										
BW (MHz)	UL Channel	Frequency (MHz)	Modulation	RB Size	RB Offset	Conducted Average (dBm)	ERP Average (dBm)	EIRP Average (dBm)	ERP Limit (dBm)	Margin (dB)
3	23025	700.5	QPSK	1	0	23.23	16.28	18.43	34.77	-18.49
				1	14	23.21	16.26	18.41	34.77	-18.51
				8	4	22.30	15.35	17.50	34.77	-19.42
				15	0	22.32	15.37	17.52	34.77	-19.40
	23095	707.5	QPSK	1	0	23.38	16.43	18.58	34.77	-18.34
				1	14	23.25	16.30	18.45	34.77	-18.47
				8	4	22.36	15.41	17.56	34.77	-19.36
				15	0	22.29	15.34	17.49	34.77	-19.43
	23165	714.5	QPSK	1	0	23.16	16.21	18.36	34.77	-18.56
				1	14	23.18	16.23	18.38	34.77	-18.54
				8	4	22.29	15.34	17.49	34.77	-19.43
				15	0	22.26	15.31	17.46	34.77	-19.46
	23025	700.5	16QAM	1	0	22.62	15.67	17.82	34.77	-19.10
				1	14	22.30	15.35	17.50	34.77	-19.42
				8	4	21.46	14.51	16.66	34.77	-20.26
				15	0	21.24	14.29	16.44	34.77	-20.48
	23095	707.5	16QAM	1	0	22.48	15.53	17.68	34.77	-19.24
				1	14	22.38	15.43	17.58	34.77	-19.34
				8	4	21.31	14.36	16.51	34.77	-20.41
				15	0	21.42	14.47	16.62	34.77	-20.30
	23165	714.5	16QAM	1	0	22.53	15.58	17.73	34.77	-19.19
				1	14	22.75	15.80	17.95	34.77	-18.97
				8	4	21.40	14.45	16.60	34.77	-20.32
				15	0	21.29	14.34	16.49	34.77	-20.43
	23025	700.5	64QAM	1	0	21.25	14.30	16.45	34.77	-20.47
				1	14	21.28	14.33	16.48	34.77	-20.44
				8	4	20.30	13.35	15.50	34.77	-21.42
				15	0	20.16	13.21	15.36	34.77	-21.56
	23095	707.5	64QAM	1	0	21.33	14.38	16.53	34.77	-20.39
				1	14	21.19	14.24	16.39	34.77	-20.53
				8	4	20.18	13.23	15.38	34.77	-21.54
				15	0	20.19	13.24	15.39	34.77	-21.53
	23165	714.5	64QAM	1	0	21.09	14.14	16.29	34.77	-20.63
				1	14	21.10	14.15	16.30	34.77	-20.62
				8	4	20.16	13.21	15.36	34.77	-21.56
				15	0	20.10	13.15	15.30	34.77	-21.62

Unless otherwise stated the results shown in this test report refer only to the sample(s) tested and such sample(s) are retained for 90 days only.

除非另有說明，此報告結果僅對測試之樣品負責，同時此樣品僅保留90天。本報告未經本公司書面許可，不可部份複製。

This document is issued by the Company subject to its General Conditions of Service printed overleaf, available on request or accessible at <http://www.sgs.com.tw/Terms-and-Conditions> and for electronic format documents, subject to Terms and Conditions for Electronic Documents at <http://www.sgs.com.tw/Terms-and-Conditions>. Attention is drawn to the limitation of liability, indemnification and jurisdiction issues defined therein. Any holder of this document is advised that information contained hereon reflects the Company's findings at the time of its intervention only and within the limits of Client's instructions, if any. The Company's sole responsibility is to its Client and this document does not exonerate parties to a transaction from exercising all their rights and obligations under the transaction documents. This document cannot be reproduced except in full, without prior written approval of the Company. Any unauthorized alteration, forgery or falsification of the content or appearance of this document is unlawful and offenders may be prosecuted to the fullest extent of the law.

Antenna gain (dBi)		-4.8								
LTE Band 12_Uplink frequency band : 699 to 716 MHz										
BW (MHz)	UL Channel	Frequency (MHz)	Modulation	RB Size	RB Offset	Conducted Average (dBm)	ERP Average (dBm)	EIRP Average (dBm)	ERP Limit (dBm)	Margin (dB)
5	23035	701.5	QPSK	1	0	23.21	16.26	18.41	34.77	-18.51
				1	24	23.36	16.41	18.56	34.77	-18.36
				12	6	22.43	15.48	17.63	34.77	-19.29
				25	0	22.36	15.41	17.56	34.77	-19.36
	23095	707.5	QPSK	1	0	23.21	16.26	18.41	34.77	-18.51
				1	24	23.34	16.39	18.54	34.77	-18.38
				12	6	22.29	15.34	17.49	34.77	-19.43
				25	0	22.46	15.51	17.66	34.77	-19.26
	23155	713.5	QPSK	1	0	23.34	16.39	18.54	34.77	-18.38
				1	24	23.24	16.29	18.44	34.77	-18.48
				12	6	22.25	15.30	17.45	34.77	-19.47
				25	0	22.29	15.34	17.49	34.77	-19.43
	23035	701.5	16QAM	1	0	22.16	15.21	17.36	34.77	-19.56
				1	24	22.54	15.59	17.74	34.77	-19.18
				12	6	21.48	14.53	16.68	34.77	-20.24
				25	0	21.27	14.32	16.47	34.77	-20.45
	23095	707.5	16QAM	1	0	22.71	15.76	17.91	34.77	-19.01
				1	24	22.63	15.68	17.83	34.77	-19.09
				12	6	21.44	14.49	16.64	34.77	-20.28
				25	0	21.36	14.41	16.56	34.77	-20.36
	23155	713.5	16QAM	1	0	22.28	15.33	17.48	34.77	-19.44
				1	24	22.46	15.51	17.66	34.77	-19.26
				12	6	21.72	14.77	16.92	34.77	-20.00
				25	0	21.29	14.34	16.49	34.77	-20.43
	23035	701.5	64QAM	1	0	21.31	14.36	16.51	34.77	-20.41
				1	24	21.27	14.32	16.47	34.77	-20.45
				12	6	20.27	13.32	15.47	34.77	-21.45
				25	0	20.22	13.27	15.42	34.77	-21.50
	23095	707.5	64QAM	1	0	21.21	14.26	16.41	34.77	-20.51
				1	24	21.19	14.24	16.39	34.77	-20.53
				12	6	20.21	13.26	15.41	34.77	-21.51
				25	0	20.09	13.14	15.29	34.77	-21.63
	23155	713.5	64QAM	1	0	21.07	14.12	16.27	34.77	-20.65
				1	24	21.08	14.13	16.28	34.77	-20.64
				12	6	20.17	13.22	15.37	34.77	-21.55
				25	0	20.07	13.12	15.27	34.77	-21.65

Unless otherwise stated the results shown in this test report refer only to the sample(s) tested and such sample(s) are retained for 90 days only.

除非另有說明，此報告結果僅對測試之樣品負責，同時此樣品僅保留90天。本報告未經本公司書面許可，不可部份複製。

This document is issued by the Company subject to its General Conditions of Service printed overleaf, available on request or accessible at <http://www.sgs.com.tw/Terms-and-Conditions> and for electronic format documents, subject to Terms and Conditions for Electronic Documents at <http://www.sgs.com.tw/Terms-and-Conditions>. Attention is drawn to the limitation of liability, indemnification and jurisdiction issues defined therein. Any holder of this document is advised that information contained hereon reflects the Company's findings at the time of its intervention only and within the limits of Client's instructions, if any. The Company's sole responsibility is to its Client and this document does not exonerate parties to a transaction from exercising all their rights and obligations under the transaction documents. This document cannot be reproduced except in full, without prior written approval of the Company. Any unauthorized alteration, forgery or falsification of the content or appearance of this document is unlawful and offenders may be prosecuted to the fullest extent of the law.

Antenna gain (dBi)		-4.8								
LTE Band 12_Uplink frequency band : 699 to 716 MHz										
BW (MHz)	UL Channel	Frequency (MHz)	Modulation	RB Size	RB Offset	Conducted Average (dBm)	ERP Average (dBm)	EIRP Average (dBm)	ERP Limit (dBm)	Margin (dB)
10	23060	704	QPSK	1	0	23.20	16.25	18.40	34.77	-18.52
				1	49	23.44	16.49	18.64	34.77	-18.28
				25	12	22.40	15.45	17.60	34.77	-19.32
				50	0	22.32	15.37	17.52	34.77	-19.40
	23095	707.5	QPSK	1	0	23.19	16.24	18.39	34.77	-18.53
				1	49	23.89	16.94	19.09	34.77	-17.83
				25	12	22.32	15.37	17.52	34.77	-19.40
				50	0	22.41	15.46	17.61	34.77	-19.31
	23130	711	QPSK	1	0	23.53	16.58	18.73	34.77	-18.19
				1	49	23.17	16.22	18.37	34.77	-18.55
				25	12	22.29	15.34	17.49	34.77	-19.43
				50	0	22.15	15.20	17.35	34.77	-19.57
	23060	704	16QAM	1	0	22.45	15.50	17.65	34.77	-19.27
				1	49	23.00	16.05	18.20	34.77	-18.72
				25	12	21.44	14.49	16.64	34.77	-20.28
				50	0	21.55	14.60	16.75	34.77	-20.17
	23095	707.5	16QAM	1	0	22.52	15.57	17.72	34.77	-19.20
				1	49	22.63	15.68	17.83	34.77	-19.09
				25	12	21.37	14.42	16.57	34.77	-20.35
				50	0	21.38	14.43	16.58	34.77	-20.34
	23130	711	16QAM	1	0	22.34	15.39	17.54	34.77	-19.38
				1	49	22.65	15.70	17.85	34.77	-19.07
				25	12	21.51	14.56	16.71	34.77	-20.21
				50	0	21.25	14.30	16.45	34.77	-20.47
	23060	704	64QAM	1	0	21.36	14.41	16.56	34.77	-20.36
				1	49	21.39	14.44	16.59	34.77	-20.33
				25	12	20.37	13.42	15.57	34.77	-21.35
				50	0	20.28	13.33	15.48	34.77	-21.44
	23095	707.5	64QAM	1	0	21.33	14.38	16.53	34.77	-20.39
				1	49	21.30	14.35	16.50	34.77	-20.42
				25	12	20.27	13.32	15.47	34.77	-21.45
				50	0	20.20	13.25	15.40	34.77	-21.52
	23130	711	64QAM	1	0	21.19	14.24	16.39	34.77	-20.53
				1	49	21.22	14.27	16.42	34.77	-20.50
				25	12	20.28	13.33	15.48	34.77	-21.44
				50	0	20.19	13.24	15.39	34.77	-21.53

Unless otherwise stated the results shown in this test report refer only to the sample(s) tested and such sample(s) are retained for 90 days only.

除非另有說明，此報告結果僅對測試之樣品負責，同時此樣品僅保留90天。本報告未經本公司書面許可，不可部份複製。

This document is issued by the Company subject to its General Conditions of Service printed overleaf, available on request or accessible at <http://www.sgs.com.tw/Terms-and-Conditions> and for electronic format documents, subject to Terms and Conditions for Electronic Documents at <http://www.sgs.com.tw/Terms-and-Conditions>. Attention is drawn to the limitation of liability, indemnification and jurisdiction issues defined therein. Any holder of this document is advised that information contained hereon reflects the Company's findings at the time of its intervention only and within the limits of Client's instructions, if any. The Company's sole responsibility is to its Client and this document does not exonerate parties to a transaction from exercising all their rights and obligations under the transaction documents. This document cannot be reproduced except in full, without prior written approval of the Company. Any unauthorized alteration, forgery or falsification of the content or appearance of this document is unlawful and offenders may be prosecuted to the fullest extent of the law.

Antenna gain (dBi)		-4.8		LTE Band 17_Uplink frequency band : 704 to 716 MHz							
BW (MHz)	UL Channel	Frequency (MHz)	Modulation	RB Size	RB Offset	Conducted Average (dBm)	ERP Average (dBm)	EIRP Average (dBm)	ERP Limit (dBm)	Margin (dB)	
5	23755	706.5	QPSK	1	0	23.08	16.13	18.28	34.77	-18.64	
				1	24	23.31	16.36	18.51	34.77	-18.41	
				12	6	22.37	15.42	17.57	34.77	-19.35	
				25	0	22.38	15.43	17.58	34.77	-19.34	
	23790	710	QPSK	1	0	23.17	16.22	18.37	34.77	-18.55	
				1	24	23.21	16.26	18.41	34.77	-18.51	
				12	6	22.34	15.39	17.54	34.77	-19.38	
				25	0	22.28	15.33	17.48	34.77	-19.44	
	23825	713.5	QPSK	1	0	23.34	16.39	18.54	34.77	-18.38	
				1	24	23.31	16.36	18.51	34.77	-18.41	
				12	6	22.30	15.35	17.50	34.77	-19.42	
				25	0	22.27	15.32	17.47	34.77	-19.45	
	23755	706.5	16QAM	1	0	22.44	15.49	17.64	34.77	-19.28	
				1	24	22.39	15.44	17.59	34.77	-19.33	
				12	6	21.36	14.41	16.56	34.77	-20.36	
				25	0	21.44	14.49	16.64	34.77	-20.28	
	23790	710	16QAM	1	0	22.34	15.39	17.54	34.77	-19.38	
				1	24	22.58	15.63	17.78	34.77	-19.14	
				12	6	21.31	14.36	16.51	34.77	-20.41	
				25	0	21.29	14.34	16.49	34.77	-20.43	
	23825	713.5	16QAM	1	0	22.66	15.71	17.86	34.77	-19.06	
				1	24	22.98	16.03	18.18	34.77	-18.74	
				12	6	21.41	14.46	16.61	34.77	-20.31	
				25	0	21.37	14.42	16.57	34.77	-20.35	
	23755	706.5	64QAM	1	0	21.28	14.33	16.48	34.77	-20.44	
				1	24	21.11	14.16	16.31	34.77	-20.61	
				12	6	20.11	13.16	15.31	34.77	-21.61	
				25	0	20.12	13.17	15.32	34.77	-21.60	
	23790	710	64QAM	1	0	21.24	14.29	16.44	34.77	-20.48	
				1	24	21.23	14.28	16.43	34.77	-20.49	
				12	6	20.23	13.28	15.43	34.77	-21.49	
				25	0	20.14	13.19	15.34	34.77	-21.58	
23825	713.5	64QAM	1	0	21.27	14.32	16.47	34.77	-20.45		
			1	24	20.96	14.01	16.16	34.77	-20.76		
			12	6	20.16	13.21	15.36	34.77	-21.56		
			25	0	20.07	13.12	15.27	34.77	-21.65		

Unless otherwise stated the results shown in this test report refer only to the sample(s) tested and such sample(s) are retained for 90 days only.

除非另有說明，此報告結果僅對測試之樣品負責，同時此樣品僅保留90天。本報告未經本公司書面許可，不可部份複製。

This document is issued by the Company subject to its General Conditions of Service printed overleaf, available on request or accessible at <http://www.sgs.com.tw/Terms-and-Conditions> and for electronic format documents, subject to Terms and Conditions for Electronic Documents at <http://www.sgs.com.tw/Terms-and-Conditions>. Attention is drawn to the limitation of liability, indemnification and jurisdiction issues defined therein. Any holder of this document is advised that information contained hereon reflects the Company's findings at the time of its intervention only and within the limits of Client's instructions, if any. The Company's sole responsibility is to its Client and this document does not exonerate parties to a transaction from exercising all their rights and obligations under the transaction documents. This document cannot be reproduced except in full, without prior written approval of the Company. Any unauthorized alteration, forgery or falsification of the content or appearance of this document is unlawful and offenders may be prosecuted to the fullest extent of the law.

Antenna gain (dBi)		-4.8								
LTE Band 17_Uplink frequency band : 704 to 716 MHz										
BW (MHz)	UL Channel	Frequency (MHz)	Modulation	RB Size	RB Offset	Conducted Average (dBm)	ERP Average (dBm)	EIRP Average (dBm)	ERP Limit (dBm)	Margin (dB)
10	23780	709	QPSK	1	0	23.21	16.26	18.41	34.77	-18.51
				1	49	23.27	16.32	18.47	34.77	-18.45
				25	12	22.38	15.43	17.58	34.77	-19.34
				50	0	22.32	15.37	17.52	34.77	-19.40
	23790	710	QPSK	1	0	23.24	16.29	18.44	34.77	-18.48
				1	49	23.49	16.54	18.69	34.77	-18.23
				25	12	22.26	15.31	17.46	34.77	-19.46
				50	0	22.27	15.32	17.47	34.77	-19.45
	23800	711	QPSK	1	0	23.34	16.39	18.54	34.77	-18.38
				1	49	23.12	16.17	18.32	34.77	-18.60
				25	12	22.29	15.34	17.49	34.77	-19.43
				50	0	22.20	15.25	17.40	34.77	-19.52
	23780	709	16QAM	1	0	22.26	15.31	17.46	34.77	-19.46
				1	49	22.51	15.56	17.71	34.77	-19.21
				25	12	21.43	14.48	16.63	34.77	-20.29
				50	0	21.34	14.39	16.54	34.77	-20.38
	23790	710	16QAM	1	0	22.26	15.31	17.46	34.77	-19.46
				1	49	22.48	15.53	17.68	34.77	-19.24
				25	12	21.37	14.42	16.57	34.77	-20.35
				50	0	21.38	14.43	16.58	34.77	-20.34
	23800	711	16QAM	1	0	22.19	15.24	17.39	34.77	-19.53
				1	49	22.52	15.57	17.72	34.77	-19.20
				25	12	21.37	14.42	16.57	34.77	-20.35
				50	0	21.16	14.21	16.36	34.77	-20.56
	23780	709	64QAM	1	0	21.33	14.38	16.53	34.77	-20.39
				1	49	21.24	14.29	16.44	34.77	-20.48
				25	12	20.23	13.28	15.43	34.77	-21.49
				50	0	20.19	13.24	15.39	34.77	-21.53
	23790	710	64QAM	1	0	21.26	14.31	16.46	34.77	-20.46
				1	49	21.28	14.33	16.48	34.77	-20.44
				25	12	20.24	13.29	15.44	34.77	-21.48
				50	0	20.16	13.21	15.36	34.77	-21.56
	23800	711	64QAM	1	0	21.36	14.41	16.56	34.77	-20.36
				1	49	21.07	14.12	16.27	34.77	-20.65
				25	12	20.25	13.30	15.45	34.77	-21.47
				50	0	20.10	13.15	15.30	34.77	-21.62

Unless otherwise stated the results shown in this test report refer only to the sample(s) tested and such sample(s) are retained for 90 days only.

除非另有說明，此報告結果僅對測試之樣品負責，同時此樣品僅保留90天。本報告未經本公司書面許可，不可部份複製。

This document is issued by the Company subject to its General Conditions of Service printed overleaf, available on request or accessible at <http://www.sgs.com.tw/Terms-and-Conditions> and for electronic format documents, subject to Terms and Conditions for Electronic Documents at <http://www.sgs.com.tw/Terms-and-Conditions>. Attention is drawn to the limitation of liability, indemnification and jurisdiction issues defined therein. Any holder of this document is advised that information contained hereon reflects the Company's findings at the time of its intervention only and within the limits of Client's instructions, if any. The Company's sole responsibility is to its Client and this document does not exonerate parties to a transaction from exercising all their rights and obligations under the transaction documents. This document cannot be reproduced except in full, without prior written approval of the Company. Any unauthorized alteration, forgery or falsification of the content or appearance of this document is unlawful and offenders may be prosecuted to the fullest extent of the law.

Antenna gain (dBi) -3.9									
LTE Band 38_Uplink frequency band : 2570 to 2620 MHz									
BW (MHz)	UL Channel	Frequency (MHz)	Modulation	RB Size	RB Offset	Conducted Average (dBm)	EIRP Average (dBm)	EIRP Limit (dBm)	Margin (dB)
5	37775	2572.5	QPSK	1	0	22.57	18.67	33	-14.33
				1	24	22.61	18.71	33	-14.29
				12	6	21.79	17.89	33	-15.11
				25	0	21.82	17.92	33	-15.08
	38000	2595	QPSK	1	0	22.68	18.78	33	-14.22
				1	24	22.52	18.62	33	-14.38
				12	6	21.80	17.90	33	-15.1
				25	0	21.83	17.93	33	-15.07
	38225	2617.5	QPSK	1	0	22.69	18.79	33	-14.21
				1	24	22.64	18.74	33	-14.26
				12	6	21.85	17.95	33	-15.05
				25	0	21.67	17.77	33	-15.23
	37775	2572.5	16QAM	1	0	21.86	17.96	33	-15.04
				1	24	21.78	17.88	33	-15.12
				12	6	20.86	16.96	33	-16.04
				25	0	20.90	17.00	33	-16
	38000	2595	16QAM	1	0	21.73	17.83	33	-15.17
				1	24	21.83	17.93	33	-15.07
				12	6	20.84	16.94	33	-16.06
				25	0	20.88	16.98	33	-16.02
	38225	2617.5	16QAM	1	0	21.83	17.93	33	-15.07
				1	24	21.67	17.77	33	-15.23
				12	6	20.76	16.86	33	-16.14
				25	0	20.80	16.90	33	-16.1
	37775	2572.5	64QAM	1	0	21.08	17.18	33	-15.82
				1	24	20.99	17.09	33	-15.91
				12	6	20.00	16.10	33	-16.9
				25	0	19.90	16.00	33	-17
	38000	2595	64QAM	1	0	21.04	17.14	33	-15.86
				1	24	21.09	17.19	33	-15.81
				12	6	20.00	16.10	33	-16.9
				25	0	20.05	16.15	33	-16.85
38225	2617.5	64QAM	1	0	21.01	17.11	33	-15.89	
			1	24	21.03	17.13	33	-15.87	
			12	6	19.89	15.99	33	-17.01	
			25	0	19.88	15.98	33	-17.02	

Unless otherwise stated the results shown in this test report refer only to the sample(s) tested and such sample(s) are retained for 90 days only.

除非另有說明，此報告結果僅對測試之樣品負責，同時此樣品僅保留90天。本報告未經本公司書面許可，不可部份複製。

This document is issued by the Company subject to its General Conditions of Service printed overleaf, available on request or accessible at <http://www.sgs.com.tw/Terms-and-Conditions> and for electronic format documents, subject to Terms and Conditions for Electronic Documents at <http://www.sgs.com.tw/Terms-and-Conditions>. Attention is drawn to the limitation of liability, indemnification and jurisdiction issues defined therein. Any holder of this document is advised that information contained hereon reflects the Company's findings at the time of its intervention only and within the limits of Client's instructions, if any. The Company's sole responsibility is to its Client and this document does not exonerate parties to a transaction from exercising all their rights and obligations under the transaction documents. This document cannot be reproduced except in full, without prior written approval of the Company. Any unauthorized alteration, forgery or falsification of the content or appearance of this document is unlawful and offenders may be prosecuted to the fullest extent of the law.

Antenna gain (dBi)		-3.9							
LTE Band 38_Uplink frequency band : 2570 to 2620 MHz									
BW (MHz)	UL Channel	Frequency (MHz)	Modulation	RB Size	RB Offset	Conducted Average (dBm)	EIRP Average (dBm)	EIRP Limit (dBm)	Margin (dB)
10	37800	2575	QPSK	1	0	22.93	19.03	33	-13.97
				1	49	22.97	19.07	33	-13.93
				25	12	22.07	18.17	33	-14.83
				50	0	22.09	18.19	33	-14.81
	38000	2595	QPSK	1	0	22.87	18.97	33	-14.03
				1	49	22.80	18.90	33	-14.1
				25	12	22.09	18.19	33	-14.81
				50	0	22.13	18.23	33	-14.77
	38200	2615	QPSK	1	0	22.85	18.95	33	-14.05
				1	49	22.83	18.93	33	-14.07
				25	12	21.93	18.03	33	-14.97
				50	0	21.97	18.07	33	-14.93
	37800	2575	16QAM	1	0	22.09	18.19	33	-14.81
				1	49	22.02	18.12	33	-14.88
				25	12	21.08	17.18	33	-15.82
				50	0	21.18	17.28	33	-15.72
	38000	2595	16QAM	1	0	22.07	18.17	33	-14.83
				1	49	21.98	18.08	33	-14.92
				25	12	21.04	17.14	33	-15.86
				50	0	21.11	17.21	33	-15.79
	38200	2615	16QAM	1	0	21.88	17.98	33	-15.02
				1	49	21.90	18.00	33	-15
				25	12	20.87	16.97	33	-16.03
				50	0	20.97	17.07	33	-15.93
	37800	2575	64QAM	1	0	21.01	17.11	33	-15.89
				1	49	21.06	17.16	33	-15.84
				25	12	20.07	16.17	33	-16.83
				50	0	19.96	16.06	33	-16.94
	38000	2595	64QAM	1	0	21.10	17.20	33	-15.8
				1	49	21.11	17.21	33	-15.79
				25	12	20.00	16.10	33	-16.9
				50	0	20.00	16.10	33	-16.9
38200	2615	64QAM	1	0	21.07	17.17	33	-15.83	
			1	49	21.06	17.16	33	-15.84	
			25	12	19.88	15.98	33	-17.02	
			50	0	19.92	16.02	33	-16.98	

Unless otherwise stated the results shown in this test report refer only to the sample(s) tested and such sample(s) are retained for 90 days only.

除非另有說明，此報告結果僅對測試之樣品負責，同時此樣品僅保留90天。本報告未經本公司書面許可，不可部份複製。

This document is issued by the Company subject to its General Conditions of Service printed overleaf, available on request or accessible at <http://www.sgs.com.tw/Terms-and-Conditions> and for electronic format documents, subject to Terms and Conditions for Electronic Documents at <http://www.sgs.com.tw/Terms-and-Conditions>. Attention is drawn to the limitation of liability, indemnification and jurisdiction issues defined therein. Any holder of this document is advised that information contained hereon reflects the Company's findings at the time of its intervention only and within the limits of Client's instructions, if any. The Company's sole responsibility is to its Client and this document does not exonerate parties to a transaction from exercising all their rights and obligations under the transaction documents. This document cannot be reproduced except in full, without prior written approval of the Company. Any unauthorized alteration, forgery or falsification of the content or appearance of this document is unlawful and offenders may be prosecuted to the fullest extent of the law.

Antenna gain (dBi)		-3.9							
LTE Band 38_Uplink frequency band : 2570 to 2620 MHz									
BW (MHz)	UL Channel	Frequency (MHz)	Modulation	RB Size	RB Offset	Conducted Average (dBm)	EIRP Average (dBm)	EIRP Limit (dBm)	Margin (dB)
15	37825	2577.5	QPSK	1	0	23.00	19.10	33	-13.9
				1	74	23.05	19.15	33	-13.85
				36	19	22.21	18.31	33	-14.69
				75	0	22.27	18.37	33	-14.63
	38000	2595	QPSK	1	0	23.15	19.25	33	-13.75
				1	74	22.96	19.06	33	-13.94
				36	19	22.17	18.27	33	-14.73
	38175	2612.5	QPSK	75	0	22.23	18.33	33	-14.67
				1	0	23.04	19.14	33	-13.86
				1	74	22.98	19.08	33	-13.92
	37825	2577.5	16QAM	36	19	22.08	18.18	33	-14.82
				75	0	22.16	18.26	33	-14.74
				1	0	22.30	18.40	33	-14.6
				1	74	22.30	18.40	33	-14.6
	38000	2595	16QAM	36	19	21.30	17.40	33	-15.6
				75	0	21.27	17.37	33	-15.63
				1	0	22.30	18.40	33	-14.6
				1	74	22.20	18.30	33	-14.7
	38175	2612.5	16QAM	36	19	21.27	17.37	33	-15.63
				75	0	21.25	17.35	33	-15.65
				1	0	22.19	18.29	33	-14.71
				1	74	22.13	18.23	33	-14.77
	37825	2577.5	64QAM	36	19	21.20	17.30	33	-15.7
				75	0	21.26	17.36	33	-15.64
				1	0	20.99	17.09	33	-15.91
				1	74	20.99	17.09	33	-15.91
	38000	2595	64QAM	36	19	19.96	16.06	33	-16.94
				75	0	19.90	16.00	33	-17
				1	0	21.16	17.26	33	-15.74
				1	74	21.07	17.17	33	-15.83
	38175	2612.5	64QAM	36	19	19.96	16.06	33	-16.94
				75	0	19.95	16.05	33	-16.95
1				0	21.02	17.12	33	-15.88	
1				74	21.00	17.10	33	-15.9	
37825	2577.5	64QAM	36	19	19.85	15.95	33	-17.05	
			75	0	20.03	16.13	33	-16.87	

Unless otherwise stated the results shown in this test report refer only to the sample(s) tested and such sample(s) are retained for 90 days only.
 除非另有說明，此報告結果僅對測試之樣品負責，同時此樣品僅保留90天。本報告未經本公司書面許可，不可部份複製。
 This document is issued by the Company subject to its General Conditions of Service printed overleaf, available on request or accessible at <http://www.sgs.com.tw/Terms-and-Conditions> and for electronic format documents, subject to Terms and Conditions for Electronic Documents at <http://www.sgs.com.tw/Terms-and-Conditions>. Attention is drawn to the limitation of liability, indemnification and jurisdiction issues defined therein. Any holder of this document is advised that information contained hereon reflects the Company's findings at the time of its intervention only and within the limits of Client's instructions, if any. The Company's sole responsibility is to its Client and this document does not exonerate parties to a transaction from exercising all their rights and obligations under the transaction documents. This document cannot be reproduced except in full, without prior written approval of the Company. Any unauthorized alteration, forgery or falsification of the content or appearance of this document is unlawful and offenders may be prosecuted to the fullest extent of the law.

Antenna gain (dBi)		-3.9							
LTE Band 38_Uplink frequency band : 2570 to 2620 MHz									
BW (MHz)	UL Channel	Frequency (MHz)	Modulation	RB Size	RB Offset	Conducted Average (dBm)	EIRP Average (dBm)	EIRP Limit (dBm)	Margin (dB)
20	37850	2580	QPSK	1	0	23.27	19.37	33	-13.63
				1	99	23.34	19.44	33	-13.56
				50	25	22.27	18.37	33	-14.63
				100	0	22.25	18.35	33	-14.65
	38000	2595	QPSK	1	0	23.28	19.38	33	-13.62
				1	99	23.19	19.29	33	-13.71
				50	25	22.23	18.33	33	-14.67
	38150	2610	QPSK	100	0	22.23	18.33	33	-14.67
				1	0	23.14	19.24	33	-13.76
				1	99	23.20	19.30	33	-13.7
	37850	2580	16QAM	50	25	22.16	18.26	33	-14.74
				100	0	22.17	18.27	33	-14.73
				1	0	22.08	18.18	33	-14.82
				1	99	22.63	18.73	33	-14.27
	38000	2595	16QAM	50	25	21.21	17.31	33	-15.69
				100	0	21.26	17.36	33	-15.64
				1	0	22.56	18.66	33	-14.34
				1	99	22.14	18.24	33	-14.76
	38150	2610	16QAM	50	25	21.19	17.29	33	-15.71
				100	0	21.24	17.34	33	-15.66
				1	0	22.45	18.55	33	-14.45
				1	99	22.43	18.53	33	-14.47
	37850	2580	64QAM	50	25	21.13	17.23	33	-15.77
				100	0	21.18	17.28	33	-15.72
				1	0	21.13	17.23	33	-15.77
				1	99	21.07	17.17	33	-15.83
	38000	2595	64QAM	50	25	20.11	16.21	33	-16.79
				100	0	20.05	16.15	33	-16.85
1				0	21.16	17.26	33	-15.74	
1				99	21.13	17.23	33	-15.77	
38150	2610	64QAM	50	25	20.07	16.17	33	-16.83	
			100	0	20.07	16.17	33	-16.83	
			1	0	21.12	17.22	33	-15.78	
			1	99	21.09	17.19	33	-15.81	
37850	2580	64QAM	50	25	19.98	16.08	33	-16.92	
			100	0	20.03	16.13	33	-16.87	

Unless otherwise stated the results shown in this test report refer only to the sample(s) tested and such sample(s) are retained for 90 days only.
 除非另有說明，此報告結果僅對測試之樣品負責，同時此樣品僅保留90天。本報告未經本公司書面許可，不可部份複製。
 This document is issued by the Company subject to its General Conditions of Service printed overleaf, available on request or accessible at <http://www.sgs.com.tw/Terms-and-Conditions> and for electronic format documents, subject to Terms and Conditions for Electronic Documents at <http://www.sgs.com.tw/Terms-and-Conditions>. Attention is drawn to the limitation of liability, indemnification and jurisdiction issues defined therein. Any holder of this document is advised that information contained hereon reflects the Company's findings at the time of its intervention only and within the limits of Client's instructions, if any. The Company's sole responsibility is to its Client and this document does not exonerate parties to a transaction from exercising all their rights and obligations under the transaction documents. This document cannot be reproduced except in full, without prior written approval of the Company. Any unauthorized alteration, forgery or falsification of the content or appearance of this document is unlawful and offenders may be prosecuted to the fullest extent of the law.

LTE Band 41_Uplink frequency band : 2496 to 2690 MHz									
BW (MHz)	UL Channel	Frequency (MHz)	Modulation	RB Size	RB Offset	Conducted Average (dBm)	EIRP Average (dBm)	EIRP Limit (dBm)	Margin (dB)
5	39675	2498.5	QPSK	1	0	22.12	18.22	33	-14.78
				1	24	22.11	18.21	33	-14.79
				12	6	21.21	17.31	33	-15.69
				25	0	21.19	17.29	33	-15.71
	40620	2593	QPSK	1	0	23.61	19.71	33	-13.29
				1	24	23.58	19.68	33	-13.32
				12	6	22.72	18.82	33	-14.18
				25	0	22.72	18.82	33	-14.18
	41565	2687.5	QPSK	1	0	22.16	18.26	33	-14.74
				1	24	22.03	18.13	33	-14.87
				12	6	21.16	17.26	33	-15.74
				25	0	21.17	17.27	33	-15.73
	39675	2498.5	16QAM	1	0	21.55	17.65	33	-15.35
				1	24	21.51	17.61	33	-15.39
				12	6	20.17	16.27	33	-16.73
				25	0	20.23	16.33	33	-16.67
	40620	2593	16QAM	1	0	23.02	19.12	33	-13.88
				1	24	23.10	19.20	33	-13.8
				12	6	21.72	17.82	33	-15.18
				25	0	21.69	17.79	33	-15.21
	41565	2687.5	16QAM	1	0	21.42	17.52	33	-15.48
				1	24	21.47	17.57	33	-15.43
				12	6	20.17	16.27	33	-16.73
				25	0	20.13	16.23	33	-16.77
	39675	2498.5	64QAM	1	0	19.34	15.44	33	-17.56
				1	24	20.33	16.43	33	-16.57
				12	6	19.31	15.41	33	-17.59
				25	0	19.34	15.44	33	-17.56
	40620	2593	64QAM	1	0	22.01	18.11	33	-14.89
				1	24	21.91	18.01	33	-14.99
				12	6	20.91	17.01	33	-15.99
				25	0	20.90	17.00	33	-16
41565	2687.5	64QAM	1	0	20.34	16.44	33	-16.56	
			1	24	20.45	16.55	33	-16.45	
			12	6	19.15	15.25	33	-17.75	
			25	0	19.30	15.40	33	-17.6	

Unless otherwise stated the results shown in this test report refer only to the sample(s) tested and such sample(s) are retained for 90 days only.

除非另有說明，此報告結果僅對測試之樣品負責，同時此樣品僅保留90天。本報告未經本公司書面許可，不可部份複製。

This document is issued by the Company subject to its General Conditions of Service printed overleaf, available on request or accessible at <http://www.sgs.com.tw/Terms-and-Conditions> and for electronic format documents, subject to Terms and Conditions for Electronic Documents at <http://www.sgs.com.tw/Terms-and-Conditions>. Attention is drawn to the limitation of liability, indemnification and jurisdiction issues defined therein. Any holder of this document is advised that information contained hereon reflects the Company's findings at the time of its intervention only and within the limits of Client's instructions, if any. The Company's sole responsibility is to its Client and this document does not exonerate parties to a transaction from exercising all their rights and obligations under the transaction documents. This document cannot be reproduced except in full, without prior written approval of the Company. Any unauthorized alteration, forgery or falsification of the content or appearance of this document is unlawful and offenders may be prosecuted to the fullest extent of the law.

Antenna gain (dBi)		-3.9							
LTE Band 41_Uplink frequency band : 2496 to 2690 MHz									
BW (MHz)	UL Channel	Frequency (MHz)	Modulation	RB Size	RB Offset	Conducted Average (dBm)	EIRP Average (dBm)	EIRP Limit (dBm)	Margin (dB)
10	39700	2501	QPSK	1	0	22.13	18.23	33	-14.77
				1	49	22.10	18.20	33	-14.8
				25	12	21.17	17.27	33	-15.73
				50	0	21.22	17.32	33	-15.68
	40620	2593	QPSK	1	0	23.55	19.65	33	-13.35
				1	49	23.41	19.51	33	-13.49
				25	12	22.86	18.96	33	-14.04
				50	0	22.72	18.82	33	-14.18
	41540	2685	QPSK	1	0	21.96	18.06	33	-14.94
				1	49	22.08	18.18	33	-14.82
				25	12	21.17	17.27	33	-15.73
				50	0	21.11	17.21	33	-15.79
	39700	2501	16QAM	1	0	21.27	17.37	33	-15.63
				1	49	21.23	17.33	33	-15.67
				25	12	20.37	16.47	33	-16.53
				50	0	20.33	16.43	33	-16.57
	40620	2593	16QAM	1	0	22.73	18.83	33	-14.17
				1	49	22.69	18.79	33	-14.21
				25	12	21.82	17.92	33	-15.08
				50	0	21.79	17.89	33	-15.11
	41540	2685	16QAM	1	0	21.24	17.34	33	-15.66
				1	49	21.08	17.18	33	-15.82
				25	12	20.21	16.31	33	-16.69
				50	0	20.05	16.15	33	-16.85
	39700	2501	64QAM	1	0	20.49	16.59	33	-16.41
				1	49	20.34	16.44	33	-16.56
				25	12	19.31	15.41	33	-17.59
				50	0	19.25	15.35	33	-17.65
	40620	2593	64QAM	1	0	21.90	18.00	33	-15
				1	49	21.92	18.02	33	-14.98
				25	12	21.02	17.12	33	-15.88
				50	0	20.89	16.99	33	-16.01
41540	2685	64QAM	1	0	20.32	16.42	33	-16.58	
			1	49	20.33	16.43	33	-16.57	
			25	12	19.20	15.30	33	-17.7	
			50	0	19.21	15.31	33	-17.69	

Unless otherwise stated the results shown in this test report refer only to the sample(s) tested and such sample(s) are retained for 90 days only.

除非另有說明，此報告結果僅對測試之樣品負責，同時此樣品僅保留90天。本報告未經本公司書面許可，不可部份複製。

This document is issued by the Company subject to its General Conditions of Service printed overleaf, available on request or accessible at <http://www.sgs.com.tw/Terms-and-Conditions> and for electronic format documents, subject to Terms and Conditions for Electronic Documents at <http://www.sgs.com.tw/Terms-and-Conditions>. Attention is drawn to the limitation of liability, indemnification and jurisdiction issues defined therein. Any holder of this document is advised that information contained hereon reflects the Company's findings at the time of its intervention only and within the limits of Client's instructions, if any. The Company's sole responsibility is to its Client and this document does not exonerate parties to a transaction from exercising all their rights and obligations under the transaction documents. This document cannot be reproduced except in full, without prior written approval of the Company. Any unauthorized alteration, forgery or falsification of the content or appearance of this document is unlawful and offenders may be prosecuted to the fullest extent of the law.

Antenna gain (dBi)		-3.9							
LTE Band 41_Uplink frequency band : 2496 to 2690 MHz									
BW (MHz)	UL Channel	Frequency (MHz)	Modulation	RB Size	RB Offset	Conducted Average (dBm)	EIRP Average (dBm)	EIRP Limit (dBm)	Margin (dB)
15	39725	2503.5	QPSK	1	0	21.98	18.08	33	-14.92
				1	74	21.96	18.06	33	-14.94
				36	18	21.17	17.27	33	-15.73
				75	0	21.22	17.32	33	-15.68
	40620	2593	QPSK	1	0	23.60	19.70	33	-13.3
				1	74	23.67	19.77	33	-13.23
				36	18	22.64	18.74	33	-14.26
				75	0	22.67	18.77	33	-14.23
	41515	2682.5	QPSK	1	0	21.94	18.04	33	-14.96
				1	74	22.09	18.19	33	-14.81
				36	18	21.11	17.21	33	-15.79
				75	0	21.13	17.23	33	-15.77
	39725	2503.5	16QAM	1	0	21.17	17.27	33	-15.73
				1	74	21.12	17.22	33	-15.78
				36	18	20.11	16.21	33	-16.79
				75	0	20.20	16.30	33	-16.7
	40620	2593	16QAM	1	0	22.67	18.77	33	-14.23
				1	74	22.72	18.82	33	-14.18
				36	18	21.74	17.84	33	-15.16
				75	0	21.81	17.91	33	-15.09
	41515	2682.5	16QAM	1	0	21.12	17.22	33	-15.78
				1	74	21.11	17.21	33	-15.79
				36	18	20.10	16.20	33	-16.8
				75	0	20.17	16.27	33	-16.73
	39725	2503.5	64QAM	1	0	20.44	16.54	33	-16.46
				1	74	20.31	16.41	33	-16.59
				36	18	19.32	15.42	33	-17.58
				75	0	19.29	15.39	33	-17.61
	40620	2593	64QAM	1	0	21.98	18.08	33	-14.92
				1	74	22.03	18.13	33	-14.87
				36	18	20.95	17.05	33	-15.95
				75	0	20.83	16.93	33	-16.07
41515	2682.5	64QAM	1	0	20.31	16.41	33	-16.59	
			1	74	20.42	16.52	33	-16.48	
			36	18	19.15	15.25	33	-17.75	
			75	0	19.34	15.44	33	-17.56	

Unless otherwise stated the results shown in this test report refer only to the sample(s) tested and such sample(s) are retained for 90 days only.

除非另有說明，此報告結果僅對測試之樣品負責，同時此樣品僅保留90天。本報告未經本公司書面許可，不可部份複製。

This document is issued by the Company subject to its General Conditions of Service printed overleaf, available on request or accessible at <http://www.sgs.com.tw/Terms-and-Conditions> and for electronic format documents, subject to Terms and Conditions for Electronic Documents at <http://www.sgs.com.tw/Terms-and-Conditions>. Attention is drawn to the limitation of liability, indemnification and jurisdiction issues defined therein. Any holder of this document is advised that information contained hereon reflects the Company's findings at the time of its intervention only and within the limits of Client's instructions, if any. The Company's sole responsibility is to its Client and this document does not exonerate parties to a transaction from exercising all their rights and obligations under the transaction documents. This document cannot be reproduced except in full, without prior written approval of the Company. Any unauthorized alteration, forgery or falsification of the content or appearance of this document is unlawful and offenders may be prosecuted to the fullest extent of the law.

Antenna gain (dBi)		-3.9							
LTE Band 41_Uplink frequency band : 2496 to 2690 MHz									
BW (MHz)	UL Channel	Frequency (MHz)	Modulation	RB Size	RB Offset	Conducted Average (dBm)	EIRP Average (dBm)	EIRP Limit (dBm)	Margin (dB)
20	39750	2506	QPSK	1	0	22.18	18.28	33	-14.72
				1	99	22.22	18.32	33	-14.68
				50	25	21.43	17.53	33	-15.47
				100	0	21.39	17.49	33	-15.51
	40620	2593	QPSK	1	0	23.79	19.89	33	-13.11
				1	99	23.78	19.88	33	-13.12
				50	25	22.98	19.08	33	-13.92
				100	0	23.00	19.10	33	-13.9
	41490	2680	QPSK	1	0	22.22	18.32	33	-14.68
				1	99	22.23	18.33	33	-14.67
				50	25	21.31	17.41	33	-15.59
				100	0	21.31	17.41	33	-15.59
	39750	2506	16QAM	1	0	21.40	17.50	33	-15.5
				1	99	21.37	17.47	33	-15.53
				50	25	20.40	16.50	33	-16.5
				100	0	20.47	16.57	33	-16.43
	40620	2593	16QAM	1	0	23.05	19.15	33	-13.85
				1	99	22.91	19.01	33	-13.99
				50	25	22.03	18.13	33	-14.87
				100	0	22.04	18.14	33	-14.86
	41490	2680	16QAM	1	0	21.42	17.52	33	-15.48
				1	99	21.35	17.45	33	-15.55
				50	25	20.26	16.36	33	-16.64
				100	0	20.35	16.45	33	-16.55
	39750	2506	64QAM	1	0	20.43	16.53	33	-16.47
				1	99	20.37	16.47	33	-16.53
				50	25	19.26	15.36	33	-17.64
				100	0	19.32	15.42	33	-17.58
	40620	2593	64QAM	1	0	21.96	18.06	33	-14.94
				1	99	21.95	18.05	33	-14.95
				50	25	20.95	17.05	33	-15.95
				100	0	20.85	16.95	33	-16.05
41490	2680	64QAM	1	0	20.38	16.48	33	-16.52	
			1	99	20.39	16.49	33	-16.51	
			50	25	19.17	15.27	33	-17.73	
			100	0	19.26	15.36	33	-17.64	

Unless otherwise stated the results shown in this test report refer only to the sample(s) tested and such sample(s) are retained for 90 days only.

除非另有說明，此報告結果僅對測試之樣品負責，同時此樣品僅保留90天。本報告未經本公司書面許可，不可部份複製。

This document is issued by the Company subject to its General Conditions of Service printed overleaf, available on request or accessible at <http://www.sgs.com.tw/Terms-and-Conditions> and for electronic format documents, subject to Terms and Conditions for Electronic Documents at <http://www.sgs.com.tw/Terms-and-Conditions>. Attention is drawn to the limitation of liability, indemnification and jurisdiction issues defined therein. Any holder of this document is advised that information contained hereon reflects the Company's findings at the time of its intervention only and within the limits of Client's instructions, if any. The Company's sole responsibility is to its Client and this document does not exonerate parties to a transaction from exercising all their rights and obligations under the transaction documents. This document cannot be reproduced except in full, without prior written approval of the Company. Any unauthorized alteration, forgery or falsification of the content or appearance of this document is unlawful and offenders may be prosecuted to the fullest extent of the law.

7 OCCUPIED BANDWIDTH MEASUREMENT

7.1 Standard Applicable

The occupied bandwidth is the frequency bandwidth such that, below its lower and above its upper frequency limits, the mean powers radiated are each equal to 0.5 percent of the total mean power.

7.2 Test Set-up

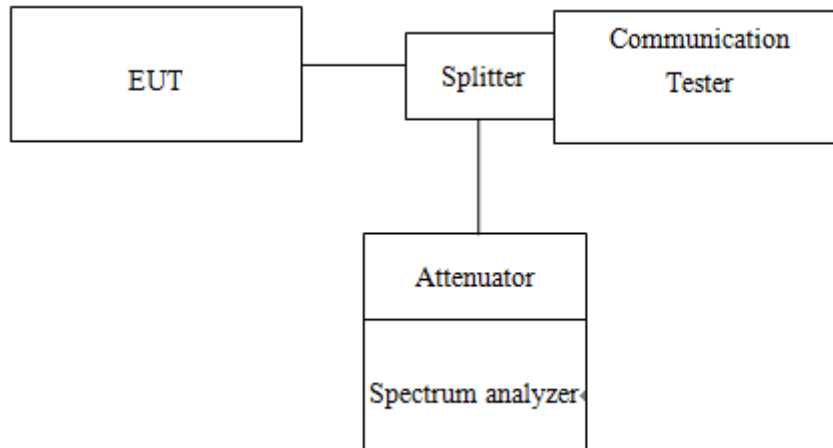

7.3 Measurement Procedure

99% &26dB Bandwidth with detector peak

The EUT's output RF connector was connected with a short cable to the spectrum analyzer, RBW was set to about 1% of emission BW, VBW= 3 times RBW, -26dBc display line was placed on the screen (or 26dB bandwidth), the occupied bandwidth is the delta frequency between the two points where the display line intersects the signal trace. Then set RBW to 99% bandwidth, RBW= 1%, VBW= 3 * RBW, with span > 2 * Signal BW, set % Power = 99%.

7.4 Measurement Equipment Used

Conducted Emission (measured at antenna port) Test Site					
EQUIPMENT TYPE	MFR	MODEL NUMBER	SERIAL NUMBER	LAST CAL.	CAL DUE.
PXA Spectrum Analyzer	Agilent	N9030A	MY53120760	04/21/2020	04/20/2021
DC Power Supply	Agilent	E3640A	MY40000811	12/23/2019	12/22/2020
Radio Communication Analyzer	Anritsu	MT8815B	6200711454	04/01/2020	03/31/2021
Radio Communication Analyzer	Anritsu	MT8821C	6261786084	01/18/2020	01/17/2021
Attenuator	Mini-Circuit	BW-S10W2+	2	01/02/2020	01/01/2021
DC Block	Mini-Circuits	BLK-18-S+	1	01/02/2020	01/01/2021
Splitter	RF-LAMBAD	RFLT2W1G18G	11-JSPF412-018	01/02/2020	01/01/2021

Unless otherwise stated the results shown in this test report refer only to the sample(s) tested and such sample(s) are retained for 90 days only.

除非另有說明，此報告結果僅對測試之樣品負責，同時此樣品僅保留90天。本報告未經本公司書面許可，不可部份複製。

This document is issued by the Company subject to its General Conditions of Service printed overleaf, available on request or accessible at <http://www.sgs.com.tw/Terms-and-Conditions> and for electronic format documents, subject to Terms and Conditions for Electronic Documents at <http://www.sgs.com.tw/Terms-and-Conditions>. Attention is drawn to the limitation of liability, indemnification and jurisdiction issues defined therein. Any holder of this document is advised that information contained hereon reflects the Company's findings at the time of its intervention only and within the limits of Client's instructions, if any. The Company's sole responsibility is to its Client and this document does not exonerate parties to a transaction from exercising all their rights and obligations under the transaction documents. This document cannot be reproduced except in full, without prior written approval of the Company. Any unauthorized alteration, forgery or falsification of the content or appearance of this document is unlawful and offenders may be prosecuted to the fullest extent of the law.

7.5 Measurement Result

Freq. (MHz)	CH	99% BW (MHz)		26 dB BW (MHz)	
		GSM 850	GPRS 850	GSM 850	GPRS 850
824.2	128	0.24260	0.24726	0.3142	0.3158
836.6	190	0.24446	0.24399	0.3171	0.3281
848.8	251	0.24574	0.24442	0.3166	0.3131
Freq. (MHz)	CH	99% BW (MHz)		26 dB BW (MHz)	
		GSM 1900	GPRS 1900	GSM 1900	GPRS 1900
1850.2	512	0.24423	0.24615	0.3141	0.3241
1880.0	661	0.24778	0.24570	0.3181	0.3190
1909.8	810	0.24122	0.24587	0.3152	0.3176

Freq. (MHz)	CH	99% BW (MHz)			26 dB BW (MHz)		
		WCDMA V	HSDPA V	HSUPA V	WCDMA V	HSDPA V	HSUPA V
826.40	4132	4.13970	4.13080	4.13870	4.703	4.672	4.705
836.60	4183	4.14540	4.14000	4.14450	4.707	4.683	4.683
846.60	4233	4.14470	4.11480	4.13290	4.713	4.694	4.680

LTE BAND 5 Channel bandwidth: 1.4MHz							
Freq. (MHz)	CH	99% BW (MHz)			26 dB BW (MHz)		
		QPSK	16QAM	64QAM	QPSK	16QAM	64QAM
824.7	20407	1.0948	1.0976	1.0966	1.238	1.237	1.239
836.5	20525	1.0945	1.0945	1.0943	1.238	1.239	1.235
848.3	20643	1.0950	1.0946	1.0942	1.235	1.234	1.238

LTE BAND 5 Channel bandwidth: 3MHz							
Freq. (MHz)	CH	99% BW (MHz)			26 dB BW (MHz)		
		QPSK	16QAM	64QAM	QPSK	16QAM	64QAM
825.5	20415	2.6962	2.6995	2.7017	2.998	3.003	2.990
836.5	20525	2.6961	2.7003	2.7008	2.979	3.009	2.985
847.5	20635	2.6989	2.6986	2.6962	2.986	3.003	2.982

LTE BAND 5 Channel bandwidth: 5MHz							
Freq. (MHz)	CH	99% BW (MHz)			26 dB BW (MHz)		
		QPSK	16QAM	64QAM	QPSK	16QAM	64QAM
826.5	20425	4.4999	4.4997	4.5061	4.983	4.996	4.997
836.5	20525	4.4952	4.4997	4.5072	4.985	5.013	4.997
846.5	20625	4.4938	4.4969	4.5037	4.992	4.975	4.972

LTE BAND 5 Channel bandwidth: 10MHz							
Freq. (MHz)	CH	99% BW (MHz)			26 dB BW (MHz)		
		QPSK	16QAM	64QAM	QPSK	16QAM	64QAM
829.0	20450	9.0027	8.9500	8.9910	9.801	9.802	9.825
836.5	20525	9.0025	8.9506	8.9828	9.836	9.792	9.823
844.0	20600	8.9900	8.9415	8.9642	9.814	9.763	9.836

LTE BAND 12 Channel bandwidth: 1.4MHz							
Freq. (MHz)	CH	99% BW (MHz)			26 dB BW (MHz)		
		QPSK	16QAM	64QAM	QPSK	16QAM	64QAM
699.7	23017	1.0937	1.0963	1.0961	1.233	1.232	1.234
707.5	23095	1.0945	1.0976	1.0962	1.238	1.239	1.235
715.3	23173	1.0958	1.0968	1.0954	1.239	1.243	1.231

LTE BAND 12 Channel bandwidth: 3MHz							
Freq. (MHz)	CH	99% BW (MHz)			26 dB BW (MHz)		
		QPSK	16QAM	64QAM	QPSK	16QAM	64QAM
700.5	23025	2.6908	2.6881	2.6948	2.992	2.996	2.981
707.5	23095	2.6956	2.6943	2.6989	2.978	3.012	2.985
714.5	23165	2.7030	2.7014	2.7140	2.994	3.001	2.884

LTE BAND 12 Channel bandwidth: 5MHz							
Freq. (MHz)	CH	99% BW (MHz)			26 dB BW (MHz)		
		QPSK	16QAM	64QAM	QPSK	16QAM	64QAM
701.5	23035	4.4964	4.4888	4.4978	4.955	4.956	4.963
707.5	23095	4.4959	4.4967	4.5082	4.953	4.961	4.980
713.5	23155	4.5089	4.5063	4.5194	4.964	4.981	4.977

LTE BAND 12 Channel bandwidth: 10MHz							
Freq. (MHz)	CH	99% BW (MHz)			26 dB BW (MHz)		
		QPSK	16QAM	64QAM	QPSK	16QAM	64QAM
704.0	23060	9.0487	8.9867	9.0174	9.880	9.807	9.866
707.5	23095	8.9924	8.9494	8.9693	9.794	9.764	9.800
711.0	23130	8.9625	8.9102	8.9237	9.736	9.753	9.773

Unless otherwise stated the results shown in this test report refer only to the sample(s) tested and such sample(s) are retained for 90 days only.

除非另有說明，此報告結果僅對測試之樣品負責，同時此樣品僅保留90天。本報告未經本公司書面許可，不可部份複製。

This document is issued by the Company subject to its General Conditions of Service printed overleaf, available on request or accessible at <http://www.sgs.com.tw/Terms-and-Conditions> and for electronic format documents, subject to Terms and Conditions for Electronic Documents at <http://www.sgs.com.tw/Terms-and-Conditions>. Attention is drawn to the limitation of liability, indemnification and jurisdiction issues defined therein. Any holder of this document is advised that information contained hereon reflects the Company's findings at the time of its intervention only and within the limits of Client's instructions, if any. The Company's sole responsibility is to its Client and this document does not exonerate parties to a transaction from exercising all their rights and obligations under the transaction documents. This document cannot be reproduced except in full, without prior written approval of the Company. Any unauthorized alteration, forgery or falsification of the content or appearance of this document is unlawful and offenders may be prosecuted to the fullest extent of the law.

LTE BAND 17 Channel bandwidth: 5MHz								LTE BAND 17 Channel bandwidth: 10MHz							
Freq. (MHz)	CH	99% BW (MHz)			26 dB BW (MHz)			Freq. (MHz)	CH	99% BW (MHz)			26 dB BW (MHz)		
		QPSK	16QAM	64QAM	QPSK	16QAM	64QAM			QPSK	16QAM	64QAM	QPSK	16QAM	64QAM
706.5	23755	4.4954	4.4970	4.5049	4.979	4.969	4.989	709.0	23780	8.9698	8.9167	8.9284	9.745	9.707	9.780
710.0	23790	4.4848	4.4834	4.4950	4.958	4.958	4.932	710.0	23790	8.9417	8.9009	8.9273	9.752	9.693	9.739
713.5	23825	4.5066	4.4974	4.5172	4.992	4.977	4.966	711.0	23800	8.9641	8.9132	8.9433	9.750	9.742	9.752
LTE BAND 38 Channel bandwidth: 5MHz								LTE BAND 38 Channel bandwidth: 10MHz							
Freq. (MHz)	CH	99% BW (MHz)			26 dB BW (MHz)			Freq. (MHz)	CH	99% BW (MHz)			26 dB BW (MHz)		
		QPSK	16QAM	64QAM	QPSK	16QAM	64QAM			QPSK	16QAM	64QAM	QPSK	16QAM	64QAM
2572.5	37775	4.5110	4.5027	4.5031	5.198	5.124	4.944	2575.0	37800	8.9820	8.9686	9.0015	9.802	9.767	10.110
2595.0	38000	4.5048	4.5017	4.5085	5.201	5.212	4.947	2595.0	38000	8.9969	8.9738	8.9882	9.874	9.866	10.180
2617.5	38225	4.5065	4.5009	4.5032	5.161	5.209	4.954	2615.0	38200	8.9990	8.9826	8.9788	9.858	9.946	10.520
LTE BAND 38 Channel bandwidth: 15MHz								LTE BAND 38 Channel bandwidth: 20MHz							
Freq. (MHz)	CH	99% BW (MHz)			26 dB BW (MHz)			Freq. (MHz)	CH	99% BW (MHz)			26 dB BW (MHz)		
		QPSK	16QAM	64QAM	QPSK	16QAM	64QAM			QPSK	16QAM	64QAM	QPSK	16QAM	64QAM
2577.5	37825	13.517	13.516	13.475	15.710	17.210	16.620	2580.0	37850	17.959	17.972	17.960	19.470	20.040	20.230
2595.0	38000	13.496	13.509	13.479	15.840	15.150	16.070	2595.0	38000	17.947	17.963	17.993	19.500	20.520	20.380
2612.5	38175	13.509	13.508	13.468	17.890	15.320	15.870	2610.0	38150	17.959	17.940	17.976	19.630	20.730	20.130
LTE BAND 41 Channel bandwidth: 5MHz								LTE BAND 41 Channel bandwidth: 10MHz							
Freq. (MHz)	CH	99% BW (MHz)			26 dB BW (MHz)			Freq. (MHz)	CH	99% BW (MHz)			26 dB BW (MHz)		
		QPSK	16QAM	64QAM	QPSK	16QAM	64QAM			QPSK	16QAM	64QAM	QPSK	16QAM	64QAM
2498.5	39675	4.5058	4.5006	4.5137	5.084	5.191	4.934	2501.0	39700	9.0021	8.9670	8.9720	10.160	9.758	9.990
2593.0	40620	4.5102	4.5078	4.5027	5.201	5.141	4.925	2593.0	40620	8.9936	8.9811	8.9912	9.987	9.893	10.110
2687.5	41565	4.5032	4.5063	4.5045	5.113	5.186	4.911	2685.0	41540	9.0047	8.9741	8.9787	10.280	9.789	10.020
LTE BAND 41 Channel bandwidth: 15MHz								LTE BAND 41 Channel bandwidth: 20MHz							
Freq. (MHz)	CH	99% BW (MHz)			26 dB BW (MHz)			Freq. (MHz)	CH	99% BW (MHz)			26 dB BW (MHz)		
		QPSK	16QAM	64QAM	QPSK	16QAM	64QAM			QPSK	16QAM	64QAM	QPSK	16QAM	64QAM
2503.5	39725	13.481	13.504	13.453	15.200	14.760	15.060	2506.0	39750	17.906	17.955	17.938	19.560	19.790	20.750
2593.0	40620	13.508	13.502	13.475	15.680	16.430	14.930	2593.0	40620	17.967	17.948	17.962	19.730	20.390	21.340
2682.5	41515	13.510	13.505	13.455	15.570	20.770	15.330	2680.0	41490	17.970	17.942	17.965	20.850	20.270	21.430

Unless otherwise stated the results shown in this test report refer only to the sample(s) tested and such sample(s) are retained for 90 days only.

除非另有說明，此報告結果僅對測試之樣品負責，同時此樣品僅保留90天。本報告未經本公司書面許可，不可部份複製。

This document is issued by the Company subject to its General Conditions of Service printed overleaf, available on request or accessible at <http://www.sgs.com.tw/Terms-and-Conditions> and for electronic format documents, subject to Terms and Conditions for Electronic Documents at <http://www.sgs.com.tw/Terms-and-Conditions>. Attention is drawn to the limitation of liability, indemnification and jurisdiction issues defined therein. Any holder of this document is advised that information contained hereon reflects the Company's findings at the time of its intervention only and within the limits of Client's instructions, if any. The Company's sole responsibility is to its Client and this document does not exonerate parties to a transaction from exercising all their rights and obligations under the transaction documents. This document cannot be reproduced except in full, without prior written approval of the Company. Any unauthorized alteration, forgery or falsification of the content or appearance of this document is unlawful and offenders may be prosecuted to the fullest extent of the law.

GSM_850MHz_LowCH128-824.2

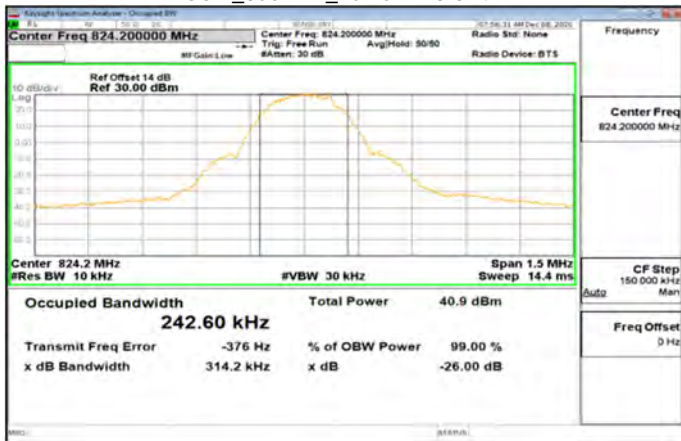

GPRS_850MHz_LowCH128-824.2

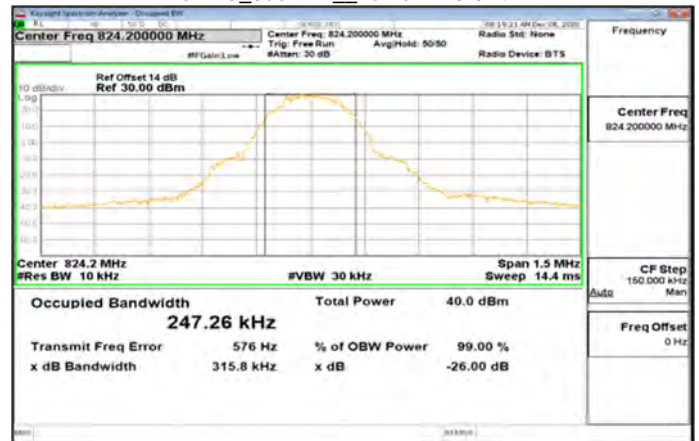

GSM_850MHz_MidCH190-836.6

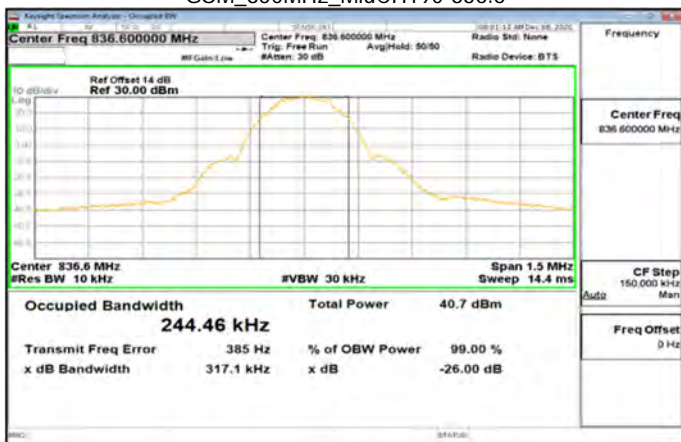

GPRS_850MHz_MidCH190-836.6

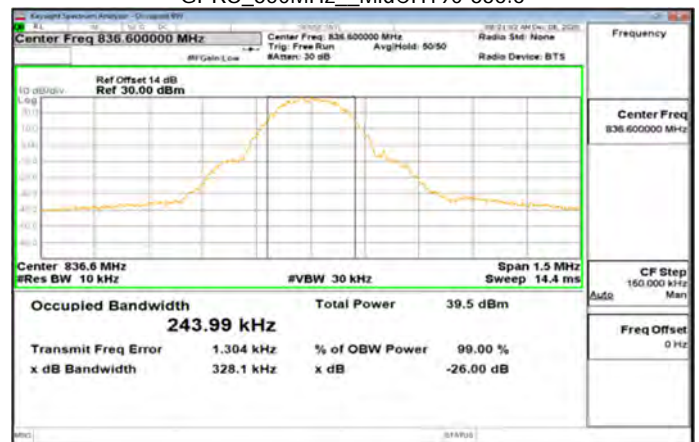

GSM_850MHz_HighCH251-848.8

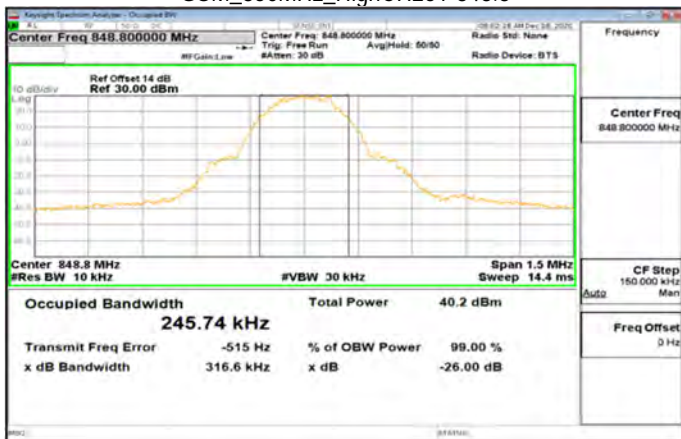

GPRS_850MHz_HighCH251-848.8

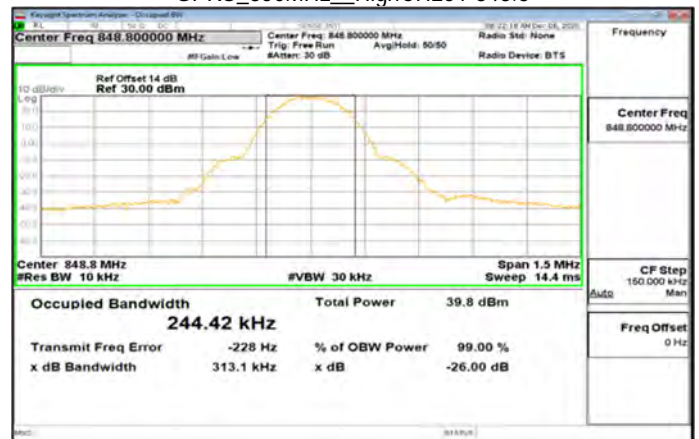

Unless otherwise stated the results shown in this test report refer only to the sample(s) tested and such sample(s) are retained for 90 days only.

除非另有說明，此報告結果僅對測試之樣品負責，同時此樣品僅保留90天。本報告未經本公司書面許可，不可部份複製。

This document is issued by the Company subject to its General Conditions of Service printed overleaf, available on request or accessible at <http://www.sgs.com.tw/Terms-and-Conditions> and for electronic format documents, subject to Terms and Conditions for Electronic Documents at <http://www.sgs.com.tw/Terms-and-Conditions>. Attention is drawn to the limitation of liability, indemnification and jurisdiction issues defined therein. Any holder of this document is advised that information contained hereon reflects the Company's findings at the time of its intervention only and within the limits of Client's instructions, if any. The Company's sole responsibility is to its Client and this document does not exonerate parties to a transaction from exercising all their rights and obligations under the transaction documents. This document cannot be reproduced except in full, without prior written approval of the Company. Any unauthorized alteration, forgery or falsification of the content or appearance of this document is unlawful and offenders may be prosecuted to the fullest extent of the law.

GSM_1900MHz_LowCH512-1850.2

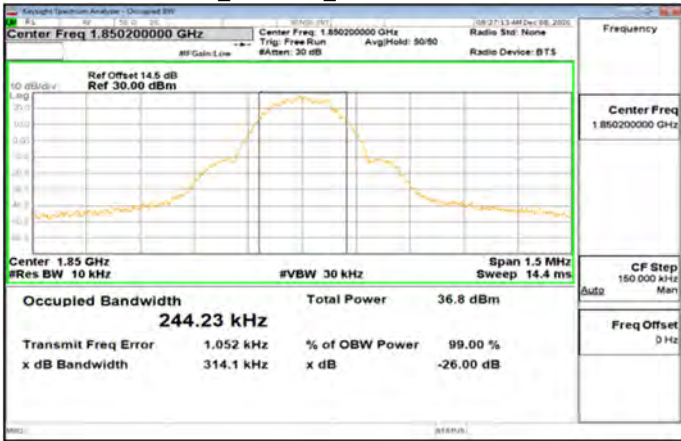

GPRS_1900MHz_LowCH512-1850.2

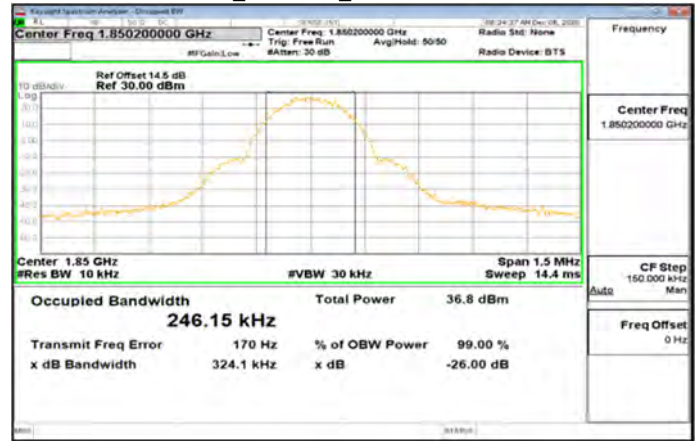

GSM_1900MHz_MidCH661-1880

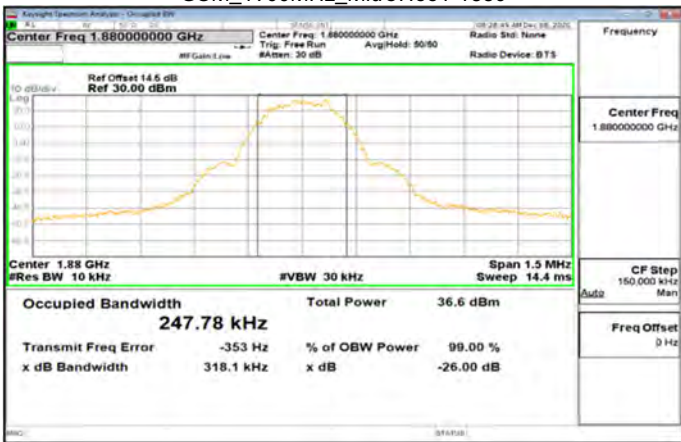

GPRS_1900MHz_MidCH661-1880

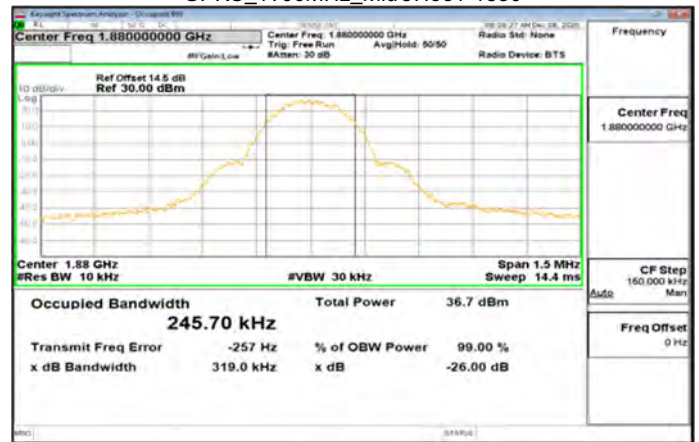

GSM_1900MHz_HighCH810-1909.8

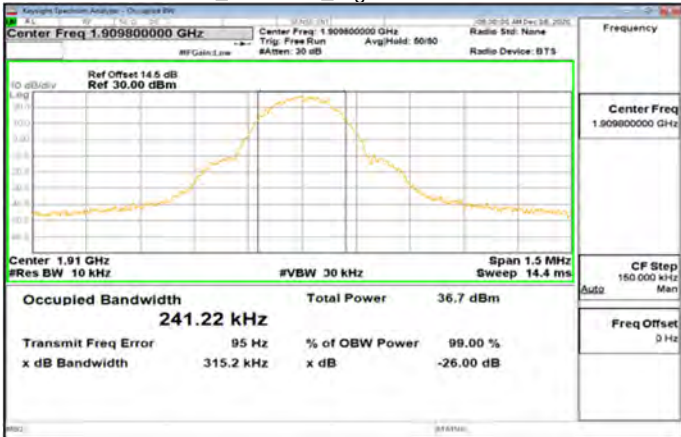

GPRS_1900MHz_HighCH810-1909.8

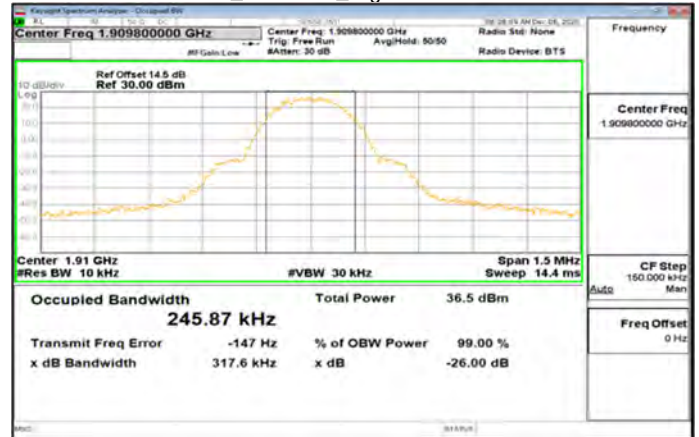

Unless otherwise stated the results shown in this test report refer only to the sample(s) tested and such sample(s) are retained for 90 days only.

除非另有說明，此報告結果僅對測試之樣品負責，同時此樣品僅保留90天。本報告未經本公司書面許可，不可部份複製。

This document is issued by the Company subject to its General Conditions of Service printed overleaf, available on request or accessible at <http://www.sgs.com.tw/Terms-and-Conditions> and for electronic format documents, subject to Terms and Conditions for Electronic Documents at <http://www.sgs.com.tw/Terms-and-Conditions>. Attention is drawn to the limitation of liability, indemnification and jurisdiction issues defined therein. Any holder of this document is advised that information contained herein reflects the Company's findings at the time of its intervention only and within the limits of Client's instructions, if any. The Company's sole responsibility is to its Client and this document does not exonerate parties to a transaction from exercising all their rights and obligations under the transaction documents. This document cannot be reproduced except in full, without prior written approval of the Company. Any unauthorized alteration, forgery or falsification of the content or appearance of this document is unlawful and offenders may be prosecuted to the fullest extent of the law.

WCDMA_B5_LowCH4132-826.4

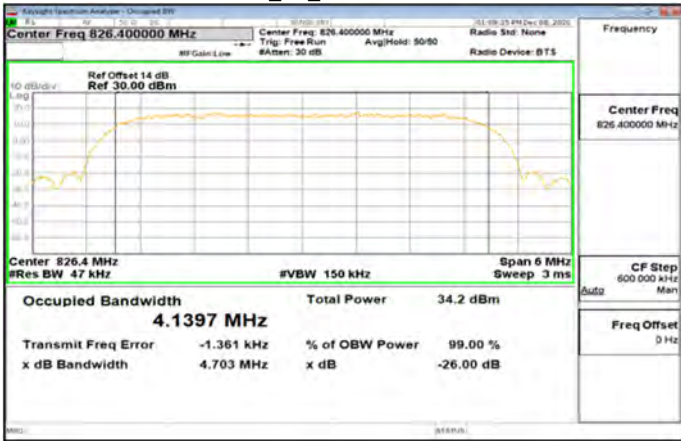

HSDPA_B5_LowCH4132-826.4

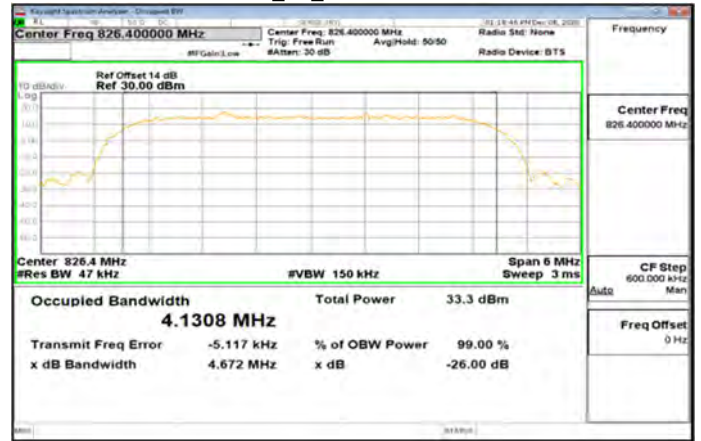

WCDMA_B5_MidCH4183-836.6

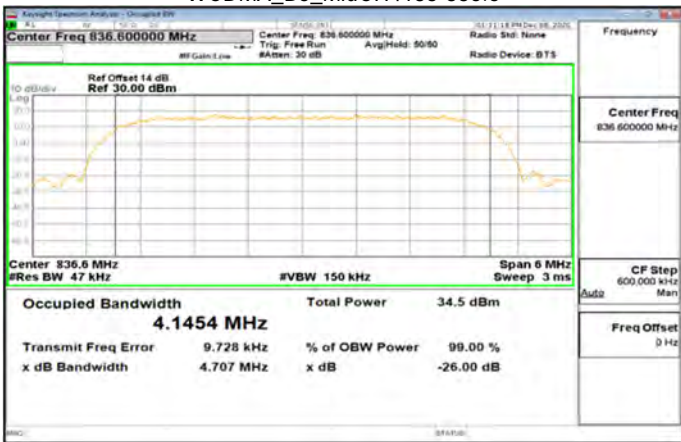

HSDPA_B5_MidCH4183-836.6

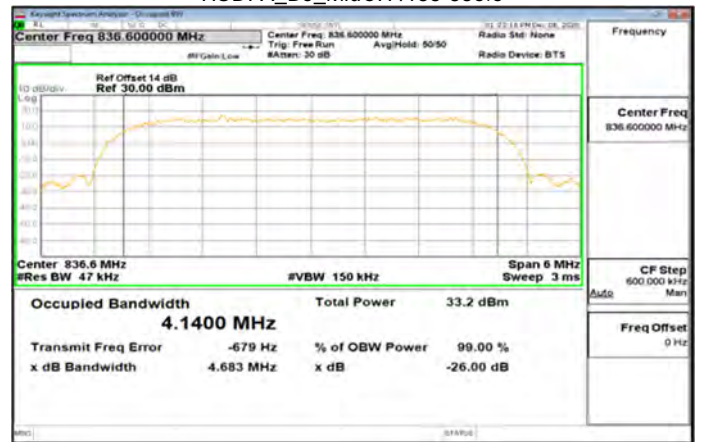

WCDMA_B5_HighCH4233-846.6

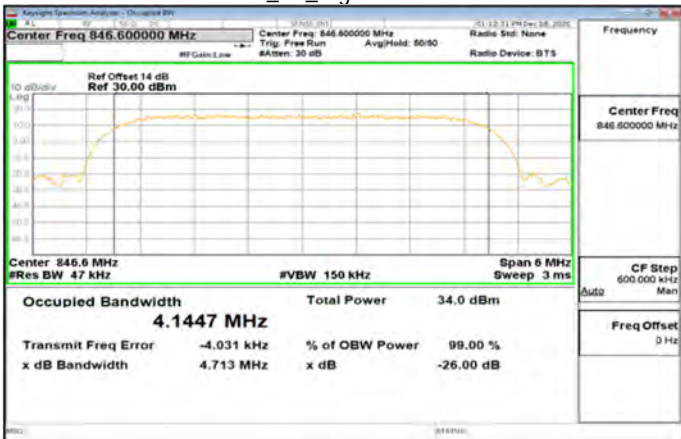

HSDPA_B5_HighCH4233-846.6

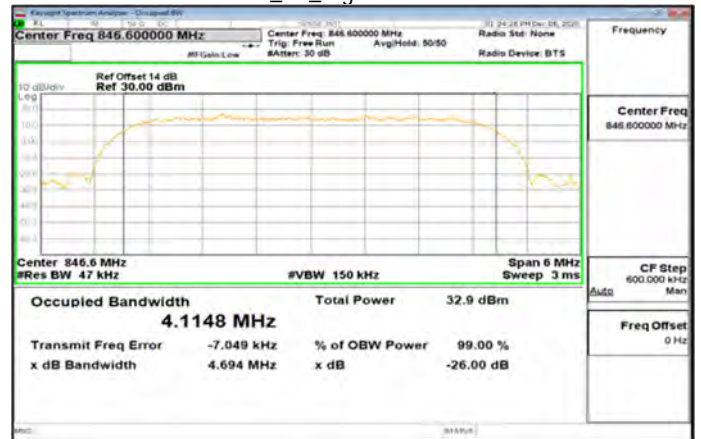

Unless otherwise stated the results shown in this test report refer only to the sample(s) tested and such sample(s) are retained for 90 days only.

除非另有說明，此報告結果僅對測試之樣品負責，同時此樣品僅保留90天。本報告未經本公司書面許可，不可部份複製。

This document is issued by the Company subject to its General Conditions of Service printed overleaf, available on request or accessible at <http://www.sgs.com.tw/Terms-and-Conditions> and for electronic format documents, subject to Terms and Conditions for Electronic Documents at <http://www.sgs.com.tw/Terms-and-Conditions>. Attention is drawn to the limitation of liability, indemnification and jurisdiction issues defined therein. Any holder of this document is advised that information contained herein reflects the Company's findings at the time of its intervention only and within the limits of Client's instructions, if any. The Company's sole responsibility is to its Client and this document does not exonerate parties to a transaction from exercising all their rights and obligations under the transaction documents. This document cannot be reproduced except in full, without prior written approval of the Company. Any unauthorized alteration, forgery or falsification of the content or appearance of this document is unlawful and offenders may be prosecuted to the fullest extent of the law.

HSUPA_B5_LowCH4132-826.4

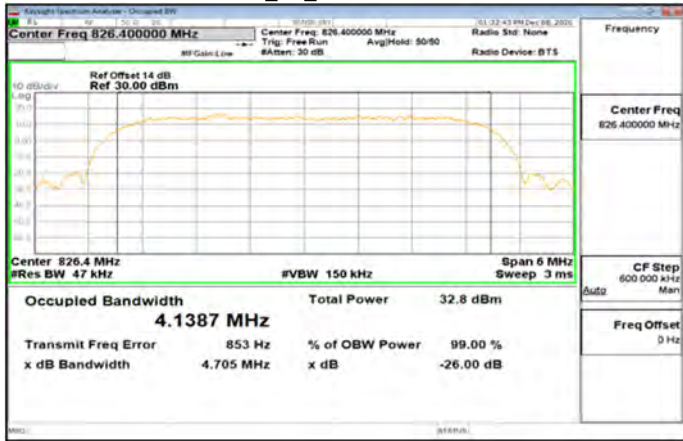

Band5_1_4MHz_QPSK_6_0_Main_LowCH20407-824.7

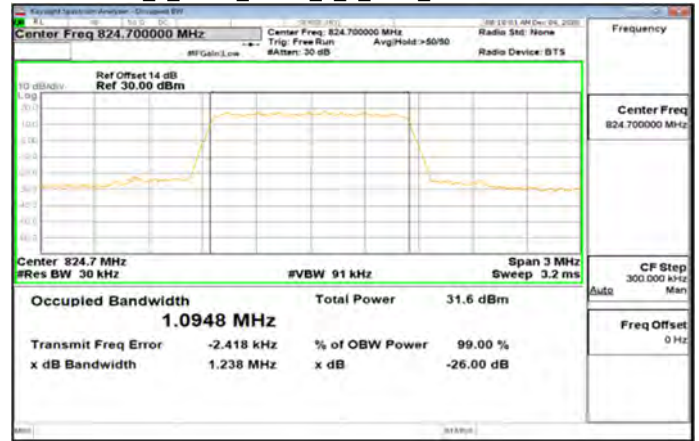

HSUPA_B5_MidCH183-836.6

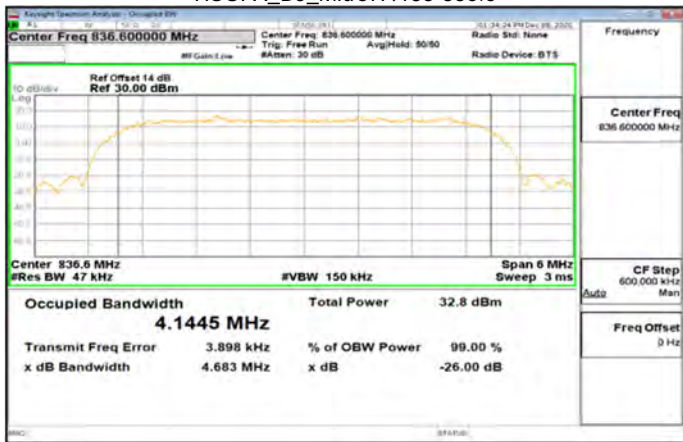

Band5_1_4MHz_QPSK_6_0_Main_MidCH20525-836.5

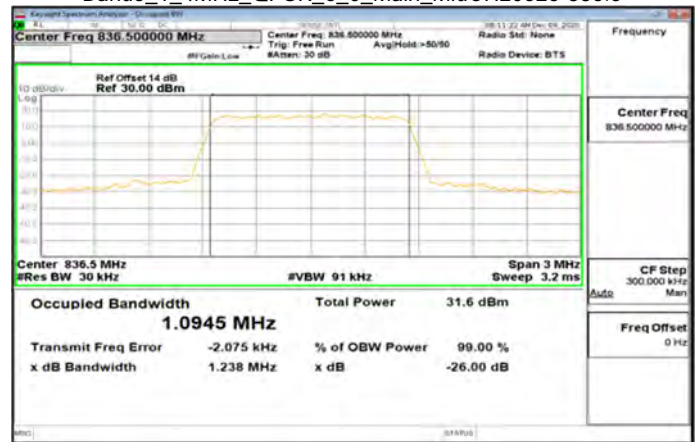

HSUPA_B5_HighCH4233-846.6

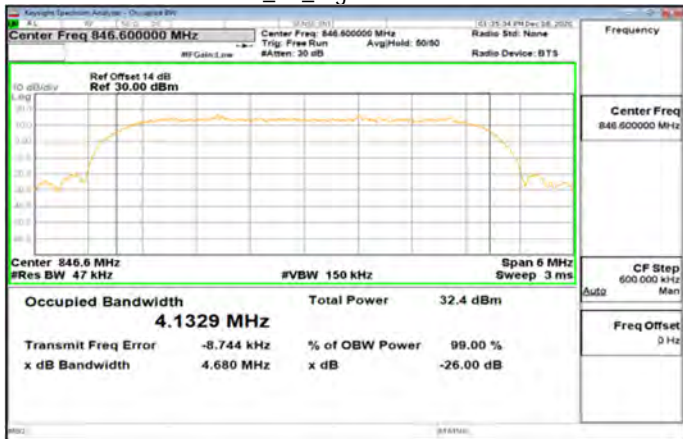

Band5_1_4MHz_QPSK_6_0_Main_HighCH20643-848.3

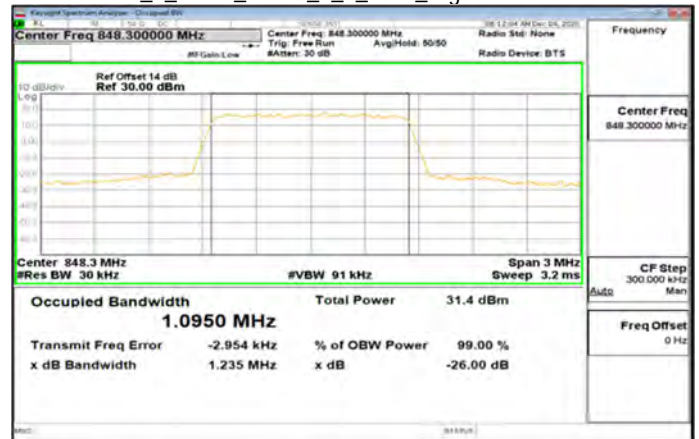

Unless otherwise stated the results shown in this test report refer only to the sample(s) tested and such sample(s) are retained for 90 days only.

除非另有說明，此報告結果僅對測試之樣品負責，同時此樣品僅保留90天。本報告未經本公司書面許可，不可部份複製。

This document is issued by the Company subject to its General Conditions of Service printed overleaf, available on request or accessible at <http://www.sgs.com.tw/Terms-and-Conditions> and for electronic format documents, subject to Terms and Conditions for Electronic Documents at <http://www.sgs.com.tw/Terms-and-Conditions>. Attention is drawn to the limitation of liability, indemnification and jurisdiction issues defined therein. Any holder of this document is advised that information contained herein reflects the Company's findings at the time of its intervention only and within the limits of Client's instructions, if any. The Company's sole responsibility is to its Client and this document does not exonerate parties to a transaction from exercising all their rights and obligations under the transaction documents. This document cannot be reproduced except in full, without prior written approval of the Company. Any unauthorized alteration, forgery or falsification of the content or appearance of this document is unlawful and offenders may be prosecuted to the fullest extent of the law.

Band5_1_4MHz_16QAM_6_0_Main_LowCH20407-824.7

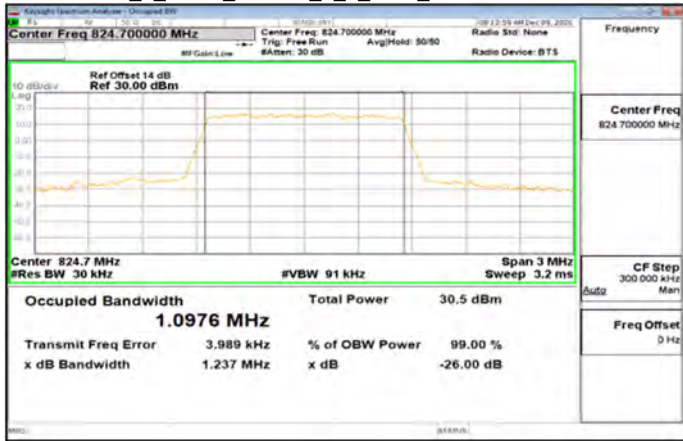

Band5_1_4MHz_64QAM_6_0_Main_LowCH20407-824.7

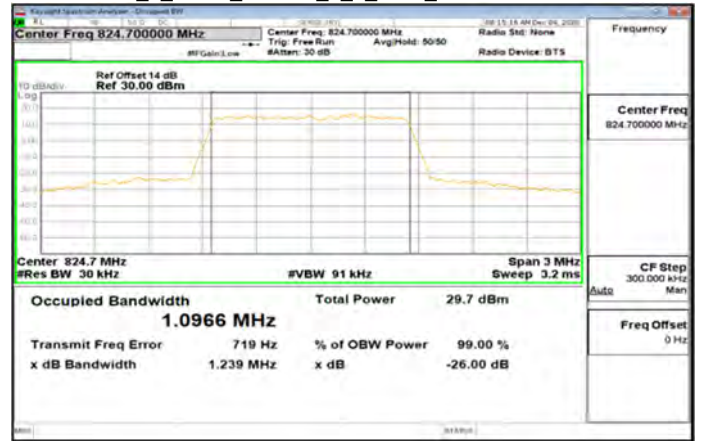

Band5_1_4MHz_16QAM_6_0_Main_MidCH20525-836.5

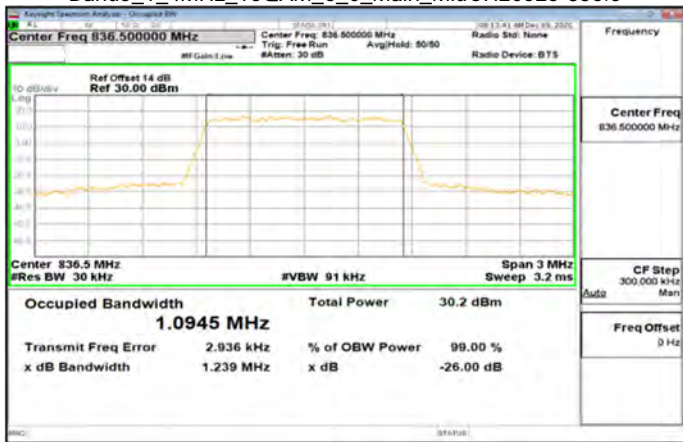

Band5_1_4MHz_64QAM_6_0_Main_MidCH20525-836.5

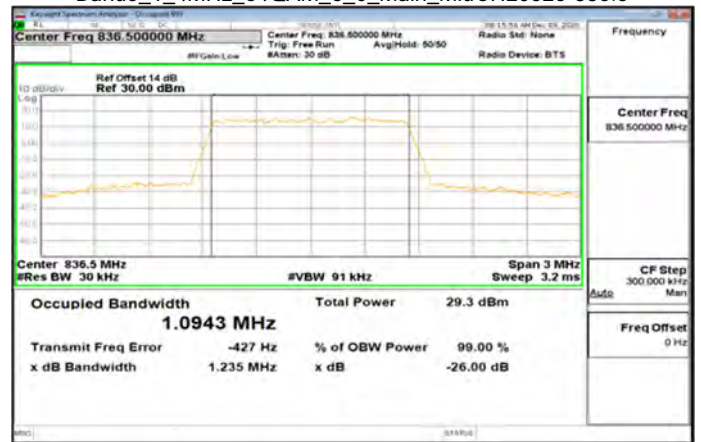

Band5_1_4MHz_16QAM_6_0_Main_HighCH20643-848.3

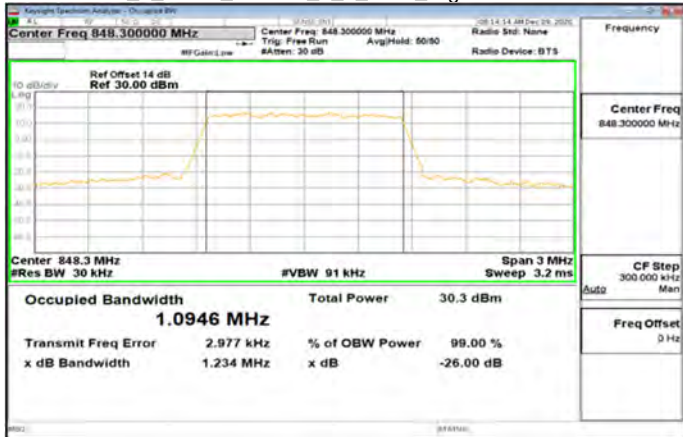

Band5_1_4MHz_64QAM_6_0_Main_HighCH20643-848.3

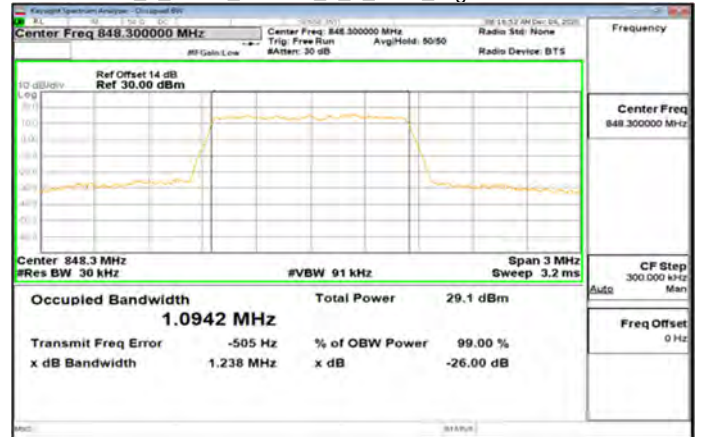

Unless otherwise stated the results shown in this test report refer only to the sample(s) tested and such sample(s) are retained for 90 days only.

除非另有說明，此報告結果僅對測試之樣品負責，同時此樣品僅保留90天。本報告未經本公司書面許可，不可部份複製。

This document is issued by the Company subject to its General Conditions of Service printed overleaf, available on request or accessible at <http://www.sgs.com.tw/Terms-and-Conditions> and for electronic format documents, subject to Terms and Conditions for Electronic Documents at <http://www.sgs.com.tw/Terms-and-Conditions>. Attention is drawn to the limitation of liability, indemnification and jurisdiction issues defined therein. Any holder of this document is advised that information contained herein reflects the Company's findings at the time of its intervention only and within the limits of Client's instructions, if any. The Company's sole responsibility is to its Client and this document does not exonerate parties to a transaction from exercising all their rights and obligations under the transaction documents. This document cannot be reproduced except in full, without prior written approval of the Company. Any unauthorized alteration, forgery or falsification of the content or appearance of this document is unlawful and offenders may be prosecuted to the fullest extent of the law.

Band5_3MHz_QPSK_15_0_Main_LowCH20415-825.5

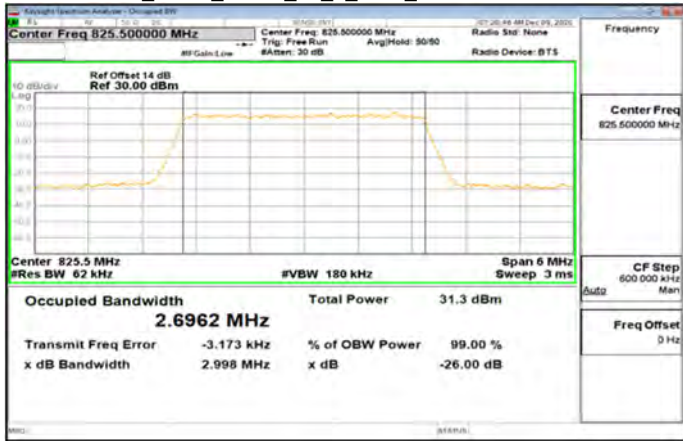

Band5_3MHz_16QAM_15_0_Main_LowCH20415-825.5

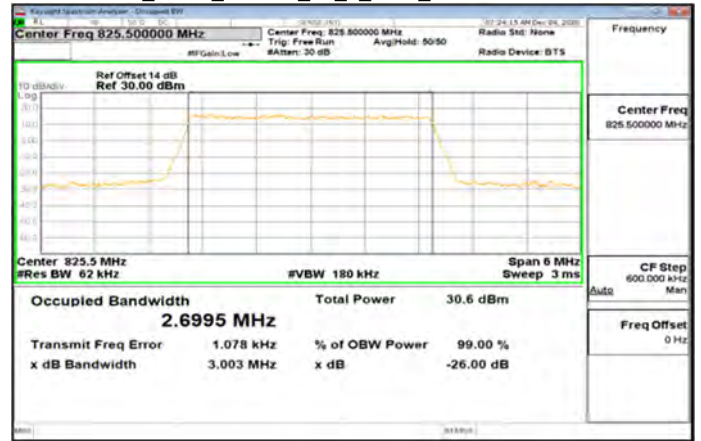

Band5_3MHz_QPSK_15_0_Main_MidCH20525-836.5

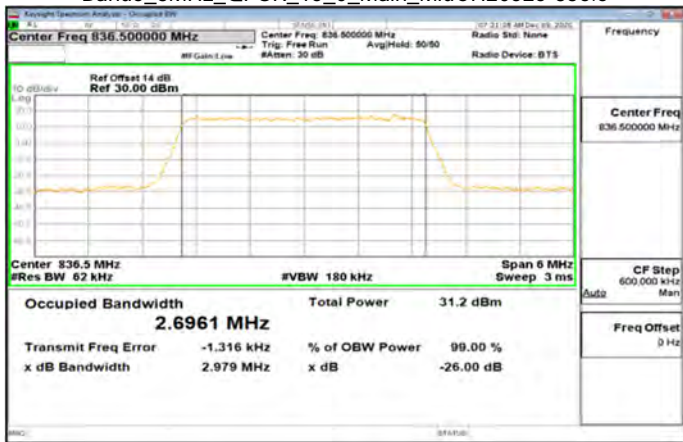

Band5_3MHz_16QAM_15_0_Main_MidCH20525-836.5

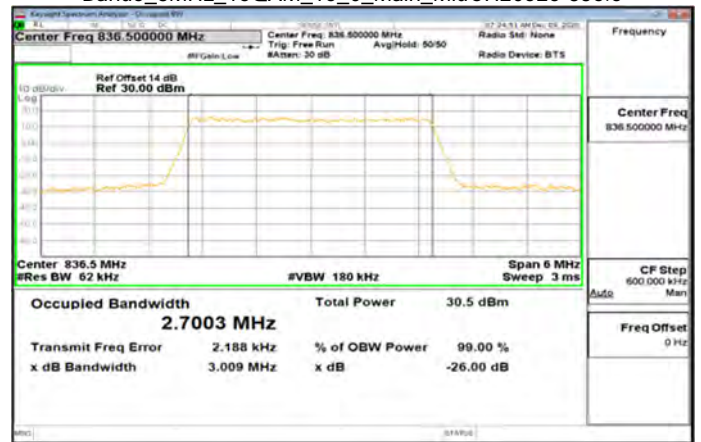

Band5_3MHz_QPSK_15_0_Main_HighCH20635-847.5

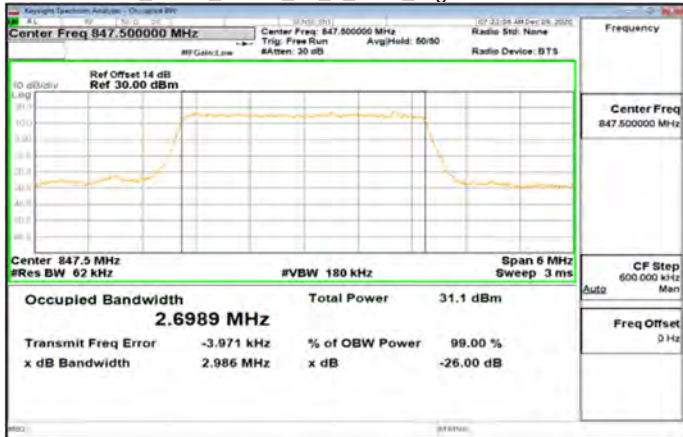

Band5_3MHz_16QAM_15_0_Main_HighCH20635-847.5

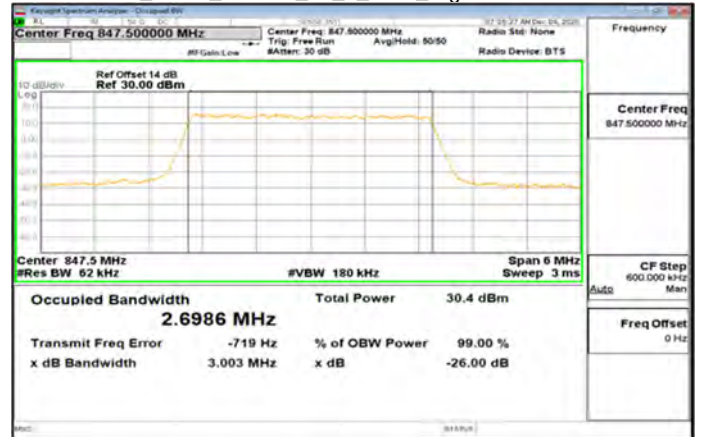

Unless otherwise stated the results shown in this test report refer only to the sample(s) tested and such sample(s) are retained for 90 days only.

除非另有說明，此報告結果僅對測試之樣品負責，同時此樣品僅保留90天。本報告未經本公司書面許可，不可部份複製。

This document is issued by the Company subject to its General Conditions of Service printed overleaf, available on request or accessible at <http://www.sgs.com.tw/Terms-and-Conditions> and for electronic format documents, subject to Terms and Conditions for Electronic Documents at <http://www.sgs.com.tw/Terms-and-Conditions>. Attention is drawn to the limitation of liability, indemnification and jurisdiction issues defined therein. Any holder of this document is advised that information contained herein reflects the Company's findings at the time of its intervention only and within the limits of Client's instructions, if any. The Company's sole responsibility is to its Client and this document does not exonerate parties to a transaction from exercising all their rights and obligations under the transaction documents. This document cannot be reproduced except in full, without prior written approval of the Company. Any unauthorized alteration, forgery or falsification of the content or appearance of this document is unlawful and offenders may be prosecuted to the fullest extent of the law.

Band5_3MHz_64QAM_15_0_Main_LowCH20415-825.5

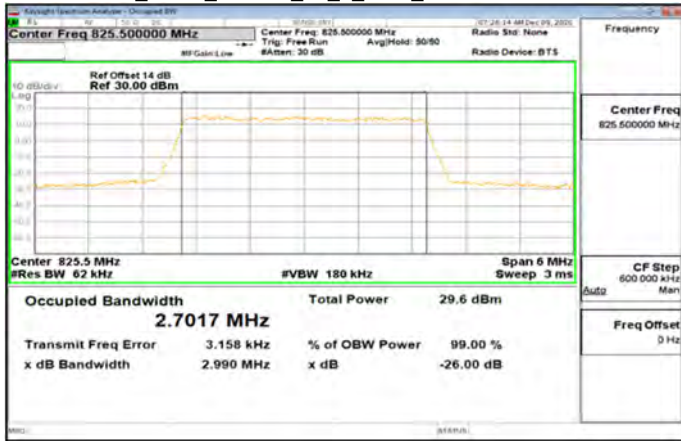

Band5_5MHz_QPSK_25_0_Main_LowCH20425-826.5

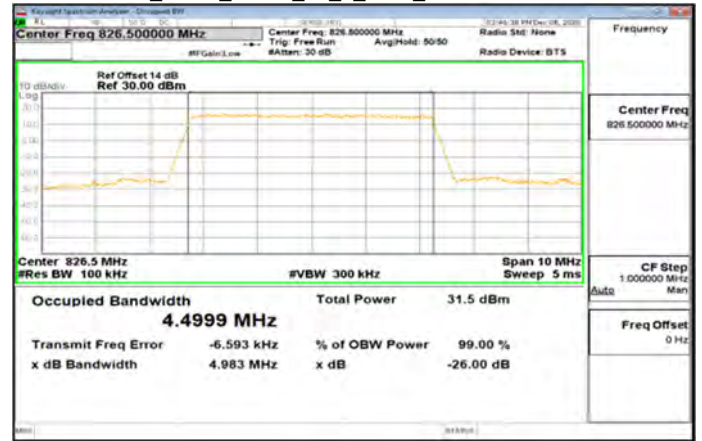

Band5_3MHz_64QAM_15_0_Main_MidCH20525-836.5

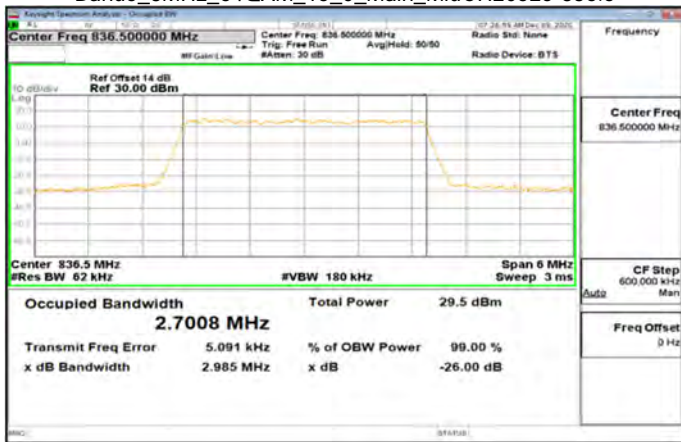

Band5_5MHz_QPSK_25_0_Main_MidCH20525-836.5

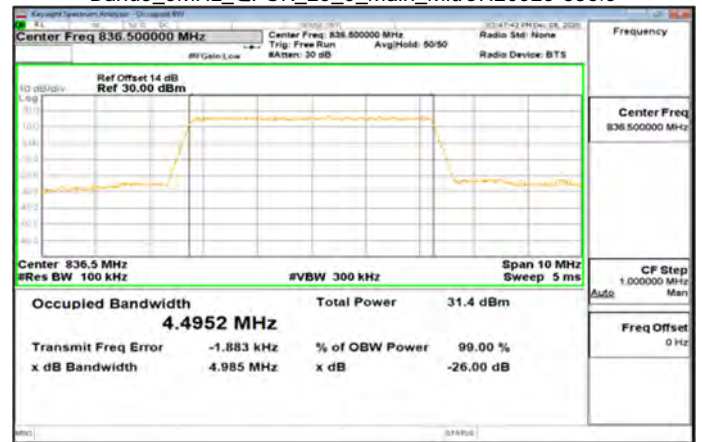

Band5_3MHz_64QAM_15_0_Main_HighCH20635-847.5

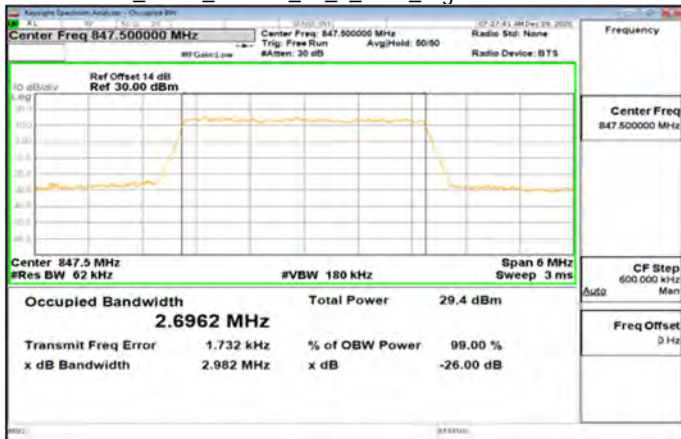

Band5_5MHz_QPSK_25_0_Main_HighCH20625-846.5

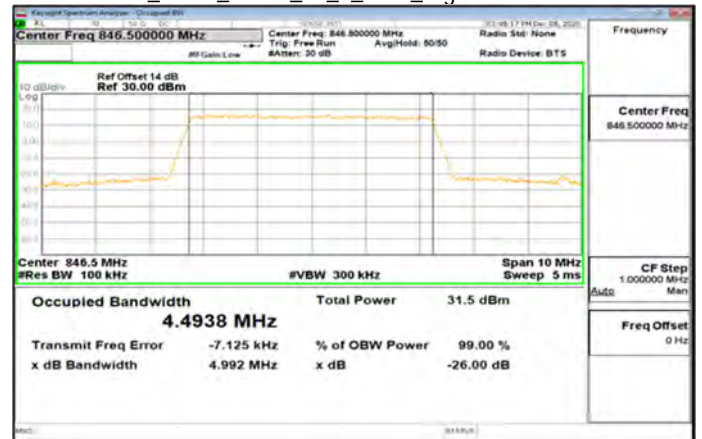

Unless otherwise stated the results shown in this test report refer only to the sample(s) tested and such sample(s) are retained for 90 days only.

除非另有說明，此報告結果僅對測試之樣品負責，同時此樣品僅保留90天。本報告未經本公司書面許可，不可部份複製。

This document is issued by the Company subject to its General Conditions of Service printed overleaf, available on request or accessible at <http://www.sgs.com.tw/Terms-and-Conditions> and for electronic format documents, subject to Terms and Conditions for Electronic Documents at <http://www.sgs.com.tw/Terms-and-Conditions>. Attention is drawn to the limitation of liability, indemnification and jurisdiction issues defined therein. Any holder of this document is advised that information contained herein reflects the Company's findings at the time of its intervention only and within the limits of Client's instructions, if any. The Company's sole responsibility is to its Client and this document does not exonerate parties to a transaction from exercising all their rights and obligations under the transaction documents. This document cannot be reproduced except in full, without prior written approval of the Company. Any unauthorized alteration, forgery or falsification of the content or appearance of this document is unlawful and offenders may be prosecuted to the fullest extent of the law.

Band5_5MHz_16QAM_25_0_Main_LowCH20425-826.5

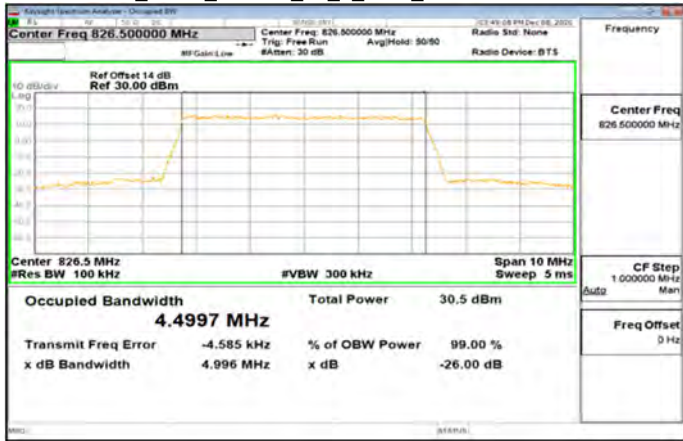

Band5_5MHz_64QAM_25_0_Main_LowCH20425-826.5

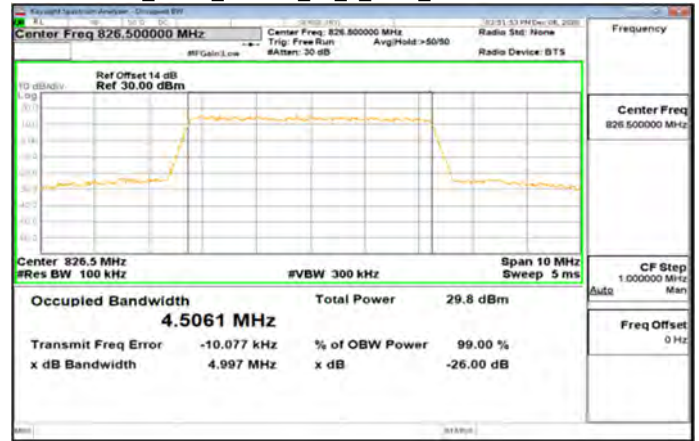

Band5_5MHz_16QAM_25_0_Main_MidCH20525-836.5

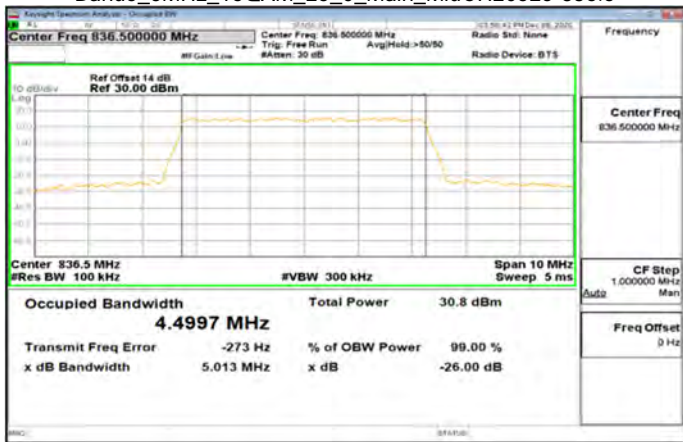

Band5_5MHz_64QAM_25_0_Main_MidCH20525-836.5

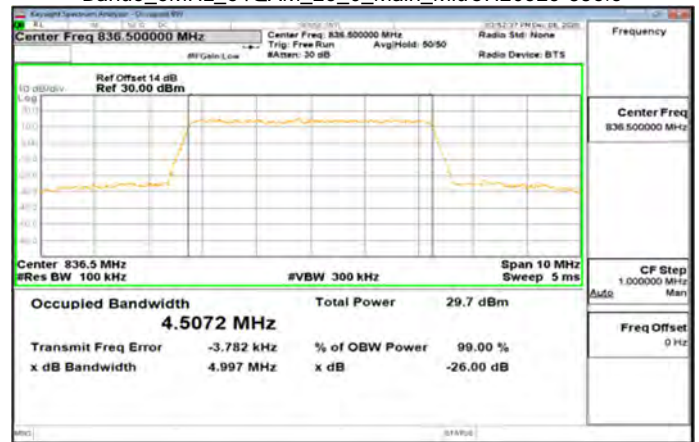

Band5_5MHz_16QAM_25_0_Main_HighCH20625-846.5

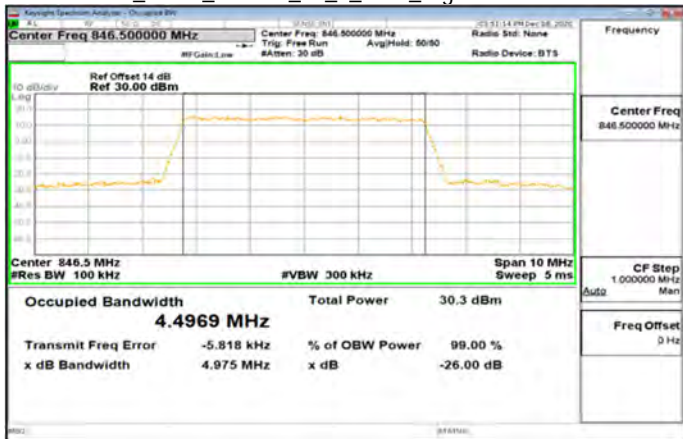

Band5_5MHz_64QAM_25_0_Main_HighCH20625-846.5

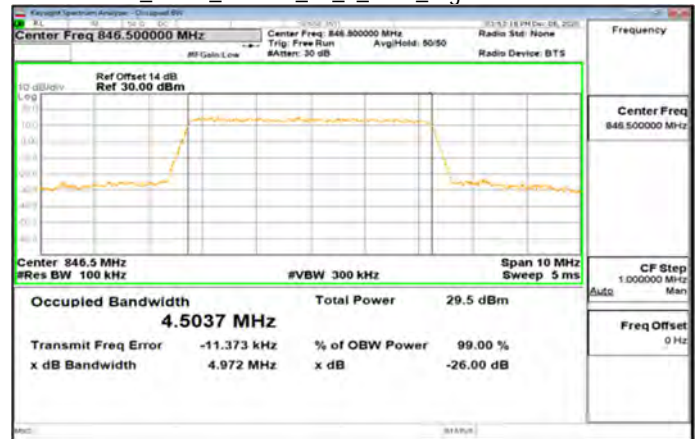

Unless otherwise stated the results shown in this test report refer only to the sample(s) tested and such sample(s) are retained for 90 days only.

除非另有說明，此報告結果僅對測試之樣品負責，同時此樣品僅保留90天。本報告未經本公司書面許可，不可部份複製。

This document is issued by the Company subject to its General Conditions of Service printed overleaf, available on request or accessible at <http://www.sgs.com.tw/Terms-and-Conditions> and for electronic format documents, subject to Terms and Conditions for Electronic Documents at <http://www.sgs.com.tw/Terms-and-Conditions>. Attention is drawn to the limitation of liability, indemnification and jurisdiction issues defined therein. Any holder of this document is advised that information contained herein reflects the Company's findings at the time of its intervention only and within the limits of Client's instructions, if any. The Company's sole responsibility is to its Client and this document does not exonerate parties to a transaction from exercising all their rights and obligations under the transaction documents. This document cannot be reproduced except in full, without prior written approval of the Company. Any unauthorized alteration, forgery or falsification of the content or appearance of this document is unlawful and offenders may be prosecuted to the fullest extent of the law.

Band5_10MHz_QPSK_50_0_Main_LowCH20450-829

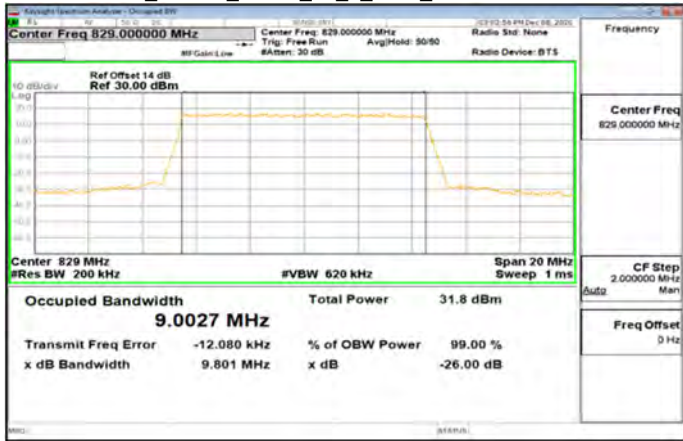

Band5_10MHz_16QAM_50_0_Main_LowCH20450-829

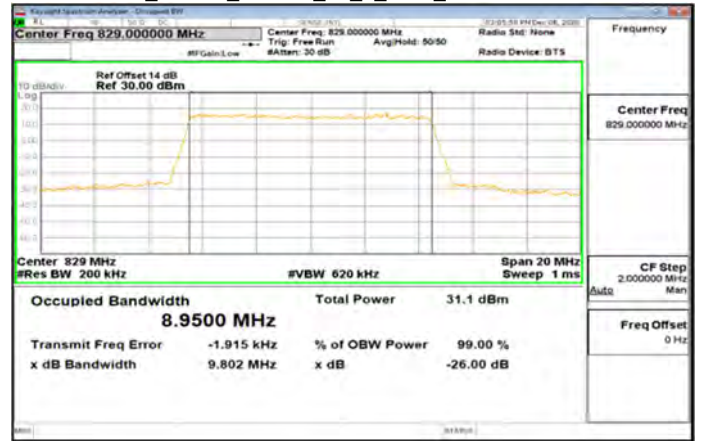

Band5_10MHz_QPSK_50_0_Main_MidCH20525-836.5

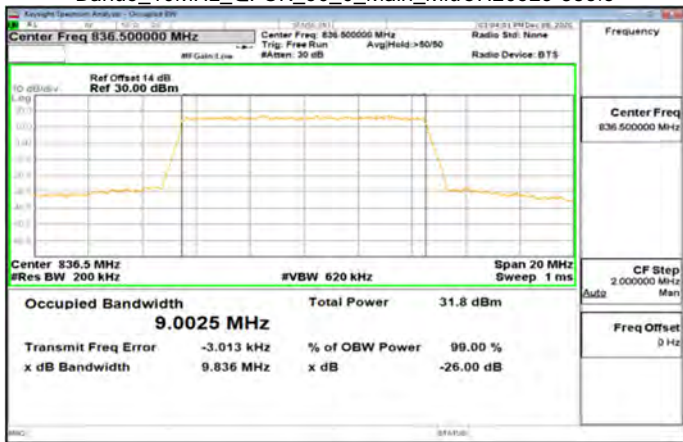

Band5_10MHz_16QAM_50_0_Main_MidCH20525-836.5

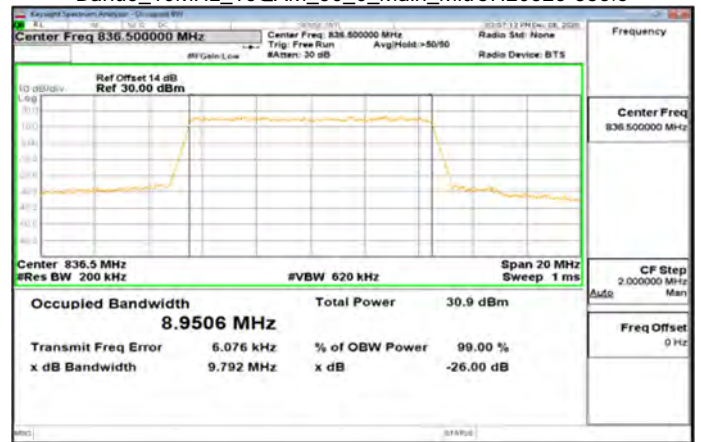

Band5_10MHz_QPSK_50_0_Main_HighCH20600-844

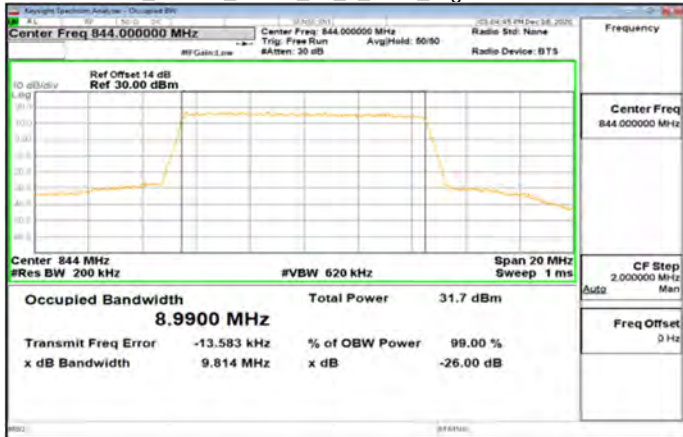

Band5_10MHz_16QAM_50_0_Main_HighCH20600-844

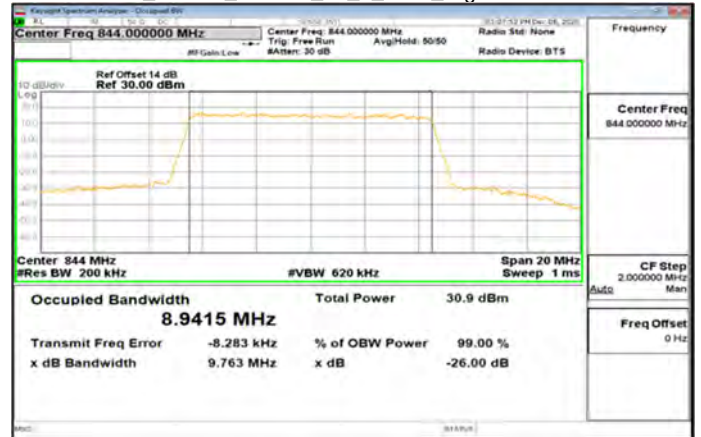

Unless otherwise stated the results shown in this test report refer only to the sample(s) tested and such sample(s) are analyzed for 90 days only.

除非另有說明，此報告結果僅對測試之樣品負責，同時此樣品僅保留90天。本報告未經本公司書面許可，不可部份複製。

This document is issued by the Company subject to its General Conditions of Service printed overleaf, available on request or accessible at <http://www.sgs.com.tw/Terms-and-Conditions> and for electronic format documents, subject to Terms and Conditions for Electronic Documents at <http://www.sgs.com.tw/Terms-and-Conditions>. Attention is drawn to the limitation of liability, indemnification and jurisdiction issues defined therein. Any holder of this document is advised that information contained herein reflects the Company's findings at the time of its intervention only and within the limits of Client's instructions, if any. The Company's sole responsibility is to its Client and this document does not exonerate parties to a transaction from exercising all their rights and obligations under the transaction documents. This document cannot be reproduced except in full, without prior written approval of the Company. Any unauthorized alteration, forgery or falsification of the content or appearance of this document is unlawful and offenders may be prosecuted to the fullest extent of the law.

Band5_10MHz_64QAM_50_0_Main_LowCH20450-829

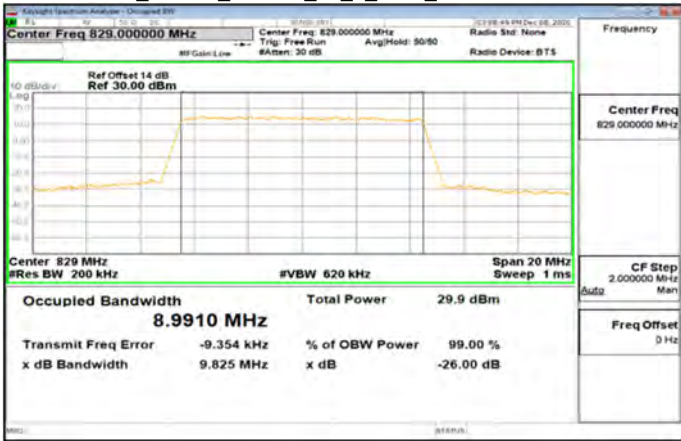

Band12_1_4MHz_QPSK_6_0_Main_LowCH23017-699.7

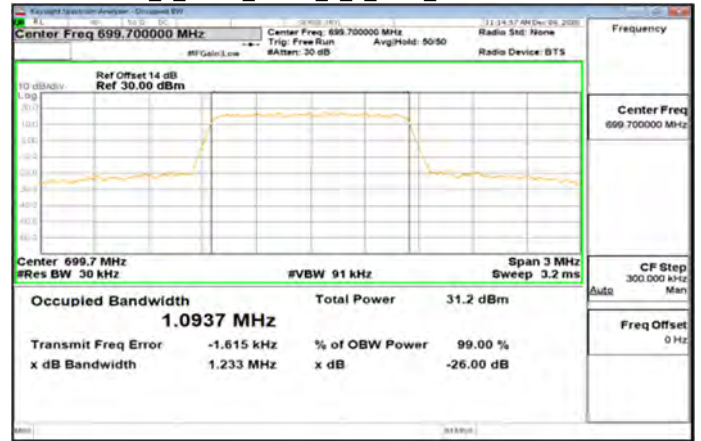

Band5_10MHz_64QAM_50_0_Main_MidCH20525-836.5

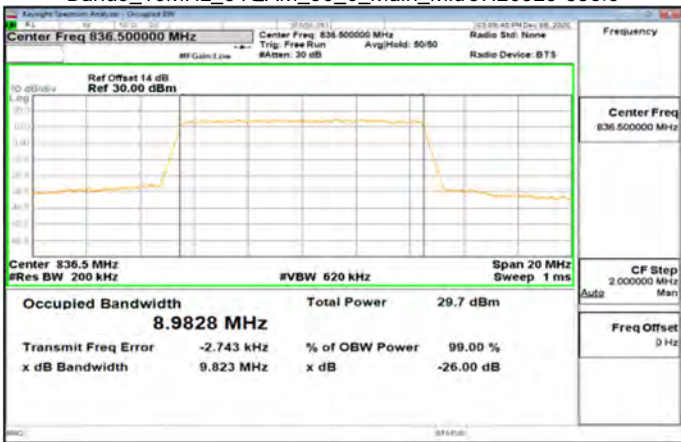

Band12_1_4MHz_QPSK_6_0_Main_MidCH23095-707.5

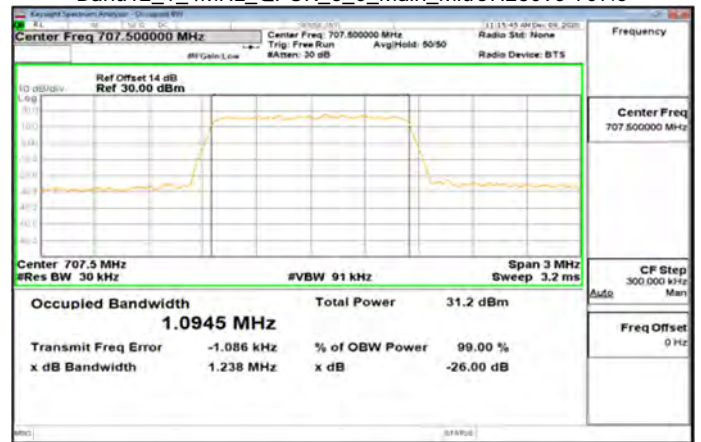

Band5_10MHz_64QAM_50_0_Main_HighCH20600-844

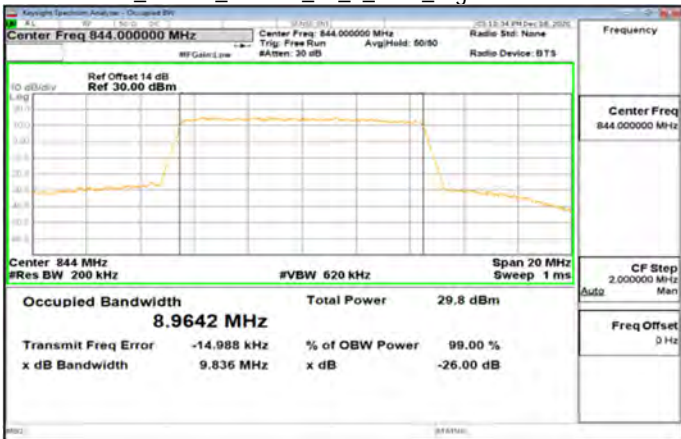

Band12_1_4MHz_QPSK_6_0_Main_HighCH23173-715.3

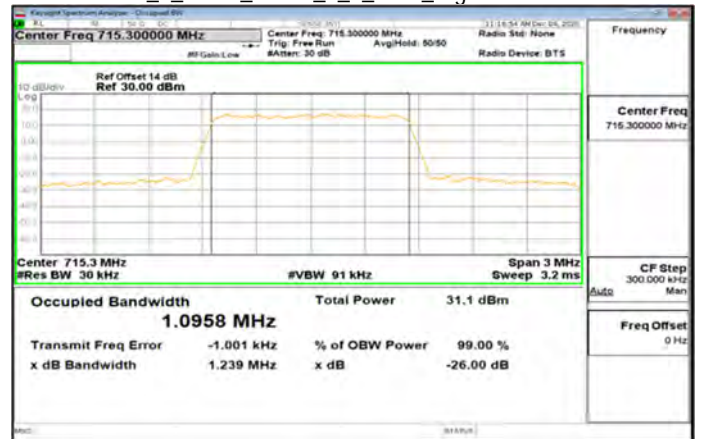

Unless otherwise stated the results shown in this test report refer only to the sample(s) tested and such sample(s) are reported for 90 days only.

除非另有說明，此報告結果僅對測試之樣品負責，同時此樣品僅保留90天。本報告未經本公司書面許可，不可部份複製。

This document is issued by the Company subject to its General Conditions of Service printed overleaf, available on request or accessible at <http://www.sgs.com.tw/Terms-and-Conditions> and for electronic format documents, subject to Terms and Conditions for Electronic Documents at <http://www.sgs.com.tw/Terms-and-Conditions>. Attention is drawn to the limitation of liability, indemnification and jurisdiction issues defined therein. Any holder of this document is advised that information contained herein reflects the Company's findings at the time of its intervention only and within the limits of Client's instructions, if any. The Company's sole responsibility is to its Client and this document does not exonerate parties to a transaction from exercising all their rights and obligations under the transaction documents. This document cannot be reproduced except in full, without prior written approval of the Company. Any unauthorized alteration, forgery or falsification of the content or appearance of this document is unlawful and offenders may be prosecuted to the fullest extent of the law.

Band12_1_4MHz_16QAM_6_0_Main_LowCH23017-699.7

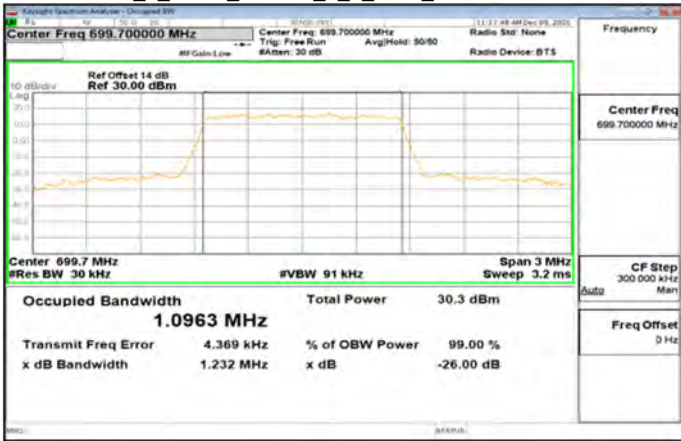

Band12_1_4MHz_64QAM_6_0_Main_LowCH23017-699.7

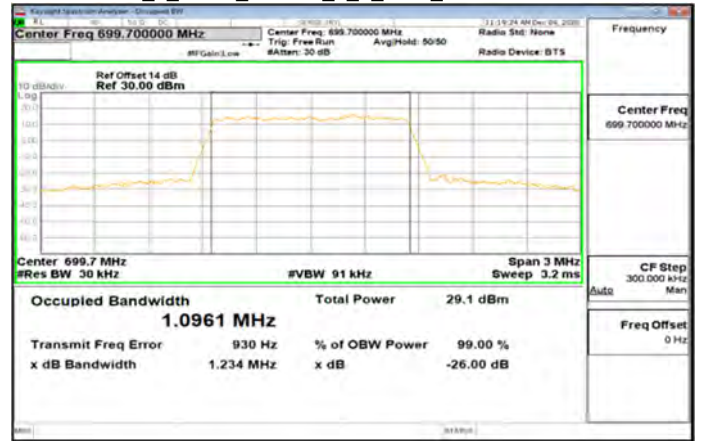

Band12_1_4MHz_16QAM_6_0_Main_MidCH23095-707.5

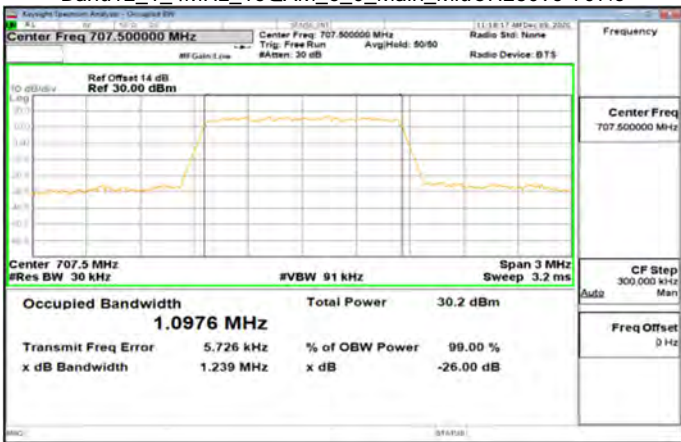

Band12_1_4MHz_64QAM_6_0_Main_MidCH23095-707.5

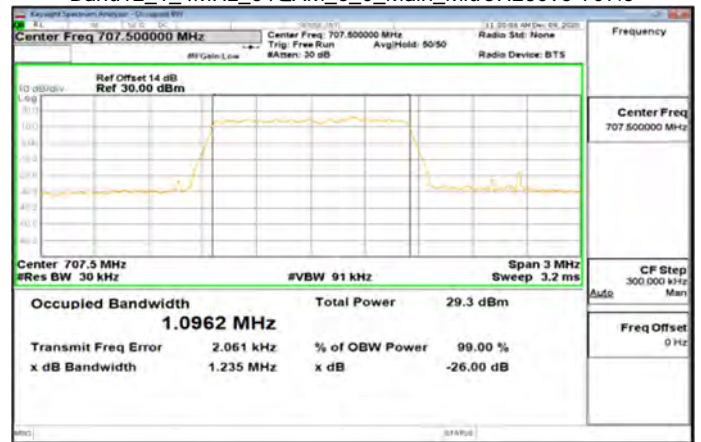

Band12_1_4MHz_16QAM_6_0_Main_HighCH23173-715.3

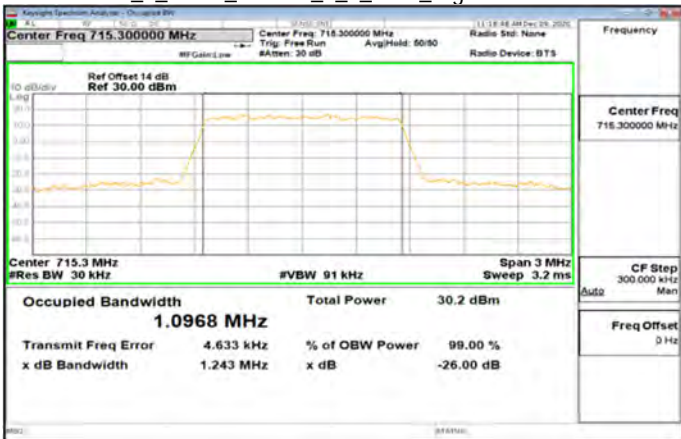

Band12_1_4MHz_64QAM_6_0_Main_HighCH23173-715.3

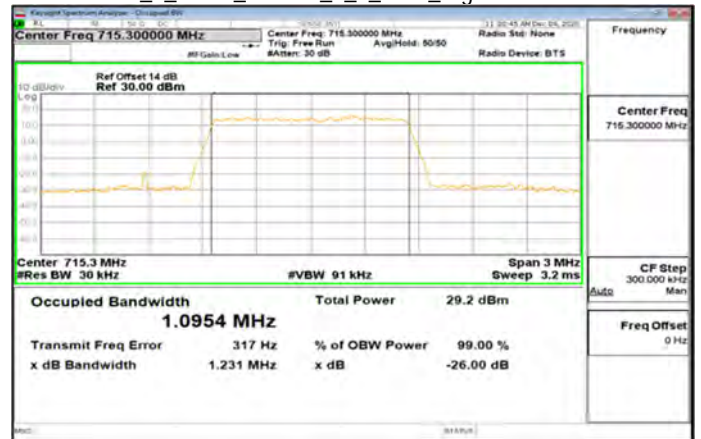

Unless otherwise stated the results shown in this test report refer only to the sample(s) tested and such sample(s) are for 90 days only.

除非另有說明，此報告結果僅對測試之樣品負責，同時此樣品僅保留90天。本報告未經本公司書面許可，不可部份複製。

This document is issued by the Company subject to its General Conditions of Service printed overleaf, available on request or accessible at <http://www.sgs.com.tw/Terms-and-Conditions> and for electronic format documents, subject to Terms and Conditions for Electronic Documents at <http://www.sgs.com.tw/Terms-and-Conditions>. Attention is drawn to the limitation of liability, indemnification and jurisdiction issues defined therein. Any holder of this document is advised that information contained herein reflects the Company's findings at the time of its intervention only and within the limits of Client's instructions, if any. The Company's sole responsibility is to its Client and this document does not exonerate parties to a transaction from exercising all their rights and obligations under the transaction documents. This document cannot be reproduced except in full, without prior written approval of the Company. Any unauthorized alteration, forgery or falsification of the content or appearance of this document is unlawful and offenders may be prosecuted to the fullest extent of the law.

Band12_3MHz_QPSK_15_0_Main_LowCH23025-700.5

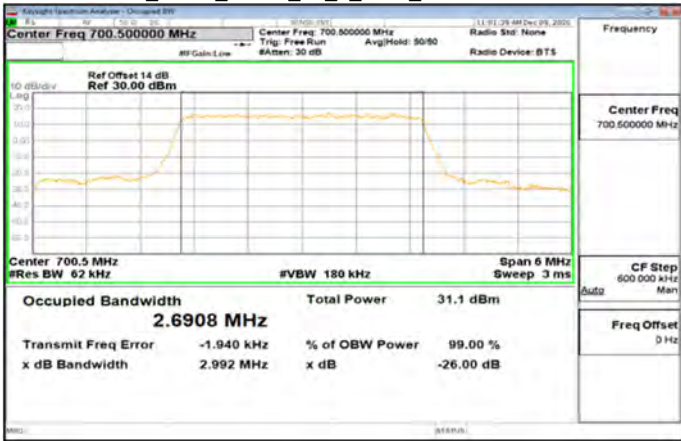

Band12_3MHz_16QAM_15_0_Main_LowCH23025-700.5

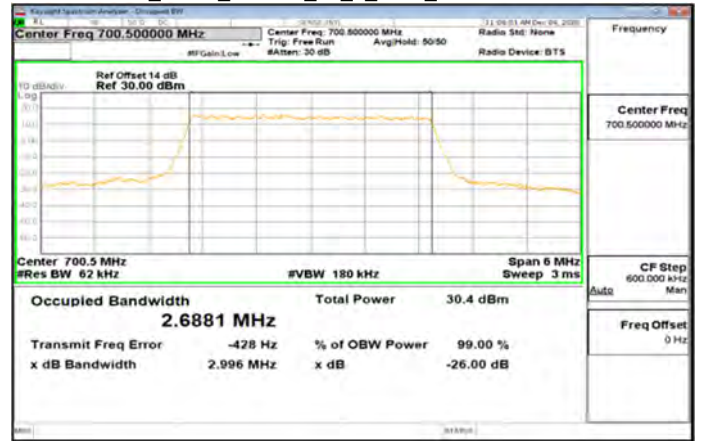

Band12_3MHz_QPSK_15_0_Main_MidCH23095-707.5

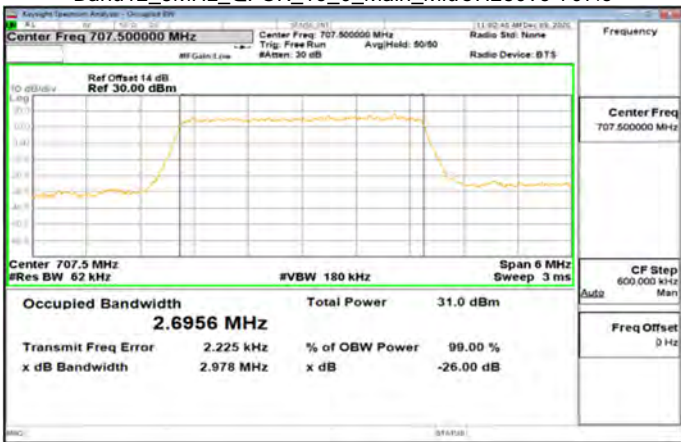

Band12_3MHz_16QAM_15_0_Main_MidCH23095-707.5

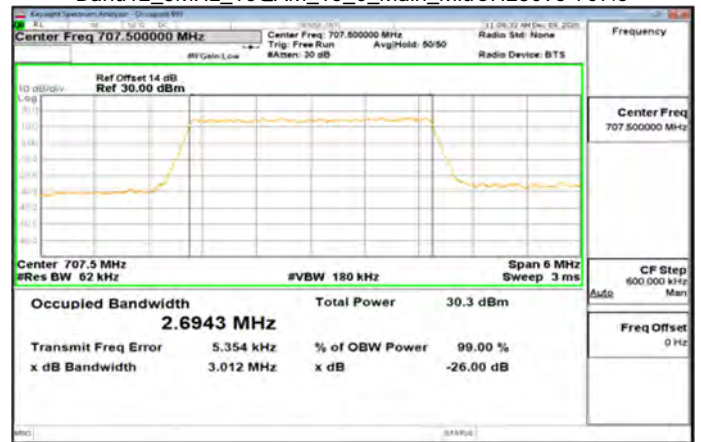

Band12_3MHz_QPSK_15_0_Main_HighCH23165-714.5

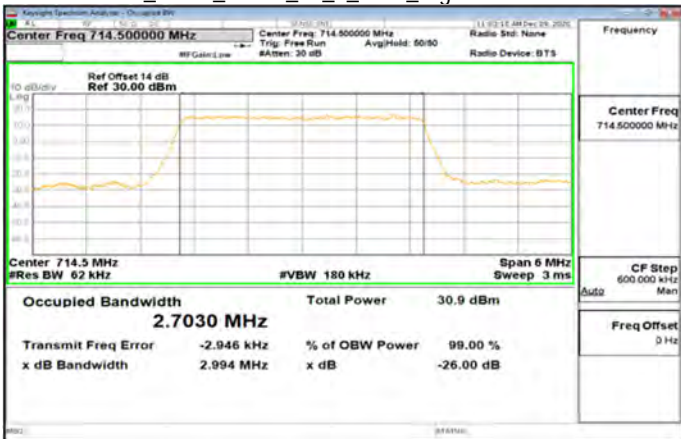

Band12_3MHz_16QAM_15_0_Main_HighCH23165-714.5

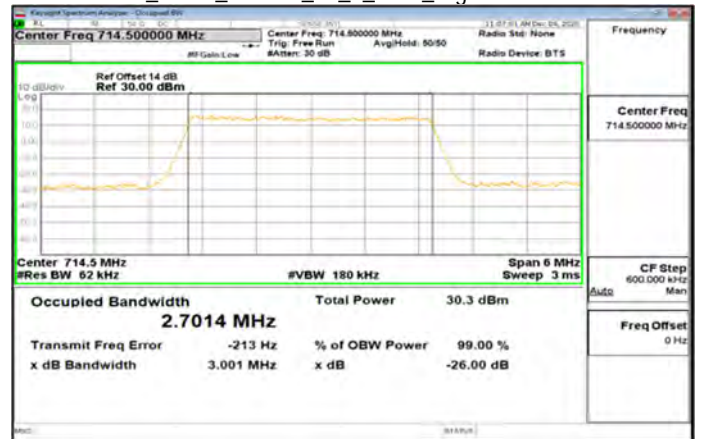

Unless otherwise stated the results shown in this test report refer only to the sample(s) tested and such sample(s) are retained for 90 days only.

除非另有說明，此報告結果僅對測試之樣品負責，同時此樣品僅保留90天。本報告未經本公司書面許可，不可部份複製。

This document is issued by the Company subject to its General Conditions of Service printed overleaf, available on request or accessible at <http://www.sgs.com.tw/Terms-and-Conditions> and for electronic format documents, subject to Terms and Conditions for Electronic Documents at <http://www.sgs.com.tw/Terms-and-Conditions>. Attention is drawn to the limitation of liability, indemnification and jurisdiction issues defined therein. Any holder of this document is advised that information contained herein reflects the Company's findings at the time of its intervention only and within the limits of Client's instructions, if any. The Company's sole responsibility is to its Client and this document does not exonerate parties to a transaction from exercising all their rights and obligations under the transaction documents. This document cannot be reproduced except in full, without prior written approval of the Company. Any unauthorized alteration, forgery or falsification of the content or appearance of this document is unlawful and offenders may be prosecuted to the fullest extent of the law.

Band12_3MHz_64QAM_15_0_Main_LowCH23025-700.5

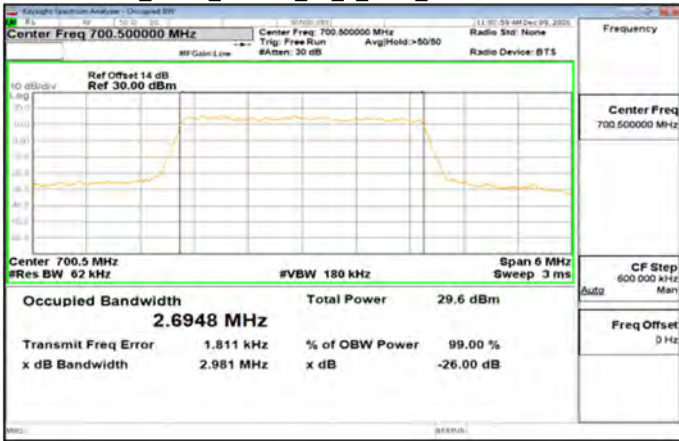

Band12_5MHz_QPSK_25_0_Main_LowCH23035-701.5

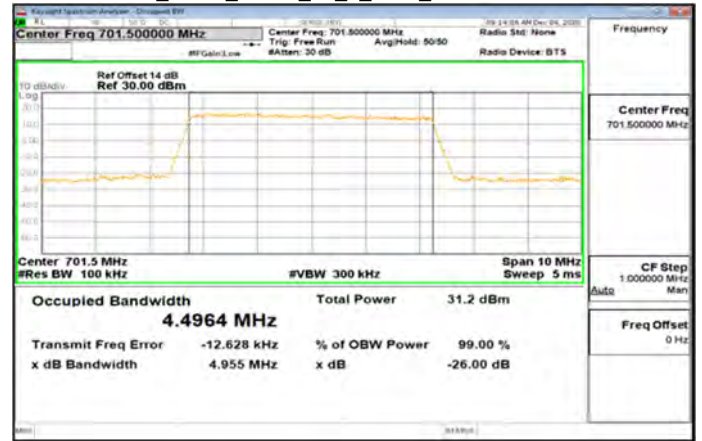

Band12_3MHz_64QAM_15_0_Main_MidCH23095-707.5

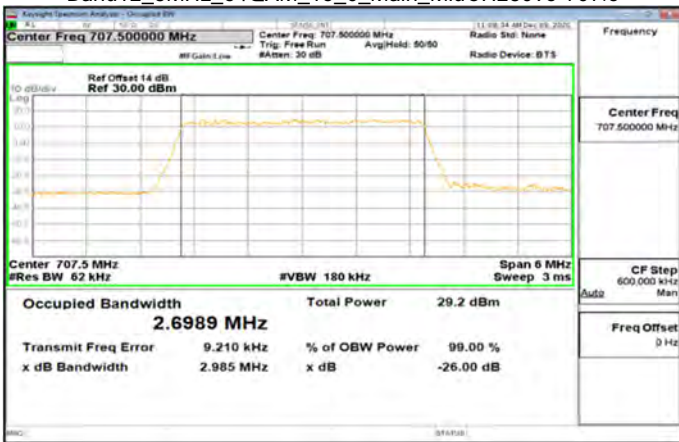

Band12_5MHz_QPSK_25_0_Main_MidCH23095-707.5

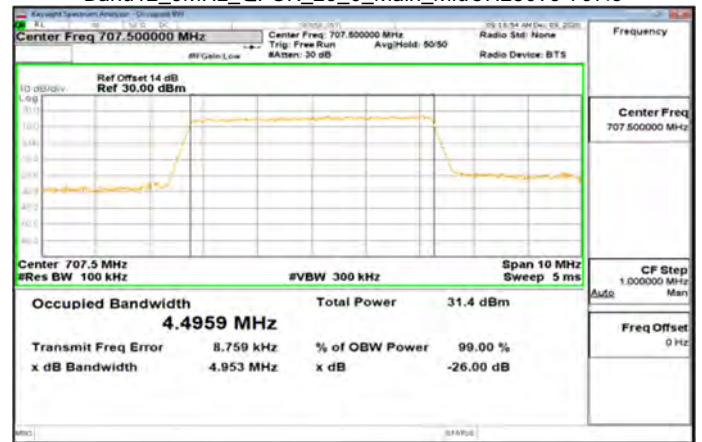

Band12_3MHz_64QAM_15_0_Main_HighCH23165-714.5

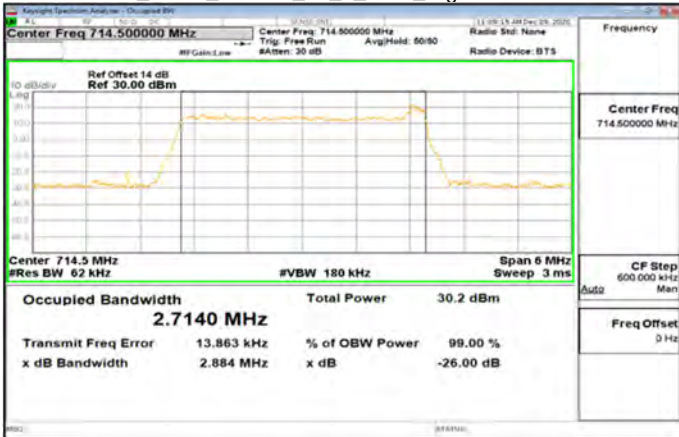

Band12_5MHz_QPSK_25_0_Main_HighCH23155-713.5

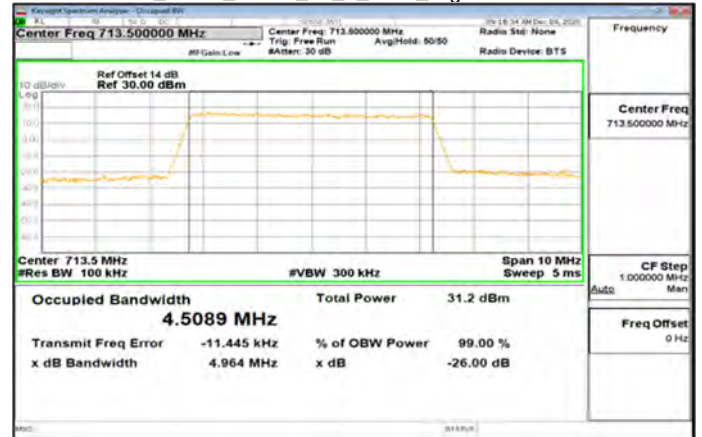

Unless otherwise stated the results shown in this test report refer only to the sample(s) tested and such sample(s) are retained for 90 days only.

除非另有說明，此報告結果僅對測試之樣品負責，同時此樣品僅保留90天。本報告未經本公司書面許可，不可部份複製。

This document is issued by the Company subject to its General Conditions of Service printed overleaf, available on request or accessible at <http://www.sgs.com.tw/Terms-and-Conditions> and for electronic format documents, subject to Terms and Conditions for Electronic Documents at <http://www.sgs.com.tw/Terms-and-Conditions>. Attention is drawn to the limitation of liability, indemnification and jurisdiction issues defined therein. Any holder of this document is advised that information contained hereon reflects the Company's findings at the time of its intervention only and within the limits of Client's instructions, if any. The Company's sole responsibility is to its Client and this document does not exonerate parties to a transaction from exercising all their rights and obligations under the transaction documents. This document cannot be reproduced except in full, without prior written approval of the Company. Any unauthorized alteration, forgery or falsification of the content or appearance of this document is unlawful and offenders may be prosecuted to the fullest extent of the law.

Band12_5MHz_16QAM_25_0_Main_LowCH23035-701.5

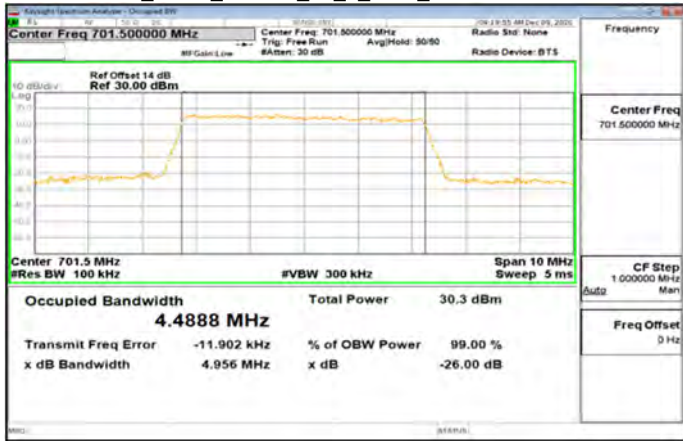

Band12_5MHz_64QAM_25_0_Main_LowCH23035-701.5

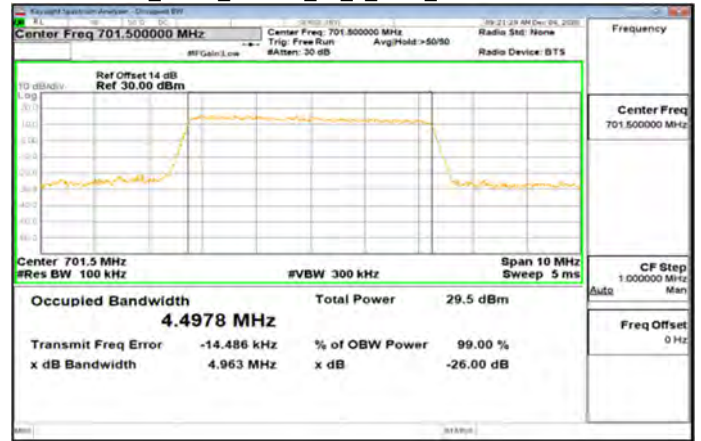

Band12_5MHz_16QAM_25_0_Main_MidCH23095-707.5

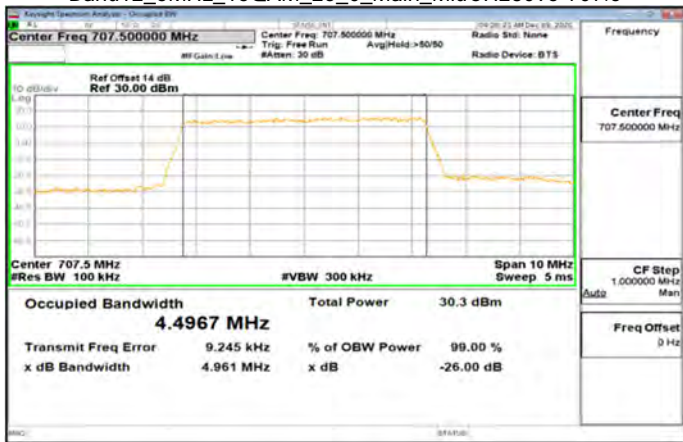

Band12_5MHz_64QAM_25_0_Main_MidCH23095-707.5

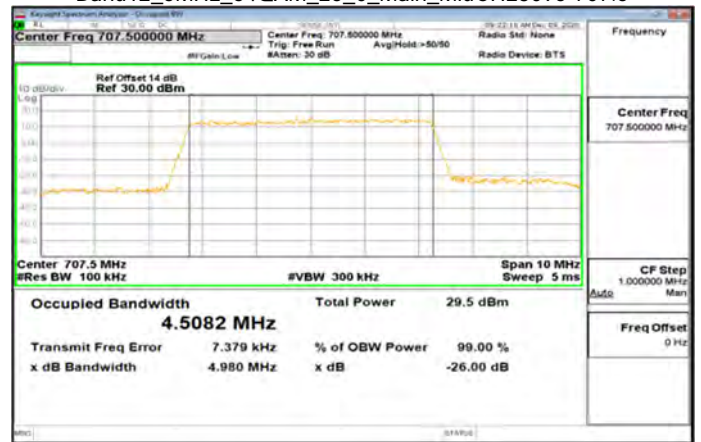

Band12_5MHz_16QAM_25_0_Main_HighCH23155-713.5

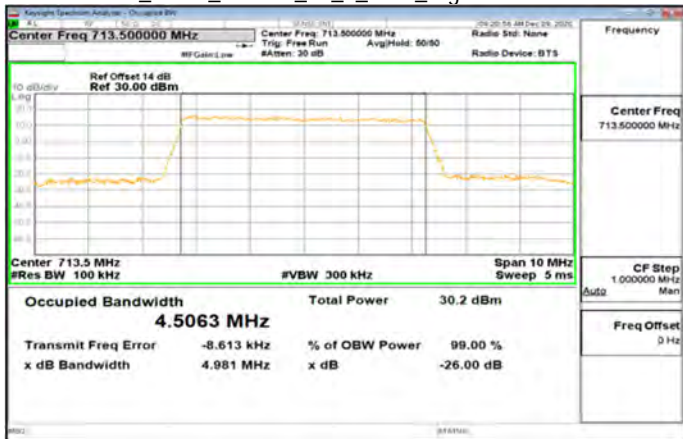

Band12_5MHz_64QAM_25_0_Main_HighCH23155-713.5

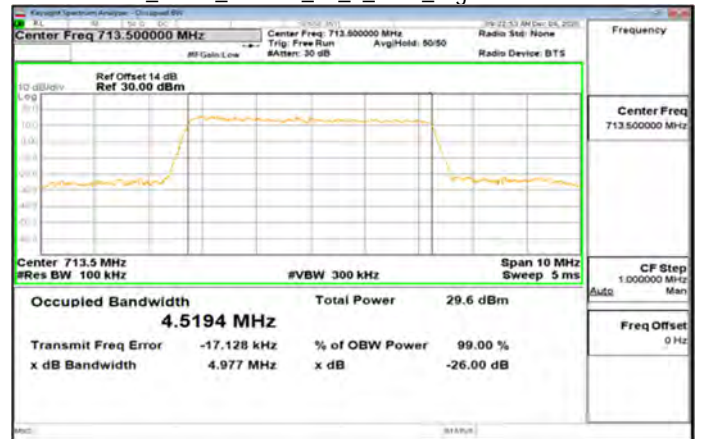

Unless otherwise stated the results shown in this test report refer only to the sample(s) tested and such sample(s) are retained for 90 days only.

除非另有說明，此報告結果僅對測試之樣品負責，同時此樣品僅保留90天。本報告未經本公司書面許可，不可部份複製。

This document is issued by the Company subject to its General Conditions of Service printed overleaf, available on request or accessible at <http://www.sgs.com.tw/Terms-and-Conditions> and for electronic format documents, subject to Terms and Conditions for Electronic Documents at <http://www.sgs.com.tw/Terms-and-Conditions>. Attention is drawn to the limitation of liability, indemnification and jurisdiction issues defined therein. Any holder of this document is advised that information contained herein reflects the Company's findings at the time of its intervention only and within the limits of Client's instructions, if any. The Company's sole responsibility is to its Client and this document does not exonerate parties to a transaction from exercising all their rights and obligations under the transaction documents. This document cannot be reproduced except in full, without prior written approval of the Company. Any unauthorized alteration, forgery or falsification of the content or appearance of this document is unlawful and offenders may be prosecuted to the fullest extent of the law.

Band12_10MHz_QPSK_50_0_Main_LowCH23060-704

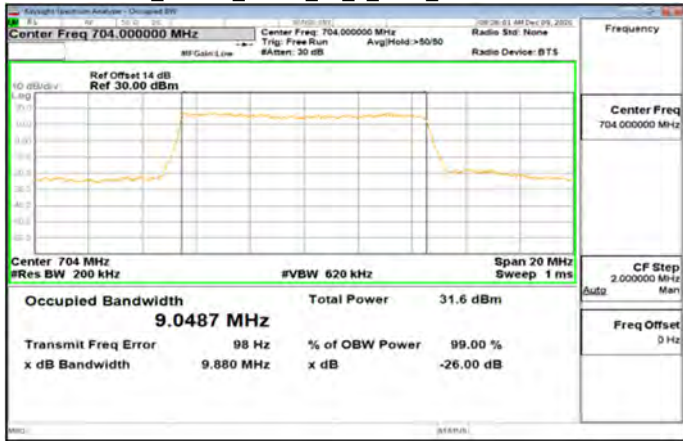

Band12_10MHz_16QAM_50_0_Main_LowCH23060-704

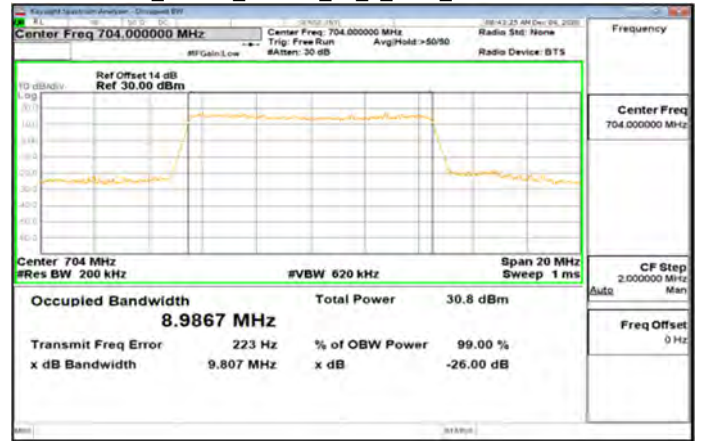

Band12_10MHz_QPSK_50_0_Main_MidCH23095-707.5

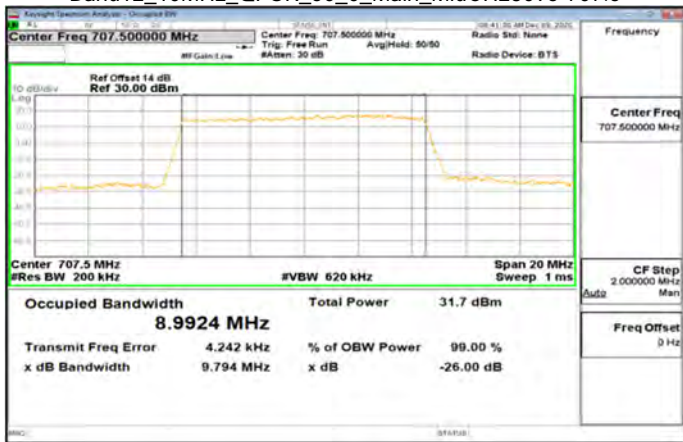

Band12_10MHz_16QAM_50_0_Main_MidCH23095-707.5

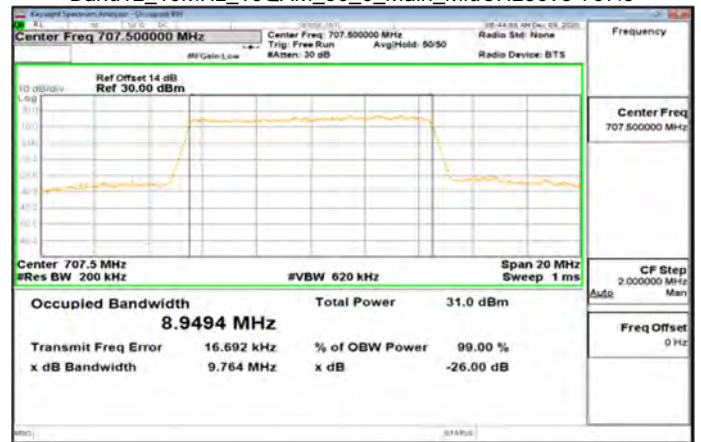

Band12_10MHz_QPSK_50_0_Main_HighCH23130-711

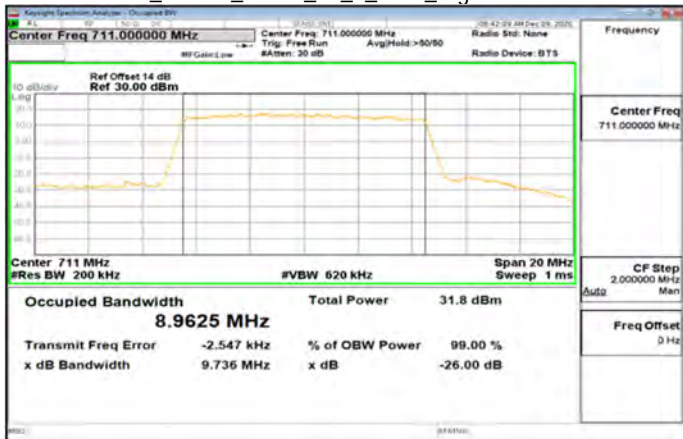

Band12_10MHz_16QAM_50_0_Main_HighCH23130-711

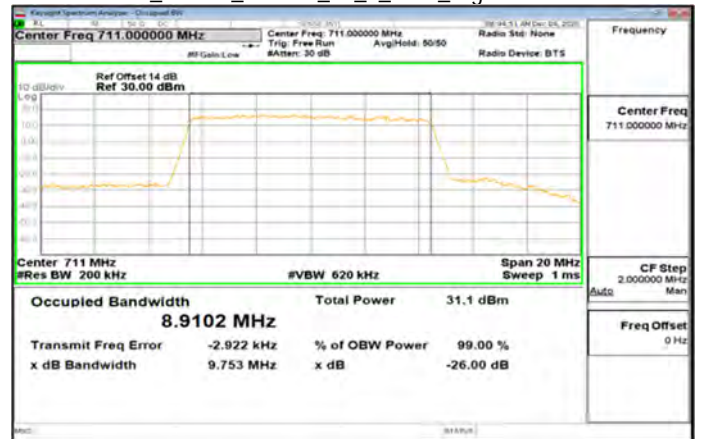

Unless otherwise stated the results shown in this test report refer only to the sample(s) tested and such sample(s) are retained for 90 days only.

除非另有說明，此報告結果僅對測試之樣品負責，同時此樣品僅保留90天。本報告未經本公司書面許可，不可部份複製。

This document is issued by the Company subject to its General Conditions of Service printed overleaf, available on request or accessible at <http://www.sgs.com.tw/Terms-and-Conditions> and for electronic format documents, subject to Terms and Conditions for Electronic Documents at <http://www.sgs.com.tw/Terms-and-Conditions>. Attention is drawn to the limitation of liability, indemnification and jurisdiction issues defined therein. Any holder of this document is advised that information contained herein reflects the Company's findings at the time of its intervention only and within the limits of Client's instructions, if any. The Company's sole responsibility is to its Client and this document does not exonerate parties to a transaction from exercising all their rights and obligations under the transaction documents. This document cannot be reproduced except in full, without prior written approval of the Company. Any unauthorized alteration, forgery or falsification of the content or appearance of this document is unlawful and offenders may be prosecuted to the fullest extent of the law.

Band12_10MHz_64QAM_50_0_Main_LowCH23060-704

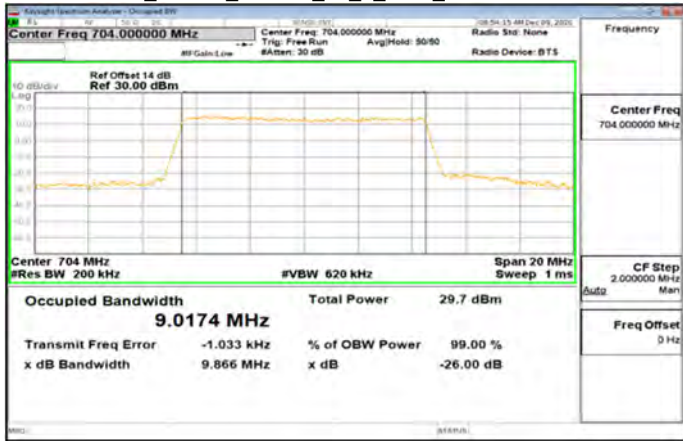

Band17_5MHz_QPSK_25_0_Main_LowCH23755-706.5

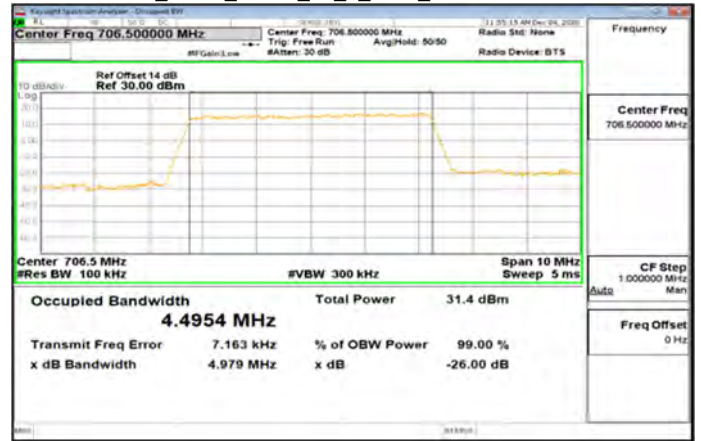

Band12_10MHz_64QAM_50_0_Main_MidCH23095-707.5

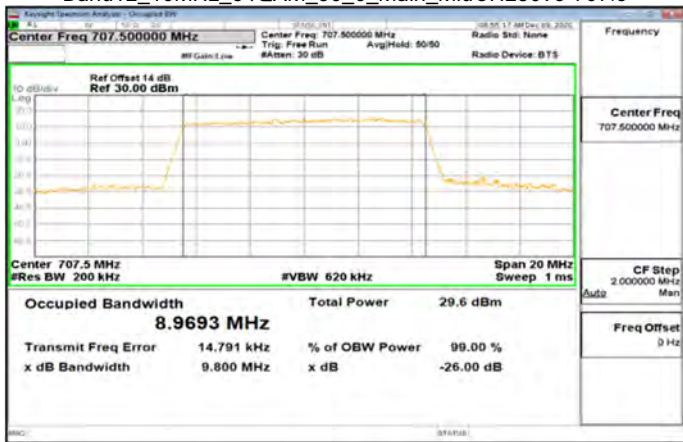

Band17_5MHz_QPSK_25_0_Main_MidCH23790-710

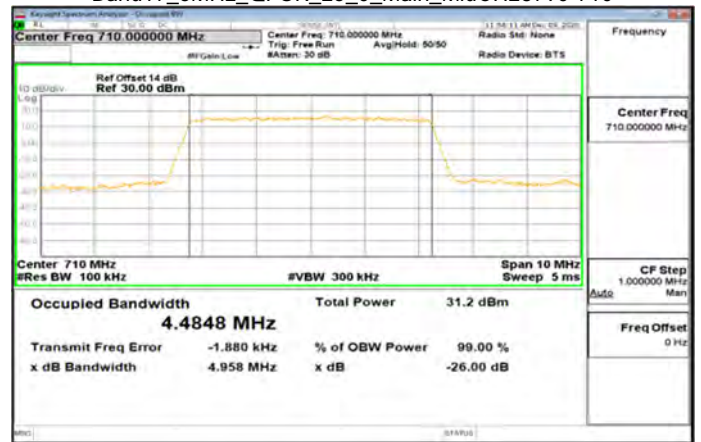

Band12_10MHz_64QAM_50_0_Main_HighCH23130-711

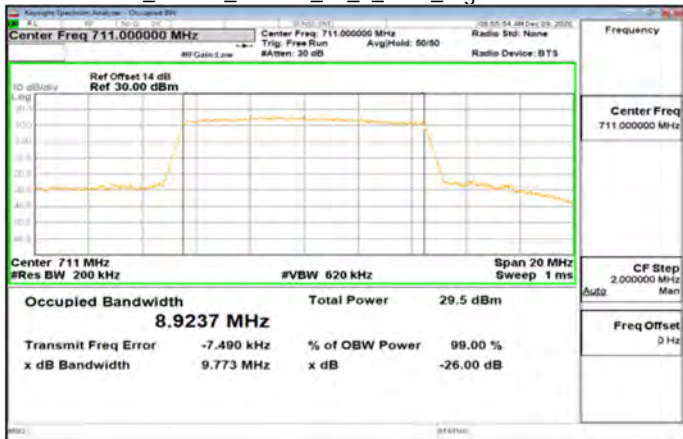

Band17_5MHz_QPSK_25_0_Main_HighCH23825-713.5

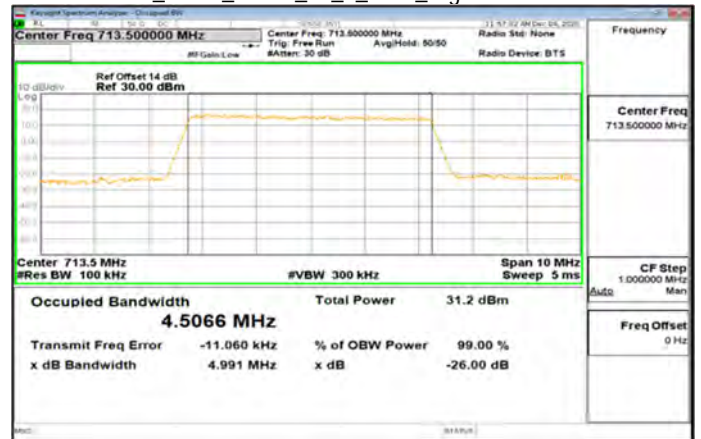

Unless otherwise stated the results shown in this test report refer only to the sample(s) tested and such sample(s) are retained for 90 days only.

除非另有說明，此報告結果僅對測試之樣品負責，同時此樣品僅保留90天。本報告未經本公司書面許可，不可部份複製。

This document is issued by the Company subject to its General Conditions of Service printed overleaf, available on request or accessible at <http://www.sgs.com.tw/Terms-and-Conditions> and for electronic format documents, subject to Terms and Conditions for Electronic Documents at <http://www.sgs.com.tw/Terms-and-Conditions>. Attention is drawn to the limitation of liability, indemnification and jurisdiction issues defined therein. Any holder of this document is advised that information contained herein reflects the Company's findings at the time of its intervention only and within the limits of Client's instructions, if any. The Company's sole responsibility is to its Client and this document does not exonerate parties to a transaction from exercising all their rights and obligations under the transaction documents. This document cannot be reproduced except in full, without prior written approval of the Company. Any unauthorized alteration, forgery or falsification of the content or appearance of this document is unlawful and offenders may be prosecuted to the fullest extent of the law.

Band17_5MHz_16QAM_25_0_Main_LowCH23755-706.5

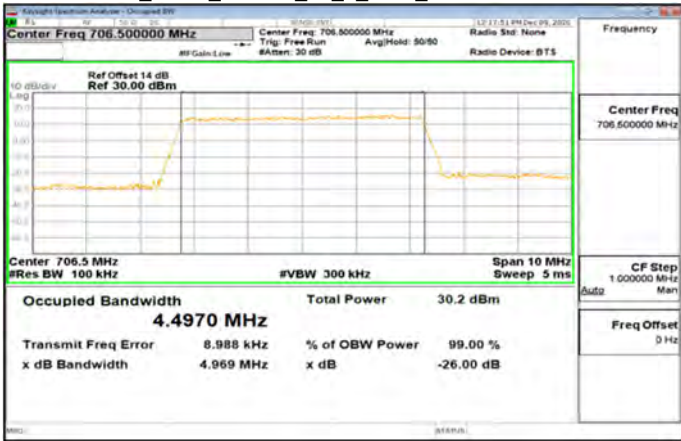

Band17_5MHz_64QAM_25_0_Main_LowCH23755-706.5

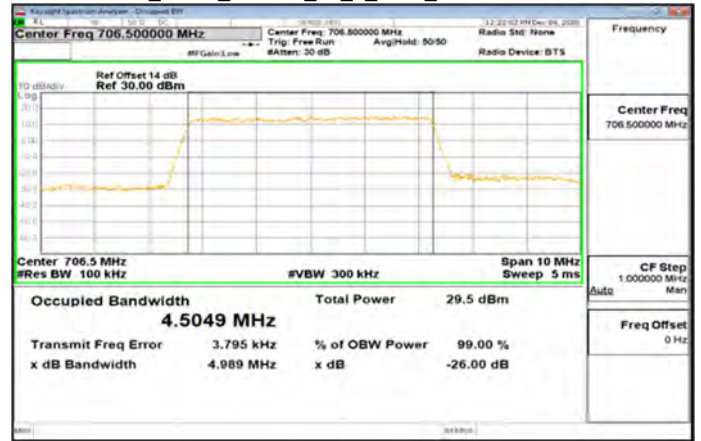

Band17_5MHz_16QAM_25_0_Main_MidCH23790-710

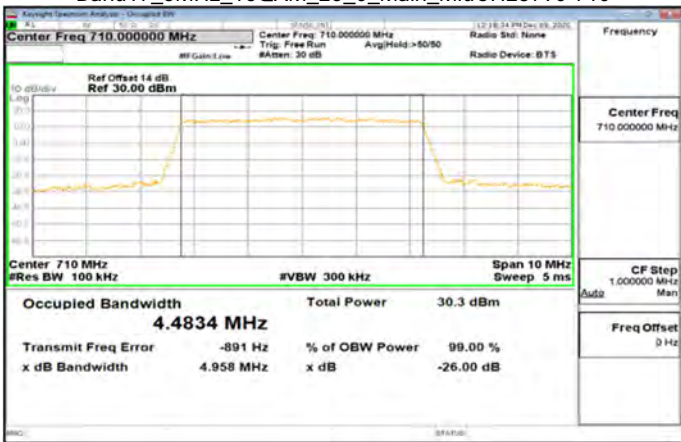

Band17_5MHz_64QAM_25_0_Main_MidCH23790-710

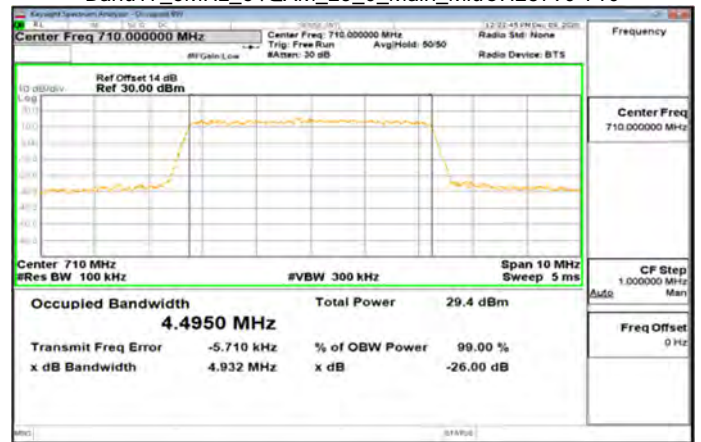

Band17_5MHz_16QAM_25_0_Main_HighCH23825-713.5

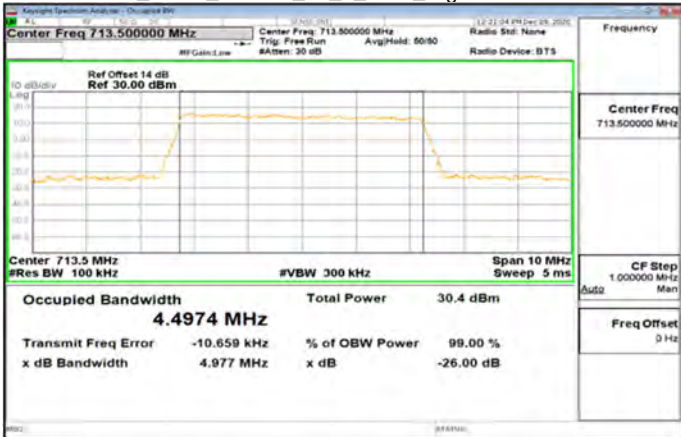

Band17_5MHz_64QAM_25_0_Main_HighCH23825-713.5

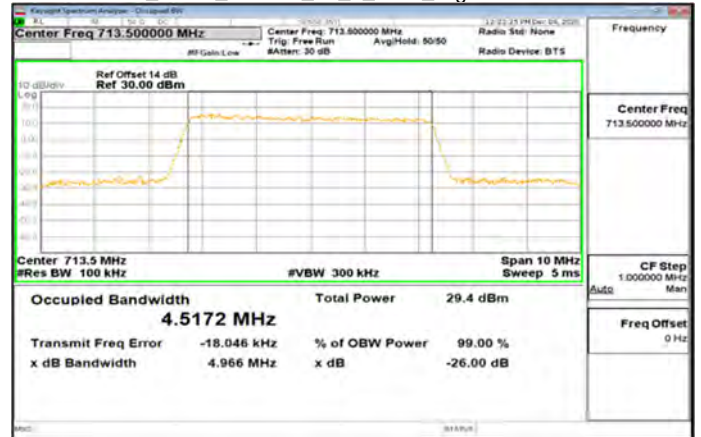

Unless otherwise stated the results shown in this test report refer only to the sample(s) tested and such sample(s) are retained for 90 days only.

除非另有說明，此報告結果僅對測試之樣品負責，同時此樣品僅保留90天。本報告未經本公司書面許可，不可部份複製。

This document is issued by the Company subject to its General Conditions of Service printed overleaf, available on request or accessible at <http://www.sgs.com.tw/Terms-and-Conditions> and for electronic format documents, subject to Terms and Conditions for Electronic Documents at <http://www.sgs.com.tw/Terms-and-Conditions>. Attention is drawn to the limitation of liability, indemnification and jurisdiction issues defined therein. Any holder of this document is advised that information contained herein reflects the Company's findings at the time of its intervention only and within the limits of Client's instructions, if any. The Company's sole responsibility is to its Client and this document does not exonerate parties to a transaction from exercising all their rights and obligations under the transaction documents. This document cannot be reproduced except in full, without prior written approval of the Company. Any unauthorized alteration, forgery or falsification of the content or appearance of this document is unlawful and offenders may be prosecuted to the fullest extent of the law.

Band17_10MHz_QPSK_50_0_Main_LowCH23780-709

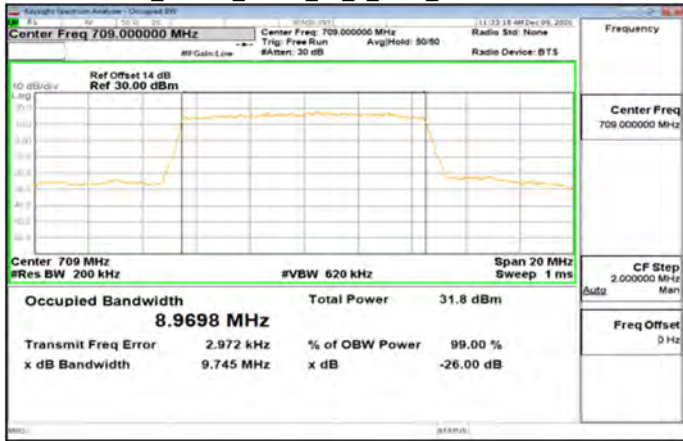

Band17_10MHz_16QAM_50_0_Main_LowCH23780-709

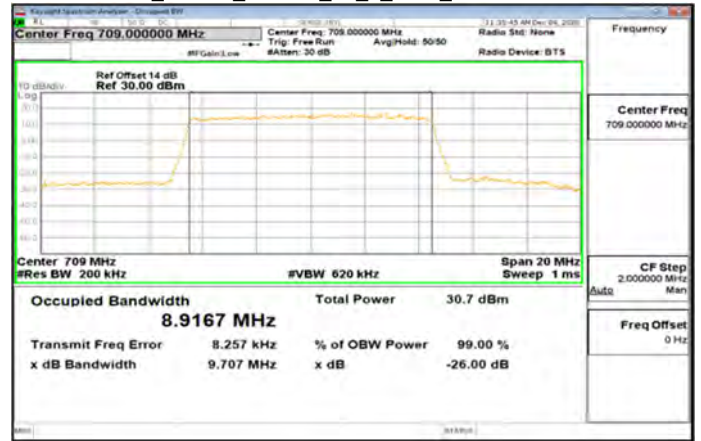

Band17_10MHz_QPSK_50_0_Main_MidCH23790-710

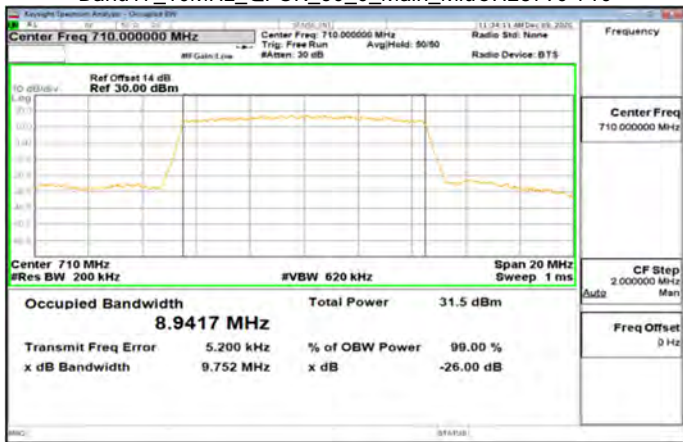

Band17_10MHz_16QAM_50_0_Main_MidCH23790-710

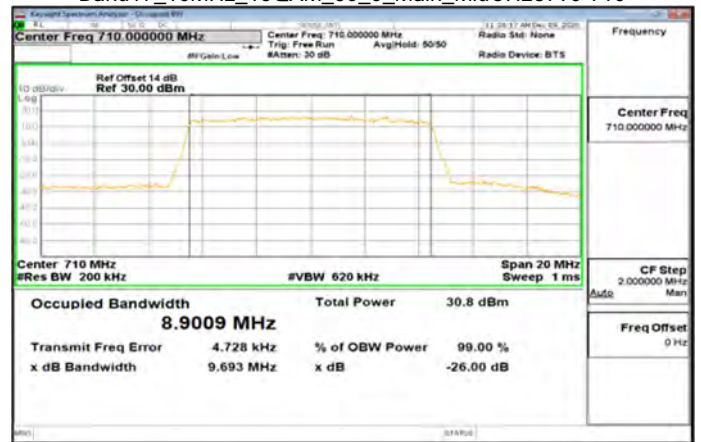

Band17_10MHz_QPSK_50_0_Main_HighCH23800-711

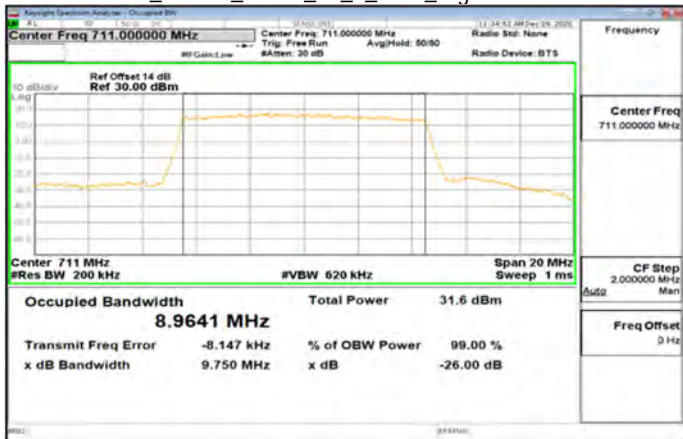

Band17_10MHz_16QAM_50_0_Main_HighCH23800-711

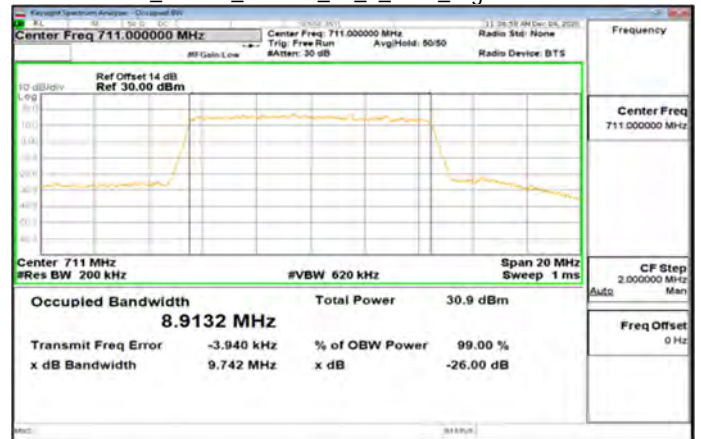

Unless otherwise stated the results shown in this test report refer only to the sample(s) tested and such sample(s) are retained for 90 days only.

除非另有說明，此報告結果僅對測試之樣品負責，同時此樣品僅保留90天。本報告未經本公司書面許可，不可部份複製。

This document is issued by the Company subject to its General Conditions of Service printed overleaf, available on request or accessible at <http://www.sgs.com.tw/Terms-and-Conditions> and for electronic format documents, subject to Terms and Conditions for Electronic Documents at <http://www.sgs.com.tw/Terms-and-Conditions>. Attention is drawn to the limitation of liability, indemnification and jurisdiction issues defined therein. Any holder of this document is advised that information contained herein reflects the Company's findings at the time of its intervention only and within the limits of Client's instructions, if any. The Company's sole responsibility is to its Client and this document does not exonerate parties to a transaction from exercising all their rights and obligations under the transaction documents. This document cannot be reproduced except in full, without prior written approval of the Company. Any unauthorized alteration, forgery or falsification of the content or appearance of this document is unlawful and offenders may be prosecuted to the fullest extent of the law.

Band17_10MHz_64QAM_50_0_Main_LowCH23780-709

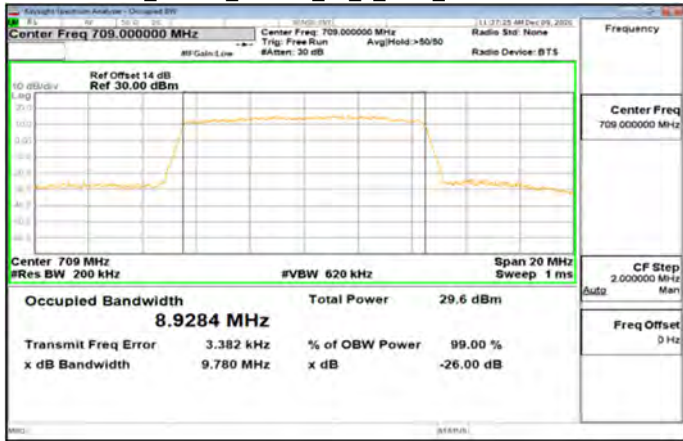

Band38_5MHz_QPSK_25_0_Main_LowCH37775-2572.5

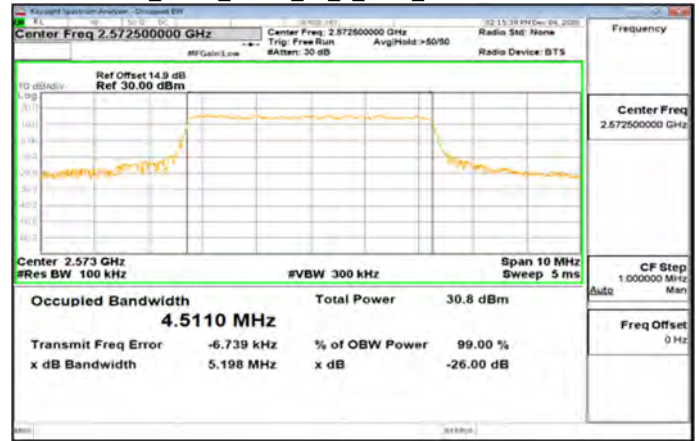

Band17_10MHz_64QAM_50_0_Main_MidCH23790-710

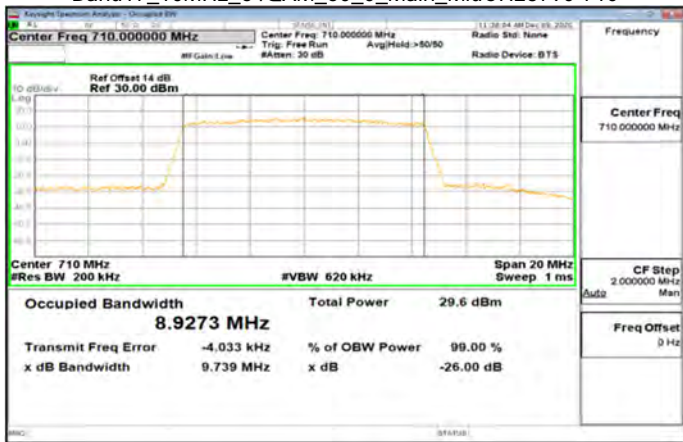

Band38_5MHz_QPSK_25_0_Main_MidCH38000-2595

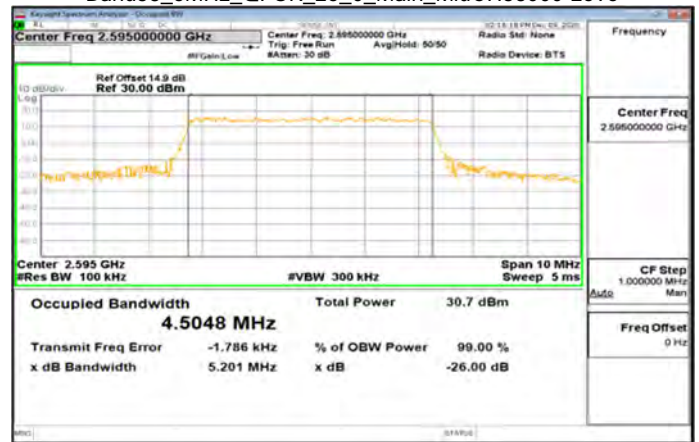

Band17_10MHz_64QAM_50_0_Main_HighCH23800-711

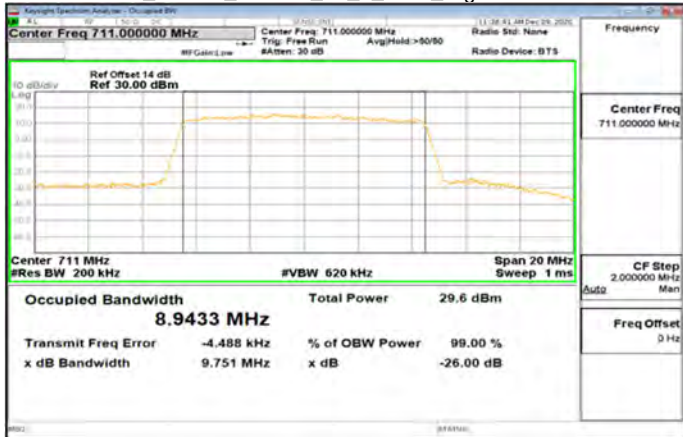

Band38_5MHz_QPSK_25_0_Main_HighCH38225-2617.5

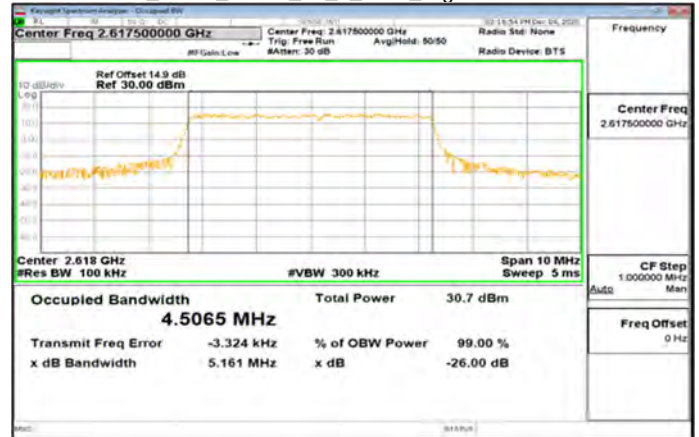

Unless otherwise stated the results shown in this test report refer only to the sample(s) tested and such sample(s) are retained for 90 days only.

除非另有說明，此報告結果僅對測試之樣品負責，同時此樣品僅保留90天。本報告未經本公司書面許可，不可部份複製。

This document is issued by the Company subject to its General Conditions of Service printed overleaf, available on request or accessible at <http://www.sgs.com.tw/Terms-and-Conditions> and for electronic format documents, subject to Terms and Conditions for Electronic Documents at <http://www.sgs.com.tw/Terms-and-Conditions>. Attention is drawn to the limitation of liability, indemnification and jurisdiction issues defined therein. Any holder of this document is advised that information contained herein reflects the Company's findings at the time of its intervention only and within the limits of Client's instructions, if any. The Company's sole responsibility is to its Client and this document does not exonerate parties to a transaction from exercising all their rights and obligations under the transaction documents. This document cannot be reproduced except in full, without prior written approval of the Company. Any unauthorized alteration, forgery or falsification of the content or appearance of this document is unlawful and offenders may be prosecuted to the fullest extent of the law.

Band38_5MHz_16QAM_25_0_Main_LowCH37775-2572.5

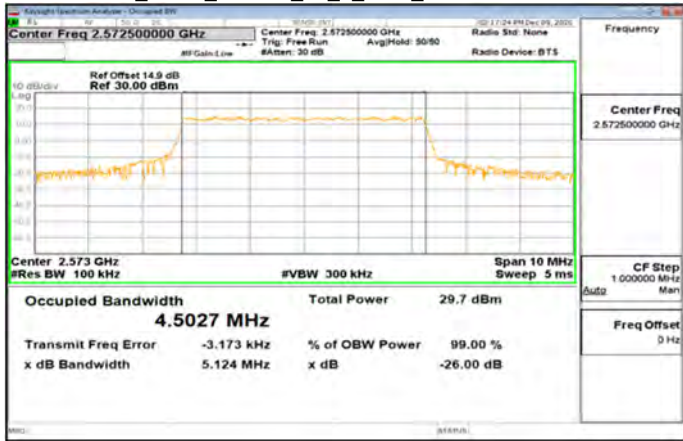

Band38_5MHz_64QAM_25_0_Main_LowCH37775-2572.5

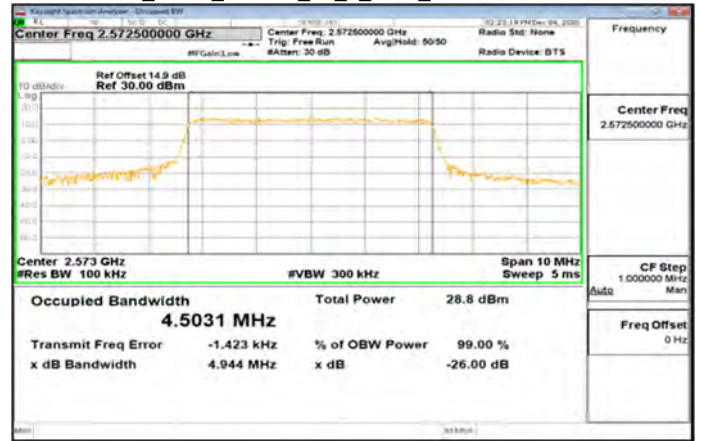

Band38_5MHz_16QAM_25_0_Main_MidCH38000-2595

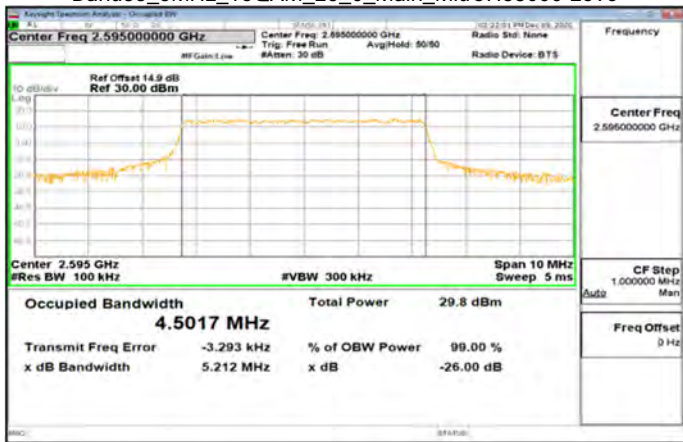

Band38_5MHz_64QAM_25_0_Main_MidCH38000-2595

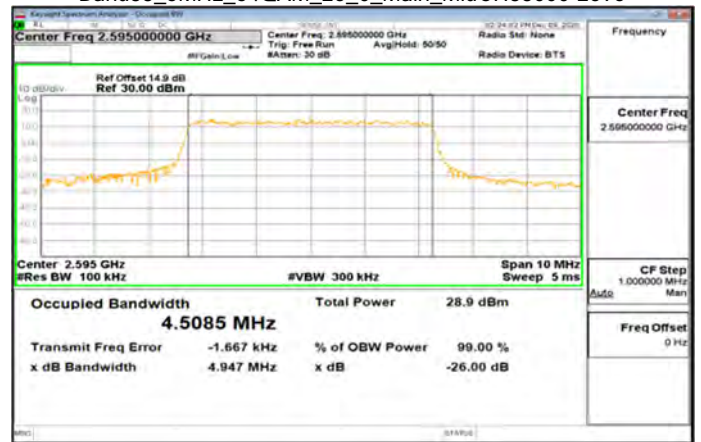

Band38_5MHz_16QAM_25_0_Main_HighCH38225-2617.5

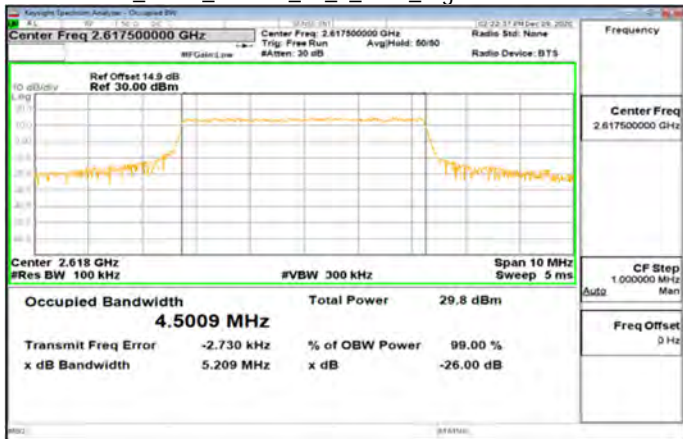

Band38_5MHz_64QAM_25_0_Main_HighCH38225-2617.5

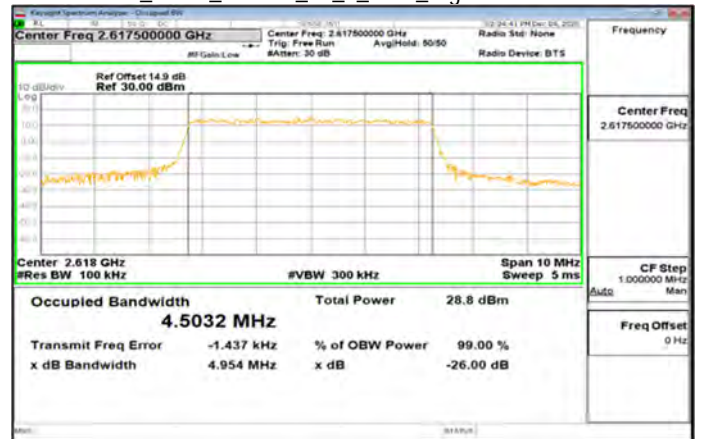

Unless otherwise stated the results shown in this test report refer only to the sample(s) tested and such sample(s) are retained for 90 days only.

除非另有說明，此報告結果僅對測試之樣品負責，同時此樣品僅保留90天。本報告未經本公司書面許可，不可部份複製。

This document is issued by the Company subject to its General Conditions of Service printed overleaf, available on request or accessible at <http://www.sgs.com.tw/Terms-and-Conditions> and for electronic format documents, subject to Terms and Conditions for Electronic Documents at <http://www.sgs.com.tw/Terms-and-Conditions>. Attention is drawn to the limitation of liability, indemnification and jurisdiction issues defined therein. Any holder of this document is advised that information contained herein reflects the Company's findings at the time of its intervention only and within the limits of Client's instructions, if any. The Company's sole responsibility is to its Client and this document does not exonerate parties to a transaction from exercising all their rights and obligations under the transaction documents. This document cannot be reproduced except in full, without prior written approval of the Company. Any unauthorized alteration, forgery or falsification of the content or appearance of this document is unlawful and offenders may be prosecuted to the fullest extent of the law.

Band38_10MHz_QPSK_50_0_Main_LowCH37800-2575

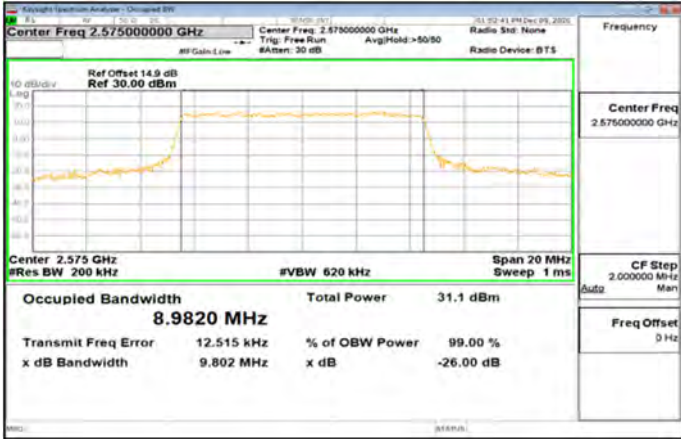

Band38_10MHz_16QAM_50_0_Main_LowCH37800-2575



Band38_10MHz_QPSK_50_0_Main_MidCH38000-2595

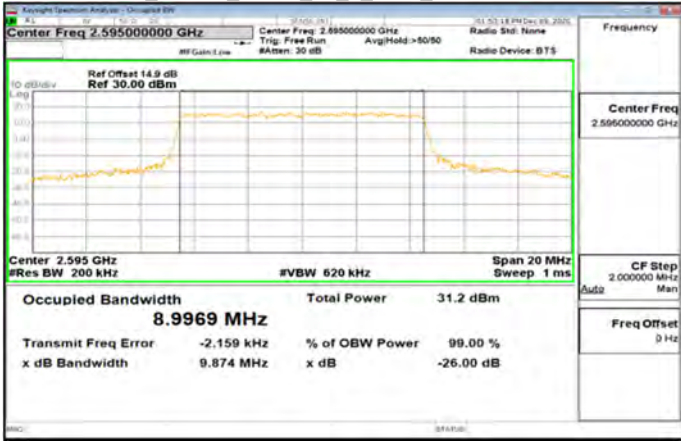

Band38_10MHz_16QAM_50_0_Main_MidCH38000-2595

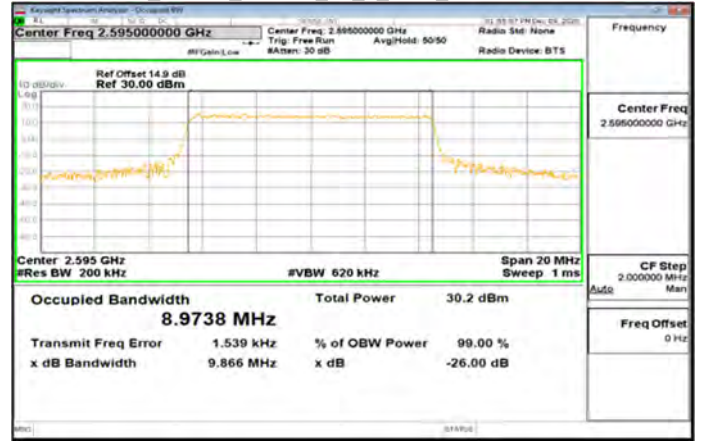

Band38_10MHz_QPSK_50_0_Main_HighCH38200-2615

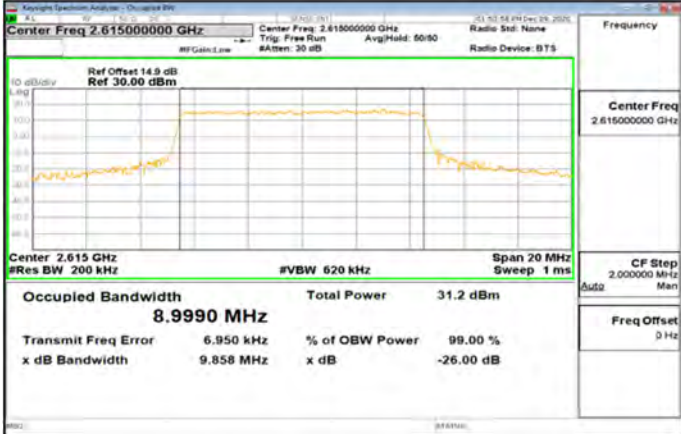

Band38_10MHz_16QAM_50_0_Main_HighCH38200-2615

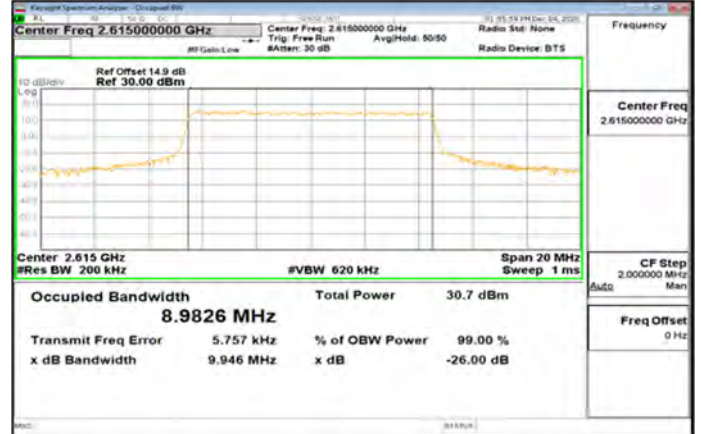

Unless otherwise stated the results shown in this test report refer only to the sample(s) tested and such sample(s) are retained for 90 days only.

除非另有說明，此報告結果僅對測試之樣品負責，同時此樣品僅保留90天。本報告未經本公司書面許可，不可部份複製。

This document is issued by the Company subject to its General Conditions of Service printed overleaf, available on request or accessible at <http://www.sgs.com.tw/Terms-and-Conditions> and for electronic format documents, subject to Terms and Conditions for Electronic Documents at <http://www.sgs.com.tw/Terms-and-Conditions>. Attention is drawn to the limitation of liability, indemnification and jurisdiction issues defined therein. Any holder of this document is advised that information contained herein reflects the Company's findings at the time of its intervention only and within the limits of Client's instructions, if any. The Company's sole responsibility is to its Client and this document does not exonerate parties to a transaction from exercising all their rights and obligations under the transaction documents. This document cannot be reproduced except in full, without prior written approval of the Company. Any unauthorized alteration, forgery or falsification of the content or appearance of this document is unlawful and offenders may be prosecuted to the fullest extent of the law.

Band38_10MHz_64QAM_50_0_Main_LowCH37800-2575

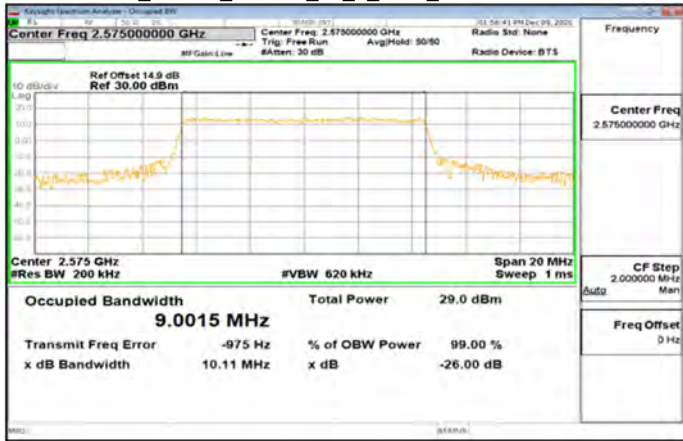

Band38_15MHz_QPSK_75_0_Main_LowCH37825-2577.5

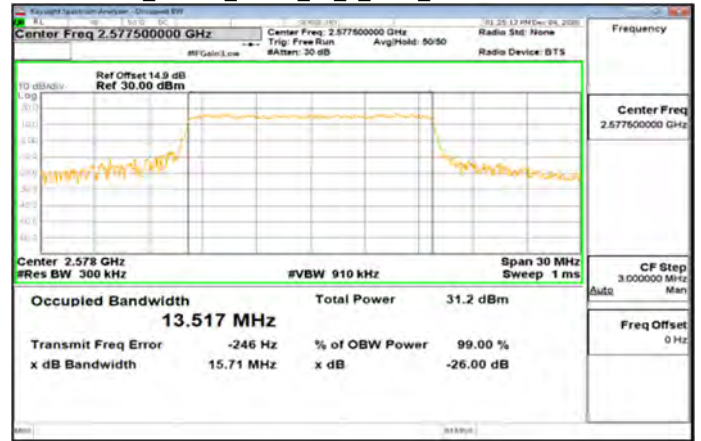

Band38_10MHz_64QAM_50_0_Main_MidCH38000-2595

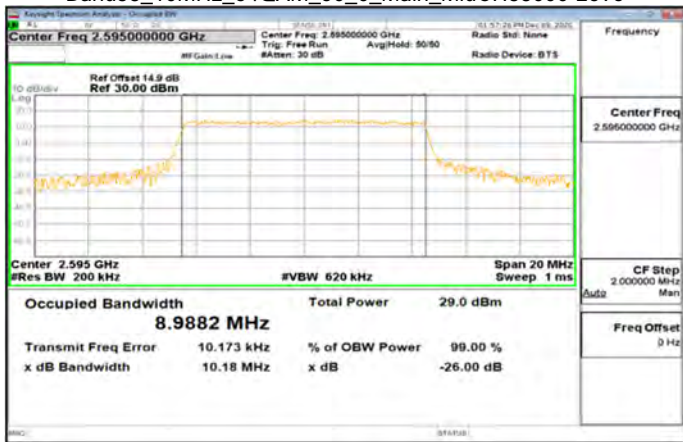

Band38_15MHz_QPSK_75_0_Main_MidCH38000-2595

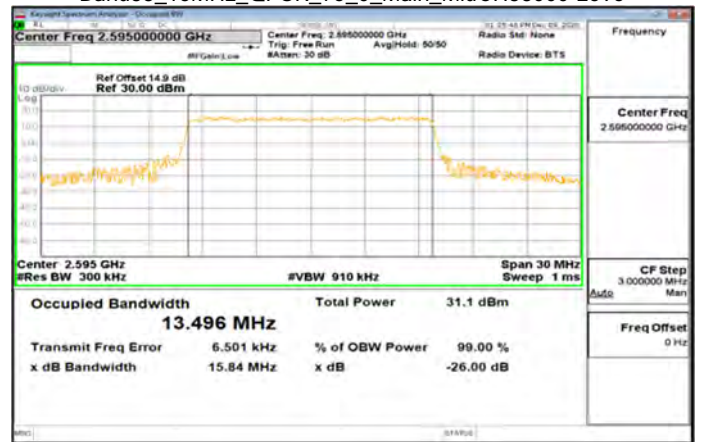

Band38_10MHz_64QAM_50_0_Main_HighCH38200-2615

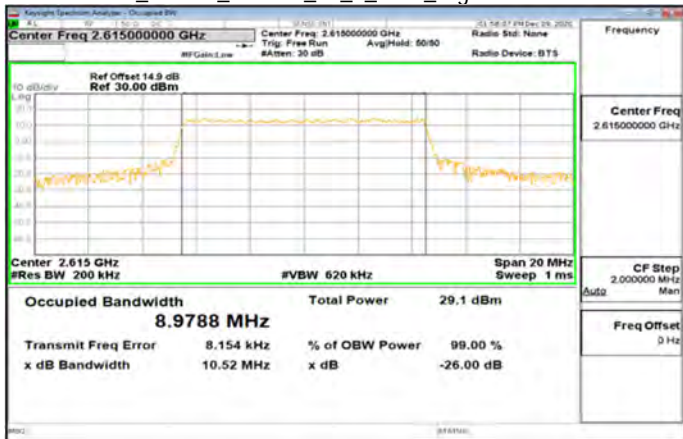

Band38_15MHz_QPSK_75_0_Main_HighCH38175-2612.5

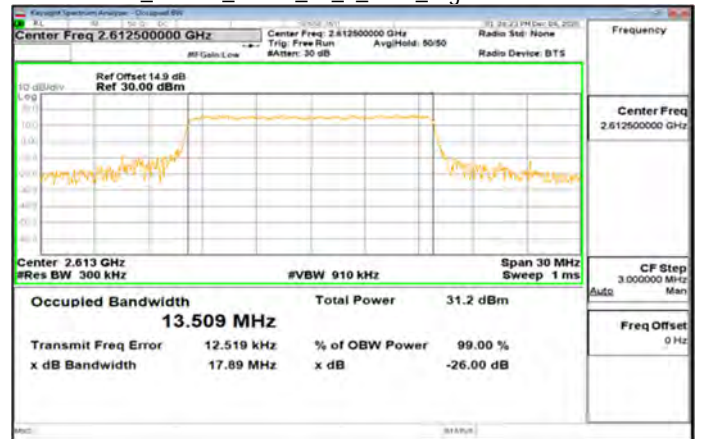

Unless otherwise stated the results shown in this test report refer only to the sample(s) tested and such sample(s) are retained for 90 days only.

除非另有說明，此報告結果僅對測試之樣品負責，同時此樣品僅保留90天。本報告未經本公司書面許可，不可部份複製。

This document is issued by the Company subject to its General Conditions of Service printed overleaf, available on request or accessible at <http://www.sgs.com.tw/Terms-and-Conditions> and for electronic format documents, subject to Terms and Conditions for Electronic Documents at <http://www.sgs.com.tw/Terms-and-Conditions>. Attention is drawn to the limitation of liability, indemnification and jurisdiction issues defined therein. Any holder of this document is advised that information contained herein reflects the Company's findings at the time of its intervention only and within the limits of Client's instructions, if any. The Company's sole responsibility is to its Client and this document does not exonerate parties to a transaction from exercising all their rights and obligations under the transaction documents. This document cannot be reproduced except in full, without prior written approval of the Company. Any unauthorized alteration, forgery or falsification of the content or appearance of this document is unlawful and offenders may be prosecuted to the fullest extent of the law.

Band38_15MHz_16QAM_75_0_Main_LowCH37825-2577.5

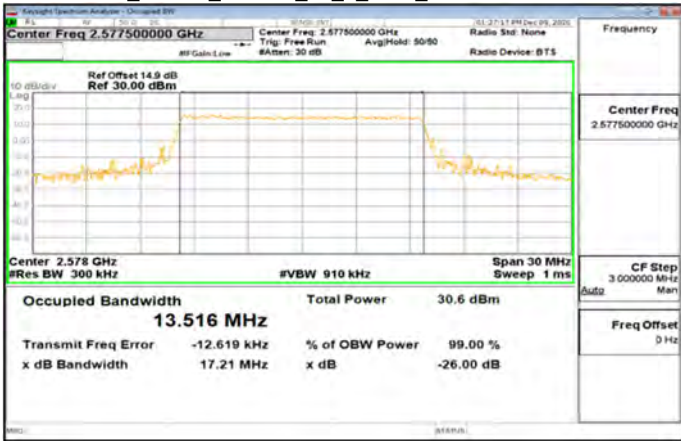

Band38_15MHz_64QAM_75_0_Main_LowCH37825-2577.5

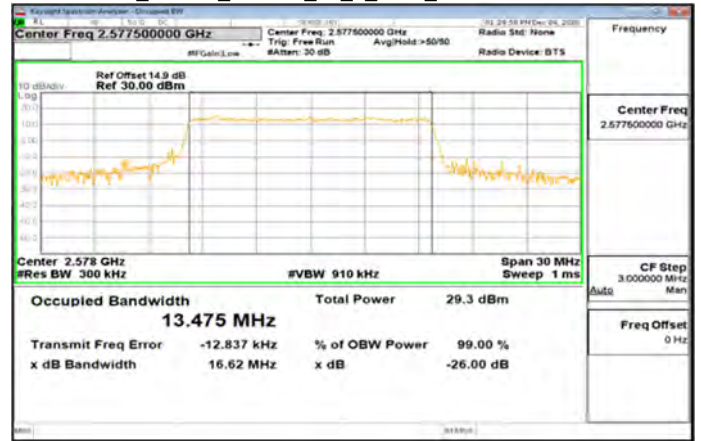

Band38_15MHz_16QAM_75_0_Main_MidCH38000-2595

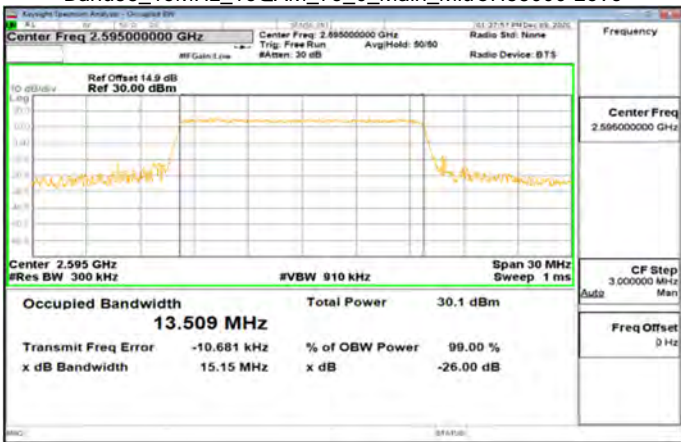

Band38_15MHz_64QAM_75_0_Main_MidCH38000-2595

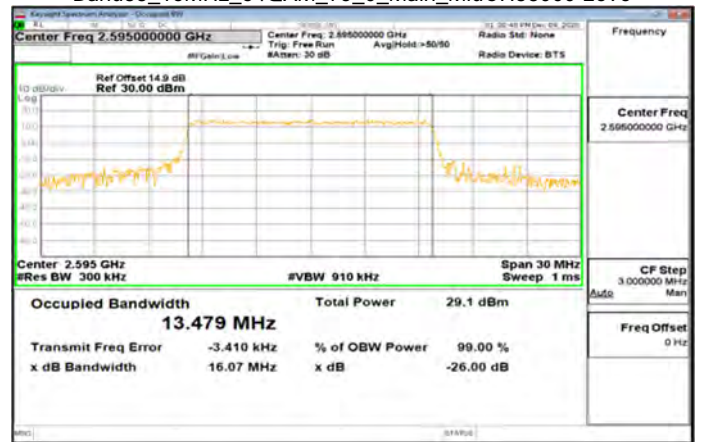

Band38_15MHz_16QAM_75_0_Main_HighCH38175-2612.5

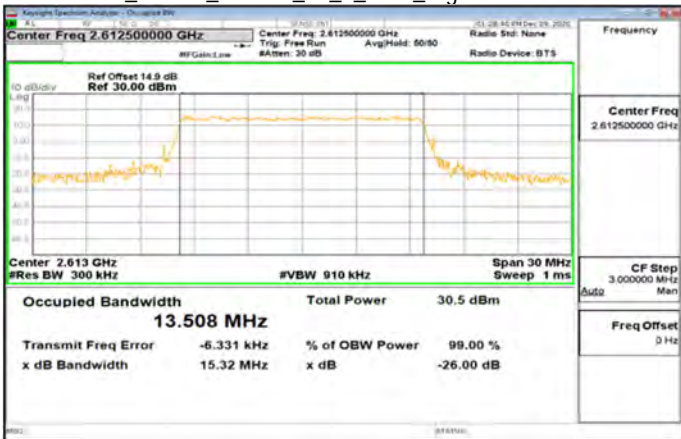

Band38_15MHz_64QAM_75_0_Main_HighCH38175-2612.5

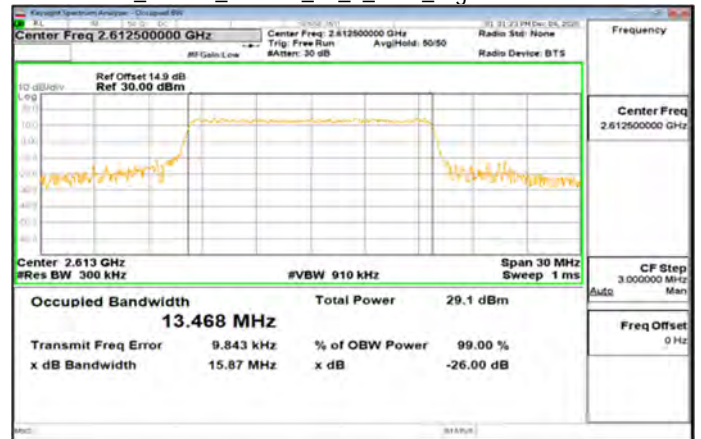

Unless otherwise stated the results shown in this test report refer only to the sample(s) tested and such sample(s) are retained for 90 days only.

除非另有說明，此報告結果僅對測試之樣品負責，同時此樣品僅保留90天。本報告未經本公司書面許可，不可部份複製。

This document is issued by the Company subject to its General Conditions of Service printed overleaf, available on request or accessible at <http://www.sgs.com.tw/Terms-and-Conditions> and for electronic format documents, subject to Terms and Conditions for Electronic Documents at <http://www.sgs.com.tw/Terms-and-Conditions>. Attention is drawn to the limitation of liability, indemnification and jurisdiction issues defined therein. Any holder of this document is advised that information contained herein reflects the Company's findings at the time of its intervention only and within the limits of Client's instructions, if any. The Company's sole responsibility is to its Client and this document does not exonerate parties to a transaction from exercising all their rights and obligations under the transaction documents. This document cannot be reproduced except in full, without prior written approval of the Company. Any unauthorized alteration, forgery or falsification of the content or appearance of this document is unlawful and offenders may be prosecuted to the fullest extent of the law.

Band38_20MHz_QPSK_100_0_Main_LowCH37850-2580

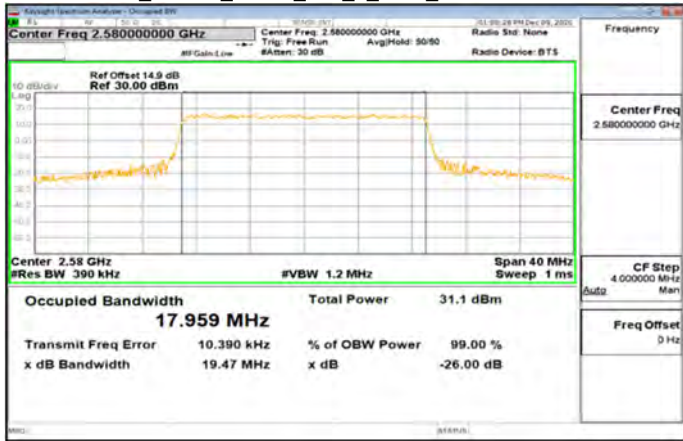

Band38_20MHz_16QAM_100_0_Main_LowCH37850-2580

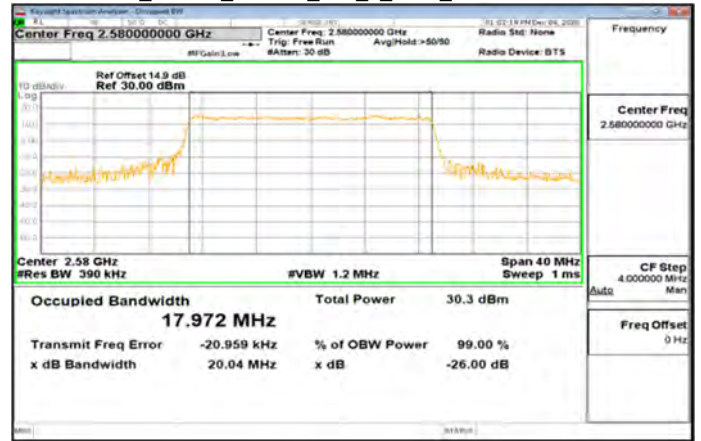

Band38_20MHz_QPSK_100_0_Main_MidCH38000-2595

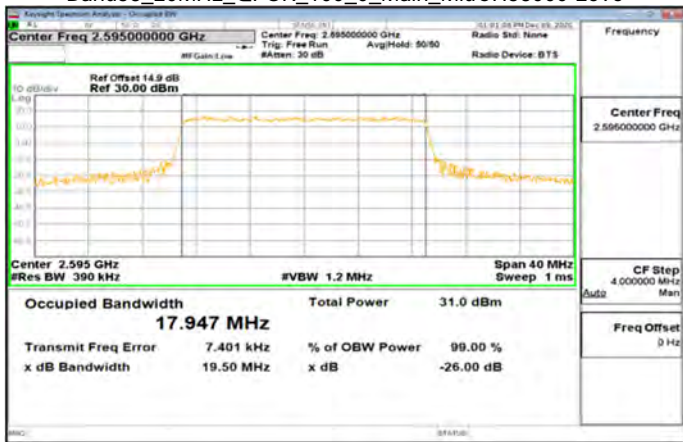

Band38_20MHz_16QAM_100_0_Main_MidCH38000-2595

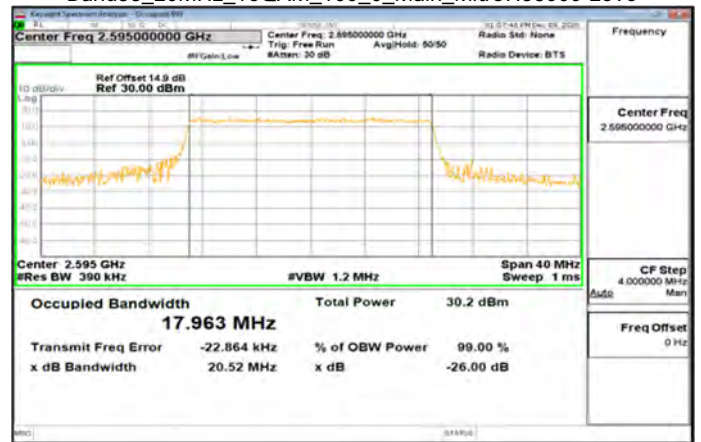

Band38_20MHz_QPSK_100_0_Main_HighCH38150-2610

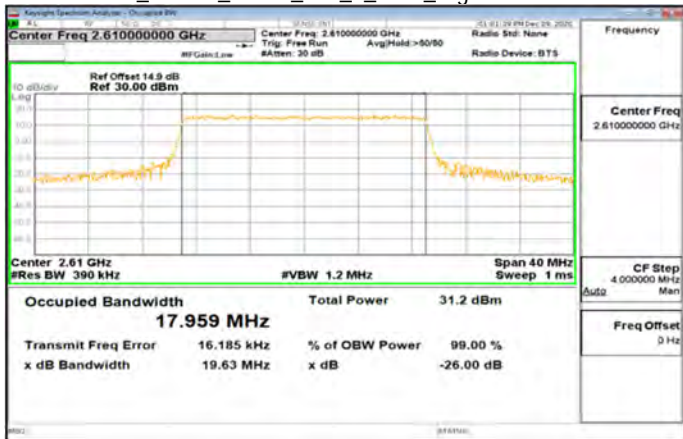

Band38_20MHz_16QAM_100_0_Main_HighCH38150-2610

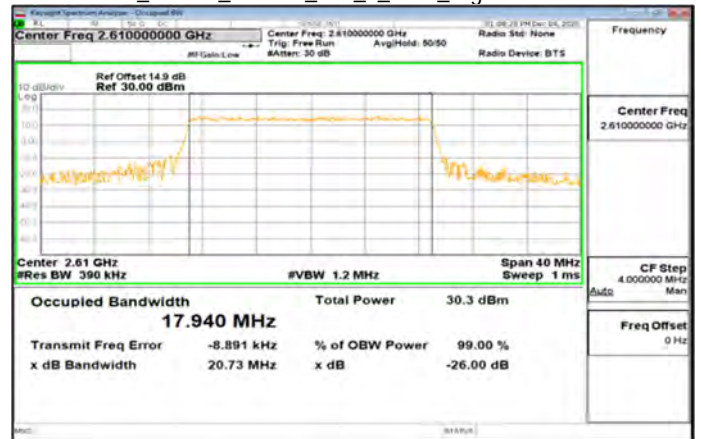

Unless otherwise stated the results shown in this test report refer only to the sample(s) tested and such sample(s) are retained for 90 days only.

除非另有說明，此報告結果僅對測試之樣品負責，同時此樣品僅保留90天。本報告未經本公司書面許可，不可部份複製。

This document is issued by the Company subject to its General Conditions of Service printed overleaf, available on request or accessible at <http://www.sgs.com.tw/Terms-and-Conditions> and for electronic format documents, subject to Terms and Conditions for Electronic Documents at <http://www.sgs.com.tw/Terms-and-Conditions>. Attention is drawn to the limitation of liability, indemnification and jurisdiction issues defined therein. Any holder of this document is advised that information contained herein reflects the Company's findings at the time of its intervention only and within the limits of Client's instructions, if any. The Company's sole responsibility is to its Client and this document does not exonerate parties to a transaction from exercising all their rights and obligations under the transaction documents. This document cannot be reproduced except in full, without prior written approval of the Company. Any unauthorized alteration, forgery or falsification of the content or appearance of this document is unlawful and offenders may be prosecuted to the fullest extent of the law.

Band38_20MHz_64QAM_100_0_Main_LowCH37850-2580

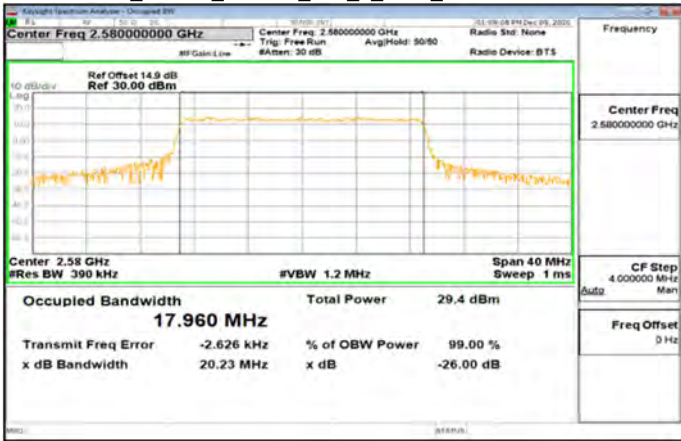

Band41_5MHz_QPSK_25_0_Main_LowCH39675-2498.5

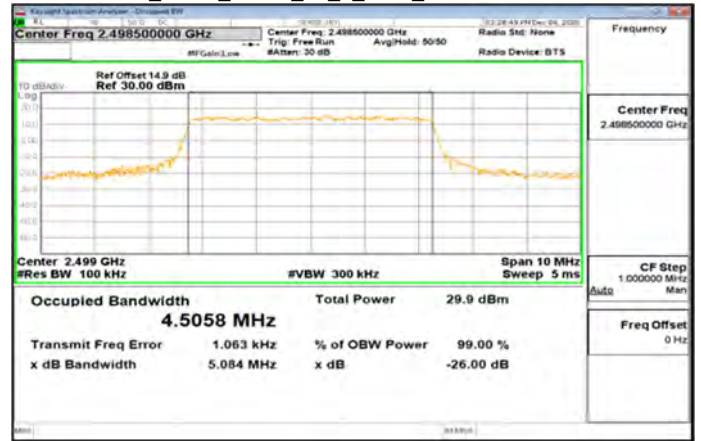

Band38_20MHz_64QAM_100_0_Main_MidCH38000-2595

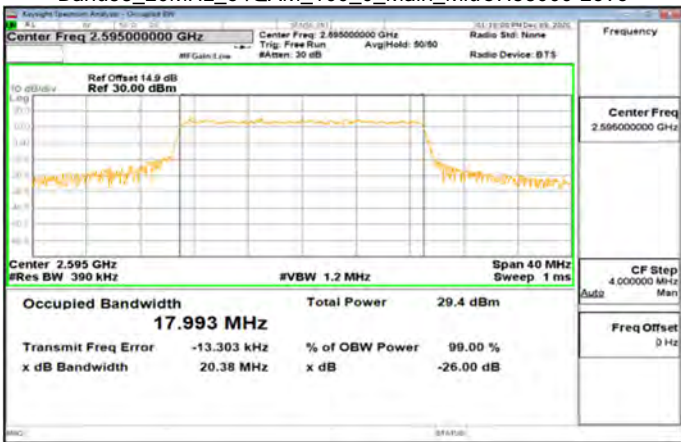

Band41_5MHz_QPSK_25_0_Main_MidCH40620-2593

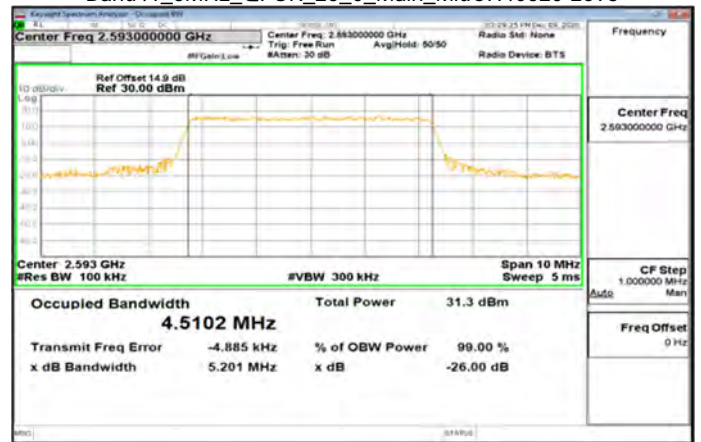

Band38_20MHz_64QAM_100_0_Main_HighCH38150-2610

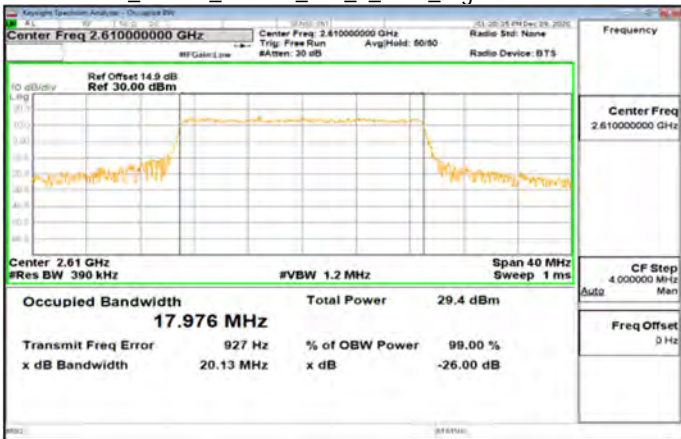

Band41_5MHz_QPSK_25_0_Main_HighCH41565-2687.5

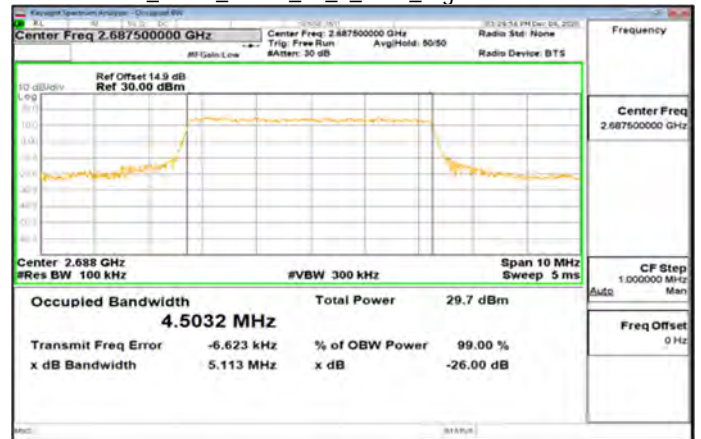

Unless otherwise stated, the results shown in this test report refer only to the sample(s) tested and such sample(s) are retained for 90 days only.

除非另有說明，此報告結果僅對測試之樣品負責，同時此樣品僅保留90天。本報告未經本公司書面許可，不可部份複製。

This document is issued by the Company subject to its General Conditions of Service printed overleaf, available on request or accessible at <http://www.sgs.com.tw/Terms-and-Conditions> and for electronic format documents, subject to Terms and Conditions for Electronic Documents at <http://www.sgs.com.tw/Terms-and-Conditions>. Attention is drawn to the limitation of liability, indemnification and jurisdiction issues defined therein. Any holder of this document is advised that information contained herein reflects the Company's findings at the time of its intervention only and within the limits of Client's instructions, if any. The Company's sole responsibility is to its Client and this document does not exonerate parties to a transaction from exercising all their rights and obligations under the transaction documents. This document cannot be reproduced except in full, without prior written approval of the Company. Any unauthorized alteration, forgery or falsification of the content or appearance of this document is unlawful and offenders may be prosecuted to the fullest extent of the law.

Band41_5MHz_16QAM_25_0_Main_LowCH39675-2498.5

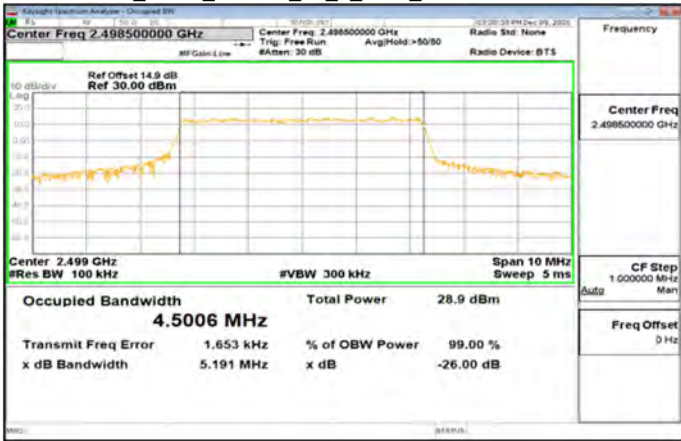

Band41_5MHz_64QAM_25_0_Main_LowCH39675-2498.5

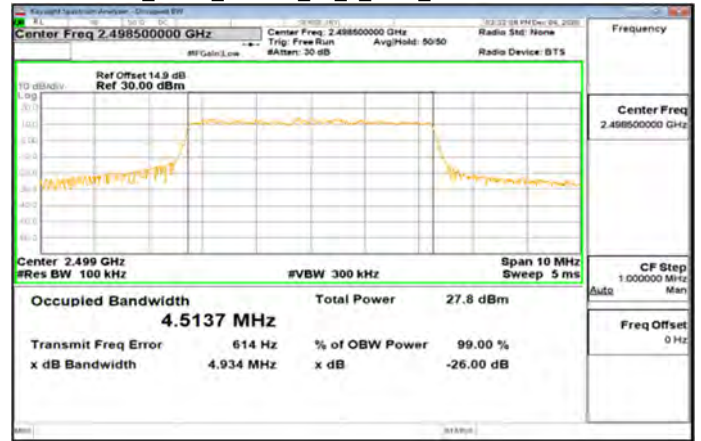

Band41_5MHz_16QAM_25_0_Main_MidCH40620-2593

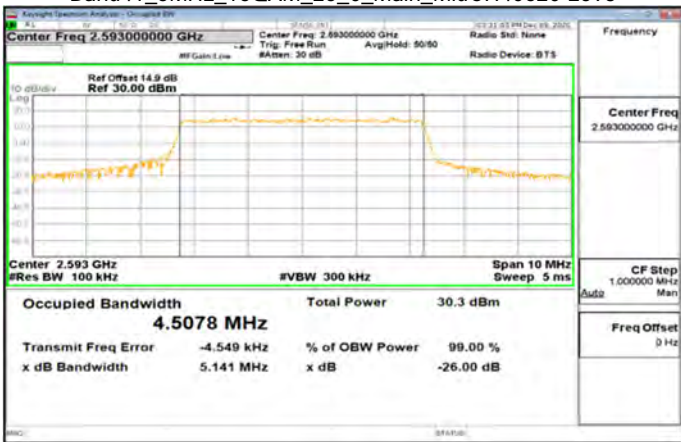

Band41_5MHz_64QAM_25_0_Main_MidCH40620-2593

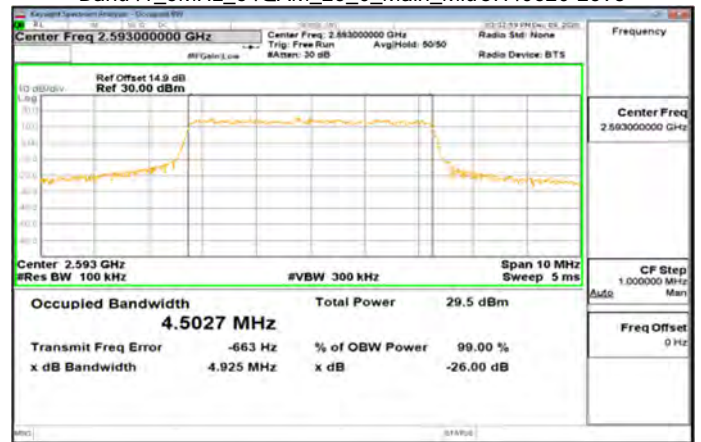

Band41_5MHz_16QAM_25_0_Main_HighCH41565-2687.5

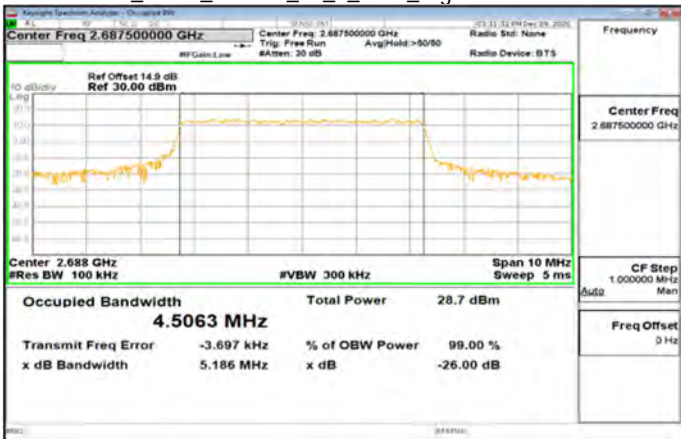

Band41_5MHz_64QAM_25_0_Main_HighCH41565-2687.5

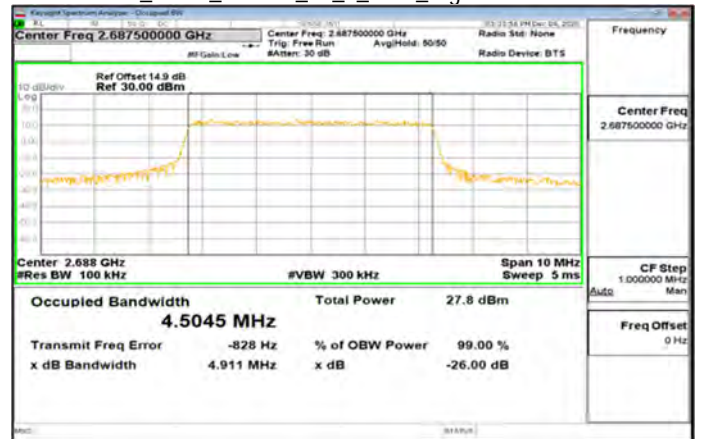

Unless otherwise stated the results shown in this test report refer only to the sample(s) tested and such sample(s) are retained for 90 days only.

除非另有說明，此報告結果僅對測試之樣品負責，同時此樣品僅保留90天。本報告未經本公司書面許可，不可部份複製。

This document is issued by the Company subject to its General Conditions of Service printed overleaf, available on request or accessible at <http://www.sgs.com.tw/Terms-and-Conditions> and for electronic format documents, subject to Terms and Conditions for Electronic Documents at <http://www.sgs.com.tw/Terms-and-Conditions>. Attention is drawn to the limitation of liability, indemnification and jurisdiction issues defined therein. Any holder of this document is advised that information contained herein reflects the Company's findings at the time of its intervention only and within the limits of Client's instructions, if any. The Company's sole responsibility is to its Client and this document does not exonerate parties to a transaction from exercising all their rights and obligations under the transaction documents. This document cannot be reproduced except in full, without prior written approval of the Company. Any unauthorized alteration, forgery or falsification of the content or appearance of this document is unlawful and offenders may be prosecuted to the fullest extent of the law.

Band41_10MHz_QPSK_50_0_Main_LowCH39700-2501



Band41_10MHz_16QAM_50_0_Main_LowCH39700-2501

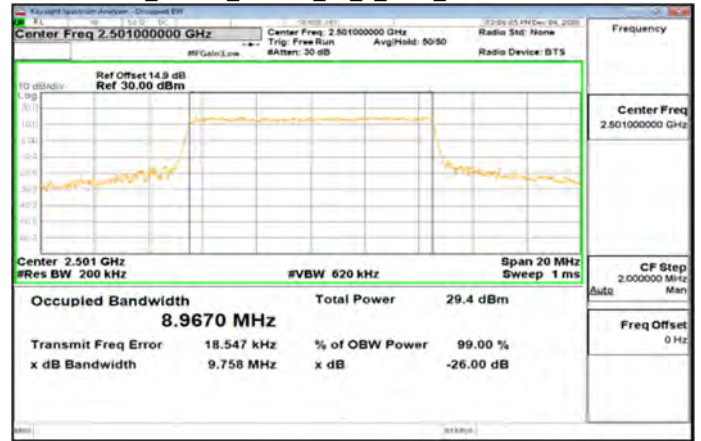

Band41_10MHz_QPSK_50_0_Main_MidCH40620-2593

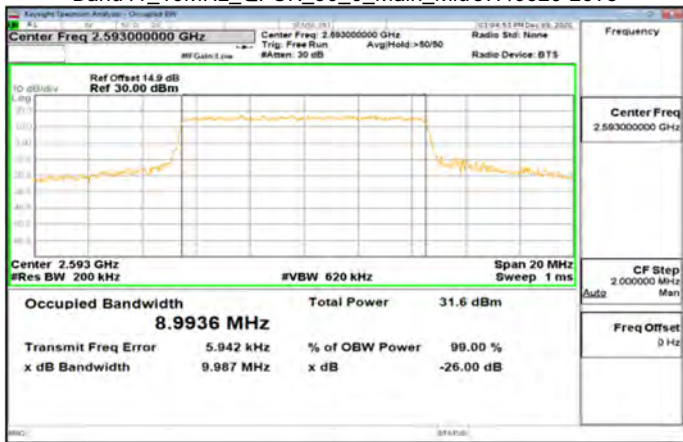

Band41_10MHz_16QAM_50_0_Main_MidCH40620-2593

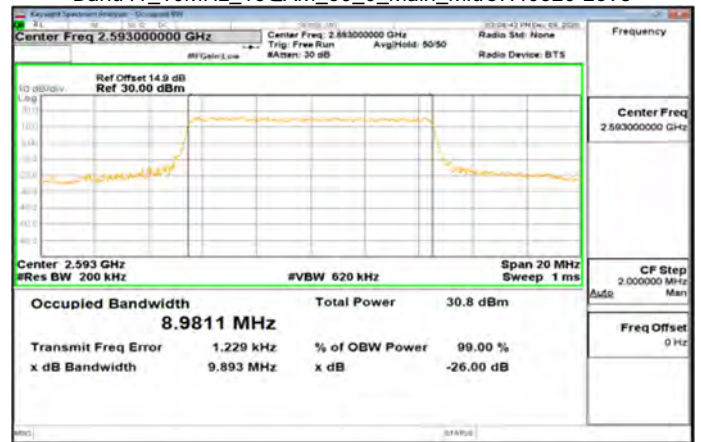

Band41_10MHz_QPSK_50_0_Main_HighCH41540-2685

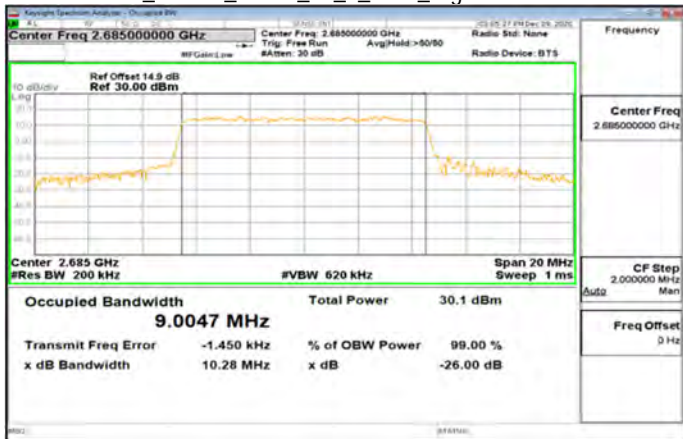

Band41_10MHz_16QAM_50_0_Main_HighCH41540-2685

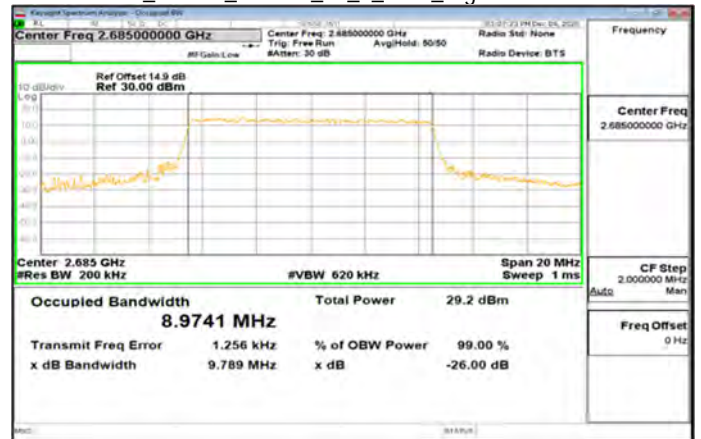

Unless otherwise stated the results shown in this test report refer only to the sample(s) tested and such sample(s) are retained for 90 days only.

除非另有說明，此報告結果僅對測試之樣品負責，同時此樣品僅保留90天。本報告未經本公司書面許可，不可部份複製。

This document is issued by the Company subject to its General Conditions of Service printed overleaf, available on request or accessible at <http://www.sgs.com.tw/Terms-and-Conditions> and for electronic format documents, subject to Terms and Conditions for Electronic Documents at <http://www.sgs.com.tw/Terms-and-Conditions>. Attention is drawn to the limitation of liability, indemnification and jurisdiction issues defined therein. Any holder of this document is advised that information contained hereon reflects the Company's findings at the time of its intervention only and within the limits of Client's instructions, if any. The Company's sole responsibility is to its Client and this document does not exonerate parties to a transaction from exercising all their rights and obligations under the transaction documents. This document cannot be reproduced except in full, without prior written approval of the Company. Any unauthorized alteration, forgery or falsification of the content or appearance of this document is unlawful and offenders may be prosecuted to the fullest extent of the law.

Band41_10MHz_64QAM_50_0_Main_LowCH39700-2501

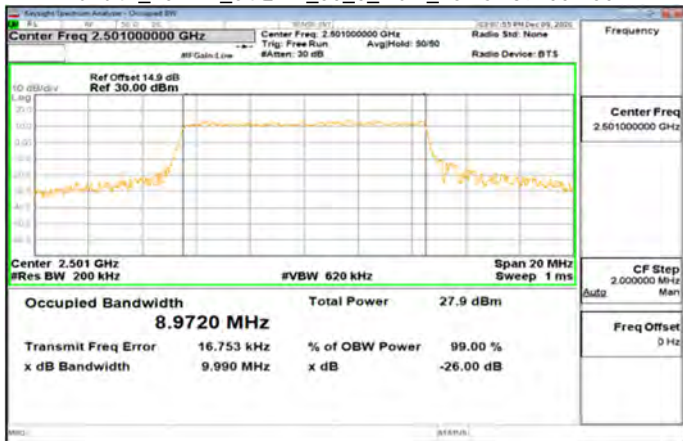

Band41_15MHz_QPSK_75_0_Main_LowCH39725-2503.5

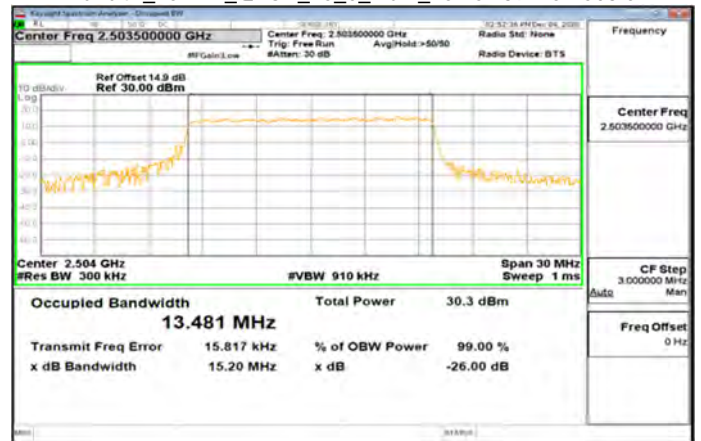

Band41_10MHz_64QAM_50_0_Main_MidCH40620-2593

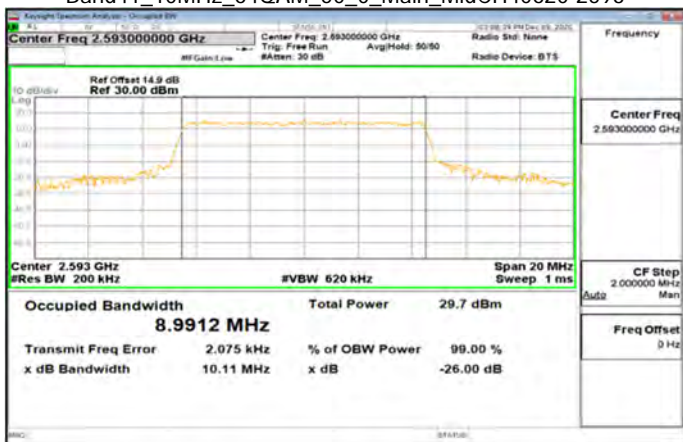

Band41_15MHz_QPSK_75_0_Main_MidCH40620-2593

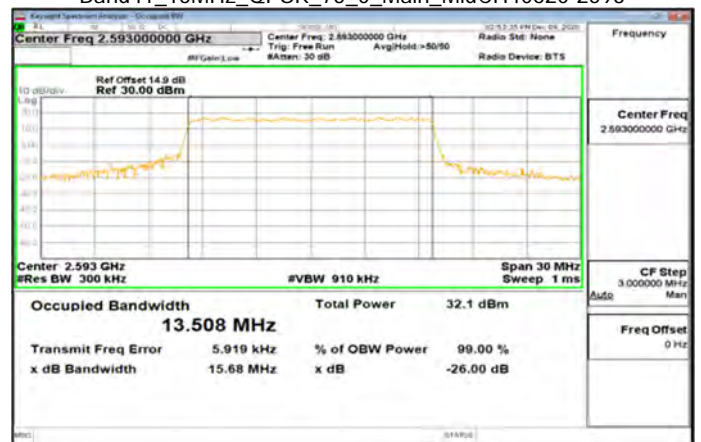

Band41_10MHz_64QAM_50_0_Main_HighCH41540-2685

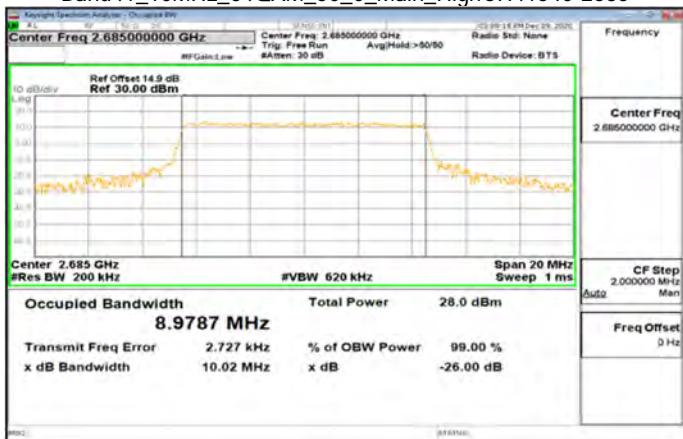

Band41_15MHz_QPSK_75_0_Main_HighCH41515-2682.5

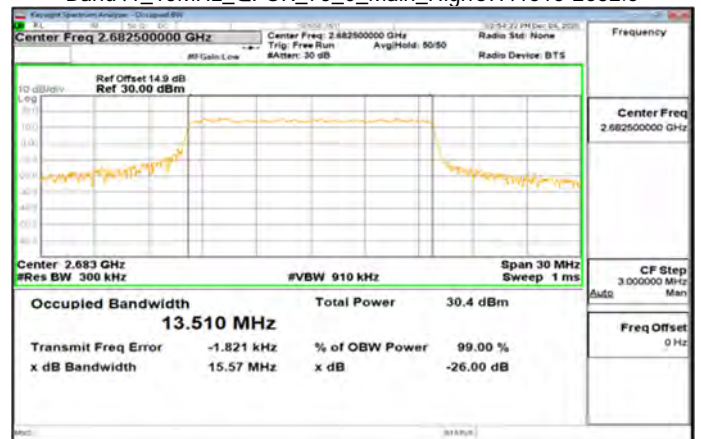

Unless otherwise stated the results shown in this test report refer only to the sample(s) tested and such sample(s) are retained for 90 days only.

除非另有說明，此報告結果僅對測試之樣品負責，同時此樣品僅保留90天。本報告未經本公司書面許可，不可部份複製。

This document is issued by the Company subject to its General Conditions of Service printed overleaf, available on request or accessible at <http://www.sgs.com.tw/Terms-and-Conditions> and for electronic format documents, subject to Terms and Conditions for Electronic Documents at <http://www.sgs.com.tw/Terms-and-Conditions>. Attention is drawn to the limitation of liability, indemnification and jurisdiction issues defined therein. Any holder of this document is advised that information contained herein reflects the Company's findings at the time of its intervention only and within the limits of Client's instructions, if any. The Company's sole responsibility is to its Client and this document does not exonerate parties to a transaction from exercising all their rights and obligations under the transaction documents. This document cannot be reproduced except in full, without prior written approval of the Company. Any unauthorized alteration, forgery or falsification of the content or appearance of this document is unlawful and offenders may be prosecuted to the fullest extent of the law.

Band41_15MHz_16QAM_75_0_Main_LowCH39725-2503.5

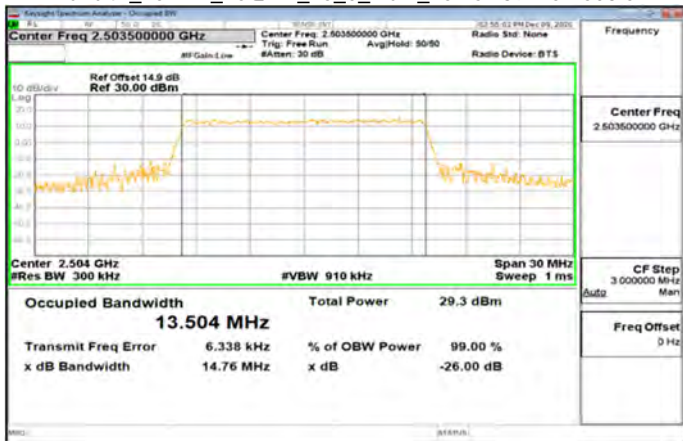

Band41_15MHz_64QAM_75_0_Main_LowCH39725-2503.5

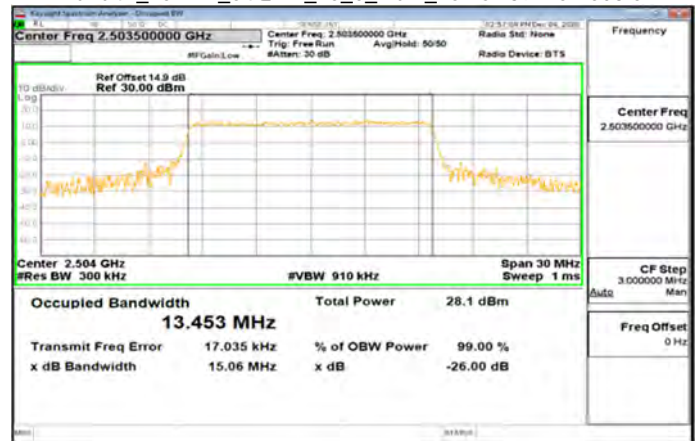

Band41_15MHz_16QAM_75_0_Main_MidCH40620-2593

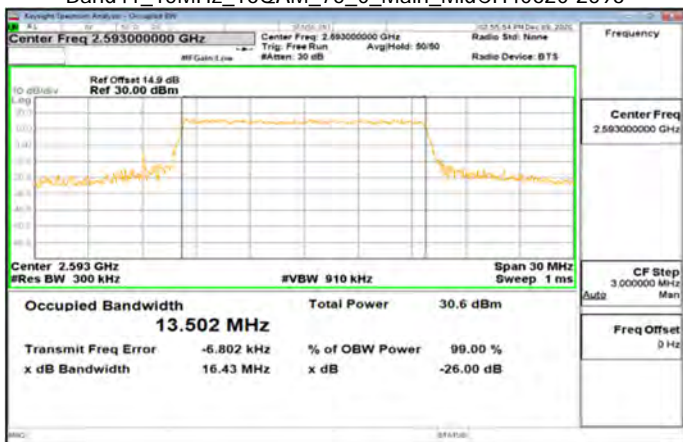

Band41_15MHz_64QAM_75_0_Main_MidCH40620-2593

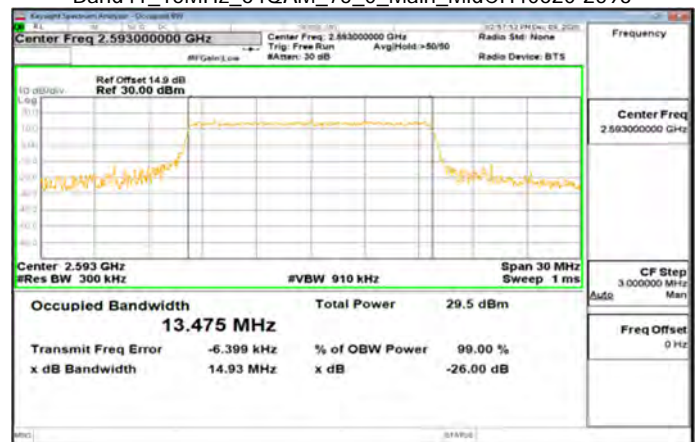

Band41_15MHz_16QAM_75_0_Main_HighCH41515-2682.5

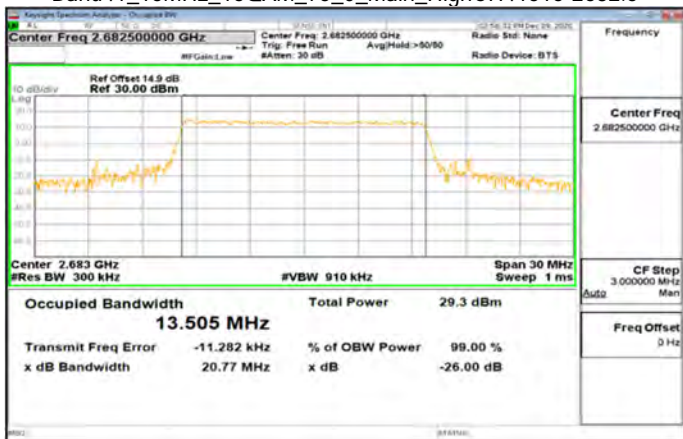

Band41_15MHz_64QAM_75_0_Main_HighCH41515-2682.5

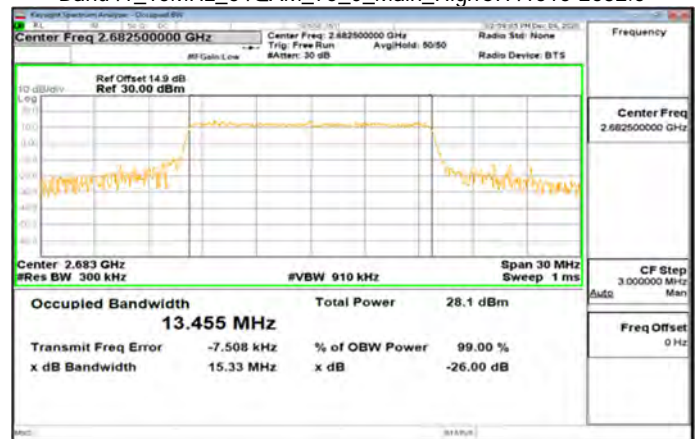

Unless otherwise stated the results shown in this test report refer only to the sample(s) tested and such sample(s) are retained for 90 days only.

除非另有說明，此報告結果僅對測試之樣品負責，同時此樣品僅保留90天。本報告未經本公司書面許可，不可部份複製。

This document is issued by the Company subject to its General Conditions of Service printed overleaf, available on request or accessible at <http://www.sgs.com.tw/Terms-and-Conditions> and for electronic format documents, subject to Terms and Conditions for Electronic Documents at <http://www.sgs.com.tw/Terms-and-Conditions>. Attention is drawn to the limitation of liability, indemnification and jurisdiction issues defined therein. Any holder of this document is advised that information contained herein reflects the Company's findings at the time of its intervention only and within the limits of Client's instructions, if any. The Company's sole responsibility is to its Client and this document does not exonerate parties to a transaction from exercising all their rights and obligations under the transaction documents. This document cannot be reproduced except in full, without prior written approval of the Company. Any unauthorized alteration, forgery or falsification of the content or appearance of this document is unlawful and offenders may be prosecuted to the fullest extent of the law.

Band41_20MHz_QPSK_100_0_Main_LowCH39750-2506

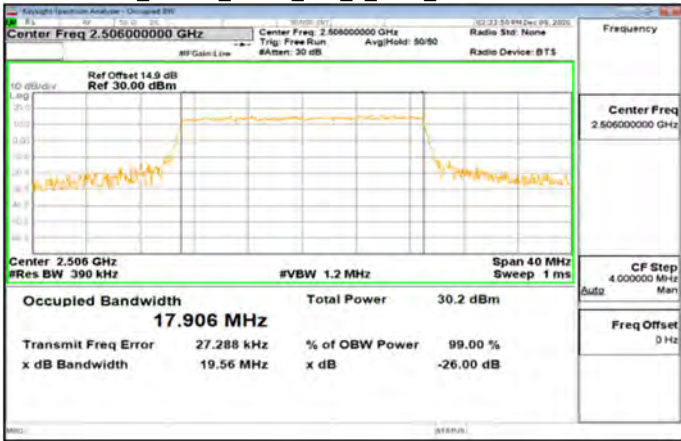

Band41_20MHz_16QAM_100_0_Main_LowCH39750-2506

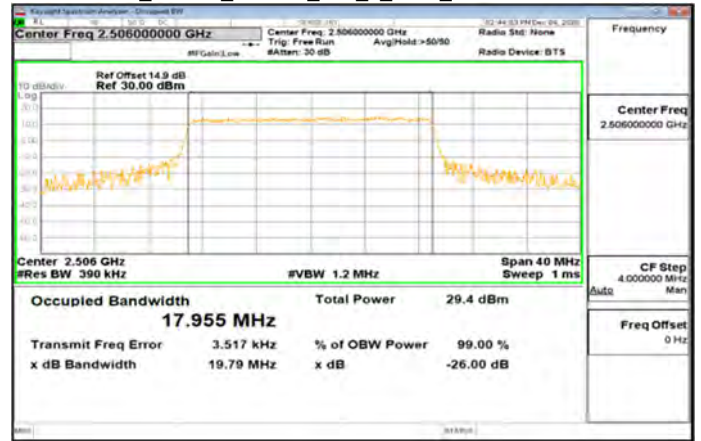

Band41_20MHz_QPSK_100_0_Main_MidCH40620-2593

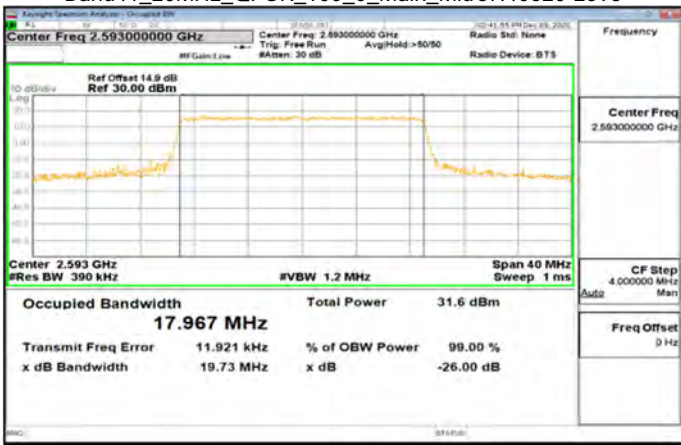

Band41_20MHz_16QAM_100_0_Main_MidCH40620-2593

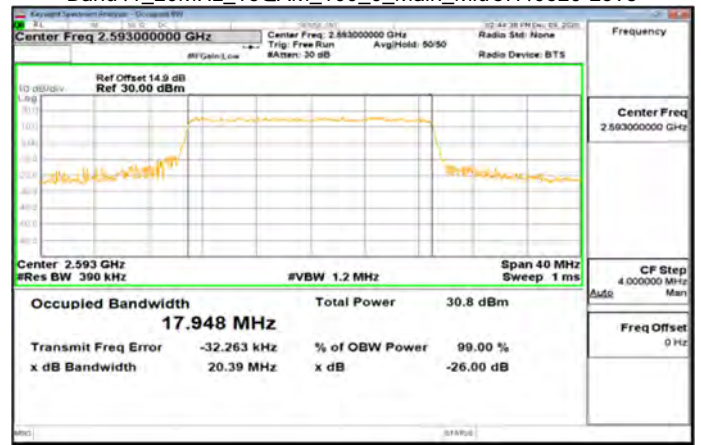

Band41_20MHz_QPSK_100_0_Main_HighCH41490-2680

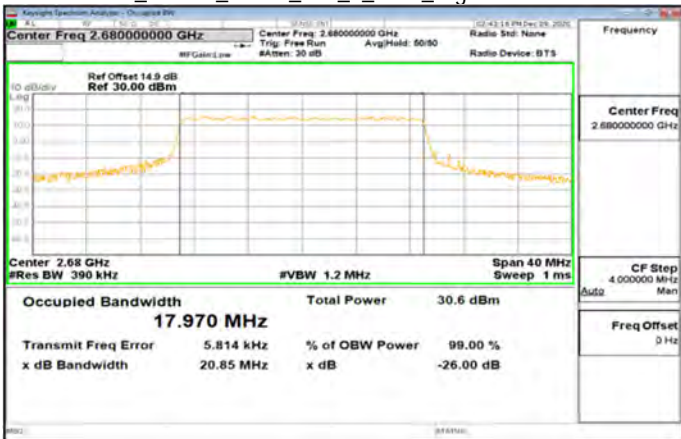

Band41_20MHz_16QAM_100_0_Main_HighCH41490-2680

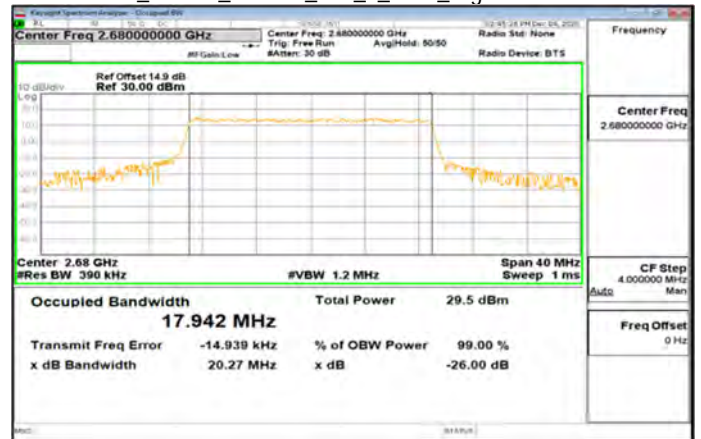

Unless otherwise stated the results shown in this test report refer only to the sample(s) tested and such sample(s) are retained for 90 days only.

除非另有說明，此報告結果僅對測試之樣品負責，同時此樣品僅保留90天。本報告未經本公司書面許可，不可部份複製。

This document is issued by the Company subject to its General Conditions of Service printed overleaf, available on request or accessible at <http://www.sgs.com.tw/Terms-and-Conditions> and for electronic format documents, subject to Terms and Conditions for Electronic Documents at <http://www.sgs.com.tw/Terms-and-Conditions>. Attention is drawn to the limitation of liability, indemnification and jurisdiction issues defined therein. Any holder of this document is advised that information contained herein reflects the Company's findings at the time of its intervention only and within the limits of Client's instructions, if any. The Company's sole responsibility is to its Client and this document does not exonerate parties to a transaction from exercising all their rights and obligations under the transaction documents. This document cannot be reproduced except in full, without prior written approval of the Company. Any unauthorized alteration, forgery or falsification of the content or appearance of this document is unlawful and offenders may be prosecuted to the fullest extent of the law.

Band41_20MHz_64QAM_100_0_Main_LowCH39750-2506

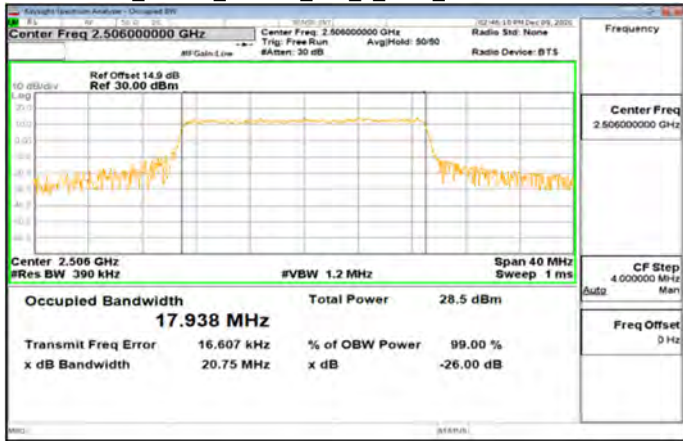

Band41_20MHz_64QAM_100_0_Main_MidCH40620-2593

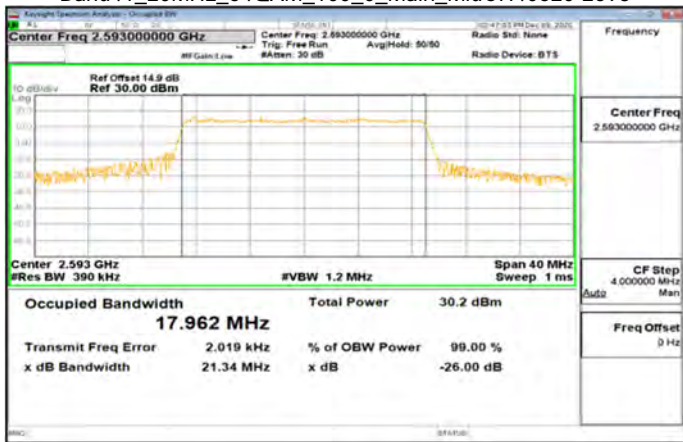

Band41_20MHz_64QAM_100_0_Main_HighCH41490-2680

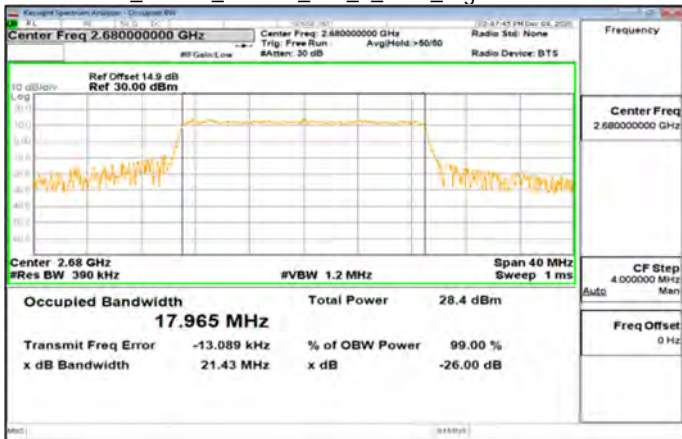

Unless otherwise stated the results shown in this test report refer only to the sample(s) tested and such sample(s) are retained for 90 days only.

除非另有說明，此報告結果僅對測試之樣品負責，同時此樣品僅保留90天。本報告未經本公司書面許可，不可部份複製。

This document is issued by the Company subject to its General Conditions of Service printed overleaf, available on request or accessible at <http://www.sgs.com.tw/Terms-and-Conditions> and for electronic format documents, subject to Terms and Conditions for Electronic Documents at <http://www.sgs.com.tw/Terms-and-Conditions>. Attention is drawn to the limitation of liability, indemnification and jurisdiction issues defined therein. Any holder of this document is advised that information contained herein reflects the Company's findings at the time of its intervention only and within the limits of Client's instructions, if any. The Company's sole responsibility is to its Client and this document does not exonerate parties to a transaction from exercising all their rights and obligations under the transaction documents. This document cannot be reproduced except in full, without prior written approval of the Company. Any unauthorized alteration, forgery or falsification of the content or appearance of this document is unlawful and offenders may be prosecuted to the fullest extent of the law.

8 OUT OF BAND EMISSION AT ANTENNA TERMINALS

8.1 Standard Applicable

FCC §22.917(a), §24.238(a), §27.53(h)

Out of band emissions. The power of any emission outside of the authorized operating frequency ranges must be attenuated below the transmitting power (P) by a factor of at least $43 + 10 \log(P)$ dB.

FCC §27.53(g) for LTE B12

Compliance for operations in the 600 MHz, 698-746 MHz, 746-758 MHz and the 776-788 MHz band with this provision is based on the use of measurement instrumentation employing a resolution bandwidth of 100 kilohertz or greater. However, in the 100 kilohertz bands immediately outside and adjacent to a licensee's frequency block, a resolution bandwidth of at least 30 kHz may be employed.

FCC §27.53(m) (4) (6) for LTE B38, 41

For mobile digital stations, the attenuation factor shall be not less than $40 + 10 \log(P)$ dB on all frequencies between the channel edge and 5 megahertz from the channel edge, $43 + 10 \log(P)$ dB on all frequencies between 5 megahertz and X megahertz from the channel edge, and $55 + 10 \log(P)$ dB on all frequencies more than X megahertz from the channel edge, where X is the greater of 6 megahertz or the actual emission bandwidth as defined in paragraph (m)(6) of this section. In addition, the attenuation factor shall not be less than $43 + 10 \log(P)$ dB on all frequencies between 2490.5 MHz and 2496 MHz and $55 + 10 \log(P)$ dB at or below 2490.5 MHz. Mobile Satellite Service licensees operating on frequencies below 2495 MHz may also submit a documented interference complaint against BRS licensees operating on channel BRS Channel 1 on the same terms and conditions as adjacent channel BRS or EBS licensees.

Measurement procedure. Compliance with these rules is based on the use of measurement instrumentation employing a resolution bandwidth of 1 megahertz or greater. However, in the 1 MHz bands immediately outside and adjacent to the frequency block a resolution bandwidth of at least one percent of the emission bandwidth of the fundamental emission of the transmitter may be employed; for mobile digital stations, in the 1 megahertz bands immediately outside and adjacent to the frequency block a resolution bandwidth of at least two percent may be employed, except when the 1 megahertz band is 2495-2496 MHz, in which case a resolution bandwidth of at least one percent may be employed. A narrower resolution bandwidth is permitted in all cases to improve measurement accuracy provided the measured power is integrated over the full required measurement bandwidth (i.e. 1 megahertz or 1 percent of emission bandwidth, as specified; or 1 megahertz or 2 percent for mobile digital stations, except in the band 2495-2496 MHz). The emission bandwidth is defined as the width of the signal between two points, one below the carrier center frequency and one above the carrier center frequency, outside of which all emissions are attenuated at least 26 dB below the transmitter power. With respect to television operations, measurements must be made of the separate visual and aural operating powers at sufficiently frequent intervals to ensure compliance with the rules.

8.2 Test SET-UP

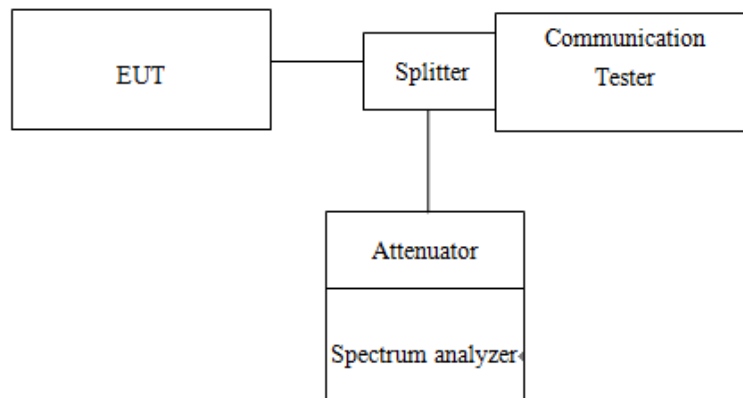

Unless otherwise stated the results shown in this test report refer only to the sample(s) tested and such sample(s) are retained for 90 days only.

除非另有說明，此報告結果僅對測試之樣品負責，同時此樣品僅保留90天。本報告未經本公司書面許可，不可部份複製。

This document is issued by the Company subject to its General Conditions of Service printed overleaf, available on request or accessible at <http://www.sgs.com.tw/Terms-and-Conditions> and for electronic format documents, subject to Terms and Conditions for Electronic Documents at <http://www.sgs.com.tw/Terms-and-Conditions>. Attention is drawn to the limitation of liability, indemnification and jurisdiction issues defined therein. Any holder of this document is advised that information contained hereon reflects the Company's findings at the time of its intervention only and within the limits of Client's instructions, if any. The Company's sole responsibility is to its Client and this document does not exonerate parties to a transaction from exercising all their rights and obligations under the transaction documents. This document cannot be reproduced except in full, without prior written approval of the Company. Any unauthorized alteration, forgery or falsification of the content or appearance of this document is unlawful and offenders may be prosecuted to the fullest extent of the law.

8.3 Measurement Procedure

8.3.1 Conducted Emission

The RF output of the transceiver was connected to a spectrum analyzer through appropriate attenuation. The resolution bandwidth of the spectrum analyzer was set at 1MHz, sufficient scans were taken to show the out of band Emissions if any up to 10th harmonic.

1. To connect Antenna Port of EUT to Spectrum.
2. Set RBW = 1MHz & VBW = 1MHz on Spectrum.
3. Allow trace to fully stabilize
4. Repeat above procedures until all default test channel measured were complete.

8.3.2 Band Edge

1. To connect Antenna Port of EUT to Spectrum.
2. The band edge of low and high channels for the highest RF powers was measured. Setting RBW \geq 1% EBW.
3. Allow trace to fully stabilize
4. Repeat above procedures until all default test channel measured were complete.

8.4 Measurement Equipment Used

Conducted Emission (measured at antenna port) Test Site					
EQUIPMENT TYPE	MFR	MODEL NUMBER	SERIAL NUMBER	LAST CAL.	CAL DUE.
PXA Spectrum Analyzer	Agilent	N9030A	MY53120760	04/21/2020	04/20/2021
DC Power Supply	Agilent	E3640A	MY40000811	12/23/2019	12/22/2020
Radio Communication Analyzer	Anritsu	MT8815B	6200711454	04/01/2020	03/31/2021
Radio Communication Analyzer	Anritsu	MT8821C	6261786084	01/18/2020	01/17/2021
Attenuator	Mini-Circuit	BW-S10W2+	2	01/02/2020	01/01/2021
DC Block	Mini-Circuits	BLK-18-S+	1	01/02/2020	01/01/2021
Splitter	RF-LAMBAD	RFLT2W1G18G	11-JSPF412-018	01/02/2020	01/01/2021

8.5 Measurement Result:

Refer to next pages.

Unless otherwise stated the results shown in this test report refer only to the sample(s) tested and such sample(s) are retained for 90 days only.

除非另有說明，此報告結果僅對測試之樣品負責，同時此樣品僅保留90天。本報告未經本公司書面許可，不可部份複製。

This document is issued by the Company subject to its General Conditions of Service printed overleaf, available on request or accessible at <http://www.sgs.com.tw/Terms-and-Conditions> and for electronic format documents, subject to Terms and Conditions for Electronic Documents at <http://www.sgs.com.tw/Terms-and-Conditions>. Attention is drawn to the limitation of liability, indemnification and jurisdiction issues defined therein. Any holder of this document is advised that information contained hereon reflects the Company's findings at the time of its intervention only and within the limits of Client's instructions, if any. The Company's sole responsibility is to its Client and this document does not exonerate parties to a transaction from exercising all their rights and obligations under the transaction documents. This document cannot be reproduced except in full, without prior written approval of the Company. Any unauthorized alteration, forgery or falsification of the content or appearance of this document is unlawful and offenders may be prosecuted to the fullest extent of the law.

Bandedge
GSM_850MHz_LowCH128-824.2

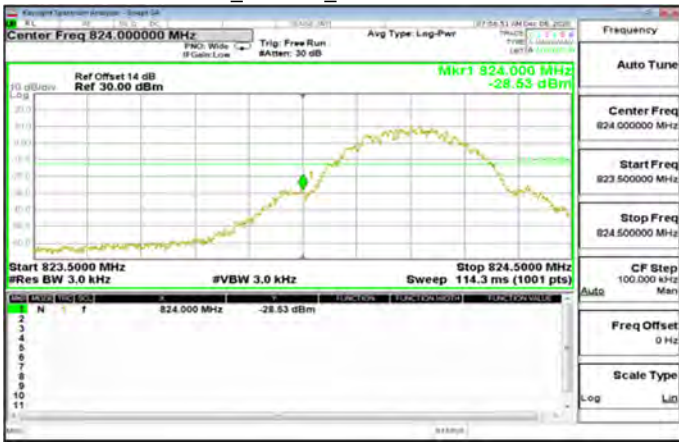

GPRS_850MHz_HighCH251-848.8



GSM_850MHz_HighCH251-848.8

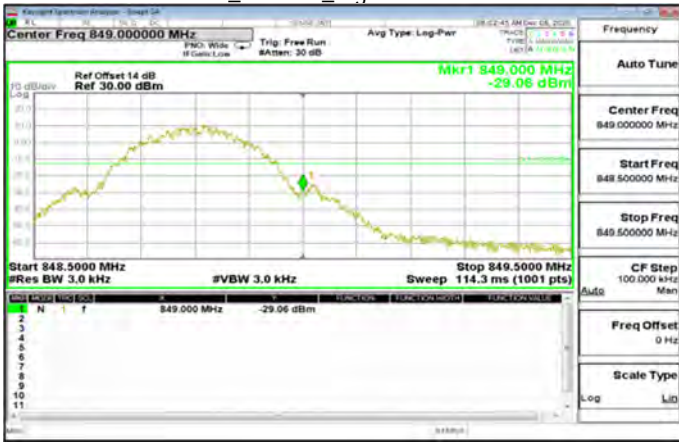

GSM_1900MHz_LowCH512-1850.2



GPRS_850MHz_LowCH128-824.2



GSM_1900MHz_HighCH810-1909.8



Unless otherwise stated the results shown in this test report refer only to the sample(s) tested and such sample(s) are retained for 90 days only.

除非另有說明，此報告結果僅對測試之樣品負責，同時此樣品僅保留90天。本報告未經本公司書面許可，不可部份複製。

This document is issued by the Company subject to its General Conditions of Service printed overleaf, available on request or accessible at <http://www.sgs.com.tw/Terms-and-Conditions> and for electronic format documents, subject to Terms and Conditions for Electronic Documents at <http://www.sgs.com.tw/Terms-and-Conditions>. Attention is drawn to the limitation of liability, indemnification and jurisdiction issues defined therein. Any holder of this document is advised that information contained hereon reflects the Company's findings at the time of its intervention only and within the limits of Client's instructions, if any. The Company's sole responsibility is to its Client and this document does not exonerate parties to a transaction from exercising all their rights and obligations under the transaction documents. This document cannot be reproduced except in full, without prior written approval of the Company. Any unauthorized alteration, forgery or falsification of the content or appearance of this document is unlawful and offenders may be prosecuted to the fullest extent of the law.

GPRS_1900MHz_LowCH512-1850.2



WCDMA_B5_HighCH4233-846.6



GPRS_1900MHz_HighCH810-1909.8

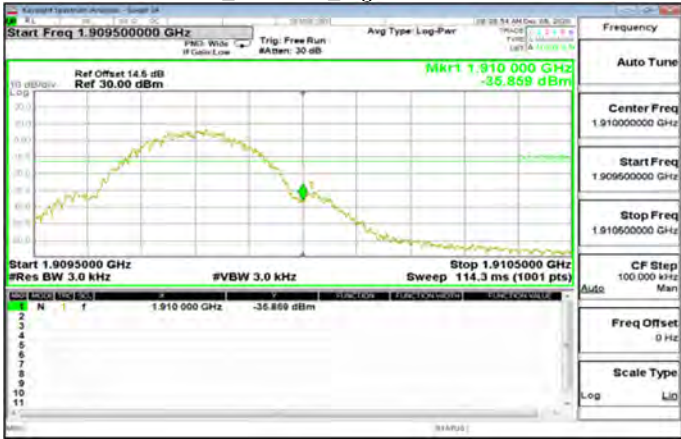

HSDPA_B5_LowCH4132-826.4

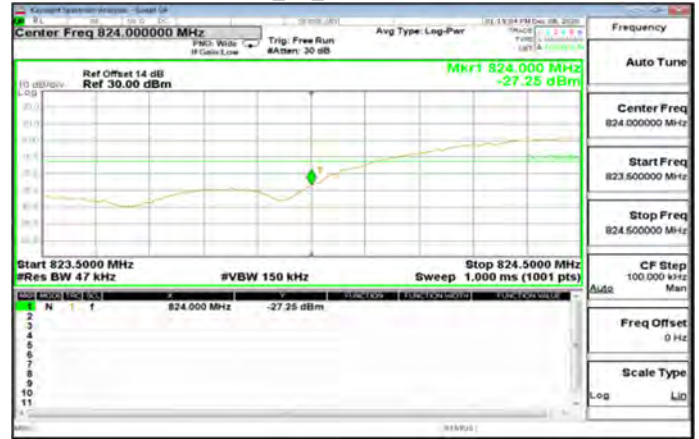

WCDMA_B5_LowCH4132-826.4

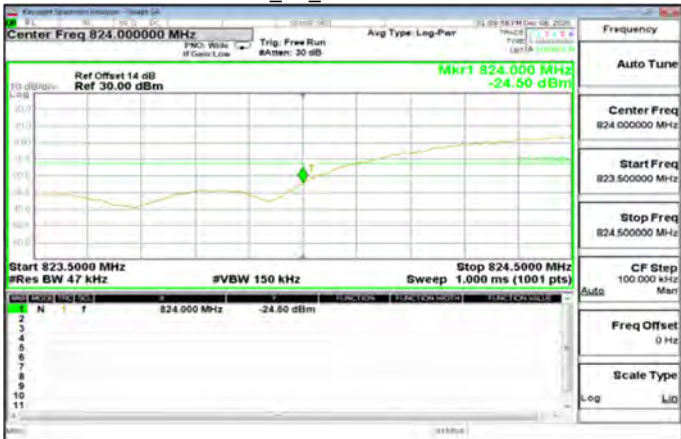

HSDPA_B5_HighCH4233-846.6

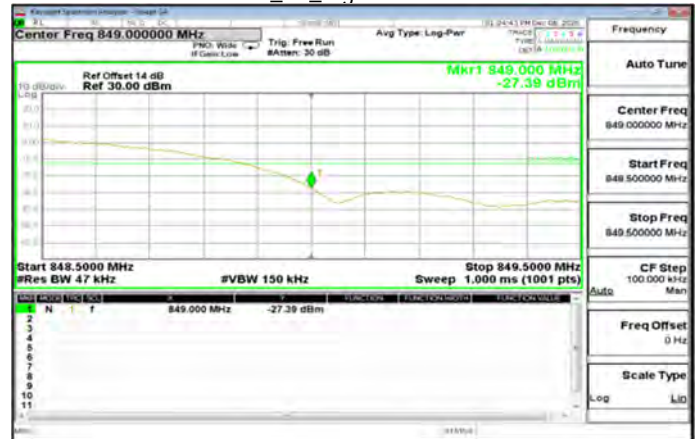

Unless otherwise stated the results shown in this test report refer only to the sample(s) tested and such sample(s) are retained for 90 days only.

除非另有說明，此報告結果僅對測試之樣品負責，同時此樣品僅保留90天。本報告未經本公司書面許可，不可部份複製。

This document is issued by the Company subject to its General Conditions of Service printed overleaf, available on request or accessible at <http://www.sgs.com.tw/Terms-and-Conditions> and for electronic format documents, subject to Terms and Conditions for Electronic Documents at <http://www.sgs.com.tw/Terms-and-Conditions>. Attention is drawn to the limitation of liability, indemnification and jurisdiction issues defined therein. Any holder of this document is advised that information contained hereon reflects the Company's findings at the time of its intervention only and within the limits of Client's instructions, if any. The Company's sole responsibility is to its Client and this document does not exonerate parties to a transaction from exercising all their rights and obligations under the transaction documents. This document cannot be reproduced except in full, without prior written approval of the Company. Any unauthorized alteration, forgery or falsification of the content or appearance of this document is unlawful and offenders may be prosecuted to the fullest extent of the law.

HSUPA_B5_LowCH4132-826.4

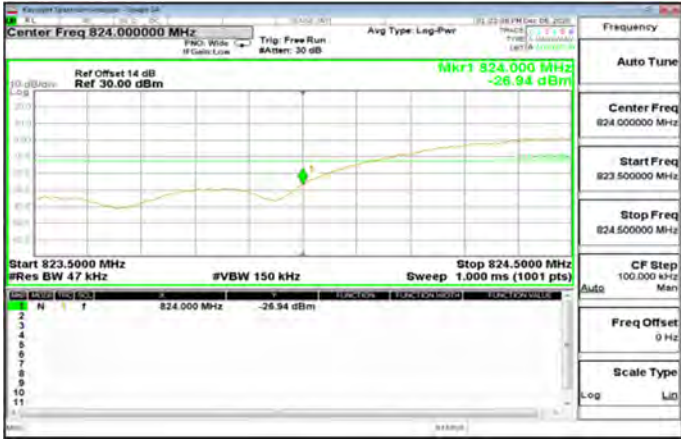

LTEBand5_10MHz_QPSK_1_49_HighCH20600-844



HSUPA_B5_HighCH4233-846.6



LTEBand5_10MHz_QPSK_50_0_LowCH20450-829

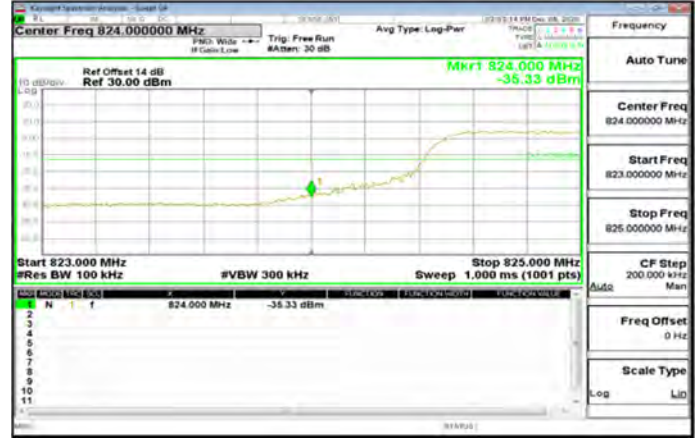

LTE\Band5_10MHz_QPSK_1_0_LowCH20450-829



LTEBand5_10MHz_QPSK_50_0_HighCH20600-844



Unless otherwise stated the results shown in this test report refer only to the sample(s) tested and such sample(s) are retained for 90 days only.

除非另有說明，此報告結果僅對測試之樣品負責，同時此樣品僅保留90天。本報告未經本公司書面許可，不可部份複製。

This document is issued by the Company subject to its General Conditions of Service printed overleaf, available on request or accessible at <http://www.sgs.com.tw/Terms-and-Conditions> and for electronic format documents, subject to Terms and Conditions for Electronic Documents at <http://www.sgs.com.tw/Terms-and-Conditions>. Attention is drawn to the limitation of liability, indemnification and jurisdiction issues defined therein. Any holder of this document is advised that information contained hereon reflects the Company's findings at the time of its intervention only and within the limits of Client's instructions, if any. The Company's sole responsibility is to its Client and this document does not exonerate parties to a transaction from exercising all their rights and obligations under the transaction documents. This document cannot be reproduced except in full, without prior written approval of the Company. Any unauthorized alteration, forgery or falsification of the content or appearance of this document is unlawful and offenders may be prosecuted to the fullest extent of the law.

LTE\Band12_10MHz_QPSK_1_0_LowCH23060-704



LTE\Band12_10MHz_QPSK_50_0_HighCH23130-711



LTE\Band12_10MHz_QPSK_1_49_HighCH23130-711

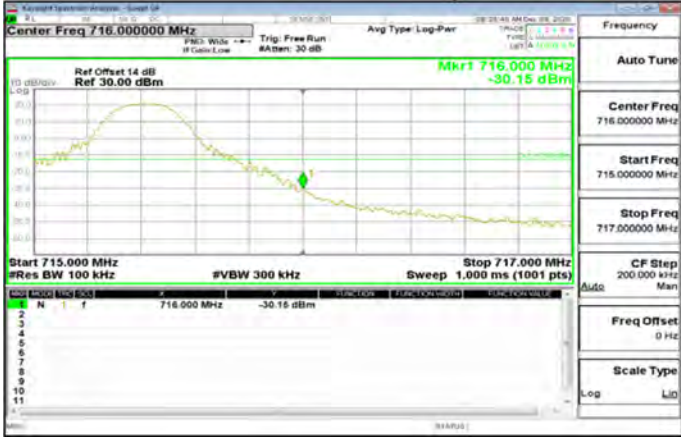

LTE\Band17_10MHz_QPSK_1_0_LowCH23780-709



LTE\Band12_10MHz_QPSK_50_0_LowCH23060-704

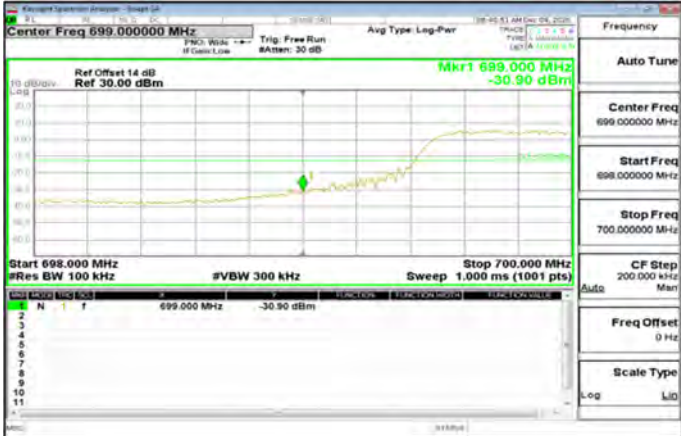

LTE\Band17_10MHz_QPSK_1_49_HighCH23800-711



Unless otherwise stated the results shown in this test report refer only to the sample(s) tested and such sample(s) are retained for 90 days only.

除非另有說明，此報告結果僅對測試之樣品負責，同時此樣品僅保留90天。本報告未經本公司書面許可，不可部份複製。

This document is issued by the Company subject to its General Conditions of Service printed overleaf, available on request or accessible at <http://www.sgs.com.tw/Terms-and-Conditions> and for electronic format documents, subject to Terms and Conditions for Electronic Documents at <http://www.sgs.com.tw/Terms-and-Conditions>. Attention is drawn to the limitation of liability, indemnification and jurisdiction issues defined therein. Any holder of this document is advised that information contained hereon reflects the Company's findings at the time of its intervention only and within the limits of Client's instructions, if any. The Company's sole responsibility is to its Client and this document does not exonerate parties to a transaction from exercising all their rights and obligations under the transaction documents. This document cannot be reproduced except in full, without prior written approval of the Company. Any unauthorized alteration, forgery or falsification of the content or appearance of this document is unlawful and offenders may be prosecuted to the fullest extent of the law.