



FCC CERTIFICATION REPORT

FCC Designation Number: TW1124

Test Report No. : MH/2020/B0179
Applicant : Sharp Corporation, Mobile Communication B.U.
Address : 2-13-1, Hachihonmatsu-lida, Higashi-hiroshima-shi, Hiroshima, 739-0192, Japan
Manufacturer : Sharp Corporation
Address : 1 Takumi-cho, Sakai-ku, Sakai City, Osaka 590-8522, Japan

Equipment Under Test (EUT) :
Product Name : Smart phone

Standards : FCC Part 15 Subpart B (Class B)

Date of Sample Receipt : Nov. 25, 2020
Date of Test : Dec. 10 ~ 15, 2020
Date of Issue : Dec. 25, 2020

| | |
|----------------------|-------------|
| Test Result : | PASS |
|----------------------|-------------|

In the configuration tested, the EUT complied with the standards specified above.

Remarks :

This report details the results of the testing carried out on one sample, the results contained in this test report do not relate to other samples of the same product. The manufacturer should ensure that all products in series production are in conformity with the product sample detailed in this report.

This report may only be reproduced and distributed in full. If the product in this report is used in any configuration other than that detailed in the report, the manufacturer must ensure the new system complies with all relevant standards. Any mention of SGS Taiwan Electromagnetic Compatibility Laboratory or testing done by SGS Taiwan Electromagnetic Compatibility Laboratory in connection with distribution or use of the product described in this report must be approved by SGS Taiwan Electromagnetic Compatibility Laboratory in writing.

Approved By Eddy Cheng
Eddy Cheng (Asst. Supervisor)

Date Dec. 25, 2020



Unless otherwise stated the results shown in this test report refer only to the sample(s) tested and such sample(s) are retained for 90 days only.
 除非另有說明，此報告結果僅對測試之樣品負責，同時此樣品僅保留90天。本報告未經本公司書面許可，不可部份複製。

This document is issued by the Company subject to its General Conditions of Service printed overleaf, available on request or accessible at <http://www.sgs.com.tw/Terms-and-Conditions> and for electronic format documents, subject to Terms and Conditions for Electronic Documents at <http://www.sgs.com.tw/Terms-and-Conditions>. Attention is drawn to the limitation of liability, indemnification and jurisdiction issues defined therein. Any holder of this document is advised that information contained hereon reflects the Company's findings at the time of its intervention only and within the limits of Client's instructions, if any. The Company's sole responsibility is to its Client and this document does not exonerate parties to a transaction from exercising all their rights and obligations under the transaction documents. This document cannot be reproduced except in full, without prior written approval of the Company. Any unauthorized alteration, forgery or falsification of the content or appearance of this document is unlawful and offenders may be prosecuted to the fullest extent of the law.



Revision History

| Revision | Description | Issue Date | Remark |
|----------|-------------|---------------|---------------|
| 00 | Original. | Dec. 25, 2020 | MH/2020/B0179 |

Unless otherwise stated the results shown in this test report refer only to the sample(s) tested and such sample(s) are retained for 90 days only.

除非另有說明，此報告結果僅對測試之樣品負責，同時此樣品僅保留90天。本報告未經本公司書面許可，不可部份複製。

This document is issued by the Company subject to its General Conditions of Service printed overleaf, available on request or accessible at <http://www.sgs.com.tw/Terms-and-Conditions> and for electronic format documents, subject to Terms and Conditions for Electronic Documents at <http://www.sgs.com.tw/Terms-and-Conditions>. Attention is drawn to the limitation of liability, indemnification and jurisdiction issues defined therein. Any holder of this document is advised that information contained hereon reflects the Company's findings at the time of its intervention only and within the limits of Client's instructions, if any. The Company's sole responsibility is to its Client and this document does not exonerate parties to a transaction from exercising all their rights and obligations under the transaction documents. This document cannot be reproduced except in full, without prior written approval of the Company. Any unauthorized alteration, forgery or falsification of the content or appearance of this document is unlawful and offenders may be prosecuted to the fullest extent of the law.

SGS Taiwan Ltd.

No.2, Keji 1st Rd., Guishan District, Taoyuan City, Taiwan / 桃園市龜山區科技一路2號

台灣檢驗科技股份有限公司

t (886-2) 2299-3279

f (886-3) 327-7559

www.sgs.com.tw

Member of SGS Group



Contents

| | |
|---|-----------|
| 1. GENERAL INFORMATION | 4 |
| 1.1 APPLICANT & MANUFACTURER INFORMATION | 4 |
| 1.2 GENERAL DESCRIPTION OF EUT | 4 |
| 1.3 DETAILS OF EUT | 4 |
| 1.4 DESCRIPTION OF SUPPORT UNITS | 5 |
| 1.5 OPERATION PROCEDURE | 6 |
| 1.6 MODIFICATION LIST | 7 |
| 1.7 ACCESSORIES CABLE LIST | 7 |
| 1.8 TEST SET-UP CONFIGURATION..... | 8 |
| 1.9 MEASUREMENT PROCEDURE | 9 |
| 1.10 STANDARDS APPLICABLE FOR TESTING..... | 9 |
| 1.11 DECISION RULES OF RESULTS..... | 10 |
| 1.12 SUMMARY OF RESULTS..... | 10 |
| 1.13 REPORTING STATEMENTS OF CONFORMITY..... | 10 |
| 2. EMISSION | 11 |
| 2.1 TEST RESULTS | 11 |
| 2.2 FREQUENCY RANGE..... | 11 |
| 2.3 LIMITS OF CONDUCTED AND RADIATED EMISSION | 12 |
| 2.3.1 LIMITS OF CONDUCTED EMISSION | 12 |
| 2.3.2 LIMITS OF RADIATED EMISSIONS..... | 12 |
| 2.4. TEST OF CONDUCTED EMISSION..... | 13 |
| 2.4.1 TEST EQUIPMENTS | 13 |
| 2.4.2 MEASUREMENT LEVEL CALCULATION..... | 13 |
| 2.4.3 MEASUREMENT DATA:..... | 14 |
| 2.5 TEST OF RADIATED EMISSION..... | 24 |
| 2.5.1 TEST EQUIPMENTS | 24 |
| 2.5.2 MEASUREMENT LEVEL CALCULATION..... | 25 |
| 2.5.3 MEASUREMENT DATA..... | 26 |
| 3. PHOTOGRAPHS OF TEST | 56 |

Unless otherwise stated the results shown in this test report refer only to the sample(s) tested and such sample(s) are retained for 90 days only.
 除非另有說明，此報告結果僅對測試之樣品負責，同時此樣品僅保留90天。本報告未經本公司書面許可，不可部份複製。

This document is issued by the Company subject to its General Conditions of Service printed overleaf, available on request or accessible at <http://www.sgs.com.tw/Terms-and-Conditions> and for electronic format documents, subject to Terms and Conditions for Electronic Documents at <http://www.sgs.com.tw/Terms-and-Conditions>. Attention is drawn to the limitation of liability, indemnification and jurisdiction issues defined therein. Any holder of this document is advised that information contained hereon reflects the Company's findings at the time of its intervention only and within the limits of Client's instructions, if any. The Company's sole responsibility is to its Client and this document does not exonerate parties to a transaction from exercising all their rights and obligations under the transaction documents. This document cannot be reproduced except in full, without prior written approval of the Company. Any unauthorized alteration, forgery or falsification of the content or appearance of this document is unlawful and offenders may be prosecuted to the fullest extent of the law.



1. General Information

1.1 Applicant & Manufacturer Information

Applicant : Sharp Corporation, Mobile Communication B.U.
 Address of Applicant : 2-13-1, Hachihonmatsu-lida, Higashi-hiroshima-shi,
 Hiroshima, 739-0192, Japan
 Manufacturer : Sharp Corporation
 Address of Manufacturer : 1 Takumi-cho, Sakai-ku, Sakai City, Osaka 590-
 8522, Japan

1.2 General Description of EUT

Product Name : Smart phone

1.3 Details of EUT

Power Supply : AC 100~240V, 50~60Hz
 Highest internal frequency : 5850 MHz
 Battery : 3.85V, 4570mAh, 17.28Wh
 Worst case : CE Worst case : Config 1~5
 Below 1GHz RE Worst case : Config 1~5
 Above 1GHz RE Worst case : Config 1~5

| FCC ID : APYHRO00292 | Memory | Main PCB | Ant PCB | Prox PCB | (Select which one is worst case) |
|----------------------|----------|----------|----------|----------|----------------------------------|
| 1st Source | Vendor A | Vendor A | Vendor A | Vendor A | Worst case |
| 2nd Source | Vendor B | Vendor B | Vendor B | Vendor B | V |

Unless otherwise stated the results shown in this test report refer only to the sample(s) tested and such sample(s) are retained for 90 days only.
 除非另有說明，此報告結果僅對測試之樣品負責，同時此樣品僅保留90天。本報告未經本公司書面許可，不可部份複製。

This document is issued by the Company subject to its General Conditions of Service printed overleaf, available on request or accessible at <http://www.sgs.com.tw/Terms-and-Conditions> and for electronic format documents, subject to Terms and Conditions for Electronic Documents at <http://www.sgs.com.tw/Terms-and-Conditions>. Attention is drawn to the limitation of liability, indemnification and jurisdiction issues defined therein. Any holder of this document is advised that information contained hereon reflects the Company's findings at the time of its intervention only and within the limits of Client's instructions, if any. The Company's sole responsibility is to its Client and this document does not exonerate parties to a transaction from exercising all their rights and obligations under the transaction documents. This document cannot be reproduced except in full, without prior written approval of the Company. Any unauthorized alteration, forgery or falsification of the content or appearance of this document is unlawful and offenders may be prosecuted to the fullest extent of the law.



| | | | | | |
|--|---|---------------------------|--|---|---|
| Accessories List: (Not bundled) AC Charger : Salom/XN-2QC25 Data Cable : Luxshare-ICT/L6KU2007-CS-H PHF : Ambibio / AB-HI02JS | Config 1 | Config 2 | Config 3 | Config 4 | Config 5 |
| | Applicable standard | | | | |
| Accessories | EUT + AC Adaptor +USB Cable +PHF | EUT +USB Cable +PHF | EUT + AC Adaptor +USB Cable +PHF | EUT + AC Adaptor +USB Cable +PHF | EUT + AC Adaptor +USB Cable +PHF |
| Main function | Speech | Data Link | Camera | RX Receive | FM RX |
| Additional function | BT+WLAN2.4G/5G+GNSS+NFC | | | | |
| Description | | | | | |
| radiated emission | GSM 850, 1900 WCDMA BV LTE B05, 12, 17, 38, 41 | Data R/W | MP3/ ;REC mode (Front/Back) ;play REC | GSM 850 WCDMA BV LTE B05 | FM 88.1/ FM 98.1/ FM 107.9 |
| conducted emission (DC Power) | NA | NA | NA | NA | NA |
| conducted emission (AC Power) | GSM 850, 1900 WCDMA BV LTE B05, 12, 17, 38, 41 | Data R/W | MP3/ ;REC mode (Front/Back) ;play REC | GSM 850 WCDMA BV LTE B05 | FM 88.1/ FM 98.1/ FM 107.9 |

1.4 Description of Support Units

| PRODUCT | MANUFACTURER | MODEL NO. | SERIAL NO. |
|------------------------------|--------------|----------------------|-----------------------|
| SIM Card | R&S | CMW-Z05 | 8952530076180138474 |
| Micro SD | Transcend | Micro SDHC(Class 10) | TS32GUSDU1 |
| BT Speaker | Creative | MF8090 | YFMF8090245R00855Y |
| Radio Communication Analyzer | R&S | CMU200 | 102189 |
| Radio Communication Analyzer | R&S | CMW500 | 1201.002K50-152303-Zr |
| AP | BUFFALO | WZR-HP-G300NH2 | 44066221202559[[G]] |
| GPS Signal Generator | Spectracom | GSG53 GNSS4 | 200218 |
| Notebook (CE, HRE) | Lenovo | TP00109A | SL10N19265 |
| Notebook (RE) | DELL | P56F | 59WSJ72 |
| Mouse | Logitech | M-U0026 | 1738HS05FGU8 |
| Earphone | Ambibio | AB-HI02JS | N/A |
| Adapter | Salom | XN-2QC25 | N/A |
| TMC/FM Generator | Levear | VP-8194D | 0821170LA |

Support Equipment Used in Tested Cable

| Cable Type | Core | Length | Shielding/Non-shielding |
|----------------|------|--------|-------------------------|
| USB cable | N/A | 1m | Shielding |
| USB cable | N/A | 1.5m | Shielding |
| Earphone cable | N/A | 1.5m | Non-shielding |

Unless otherwise stated the results shown in this test report refer only to the sample(s) tested and such sample(s) are retained for 90 days only.

除非另有說明，此報告結果僅對測試之樣品負責，同時此樣品僅保留90天。本報告未經本公司書面許可，不可部份複製。

This document is issued by the Company subject to its General Conditions of Service printed overleaf, available on request or accessible at <http://www.sgs.com.tw/Terms-and-Conditions> and for electronic format documents, subject to Terms and Conditions for Electronic Documents at <http://www.sgs.com.tw/Terms-and-Conditions>. Attention is drawn to the limitation of liability, indemnification and jurisdiction issues defined therein. Any holder of this document is advised that information contained hereon reflects the Company's findings at the time of its intervention only and within the limits of Client's instructions, if any. The Company's sole responsibility is to its Client and this document does not exonerate parties to a transaction from exercising all their rights and obligations under the transaction documents. This document cannot be reproduced except in full, without prior written approval of the Company. Any unauthorized alteration, forgery or falsification of the content or appearance of this document is unlawful and offenders may be prosecuted to the fullest extent of the law.



1.5 Operation Procedure

Config 1

1. Install SIM Card & Micro SD Card & Earphone in EUT, connect to designated Adapter with USB Cable and turn it on.
2. Turn on BT and Link BT Speaker.
3. Turn on Wifi and NB Link to WiFi-AP, NB ping EUT IP Address.
4. Set up a GPS simulator and execute GPS Test.app.
5. Before and after the test, confirm the NFC function.
6. Set up the base station and set Link/Idle in according to config table.
7. Start the test.

Config 2

1. Install SIM Card & Micro SD Card & Earphone in EUT, connect to NB with USB Cable and turn it on.
2. Turn on BT and Link BT Speaker.
3. Turn on Wifi and NB Link to WiFi-AP, NB ping EUT IP Address.
4. Set up a GPS simulator and execute GPS Test.app.
5. Before and after the test, confirm the NFC function.
6. NB executes data R/W with EUT according to config table.
7. Start the test.

Config 3

1. Install SIM Card & Micro SD Card & Earphone in EUT, connect to designated Adapter with USB Cable and turn it on.
2. Turn on BT and Link BT Speaker.
3. Turn on Wifi and NB Link to WiFi-AP, NB ping EUT IP Address.
4. Set up a GPS simulator and execute GPS Test.app.
5. Before and after the test, confirm the NFC function.
6. Execute Camera(Front/Back) Record / Play REC / MP3 function according to config table.
7. Start the test.

Unless otherwise stated the results shown in this test report refer only to the sample(s) tested and such sample(s) are retained for 90 days only.
除非另有說明，此報告結果僅對測試之樣品負責，同時此樣品僅保留90天。本報告未經本公司書面許可，不可部份複製。

This document is issued by the Company subject to its General Conditions of Service printed overleaf, available on request or accessible at <http://www.sgs.com.tw/Terms-and-Conditions> and for electronic format documents, subject to Terms and Conditions for Electronic Documents at <http://www.sgs.com.tw/Terms-and-Conditions>. Attention is drawn to the limitation of liability, indemnification and jurisdiction issues defined therein. Any holder of this document is advised that information contained hereon reflects the Company's findings at the time of its intervention only and within the limits of Client's instructions, if any. The Company's sole responsibility is to its Client and this document does not exonerate parties to a transaction from exercising all their rights and obligations under the transaction documents. This document cannot be reproduced except in full, without prior written approval of the Company. Any unauthorized alteration, forgery or falsification of the content or appearance of this document is unlawful and offenders may be prosecuted to the fullest extent of the law.



Config 4

1. Install SIM Card & Micro SD Card & Earphone in EUT, connect to designated Adapter with USB Cable and turn it on.
2. Turn on BT and Link BT Speaker.
3. Turn on Wifi and NB Link to WiFi-AP, NB ping EUT IP Address.
4. Set up a GPS simulator and execute GPS Test.app.
5. Before and after the test, confirm the NFC function.
6. Set up the base station and set Rx Receive in according to config table.
7. Start the test.

Config 5

1. Install SIM Card & Micro SD Card & Earphone in EUT, connect to designated Adapter with USB Cable and turn it on.
2. Turn on BT and Link BT Speaker.
3. Turn on Wifi and NB Link to WiFi-AP, NB ping EUT IP Address.
4. Set up a GPS simulator and execute GPS Test.app.
5. Before and after the test, confirm the NFC function.
6. Execute FM function according to config table. (FM 88.1 /FM 98.1 /FM107.9)
7. Start the test.

1.6 Modification List

No modification was made by SGS Taiwan Electromagnetic Compatibility Laboratory.

1.7 Accessories Cable List

| Cable Type | Core | Length | Shielding/Non-shielding |
|------------|------|--------|-------------------------|
| N/A | N/A | N/A | N/A |

Unless otherwise stated the results shown in this test report refer only to the sample(s) tested and such sample(s) are retained for 90 days only.
 除非另有說明，此報告結果僅對測試之樣品負責，同時此樣品僅保留90天。本報告未經本公司書面許可，不可部份複製。

This document is issued by the Company subject to its General Conditions of Service printed overleaf, available on request or accessible at <http://www.sgs.com.tw/Terms-and-Conditions> and for electronic format documents, subject to Terms and Conditions for Electronic Documents at <http://www.sgs.com.tw/Terms-and-Conditions>. Attention is drawn to the limitation of liability, indemnification and jurisdiction issues defined therein. Any holder of this document is advised that information contained hereon reflects the Company's findings at the time of its intervention only and within the limits of Client's instructions, if any. The Company's sole responsibility is to its Client and this document does not exonerate parties to a transaction from exercising all their rights and obligations under the transaction documents. This document cannot be reproduced except in full, without prior written approval of the Company. Any unauthorized alteration, forgery or falsification of the content or appearance of this document is unlawful and offenders may be prosecuted to the fullest extent of the law.



1.8 Test Set-Up Configuration

Config 1 & 4

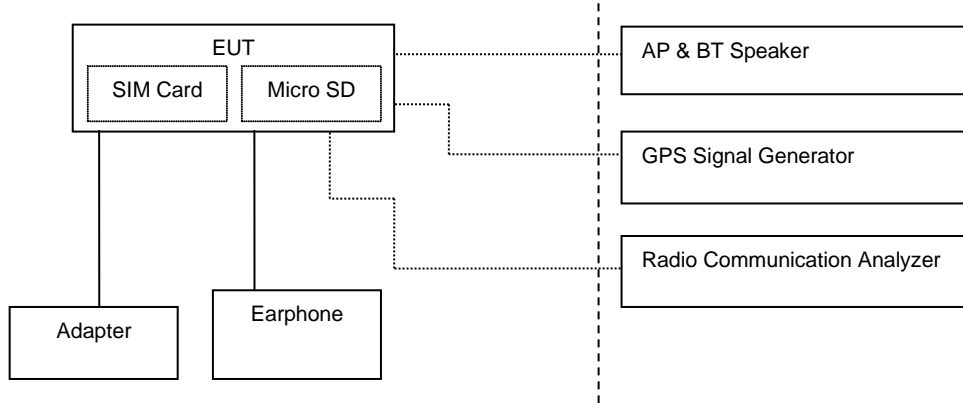

Config 2

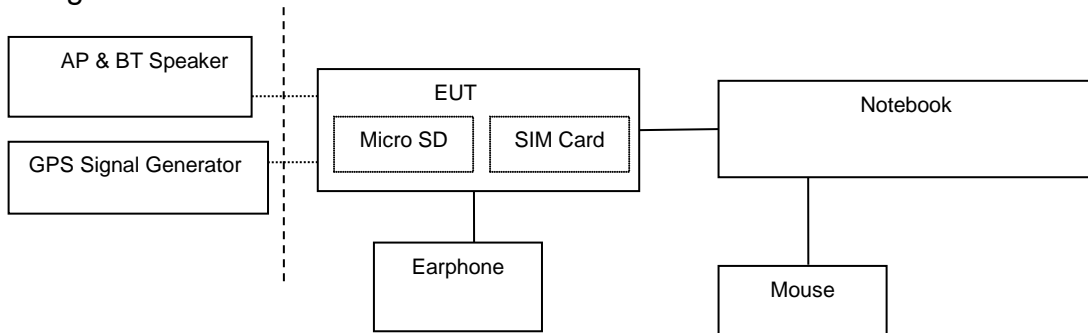

Config 3

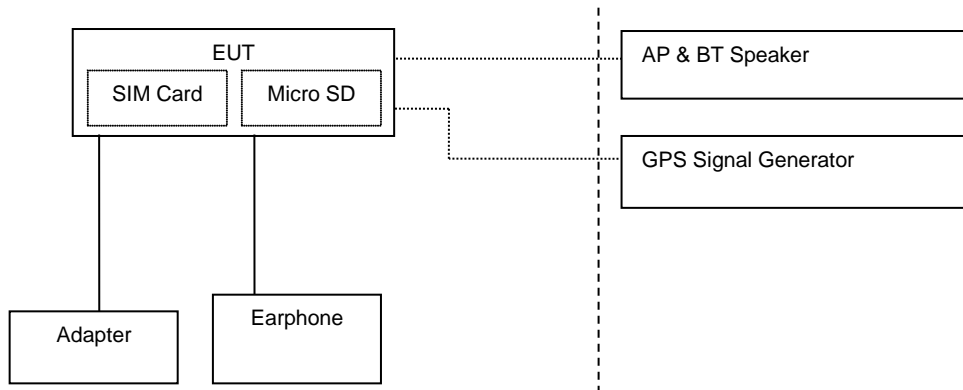

Unless otherwise stated the results shown in this test report refer only to the sample(s) tested and such sample(s) are retained for 90 days only.

除非另有說明，此報告結果僅對測試之樣品負責，同時此樣品僅保留90天。本報告未經本公司書面許可，不可部份複製。

This document is issued by the Company subject to its General Conditions of Service printed overleaf, available on request or accessible at <http://www.sgs.com.tw/Terms-and-Conditions> and for electronic format documents, subject to Terms and Conditions for Electronic Documents at <http://www.sgs.com.tw/Terms-and-Conditions>. Attention is drawn to the limitation of liability, indemnification and jurisdiction issues defined therein. Any holder of this document is advised that information contained hereon reflects the Company's findings at the time of its intervention only and within the limits of Client's instructions, if any. The Company's sole responsibility is to its Client and this document does not exonerate parties to a transaction from exercising all their rights and obligations under the transaction documents. This document cannot be reproduced except in full, without prior written approval of the Company. Any unauthorized alteration, forgery or falsification of the content or appearance of this document is unlawful and offenders may be prosecuted to the fullest extent of the law.

SGS Taiwan Ltd. No.2, Keji 1st Rd., Guishan District, Taoyuan City, Taiwan / 桃園市龜山區科技一路2號

台灣檢驗科技股份有限公司

t (886-2) 2299-3279

f (886-3) 327-7559

www.sgs.com.tw

Member of SGS Group



Config 5

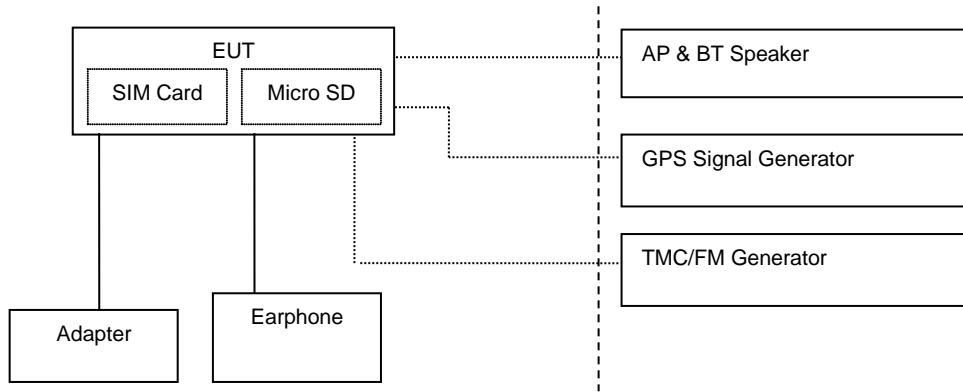

1.9 Measurement Procedure

Conducted Emission Testing was performed according to ANSI C63.4:2014 in a shielded room with peripherals placed on a table, 0.8m high over a metal floor. It was located more than required distance away from the shielded room wall.

Radiated Emission Testing was performed according to ANSI C63.4:2014 at the 3/10m semi-anechoic chamber. The EUT was placed on a 0.8m high table along with the peripherals. The turn table was placed 3/10m distance from the antenna. Cables were placed in a position to produce maximum emissions as determined by experimentation, and operation mode was selected for production of maximum emission.

The frequency and amplitude of the worse emissions were measured at varying azimuths, antenna heights and antenna polarities. Maximum emission levels are then reported.

1.10 Standards Applicable for Testing

Tests to be carried out under FCC Part 15 Subpart B/CISPR 22

| Test Standards | Status |
|-----------------------------------|--------------|
| FCC Part 15 Subpart B CISPR 22 | Applicable |
| Deviation from Standard | No deviation |

Unless otherwise stated the results shown in this test report refer only to the sample(s) tested and such sample(s) are retained for 90 days only.
除非另有說明，此報告結果僅對測試之樣品負責，同時此樣品僅保留90天。本報告未經本公司書面許可，不可部份複製。

This document is issued by the Company subject to its General Conditions of Service printed overleaf, available on request or accessible at <http://www.sgs.com.tw/Terms-and-Conditions> and for electronic format documents, subject to Terms and Conditions for Electronic Documents at <http://www.sgs.com.tw/Terms-and-Conditions>. Attention is drawn to the limitation of liability, indemnification and jurisdiction issues defined therein. Any holder of this document is advised that information contained hereon reflects the Company's findings at the time of its intervention only and within the limits of Client's instructions, if any. The Company's sole responsibility is to its Client and this document does not exonerate parties to a transaction from exercising all their rights and obligations under the transaction documents. This document cannot be reproduced except in full, without prior written approval of the Company. Any unauthorized alteration, forgery or falsification of the content or appearance of this document is unlawful and offenders may be prosecuted to the fullest extent of the law.



1.11 Decision Rules of Results

Reported measurement data comply with FCC Part 15 Subpart B
Determining compliance shall be based on the results of the compliance measurement, not taking into account measurement instrumentation uncertainty.

1.12 Summary of Results

| Standard | Test Type | Result |
|---------------------------------|--------------------|--------|
| FCC Part 15 Subpart B (Class B) | Conducted Emission | PASS |
| | Radiated Emission | PASS |

1.13 Reporting Statements of Conformity

The conformity statement in this report is based solely on the test results, measurement uncertainty is excluded.

Unless otherwise stated the results shown in this test report refer only to the sample(s) tested and such sample(s) are retained for 90 days only.
除非另有說明，此報告結果僅對測試之樣品負責，同時此樣品僅保留90天。本報告未經本公司書面許可，不可部份複製。

This document is issued by the Company subject to its General Conditions of Service printed overleaf, available on request or accessible at <http://www.sgs.com.tw/Terms-and-Conditions> and for electronic format documents, subject to Terms and Conditions for Electronic Documents at <http://www.sgs.com.tw/Terms-and-Conditions>. Attention is drawn to the limitation of liability, indemnification and jurisdiction issues defined therein. Any holder of this document is advised that information contained hereon reflects the Company's findings at the time of its intervention only and within the limits of Client's instructions, if any. The Company's sole responsibility is to its Client and this document does not exonerate parties to a transaction from exercising all their rights and obligations under the transaction documents. This document cannot be reproduced except in full, without prior written approval of the Company. Any unauthorized alteration, forgery or falsification of the content or appearance of this document is unlawful and offenders may be prosecuted to the fullest extent of the law.



2. EMISSION

2.1 Test Results

| | Results |
|--------------------|---------|
| Conducted Emission | Pass |
| Radiated Emission | Pass |

2.2 Frequency Range

FCC Part 15 Subpart B:

Conducted Emission : 150 kHz - 30 MHz

Radiated Emission : See below table

| Highest frequency generated or used in the device or on which the device operates or tunes (MHz) | Upper frequency of measurement range (MHz) |
|--|--|
| Below 1.705 | 30 |
| 1.705 - 108 | 1000 |
| 500 - 1000 | 2000 |
| Above 1000 | 5th harmonic of the highest frequency or 40 GHz, whichever is lower. |

Unless otherwise stated the results shown in this test report refer only to the sample(s) tested and such sample(s) are retained for 90 days only.
除非另有說明，此報告結果僅對測試之樣品負責，同時此樣品僅保留90天。本報告未經本公司書面許可，不可部份複製。

This document is issued by the Company subject to its General Conditions of Service printed overleaf, available on request or accessible at <http://www.sgs.com.tw/Terms-and-Conditions> and for electronic format documents, subject to Terms and Conditions for Electronic Documents at <http://www.sgs.com.tw/Terms-and-Conditions>. Attention is drawn to the limitation of liability, indemnification and jurisdiction issues defined therein. Any holder of this document is advised that information contained hereon reflects the Company's findings at the time of its intervention only and within the limits of Client's instructions, if any. The Company's sole responsibility is to its Client and this document does not exonerate parties to a transaction from exercising all their rights and obligations under the transaction documents. This document cannot be reproduced except in full, without prior written approval of the Company. Any unauthorized alteration, forgery or falsification of the content or appearance of this document is unlawful and offenders may be prosecuted to the fullest extent of the law.

SGS Taiwan Ltd. No.2, Keji 1st Rd., Guishan District, Taoyuan City, Taiwan / 桃園市龜山區科技一路2號

台灣檢驗科技股份有限公司

t (886-2) 2299-3279

f (886-3) 327-7559

www.sgs.com.tw

Member of SGS Group



2.3 Limits of Conducted and Radiated Emission

2.3.1 Limits of Conducted Emission

FCC Part 15 Subpart B

| FREQUENCY (MHz) | Class A (dBuV) | | Class B (dBuV) | |
|--------------------|----------------|---------|----------------|---------|
| | Quasi - peak | Average | Quasi - peak | Average |
| 0.15 - 0.5 | 79 | 66 | 66 - 56 | 56 - 46 |
| 0.50 - 5.0 | 73 | 60 | 56 | 46 |
| 5.0 - 30.0 | 73 | 60 | 60 | 50 |

Note : (1) The lower limit shall apply at the transition frequencies.

(2) The limit decreases linearly with the logarithm of the frequency in the range 0.15 to 0.50 MHz.

(3) All emanation from a class A/B digital device or system, including any network of conductors and apparatus connected there to, shall not exceed the level of field strengths specified above.

2.3.2 Limits of Radiated Emissions

FCC Part 15 Subpart B Limit:

- Detector Function : Quasi – Peak

| FREQUENCY (MHz) | Class A (at 10 m) | Class B (at 3 m) |
|--------------------|-------------------|------------------|
| | dBuV/m | dBuV/m |
| 30~88 | 39 | 40 |
| 88~216 | 43.5 | 43.5 |
| 216~960 | 46.4 | 46 |
| 960~1000 | 49.5 | 54 |

- Detector Function : Peak , Average

| FREQUENCY (MHz) | Class A (dBuV/m) (at 3 m) | | Class B (dBuV/m) (at 3 m) | |
|--------------------|---------------------------|---------|---------------------------|---------|
| | Peak | Average | Peak | Average |
| Above 1000 | 80 | 60 | 74 | 54 |

CISPR 22 Limit:

- Detector Function : Quasi – Peak

| FREQUENCY (MHz) | Class A (at 10 m) | Class B (at 10 m) |
|--------------------|-------------------|-------------------|
| | dBuV/m | dBuV/m |
| 30~230 | 40 | 30 |
| 230~1000 | 47 | 37 |

Note: 1. The lower limit shall apply at the transition frequency.

2. Additional provisions may be required for cases where interference occurs.

Unless otherwise stated the results shown in this test report refer only to the sample(s) tested and such sample(s) are retained for 90 days only.
除非另有說明，此報告結果僅對測試之樣品負責，同時此樣品僅保留90天。本報告未經本公司書面許可，不可部份複製。

This document is issued by the Company subject to its General Conditions of Service printed overleaf, available on request or accessible at <http://www.sgs.com.tw/Terms-and-Conditions> and for electronic format documents, subject to Terms and Conditions for Electronic Documents at <http://www.sgs.com.tw/Terms-and-Conditions>. Attention is drawn to the limitation of liability, indemnification and jurisdiction issues defined therein. Any holder of this document is advised that information contained hereon reflects the Company's findings at the time of its intervention only and within the limits of Client's instructions, if any. The Company's sole responsibility is to its Client and this document does not exonerate parties to a transaction from exercising all their rights and obligations under the transaction documents. This document cannot be reproduced except in full, without prior written approval of the Company. Any unauthorized alteration, forgery or falsification of the content or appearance of this document is unlawful and offenders may be prosecuted to the fullest extent of the law.



2.4. Test of Conducted Emission

2.4.1 Test Equipments

| SGS Conducted Emission HWAYA Conducted Room No.B EMC | | | | | |
|--|-----------------------|------------------|-----------------|------------------|-----------------|
| EQUIPMENT TYPE | Manufacturer | Model Number | Serial Number | Calibration Date | Calibration Due |
| EMI Test Receiver | R&S | ESCI 7 | 100924 | 2020/10/28 | 2021/10/27 |
| Coaxial Cables | EMC Instruments Corp. | EMC5D-BM-BM-3000 | 1401004 | 2020/5/25 | 2021/5/24 |
| Pulse Limiter | R&S | ESH3Z2 | 102099 | 2020/6/16 | 2021/6/15 |
| LISN | TESEQ | NNB 51 | 36061 | 2020/2/27 | 2021/2/26 |
| LISN | TESEQ | NNB 51 | 36062 | 2020/4/17 | 2021/4/16 |
| Communication Tester | R&S | CMU200 | 114273 | 2020/5/31 | 2021/5/30 |
| Communication Tester | R&S | CMW500 | 152303 | 2020/2/24 | 2021/2/23 |
| Communication Tester | Anritsu | MT8820C | 6201465315 | N.C.R. | N.C.R. |
| Test Software | Farad | EZ-EMC | Ver. SGS-03A2-5 | N.C.R. | N.C.R. |

Testing Site : No.2, Keji 1st Rd., Guishan District, Taoyuan City, Taiwan
 Measurement Uncertainty of Conducted Emission
 Expanded uncertainty Ulab (k=2) of Conducted Emission is 2.28 dB.
 Expanded uncertainty CISPR 16-4-2:2011+A1:2014+A2:2018 (k=2) of Conducted Emission measurement is 3.44 dB.

2.4.2 Measurement Level Calculation

Factor = LISN insertion loss + Cable loss + Pulse Limiter insertion loss

Measurement Level = Reading Level + Factor

Over (Margin) = Measurement Level – Limit

Unless otherwise stated the results shown in this test report refer only to the sample(s) tested and such sample(s) are retained for 90 days only.
 除非另有說明，此報告結果僅對測試之樣品負責，同時此樣品僅保留90天。本報告未經本公司書面許可，不可部份複製。

This document is issued by the Company subject to its General Conditions of Service printed overleaf, available on request or accessible at <http://www.sgs.com.tw/Terms-and-Conditions> and for electronic format documents, subject to Terms and Conditions for Electronic Documents at <http://www.sgs.com.tw/Terms-and-Conditions>. Attention is drawn to the limitation of liability, indemnification and jurisdiction issues defined therein. Any holder of this document is advised that information contained hereon reflects the Company's findings at the time of its intervention only and within the limits of Client's instructions, if any. The Company's sole responsibility is to its Client and this document does not exonerate parties to a transaction from exercising all their rights and obligations under the transaction documents. This document cannot be reproduced except in full, without prior written approval of the Company. Any unauthorized alteration, forgery or falsification of the content or appearance of this document is unlawful and offenders may be prosecuted to the fullest extent of the law.

SGS Taiwan Ltd. No.2, Keji 1st Rd., Guishan District, Taoyuan City, Taiwan / 桃園市龜山區科技一路2號

台灣檢驗科技股份有限公司

t (886-2) 2299-3279

f (886-3) 327-7559

www.sgs.com.tw

Member of SGS Group



2.4.3 Measurement Data:

Config_1_L

| | | |
|-----------------------------------|--------------------|-----------------------|
| Site: : Conduction Room B | Date: 2020/12/15 | Time: 下午 02:50:35 |
| Limit: FCC Class B Conduction(QP) | Phase: L1 | Temperature: 20 °C |
| Mode: Config 1 | Power: AC120V/60Hz | Humidity: 70 %RH |
| Report: MH-2020-B0179 | | Air Pressure: 990 hpa |
| Tester: Stan Lin | | |
| Note: | | |

SGS Taiwan Ltd.-Electromagnetic Compatibility Laboratory Address: No.2, Keji 1st Rd., Guishan District, Taoyuan City, Taiwan 333

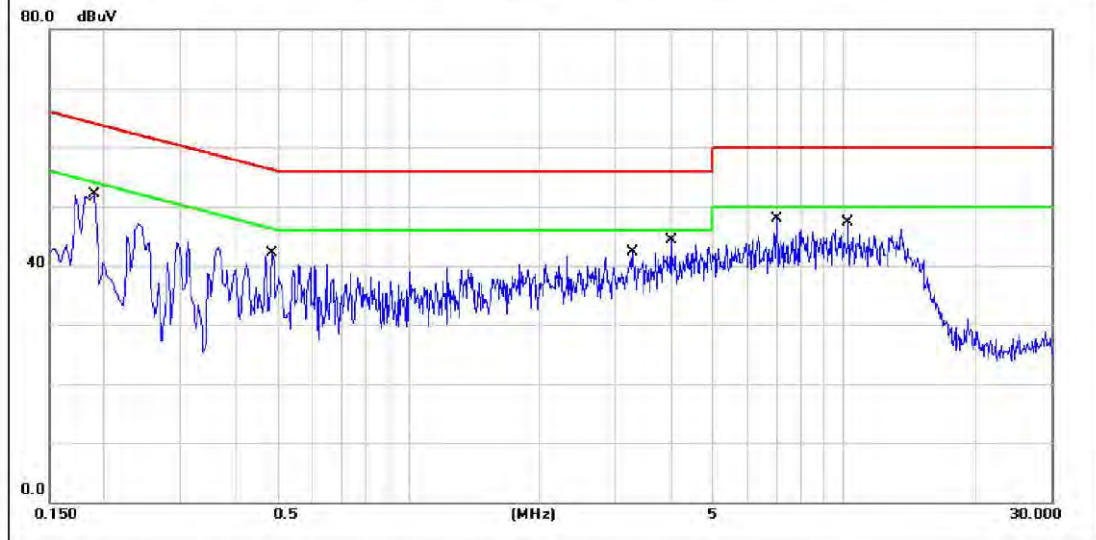

| No. | Mk | Freq. MHz | Reading (dBuV) | Factor (dB) | Measurement (dBuV) | Limit (dBuV) | Over (dB) | Detector | Comment |
|-----|----|--------------|-------------------|----------------|-----------------------|-----------------|--------------|----------|---------|
| 1 | | 0.1905 | 27.36 | 19.74 | 47.10 | 64.01 | -16.91 | QP | |
| 2 | | 0.1905 | 15.06 | 19.74 | 34.80 | 54.01 | -19.21 | AVG | |
| 3 | | 0.4875 | 17.18 | 20.30 | 37.48 | 56.21 | -18.73 | QP | |
| 4 | | 0.4875 | 8.40 | 20.30 | 28.70 | 46.21 | -17.51 | AVG | |
| 5 | | 3.2910 | 13.66 | 20.47 | 34.13 | 56.00 | -21.87 | QP | |
| 6 | | 3.2910 | 5.13 | 20.47 | 25.60 | 46.00 | -20.40 | AVG | |
| 7 | | 4.0065 | 18.39 | 20.31 | 38.70 | 56.00 | -17.30 | QP | |
| 8 | * | 4.0065 | 8.89 | 20.31 | 29.20 | 46.00 | -16.80 | AVG | |
| 9 | | 7.0620 | 17.11 | 20.07 | 37.18 | 60.00 | -22.82 | QP | |
| 10 | | 7.0620 | 8.40 | 20.07 | 28.47 | 50.00 | -21.53 | AVG | |
| 11 | | 10.2390 | 17.27 | 20.04 | 37.31 | 60.00 | -22.69 | QP | |
| 12 | | 10.2390 | 7.78 | 20.04 | 27.82 | 50.00 | -22.18 | AVG | |

*:Maximum data x:Over limit l:over margin

Unless otherwise stated the results shown in this test report refer only to the sample(s) tested and such sample(s) are retained for 90 days only.
 除非另有說明，此報告結果僅對測試之樣品負責，同時此樣品僅保留90天。本報告未經本公司書面許可，不可部份複製。
 This document is issued by the Company subject to its General Conditions of Service printed overleaf, available on request or accessible at <http://www.sgs.com.tw/Terms-and-Conditions> and for electronic format documents, subject to Terms and Conditions for Electronic Documents at <http://www.sgs.com.tw/Terms-and-Conditions>. Attention is drawn to the limitation of liability, indemnification and jurisdiction issues defined therein. Any holder of this document is advised that information contained hereon reflects the Company's findings at the time of its intervention only and within the limits of Client's instructions, if any. The Company's sole responsibility is to its Client and this document does not exonerate parties to a transaction from exercising all their rights and obligations under the transaction documents. This document cannot be reproduced except in full, without prior written approval of the Company. Any unauthorized alteration, forgery or falsification of the content or appearance of this document is unlawful and offenders may be prosecuted to the fullest extent of the law.



Config_1_N

Site: : Conduction Room B Date: 2020/12/15 Time: 下午 02:54:39
 Limit: FCC Class B Conduction(QP) Phase: N Temperature: 20 °C
 Mode: Config 1 Power: AC120V/60Hz Humidity: 70 %RH
 Report: MH-2020-B0179 Tester: Stan Lin Air Pressure: 990 hpa
 Note:

SGS Taiwan Ltd.-Electromagnetic Compatibility Laboratory Address: No.2, Keji 1st Rd., Guishan District, Taoyuan City, Taiwan 333

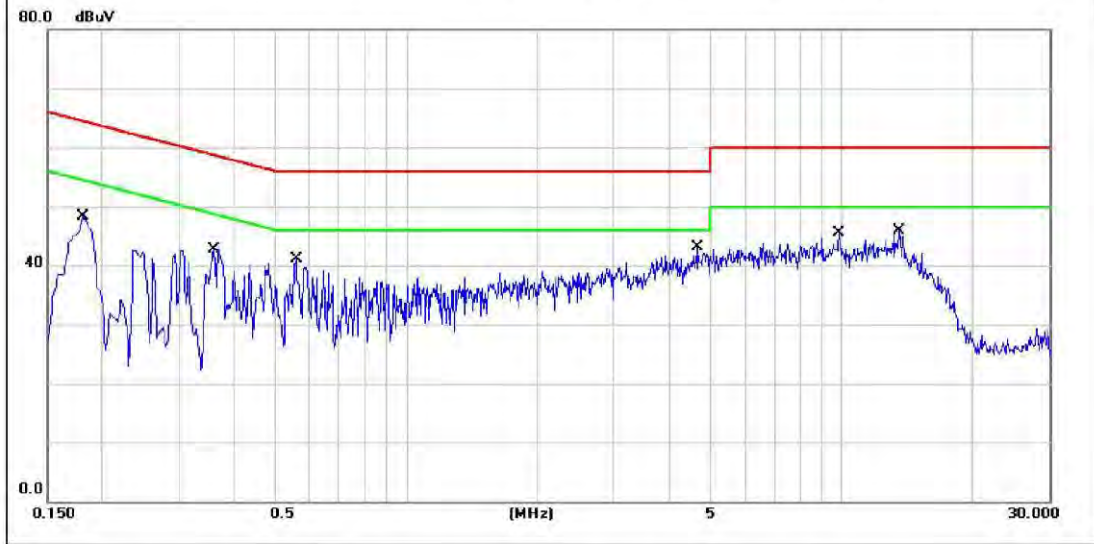

| No. | Mk | Freq. | Reading | Factor | Measurement | Limit | Over | Detector | Comment |
|-----|----|---------|---------|--------|-------------|--------|--------|----------|---------|
| | | MHz | (dBuV) | (dB) | (dBuV) | (dBuV) | (dB) | | |
| 1 | | 0.1815 | 25.87 | 19.74 | 45.61 | 64.42 | -18.81 | QP | |
| 2 | | 0.1815 | 13.75 | 19.74 | 33.49 | 54.42 | -20.93 | AVG | |
| 3 | | 0.3615 | 20.96 | 20.04 | 41.00 | 58.69 | -17.69 | QP | |
| 4 | * | 0.3615 | 11.13 | 20.04 | 31.17 | 48.69 | -17.52 | AVG | |
| 5 | | 0.5595 | 16.17 | 20.27 | 36.44 | 56.00 | -19.56 | QP | |
| 6 | | 0.5595 | 3.50 | 20.27 | 23.77 | 46.00 | -22.23 | AVG | |
| 7 | | 4.6860 | 16.41 | 20.15 | 36.56 | 56.00 | -19.44 | QP | |
| 8 | | 4.6860 | 6.85 | 20.15 | 27.00 | 46.00 | -19.00 | AVG | |
| 9 | | 9.8610 | 16.92 | 20.03 | 36.95 | 60.00 | -23.05 | QP | |
| 10 | | 9.8610 | 7.55 | 20.03 | 27.58 | 50.00 | -22.42 | AVG | |
| 11 | | 13.5825 | 17.18 | 20.12 | 37.30 | 60.00 | -22.70 | QP | |
| 12 | | 13.5825 | 6.09 | 20.12 | 26.21 | 50.00 | -23.79 | AVG | |

*:Maximum data x:Over limit l:over margin

Unless otherwise stated the results shown in this test report refer only to the sample(s) tested and such sample(s) are retained for 90 days only.

除非另有說明，此報告結果僅對測試之樣品負責，同時此樣品僅保留90天。本報告未經本公司書面許可，不可部份複製。
 This document is issued by the Company subject to its General Conditions of Service printed overleaf, available on request or accessible at <http://www.sgs.com.tw/Terms-and-Conditions> and for electronic format documents, subject to Terms and Conditions for Electronic Documents at <http://www.sgs.com.tw/Terms-and-Conditions>. Attention is drawn to the limitation of liability, indemnification and jurisdiction issues defined therein. Any holder of this document is advised that information contained hereon reflects the Company's findings at the time of its intervention only and within the limits of Client's instructions, if any. The Company's sole responsibility is to its Client and this document does not exonerate parties to a transaction from exercising all their rights and obligations under the transaction documents. This document cannot be reproduced except in full, without prior written approval of the Company. Any unauthorized alteration, forgery or falsification of the content or appearance of this document is unlawful and offenders may be prosecuted to the fullest extent of the law.



Config_2_L

| | | |
|-----------------------------------|--------------------|-----------------------|
| Site: : Conduction Room B | Date: 2020/12/15 | Time: 下午 03:30:31 |
| Limit: FCC Class B Conduction(QP) | Phase: L1 | Temperature: 20 °C |
| Mode: Config 2 | Power: AC120V/60Hz | Humidity: 70 %RH |
| Report: MH-2020-B0179 | | Air Pressure: 990 hpa |
| Tester: Stan Lin | | |
| Note: | | |

SGS Taiwan Ltd.-Electromagnetic Compatibility Laboratory Address: No.2, Keji 1st Rd., Guishan District, Taoyuan City, Taiwan 333

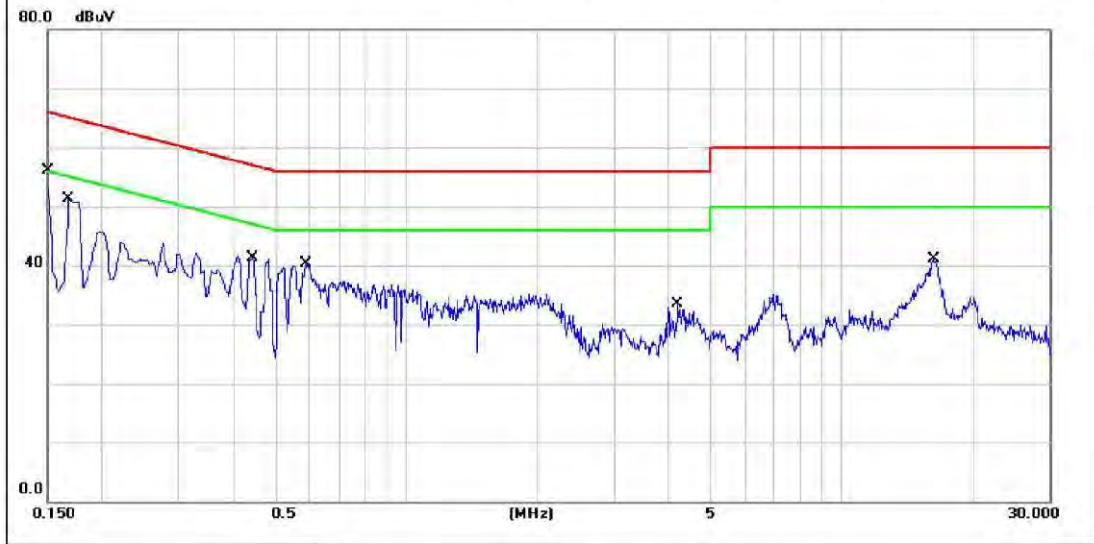

| No. | Mk | Freq. | Reading | Factor | Measurement | Limit | Over | Detector | Comment |
|-----|----|---------|---------|--------|-------------|--------|--------|----------|---------|
| | | MHz | (dBuV) | (dB) | (dBuV) | (dBuV) | (dB) | | |
| 1 | | 0.1500 | 33.22 | 19.76 | 52.98 | 66.00 | -13.02 | QP | |
| 2 | | 0.1500 | 19.91 | 19.76 | 39.67 | 56.00 | -16.33 | AVG | |
| 3 | | 0.1680 | 28.85 | 19.75 | 48.60 | 65.06 | -16.46 | QP | |
| 4 | | 0.1680 | 17.65 | 19.75 | 37.40 | 55.06 | -17.66 | AVG | |
| 5 | | 0.4425 | 19.60 | 20.21 | 39.81 | 57.01 | -17.20 | QP | |
| 6 | * | 0.4425 | 16.60 | 20.21 | 36.81 | 47.01 | -10.20 | AVG | |
| 7 | | 0.5910 | 16.23 | 20.26 | 36.49 | 56.00 | -19.51 | QP | |
| 8 | | 0.5910 | 10.11 | 20.26 | 30.37 | 46.00 | -15.63 | AVG | |
| 9 | | 4.2135 | 5.81 | 20.26 | 26.07 | 56.00 | -29.93 | QP | |
| 10 | | 4.2135 | -0.43 | 20.26 | 19.83 | 46.00 | -26.17 | AVG | |
| 11 | | 16.3680 | 16.20 | 20.17 | 36.37 | 60.00 | -23.63 | QP | |
| 12 | | 16.3680 | 7.71 | 20.17 | 27.88 | 50.00 | -22.12 | AVG | |

*:Maximum data x:Over limit l:over margin

Unless otherwise stated the results shown in this test report refer only to the sample(s) tested and such sample(s) are retained for 90 days only.
 除非另有說明，此報告結果僅對測試之樣品負責，同時此樣品僅保留90天。本報告未經本公司書面許可，不可部份複製。
 This document is issued by the Company subject to its General Conditions of Service printed overleaf, available on request or accessible at <http://www.sgs.com.tw/Terms-and-Conditions> and for electronic format documents, subject to Terms and Conditions for Electronic Documents at <http://www.sgs.com.tw/Terms-and-Conditions>. Attention is drawn to the limitation of liability, indemnification and jurisdiction issues defined therein. Any holder of this document is advised that information contained hereon reflects the Company's findings at the time of its intervention only and within the limits of Client's instructions, if any. The Company's sole responsibility is to its Client and this document does not exonerate parties to a transaction from exercising all their rights and obligations under the transaction documents. This document cannot be reproduced except in full, without prior written approval of the Company. Any unauthorized alteration, forgery or falsification of the content or appearance of this document is unlawful and offenders may be prosecuted to the fullest extent of the law.



Config_2_N

| | | |
|-----------------------------------|--------------------|-----------------------|
| Site: : Conduction Room B | Date: 2020/12/15 | Time: 下午 03:34:34 |
| Limit: FCC Class B Conduction(QP) | Phase: N | Temperature: 20 °C |
| Mode: Config 2 | Power: AC120V/60Hz | Humidity: 70 %RH |
| Report: MH-2020-B0179 | | Air Pressure: 990 hpa |
| Tester: Stan Lin | | |
| Note: | | |

SGS Taiwan Ltd.-Electromagnetic Compatibility Laboratory Address: No.2, Keji 1st Rd., Guishan District, Taoyuan City, Taiwan 333

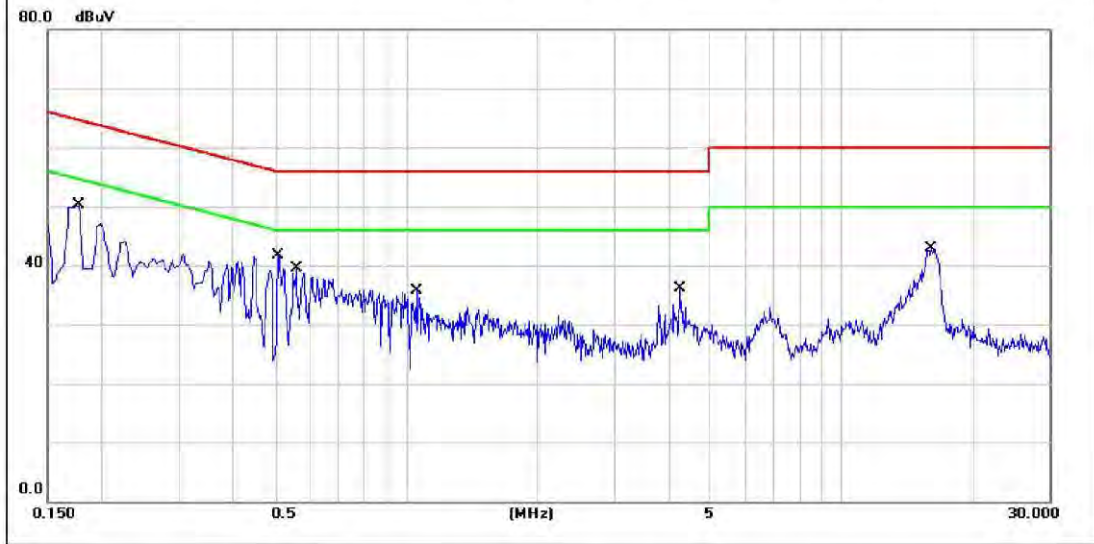

| No. | Mk | Freq. | Reading | Factor | Measurement | Limit | Over | Detector | Comment |
|-----|----|---------|---------|--------|-------------|--------|--------|----------|---------|
| | | MHz | (dBuV) | (dB) | (dBuV) | (dBuV) | (dB) | | |
| 1 | | 0.1770 | 29.06 | 19.74 | 48.80 | 64.63 | -15.83 | QP | |
| 2 | | 0.1770 | 18.56 | 19.74 | 38.30 | 54.63 | -16.33 | AVG | |
| 3 | | 0.5100 | 18.91 | 20.31 | 39.22 | 56.00 | -16.78 | QP | |
| 4 | * | 0.5100 | 14.89 | 20.31 | 35.20 | 46.00 | -10.80 | AVG | |
| 5 | | 0.5595 | 16.78 | 20.27 | 37.05 | 56.00 | -18.95 | QP | |
| 6 | | 0.5595 | 9.94 | 20.27 | 30.21 | 46.00 | -15.79 | AVG | |
| 7 | | 1.0545 | 10.02 | 19.97 | 29.99 | 56.00 | -26.01 | QP | |
| 8 | | 1.0545 | 3.83 | 19.97 | 23.80 | 46.00 | -22.20 | AVG | |
| 9 | | 4.2540 | 5.25 | 20.24 | 25.49 | 56.00 | -30.51 | QP | |
| 10 | | 4.2540 | -1.13 | 20.24 | 19.11 | 46.00 | -26.89 | AVG | |
| 11 | | 16.0575 | 17.64 | 20.18 | 37.82 | 60.00 | -22.18 | QP | |
| 12 | | 16.0575 | 8.22 | 20.18 | 28.40 | 50.00 | -21.60 | AVG | |

*:Maximum data x:Over limit l:over margin

Unless otherwise stated the results shown in this test report refer only to the sample(s) tested and such sample(s) are retained for 90 days only.
 除非另有說明，此報告結果僅對測試之樣品負責，同時此樣品僅保留90天。本報告未經本公司書面許可，不可部份複製。
 This document is issued by the Company subject to its General Conditions of Service printed overleaf, available on request or accessible at <http://www.sgs.com.tw/Terms-and-Conditions> and for electronic format documents, subject to Terms and Conditions for Electronic Documents at <http://www.sgs.com.tw/Terms-and-Conditions>. Attention is drawn to the limitation of liability, indemnification and jurisdiction issues defined therein. Any holder of this document is advised that information contained hereon reflects the Company's findings at the time of its intervention only and within the limits of Client's instructions, if any. The Company's sole responsibility is to its Client and this document does not exonerate parties to a transaction from exercising all their rights and obligations under the transaction documents. This document cannot be reproduced except in full, without prior written approval of the Company. Any unauthorized alteration, forgery or falsification of the content or appearance of this document is unlawful and offenders may be prosecuted to the fullest extent of the law.



Config_3_L

Site: : Conduction Room B Date: 2020/12/15 Time: 下午 03:03:37
 Limit: FCC Class B Conduction(QP) Phase: **L1** Temperature: 20 °C
 Mode: Config 3 Power: AC120V/60Hz Humidity: 70 %RH
 Report: MH-2020-B0179 Tester: Stan Lin Air Pressure: 990 hpa
 Note:

SGS Taiwan Ltd.-Electromagnetic Compatibility Laboratory Address: No.2, Keji 1st Rd., Guishan District, Taoyuan City, Taiwan 333

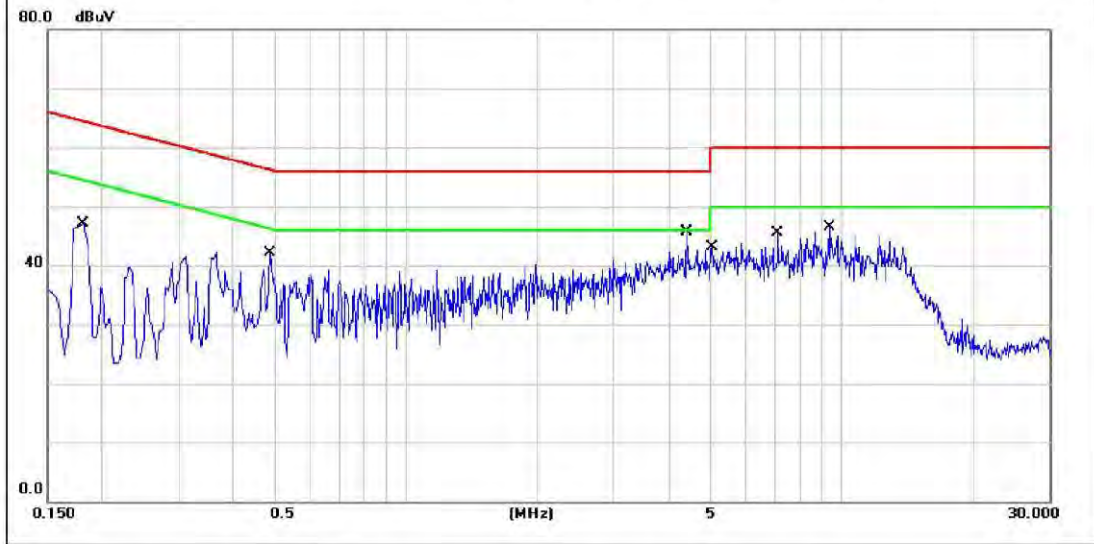

| No. | Mk | Freq. | Reading | Factor | Measurement | Limit | Over | Detector | Comment |
|-----|----|--------|---------|--------|-------------|--------|--------|----------|---------|
| | | MHz | (dBuV) | (dB) | (dBuV) | (dBuV) | (dB) | | |
| 1 | | 0.1815 | 24.47 | 19.75 | 44.22 | 64.42 | -20.20 | QP | |
| 2 | | 0.1815 | 13.45 | 19.75 | 33.20 | 54.42 | -21.22 | AVG | |
| 3 | | 0.4875 | 16.10 | 20.30 | 36.40 | 56.21 | -19.81 | QP | |
| 4 | * | 0.4875 | 8.50 | 20.30 | 28.80 | 46.21 | -17.41 | AVG | |
| 5 | | 4.4205 | 15.41 | 20.22 | 35.63 | 56.00 | -20.37 | QP | |
| 6 | | 4.4205 | 6.58 | 20.22 | 26.80 | 46.00 | -19.20 | AVG | |
| 7 | | 5.0505 | 15.66 | 20.09 | 35.75 | 60.00 | -24.25 | QP | |
| 8 | | 5.0505 | 7.69 | 20.09 | 27.78 | 50.00 | -22.22 | AVG | |
| 9 | | 7.1700 | 15.86 | 20.07 | 35.93 | 60.00 | -24.07 | QP | |
| 10 | | 7.1700 | 7.85 | 20.07 | 27.92 | 50.00 | -22.08 | AVG | |
| 11 | | 9.3570 | 15.72 | 20.04 | 35.76 | 60.00 | -24.24 | QP | |
| 12 | | 9.3570 | 7.70 | 20.04 | 27.74 | 50.00 | -22.26 | AVG | |

*:Maximum data x:Over limit l:over margin

Unless otherwise stated the results shown in this test report refer only to the sample(s) tested and such sample(s) are retained for 90 days only.
 除非另有說明，此報告結果僅對測試之樣品負責，同時此樣品僅保留90天。本報告未經本公司書面許可，不可部份複製。

This document is issued by the Company subject to its General Conditions of Service printed overleaf, available on request or accessible at <http://www.sgs.com.tw/Terms-and-Conditions> and for electronic format documents, subject to Terms and Conditions for Electronic Documents at <http://www.sgs.com.tw/Terms-and-Conditions>. Attention is drawn to the limitation of liability, indemnification and jurisdiction issues defined therein. Any holder of this document is advised that information contained hereon reflects the Company's findings at the time of its intervention only and within the limits of Client's instructions, if any. The Company's sole responsibility is to its Client and this document does not exonerate parties to a transaction from exercising all their rights and obligations under the transaction documents. This document cannot be reproduced except in full, without prior written approval of the Company. Any unauthorized alteration, forgery or falsification of the content or appearance of this document is unlawful and offenders may be prosecuted to the fullest extent of the law.



Config_3_N

| | | |
|-----------------------------------|--------------------|-----------------------|
| Site: : Conduction Room B | Date: 2020/12/15 | Time: 下午 03:07:12 |
| Limit: FCC Class B Conduction(QP) | Phase: N | Temperature: 20 °C |
| Mode: Config 3 | Power: AC120V/60Hz | Humidity: 70 %RH |
| Report: MH-2020-B0179 | | Air Pressure: 990 hpa |
| Tester: Stan Lin | | |
| Note: | | |

SGS Taiwan Ltd.-Electromagnetic Compatibility Laboratory Address: No.2, Keji 1st Rd., Guishan District, Taoyuan City, Taiwan 333

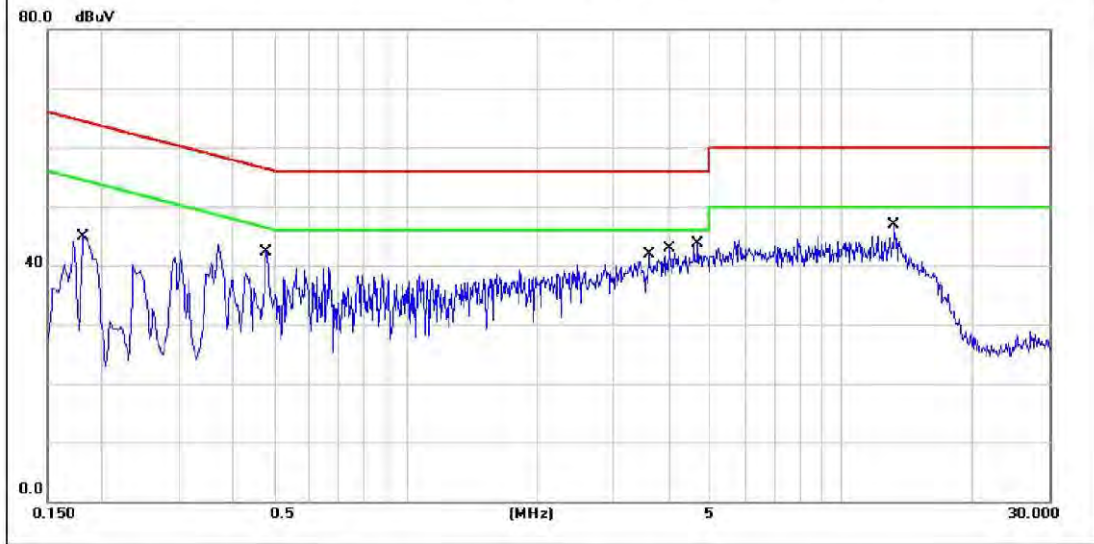

| No. | Mk | Freq. | Reading | Factor | Measurement | Limit | Over | Detector | Comment |
|-----|----|---------|---------|--------|-------------|--------|--------|----------|---------|
| | | MHz | (dBuV) | (dB) | (dBuV) | (dBuV) | (dB) | | |
| 1 | | 0.1815 | 22.95 | 19.74 | 42.69 | 64.42 | -21.73 | QP | |
| 2 | | 0.1815 | 11.83 | 19.74 | 31.57 | 54.42 | -22.85 | AVG | |
| 3 | | 0.4785 | 17.41 | 20.28 | 37.69 | 56.37 | -18.68 | QP | |
| 4 | * | 0.4785 | 7.82 | 20.28 | 28.10 | 46.37 | -18.27 | AVG | |
| 5 | | 3.6105 | 15.11 | 20.39 | 35.50 | 56.00 | -20.50 | QP | |
| 6 | | 3.6105 | 6.21 | 20.39 | 26.60 | 46.00 | -19.40 | AVG | |
| 7 | | 4.0245 | 15.21 | 20.30 | 35.51 | 56.00 | -20.49 | QP | |
| 8 | | 4.0245 | 6.33 | 20.30 | 26.63 | 46.00 | -19.37 | AVG | |
| 9 | | 4.6770 | 17.47 | 20.16 | 37.63 | 56.00 | -18.37 | QP | |
| 10 | | 4.6770 | 7.40 | 20.16 | 27.56 | 46.00 | -18.44 | AVG | |
| 11 | | 13.2000 | 17.17 | 20.11 | 37.28 | 60.00 | -22.72 | QP | |
| 12 | | 13.2000 | 6.52 | 20.11 | 26.63 | 50.00 | -23.37 | AVG | |

*:Maximum data x:Over limit l:over margin

Unless otherwise stated the results shown in this test report refer only to the sample(s) tested and such sample(s) are retained for 90 days only.
 除非另有說明，此報告結果僅對測試之樣品負責，同時此樣品僅保留90天。本報告未經本公司書面許可，不可部份複製。
 This document is issued by the Company subject to its General Conditions of Service printed overleaf, available on request or accessible at <http://www.sgs.com.tw/Terms-and-Conditions> and for electronic format documents, subject to Terms and Conditions for Electronic Documents at <http://www.sgs.com.tw/Terms-and-Conditions>. Attention is drawn to the limitation of liability, indemnification and jurisdiction issues defined therein. Any holder of this document is advised that information contained hereon reflects the Company's findings at the time of its intervention only and within the limits of Client's instructions, if any. The Company's sole responsibility is to its Client and this document does not exonerate parties to a transaction from exercising all their rights and obligations under the transaction documents. This document cannot be reproduced except in full, without prior written approval of the Company. Any unauthorized alteration, forgery or falsification of the content or appearance of this document is unlawful and offenders may be prosecuted to the fullest extent of the law.



Config_4_L

| | | |
|-----------------------------------|--------------------|-----------------------|
| Site: : Conduction Room B | Date: 2020/12/15 | Time: 下午 03:11:08 |
| Limit: FCC Class B Conduction(QP) | Phase: L1 | Temperature: 20 °C |
| Mode: Config 4 | Power: AC120V/60Hz | Humidity: 70 %RH |
| Report: MH-2020-B0179 | | Air Pressure: 990 hpa |
| Tester: Stan Lin | | |
| Note: | | |

SGS Taiwan Ltd.-Electromagnetic Compatibility Laboratory Address: No.2, Keji 1st Rd., Guishan District, Taoyuan City, Taiwan 333

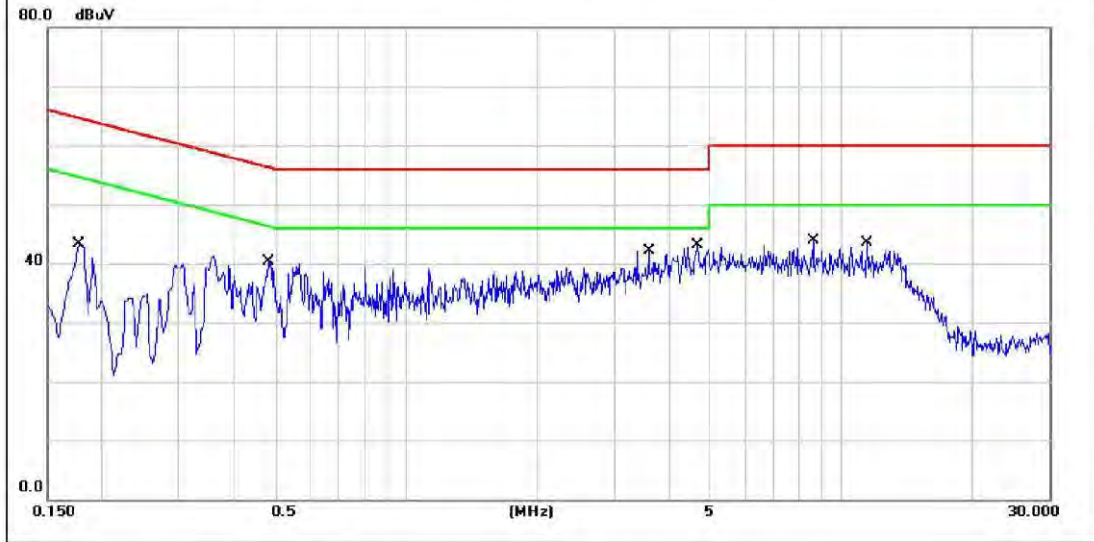

| No. | Mk | Freq. | Reading | Factor | Measurement | Limit | Over | Detector | Comment |
|-----|----|---------|---------|--------|-------------|--------|--------|----------|---------|
| | | MHz | (dBuV) | (dB) | (dBuV) | (dBuV) | (dB) | | |
| 1 | | 0.1770 | 20.16 | 19.75 | 39.91 | 64.63 | -24.72 | QP | |
| 2 | | 0.1770 | 9.86 | 19.75 | 29.61 | 54.63 | -25.02 | AVG | |
| 3 | | 0.4830 | 16.70 | 20.30 | 37.00 | 56.29 | -19.29 | QP | |
| 4 | * | 0.4830 | 8.90 | 20.30 | 29.20 | 46.29 | -17.09 | AVG | |
| 5 | | 3.6060 | 14.39 | 20.41 | 34.80 | 56.00 | -21.20 | QP | |
| 6 | | 3.6060 | 5.62 | 20.41 | 26.03 | 46.00 | -19.97 | AVG | |
| 7 | | 4.6905 | 17.14 | 20.16 | 37.30 | 56.00 | -18.70 | QP | |
| 8 | | 4.6905 | 7.64 | 20.16 | 27.80 | 46.00 | -18.20 | AVG | |
| 9 | | 8.6190 | 14.10 | 20.06 | 34.16 | 60.00 | -25.84 | QP | |
| 10 | | 8.6190 | 7.07 | 20.06 | 27.13 | 50.00 | -22.87 | AVG | |
| 11 | | 11.4855 | 13.35 | 20.07 | 33.42 | 60.00 | -26.58 | QP | |
| 12 | | 11.4855 | 5.65 | 20.07 | 25.72 | 50.00 | -24.28 | AVG | |

*:Maximum data x:Over limit l:over margin

Unless otherwise stated the results shown in this test report refer only to the sample(s) tested and such sample(s) are retained for 90 days only.

除非另有說明，此報告結果僅對測試之樣品負責，同時此樣品僅保留90天。本報告未經本公司書面許可，不可部份複製。
 This document is issued by the Company subject to its General Conditions of Service printed overleaf, available on request or accessible at <http://www.sgs.com.tw/Terms-and-Conditions> and for electronic format documents, subject to Terms and Conditions for Electronic Documents at <http://www.sgs.com.tw/Terms-and-Conditions>. Attention is drawn to the limitation of liability, indemnification and jurisdiction issues defined therein. Any holder of this document is advised that information contained hereon reflects the Company's findings at the time of its intervention only and within the limits of Client's instructions, if any. The Company's sole responsibility is to its Client and this document does not exonerate parties to a transaction from exercising all their rights and obligations under the transaction documents. This document cannot be reproduced except in full, without prior written approval of the Company. Any unauthorized alteration, forgery or falsification of the content or appearance of this document is unlawful and offenders may be prosecuted to the fullest extent of the law.



Config_4_N

Site: : Conduction Room B Date: 2020/12/15 Time: 下午 03:14:57
 Limit: FCC Class B Conduction(QP) Phase: N Temperature: 20 °C
 Mode: Config 4 Power: AC120V/60Hz Humidity: 70 %RH
 Report: MH-2020-B0179 Tester: Stan Lin Air Pressure: 990 hpa
 Note:

SGS Taiwan Ltd.-Electromagnetic Compatibility Laboratory Address: No.2, Keji 1st Rd., Guishan District, Taoyuan City, Taiwan 333

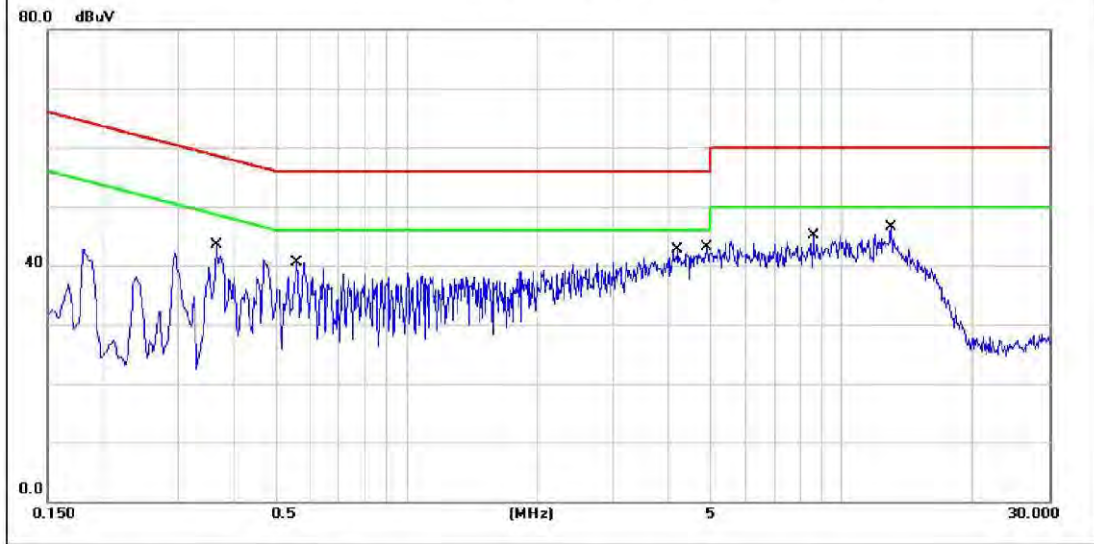

| No. | Mk | Freq. | Reading | Factor | Measurement | Limit | Over | Detector | Comment |
|-----|----|---------|---------|--------|-------------|--------|--------|----------|---------|
| | | MHz | (dBuV) | (dB) | (dBuV) | (dBuV) | (dB) | | |
| 1 | | 0.3660 | 19.88 | 20.05 | 39.93 | 58.59 | -18.66 | QP | |
| 2 | | 0.3660 | 9.34 | 20.05 | 29.39 | 48.59 | -19.20 | AVG | |
| 3 | | 0.5595 | 15.92 | 20.27 | 36.19 | 56.00 | -19.81 | QP | |
| 4 | | 0.5595 | 3.67 | 20.27 | 23.94 | 46.00 | -22.06 | AVG | |
| 5 | | 4.2090 | 15.85 | 20.25 | 36.10 | 56.00 | -19.90 | QP | |
| 6 | | 4.2090 | 6.97 | 20.25 | 27.22 | 46.00 | -18.78 | AVG | |
| 7 | | 4.9064 | 17.80 | 20.10 | 37.90 | 56.00 | -18.10 | QP | |
| 8 | * | 4.9064 | 8.20 | 20.10 | 28.30 | 46.00 | -17.70 | AVG | |
| 9 | | 8.5965 | 17.29 | 20.05 | 37.34 | 60.00 | -22.66 | QP | |
| 10 | | 8.5965 | 8.22 | 20.05 | 28.27 | 50.00 | -21.73 | AVG | |
| 11 | | 13.0470 | 18.53 | 20.11 | 38.64 | 60.00 | -21.36 | QP | |
| 12 | | 13.0470 | 6.68 | 20.11 | 26.79 | 50.00 | -23.21 | AVG | |

*:Maximum data x:Over limit l:over margin

Unless otherwise stated the results shown in this test report refer only to the sample(s) tested and such sample(s) are retained for 90 days only.
 除非另有說明，此報告結果僅對測試之樣品負責，同時此樣品僅保留90天。本報告未經本公司書面許可，不可部份複製。

This document is issued by the Company subject to its General Conditions of Service printed overleaf, available on request or accessible at <http://www.sgs.com.tw/Terms-and-Conditions> and for electronic format documents, subject to Terms and Conditions for Electronic Documents at <http://www.sgs.com.tw/Terms-and-Conditions>. Attention is drawn to the limitation of liability, indemnification and jurisdiction issues defined therein. Any holder of this document is advised that information contained hereon reflects the Company's findings at the time of its intervention only and within the limits of Client's instructions, if any. The Company's sole responsibility is to its Client and this document does not exonerate parties to a transaction from exercising all their rights and obligations under the transaction documents. This document cannot be reproduced except in full, without prior written approval of the Company. Any unauthorized alteration, forgery or falsification of the content or appearance of this document is unlawful and offenders may be prosecuted to the fullest extent of the law.



Config_5_L

Site: : Conduction Room B Date: 2020/12/15 Time: 下午 03:18:25
 Limit: FCC Class B Conduction(QP) Phase: L1 Temperature: 20 °C
 Mode: Config 5 Power: AC120V/60Hz Humidity: 70 %RH
 Report: MH-2020-B0179 Tester: Stan Lin Air Pressure: 990 hpa
 Note:

SGS Taiwan Ltd.-Electromagnetic Compatibility Laboratory Address: No.2, Keji 1st Rd., Guishan District, Taoyuan City, Taiwan 333

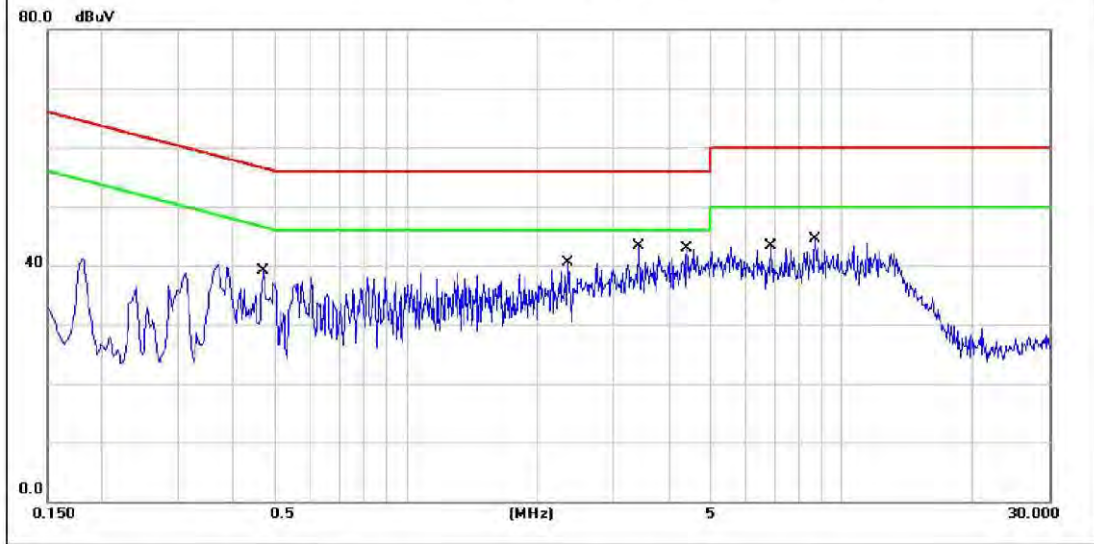

| No. | Mk | Freq. | Reading | Factor | Measurement | Limit | Over | Detector | Comment |
|-----|----|--------|---------|--------|-------------|--------|--------|----------|---------|
| | | MHz | (dBuV) | (dB) | (dBuV) | (dBuV) | (dB) | | |
| 1 | | 0.4695 | 16.13 | 20.27 | 36.40 | 56.52 | -20.12 | QP | |
| 2 | * | 0.4695 | 8.83 | 20.27 | 29.10 | 46.52 | -17.42 | AVG | |
| 3 | | 2.3550 | 12.52 | 20.68 | 33.20 | 56.00 | -22.80 | QP | |
| 4 | | 2.3550 | 4.12 | 20.68 | 24.80 | 46.00 | -21.20 | AVG | |
| 5 | | 3.4215 | 14.20 | 20.44 | 34.64 | 56.00 | -21.36 | QP | |
| 6 | | 3.4215 | 4.88 | 20.44 | 25.32 | 46.00 | -20.68 | AVG | |
| 7 | | 4.4205 | 16.08 | 20.22 | 36.30 | 56.00 | -19.70 | QP | |
| 8 | | 4.4205 | 6.68 | 20.22 | 26.90 | 46.00 | -19.10 | AVG | |
| 9 | | 6.9045 | 15.33 | 20.07 | 35.40 | 60.00 | -24.60 | QP | |
| 10 | | 6.9045 | 7.84 | 20.07 | 27.91 | 50.00 | -22.09 | AVG | |
| 11 | | 8.7225 | 15.03 | 20.06 | 35.09 | 60.00 | -24.91 | QP | |
| 12 | | 8.7225 | 7.60 | 20.06 | 27.66 | 50.00 | -22.34 | AVG | |

*:Maximum data x:Over limit l:over margin

Unless otherwise stated the results shown in this test report refer only to the sample(s) tested and such sample(s) are retained for 90 days only.

除非另有說明，此報告結果僅對測試之樣品負責，同時此樣品僅保留90天。本報告未經本公司書面許可，不可部份複製。
 This document is issued by the Company subject to its General Conditions of Service printed overleaf, available on request or accessible at <http://www.sgs.com.tw/Terms-and-Conditions> and for electronic format documents, subject to Terms and Conditions for Electronic Documents at <http://www.sgs.com.tw/Terms-and-Conditions>. Attention is drawn to the limitation of liability, indemnification and jurisdiction issues defined therein. Any holder of this document is advised that information contained hereon reflects the Company's findings at the time of its intervention only and within the limits of Client's instructions, if any. The Company's sole responsibility is to its Client and this document does not exonerate parties to a transaction from exercising all their rights and obligations under the transaction documents. This document cannot be reproduced except in full, without prior written approval of the Company. Any unauthorized alteration, forgery or falsification of the content or appearance of this document is unlawful and offenders may be prosecuted to the fullest extent of the law.



Config_5_N

Site: : Conduction Room B Date: 2020/12/15 Time: 下午 03:22:15
 Limit: FCC Class B Conduction(QP) Phase: N Temperature: 20 °C
 Mode: Config 5 Power: AC120V/60Hz Humidity: 70 %RH
 Report: MH-2020-B0179 Tester: Stan Lin Air Pressure: 990 hpa
 Note:

SGS Taiwan Ltd.-Electromagnetic Compatibility Laboratory Address: No.2, Keji 1st Rd., Guishan District, Taoyuan City, Taiwan 333

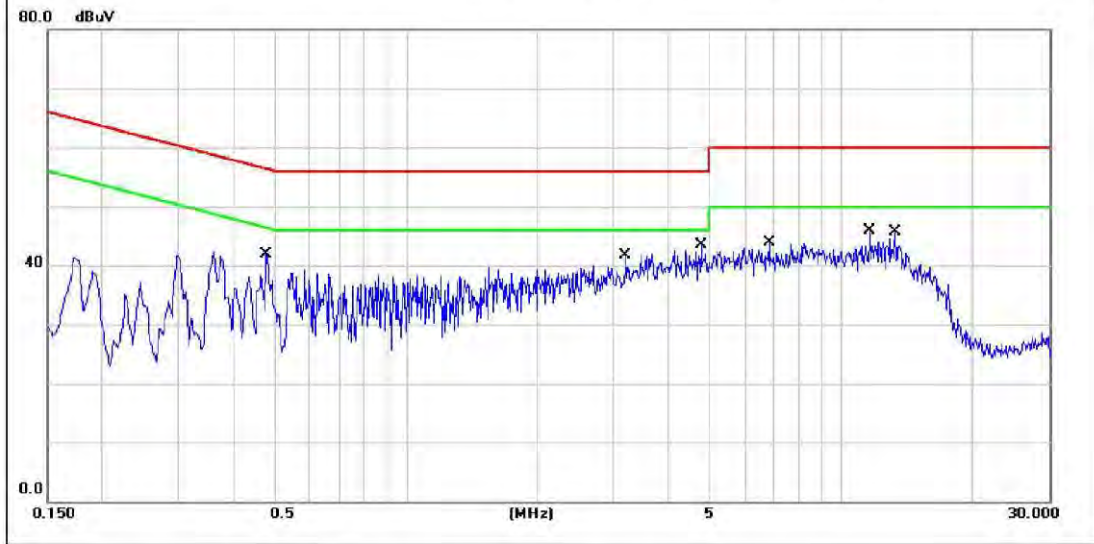

| No. | Mk | Freq. MHz | Reading (dBuV) | Factor (dB) | Measurement (dBuV) | Limit (dBuV) | Over (dB) | Detector | Comment |
|-----|----|--------------|-------------------|----------------|-----------------------|-----------------|--------------|----------|---------|
| 1 | | 0.4785 | 17.62 | 20.28 | 37.90 | 56.37 | -18.47 | QP | |
| 2 | | 0.4785 | 7.49 | 20.28 | 27.77 | 46.37 | -18.60 | AVG | |
| 3 | | 3.2055 | 14.30 | 20.48 | 34.78 | 56.00 | -21.22 | QP | |
| 4 | | 3.2055 | 5.24 | 20.48 | 25.72 | 46.00 | -20.28 | AVG | |
| 5 | | 4.7490 | 16.76 | 20.14 | 36.90 | 56.00 | -19.10 | QP | |
| 6 | * | 4.7490 | 7.66 | 20.14 | 27.80 | 46.00 | -18.20 | AVG | |
| 7 | | 6.8280 | 16.23 | 20.06 | 36.29 | 60.00 | -23.71 | QP | |
| 8 | | 6.8280 | 7.74 | 20.06 | 27.80 | 50.00 | -22.20 | AVG | |
| 9 | | 11.6745 | 16.72 | 20.08 | 36.80 | 60.00 | -23.20 | QP | |
| 10 | | 11.6745 | 6.81 | 20.08 | 26.89 | 50.00 | -23.11 | AVG | |
| 11 | | 13.2765 | 18.39 | 20.11 | 38.50 | 60.00 | -21.50 | QP | |
| 12 | | 13.2765 | 6.79 | 20.11 | 26.90 | 50.00 | -23.10 | AVG | |

*:Maximum data x:Over limit l:over margin

Unless otherwise stated the results shown in this test report refer only to the sample(s) tested and such sample(s) are retained for 90 days only.
 除非另有說明，此報告結果僅對測試之樣品負責，同時此樣品僅保留90天。本報告未經本公司書面許可，不可部份複製。
 This document is issued by the Company subject to its General Conditions of Service printed overleaf, available on request or accessible at <http://www.sgs.com.tw/Terms-and-Conditions> and for electronic format documents, subject to Terms and Conditions for Electronic Documents at <http://www.sgs.com.tw/Terms-and-Conditions>. Attention is drawn to the limitation of liability, indemnification and jurisdiction issues defined therein. Any holder of this document is advised that information contained hereon reflects the Company's findings at the time of its intervention only and within the limits of Client's instructions, if any. The Company's sole responsibility is to its Client and this document does not exonerate parties to a transaction from exercising all their rights and obligations under the transaction documents. This document cannot be reproduced except in full, without prior written approval of the Company. Any unauthorized alteration, forgery or falsification of the content or appearance of this document is unlawful and offenders may be prosecuted to the fullest extent of the law.



2.5 Test of Radiated Emission

2.5.1 Test Equipments

Below 1GHz

| SGS Radiated_Below_1GHz HWAYA 10m_EMC | | | | | |
|--|-----------------------|-----------------|---------------------|------------------|-----------------|
| EQUIPMENT TYPE | Manufacturer | Model Number | Serial Number | Calibration Date | Calibration Due |
| EMI Test Receiver | R&S | ESCI 7 | 100950 | 2020/11/30 | 2021/11/29 |
| EMI Test Receiver | R&S | ESCI 3 | 101343 | 2020/2/17 | 2021/2/16 |
| Broadband Antenna | SCHWAZBECK | VULB9168 | 9168-628 | 2020/9/8 | 2021/9/7 |
| Broadband Antenna | SCHWAZBECK | VULB9168 | 9168-629 | 2020/9/14 | 2021/9/13 |
| Pre Amplifier | EMC Instruments Corp. | EMC330 | 980178 | 2020/3/31 | 2021/3/30 |
| Pre Amplifier | EMC Instruments Corp. | EMC330 | 980179 | 2020/3/31 | 2021/3/30 |
| Coaxial Cable | EMC Instruments | EMCCFD400-NM-NM | 150917 | 2020/9/18 | 2021/9/17 |
| Coaxial Cable | EMC Instruments | EMCCFD400-NM-NM | 150919 | 2020/9/18 | 2021/9/17 |
| Coaxial Cable | EMC Instruments | EMCCFD400-NM-NM | 150820 | 2020/9/18 | 2021/9/17 |
| Coaxial Cable | EMC Instruments | EMCCFD400-NM-NM | 150918 | 2020/9/18 | 2021/9/17 |
| Coaxial Cable | EMC Instruments | EMCCFD400-NM-NM | 150821 | 2020/9/18 | 2021/9/17 |
| Coaxial Cable | EMC Instruments | EMCCFD400-NM-NM | 150822 | 2020/9/18 | 2021/9/17 |
| Universal Digital Radio Communication Tester | R&S | CMU 200 | 114273 | 2020/5/31 | 2021/5/30 |
| Wideband Radio Communication Tester | R&S | CMW 500 | 152303 | 2020/2/24 | 2021/2/23 |
| Radio Communication Analyzer | Anritsu | MT8820C | 6201465315 | N.C.R. | N.C.R. |
| Controller | MF | MF7802 | N/A | N.C.R. | N.C.R. |
| Controller | MF | MF7802 | N/A | N.C.R. | N.C.R. |
| Antenna Master | MF | N/A | N/A | N.C.R. | N.C.R. |
| Antenna Master | MF | N/A | N/A | N.C.R. | N.C.R. |
| Antenna Master | MF | N/A | N/A | N.C.R. | N.C.R. |
| Turn Table | MF | N/A | N/A | N.C.R. | N.C.R. |
| Site NSA | SGS | 10M Chamber | 10M SAC | 2019/12/31 | 2020/12/30 |
| Test S/W | Farad | EZ-EMC | Ver. SGS 10m-03A2-3 | N.C.R. | N.C.R. |

Testing Site : No.2, Keji 1st Rd., Guishan District, Taoyuan City, Taiwan
 Measurement Uncertainty of Radiated Emission
 Expanded uncertainty Ulab (k=2) of Radiated Emission is 4.43 dB.(30MHz-1000MHz)
 Expanded uncertainty CISPR 16-4-2:2011+A1:2014+A2:2018 (k=2) of Radiated Emission measurement is 5.22 dB.(30MHz-1000MHz)

Unless otherwise stated the results shown in this test report refer only to the sample(s) tested and such sample(s) are retained for 90 days only.

除非另有說明，此報告結果僅對測試之樣品負責，同時此樣品僅保留90天。本報告未經本公司書面許可，不可部份複製。

This document is issued by the Company subject to its General Conditions of Service printed overleaf, available on request or accessible at <http://www.sgs.com.tw/Terms-and-Conditions> and for electronic format documents, subject to Terms and Conditions for Electronic Documents at <http://www.sgs.com.tw/Terms-and-Conditions>. Attention is drawn to the limitation of liability, indemnification and jurisdiction issues defined therein. Any holder of this document is advised that information contained hereon reflects the Company's findings at the time of its intervention only and within the limits of Client's instructions, if any. The Company's sole responsibility is to its Client and this document does not exonerate parties to a transaction from exercising all their rights and obligations under the transaction documents. This document cannot be reproduced except in full, without prior written approval of the Company. Any unauthorized alteration, forgery or falsification of the content or appearance of this document is unlawful and offenders may be prosecuted to the fullest extent of the law.

SGS Taiwan Ltd.

No.2, Keji 1st Rd., Guishan District, Taoyuan City, Taiwan / 桃園市龜山區科技一路2號

台灣檢驗科技股份有限公司

t (886-2) 2299-3279

f (886-3) 327-7559

www.sgs.com.tw

Member of SGS Group



Above 1GHz

| SGS Radiated_Above_1GHz HWAYA 966A EMC | | | | | |
|--|-----------------------|------------------|-----------------|------------------|-----------------|
| EQUIPMENT TYPE | Manufacturer | Model Number | Serial Number | Calibration Date | Calibration Due |
| Spectrum Analyzer | Agilent | E4446A | MY48250064 | 2020/4/6 | 2021/4/5 |
| EMI Test Receiver | R&S | ESR 7 | 101459 | 2020/2/24 | 2021/2/23 |
| Horn Antenna | SCHWARZBECK | BBHA9120D | BBHA9120D285 | 2020/4/29 | 2021/4/28 |
| Horn Antenna | Schwarzbeck | BBHA9170 | BBHA9170-184 | 2019/12/25 | 2020/12/24 |
| Pre Amplifier | EMC Instruments Corp. | EMC012645B | 980216 | 2020/4/25 | 2021/4/24 |
| Pre Amplifier | EMC Instruments Corp. | EMC184045B | 980135 | 2020/10/27 | 2021/10/26 |
| Coaxial Cable | JUNFLOW | MWX221-NMSNMS | J0778929 | 2020/4/23 | 2021/4/22 |
| Coaxial Cable | Huber+Suhner | SUCCOFLEX 104PEA | 30255/4PEA | 2020/4/23 | 2021/4/22 |
| Coaxial Cable | EMC Instruments | EMC104-SM-SM | 140927 | 2020/4/23 | 2021/4/22 |
| Coaxial Cable | Huber+Suhner | SUCOFLEX 102 | 520415/2 | 2020/6/5 | 2021/6/4 |
| Coaxial Cable | Huber+Suhner | SUCOFLEX 102 | MY 2153/2 | 2020/6/5 | 2021/6/4 |
| Universal Digital Radio Communication Tester | R&S | CMU 200 | 114273 | 2020/5/31 | 2021/5/30 |
| Wideband Radio Communication Tester | R&S | CMW 500 | 152303 | 2020/2/24 | 2021/2/23 |
| Radio Communication Analyzer | Anritsu | MT8820C | 6201465315 | N.C.R. | N.C.R. |
| Controller | MF | MF7802 | N.C.R. | N.C.R. | N.C.R. |
| Antenna Master | MF | N/A | N/A | N.C.R. | N.C.R. |
| Turn Table | MF | N/A | N/A | N.C.R. | N.C.R. |
| Site VSWR | SGS | 966 Chamber A | SAC-A | 2020/1/12 | 2021/1/11 |
| Test S/W | Farad | EZ-EMC | Ver. SGS-03A2-3 | N.C.R. | N.C.R. |

Testing Site : No.2, Keji 1st Rd., Guishan District, Taoyuan City, Taiwan

Measurement Uncertainty of Radiated Emission

Expanded uncertainty U_{lab} (k=2) of Radiated Emission measurement is 4.90 dB.(1-6GHz)

Expanded uncertainty U_{lab} (k=2) of Radiated Emission measurement is 4.93 dB.(6-18GHz)

Expanded uncertainty U_{lab} (k=2) of Radiated Emission measurement is 4.72 dB.(18-26GHz)

Expanded uncertainty U_{lab} (k=2) of Radiated Emission measurement is 4.65 dB.(26-40GHz)

Expanded uncertainty CISPR 16-4-2:2011+A1:2014+A2:2018 (k=2) of Radiated Emission measurement is 5.18 dB.(1-6GHz)

Expanded uncertainty CISPR 16-4-2:2011+A1:2014+A2:2018 (k=2) of Radiated Emission measurement is 5.48 dB.(6-18GHz)

Expanded uncertainty CISPR 16-4-2:2011+A1:2014+A2:2018 (k=2) of Radiated Emission measurement is --- dB.(18-26GHz)

Expanded uncertainty CISPR 16-4-2:2011+A1:2014+A2:2018 (k=2) of Radiated Emission measurement is --- dB.(26-40GHz)

2.5.2 Measurement Level Calculation

Correction Factor = Antenna Factor + Cable loss- Amplifier Gain

Measurement Level = Reading Level + Correction Factor

Over (Margin) = Measurement Level – Limit

Unless otherwise stated the results shown in this test report refer only to the sample(s) tested and such sample(s) are retained for 90 days only.

除非另有說明，此報告結果僅對測試之樣品負責，同時此樣品僅保留90天。本報告未經本公司書面許可，不可部份複製。

This document is issued by the Company subject to its General Conditions of Service printed overleaf, available on request or accessible at <http://www.sgs.com.tw/Terms-and-Conditions> and for electronic format documents, subject to Terms and Conditions for Electronic Documents at <http://www.sgs.com.tw/Terms-and-Conditions>. Attention is drawn to the limitation of liability, indemnification and jurisdiction issues defined therein. Any holder of this document is advised that information contained hereon reflects the Company's findings at the time of its intervention only and within the limits of Client's instructions, if any. The Company's sole responsibility is to its Client and this document does not exonerate parties to a transaction from exercising all their rights and obligations under the transaction documents. This document cannot be reproduced except in full, without prior written approval of the Company. Any unauthorized alteration, forgery or falsification of the content or appearance of this document is unlawful and offenders may be prosecuted to the fullest extent of the law.

SGS Taiwan Ltd.

No.2, Keji 1st Rd., Guishan District, Taoyuan City, Taiwan / 桃園市龜山區科技一路2號

台灣檢驗科技股份有限公司

t (886-2) 2299-3279

f (886-3) 327-7559

www.sgs.com.tw

Member of SGS Group



2.5.3 Measurement Data

Below 1GHz

Config_1_H

| | | |
|--------------------------------------|---------------------------------|-----------------------|
| Site: SGS 10m Chamber | Date: 2020/12/13 | Time: 上午 09:47:30 |
| Limit: CISPR22 Class B 10m Radiation | Polarization: Horizontal | Temperature: 22 °C |
| Mode: Config 1 | Power: AC120V/60Hz | Humidity: 67 %RH |
| Report: File :MH-2020-B0179 | Distance: 10m | Air Pressure: 990 hpa |
| Tester: Moore Cheng | | |
| Note: | | |

SGS Taiwan Ltd.-Electromagnetic Compatibility Laboratory Address: No.2, Keji 1st Rd., Guishan District, Taoyuan City, Taiwan 333

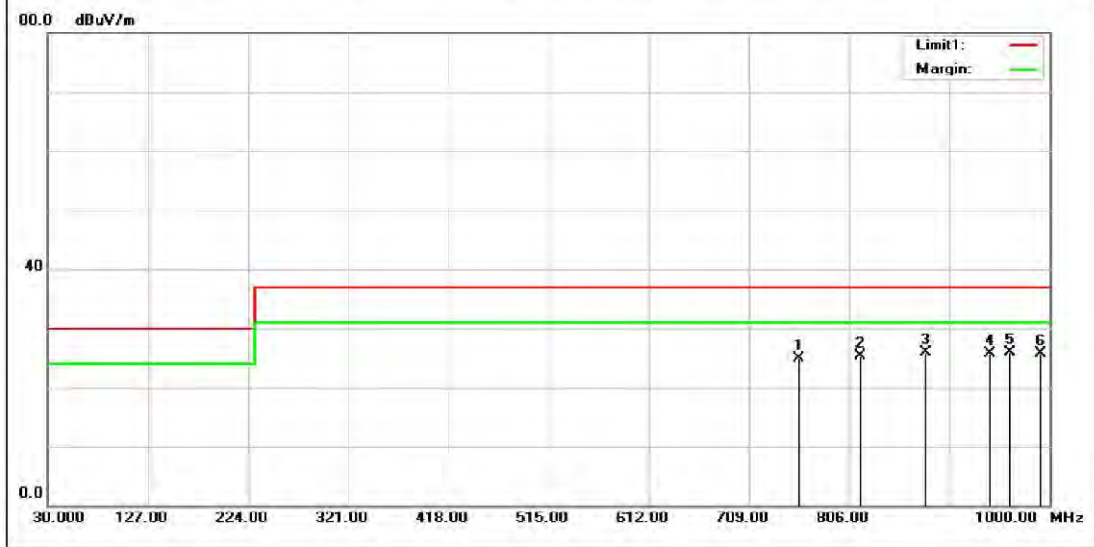

| No. | Mk | Freq. MHz | Reading (dBuV) | Factor (dB/m) | Measurement (dBuV/m) | Limit (dBuV/m) | Over (dB) | Height (cm) | Degree (deg.) | Detector | Comment |
|-----|----|--------------|-------------------|------------------|-------------------------|-------------------|--------------|----------------|------------------|----------|---------|
| 1 | | 757.5000 | 23.63 | 1.20 | 24.83 | 37.00 | -12.17 | | | QP | |
| 2 | | 816.6700 | 24.17 | 1.17 | 25.34 | 37.00 | -11.66 | | | QP | |
| 3 | | 880.6900 | 24.09 | 1.72 | 25.81 | 37.00 | -11.19 | | | QP | |
| 4 | | 941.8000 | 23.12 | 2.52 | 25.64 | 37.00 | -11.36 | | | QP | |
| 5 | * | 962.1700 | 23.11 | 2.83 | 25.94 | 37.00 | -11.06 | 400 | 56 | QP | |
| 6 | | 991.2700 | 22.84 | 2.92 | 25.76 | 37.00 | -11.24 | | | QP | |

*:Maximum data x:Over limit l:over margin

Unless otherwise stated the results shown in this test report refer only to the sample(s) tested and such sample(s) are retained for 90 days only.
 除非另有說明，此報告結果僅對測試之樣品負責，同時此樣品僅保留90天。本報告未經本公司書面許可，不可部份複製。
 This document is issued by the Company subject to its General Conditions of Service printed overleaf, available on request or accessible at <http://www.sgs.com.tw/Terms-and-Conditions> and for electronic format documents, subject to Terms and Conditions for Electronic Documents at <http://www.sgs.com.tw/Terms-and-Conditions>. Attention is drawn to the limitation of liability, indemnification and jurisdiction issues defined therein. Any holder of this document is advised that information contained hereon reflects the Company's findings at the time of its intervention only and within the limits of Client's instructions, if any. The Company's sole responsibility is to its Client and this document does not exonerate parties to a transaction from exercising all their rights and obligations under the transaction documents. This document cannot be reproduced except in full, without prior written approval of the Company. Any unauthorized alteration, forgery or falsification of the content or appearance of this document is unlawful and offenders may be prosecuted to the fullest extent of the law.



Config_1_V

| | | |
|--------------------------------------|-------------------------------|-----------------------|
| Site: SGS 10m Chamber | Date: 2020/12/13 | Time: 上午 09:47:29 |
| Limit: CISPR22 Class B 10m Radiation | Polarization: Vertical | Temperature: 22 °C |
| Mode: Config 1 | Power: AC120V/60Hz | Humidity: 67 %RH |
| Report: File :MH-2020-B0179 | Distance: 10m | Air Pressure: 990 hpa |
| Tester: Moore Cheng | | |
| Note: | | |

SGS Taiwan Ltd.-Electromagnetic Compatibility Laboratory Address: No.2, Keji 1st Rd., Guishan District, Taoyuan City, Taiwan 333

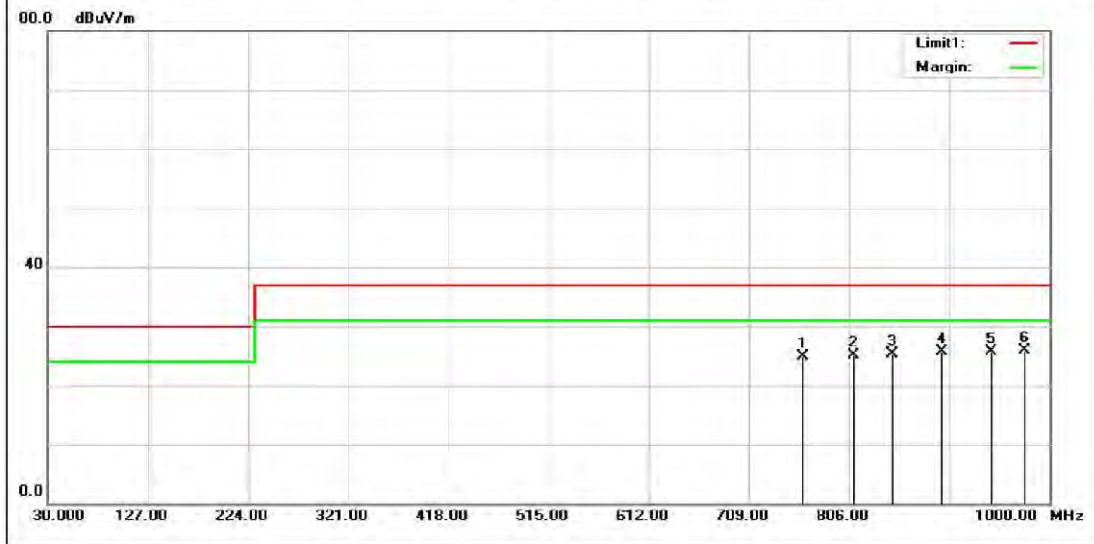

| No. | Mk | Freq. MHz | Reading (dBuV) | Factor (dB/m) | Measurement (dBuV/m) | Limit (dBuV/m) | Over (dB) | Height (cm) | Degree (deg.) | Detector | Comment |
|-----|----|--------------|-------------------|------------------|-------------------------|-------------------|--------------|----------------|------------------|----------|---------|
| 1 | | 761.3800 | 23.11 | 1.73 | 24.84 | 37.00 | -12.16 | | | QP | |
| 2 | | 809.8800 | 23.32 | 1.82 | 25.14 | 37.00 | -11.86 | | | QP | |
| 3 | | 847.7100 | 23.12 | 2.19 | 25.31 | 37.00 | -11.69 | | | QP | |
| 4 | | 896.2100 | 23.51 | 2.23 | 25.74 | 37.00 | -11.26 | | | QP | |
| 5 | | 943.7400 | 22.90 | 2.71 | 25.61 | 37.00 | -11.39 | | | QP | |
| 6 | * | 975.7500 | 23.04 | 2.90 | 25.94 | 37.00 | -11.06 | 100 | 4 | QP | |

*:Maximum data x:Over limit l:over margin

Unless otherwise stated the results shown in this test report refer only to the sample(s) tested and such sample(s) are retained for 90 days only.
除非另有說明，此報告結果僅對測試之樣品負責，同時此樣品僅保留90天。本報告未經本公司書面許可，不可部份複製。

This document is issued by the Company subject to its General Conditions of Service printed overleaf, available on request or accessible at <http://www.sgs.com.tw/Terms-and-Conditions> and for electronic format documents, subject to Terms and Conditions for Electronic Documents at <http://www.sgs.com.tw/Terms-and-Conditions>. Attention is drawn to the limitation of liability, indemnification and jurisdiction issues defined therein. Any holder of this document is advised that information contained hereon reflects the Company's findings at the time of its intervention only and within the limits of Client's instructions, if any. The Company's sole responsibility is to its Client and this document does not exonerate parties to a transaction from exercising all their rights and obligations under the transaction documents. This document cannot be reproduced except in full, without prior written approval of the Company. Any unauthorized alteration, forgery or falsification of the content or appearance of this document is unlawful and offenders may be prosecuted to the fullest extent of the law.



Config_2_H

| | | |
|--------------------------------------|---------------------------------|-----------------------|
| Site: SGS 10m Chamber | Date: 2020/12/13 | Time: 上午 10:05:09 |
| Limit: CISPR22 Class B 10m Radiation | Polarization: Horizontal | Temperature: 22 °C |
| Mode: Config 2 | Power: AC120V/60Hz | Humidity: 67 %RH |
| Report: File :MH-2020-B0179 | Distance: 10m | Air Pressure: 990 hpa |
| Tester: Moore Cheng | | |
| Note: | | |

SGS Taiwan Ltd.-Electromagnetic Compatibility Laboratory Address: No.2, Keji 1st Rd., Guishan District, Taoyuan City, Taiwan 333

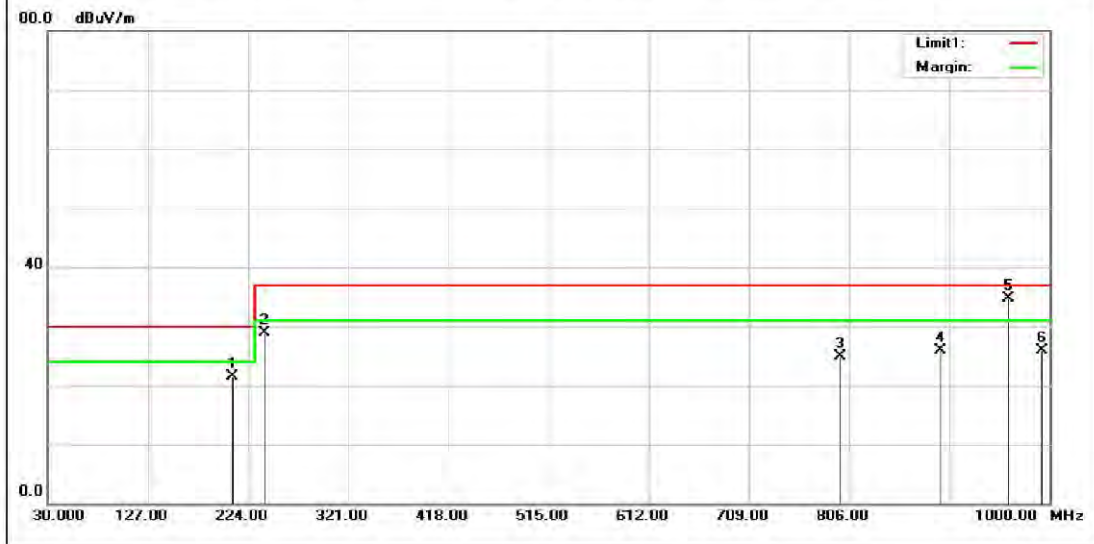

| No. | Mk | Freq. MHz | Reading (dBuV) | Factor (dB/m) | Measurement (dBuV/m) | Limit (dBuV/m) | Over (dB) | Height (cm) | Degree (deg.) | Detector | Comment |
|-----|----|--------------|-------------------|------------------|-------------------------|-------------------|--------------|----------------|------------------|----------|---------|
| 1 | | 209.4500 | 35.73 | -14.19 | 21.54 | 30.00 | -8.46 | | | QP | |
| 2 | | 239.5200 | 41.11 | -12.16 | 28.95 | 37.00 | -8.05 | | | QP | |
| 3 | | 797.2700 | 23.74 | 1.11 | 24.85 | 37.00 | -12.15 | | | QP | |
| 4 | | 894.2700 | 23.97 | 1.97 | 25.94 | 37.00 | -11.06 | | | QP | |
| 5 | * | 960.2300 | 31.83 | 2.86 | 34.69 | 37.00 | -2.31 | 136 | 358 | QP | |
| 6 | | 992.2400 | 23.08 | 2.91 | 25.99 | 37.00 | -11.01 | | | QP | |

*:Maximum data x:Over limit l:over margin

Unless otherwise stated the results shown in this test report refer only to the sample(s) tested and such sample(s) are retained for 90 days only.

除非另有說明，此報告結果僅對測試之樣品負責，同時此樣品僅保留90天。本報告未經本公司書面許可，不可部份複製。

This document is issued by the Company subject to its General Conditions of Service printed overleaf, available on request or accessible at <http://www.sgs.com.tw/Terms-and-Conditions> and for electronic format documents, subject to Terms and Conditions for Electronic Documents at <http://www.sgs.com.tw/Terms-and-Conditions>. Attention is drawn to the limitation of liability, indemnification and jurisdiction issues defined therein. Any holder of this document is advised that information contained hereon reflects the Company's findings at the time of its intervention only and within the limits of Client's instructions, if any. The Company's sole responsibility is to its Client and this document does not exonerate parties to a transaction from exercising all their rights and obligations under the transaction documents. This document cannot be reproduced except in full, without prior written approval of the Company. Any unauthorized alteration, forgery or falsification of the content or appearance of this document is unlawful and offenders may be prosecuted to the fullest extent of the law.

SGS Taiwan Ltd. No.2, Keji 1st Rd., Guishan District, Taoyuan City, Taiwan / 桃園市龜山區科技一路2號

台灣檢驗科技股份有限公司

t (886-2) 2299-3279

f (886-3) 327-7559

www.sgs.com.tw

Member of SGS Group



Config_2_V

| | | |
|--------------------------------------|-------------------------------|-----------------------|
| Site: SGS 10m Chamber | Date: 2020/12/13 | Time: 上午 10:05:08 |
| Limit: CISPR22 Class B 10m Radiation | Polarization: Vertical | Temperature: 22 °C |
| Mode: Config 2 | Power: AC120V/60Hz | Humidity: 67 %RH |
| Report: File :MH-2020-B0179 | Distance: 10m | Air Pressure: 990 hpa |
| Tester: Moore Cheng | | |
| Note: | | |

SGS Taiwan Ltd.-Electromagnetic Compatibility Laboratory Address: No.2, Keji 1st Rd., Guishan District, Taoyuan City, Taiwan 333

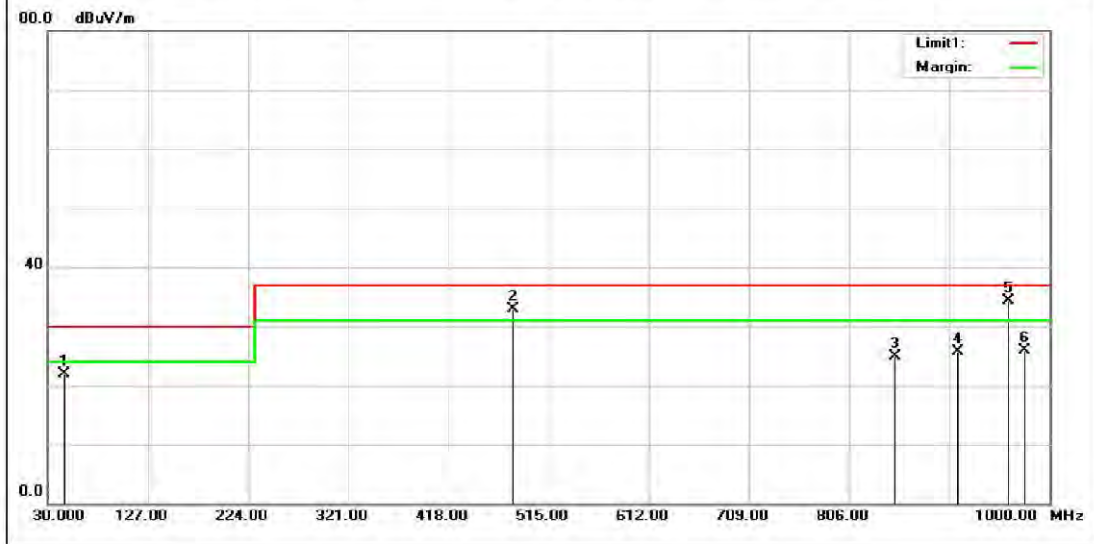

| No. | Mk | Freq. MHz | Reading (dBuV) | Factor (dB/m) | Measurement (dBuV/m) | Limit (dBuV/m) | Over (dB) | Height (cm) | Degree (deg.) | Detector | Comment |
|-----|----|--------------|-------------------|------------------|-------------------------|-------------------|--------------|----------------|------------------|----------|---------|
| 1 | | 45.5200 | 32.70 | -10.81 | 21.89 | 30.00 | -8.11 | | | QP | |
| 2 | ! | 480.0800 | 37.75 | -4.90 | 32.85 | 37.00 | -4.15 | | | QP | |
| 3 | | 850.6200 | 22.66 | 2.19 | 24.85 | 37.00 | -12.15 | | | QP | |
| 4 | | 911.7300 | 23.28 | 2.50 | 25.78 | 37.00 | -11.22 | | | QP | |
| 5 | * | 960.2300 | 31.61 | 2.64 | 34.25 | 37.00 | -2.75 | 220 | 234 | QP | |
| 6 | | 975.7500 | 23.02 | 2.90 | 25.92 | 37.00 | -11.08 | | | QP | |

*:Maximum data x:Over limit !:over margin

Unless otherwise stated the results shown in this test report refer only to the sample(s) tested and such sample(s) are retained for 90 days only.
 除非另有說明，此報告結果僅對測試之樣品負責，同時此樣品僅保留90天。本報告未經本公司書面許可，不可部份複製。

This document is issued by the Company subject to its General Conditions of Service printed overleaf, available on request or accessible at <http://www.sgs.com.tw/Terms-and-Conditions> and for electronic format documents, subject to Terms and Conditions for Electronic Documents at <http://www.sgs.com.tw/Terms-and-Conditions>. Attention is drawn to the limitation of liability, indemnification and jurisdiction issues defined therein. Any holder of this document is advised that information contained hereon reflects the Company's findings at the time of its intervention only and within the limits of Client's instructions, if any. The Company's sole responsibility is to its Client and this document does not exonerate parties to a transaction from exercising all their rights and obligations under the transaction documents. This document cannot be reproduced except in full, without prior written approval of the Company. Any unauthorized alteration, forgery or falsification of the content or appearance of this document is unlawful and offenders may be prosecuted to the fullest extent of the law.

SGS Taiwan Ltd. No.2, Keji 1st Rd., Guishan District, Taoyuan City, Taiwan / 桃園市龜山區科技一路2號

台灣檢驗科技股份有限公司

t (886-2) 2299-3279

f (886-3) 327-7559

www.sgs.com.tw

Member of SGS Group



Config_3_H

| | | |
|--------------------------------------|---------------------------------|-----------------------|
| Site: SGS 10m Chamber | Date: 2020/12/13 | Time: 上午 11:23:21 |
| Limit: CISPR22 Class B 10m Radiation | Polarization: Horizontal | Temperature: 22 °C |
| Mode: Config 3 | Power: AC120V/60Hz | Humidity: 67 %RH |
| Report: File :MH-2020-B0179 | Distance: 10m | Air Pressure: 990 hpa |
| Tester: Moore Cheng | | |
| Note: | | |

SGS Taiwan Ltd.-Electromagnetic Compatibility Laboratory Address: No.2, Keji 1st Rd., Guishan District, Taoyuan City, Taiwan 333

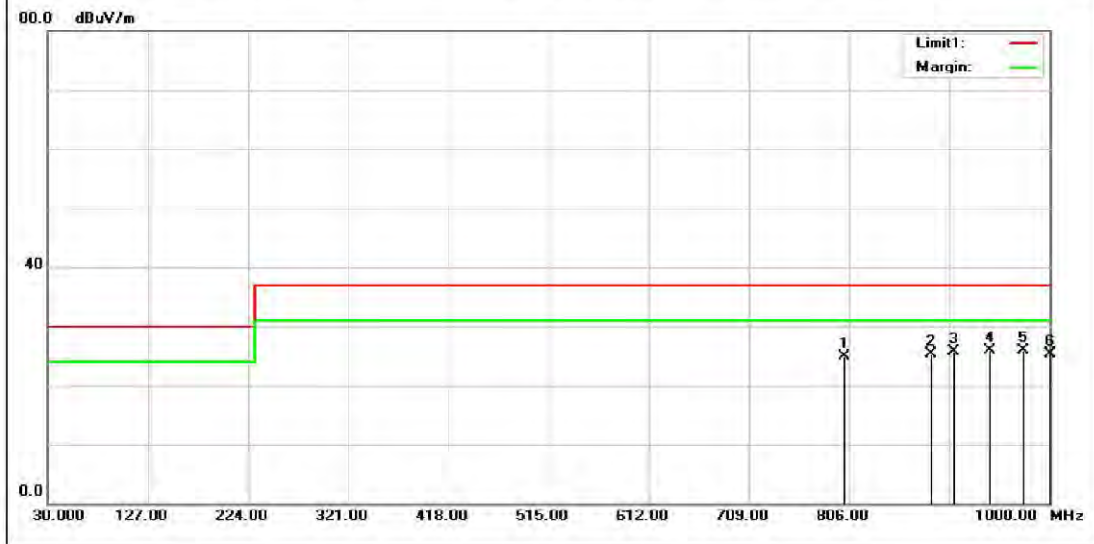

| No. | Mk | Freq. MHz | Reading (dBuV) | Factor (dB/m) | Measurement (dBuV/m) | Limit (dBuV/m) | Over (dB) | Height (cm) | Degree (deg.) | Detector | Comment |
|-----|----|--------------|-------------------|------------------|-------------------------|-------------------|--------------|----------------|------------------|----------|---------|
| 1 | | 801.1500 | 23.72 | 1.12 | 24.84 | 37.00 | -12.16 | | | QP | |
| 2 | | 885.5400 | 23.59 | 1.75 | 25.34 | 37.00 | -11.66 | | | QP | |
| 3 | | 907.8500 | 23.65 | 2.14 | 25.79 | 37.00 | -11.21 | | | QP | |
| 4 | * | 942.7700 | 23.43 | 2.51 | 25.94 | 37.00 | -11.06 | 399 | 86 | QP | |
| 5 | | 974.7800 | 22.96 | 2.85 | 25.81 | 37.00 | -11.19 | | | QP | |
| 6 | | 1000.0000 | 22.38 | 3.00 | 25.38 | 37.00 | -11.62 | | | QP | |

*:Maximum data x:Over limit l:over margin

Unless otherwise stated the results shown in this test report refer only to the sample(s) tested and such sample(s) are retained for 90 days only.
 除非另有說明，此報告結果僅對測試之樣品負責，同時此樣品僅保留90天。本報告未經本公司書面許可，不可部份複製。

This document is issued by the Company subject to its General Conditions of Service printed overleaf, available on request or accessible at <http://www.sgs.com.tw/Terms-and-Conditions> and for electronic format documents, subject to Terms and Conditions for Electronic Documents at <http://www.sgs.com.tw/Terms-and-Conditions>. Attention is drawn to the limitation of liability, indemnification and jurisdiction issues defined therein. Any holder of this document is advised that information contained hereon reflects the Company's findings at the time of its intervention only and within the limits of Client's instructions, if any. The Company's sole responsibility is to its Client and this document does not exonerate parties to a transaction from exercising all their rights and obligations under the transaction documents. This document cannot be reproduced except in full, without prior written approval of the Company. Any unauthorized alteration, forgery or falsification of the content or appearance of this document is unlawful and offenders may be prosecuted to the fullest extent of the law.

SGS Taiwan Ltd. No.2, Keji 1st Rd., Guishan District, Taoyuan City, Taiwan / 桃園市龜山區科技一路2號

台灣檢驗科技股份有限公司

t (886-2) 2299-3279

f (886-3) 327-7559

www.sgs.com.tw

Member of SGS Group



Config_3_V

| | | |
|--------------------------------------|-------------------------------|-----------------------|
| Site: SGS 10m Chamber | Date: 2020/12/13 | Time: 上午 11:23:20 |
| Limit: CISPR22 Class B 10m Radiation | Polarization: Vertical | Temperature: 22 °C |
| Mode: Config 3 | Power: AC120V/60Hz | Humidity: 67 %RH |
| Report: File :MH-2020-B0179 | Distance: 10m | Air Pressure: 990 hpa |
| Tester: Moore Cheng | | |
| Note: | | |

SGS Taiwan Ltd.-Electromagnetic Compatibility Laboratory Address: No.2, Keji 1st Rd., Guishan District, Taoyuan City, Taiwan 333

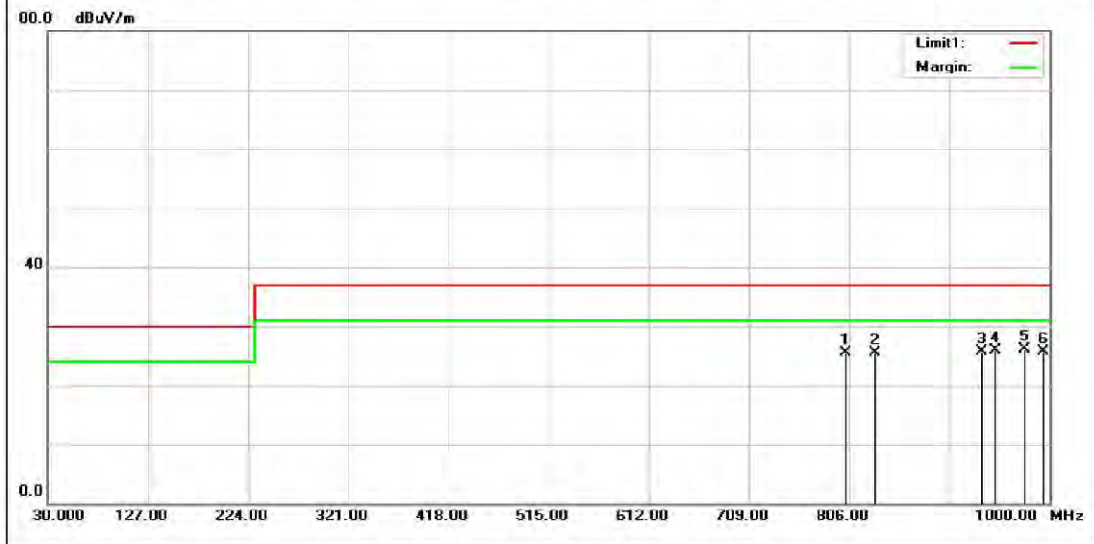

| No. | Mk | Freq. MHz | Reading (dBuV) | Factor (dB/m) | Measurement (dBuV/m) | Limit (dBuV/m) | Over (dB) | Height (cm) | Degree (deg.) | Detector | Comment |
|-----|----|--------------|-------------------|------------------|-------------------------|-------------------|--------------|----------------|------------------|----------|---------|
| 1 | | 803.0900 | 23.74 | 1.70 | 25.44 | 37.00 | -11.56 | | | QP | |
| 2 | | 831.2200 | 23.51 | 2.06 | 25.57 | 37.00 | -11.43 | | | QP | |
| 3 | | 934.0400 | 23.03 | 2.69 | 25.72 | 37.00 | -11.28 | | | QP | |
| 4 | | 947.6200 | 23.23 | 2.71 | 25.94 | 37.00 | -11.06 | | | QP | |
| 5 | * | 975.7500 | 23.28 | 2.90 | 26.18 | 37.00 | -10.82 | 100 | 141 | QP | |
| 6 | | 994.1800 | 22.76 | 2.88 | 25.64 | 37.00 | -11.36 | | | QP | |

*:Maximum data x:Over limit l:over margin

Unless otherwise stated the results shown in this test report refer only to the sample(s) tested and such sample(s) are retained for 90 days only.

除非另有說明，此報告結果僅對測試之樣品負責，同時此樣品僅保留90天。本報告未經本公司書面許可，不可部份複製。

This document is issued by the Company subject to its General Conditions of Service printed overleaf, available on request or accessible at <http://www.sgs.com.tw/Terms-and-Conditions> and for electronic format documents, subject to Terms and Conditions for Electronic Documents at <http://www.sgs.com.tw/Terms-and-Conditions>. Attention is drawn to the limitation of liability, indemnification and jurisdiction issues defined therein. Any holder of this document is advised that information contained hereon reflects the Company's findings at the time of its intervention only and within the limits of Client's instructions, if any. The Company's sole responsibility is to its Client and this document does not exonerate parties to a transaction from exercising all their rights and obligations under the transaction documents. This document cannot be reproduced except in full, without prior written approval of the Company. Any unauthorized alteration, forgery or falsification of the content or appearance of this document is unlawful and offenders may be prosecuted to the fullest extent of the law.

SGS Taiwan Ltd. No.2, Keji 1st Rd., Guishan District, Taoyuan City, Taiwan / 桃園市龜山區科技一路2號



Config_4_H

| | | |
|--------------------------------------|---------------------------------|-----------------------|
| Site: SGS 10m Chamber | Date: 2020/12/13 | Time: 下午 12:17:07 |
| Limit: CISPR22 Class B 10m Radiation | Polarization: Horizontal | Temperature: 22 °C |
| Mode: Config 4 | Power: AC120V/60Hz | Humidity: 67 %RH |
| Report: File :MH-2020-B0179 | Distance: 10m | Air Pressure: 990 hpa |
| Tester: Moore Cheng | | |
| Note: | | |

SGS Taiwan Ltd.-Electromagnetic Compatibility Laboratory Address: No.2, Keji 1st Rd., Guishan District, Taoyuan City, Taiwan 333

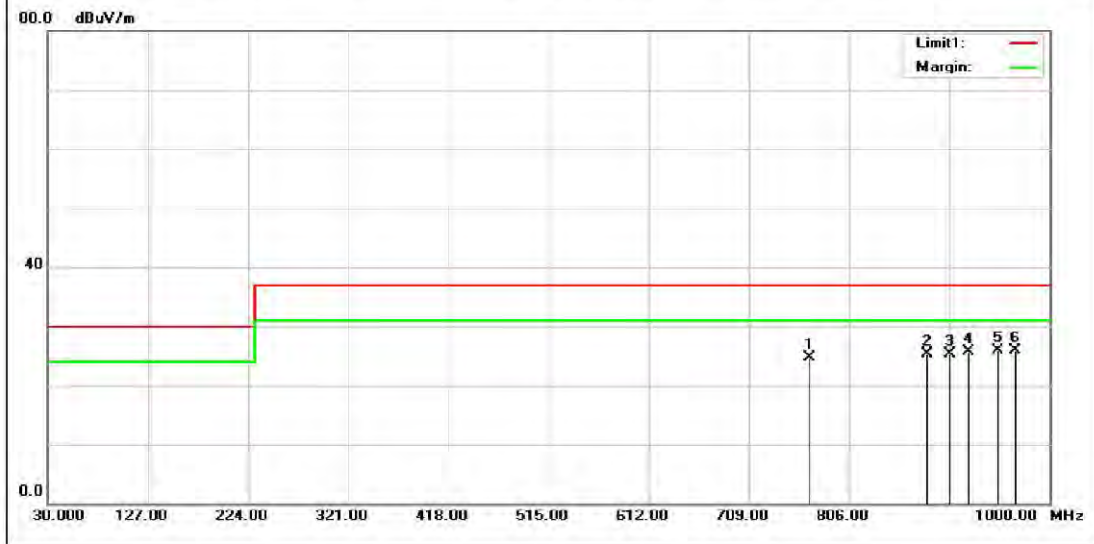

| No. | Mk | Freq. MHz | Reading (dBuV) | Factor (dB/m) | Measurement (dBuV/m) | Limit (dBuV/m) | Over (dB) | Height (cm) | Degree (deg.) | Detector | Comment |
|-----|----|--------------|-------------------|------------------|-------------------------|-------------------|--------------|----------------|------------------|----------|---------|
| 1 | | 767.2000 | 23.60 | 1.19 | 24.79 | 37.00 | -12.21 | | | QP | |
| 2 | | 881.6600 | 23.55 | 1.73 | 25.28 | 37.00 | -11.72 | | | QP | |
| 3 | | 903.0000 | 23.34 | 2.05 | 25.39 | 37.00 | -11.61 | | | QP | |
| 4 | | 921.4300 | 23.39 | 2.39 | 25.78 | 37.00 | -11.22 | | | QP | |
| 5 | * | 950.5300 | 23.34 | 2.60 | 25.94 | 37.00 | -11.06 | 400 | 119 | QP | |
| 6 | | 967.0200 | 23.03 | 2.80 | 25.83 | 37.00 | -11.17 | | | QP | |

*:Maximum data x:Over limit l:over margin

Unless otherwise stated the results shown in this test report refer only to the sample(s) tested and such sample(s) are retained for 90 days only.
 除非另有說明，此報告結果僅對測試之樣品負責，同時此樣品僅保留90天。本報告未經本公司書面許可，不可部份複製。

This document is issued by the Company subject to its General Conditions of Service printed overleaf, available on request or accessible at <http://www.sgs.com.tw/Terms-and-Conditions> and for electronic format documents, subject to Terms and Conditions for Electronic Documents at <http://www.sgs.com.tw/Terms-and-Conditions>. Attention is drawn to the limitation of liability, indemnification and jurisdiction issues defined therein. Any holder of this document is advised that information contained hereon reflects the Company's findings at the time of its intervention only and within the limits of Client's instructions, if any. The Company's sole responsibility is to its Client and this document does not exonerate parties to a transaction from exercising all their rights and obligations under the transaction documents. This document cannot be reproduced except in full, without prior written approval of the Company. Any unauthorized alteration, forgery or falsification of the content or appearance of this document is unlawful and offenders may be prosecuted to the fullest extent of the law.

SGS Taiwan Ltd. No.2, Keji 1st Rd., Guishan District, Taoyuan City, Taiwan / 桃園市龜山區科技一路2號



Config_4_V

| | | |
|--------------------------------------|-------------------------------|-----------------------|
| Site: SGS 10m Chamber | Date: 2020/12/13 | Time: 下午 12:17:06 |
| Limit: CISPR22 Class B 10m Radiation | Polarization: Vertical | Temperature: 22 °C |
| Mode: Config 4 | Power: AC120V/60Hz | Humidity: 67 %RH |
| Report: File :MH-2020-B0179 | Distance: 10m | Air Pressure: 990 hpa |
| Tester: Moore Cheng | | |
| Note: | | |

SGS Taiwan Ltd.-Electromagnetic Compatibility Laboratory Address: No.2, Keji 1st Rd., Guishan District, Taoyuan City, Taiwan 333

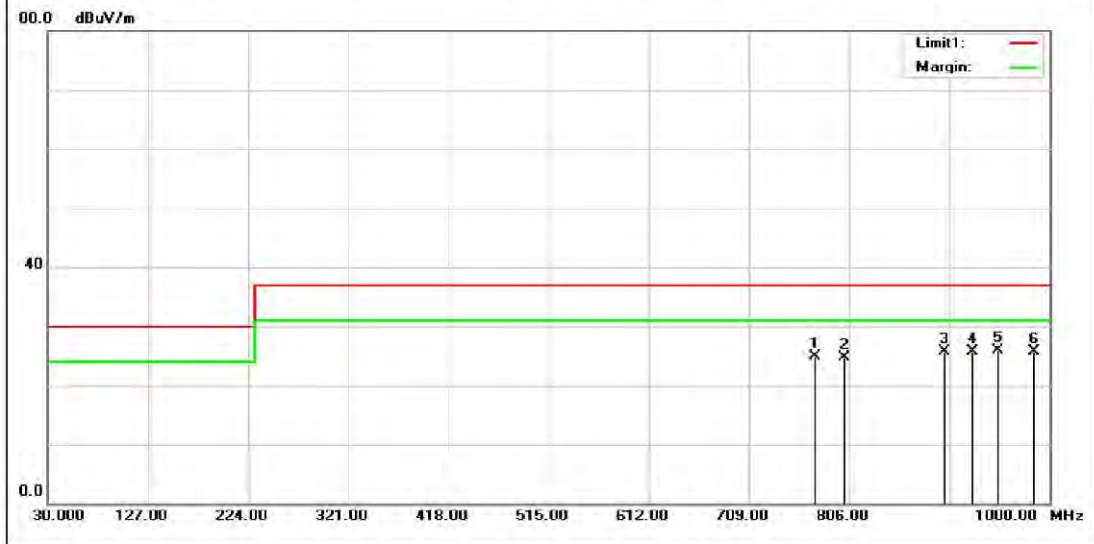

| No. | Mk | Freq. MHz | Reading (dBuV) | Factor (dB/m) | Measurement (dBuV/m) | Limit (dBuV/m) | Over (dB) | Height (cm) | Degree (deg.) | Detector | Comment |
|-----|----|--------------|-------------------|------------------|-------------------------|-------------------|--------------|----------------|------------------|----------|---------|
| 1 | | 773.0200 | 23.17 | 1.67 | 24.84 | 37.00 | -12.16 | | | QP | |
| 2 | | 801.1500 | 23.03 | 1.70 | 24.73 | 37.00 | -12.27 | | | QP | |
| 3 | | 898.1500 | 23.53 | 2.21 | 25.74 | 37.00 | -11.26 | | | QP | |
| 4 | | 925.3100 | 22.86 | 2.75 | 25.61 | 37.00 | -11.39 | | | QP | |
| 5 | * | 949.5600 | 23.18 | 2.70 | 25.88 | 37.00 | -11.12 | 100 | 125 | QP | |
| 6 | | 985.4500 | 22.78 | 2.93 | 25.71 | 37.00 | -11.29 | | | QP | |

*:Maximum data x:Over limit l:over margin

Unless otherwise stated the results shown in this test report refer only to the sample(s) tested and such sample(s) are retained for 90 days only.

除非另有說明，此報告結果僅對測試之樣品負責，同時此樣品僅保留90天。本報告未經本公司書面許可，不可部份複製。

This document is issued by the Company subject to its General Conditions of Service printed overleaf, available on request or accessible at <http://www.sgs.com.tw/Terms-and-Conditions> and for electronic format documents, subject to Terms and Conditions for Electronic Documents at <http://www.sgs.com.tw/Terms-and-Conditions>. Attention is drawn to the limitation of liability, indemnification and jurisdiction issues defined therein. Any holder of this document is advised that information contained hereon reflects the Company's findings at the time of its intervention only and within the limits of Client's instructions, if any. The Company's sole responsibility is to its Client and this document does not exonerate parties to a transaction from exercising all their rights and obligations under the transaction documents. This document cannot be reproduced except in full, without prior written approval of the Company. Any unauthorized alteration, forgery or falsification of the content or appearance of this document is unlawful and offenders may be prosecuted to the fullest extent of the law.

SGS Taiwan Ltd. No.2, Keji 1st Rd., Guishan District, Taoyuan City, Taiwan / 桃園市龜山區科技一路2號

台灣檢驗科技股份有限公司

t (886-2) 2299-3279

f (886-3) 327-7559

www.sgs.com.tw

Member of SGS Group



Config_5_H

| | | |
|--------------------------------------|---------------------------------|-----------------------|
| Site: SGS 10m Chamber | Date: 2020/12/13 | Time: 下午 01:39:14 |
| Limit: CISPR22 Class B 10m Radiation | Polarization: Horizontal | Temperature: 22 °C |
| Mode: Config 5 | Power: AC120V/60Hz | Humidity: 67 %RH |
| Report: File :MH-2020-B0179 | Distance: 10m | Air Pressure: 990 hpa |
| Tester: Moore Cheng | | |
| Note: | | |

SGS Taiwan Ltd.-Electromagnetic Compatibility Laboratory Address: No.2, Keji 1st Rd., Guishan District, Taoyuan City, Taiwan 333

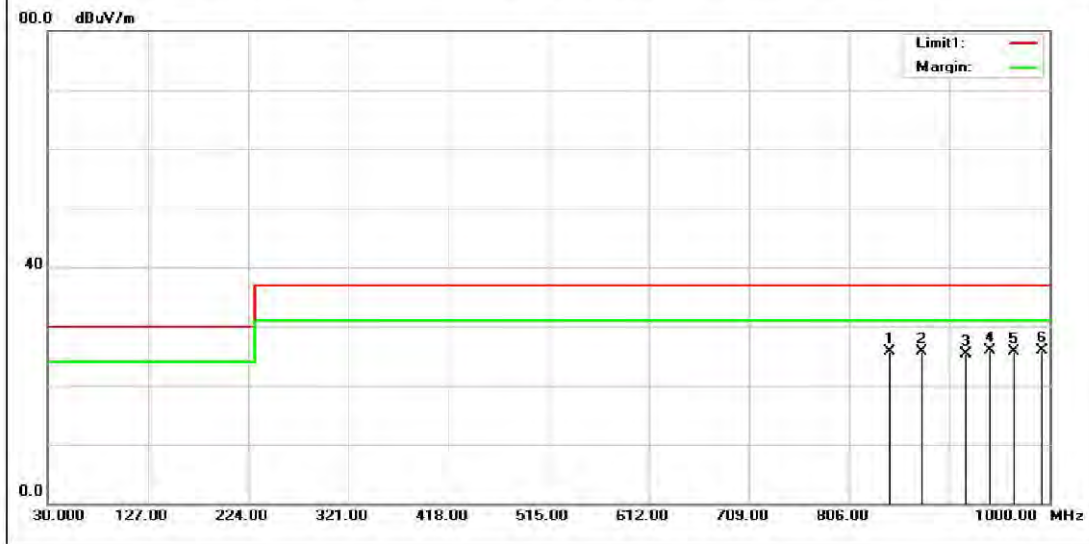

| No. | Mk | Freq. MHz | Reading (dBuV) | Factor (dB/m) | Measurement (dBuV/m) | Limit (dBuV/m) | Over (dB) | Height (cm) | Degree (deg.) | Detector | Comment |
|-----|----|--------------|-------------------|------------------|-------------------------|-------------------|--------------|----------------|------------------|----------|---------|
| 1 | | 844.8000 | 24.35 | 1.32 | 25.67 | 37.00 | -11.33 | | | QP | |
| 2 | | 875.8400 | 24.01 | 1.70 | 25.71 | 37.00 | -11.29 | | | QP | |
| 3 | | 919.4900 | 23.02 | 2.35 | 25.37 | 37.00 | -11.63 | | | QP | |
| 4 | * | 941.8000 | 23.45 | 2.52 | 25.97 | 37.00 | -11.03 | 371 | 0 | QP | |
| 5 | | 966.0500 | 22.93 | 2.79 | 25.72 | 37.00 | -11.28 | | | QP | |
| 6 | | 992.2400 | 22.92 | 2.91 | 25.83 | 37.00 | -11.17 | | | QP | |

*:Maximum data x:Over limit l:over margin

Unless otherwise stated the results shown in this test report refer only to the sample(s) tested and such sample(s) are retained for 90 days only.

除非另有說明，此報告結果僅對測試之樣品負責，同時此樣品僅保留90天。本報告未經本公司書面許可，不可部份複製。
This document is issued by the Company subject to its General Conditions of Service printed overleaf, available on request or accessible at <http://www.sgs.com.tw/Terms-and-Conditions> and for electronic format documents, subject to Terms and Conditions for Electronic Documents at <http://www.sgs.com.tw/Terms-and-Conditions>. Attention is drawn to the limitation of liability, indemnification and jurisdiction issues defined therein. Any holder of this document is advised that information contained hereon reflects the Company's findings at the time of its intervention only and within the limits of Client's instructions, if any. The Company's sole responsibility is to its Client and this document does not exonerate parties to a transaction from exercising all their rights and obligations under the transaction documents. This document cannot be reproduced except in full, without prior written approval of the Company. Any unauthorized alteration, forgery or falsification of the content or appearance of this document is unlawful and offenders may be prosecuted to the fullest extent of the law.

SGS Taiwan Ltd. No.2, Keji 1st Rd., Guishan District, Taoyuan City, Taiwan / 桃園市龜山區科技一路2號

台灣檢驗科技股份有限公司

t (886-2) 2299-3279

f (886-3) 327-7559

www.sgs.com.tw

Member of SGS Group



Config_5_V

| | | |
|--------------------------------------|-------------------------------|-----------------------|
| Site: SGS 10m Chamber | Date: 2020/12/13 | Time: 下午 01:39:13 |
| Limit: CISPR22 Class B 10m Radiation | Polarization: Vertical | Temperature: 22 °C |
| Mode: Config 5 | Power: AC120V/60Hz | Humidity: 67 %RH |
| Report: File :MH-2020-B0179 | Distance: 10m | Air Pressure: 990 hpa |
| Tester: Moore Cheng | | |
| Note: | | |

SGS Taiwan Ltd.-Electromagnetic Compatibility Laboratory Address: No.2, Keji 1st Rd., Guishan District, Taoyuan City, Taiwan 333

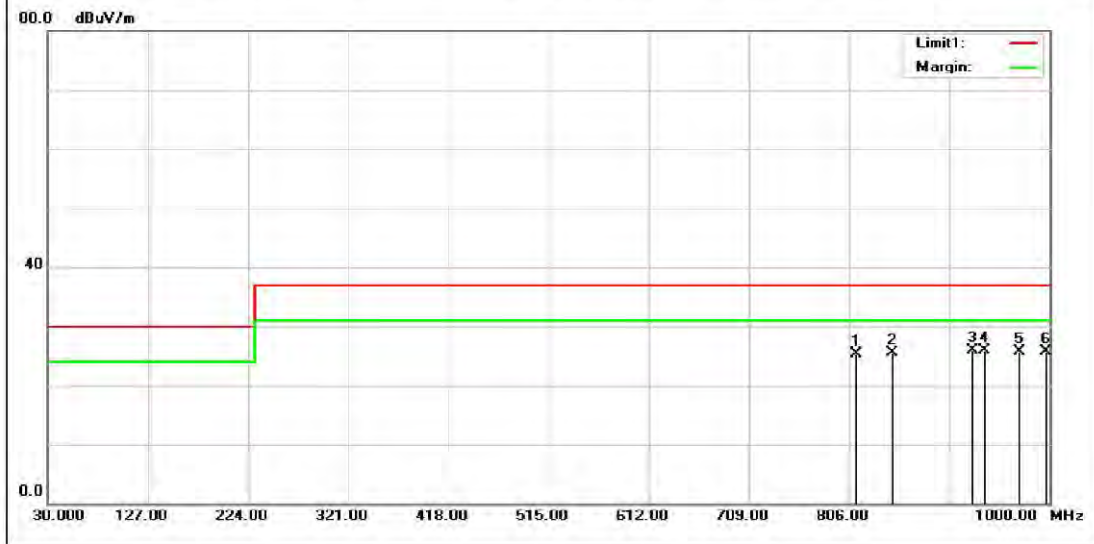

| No. | Mk | Freq. MHz | Reading (dBuV) | Factor (dB/m) | Measurement (dBuV/m) | Limit (dBuV/m) | Over (dB) | Height (cm) | Degree (deg.) | Detector | Comment |
|-----|----|--------------|-------------------|------------------|-------------------------|-------------------|--------------|----------------|------------------|----------|---------|
| 1 | | 812.7900 | 23.58 | 1.76 | 25.34 | 37.00 | -11.66 | | | QP | |
| 2 | | 847.7100 | 23.38 | 2.19 | 25.57 | 37.00 | -11.43 | | | QP | |
| 3 | | 925.3100 | 23.16 | 2.75 | 25.91 | 37.00 | -11.09 | | | QP | |
| 4 | * | 936.9500 | 23.31 | 2.68 | 25.99 | 37.00 | -11.01 | 220 | 0 | QP | |
| 5 | | 970.9000 | 22.94 | 2.81 | 25.75 | 37.00 | -11.25 | | | QP | |
| 6 | | 996.1200 | 22.76 | 2.91 | 25.67 | 37.00 | -11.33 | | | QP | |

*:Maximum data x:Over limit l:over margin

Unless otherwise stated the results shown in this test report refer only to the sample(s) tested and such sample(s) are retained for 90 days only.
 除非另有說明，此報告結果僅對測試之樣品負責，同時此樣品僅保留90天。本報告未經本公司書面許可，不可部份複製。

This document is issued by the Company subject to its General Conditions of Service printed overleaf, available on request or accessible at <http://www.sgs.com.tw/Terms-and-Conditions> and for electronic format documents, subject to Terms and Conditions for Electronic Documents at <http://www.sgs.com.tw/Terms-and-Conditions>. Attention is drawn to the limitation of liability, indemnification and jurisdiction issues defined therein. Any holder of this document is advised that information contained hereon reflects the Company's findings at the time of its intervention only and within the limits of Client's instructions, if any. The Company's sole responsibility is to its Client and this document does not exonerate parties to a transaction from exercising all their rights and obligations under the transaction documents. This document cannot be reproduced except in full, without prior written approval of the Company. Any unauthorized alteration, forgery or falsification of the content or appearance of this document is unlawful and offenders may be prosecuted to the fullest extent of the law.



Above 1GHz

Config_1_H

| | | |
|---------------------------------|---------------------------------|-----------------------|
| Site: SGS 966 Chamber A | Date: 2020/12/10 | Time: 下午 05:40:03 |
| Limit: FCC Class B 1G-18G(Peak) | Polarization: Horizontal | Temperature: 21 °C |
| Mode: Config 1 | Power: AC 120V/60Hz | Humidity: 75 %RH |
| Report: MH-2020-B0179 | Distance: 3m | Air Pressure: 990 hpa |
| Tester: Boris Liao | | |
| Note: LTE B05 | | |

SGS Taiwan Ltd.-Electromagnetic Compatibility Laboratory Address: No.2, Keji 1st Rd., Guishan District, Taoyuan City, Taiwan 333

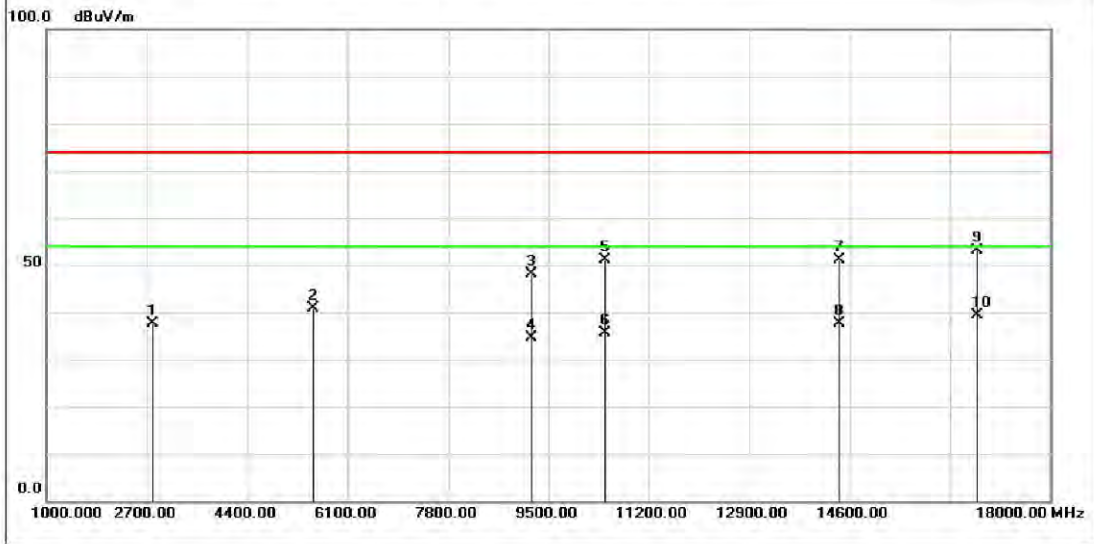

| No. | Mk | Freq. (MHz) | Reading (dBuV) | Factor (dB/m) | Measurement (dBuV/m) | Limit (dBuV/m) | Over (dB) | Height (cm) | Degree (deg.) | Detector | Comment |
|-----|----|-------------|----------------|---------------|----------------------|----------------|-----------|-------------|---------------|----------|---------|
| 1 | | 2802.000 | 55.63 | -18.11 | 37.52 | 74.00 | -36.48 | | | peak | |
| 2 | | 5522.000 | 53.73 | -12.93 | 40.80 | 74.00 | -33.20 | | | peak | |
| 3 | | 9211.000 | 49.89 | -1.83 | 48.06 | 74.00 | -25.94 | | | peak | |
| 4 | | 9211.000 | 36.37 | -1.83 | 34.54 | 54.00 | -19.46 | | | AVG | |
| 5 | | 10452.000 | 51.40 | -0.24 | 51.16 | 74.00 | -22.84 | | | peak | |
| 6 | | 10452.000 | 35.89 | -0.24 | 35.65 | 54.00 | -18.35 | | | AVG | |
| 7 | | 14430.000 | 47.10 | 3.93 | 51.03 | 74.00 | -22.97 | | | peak | |
| 8 | | 14430.000 | 33.81 | 3.93 | 37.74 | 54.00 | -16.26 | | | AVG | |
| 9 | | 16759.000 | 47.94 | 5.08 | 53.02 | 74.00 | -20.98 | 100 | 199 | peak | |
| 10 | * | 16759.000 | 34.28 | 5.08 | 39.36 | 54.00 | -14.64 | 100 | 199 | AVG | |

*:Maximum data x:Over limit !:over margin

Unless otherwise stated the results shown in this test report refer only to the sample(s) tested and such sample(s) are retained for 90 days only.
 除非另有說明，此報告結果僅對測試之樣品負責，同時此樣品僅保留90天。本報告未經本公司書面許可，不可部份複製。
 This document is issued by the Company subject to its General Conditions of Service printed overleaf, available on request or accessible at <http://www.sgs.com.tw/Terms-and-Conditions> and for electronic format documents, subject to Terms and Conditions for Electronic Documents at <http://www.sgs.com.tw/Terms-and-Conditions>. Attention is drawn to the limitation of liability, indemnification and jurisdiction issues defined therein. Any holder of this document is advised that information contained hereon reflects the Company's findings at the time of its intervention only and within the limits of Client's instructions, if any. The Company's sole responsibility is to its Client and this document does not exonerate parties to a transaction from exercising all their rights and obligations under the transaction documents. This document cannot be reproduced except in full, without prior written approval of the Company. Any unauthorized alteration, forgery or falsification of the content or appearance of this document is unlawful and offenders may be prosecuted to the fullest extent of the law.



| | | |
|------------------------------------|---------------------------------|-----------------------|
| Site: SGS 966 Chamber A | Date: 2020/12/11 | Time: 上午 01:25:57 |
| Limit: FCC Class B 1m 18-40G(Peak) | Polarization: Horizontal | Temperature: 21 °C |
| Mode: Config 1 | Power: AC 120V/60Hz | Humidity: 75 %RH |
| Report: MH-2020-B0179 | Distance: 1m | Air Pressure: 990 hpa |
| Tester: Boris Liao | | |
| Note: LTE B05 | | |

SGS Taiwan Ltd.-Electromagnetic Compatibility Laboratory Address: No.2, Keji 1st Rd., Guishan District, Taoyuan City, Taiwan 333

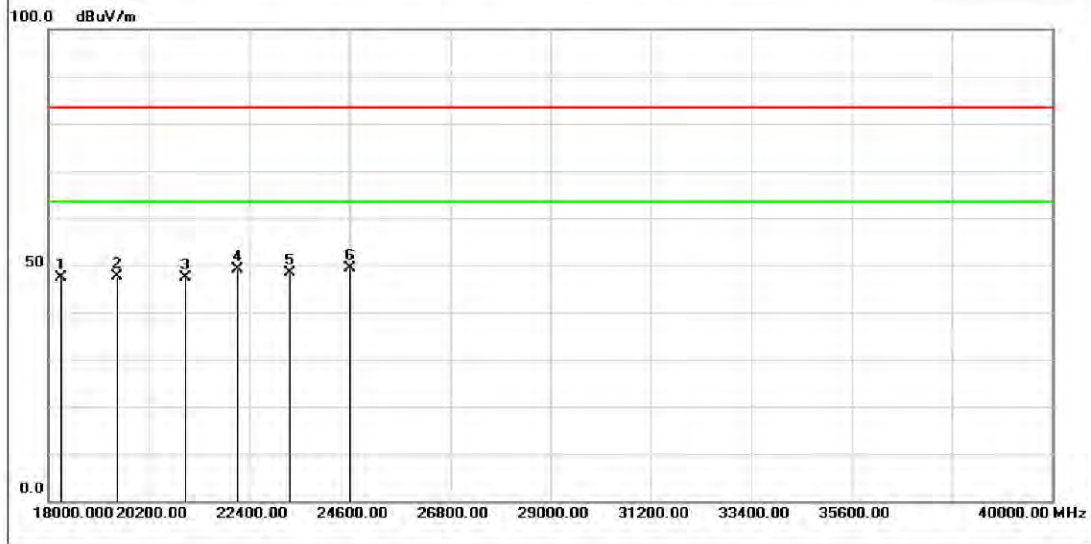

| No. | Mk | Freq. (MHz) | Reading (dBuV) | Factor (dB/m) | Measurement (dBuV/m) | Limit (dBuV/m) | Over (dB) | Height (cm) | Degree (deg.) | Detector | Comment |
|-----|----|----------------|-------------------|------------------|-------------------------|-------------------|--------------|----------------|------------------|----------|---------|
| 1 | | 18286.000 | 49.43 | -2.10 | 47.33 | 83.50 | -36.17 | | | peak | |
| 2 | | 19518.000 | 49.28 | -1.72 | 47.56 | 83.50 | -35.94 | | | peak | |
| 3 | | 21014.000 | 48.91 | -1.60 | 47.31 | 83.50 | -36.19 | | | peak | |
| 4 | | 22136.000 | 48.37 | 0.73 | 49.10 | 83.50 | -34.40 | | | peak | |
| 5 | | 23280.000 | 46.46 | 1.99 | 48.45 | 83.50 | -35.05 | | | peak | |
| 6 | * | 24622.000 | 47.22 | 2.12 | 49.34 | 83.50 | -34.16 | 100 | 326 | peak | |

*:Maximum data x:Over limit !:over margin

Unless otherwise stated the results shown in this test report refer only to the sample(s) tested and such sample(s) are retained for 90 days only.

除非另有說明，此報告結果僅對測試之樣品負責，同時此樣品僅保留90天。本報告未經本公司書面許可，不可部份複製。

This document is issued by the Company subject to its General Conditions of Service printed overleaf, available on request or accessible at <http://www.sgs.com.tw/Terms-and-Conditions> and for electronic format documents, subject to Terms and Conditions for Electronic Documents at <http://www.sgs.com.tw/Terms-and-Conditions>. Attention is drawn to the limitation of liability, indemnification and jurisdiction issues defined therein. Any holder of this document is advised that information contained hereon reflects the Company's findings at the time of its intervention only and within the limits of Client's instructions, if any. The Company's sole responsibility is to its Client and this document does not exonerate parties to a transaction from exercising all their rights and obligations under the transaction documents. This document cannot be reproduced except in full, without prior written approval of the Company. Any unauthorized alteration, forgery or falsification of the content or appearance of this document is unlawful and offenders may be prosecuted to the fullest extent of the law.

SGS Taiwan Ltd. No.2, Keji 1st Rd., Guishan District, Taoyuan City, Taiwan / 桃園市龜山區科技一路2號

台灣檢驗科技股份有限公司

t (886-2) 2299-3279

f (886-3) 327-7559

www.sgs.com.tw

Member of SGS Group



Config_1_V

| | | |
|---------------------------------|-------------------------------|-----------------------|
| Site: SGS 966 Chamber A | Date: 2020/12/10 | Time: 下午 05:27:27 |
| Limit: FCC Class B 1G-18G(Peak) | Polarization: Vertical | Temperature: 21 °C |
| Mode: Config 1 | Power: AC 120V/60Hz | Humidity: 75 %RH |
| Report: MH-2020-B0179 | Distance: 3m | Air Pressure: 990 hpa |
| Tester: Boris Liao | | |
| Note: LTE B05 | | |

SGS Taiwan Ltd.-Electromagnetic Compatibility Laboratory Address: No.2, Keji 1st Rd., Guishan District, Taoyuan City, Taiwan 333

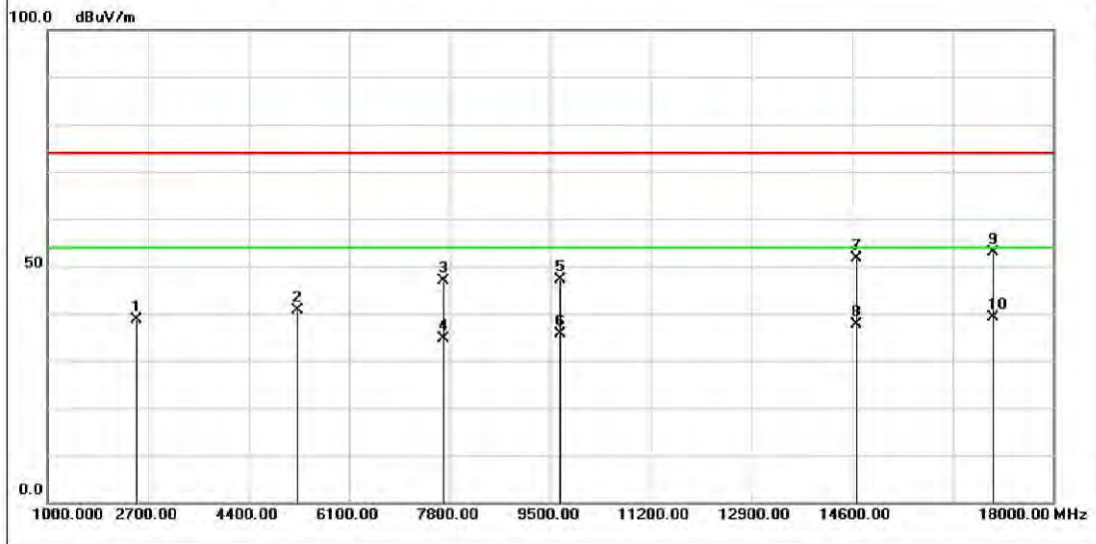

| No. | Mk | Freq. (MHz) | Reading (dBuV) | Factor (dB/m) | Measurement (dBuV/m) | Limit (dBuV/m) | Over (dB) | Height (cm) | Degree (deg.) | Detector | Comment |
|-----|----|----------------|-------------------|------------------|-------------------------|-------------------|--------------|----------------|------------------|----------|---------|
| 1 | | 2513.000 | 56.75 | -18.15 | 38.60 | 74.00 | -35.40 | | | peak | |
| 2 | | 5233.000 | 54.28 | -13.55 | 40.73 | 74.00 | -33.27 | | | peak | |
| 3 | | 7698.000 | 52.14 | -5.31 | 46.83 | 74.00 | -27.17 | | | peak | |
| 4 | | 7698.000 | 39.83 | -5.31 | 34.52 | 54.00 | -19.48 | | | AVG | |
| 5 | | 9670.000 | 48.73 | -1.51 | 47.22 | 74.00 | -26.78 | | | peak | |
| 6 | | 9670.000 | 37.17 | -1.51 | 35.66 | 54.00 | -18.34 | | | AVG | |
| 7 | | 14668.000 | 47.80 | 3.94 | 51.74 | 74.00 | -22.26 | | | peak | |
| 8 | | 14668.000 | 33.80 | 3.94 | 37.74 | 54.00 | -16.26 | | | AVG | |
| 9 | | 16980.000 | 47.60 | 5.27 | 52.87 | 74.00 | -21.13 | 110 | 278 | peak | |
| 10 | * | 16980.000 | 33.98 | 5.27 | 39.25 | 54.00 | -14.75 | 110 | 278 | AVG | |

*:Maximum data x:Over limit !:over margin

Unless otherwise stated the results shown in this test report refer only to the sample(s) tested and such sample(s) are retained for 90 days only.

除非另有說明，此報告結果僅對測試之樣品負責，同時此樣品僅保留90天。本報告未經本公司書面許可，不可部份複製。

This document is issued by the Company subject to its General Conditions of Service printed overleaf, available on request or accessible at <http://www.sgs.com.tw/Terms-and-Conditions> and for electronic format documents, subject to Terms and Conditions for Electronic Documents at <http://www.sgs.com.tw/Terms-and-Conditions>. Attention is drawn to the limitation of liability, indemnification and jurisdiction issues defined therein. Any holder of this document is advised that information contained hereon reflects the Company's findings at the time of its intervention only and within the limits of Client's instructions, if any. The Company's sole responsibility is to its Client and this document does not exonerate parties to a transaction from exercising all their rights and obligations under the transaction documents. This document cannot be reproduced except in full, without prior written approval of the Company. Any unauthorized alteration, forgery or falsification of the content or appearance of this document is unlawful and offenders may be prosecuted to the fullest extent of the law.

SGS Taiwan Ltd. No.2, Keji 1st Rd., Guishan District, Taoyuan City, Taiwan / 桃園市龜山區科技一路2號

台灣檢驗科技股份有限公司

t (886-2) 2299-3279

f (886-3) 327-7559

www.sgs.com.tw

Member of SGS Group



| | | |
|------------------------------------|-------------------------------|-----------------------|
| Site: SGS 966 Chamber A | Date: 2020/12/11 | Time: 上午 01:20:26 |
| Limit: FCC Class B 1m 18-40G(Peak) | Polarization: Vertical | Temperature: 21 °C |
| Mode: Config 1 | Power: AC 120V/60Hz | Humidity: 75 %RH |
| Report: MH-2020-B0179 | Distance: 1m | Air Pressure: 990 hpa |
| Tester: Boris Liao | | |
| Note: LTE B05 | | |

SGS Taiwan Ltd.-Electromagnetic Compatibility Laboratory Address: No.2, Keji 1st Rd., Guishan District, Taoyuan City, Taiwan 333

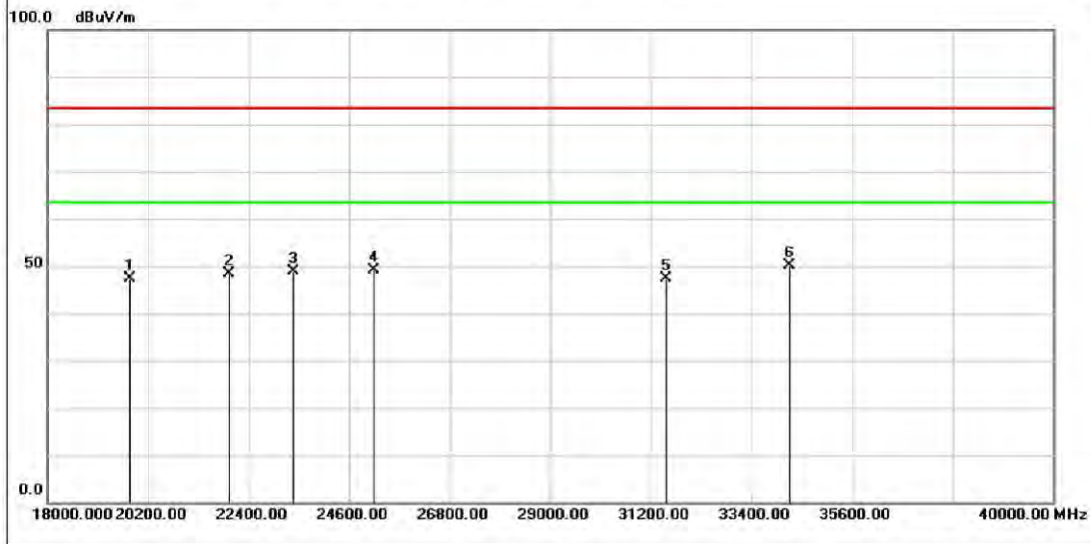

| No. | Mk | Freq. (MHz) | Reading (dBuV) | Factor (dB/m) | Measurement (dBuV/m) | Limit (dBuV/m) | Over (dB) | Height (cm) | Degree (deg.) | Detector | Comment |
|-----|----|----------------|-------------------|------------------|-------------------------|-------------------|--------------|----------------|------------------|----------|---------|
| 1 | | 19804.000 | 49.40 | -1.95 | 47.45 | 83.50 | -36.05 | | | peak | |
| 2 | | 21982.000 | 47.67 | 0.80 | 48.47 | 83.50 | -35.03 | | | peak | |
| 3 | | 23368.000 | 46.71 | 2.06 | 48.77 | 83.50 | -34.73 | | | peak | |
| 4 | | 25150.000 | 46.61 | 2.62 | 49.23 | 83.50 | -34.27 | | | peak | |
| 5 | | 31530.000 | 44.44 | 2.93 | 47.37 | 83.50 | -36.13 | | | peak | |
| 6 | * | 34236.000 | 45.98 | 4.08 | 50.06 | 83.50 | -33.44 | 100 | 45 | peak | |

*:Maximum data x:Over limit !:over margin

Unless otherwise stated the results shown in this test report refer only to the sample(s) tested and such sample(s) are retained for 90 days only.

除非另有說明，此報告結果僅對測試之樣品負責，同時此樣品僅保留90天。本報告未經本公司書面許可，不可部份複製。

This document is issued by the Company subject to its General Conditions of Service printed overleaf, available on request or accessible at <http://www.sgs.com.tw/Terms-and-Conditions> and for electronic format documents, subject to Terms and Conditions for Electronic Documents at <http://www.sgs.com.tw/Terms-and-Conditions>. Attention is drawn to the limitation of liability, indemnification and jurisdiction issues defined therein. Any holder of this document is advised that information contained hereon reflects the Company's findings at the time of its intervention only and within the limits of Client's instructions, if any. The Company's sole responsibility is to its Client and this document does not exonerate parties to a transaction from exercising all their rights and obligations under the transaction documents. This document cannot be reproduced except in full, without prior written approval of the Company. Any unauthorized alteration, forgery or falsification of the content or appearance of this document is unlawful and offenders may be prosecuted to the fullest extent of the law.

SGS Taiwan Ltd. No.2, Keji 1st Rd., Guishan District, Taoyuan City, Taiwan / 桃園市龜山區科技一路2號

台灣檢驗科技股份有限公司

t (886-2) 2299-3279

f (886-3) 327-7559

www.sgs.com.tw

Member of SGS Group



Config_2_H

| | | |
|---------------------------------|---------------------------------|-----------------------|
| Site: SGS 966 Chamber A | Date: 2020/12/11 | Time: 上午 00:35:44 |
| Limit: FCC Class B 1G-18G(Peak) | Polarization: Horizontal | Temperature: 21 °C |
| Mode: Config 2 | Power: AC 120V/60Hz | Humidity: 75 %RH |
| Report: MH-2020-B0179 | Distance: 3m | Air Pressure: 990 hpa |
| Tester: Boris Liao | | |
| Note: Data Read (SD Card) | | |

SGS Taiwan Ltd.-Electromagnetic Compatibility Laboratory Address: No.2, Keji 1st Rd., Guishan District, Taoyuan City, Taiwan 333

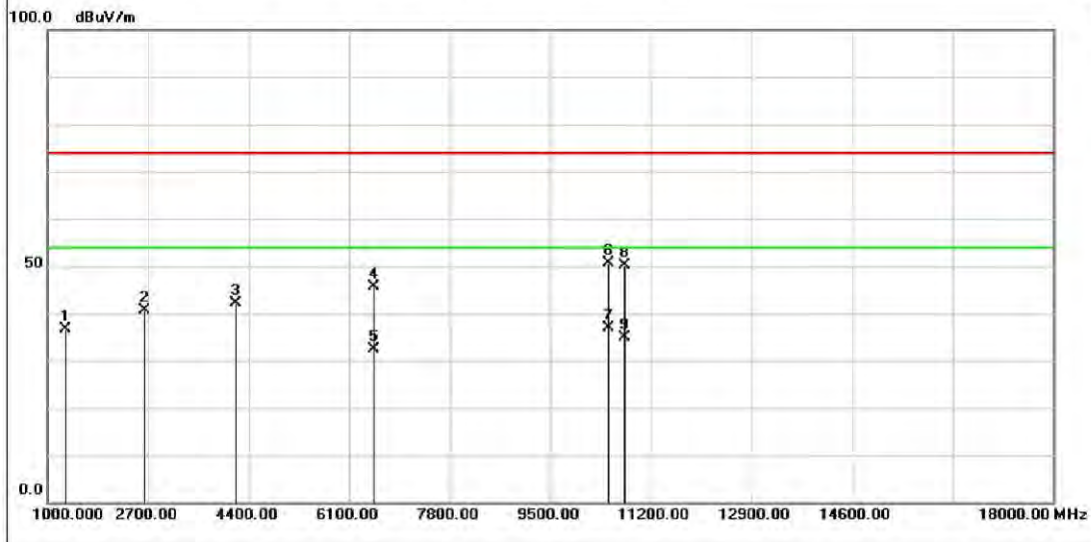

| No. | Mk | Freq. (MHz) | Reading (dBuV) | Factor (dB/m) | Measurement (dBuV/m) | Limit (dBuV/m) | Over (dB) | Height (cm) | Degree (deg.) | Detector | Comment |
|-----|----|----------------|-------------------|------------------|-------------------------|-------------------|--------------|----------------|------------------|----------|---------|
| 1 | | 1306.000 | 59.65 | -23.01 | 36.64 | 74.00 | -37.36 | | | peak | |
| 2 | | 2649.000 | 59.00 | -18.30 | 40.70 | 74.00 | -33.30 | | | peak | |
| 3 | | 4179.000 | 58.00 | -15.80 | 42.20 | 74.00 | -31.80 | | | peak | |
| 4 | | 6525.000 | 53.74 | -8.17 | 45.57 | 74.00 | -28.43 | | | peak | |
| 5 | | 6525.000 | 40.49 | -8.17 | 32.32 | 54.00 | -21.68 | | | AVG | |
| 6 | | 10486.000 | 50.70 | -0.10 | 50.60 | 74.00 | -23.40 | 100 | 222 | peak | |
| 7 | * | 10486.000 | 37.09 | -0.10 | 36.99 | 54.00 | -17.01 | 100 | 222 | AVG | |
| 8 | | 10758.000 | 50.29 | -0.20 | 50.09 | 74.00 | -23.91 | | | peak | |
| 9 | | 10758.000 | 35.05 | -0.20 | 34.85 | 54.00 | -19.15 | | | AVG | |

*:Maximum data x:Over limit !:over margin

Unless otherwise stated the results shown in this test report refer only to the sample(s) tested and such sample(s) are retained for 90 days only.

除非另有說明，此報告結果僅對測試之樣品負責，同時此樣品僅保留90天。本報告未經本公司書面許可，不可部份複製。

This document is issued by the Company subject to its General Conditions of Service printed overleaf, available on request or accessible at <http://www.sgs.com.tw/Terms-and-Conditions> and for electronic format documents, subject to Terms and Conditions for Electronic Documents at <http://www.sgs.com.tw/Terms-and-Conditions>. Attention is drawn to the limitation of liability, indemnification and jurisdiction issues defined therein. Any holder of this document is advised that information contained hereon reflects the Company's findings at the time of its intervention only and within the limits of Client's instructions, if any. The Company's sole responsibility is to its Client and this document does not exonerate parties to a transaction from exercising all their rights and obligations under the transaction documents. This document cannot be reproduced except in full, without prior written approval of the Company. Any unauthorized alteration, forgery or falsification of the content or appearance of this document is unlawful and offenders may be prosecuted to the fullest extent of the law.

SGS Taiwan Ltd. No.2, Keji 1st Rd., Guishan District, Taoyuan City, Taiwan / 桃園市龜山區科技一路2號

台灣檢驗科技股份有限公司

t (886-2) 2299-3279

f (886-3) 327-7559

www.sgs.com.tw

Member of SGS Group



| | | |
|------------------------------------|---------------------------------|-----------------------|
| Site: SGS 966 Chamber A | Date: 2020/12/11 | Time: 上午 01:10:52 |
| Limit: FCC Class B 1m 18-40G(Peak) | Polarization: Horizontal | Temperature: 21 °C |
| Mode: Config 2 | Power: AC 120V/60Hz | Humidity: 75 %RH |
| Report: MH-2020-B0179 | Distance: 1m | Air Pressure: 990 hpa |
| Tester: Boris Liao | | |
| Note: Data Read (SD Card) | | |

SGS Taiwan Ltd.-Electromagnetic Compatibility Laboratory Address: No.2, Keji 1st Rd., Guishan District, Taoyuan City, Taiwan 333

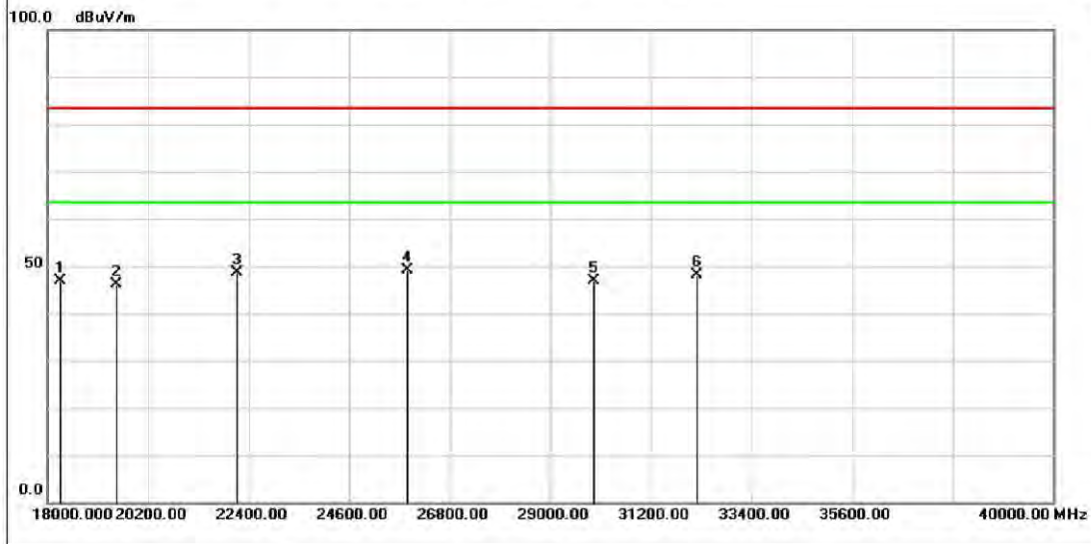

| No. | Mk | Freq. (MHz) | Reading (dBuV) | Factor (dB/m) | Measurement (dBuV/m) | Limit (dBuV/m) | Over (dB) | Height (cm) | Degree (deg.) | Detector | Comment |
|-----|----|----------------|-------------------|------------------|-------------------------|-------------------|--------------|----------------|------------------|----------|---------|
| 1 | | 18286.000 | 48.93 | -2.10 | 46.83 | 83.50 | -36.67 | | | peak | |
| 2 | | 19518.000 | 47.78 | -1.72 | 46.06 | 83.50 | -37.44 | | | peak | |
| 3 | | 22136.000 | 47.87 | 0.73 | 48.60 | 83.50 | -34.90 | | | peak | |
| 4 | * | 25876.000 | 46.85 | 2.24 | 49.09 | 83.50 | -34.41 | | | peak | |
| 5 | | 29946.000 | 45.26 | 1.59 | 46.85 | 83.50 | -36.65 | | | peak | |
| 6 | | 32212.000 | 45.86 | 2.23 | 48.09 | 83.50 | -35.41 | 100 | 25 | peak | |

*:Maximum data x:Over limit !:over margin

Unless otherwise stated the results shown in this test report refer only to the sample(s) tested and such sample(s) are retained for 90 days only.

除非另有說明，此報告結果僅對測試之樣品負責，同時此樣品僅保留90天。本報告未經本公司書面許可，不可部份複製。

This document is issued by the Company subject to its General Conditions of Service printed overleaf, available on request or accessible at <http://www.sgs.com.tw/Terms-and-Conditions> and for electronic format documents, subject to Terms and Conditions for Electronic Documents at <http://www.sgs.com.tw/Terms-and-Conditions>. Attention is drawn to the limitation of liability, indemnification and jurisdiction issues defined therein. Any holder of this document is advised that information contained hereon reflects the Company's findings at the time of its intervention only and within the limits of Client's instructions, if any. The Company's sole responsibility is to its Client and this document does not exonerate parties to a transaction from exercising all their rights and obligations under the transaction documents. This document cannot be reproduced except in full, without prior written approval of the Company. Any unauthorized alteration, forgery or falsification of the content or appearance of this document is unlawful and offenders may be prosecuted to the fullest extent of the law.

SGS Taiwan Ltd. No.2, Keji 1st Rd., Guishan District, Taoyuan City, Taiwan / 桃園市龜山區科技一路2號

台灣檢驗科技股份有限公司

t (886-2) 2299-3279

f (886-3) 327-7559

www.sgs.com.tw

Member of SGS Group



Config_2_V

| | | |
|---------------------------------|-------------------------------|-----------------------|
| Site: SGS 966 Chamber A | Date: 2020/12/11 | Time: 上午 00:23:04 |
| Limit: FCC Class B 1G-18G(Peak) | Polarization: Vertical | Temperature: 21 °C |
| Mode: Config 2 | Power: AC 120V/60Hz | Humidity: 75 %RH |
| Report: MH-2020-B0179 | Distance: 3m | Air Pressure: 990 hpa |
| Tester: Boris Liao | | |
| Note: Data Read (SD Card) | | |

SGS Taiwan Ltd.-Electromagnetic Compatibility Laboratory Address: No.2, Keji 1st Rd., Guishan District, Taoyuan City, Taiwan 333

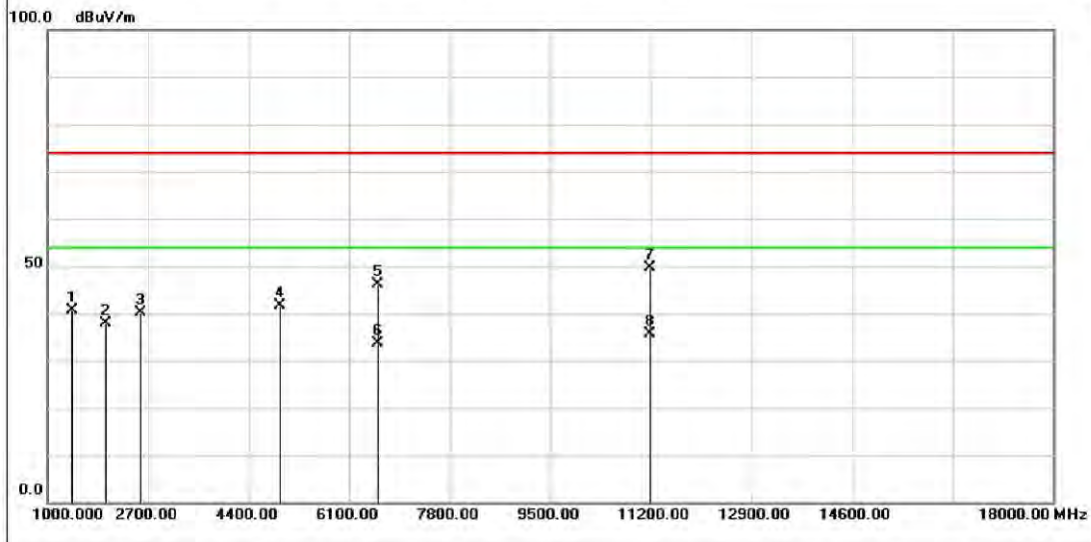

| No. | Mk | Freq. (MHz) | Reading (dBuV) | Factor (dB/m) | Measurement (dBuV/m) | Limit (dBuV/m) | Over (dB) | Height (cm) | Degree (deg.) | Detector | Comment |
|-----|----|----------------|-------------------|------------------|-------------------------|-------------------|--------------|----------------|------------------|----------|---------|
| 1 | | 1425.000 | 63.28 | -22.67 | 40.61 | 74.00 | -33.39 | | | peak | |
| 2 | | 1986.000 | 59.55 | -21.64 | 37.91 | 74.00 | -36.09 | | | peak | |
| 3 | | 2581.000 | 58.23 | -18.21 | 40.02 | 74.00 | -33.98 | | | peak | |
| 4 | | 4927.000 | 55.73 | -14.18 | 41.55 | 74.00 | -32.45 | | | peak | |
| 5 | | 6593.000 | 54.29 | -8.09 | 46.20 | 74.00 | -27.80 | | | peak | |
| 6 | | 6593.000 | 41.78 | -8.09 | 33.69 | 54.00 | -20.31 | | | AVG | |
| 7 | | 11183.000 | 50.36 | -0.78 | 49.58 | 74.00 | -24.42 | 110 | 325 | peak | |
| 8 | * | 11183.000 | 36.48 | -0.78 | 35.70 | 54.00 | -18.30 | 110 | 325 | AVG | |

*:Maximum data x:Over limit !:over margin

Unless otherwise stated the results shown in this test report refer only to the sample(s) tested and such sample(s) are retained for 90 days only.

除非另有說明，此報告結果僅對測試之樣品負責，同時此樣品僅保留90天。本報告未經本公司書面許可，不可部份複製。

This document is issued by the Company subject to its General Conditions of Service printed overleaf, available on request or accessible at <http://www.sgs.com.tw/Terms-and-Conditions> and for electronic format documents, subject to Terms and Conditions for Electronic Documents at <http://www.sgs.com.tw/Terms-and-Conditions>. Attention is drawn to the limitation of liability, indemnification and jurisdiction issues defined therein. Any holder of this document is advised that information contained hereon reflects the Company's findings at the time of its intervention only and within the limits of Client's instructions, if any. The Company's sole responsibility is to its Client and this document does not exonerate parties to a transaction from exercising all their rights and obligations under the transaction documents. This document cannot be reproduced except in full, without prior written approval of the Company. Any unauthorized alteration, forgery or falsification of the content or appearance of this document is unlawful and offenders may be prosecuted to the fullest extent of the law.

SGS Taiwan Ltd. No.2, Keji 1st Rd., Guishan District, Taoyuan City, Taiwan / 桃園市龜山區科技一路2號

台灣檢驗科技股份有限公司

t (886-2) 2299-3279

f (886-3) 327-7559

www.sgs.com.tw

Member of SGS Group



| | | |
|------------------------------------|-------------------------------|-----------------------|
| Site: SGS 966 Chamber A | Date: 2020/12/11 | Time: 上午 00:55:26 |
| Limit: FCC Class B 1m 18-40G(Peak) | Polarization: Vertical | Temperature: 21 °C |
| Mode: Config 2 | Power: AC 120V/60Hz | Humidity: 75 %RH |
| Report: MH-2020-B0179 | Distance: 1m | Air Pressure: 990 hpa |
| Tester: Boris Liao | | |
| Note: Data Read (SD Card) | | |

SGS Taiwan Ltd.-Electromagnetic Compatibility Laboratory Address: No.2, Keji 1st Rd., Guishan District, Taoyuan City, Taiwan 333

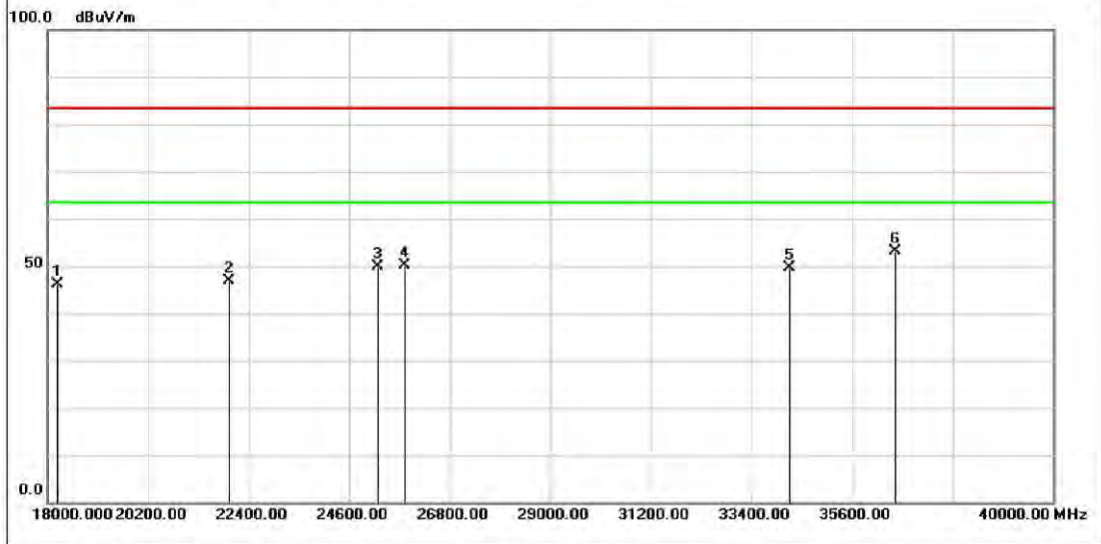

| No. | Mk | Freq. (MHz) | Reading (dBuV) | Factor (dB/m) | Measurement (dBuV/m) | Limit (dBuV/m) | Over (dB) | Height (cm) | Degree (deg.) | Detector | Comment |
|-----|----|----------------|-------------------|------------------|-------------------------|-------------------|--------------|----------------|------------------|----------|---------|
| 1 | | 18220.000 | 48.19 | -2.10 | 46.09 | 83.50 | -37.41 | | | peak | |
| 2 | | 21982.000 | 46.17 | 0.80 | 46.97 | 83.50 | -36.53 | | | peak | |
| 3 | | 25216.000 | 46.96 | 2.81 | 49.77 | 83.50 | -33.73 | | | peak | |
| 4 | | 25810.000 | 47.57 | 2.49 | 50.06 | 83.50 | -33.44 | | | peak | |
| 5 | | 34236.000 | 45.48 | 4.08 | 49.56 | 83.50 | -33.94 | | | peak | |
| 6 | * | 36546.000 | 44.68 | 8.48 | 53.16 | 83.50 | -30.34 | 100 | 0 | peak | |

*:Maximum data x:Over limit !:over margin

Unless otherwise stated the results shown in this test report refer only to the sample(s) tested and such sample(s) are retained for 90 days only.
 除非另有說明，此報告結果僅對測試之樣品負責，同時此樣品僅保留90天。本報告未經本公司書面許可，不可部份複製。
 This document is issued by the Company subject to its General Conditions of Service printed overleaf, available on request or accessible at <http://www.sgs.com.tw/Terms-and-Conditions> and for electronic format documents, subject to Terms and Conditions for Electronic Documents at <http://www.sgs.com.tw/Terms-and-Conditions>. Attention is drawn to the limitation of liability, indemnification and jurisdiction issues defined therein. Any holder of this document is advised that information contained hereon reflects the Company's findings at the time of its intervention only and within the limits of Client's instructions, if any. The Company's sole responsibility is to its Client and this document does not exonerate parties to a transaction from exercising all their rights and obligations under the transaction documents. This document cannot be reproduced except in full, without prior written approval of the Company. Any unauthorized alteration, forgery or falsification of the content or appearance of this document is unlawful and offenders may be prosecuted to the fullest extent of the law.



Config_3_H

| | | |
|---------------------------------|---------------------------------|-----------------------|
| Site: SGS 966 Chamber A | Date: 2020/12/10 | Time: 下午 10:51:48 |
| Limit: FCC Class B 1G-18G(Peak) | Polarization: Horizontal | Temperature: 21 °C |
| Mode: Config 3 | Power: AC 120V/60Hz | Humidity: 75 %RH |
| Report: MH-2020-B0179 | Distance: 3m | Air Pressure: 990 hpa |
| Tester: Boris Liao | | |
| Note: REC Back | | |

SGS Taiwan Ltd.-Electromagnetic Compatibility Laboratory Address: No.2, Keji 1st Rd., Guishan District, Taoyuan City, Taiwan 333

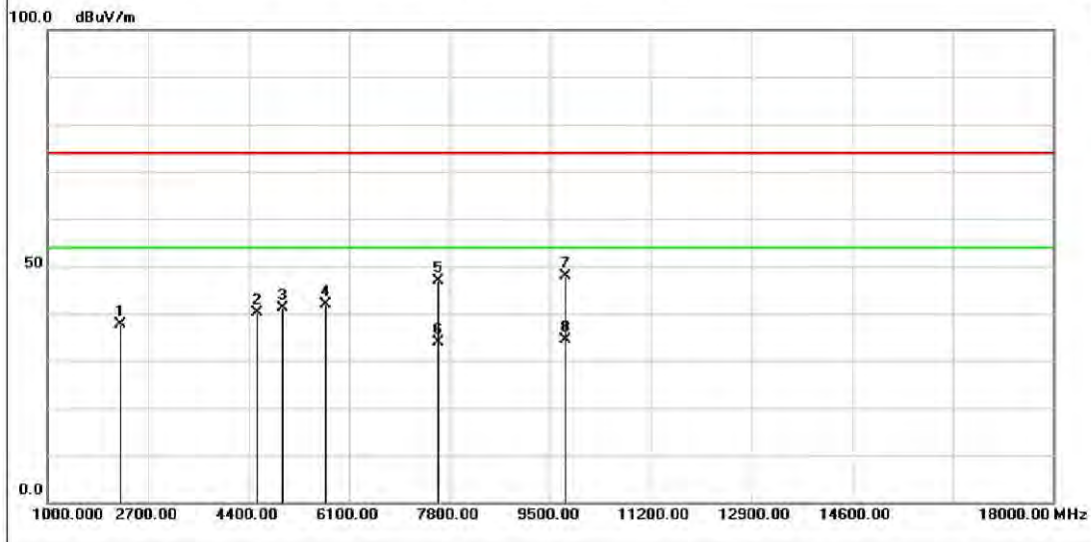

| No. | Mk | Freq. (MHz) | Reading (dBuV) | Factor (dB/m) | Measurement (dBuV/m) | Limit (dBuV/m) | Over (dB) | Height (cm) | Degree (deg.) | Detector | Comment |
|-----|----|----------------|-------------------|------------------|-------------------------|-------------------|--------------|----------------|------------------|----------|---------|
| 1 | | 2241.000 | 56.23 | -18.50 | 37.73 | 74.00 | -36.27 | | | peak | |
| 2 | | 4553.000 | 54.79 | -14.75 | 40.04 | 74.00 | -33.96 | | | peak | |
| 3 | | 4978.000 | 55.20 | -14.07 | 41.13 | 74.00 | -32.87 | | | peak | |
| 4 | | 5709.000 | 54.34 | -12.41 | 41.93 | 74.00 | -32.07 | | | peak | |
| 5 | | 7596.000 | 52.44 | -5.46 | 46.98 | 74.00 | -27.02 | | | peak | |
| 6 | | 7596.000 | 39.24 | -5.46 | 33.78 | 54.00 | -20.22 | | | AVG | |
| 7 | | 9755.000 | 49.30 | -1.47 | 47.83 | 74.00 | -26.17 | 100 | 185 | peak | |
| 8 | * | 9755.000 | 35.75 | -1.47 | 34.28 | 54.00 | -19.72 | 100 | 185 | AVG | |

*:Maximum data x:Over limit !:over margin

Unless otherwise stated the results shown in this test report refer only to the sample(s) tested and such sample(s) are retained for 90 days only.

除非另有說明，此報告結果僅對測試之樣品負責，同時此樣品僅保留90天。本報告未經本公司書面許可，不可部份複製。

This document is issued by the Company subject to its General Conditions of Service printed overleaf, available on request or accessible at <http://www.sgs.com.tw/Terms-and-Conditions> and for electronic format documents, subject to Terms and Conditions for Electronic Documents at <http://www.sgs.com.tw/Terms-and-Conditions>. Attention is drawn to the limitation of liability, indemnification and jurisdiction issues defined therein. Any holder of this document is advised that information contained hereon reflects the Company's findings at the time of its intervention only and within the limits of Client's instructions, if any. The Company's sole responsibility is to its Client and this document does not exonerate parties to a transaction from exercising all their rights and obligations under the transaction documents. This document cannot be reproduced except in full, without prior written approval of the Company. Any unauthorized alteration, forgery or falsification of the content or appearance of this document is unlawful and offenders may be prosecuted to the fullest extent of the law.

SGS Taiwan Ltd. No.2, Keji 1st Rd., Guishan District, Taoyuan City, Taiwan / 桃園市龜山區科技一路2號

台灣檢驗科技股份有限公司

t (886-2) 2299-3279

f (886-3) 327-7559

www.sgs.com.tw

Member of SGS Group



| | | |
|------------------------------------|---------------------------------|-----------------------|
| Site: SGS 966 Chamber A | Date: 2020/12/11 | Time: 上午 01:45:50 |
| Limit: FCC Class B 1m 18-40G(Peak) | Polarization: Horizontal | Temperature: 21 °C |
| Mode: Config 3 | Power: AC 120V/60Hz | Humidity: 75 %RH |
| Report: MH-2020-B0179 | Distance: 1m | Air Pressure: 990 hpa |
| Tester: Boris Liao | | |
| Note: REC Back | | |

SGS Taiwan Ltd.-Electromagnetic Compatibility Laboratory Address: No.2, Keji 1st Rd., Guishan District, Taoyuan City, Taiwan 333

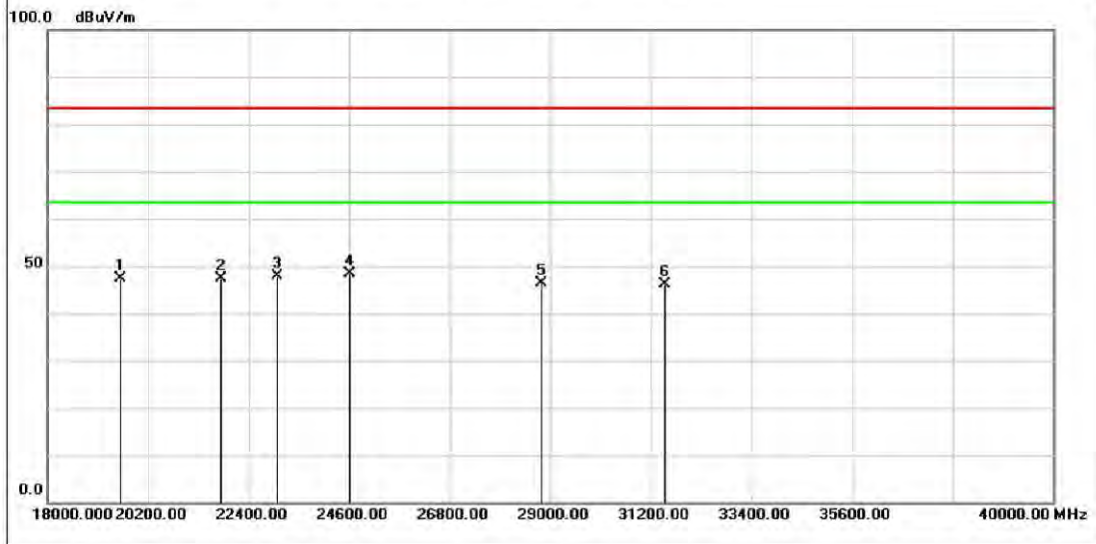

| No. | Mk | Freq. (MHz) | Reading (dBuV) | Factor (dB/m) | Measurement (dBuV/m) | Limit (dBuV/m) | Over (dB) | Height (cm) | Degree (deg.) | Detector | Comment |
|-----|----|----------------|-------------------|------------------|-------------------------|-------------------|--------------|----------------|------------------|----------|---------|
| 1 | | 19606.000 | 49.28 | -1.79 | 47.49 | 83.50 | -36.01 | | | peak | |
| 2 | | 21806.000 | 47.55 | -0.15 | 47.40 | 83.50 | -36.10 | | | peak | |
| 3 | | 23016.000 | 46.07 | 1.72 | 47.79 | 83.50 | -35.71 | | | peak | |
| 4 | * | 24622.000 | 46.22 | 2.12 | 48.34 | 83.50 | -35.16 | | | peak | |
| 5 | | 28802.000 | 45.62 | 0.82 | 46.44 | 83.50 | -37.06 | | | peak | |
| 6 | | 31508.000 | 43.12 | 2.98 | 46.10 | 83.50 | -37.40 | 100 | 286 | peak | |

*:Maximum data x:Over limit !:over margin

Unless otherwise stated the results shown in this test report refer only to the sample(s) tested and such sample(s) are retained for 90 days only.
 除非另有說明，此報告結果僅對測試之樣品負責，同時此樣品僅保留90天。本報告未經本公司書面許可，不可部份複製。

This document is issued by the Company subject to its General Conditions of Service printed overleaf, available on request or accessible at <http://www.sgs.com.tw/Terms-and-Conditions> and for electronic format documents, subject to Terms and Conditions for Electronic Documents at <http://www.sgs.com.tw/Terms-and-Conditions>. Attention is drawn to the limitation of liability, indemnification and jurisdiction issues defined therein. Any holder of this document is advised that information contained hereon reflects the Company's findings at the time of its intervention only and within the limits of Client's instructions, if any. The Company's sole responsibility is to its Client and this document does not exonerate parties to a transaction from exercising all their rights and obligations under the transaction documents. This document cannot be reproduced except in full, without prior written approval of the Company. Any unauthorized alteration, forgery or falsification of the content or appearance of this document is unlawful and offenders may be prosecuted to the fullest extent of the law.



Config_3_V

| | | |
|---------------------------------|-------------------------------|-----------------------|
| Site: SGS 966 Chamber A | Date: 2020/12/10 | Time: 下午 10:40:50 |
| Limit: FCC Class B 1G-18G(Peak) | Polarization: Vertical | Temperature: 21 °C |
| Mode: Config 3 | Power: AC 120V/60Hz | Humidity: 75 %RH |
| Report: MH-2020-B0179 | Distance: 3m | Air Pressure: 990 hpa |
| Tester: Boris Liao | | |
| Note: REC Back | | |

SGS Taiwan Ltd.-Electromagnetic Compatibility Laboratory Address: No.2, Keji 1st Rd., Guishan District, Taoyuan City, Taiwan 333

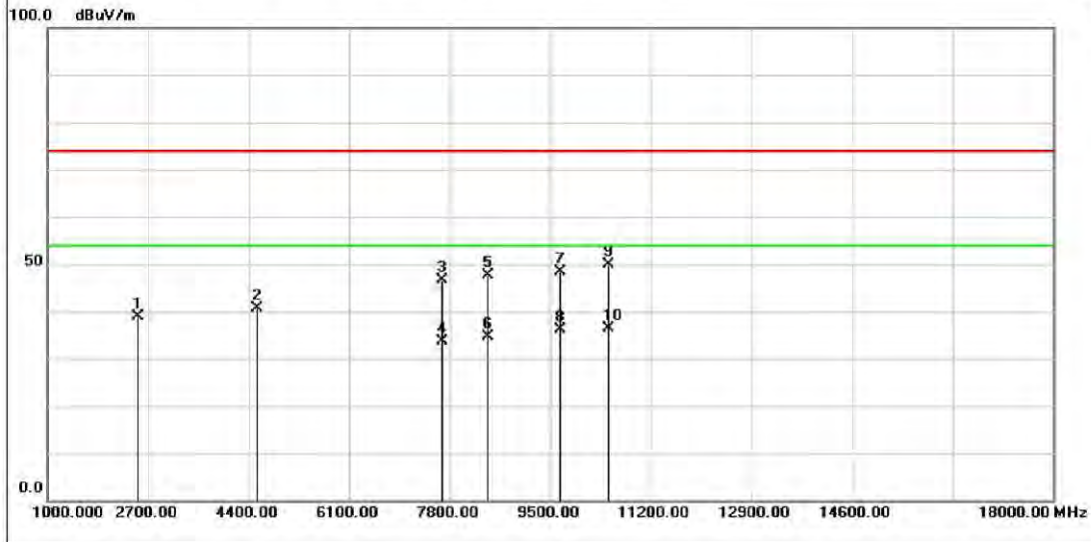

| No. | Mk | Freq. (MHz) | Reading (dBuV) | Factor (dB/m) | Measurement (dBuV/m) | Limit (dBuV/m) | Over (dB) | Height (cm) | Degree (deg.) | Detector | Comment |
|-----|----|----------------|-------------------|------------------|-------------------------|-------------------|--------------|----------------|------------------|----------|---------|
| 1 | | 2530.000 | 57.10 | -18.18 | 38.92 | 74.00 | -35.08 | | | peak | |
| 2 | | 4553.000 | 55.32 | -14.75 | 40.57 | 74.00 | -33.43 | | | peak | |
| 3 | | 7664.000 | 51.89 | -5.32 | 46.57 | 74.00 | -27.43 | | | peak | |
| 4 | | 7664.000 | 38.97 | -5.32 | 33.65 | 54.00 | -20.35 | | | AVG | |
| 5 | | 8446.000 | 51.64 | -4.04 | 47.60 | 74.00 | -26.40 | | | peak | |
| 6 | | 8446.000 | 38.71 | -4.04 | 34.67 | 54.00 | -19.33 | | | AVG | |
| 7 | | 9670.000 | 49.89 | -1.51 | 48.38 | 74.00 | -25.62 | | | peak | |
| 8 | | 9670.000 | 37.76 | -1.51 | 36.25 | 54.00 | -17.75 | | | AVG | |
| 9 | | 10486.000 | 50.03 | -0.10 | 49.93 | 74.00 | -24.07 | 100 | 239 | peak | |
| 10 | * | 10486.000 | 36.51 | -0.10 | 36.41 | 54.00 | -17.59 | 100 | 239 | AVG | |

*:Maximum data x:Over limit !:over margin

Unless otherwise stated the results shown in this test report refer only to the sample(s) tested and such sample(s) are retained for 90 days only.

除非另有說明，此報告結果僅對測試之樣品負責，同時此樣品僅保留90天。本報告未經本公司書面許可，不可部份複製。

This document is issued by the Company subject to its General Conditions of Service printed overleaf, available on request or accessible at <http://www.sgs.com.tw/Terms-and-Conditions> and for electronic format documents, subject to Terms and Conditions for Electronic Documents at <http://www.sgs.com.tw/Terms-and-Conditions>. Attention is drawn to the limitation of liability, indemnification and jurisdiction issues defined therein. Any holder of this document is advised that information contained hereon reflects the Company's findings at the time of its intervention only and within the limits of Client's instructions, if any. The Company's sole responsibility is to its Client and this document does not exonerate parties to a transaction from exercising all their rights and obligations under the transaction documents. This document cannot be reproduced except in full, without prior written approval of the Company. Any unauthorized alteration, forgery or falsification of the content or appearance of this document is unlawful and offenders may be prosecuted to the fullest extent of the law.

SGS Taiwan Ltd. No.2, Keji 1st Rd., Guishan District, Taoyuan City, Taiwan / 桃園市龜山區科技一路2號

台灣檢驗科技股份有限公司

t (886-2) 2299-3279

f (886-3) 327-7559

www.sgs.com.tw

Member of SGS Group



| | | |
|------------------------------------|-------------------------------|-----------------------|
| Site: SGS 966 Chamber A | Date: 2020/12/11 | Time: 上午 01:36:02 |
| Limit: FCC Class B 1m 18-40G(Peak) | Polarization: Vertical | Temperature: 21 °C |
| Mode: Config 3 | Power: AC 120V/60Hz | Humidity: 75 %RH |
| Report: MH-2020-B0179 | Distance: 1m | Air Pressure: 990 hpa |
| Tester: Boris Liao | | |
| Note: REC Back | | |

SGS Taiwan Ltd.-Electromagnetic Compatibility Laboratory Address: No.2, Keji 1st Rd., Guishan District, Taoyuan City, Taiwan 333

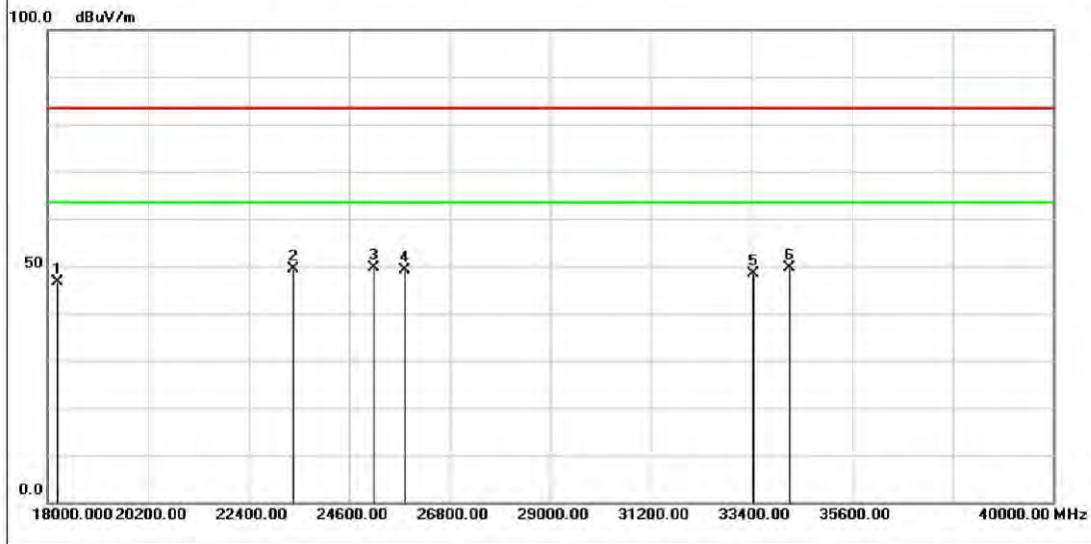

| No. | Mk | Freq. (MHz) | Reading (dBuV) | Factor (dB/m) | Measurement (dBuV/m) | Limit (dBuV/m) | Over (dB) | Height (cm) | Degree (deg.) | Detector | Comment |
|-----|----|----------------|-------------------|------------------|-------------------------|-------------------|--------------|----------------|------------------|----------|---------|
| 1 | | 18220.000 | 48.69 | -2.10 | 46.59 | 83.50 | -36.91 | | | peak | |
| 2 | | 23368.000 | 47.21 | 2.06 | 49.27 | 83.50 | -34.23 | | | peak | |
| 3 | * | 25150.000 | 47.11 | 2.62 | 49.73 | 83.50 | -33.77 | | | peak | |
| 4 | | 25810.000 | 46.57 | 2.49 | 49.06 | 83.50 | -34.44 | | | peak | |
| 5 | | 33444.000 | 44.71 | 3.62 | 48.33 | 83.50 | -35.17 | | | peak | |
| 6 | | 34236.000 | 45.48 | 4.08 | 49.56 | 83.50 | -33.94 | 105 | 25 | peak | |

*:Maximum data x:Over limit !:over margin

Unless otherwise stated the results shown in this test report refer only to the sample(s) tested and such sample(s) are retained for 90 days only.

除非另有說明，此報告結果僅對測試之樣品負責，同時此樣品僅保留90天。本報告未經本公司書面許可，不可部份複製。

This document is issued by the Company subject to its General Conditions of Service printed overleaf, available on request or accessible at <http://www.sgs.com.tw/Terms-and-Conditions> and for electronic format documents, subject to Terms and Conditions for Electronic Documents at <http://www.sgs.com.tw/Terms-and-Conditions>. Attention is drawn to the limitation of liability, indemnification and jurisdiction issues defined therein. Any holder of this document is advised that information contained hereon reflects the Company's findings at the time of its intervention only and within the limits of Client's instructions, if any. The Company's sole responsibility is to its Client and this document does not exonerate parties to a transaction from exercising all their rights and obligations under the transaction documents. This document cannot be reproduced except in full, without prior written approval of the Company. Any unauthorized alteration, forgery or falsification of the content or appearance of this document is unlawful and offenders may be prosecuted to the fullest extent of the law.

SGS Taiwan Ltd. No.2, Keji 1st Rd., Guishan District, Taoyuan City, Taiwan / 桃園市龜山區科技一路2號

台灣檢驗科技股份有限公司

t (886-2) 2299-3279

f (886-3) 327-7559

www.sgs.com.tw

Member of SGS Group



Config_4_H

| | | |
|---------------------------------|---------------------------------|-----------------------|
| Site: SGS 966 Chamber A | Date: 2020/12/10 | Time: 下午 07:13:32 |
| Limit: FCC Class B 1G-18G(Peak) | Polarization: Horizontal | Temperature: 21 °C |
| Mode: Config 4 | Power: AC 120V/60Hz | Humidity: 75 %RH |
| Report: MH-2020-B0179 | Distance: 3m | Air Pressure: 990 hpa |
| Tester: Boris Liao | | |
| Note: LTE B05 | | |

SGS Taiwan Ltd.-Electromagnetic Compatibility Laboratory Address: No.2, Keji 1st Rd., Guishan District, Taoyuan City, Taiwan 333

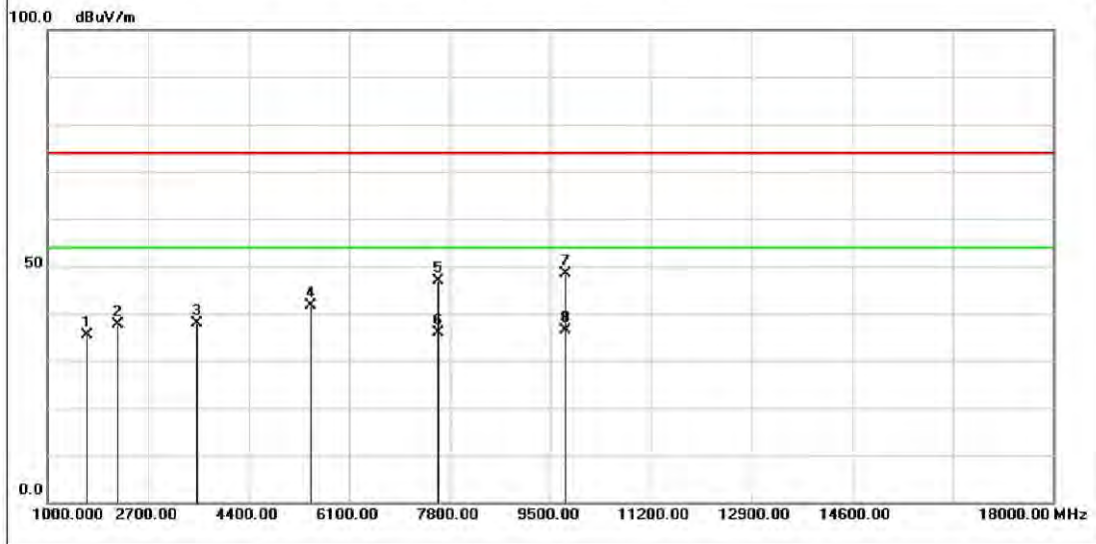

| No. | Mk | Freq. (MHz) | Reading (dBuV) | Factor (dB/m) | Measurement (dBuV/m) | Limit (dBuV/m) | Over (dB) | Height (cm) | Degree (deg.) | Detector | Comment |
|-----|----|----------------|-------------------|------------------|-------------------------|-------------------|--------------|----------------|------------------|----------|---------|
| 1 | | 1663.000 | 58.48 | -22.98 | 35.50 | 74.00 | -38.50 | | | peak | |
| 2 | | 2190.000 | 56.60 | -18.86 | 37.74 | 74.00 | -36.26 | | | peak | |
| 3 | | 3516.000 | 55.35 | -17.37 | 37.98 | 74.00 | -36.02 | | | peak | |
| 4 | | 5454.000 | 54.62 | -13.07 | 41.55 | 74.00 | -32.45 | | | peak | |
| 5 | | 7596.000 | 52.27 | -5.46 | 46.81 | 74.00 | -27.19 | | | peak | |
| 6 | | 7596.000 | 41.31 | -5.46 | 35.85 | 54.00 | -18.15 | | | AVG | |
| 7 | | 9755.000 | 49.76 | -1.47 | 48.29 | 74.00 | -25.71 | 105 | 23 | peak | |
| 8 | * | 9755.000 | 37.95 | -1.47 | 36.48 | 54.00 | -17.52 | 105 | 23 | AVG | |

*:Maximum data x:Over limit !:over margin

Unless otherwise stated the results shown in this test report refer only to the sample(s) tested and such sample(s) are retained for 90 days only.

除非另有說明，此報告結果僅對測試之樣品負責，同時此樣品僅保留90天。本報告未經本公司書面許可，不可部份複製。
This document is issued by the Company subject to its General Conditions of Service printed overleaf, available on request or accessible at <http://www.sgs.com.tw/Terms-and-Conditions> and for electronic format documents, subject to Terms and Conditions for Electronic Documents at <http://www.sgs.com.tw/Terms-and-Conditions>. Attention is drawn to the limitation of liability, indemnification and jurisdiction issues defined therein. Any holder of this document is advised that information contained hereon reflects the Company's findings at the time of its intervention only and within the limits of Client's instructions, if any. The Company's sole responsibility is to its Client and this document does not exonerate parties to a transaction from exercising all their rights and obligations under the transaction documents. This document cannot be reproduced except in full, without prior written approval of the Company. Any unauthorized alteration, forgery or falsification of the content or appearance of this document is unlawful and offenders may be prosecuted to the fullest extent of the law.



| | | |
|------------------------------------|---------------------------------|-----------------------|
| Site: SGS 966 Chamber A | Date: 2020/12/11 | Time: 上午 02:06:28 |
| Limit: FCC Class B 1m 18-40G(Peak) | Polarization: Horizontal | Temperature: 21 °C |
| Mode: Config 4 | Power: AC 120V/60Hz | Humidity: 75 %RH |
| Report: MH-2020-B0179 | Distance: 1m | Air Pressure: 990 hpa |
| Tester: Boris Liao | | |
| Note: LTE B05 | | |

SGS Taiwan Ltd.-Electromagnetic Compatibility Laboratory Address: No.2, Keji 1st Rd., Guishan District, Taoyuan City, Taiwan 333

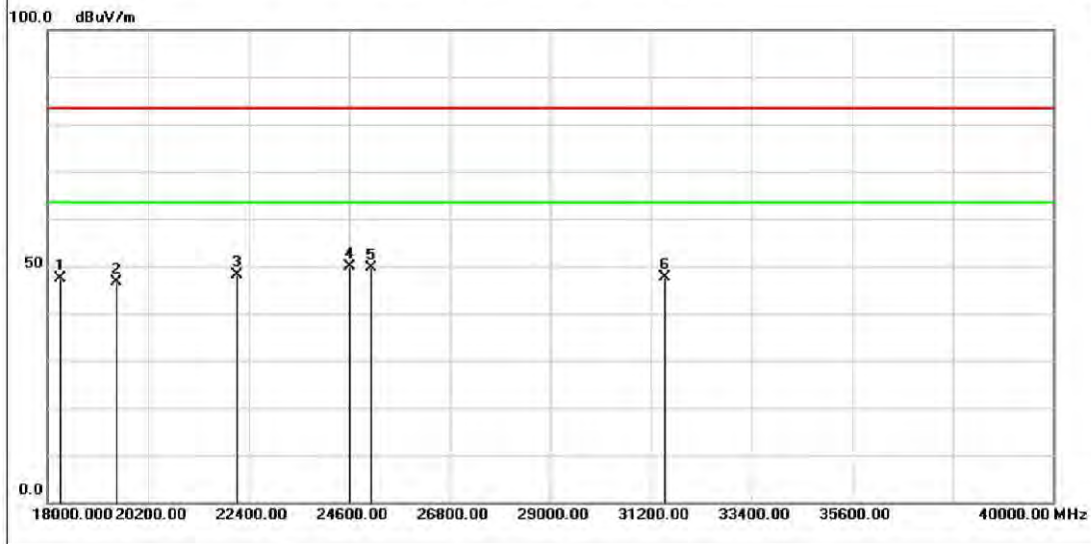

| No. | Mk | Freq. (MHz) | Reading (dBuV) | Factor (dB/m) | Measurement (dBuV/m) | Limit (dBuV/m) | Over (dB) | Height (cm) | Degree (deg.) | Detector | Comment |
|-----|----|----------------|-------------------|------------------|-------------------------|-------------------|--------------|----------------|------------------|----------|---------|
| 1 | | 18286.000 | 49.43 | -2.10 | 47.33 | 83.50 | -36.17 | | | peak | |
| 2 | | 19518.000 | 48.28 | -1.72 | 46.56 | 83.50 | -36.94 | | | peak | |
| 3 | | 22136.000 | 47.37 | 0.73 | 48.10 | 83.50 | -35.40 | | | peak | |
| 4 | * | 24622.000 | 47.72 | 2.12 | 49.84 | 83.50 | -33.66 | | | peak | |
| 5 | | 25084.000 | 47.23 | 2.43 | 49.66 | 83.50 | -33.84 | | | peak | |
| 6 | | 31508.000 | 44.62 | 2.98 | 47.60 | 83.50 | -35.90 | 110 | 26 | peak | |

*:Maximum data x:Over limit !:over margin

Unless otherwise stated the results shown in this test report refer only to the sample(s) tested and such sample(s) are retained for 90 days only.

除非另有說明，此報告結果僅對測試之樣品負責，同時此樣品僅保留90天。本報告未經本公司書面許可，不可部份複製。

This document is issued by the Company subject to its General Conditions of Service printed overleaf, available on request or accessible at <http://www.sgs.com.tw/Terms-and-Conditions> and for electronic format documents, subject to Terms and Conditions for Electronic Documents at <http://www.sgs.com.tw/Terms-and-Conditions>. Attention is drawn to the limitation of liability, indemnification and jurisdiction issues defined therein. Any holder of this document is advised that information contained hereon reflects the Company's findings at the time of its intervention only and within the limits of Client's instructions, if any. The Company's sole responsibility is to its Client and this document does not exonerate parties to a transaction from exercising all their rights and obligations under the transaction documents. This document cannot be reproduced except in full, without prior written approval of the Company. Any unauthorized alteration, forgery or falsification of the content or appearance of this document is unlawful and offenders may be prosecuted to the fullest extent of the law.

SGS Taiwan Ltd. No.2, Keji 1st Rd., Guishan District, Taoyuan City, Taiwan / 桃園市龜山區科技一路2號

台灣檢驗科技股份有限公司

t (886-2) 2299-3279

f (886-3) 327-7559

www.sgs.com.tw

Member of SGS Group



Config_4_V

| | | |
|---------------------------------|-------------------------------|-----------------------|
| Site: SGS 966 Chamber A | Date: 2020/12/10 | Time: 下午 07:01:40 |
| Limit: FCC Class B 1G-18G(Peak) | Polarization: Vertical | Temperature: 21 °C |
| Mode: Config 4 | Power: AC 120V/60Hz | Humidity: 75 %RH |
| Report: MH-2020-B0179 | Distance: 3m | Air Pressure: 990 hpa |
| Tester: Boris Liao | | |
| Note: LTE B05 | | |

SGS Taiwan Ltd.-Electromagnetic Compatibility Laboratory Address: No.2, Keji 1st Rd., Guishan District, Taoyuan City, Taiwan 333

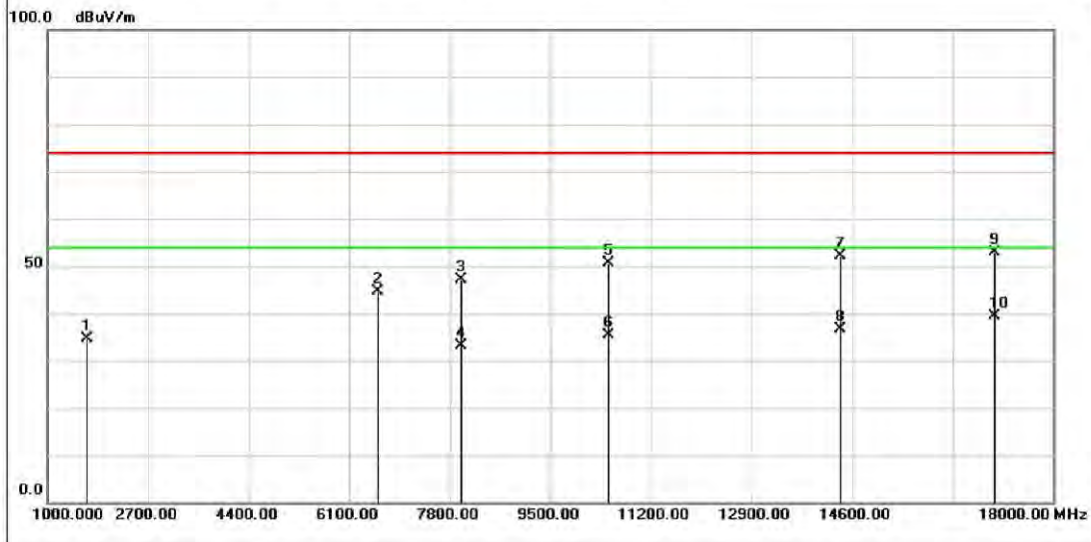

| No. | Mk | Freq. (MHz) | Reading (dBuV) | Factor (dB/m) | Measurement (dBuV/m) | Limit (dBuV/m) | Over (dB) | Height (cm) | Degree (deg.) | Detector | Comment |
|-----|----|----------------|-------------------|------------------|-------------------------|-------------------|--------------|----------------|------------------|----------|---------|
| 1 | | 1663.000 | 57.50 | -22.98 | 34.52 | 74.00 | -39.48 | | | peak | |
| 2 | | 6593.000 | 52.64 | -8.09 | 44.55 | 74.00 | -29.45 | | | peak | |
| 3 | | 7987.000 | 51.01 | -3.86 | 47.15 | 74.00 | -26.85 | | | peak | |
| 4 | | 7987.000 | 37.11 | -3.86 | 33.25 | 54.00 | -20.75 | | | AVG | |
| 5 | | 10486.000 | 50.66 | -0.10 | 50.56 | 74.00 | -23.44 | | | peak | |
| 6 | | 10486.000 | 35.57 | -0.10 | 35.47 | 54.00 | -18.53 | | | AVG | |
| 7 | | 14413.000 | 48.12 | 4.01 | 52.13 | 74.00 | -21.87 | | | peak | |
| 8 | | 14413.000 | 32.65 | 4.01 | 36.66 | 54.00 | -17.34 | | | AVG | |
| 9 | | 17014.000 | 47.57 | 5.32 | 52.89 | 74.00 | -21.11 | 100 | 263 | peak | |
| 10 | * | 17014.000 | 34.13 | 5.32 | 39.45 | 54.00 | -14.55 | 100 | 263 | AVG | |

*:Maximum data x:Over limit !:over margin

Unless otherwise stated the results shown in this test report refer only to the sample(s) tested and such sample(s) are retained for 90 days only.

除非另有說明，此報告結果僅對測試之樣品負責，同時此樣品僅保留90天。本報告未經本公司書面許可，不可部份複製。

This document is issued by the Company subject to its General Conditions of Service printed overleaf, available on request or accessible at <http://www.sgs.com.tw/Terms-and-Conditions> and for electronic format documents, subject to Terms and Conditions for Electronic Documents at <http://www.sgs.com.tw/Terms-and-Conditions>. Attention is drawn to the limitation of liability, indemnification and jurisdiction issues defined therein. Any holder of this document is advised that information contained hereon reflects the Company's findings at the time of its intervention only and within the limits of Client's instructions, if any. The Company's sole responsibility is to its Client and this document does not exonerate parties to a transaction from exercising all their rights and obligations under the transaction documents. This document cannot be reproduced except in full, without prior written approval of the Company. Any unauthorized alteration, forgery or falsification of the content or appearance of this document is unlawful and offenders may be prosecuted to the fullest extent of the law.

SGS Taiwan Ltd. No.2, Keji 1st Rd., Guishan District, Taoyuan City, Taiwan / 桃園市龜山區科技一路2號

台灣檢驗科技股份有限公司

t (886-2) 2299-3279

f (886-3) 327-7559

www.sgs.com.tw

Member of SGS Group



| | | |
|------------------------------------|-------------------------------|-----------------------|
| Site: SGS 966 Chamber A | Date: 2020/12/11 | Time: 上午 01:56:33 |
| Limit: FCC Class B 1m 18-40G(Peak) | Polarization: Vertical | Temperature: 21 °C |
| Mode: Config 4 | Power: AC 120V/60Hz | Humidity: 75 %RH |
| Report: MH-2020-B0179 | Distance: 1m | Air Pressure: 990 hpa |
| Tester: Boris Liao | | |
| Note: LTE B05 | | |

SGS Taiwan Ltd.-Electromagnetic Compatibility Laboratory Address: No.2, Keji 1st Rd., Guishan District, Taoyuan City, Taiwan 333

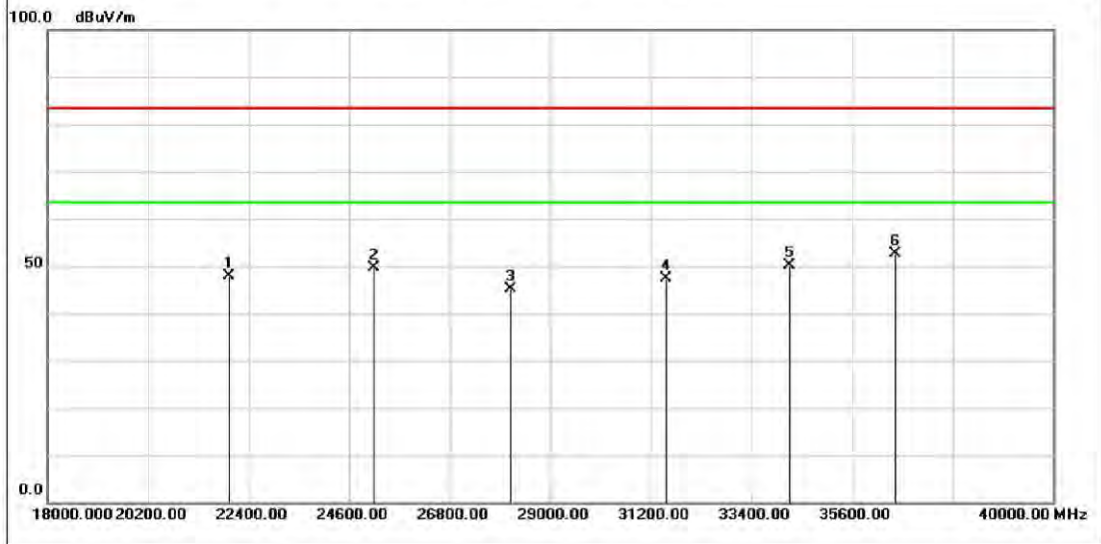

| No. | Mk | Freq. (MHz) | Reading (dBuV) | Factor (dB/m) | Measurement (dBuV/m) | Limit (dBuV/m) | Over (dB) | Height (cm) | Degree (deg.) | Detector | Comment |
|-----|----|----------------|-------------------|------------------|-------------------------|-------------------|--------------|----------------|------------------|----------|---------|
| 1 | | 21982.000 | 47.17 | 0.80 | 47.97 | 83.50 | -35.53 | | | peak | |
| 2 | | 25150.000 | 47.11 | 2.62 | 49.73 | 83.50 | -33.77 | | | peak | |
| 3 | | 28142.000 | 44.15 | 0.98 | 45.13 | 83.50 | -38.37 | | | peak | |
| 4 | | 31530.000 | 44.44 | 2.93 | 47.37 | 83.50 | -36.13 | | | peak | |
| 5 | | 34236.000 | 45.98 | 4.08 | 50.06 | 83.50 | -33.44 | | | peak | |
| 6 | * | 36546.000 | 44.18 | 8.48 | 52.66 | 83.50 | -30.84 | 100 | 325 | peak | |

*:Maximum data x:Over limit !:over margin

Unless otherwise stated the results shown in this test report refer only to the sample(s) tested and such sample(s) are retained for 90 days only.

除非另有說明，此報告結果僅對測試之樣品負責，同時此樣品僅保留90天。本報告未經本公司書面許可，不可部份複製。

This document is issued by the Company subject to its General Conditions of Service printed overleaf, available on request or accessible at <http://www.sgs.com.tw/Terms-and-Conditions> and for electronic format documents, subject to Terms and Conditions for Electronic Documents at <http://www.sgs.com.tw/Terms-and-Conditions>. Attention is drawn to the limitation of liability, indemnification and jurisdiction issues defined therein. Any holder of this document is advised that information contained hereon reflects the Company's findings at the time of its intervention only and within the limits of Client's instructions, if any. The Company's sole responsibility is to its Client and this document does not exonerate parties to a transaction from exercising all their rights and obligations under the transaction documents. This document cannot be reproduced except in full, without prior written approval of the Company. Any unauthorized alteration, forgery or falsification of the content or appearance of this document is unlawful and offenders may be prosecuted to the fullest extent of the law.

SGS Taiwan Ltd. No.2, Keji 1st Rd., Guishan District, Taoyuan City, Taiwan / 桃園市龜山區科技一路2號

台灣檢驗科技股份有限公司

t (886-2) 2299-3279

f (886-3) 327-7559

www.sgs.com.tw

Member of SGS Group



Config_5_H

| | | |
|---------------------------------|---------------------------------|-----------------------|
| Site: SGS 966 Chamber A | Date: 2020/12/10 | Time: 下午 09:43:19 |
| Limit: FCC Class B 1G-18G(Peak) | Polarization: Horizontal | Temperature: 21 °C |
| Mode: Config 5 | Power: AC 120V/60Hz | Humidity: 75 %RH |
| Report: MH-2020-B0179 | Distance: 3m | Air Pressure: 990 hpa |
| Tester: Boris Liao | | |
| Note: FM 98.1 | | |

SGS Taiwan Ltd.-Electromagnetic Compatibility Laboratory Address: No.2, Keji 1st Rd., Guishan District, Taoyuan City, Taiwan 333

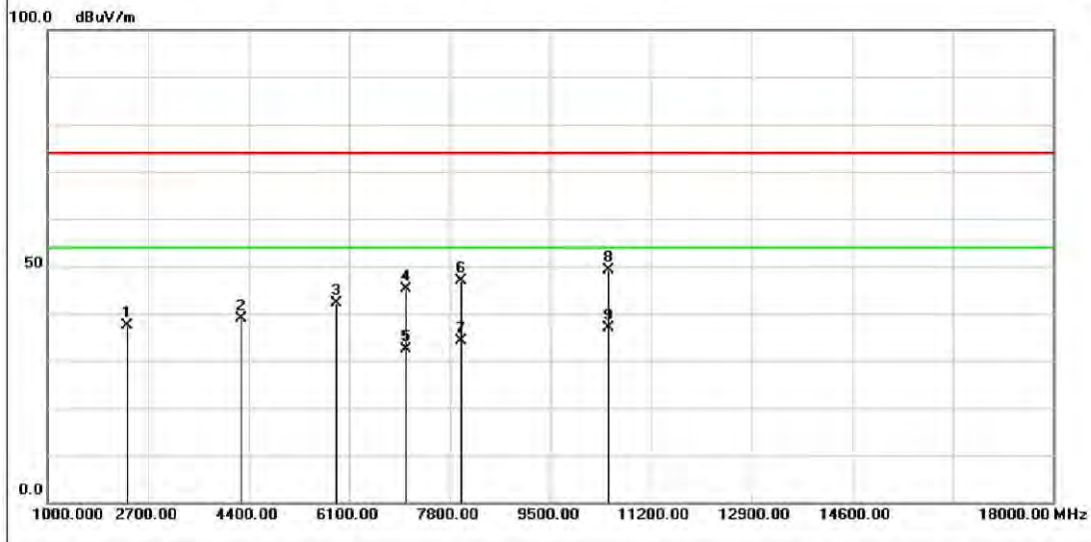

| No. | Mk | Freq. (MHz) | Reading (dBuV) | Factor (dB/m) | Measurement (dBuV/m) | Limit (dBuV/m) | Over (dB) | Height (cm) | Degree (deg.) | Detector | Comment |
|-----|----|----------------|-------------------|------------------|-------------------------|-------------------|--------------|----------------|------------------|----------|---------|
| 1 | | 2343.000 | 55.65 | -18.37 | 37.28 | 74.00 | -36.72 | | | peak | |
| 2 | | 4264.000 | 54.21 | -15.45 | 38.76 | 74.00 | -35.24 | | | peak | |
| 3 | | 5879.000 | 53.78 | -11.73 | 42.05 | 74.00 | -31.95 | | | peak | |
| 4 | | 7052.000 | 51.98 | -6.78 | 45.20 | 74.00 | -28.80 | | | peak | |
| 5 | | 7052.000 | 39.26 | -6.78 | 32.48 | 54.00 | -21.52 | | | AVG | |
| 6 | | 7987.000 | 50.67 | -3.86 | 46.81 | 74.00 | -27.19 | | | peak | |
| 7 | | 7987.000 | 37.91 | -3.86 | 34.05 | 54.00 | -19.95 | | | AVG | |
| 8 | | 10486.000 | 49.24 | -0.10 | 49.14 | 74.00 | -24.86 | 100 | 305 | peak | |
| 9 | * | 10486.000 | 36.87 | -0.10 | 36.77 | 54.00 | -17.23 | 100 | 305 | AVG | |

*:Maximum data x:Over limit !:over margin

Unless otherwise stated the results shown in this test report refer only to the sample(s) tested and such sample(s) are retained for 90 days only.

除非另有說明，此報告結果僅對測試之樣品負責，同時此樣品僅保留90天。本報告未經本公司書面許可，不可部份複製。

This document is issued by the Company subject to its General Conditions of Service printed overleaf, available on request or accessible at <http://www.sgs.com.tw/Terms-and-Conditions> and for electronic format documents, subject to Terms and Conditions for Electronic Documents at <http://www.sgs.com.tw/Terms-and-Conditions>. Attention is drawn to the limitation of liability, indemnification and jurisdiction issues defined therein. Any holder of this document is advised that information contained hereon reflects the Company's findings at the time of its intervention only and within the limits of Client's instructions, if any. The Company's sole responsibility is to its Client and this document does not exonerate parties to a transaction from exercising all their rights and obligations under the transaction documents. This document cannot be reproduced except in full, without prior written approval of the Company. Any unauthorized alteration, forgery or falsification of the content or appearance of this document is unlawful and offenders may be prosecuted to the fullest extent of the law.

SGS Taiwan Ltd. No.2, Keji 1st Rd., Guishan District, Taoyuan City, Taiwan / 桃園市龜山區科技一路2號

台灣檢驗科技股份有限公司

t (886-2) 2299-3279

f (886-3) 327-7559

www.sgs.com.tw

Member of SGS Group



| | | |
|------------------------------------|---------------------------------|-----------------------|
| Site: SGS 966 Chamber A | Date: 2020/12/11 | Time: 上午 02:30:02 |
| Limit: FCC Class B 1m 18-40G(Peak) | Polarization: Horizontal | Temperature: 21 °C |
| Mode: Config 5 | Power: AC 120V/60Hz | Humidity: 75 %RH |
| Report: MH-2020-B0179 | Distance: 1m | Air Pressure: 990 hpa |
| Tester: Boris Liao | | |
| Note: FM 98.1 | | |

SGS Taiwan Ltd.-Electromagnetic Compatibility Laboratory Address: No.2, Keji 1st Rd., Guishan District, Taoyuan City, Taiwan 333

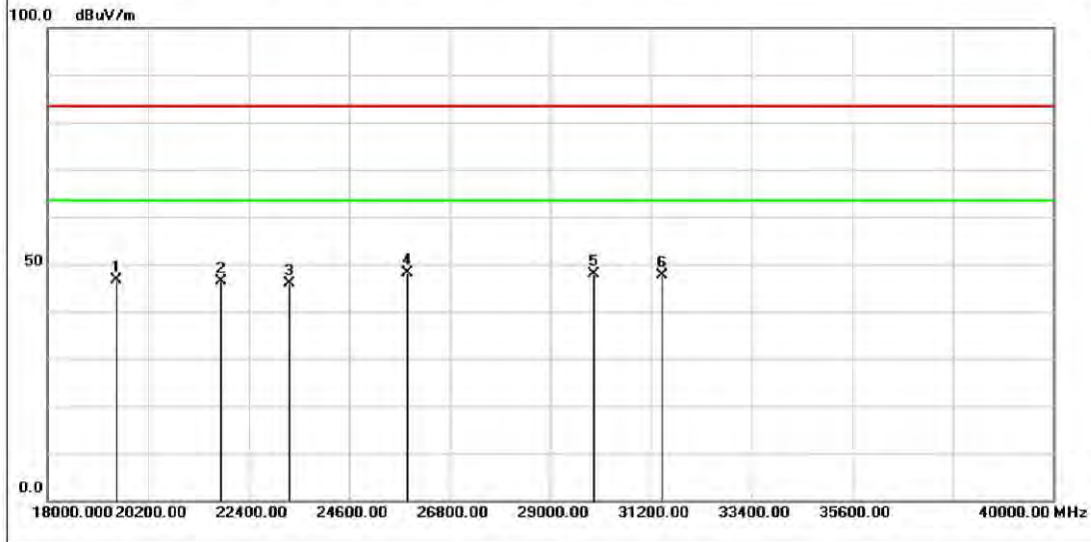

| No. | Mk | Freq. (MHz) | Reading (dBuV) | Factor (dB/m) | Measurement (dBuV/m) | Limit (dBuV/m) | Over (dB) | Height (cm) | Degree (deg.) | Detector | Comment |
|-----|----|----------------|-------------------|------------------|-------------------------|-------------------|--------------|----------------|------------------|----------|---------|
| 1 | | 19518.000 | 48.28 | -1.72 | 46.56 | 83.50 | -36.94 | | | peak | |
| 2 | | 21784.000 | 46.55 | -0.27 | 46.28 | 83.50 | -37.22 | | | peak | |
| 3 | | 23280.000 | 43.96 | 1.99 | 45.95 | 83.50 | -37.55 | | | peak | |
| 4 | * | 25876.000 | 45.85 | 2.24 | 48.09 | 83.50 | -35.41 | | | peak | |
| 5 | | 29946.000 | 46.26 | 1.59 | 47.85 | 83.50 | -35.65 | | | peak | |
| 6 | | 31442.000 | 44.78 | 2.90 | 47.68 | 83.50 | -35.82 | 100 | 300 | peak | |

*:Maximum data x:Over limit !:over margin

Unless otherwise stated the results shown in this test report refer only to the sample(s) tested and such sample(s) are retained for 90 days only.

除非另有說明，此報告結果僅對測試之樣品負責，同時此樣品僅保留90天。本報告未經本公司書面許可，不可部份複製。

This document is issued by the Company subject to its General Conditions of Service printed overleaf, available on request or accessible at <http://www.sgs.com.tw/Terms-and-Conditions> and for electronic format documents, subject to Terms and Conditions for Electronic Documents at <http://www.sgs.com.tw/Terms-and-Conditions>. Attention is drawn to the limitation of liability, indemnification and jurisdiction issues defined therein. Any holder of this document is advised that information contained hereon reflects the Company's findings at the time of its intervention only and within the limits of Client's instructions, if any. The Company's sole responsibility is to its Client and this document does not exonerate parties to a transaction from exercising all their rights and obligations under the transaction documents. This document cannot be reproduced except in full, without prior written approval of the Company. Any unauthorized alteration, forgery or falsification of the content or appearance of this document is unlawful and offenders may be prosecuted to the fullest extent of the law.

SGS Taiwan Ltd. No.2, Keji 1st Rd., Guishan District, Taoyuan City, Taiwan / 桃園市龜山區科技一路2號

台灣檢驗科技股份有限公司

t (886-2) 2299-3279

f (886-3) 327-7559

www.sgs.com.tw

Member of SGS Group



Config_5_V

| | | |
|---------------------------------|-------------------------------|-----------------------|
| Site: SGS 966 Chamber A | Date: 2020/12/10 | Time: 下午 09:33:30 |
| Limit: FCC Class B 1G-18G(Peak) | Polarization: Vertical | Temperature: 21 °C |
| Mode: Config 5 | Power: AC 120V/60Hz | Humidity: 75 %RH |
| Report: MH-2020-B0179 | Distance: 3m | Air Pressure: 990 hpa |
| Tester: Boris Liao | | |
| Note: FM 98.1 | | |

SGS Taiwan Ltd.-Electromagnetic Compatibility Laboratory Address: No.2, Keji 1st Rd., Guishan District, Taoyuan City, Taiwan 333

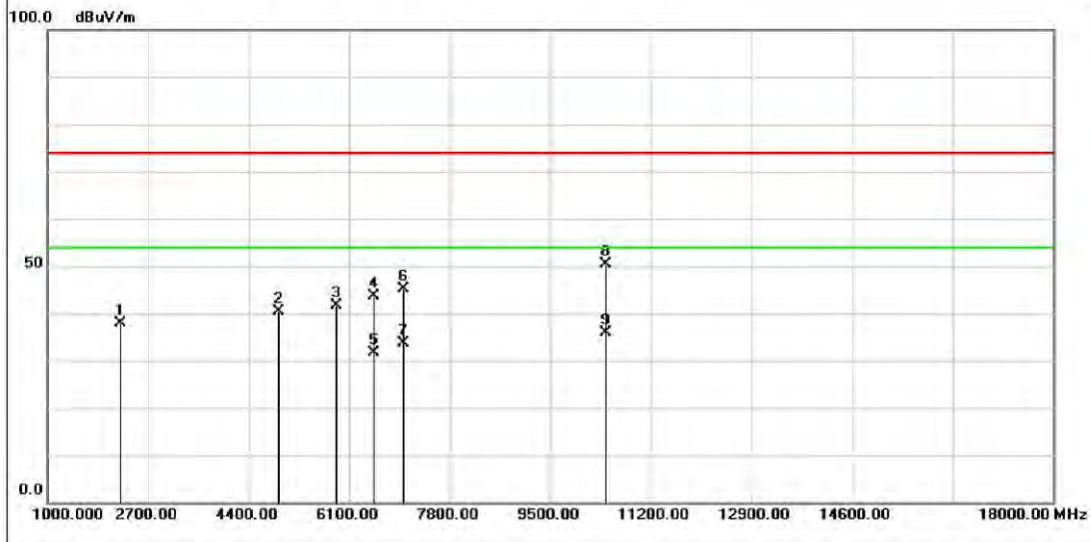

| No. | Mk | Freq. (MHz) | Reading (dBuV) | Factor (dB/m) | Measurement (dBuV/m) | Limit (dBuV/m) | Over (dB) | Height (cm) | Degree (deg.) | Detector | Comment |
|-----|----|----------------|-------------------|------------------|-------------------------|-------------------|--------------|----------------|------------------|----------|---------|
| 1 | | 2241.000 | 56.46 | -18.50 | 37.96 | 74.00 | -36.04 | | | peak | |
| 2 | | 4910.000 | 54.47 | -14.20 | 40.27 | 74.00 | -33.73 | | | peak | |
| 3 | | 5879.000 | 53.26 | -11.73 | 41.53 | 74.00 | -32.47 | | | peak | |
| 4 | | 6508.000 | 51.92 | -8.23 | 43.69 | 74.00 | -30.31 | | | peak | |
| 5 | | 6508.000 | 39.88 | -8.23 | 31.65 | 54.00 | -22.35 | | | AVG | |
| 6 | | 7018.000 | 51.99 | -6.96 | 45.03 | 74.00 | -28.97 | | | peak | |
| 7 | | 7018.000 | 40.61 | -6.96 | 33.65 | 54.00 | -20.35 | | | AVG | |
| 8 | | 10435.000 | 50.71 | -0.29 | 50.42 | 74.00 | -23.58 | 100 | 79 | peak | |
| 9 | * | 10435.000 | 36.10 | -0.29 | 35.81 | 54.00 | -18.19 | 100 | 79 | AVG | |

*:Maximum data x:Over limit !:over margin

Unless otherwise stated the results shown in this test report refer only to the sample(s) tested and such sample(s) are retained for 90 days only.

除非另有說明，此報告結果僅對測試之樣品負責，同時此樣品僅保留90天。本報告未經本公司書面許可，不可部份複製。

This document is issued by the Company subject to its General Conditions of Service printed overleaf, available on request or accessible at <http://www.sgs.com.tw/Terms-and-Conditions> and for electronic format documents, subject to Terms and Conditions for Electronic Documents at <http://www.sgs.com.tw/Terms-and-Conditions>. Attention is drawn to the limitation of liability, indemnification and jurisdiction issues defined therein. Any holder of this document is advised that information contained hereon reflects the Company's findings at the time of its intervention only and within the limits of Client's instructions, if any. The Company's sole responsibility is to its Client and this document does not exonerate parties to a transaction from exercising all their rights and obligations under the transaction documents. This document cannot be reproduced except in full, without prior written approval of the Company. Any unauthorized alteration, forgery or falsification of the content or appearance of this document is unlawful and offenders may be prosecuted to the fullest extent of the law.

SGS Taiwan Ltd. No.2, Keji 1st Rd., Guishan District, Taoyuan City, Taiwan / 桃園市龜山區科技一路2號

台灣檢驗科技股份有限公司

t (886-2) 2299-3279

f (886-3) 327-7559

www.sgs.com.tw

Member of SGS Group



| | | |
|------------------------------------|-------------------------------|-----------------------|
| Site: SGS 966 Chamber A | Date: 2020/12/11 | Time: 上午 02:17:40 |
| Limit: FCC Class B 1m 18-40G(Peak) | Polarization: Vertical | Temperature: 21 °C |
| Mode: Config 5 | Power: AC 120V/60Hz | Humidity: 75 %RH |
| Report: MH-2020-B0179 | Distance: 1m | Air Pressure: 990 hpa |
| Tester: Boris Liao | | |
| Note: FM 98.1 | | |

SGS Taiwan Ltd.-Electromagnetic Compatibility Laboratory Address: No.2, Keji 1st Rd., Guishan District, Taoyuan City, Taiwan 333

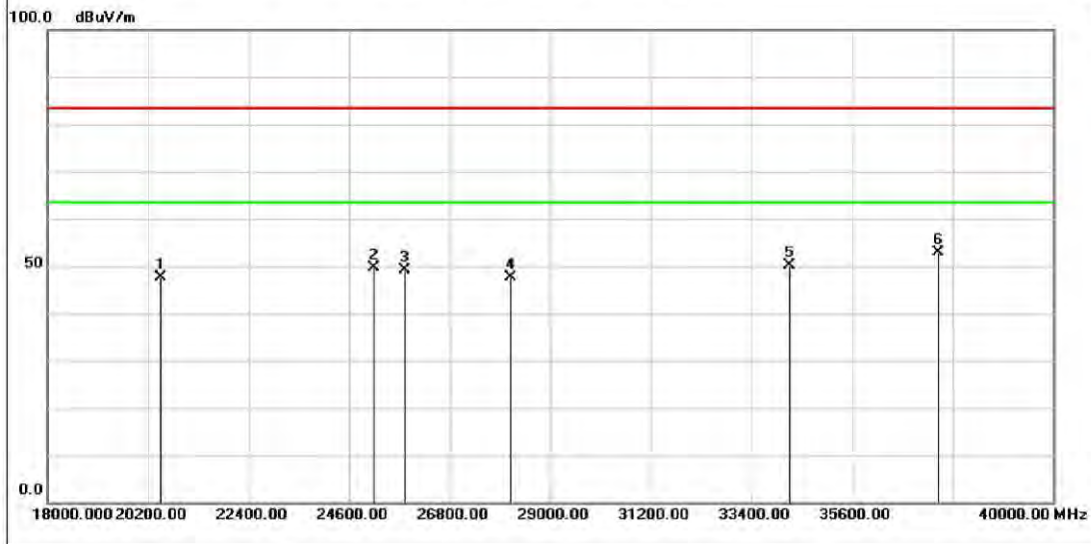

| No. | Mk | Freq. (MHz) | Reading (dBuV) | Factor (dB/m) | Measurement (dBuV/m) | Limit (dBuV/m) | Over (dB) | Height (cm) | Degree (deg.) | Detector | Comment |
|-----|----|----------------|-------------------|------------------|-------------------------|-------------------|--------------|----------------|------------------|----------|---------|
| 1 | | 20486.000 | 49.37 | -1.81 | 47.56 | 83.50 | -35.94 | | | peak | |
| 2 | | 25150.000 | 47.11 | 2.62 | 49.73 | 83.50 | -33.77 | | | peak | |
| 3 | | 25810.000 | 46.57 | 2.49 | 49.06 | 83.50 | -34.44 | | | peak | |
| 4 | | 28142.000 | 46.65 | 0.98 | 47.63 | 83.50 | -35.87 | | | peak | |
| 5 | | 34236.000 | 45.98 | 4.08 | 50.06 | 83.50 | -33.44 | | | peak | |
| 6 | * | 37492.000 | 44.62 | 8.30 | 52.92 | 83.50 | -30.58 | 103 | 30 | peak | |

*:Maximum data x:Over limit !:over margin

Unless otherwise stated the results shown in this test report refer only to the sample(s) tested and such sample(s) are retained for 90 days only.
 除非另有說明，此報告結果僅對測試之樣品負責，同時此樣品僅保留90天。本報告未經本公司書面許可，不可部份複製。

This document is issued by the Company subject to its General Conditions of Service printed overleaf, available on request or accessible at <http://www.sgs.com.tw/Terms-and-Conditions> and for electronic format documents, subject to Terms and Conditions for Electronic Documents at <http://www.sgs.com.tw/Terms-and-Conditions>. Attention is drawn to the limitation of liability, indemnification and jurisdiction issues defined therein. Any holder of this document is advised that information contained hereon reflects the Company's findings at the time of its intervention only and within the limits of Client's instructions, if any. The Company's sole responsibility is to its Client and this document does not exonerate parties to a transaction from exercising all their rights and obligations under the transaction documents. This document cannot be reproduced except in full, without prior written approval of the Company. Any unauthorized alteration, forgery or falsification of the content or appearance of this document is unlawful and offenders may be prosecuted to the fullest extent of the law.

SGS Taiwan Ltd. No.2, Keji 1st Rd., Guishan District, Taoyuan City, Taiwan / 桃園市龜山區科技一路2號

台灣檢驗科技股份有限公司

t (886-2) 2299-3279

f (886-3) 327-7559

www.sgs.com.tw

Member of SGS Group