



FCC RF Test Report

APPLICANT : SHARP CORPORATION, Mobile
 Communication B.U.
EQUIPMENT : Smart Phone
BRAND NAME : SHARP
FCC ID : APYHRO00289
STANDARD : FCC Part 15 Subpart C §15.247
CLASSIFICATION : (DTS) Digital Transmission System

The product was received on Aug. 01, 2020 and testing was completed on Sep. 07, 2020. We, Sporton International (ShenZhen) Inc., would like to declare that the tested sample has been evaluated in accordance with the test procedures and has been in compliance with the applicable technical standards.

This report contains data that were produced under subcontract by Sporton International (KunShan) Inc.

The test results in this report apply exclusively to the tested model / sample. Without written approval of Sporton International (ShenZhen) Inc., the test report shall not be reproduced except in full.

Derreck Chen

Reviewed by: Derreck Chen / Supervisor

Eric Shih

Approved by: Eric Shih / Manager



Sporton International (ShenZhen) Inc.

1/F, 2/F, Bldg 5, Shiling Industrial Zone, Xinwei Village, Xili, Nanshan, Shenzhen, 518055

People's Republic of China



TABLE OF CONTENTS

REVISION HISTORY..... 3

SUMMARY OF TEST RESULT 4

1 GENERAL DESCRIPTION..... 5

 1.1 Applicant 5

 1.2 Manufacturer 5

 1.3 Product Feature of Equipment Under Test..... 5

 1.4 Product Specification of Equipment Under Test..... 5

 1.5 Modification of EUT 6

 1.6 Testing Location 6

 1.7 Test Software 6

 1.8 Applicable Standards..... 7

2 TEST CONFIGURATION OF EQUIPMENT UNDER TEST..... 8

 2.1 Carrier Frequency Channel 8

 2.2 Test Mode 9

 2.3 Connection Diagram of Test System 10

 2.4 Support Unit used in test configuration and system 11

 2.5 EUT Operation Test Setup 11

 2.6 Measurement Results Explanation Example..... 11

3 TEST RESULT 12

 3.1 6dB Bandwidth Measurement 12

 3.2 Output Power Measurement..... 16

 3.3 Power Spectral Density Measurement 17

 3.4 Conducted Band Edges and Spurious Emission Measurement 24

 3.5 Radiated Band Edges and Spurious Emission Measurement 33

 3.6 AC Conducted Emission Measurement..... 37

 3.7 Antenna Requirements 39

4 LIST OF MEASURING EQUIPMENT 40

5 UNCERTAINTY OF EVALUATION..... 41

APPENDIX A. CONDUCTED TEST RESULTS

APPENDIX B. AC CONDUCTED EMISSION TEST RESULT

APPENDIX C. RADIATED SPURIOUS EMISSION

APPENDIX D. DUTY CYCLE PLOTS

APPENDIX E. SETUP PHOTOGRAPHS



REVISION HISTORY

REPORT NO.	VERSION	DESCRIPTION	ISSUED DATE
FR080102B	Rev. 01	Initial issue of report	Sep. 23, 2020



SUMMARY OF TEST RESULT

Report Section	FCC Rule	Description	Limit	Result	Remark
3.1	15.247(a)(2)	6dB Bandwidth	≥ 0.5MHz	Pass	-
3.2	15.247(b)(3)	Peak Output Power	≤ 30dBm	Pass	-
3.3	15.247(e)	Power Spectral Density	≤ 8dBm/3kHz	Pass	-
3.4	15.247(d)	Conducted Band Edges and Spurious Emission	≤ 20dBc	Pass	-
3.5	15.247(d)	Radiated Band Edges and Spurious Emission	15.209(a) & 15.247(d)	Pass	Under limit 9.62 dB at 2498.440 MHz
3.6	15.207	AC Conducted Emission	15.207(a)	Pass	Under limit 18.73 dB at 0.500 MHz
3.7	15.203 & 15.247(b)	Antenna Requirement	N/A	Pass	-

Declaration of Conformity:

The test results with all measurement uncertainty excluded are presented in accordance with the regulation limits or requirements declared by manufacturers.

Comments and Explanations:

The declared of product specification for EUT presented in the report are provided by the manufacturer, and the manufacturer takes all the responsibilities for the accuracy of product specification.



1 General Description

1.1 Applicant

SHARP CORPORATION, Mobile Communication B.U.

2-13-1, Hachihonmatsu-lida, Higashi-hiroshima-shi, Hiroshima 739-0192, Japan

1.2 Manufacturer

SHARP CORPORATION

1 Takumi-cho, Sakai-ku, Sakai-shi, Osaka 590-8522, Japan

1.3 Product Feature of Equipment Under Test

Product Feature	
Equipment	Smart Phone
Brand Name	SHARP
FCC ID	APYHRO00289
EUT supports Radios application	GSM/WCDMA/LTE/NFC WLAN 2.4GHz 802.11b/g/n HT20 WLAN 5GHz 802.11a/n HT20/HT40 WLAN 5GHz 802.11ac VHT20/VHT40/VHT80 Bluetooth BR/EDR/LE FM Receiver and GNSS
IMEI Code	Conducted: 004401117394938/004401117409934 Conduction: 004401117394011 Radiation: 004401117408175/004401117393179
HW Version	DVT
SW Version	A729S
EUT Stage	Identical Prototype

Remark: The above EUT's information was declared by manufacturer. Please refer to the specifications or user's manual for more detailed description.

1.4 Product Specification of Equipment Under Test

Standards-related Product Specification	
Tx/Rx Frequency Range	2402 MHz ~ 2480 MHz
Number of Channels	40
Carrier Frequency of Each Channel	40 Channel(37 hopping + 3 advertising channel)
Maximum Output Power to Antenna	Bluetooth v4.2 LE : 7.41 dBm (0.0055 W) Bluetooth v5.0 LE : 7.49 dBm (0.0056 W)
Antenna Type / Gain	IFA Antenna with gain -2.40 dBi
Type of Modulation	Bluetooth LE : GFSK



1.5 Modification of EUT

No modifications are made to the EUT during all test items.

1.6 Testing Location

Sporton International (Kunshan) Inc. is accredited to ISO/IEC 17025:2017 by American Association for Laboratory Accreditation with Certificate Number 5145.02.

Test Firm	Sporton International (Kunshan) Inc.		
Test Site Location	No. 1098, Pengxi North Road, Kunshan Economic Development Zone Jiangsu Province 215300 People's Republic of China TEL : +86-512-57900158 FAX : +86-512-57900958		
Test Site No.	Sporton Site No.	FCC Designation No.	FCC Test Firm Registration No.
	03CH06-KS	CN1257	314309

Sporton International (Shenzhen) Inc. is accredited to ISO/IEC 17025:2017 by American Association for Laboratory Accreditation with Certificate Number 5145.01.

Test Firm	Sporton International (Shenzhen) Inc.		
Test Site Location	1/F, 2/F, Bldg 5, Shiling Industrial Zone, Xinwei Village, Xili, Nanshan, Shenzhen, 518055 People's Republic of China TEL: +86-755-86379589 FAX: +86-755-86379595		
Test Site No.	Sporton Site No.	FCC Designation No.	FCC Test Firm Registration No.
	CO01-SZ TH01-SZ	CN1256	421272

1.7 Test Software

Item	Site	Manufacture	Name	Version
1.	03CH06-KS	AUDIX	E3	6.2009-8-24al
2.	CO01-SZ	AUDIX	E3	6.120613b



1.8 Applicable Standards

According to the specifications of the manufacturer, the EUT must comply with the requirements of the following standards:

- ♦ 47 CFR Part 15 Subpart C §15.247
- ♦ FCC KDB 558074 D01 15.247 Meas Guidance v05r02
- ♦ ANSI C63.10-2013

Remark:

1. All test items were verified and recorded according to the standards and without any deviation during the test.
2. This EUT has also been tested and complied with the requirements of FCC Part 15, Subpart B, recorded in a separate test report.



2 Test Configuration of Equipment Under Test

2.1 Carrier Frequency Channel

Frequency Band	Channel	Freq. (MHz)	Channel	Freq. (MHz)
2400-2483.5 MHz	0	2402	21	2444
	1	2404	22	2446
	2	2406	23	2448
	3	2408	24	2450
	4	2410	25	2452
	5	2412	26	2454
	6	2414	27	2456
	7	2416	28	2458
	8	2418	29	2460
	9	2420	30	2462
	10	2422	31	2464
	11	2424	32	2466
	12	2426	33	2468
	13	2428	34	2470
	14	2430	35	2472
	15	2432	36	2474
	16	2434	37	2476
	17	2436	38	2478
	18	2438	39	2480
	19	2440	-	-
20	2442	-	-	



2.2 Test Mode

- a. The EUT has been associated with peripherals and configuration operated in a manner tended to maximize its emission characteristics in a typical application. Frequency range investigated: conduction emission (150 kHz to 30 MHz), radiation emission (9 kHz to the 10th harmonic of the highest fundamental frequency or to 40 GHz, whichever is lower). For radiated measurement, pre-scanned in three orthogonal panels, X, Y, Z. The worst cases (Y plane) were recorded in this report.
- b. AC power line Conducted Emission was tested under maximum output power.

The following summary table is showing all test modes to demonstrate in compliance with the standard.

Summary table of Test Cases	
Test Item	Data Rate / Modulation
	Bluetooth – LE / GFSK
Conducted TCs	Mode 1: Bluetooth Tx CH00_2402 MHz Mode 2: Bluetooth Tx CH19_2440 MHz Mode 3: Bluetooth Tx CH39_2480 MHz
Radiated TCs	Mode 1: Bluetooth Tx CH00_2402 MHz Mode 2: Bluetooth Tx CH19_2440 MHz Mode 3: Bluetooth Tx CH39_2480 MHz
AC Conducted Emission	Mode 1: GSM 850 Idle + Bluetooth Link + WLAN(2.4G) Link + USB Cable (Charging from Adapter) + Battery
Remark: For Radiated Test Cases, The tests were performed with Adapter , Earphone and USB Cable	

2.3 Connection Diagram of Test System

For Radiation

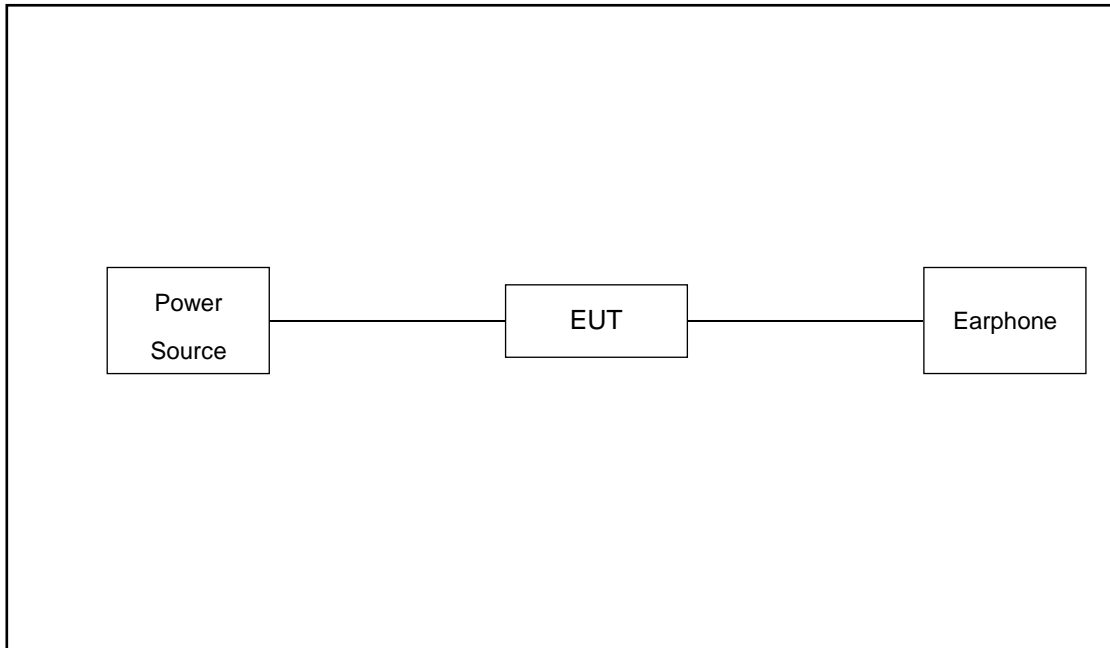

For Conducted Emission

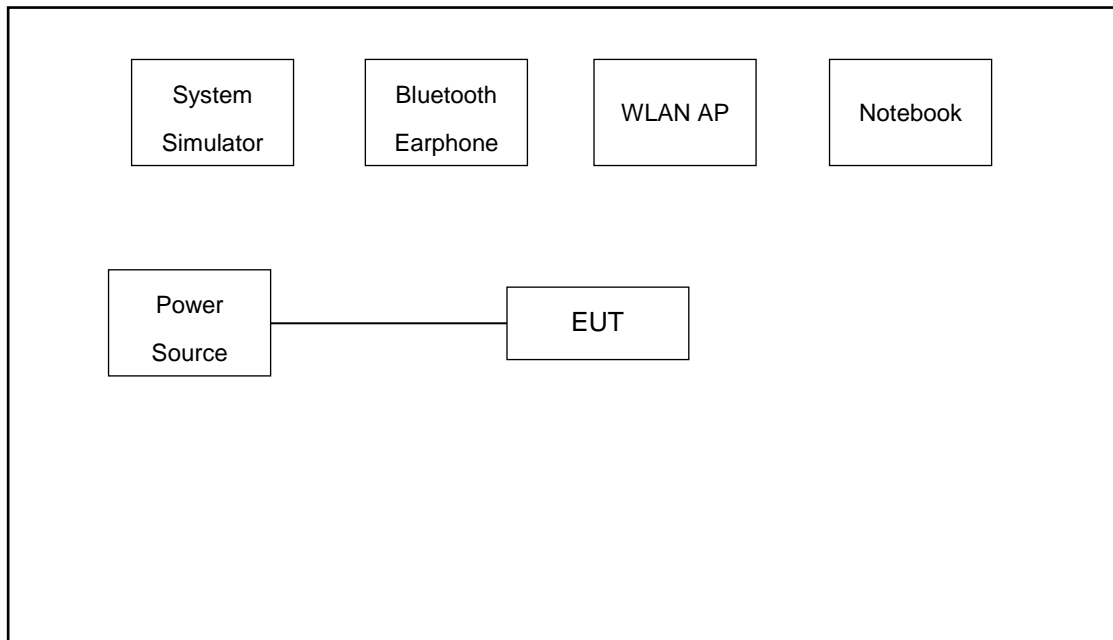



2.4 Support Unit used in test configuration and system

Item	Equipment	Trade Name	Model Name	FCC ID	Data Cable	Power Cord
1.	Base Station	Anritsu	MT8820C	N/A	N/A	Unshielded,1.8m
2.	WLAN AP	D-Link	DIR-820L	KA2IR820LA1	N/A	Unshielded,1.8m
3.	Bluetooth Earphone	Samsung	EO-MG900	N/A	N/A	N/A

2.5 EUT Operation Test Setup

For BLE function, the engineering test program was provided and enabled to make EUT continuous transmit/receive.

For AC power line conducted emissions, the EUT was set to connect with the WLAN AP under large package sizes transmission.

2.6 Measurement Results Explanation Example

For all conducted test items:

The offset level is set in the spectrum analyzer to compensate the RF cable loss and attenuator factor between EUT conducted output port and spectrum analyzer. With the offset compensation, the spectrum analyzer reading level is exactly the EUT RF output level.

Example:

The spectrum analyzer offset is derived from RF cable loss and attenuator factor.

Offset = RF cable loss + attenuator factor.

Following shows an offset computation example with cable loss 3.3dB and attenuator factor 20 dB.

$$\begin{aligned} \text{Offset(dB)} &= \text{RF cable loss(dB)} + \text{attenuator factor(dB)}. \\ &= 3.3(\text{dB}) + 20 (\text{dB}) \\ &=23.3(\text{dB}) \end{aligned}$$

3 Test Result

3.1 6dB Bandwidth Measurement

3.1.1 Limit of 6dB Bandwidth

The minimum 6 dB bandwidth shall be at least 500 kHz.

3.1.2 Measuring Instruments

The section 4.0 of List of Measuring Equipment of this test report is used for test.

3.1.3 Test Procedures

1. The testing follows ANSI C63.10-2013 clause 11.8
2. The RF output of EUT was connected to the spectrum analyzer by RF cable and attenuator. The path loss was compensated to the results for each measurement.
3. Set to the maximum power setting and enable the EUT transmit continuously.
4. Make the measurement with the spectrum analyzer's resolution bandwidth (RBW) = 100 kHz. Set the Video bandwidth (VBW) = 300 kHz. In order to make an accurate measurement. The 6 dB bandwidth must be greater than 500 kHz.
5. For 99% Bandwidth Measurement, the spectrum analyzer's resolution bandwidth (RBW) is set 30kHz and set the Video bandwidth (VBW) = 100kHz.
6. Measure and record the results in the test report.

3.1.4 Test Setup





3.1.5 Test Result of 6dB Bandwidth

Please refer to Appendix A.

Bluetooth v4.2 LE

6 dB Bandwidth Plot on Channel 00

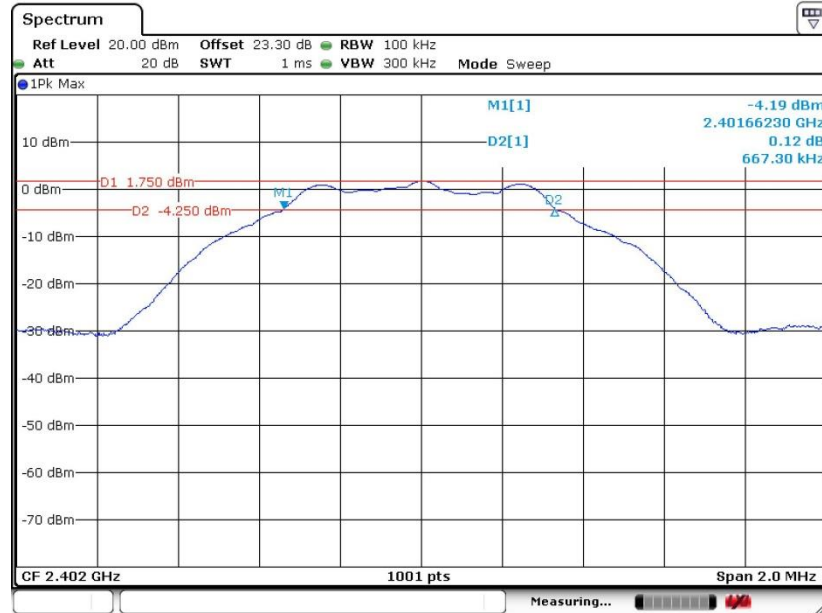

Date: 29.AUG.2020 02:07:41

6 dB Bandwidth Plot on Channel 19

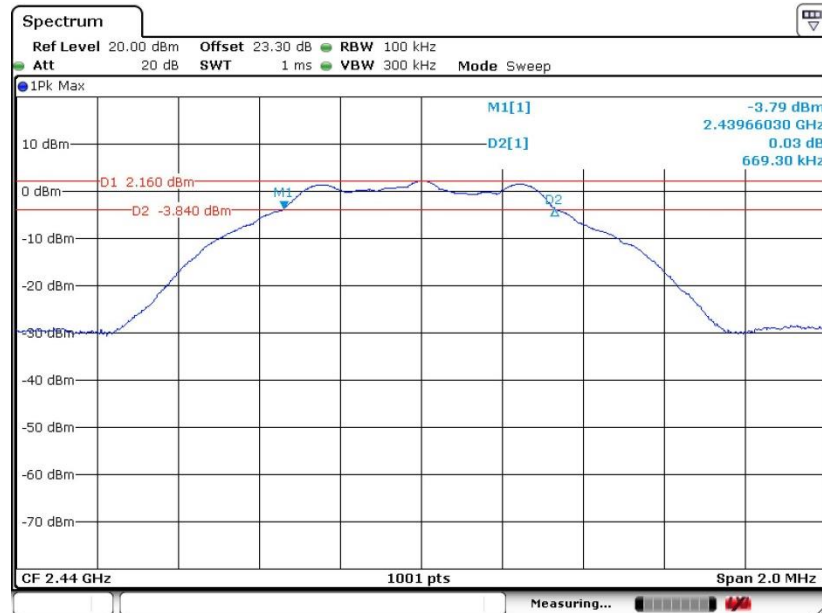

Date: 29.AUG.2020 02:18:10



6 dB Bandwidth Plot on Channel 39

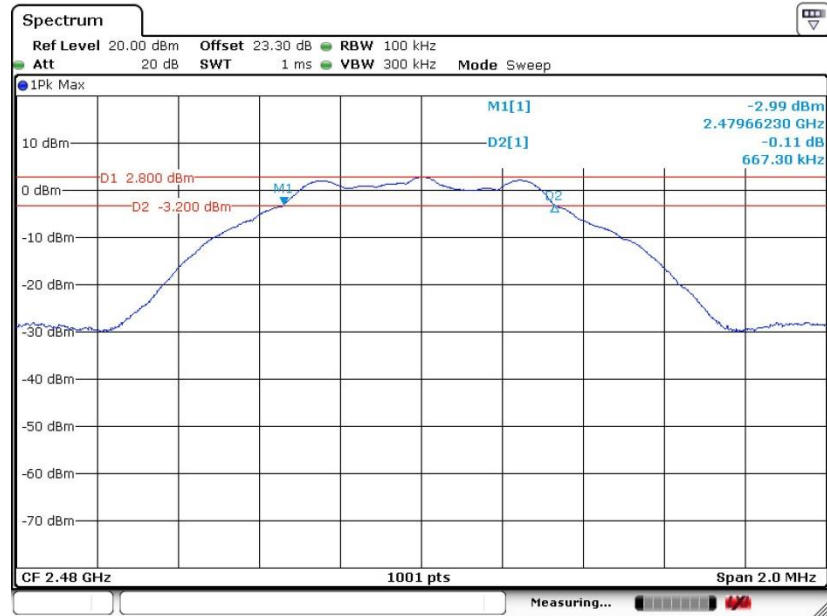

Bluetooth v5.0 LE

6 dB Bandwidth Plot on Channel 00

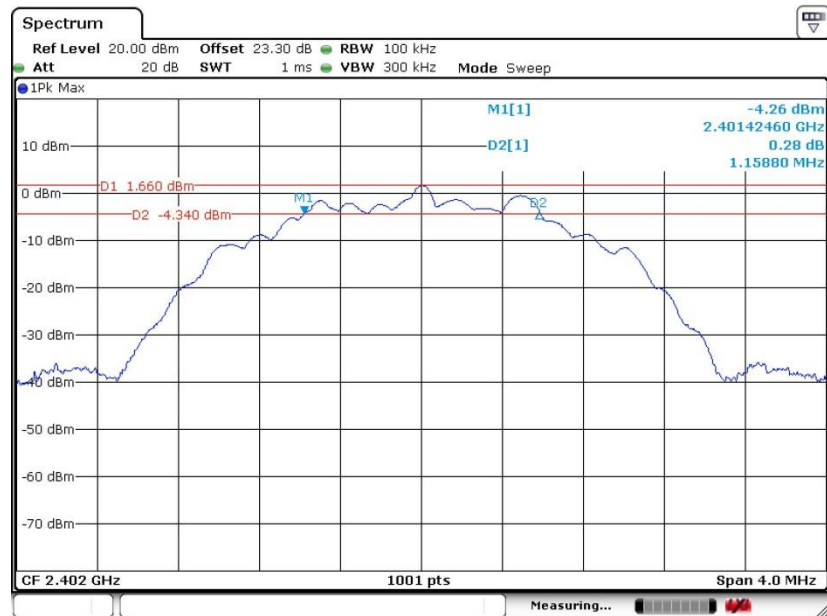



6 dB Bandwidth Plot on Channel 19

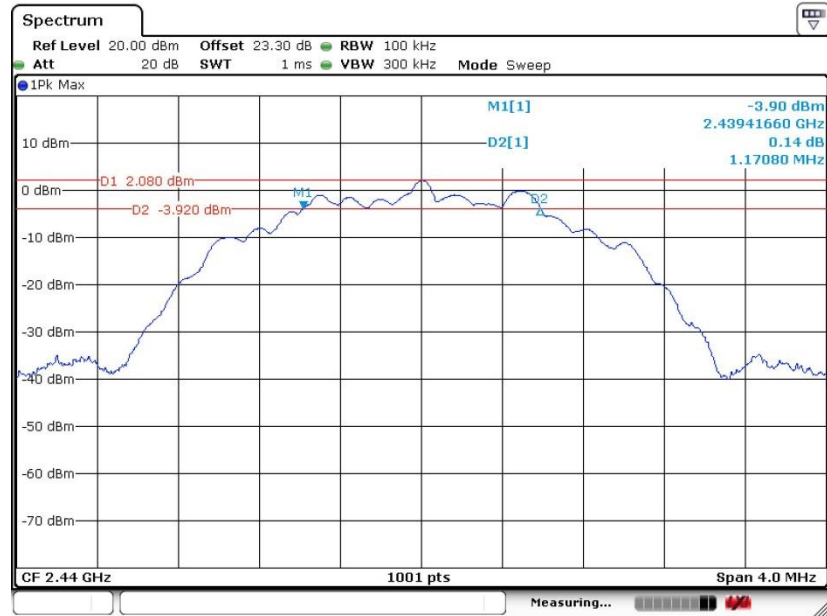

Date: 29.AUG.2020 02:55:13

6 dB Bandwidth Plot on Channel 39

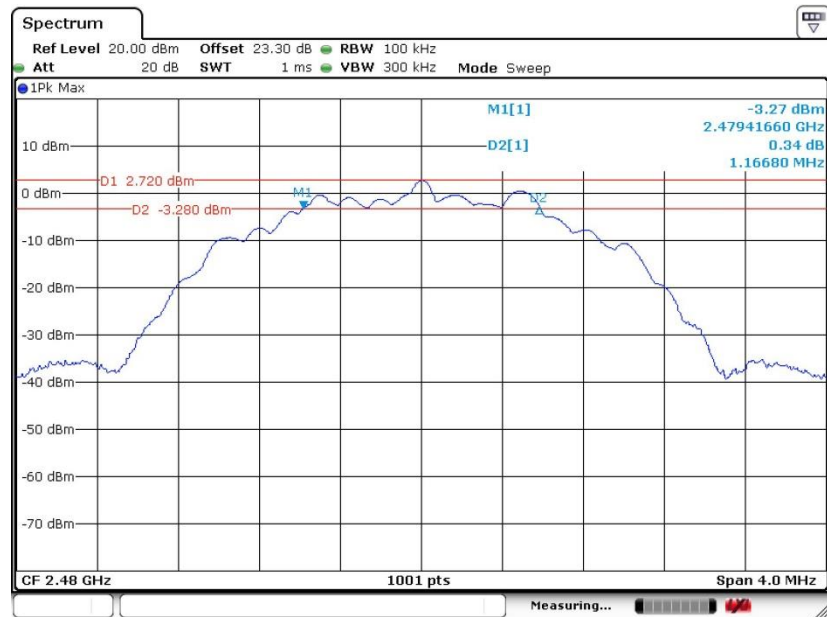

Date: 29.AUG.2020 03:12:50

3.2 Output Power Measurement

3.2.1 Limit of Output Power

For systems using digital modulation in the 2400-2483.5MHz, the limit for peak output power is 30dBm. If transmitting antenna of directional gain greater than 6dBi is used, the peak output power from the intentional radiator shall be reduced below the above stated value by the amount in dB that the directional gain of the antenna exceeds 6 dBi. In case of point-to-point operation, the limit has to be reduced by 1dB for every 3dB that the directional gain of the antenna exceeds 6dBi.

3.2.2 Measuring Instruments

The section 4.0 of List of Measuring Equipment of this test report is used for test.

3.2.3 Test Procedures

1. The testing follows the Measurement Procedure of ANSI C63.10-2013 clause 11.9.1.3 PKPM1 Peak power meter or ANSI C63.10-2013 clause 11.9.2.3.2 Method AVGPM-G method.
2. The RF output of EUT was connected to the power meter by RF cable and attenuator. The path loss was compensated to the results for each measurement.
3. Set to the maximum power setting and enable the EUT transmit continuously.
4. Measure the conducted output power and record the results in the test report.

3.2.4 Test Setup

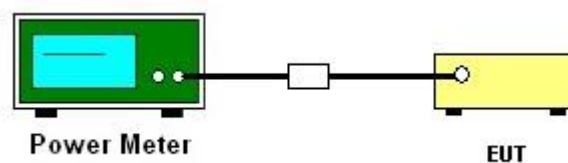

3.2.5 Test Result of Peak Output Power

Please refer to Appendix A.

3.3 Power Spectral Density Measurement

3.3.1 Limit of Power Spectral Density

The peak power spectral density shall not be greater than 8dBm in any 3kHz band at any time interval of continuous transmission.

3.3.2 Measuring Instruments

The section 4.0 of List of Measuring Equipment of this test report is used for test.

3.3.3 Test Procedures

1. The testing follows Measurement Procedure of ANSI C63.10-2013 clause 11.10.2 Method PKPSD.
2. The RF output of EUT was connected to the spectrum analyzer by RF cable and attenuator. The path loss was compensated to the results for each measurement.
3. Set to the maximum power setting and enable the EUT transmit continuously.
4. Make the measurement with the spectrum analyzer's resolution bandwidth (RBW) = 3 kHz. Video bandwidth VBW = 10 kHz In order to make an accurate measurement, set the span to 1.5 times DTS Channel Bandwidth. (6dB BW)
5. Detector = peak, Sweep time = auto couple, Trace mode = max hold, Allow trace to fully stabilize. Use the peak marker function to determine the maximum power level.
6. Measure and record the results in the test report.
7. The Measured power density (dBm)/ 100kHz is a reference level and used as 20dBc down limit line for Conducted Band Edges and Conducted Spurious Emission.

3.3.4 Test Setup

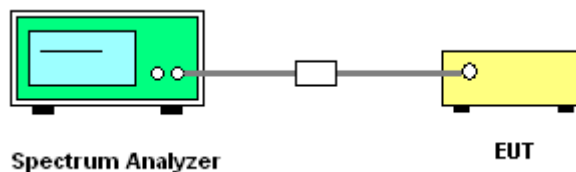

3.3.5 Test Result of Power Spectral Density

Please refer to Appendix A.



3.3.6 Test Result of Power Spectral Density Plots (100kHz)

Bluetooth v4.2 LE

PSD 100kHz Plot on Channel 00

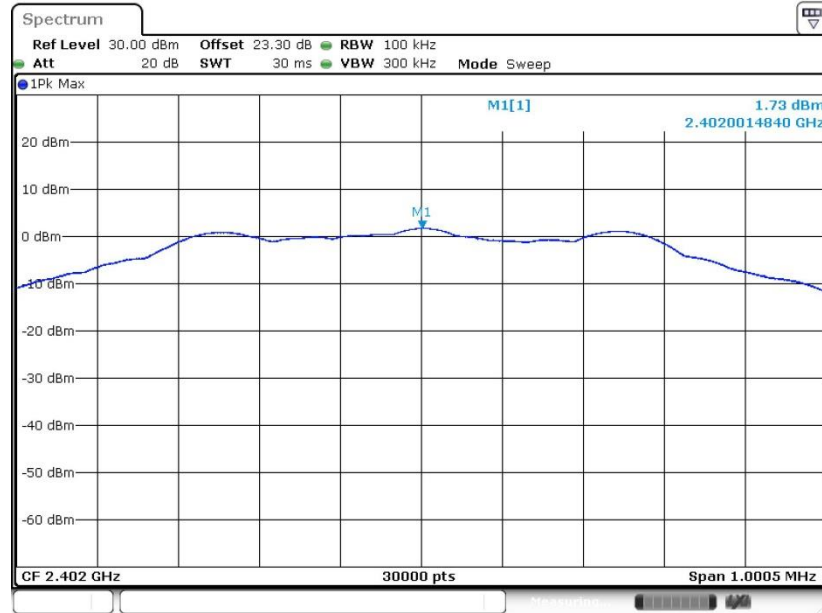

Date: 29.AUG.2020 02:10:32

PSD 100kHz Plot on Channel 19

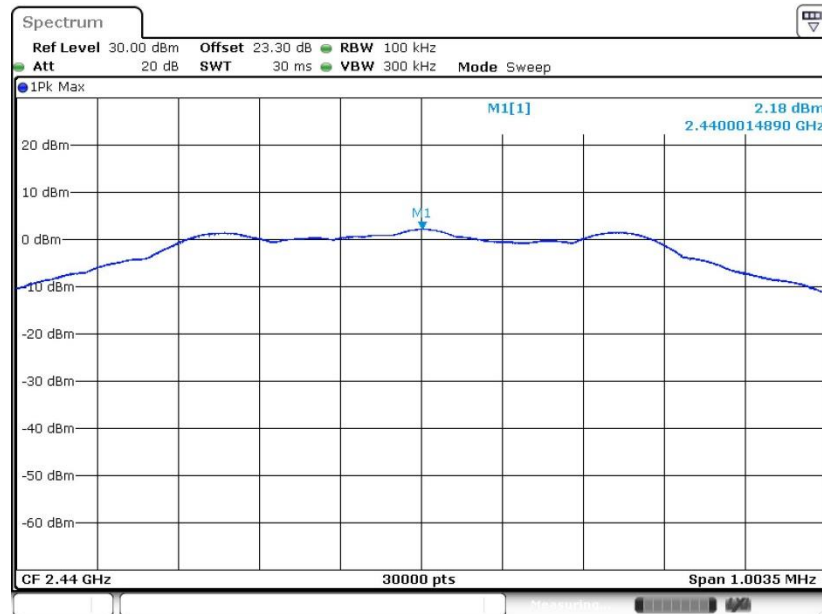

Date: 29.AUG.2020 02:20:06



PSD 100kHz Plot on Channel 39

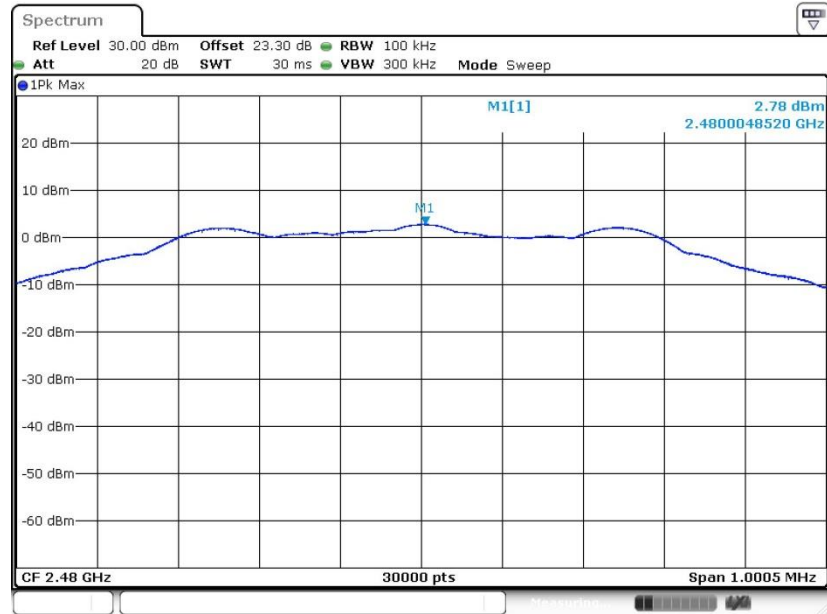

Date: 29.AUG.2020 02:27:05

Bluetooth v5.0 LE

PSD 100kHz Plot on Channel 00

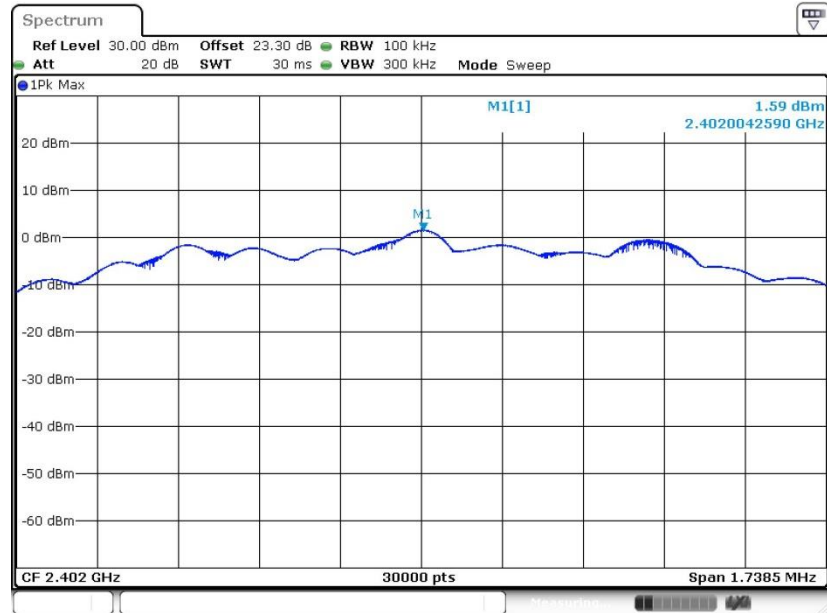

Date: 29.AUG.2020 02:44:46



PSD 100kHz Plot on Channel 19

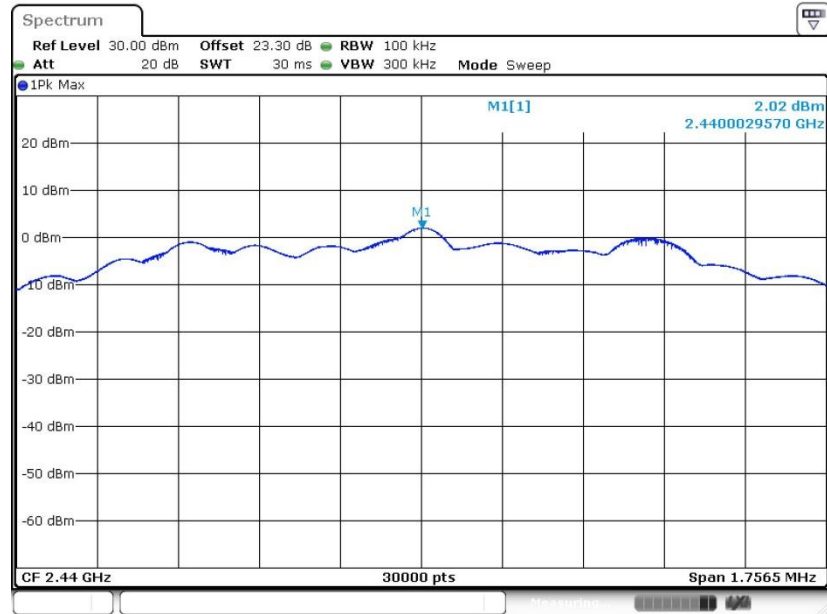

Date: 29.AUG.2020 02:58:12

PSD 100kHz Plot on Channel 39

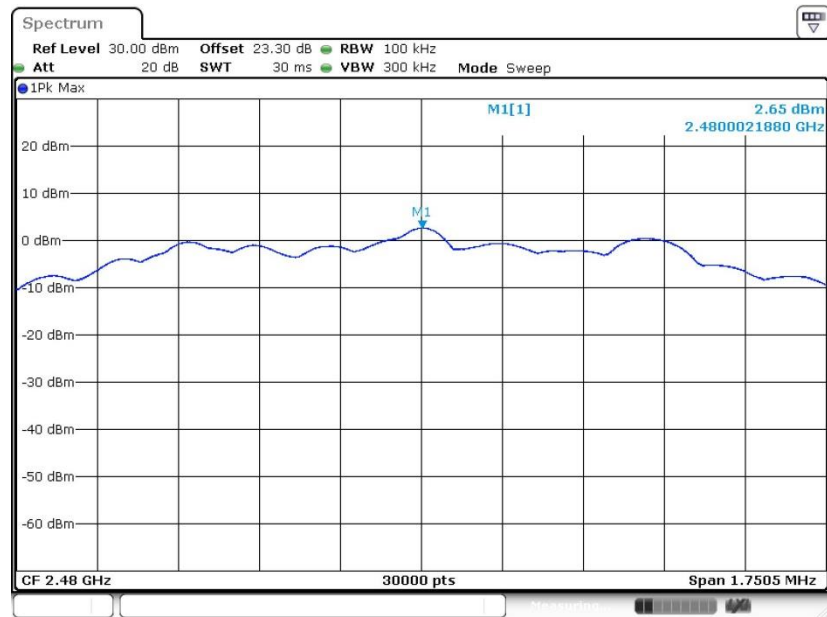

Date: 29.AUG.2020 03:20:37



3.3.7 Test Result of Power Spectral Density Plots (3kHz)

Bluetooth v4.2 LE

PSD 3kHz Plot on Channel 00

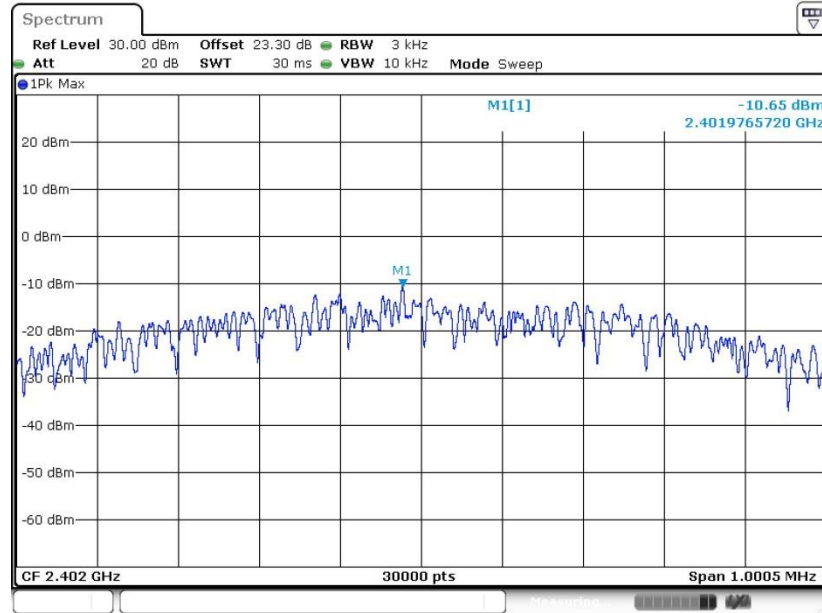

Date: 29.AUG.2020 02:09:01

PSD 3kHz Plot on Channel 19

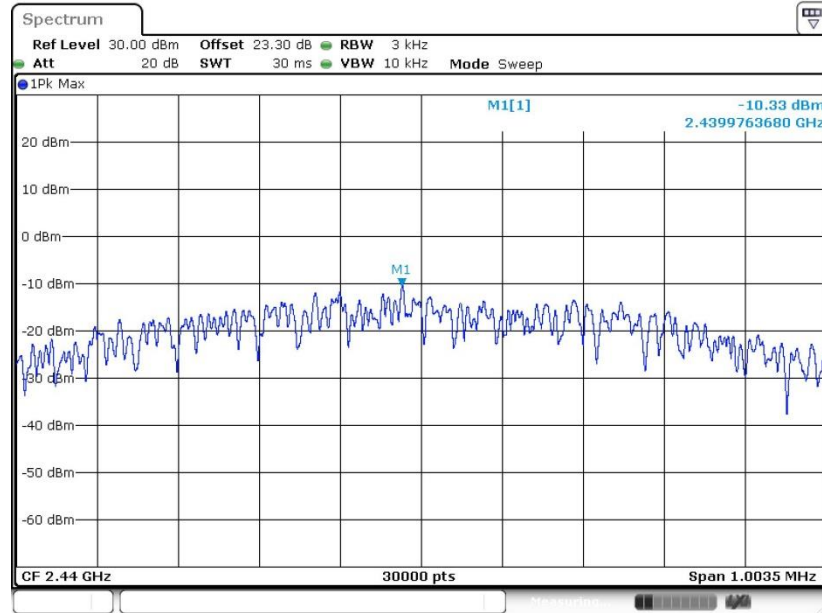

Date: 29.AUG.2020 02:19:07



PSD 3kHz Plot on Channel 39

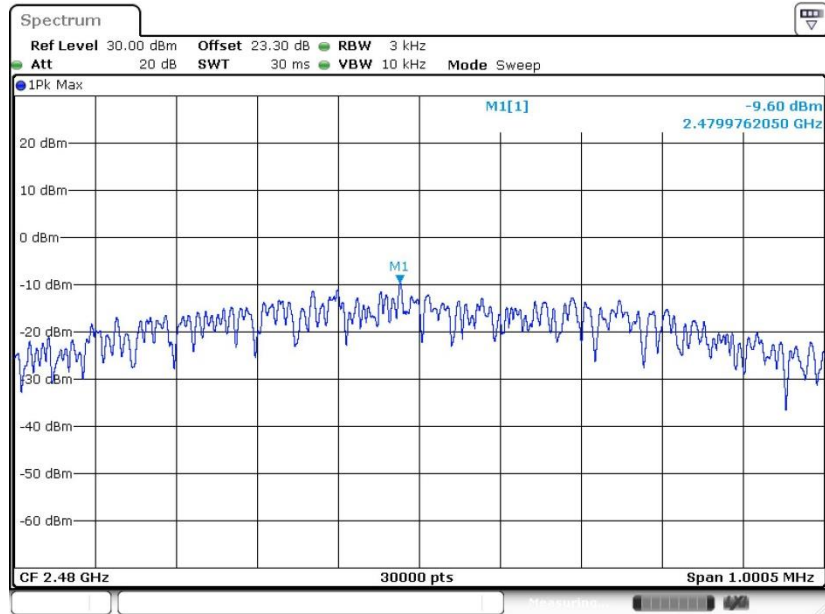

Date: 29.AUG.2020 02:26:04

Bluetooth v5.0 LE

PSD 3kHz Plot on Channel 00

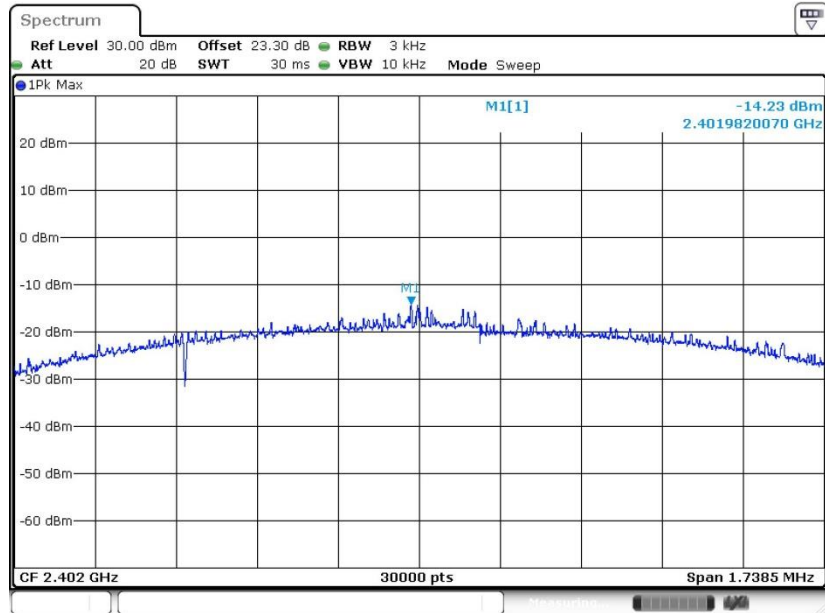

Date: 29.AUG.2020 02:41:53



PSD 3kHz Plot on Channel 19

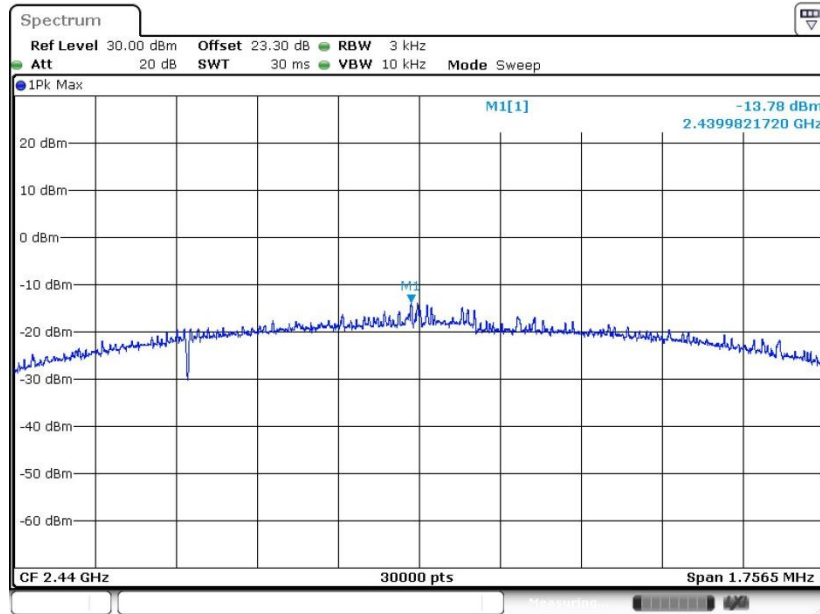

Date: 29.AUG.2020 02:56:21

PSD 3kHz Plot on Channel 39

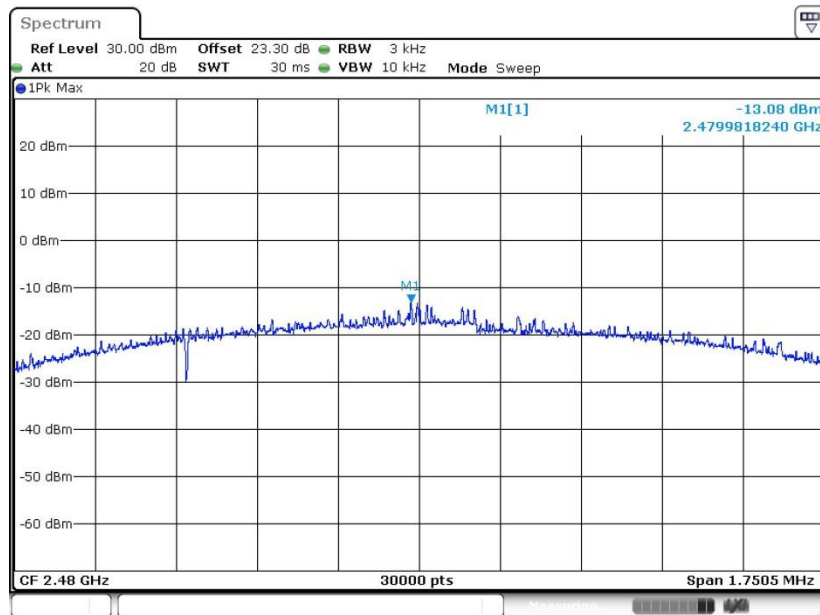

Date: 29.AUG.2020 03:13:59

3.4 Conducted Band Edges and Spurious Emission Measurement

3.4.1 Limit of Conducted Band Edges and Spurious Emission

All harmonics/spurious must be at least 20 dB down from the highest emission level within the authorized band.

3.4.2 Measuring Instruments

The section 4.0 of List of Measuring Equipment of this test report is used for test.

3.4.3 Test Procedure

1. The testing follows ANSI C63.10-2013 clause 11.13
2. The RF output of EUT was connected to the spectrum analyzer by RF cable and attenuator. The path loss was compensated to the results for each measurement.
3. Set to the maximum power setting and enable the EUT transmit continuously.
4. Set RBW = 100 kHz, VBW=300 kHz, Peak Detector. Unwanted Emissions measured in any 100 kHz bandwidth outside of the authorized frequency band shall be attenuated by at least 20 dB relative to the maximum in-band peak PSD level in 100 kHz when maximum peak conducted output power procedure is used. If the transmitter complies with the conducted power limits based on the use of RMS averaging over a time interval, the attenuation required under this paragraph shall be 30 dB instead of 20 dB.
5. Measure and record the results in the test report.
6. The RF fundamental frequency should be excluded against the limit line in the operating frequency band.

3.4.4 Test Setup





3.4.5 Test Result of Conducted Band Edges Plots

Bluetooth v4.2 LE

Low Band Edge Plot on Channel 00

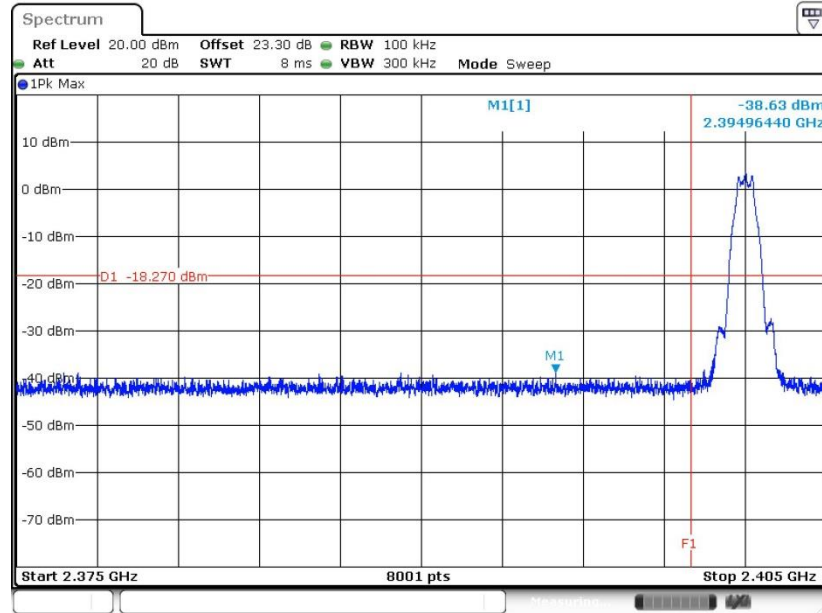

Date: 4.SEP.2020 07:24:00

High Band Edge Plot on Channel 39

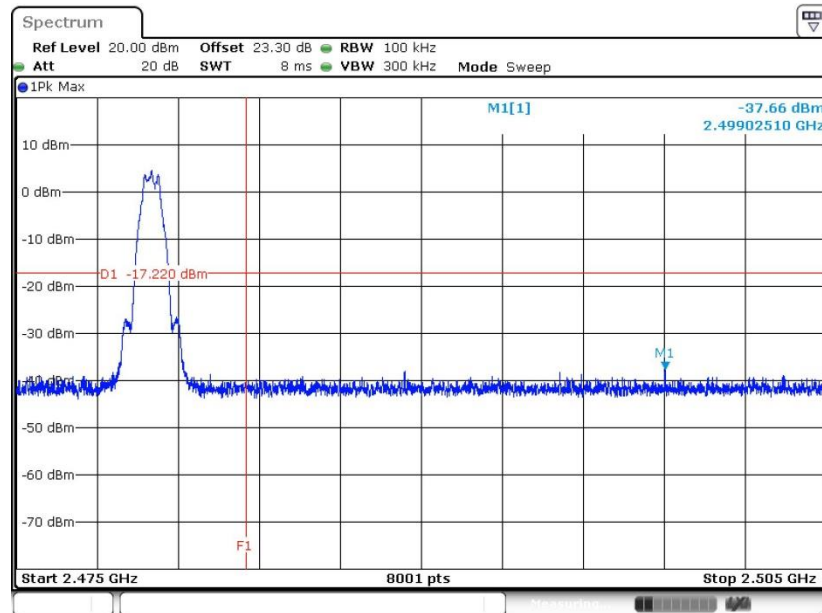

Date: 4.SEP.2020 07:29:58



Bluetooth v5.0 LE

Low Band Edge Plot on Channel 00

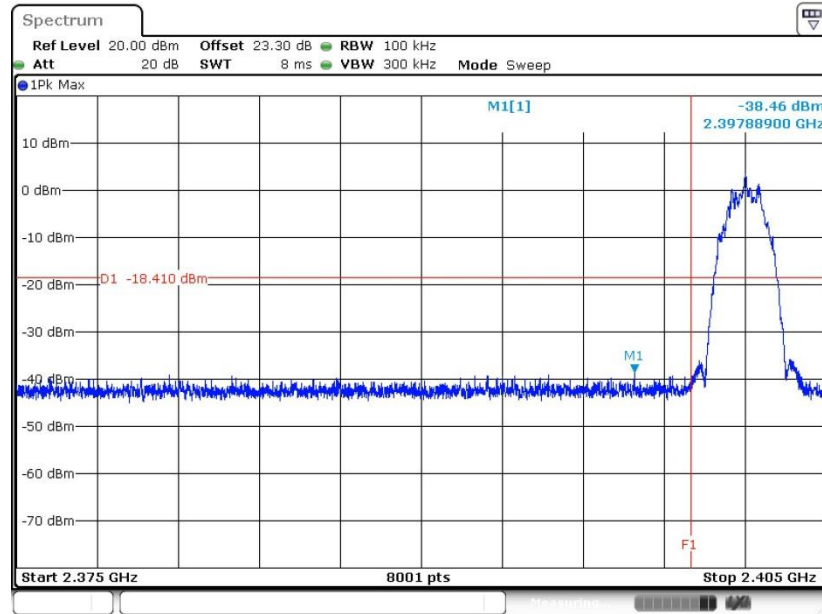

Date: 4.SEP.2020 07:34:07

High Band Edge Plot on Channel 39

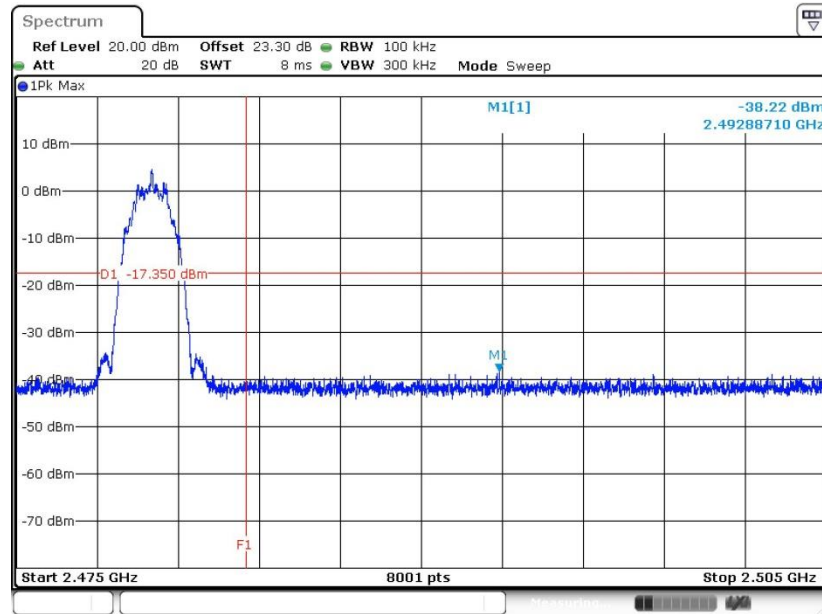

Date: 4.SEP.2020 07:39:49



3.4.6 Test Result of Conducted Spurious Emission Plots

Bluetooth v4.2 LE

Conducted Spurious Emission Plot on Bluetooth LE 1Mbps GFSK Channel 00

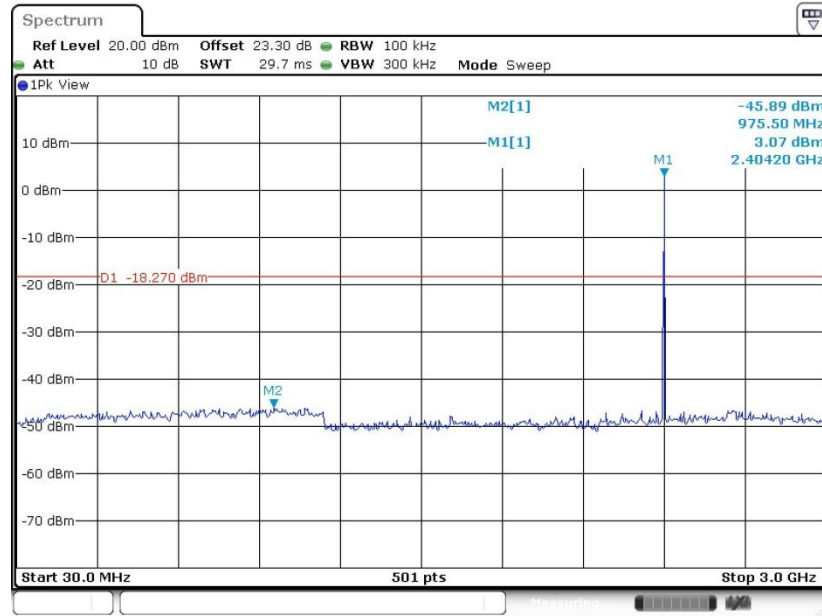

Date: 4.SEP.2020 07:25:12

Conducted Spurious Emission Plot on Bluetooth LE 1Mbps GFSK Channel 00

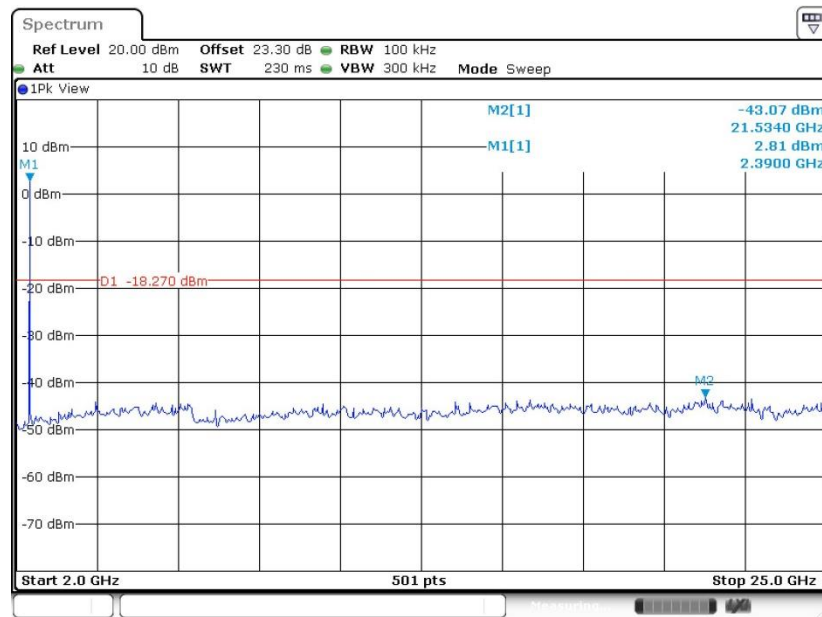

Date: 4.SEP.2020 07:25:24



Conducted Spurious Emission Plot on Bluetooth LE 1Mbps GFSK Channel 19

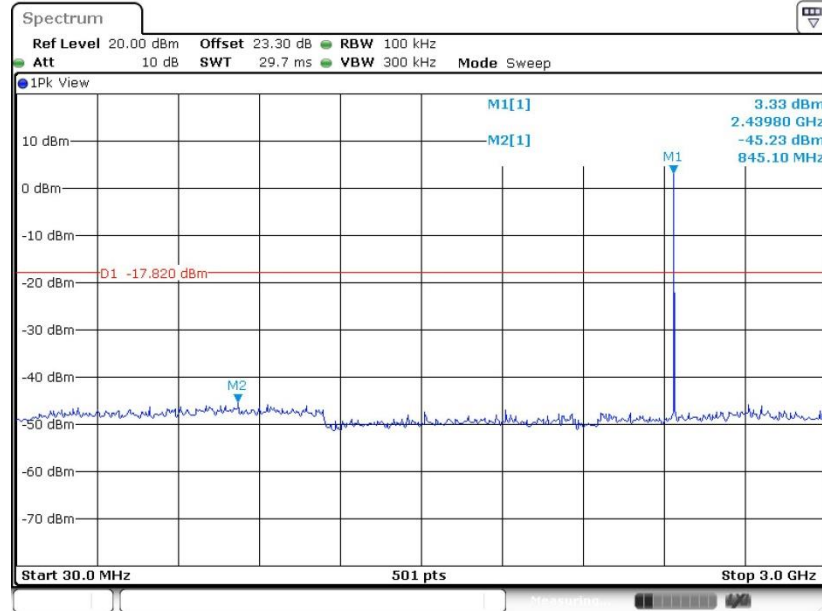

Date: 4.SEP.2020 07:29:00

Conducted Spurious Emission Plot on Bluetooth LE 1Mbps GFSK Channel 19

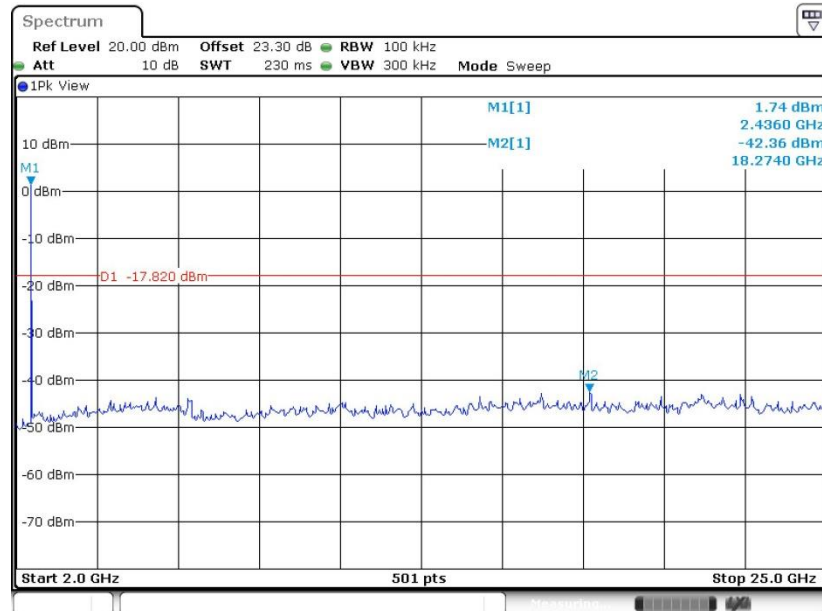

Date: 4.SEP.2020 07:29:14



Conducted Spurious Emission Plot on Bluetooth LE 1Mbps
GFSK Channel 39

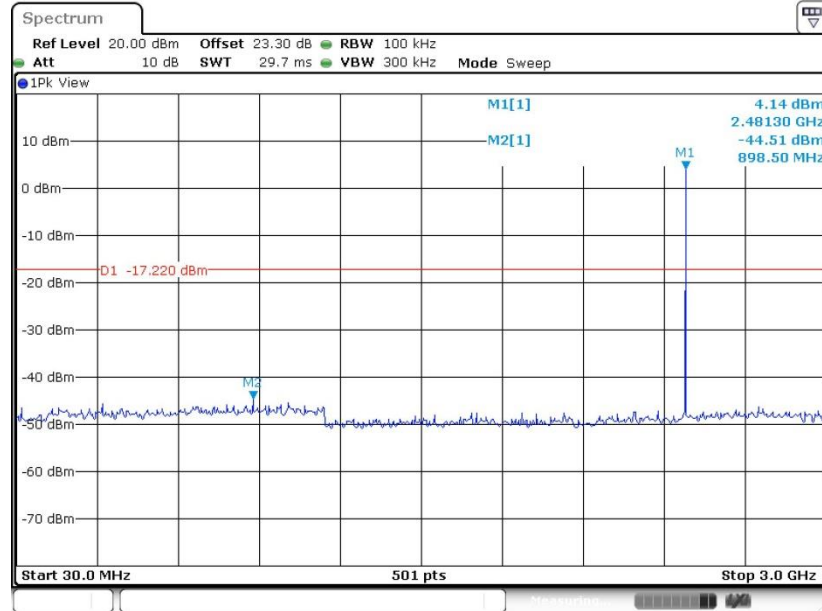

Date: 4.SEP.2020 07:30:13

Conducted Spurious Emission Plot on Bluetooth LE 1Mbps
GFSK Channel 39

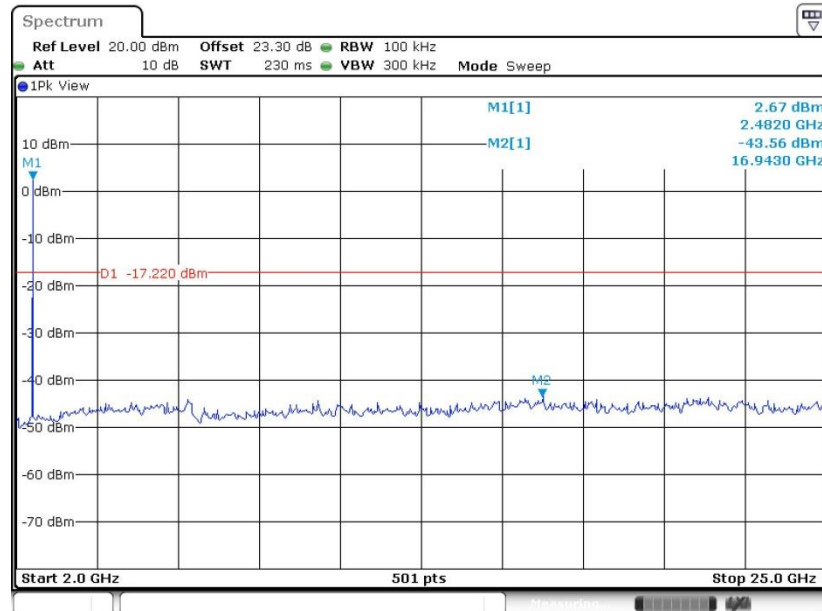

Date: 4.SEP.2020 07:30:24



Bluetooth v5.0 LE

Conducted Spurious Emission Plot on Bluetooth LE 2Mbps
GFSK Channel 00

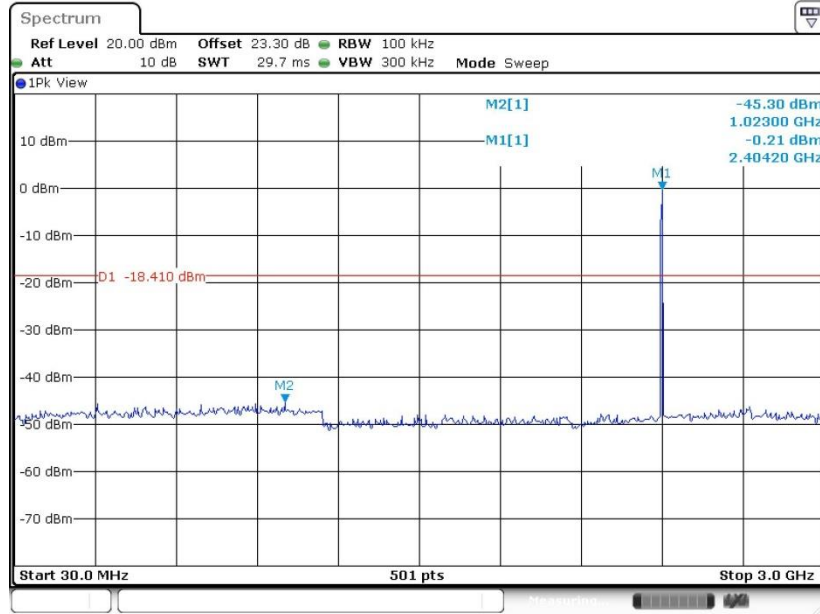

Date: 4.SEP.2020 07:34:30

Conducted Spurious Emission Plot on Bluetooth LE 2Mbps
GFSK Channel 00

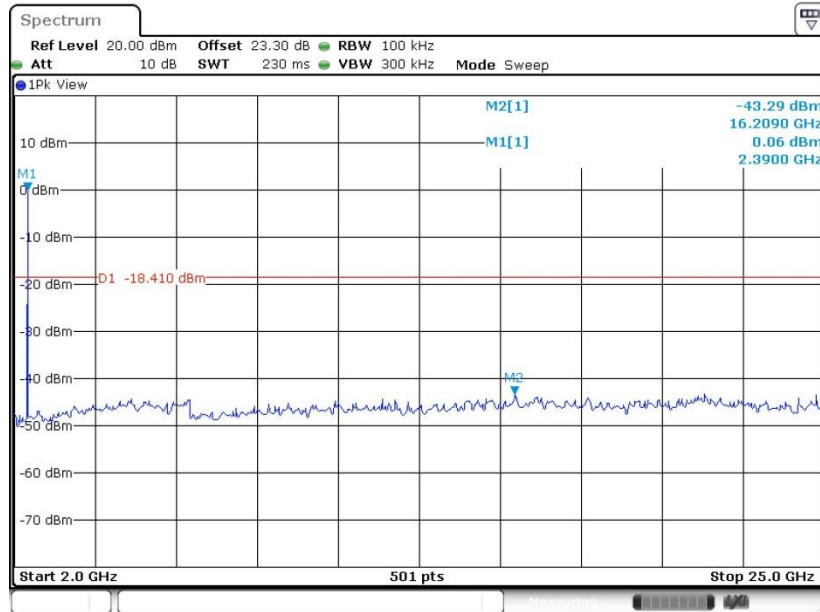

Date: 4.SEP.2020 07:34:42



Conducted Spurious Emission Plot on Bluetooth LE 2Mbps GFSK Channel 19

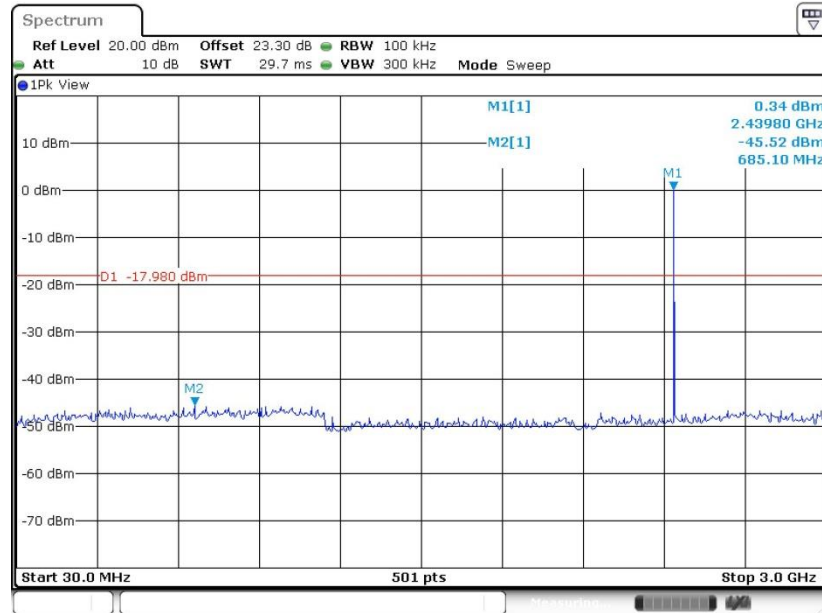

Date: 4.SEP.2020 07:38:23

Conducted Spurious Emission Plot on Bluetooth LE 2Mbps GFSK Channel 19

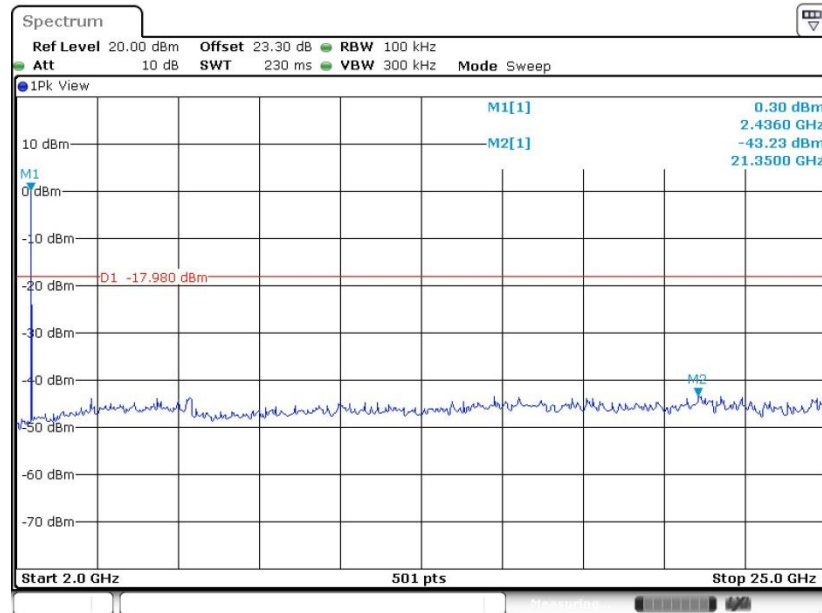

Date: 4.SEP.2020 07:38:35



Conducted Spurious Emission Plot on Bluetooth LE 2Mbps GFSK Channel 39

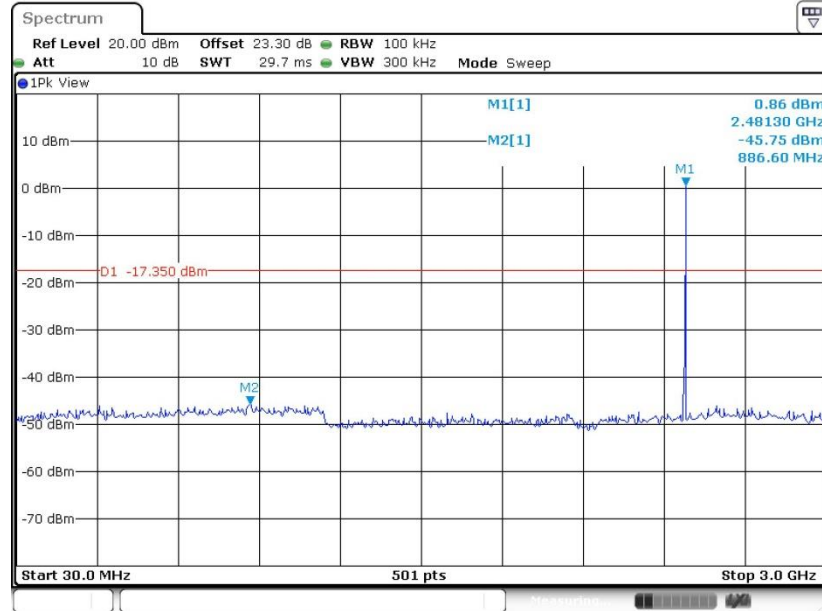

Date: 4.SEP.2020 07:40:09

Conducted Spurious Emission Plot on Bluetooth LE 2Mbps GFSK Channel 39

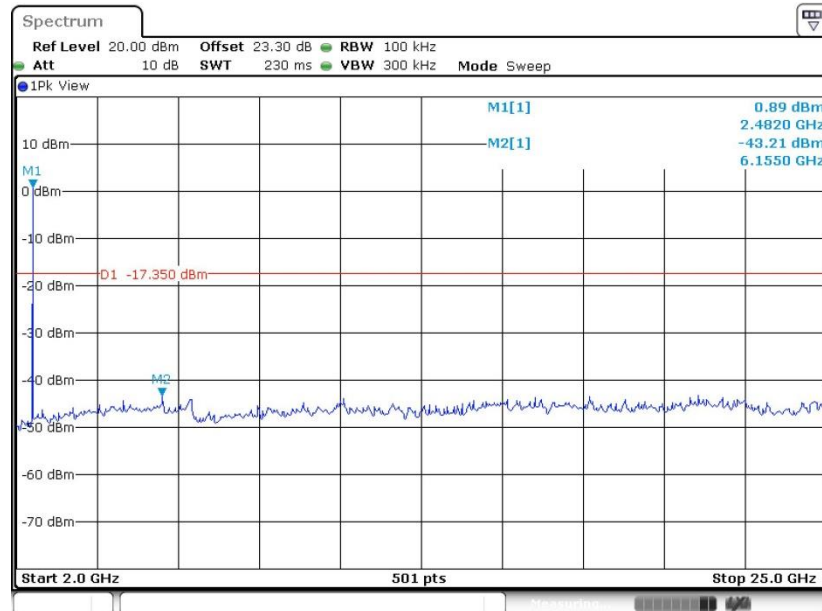

Date: 4.SEP.2020 07:40:21



3.5 Radiated Band Edges and Spurious Emission Measurement

3.5.1 Limit of Radiated Band Edges and Spurious Emission

In any 100 kHz bandwidth outside the intentional radiator frequency band, all harmonics/spurious must be at least 20 dB below the highest emission level within the authorized band. If the output power of this device was measured by spectrum analyzer, the attenuation under this paragraph shall be 30 dB instead of 20 dB. In addition, radiated emissions which fall in the restricted bands must also comply with the limits as below.

Frequency (MHz)	Field Strength (microvolts/meter)	Measurement Distance (meters)
0.009 – 0.490	2400/F(kHz)	300
0.490 – 1.705	24000/F(kHz)	30
1.705 – 30.0	30	30
30 – 88	100	3
88 – 216	150	3
216 - 960	200	3
Above 960	500	3

3.5.2 Measuring Instruments

The section 4.0 of List of Measuring Equipment of this test report is used for test.



3.5.3 Test Procedures

1. The testing follows ANSI C63.10-2013 clause 11.11 & 11.12
2. The EUT was arranged to its worst case and then tune the antenna tower (from 1 m to 4 m) and turntable (from 0 degree to 360 degrees) to find the maximum reading. A pre-amp and a high pass filter are used for the test in order to get better signal level.
3. The EUT was placed on a turntable with 0.8 meter for frequency below 1GHz and 1.5 meter for frequency above 1GHz respectively above ground.
4. The EUT was set 3 meters from the interference receiving antenna, which was mounted on the top of a variable height antenna tower.
5. Corrected Reading: Antenna Factor + Cable Loss + Read Level - Preamp Factor = Level
6. For testing below 1GHz, if the emission level of the EUT in peak mode was 3 dB lower than the limit specified, then peak values of EUT will be reported, otherwise, the emissions will be repeated one by one using the CISPR quasi-peak method and reported.
7. For testing above 1GHz, the emission level of the EUT in peak mode was 20dB lower than average limit (that means the emission level in average mode also complies with the limit in average mode), then peak values of EUT will be reported, otherwise, the emissions will be measured in average mode again and reported.
8. Use the following spectrum analyzer settings:
 - (1) Span shall wide enough to fully capture the emission being measured;
 - (2) Set RBW=100 kHz for $f < 1$ GHz; $VBW \geq RBW$; Sweep = auto; Detector function = peak; Trace = max hold;
 - (3) Set RBW = 1 MHz, VBW= 3MHz for $f \geq 1$ GHz for peak measurement.
For average measurement:
 - $VBW = 10$ Hz, when duty cycle is no less than 98 percent.
 - $VBW \geq 1/T$, when duty cycle is less than 98 percent where T is the minimum transmission duration over which the transmitter is on and is transmitting at its maximum power control level for the tested mode of operation.

3.5.4 Test Setup

For radiated emissions below 30MHz

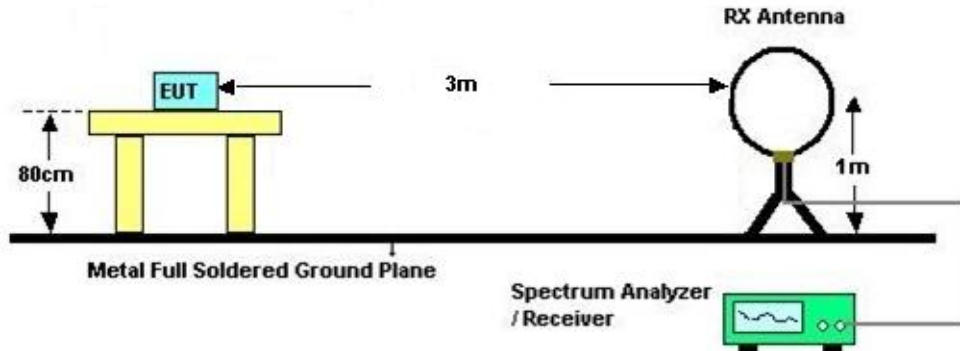

For radiated emissions from 30MHz to 1GHz

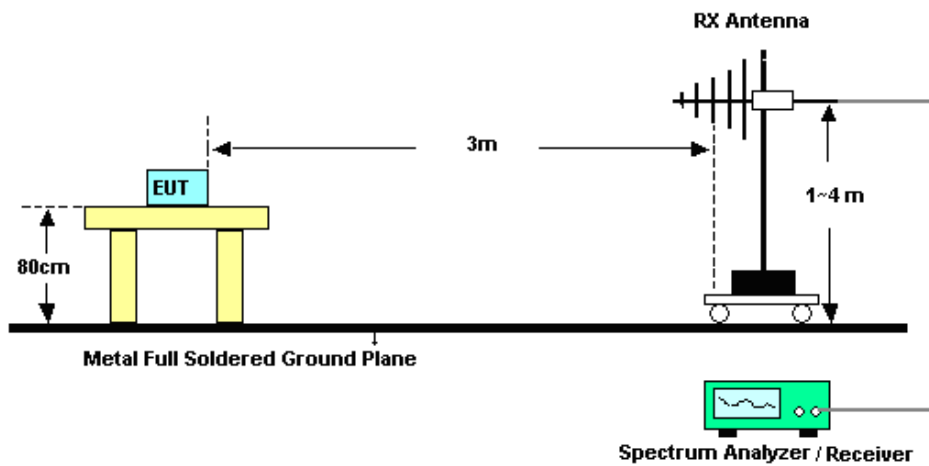

For radiated emissions above 1GHz

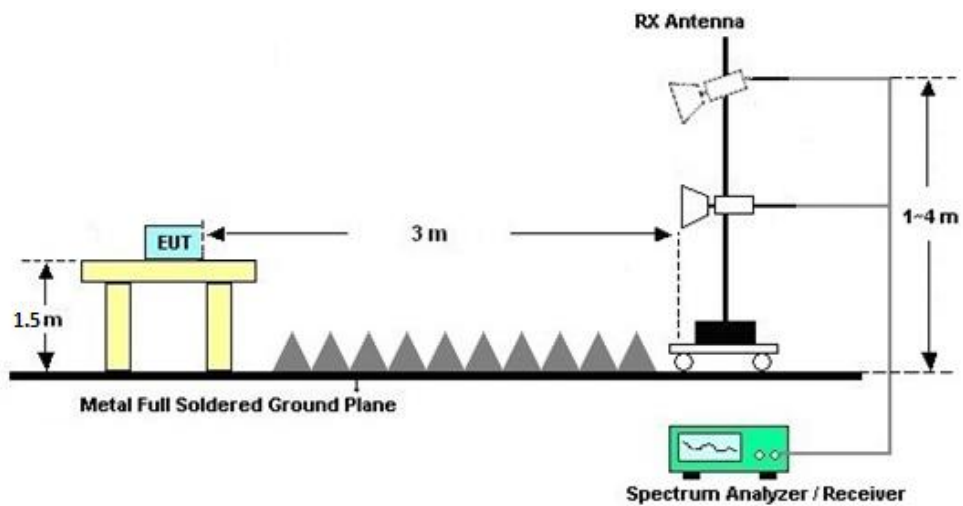



3.5.5 Test Results of Radiated Spurious Emissions (9 kHz ~ 30 MHz)

The low frequency, which started from 9 kHz to 30MHz, was pre-scanned and the result which was 20dB lower than the limit line was not reported.

There is a comparison data of both open-field test site and semi-Anechoic chamber, and the result came out very similar.

3.5.6 Test Result of Radiated Spurious at Band Edges

Please refer to Appendix C.

3.5.7 Duty Cycle

Please refer to Appendix D.

3.5.8 Test Result of Radiated Spurious Emission (30MHz ~ 10th Harmonic)

Please refer to Appendix C.



3.6 AC Conducted Emission Measurement

3.6.1 Limit of AC Conducted Emission

For equipment that is designed to be connected to the public utility (AC) power line, the radio frequency voltage that is conducted back onto the AC power line on any frequency or frequencies within the band 150 kHz to 30 MHz shall not exceed the limits in the following table.

Frequency of emission (MHz)	Conducted limit (dBµV)	
	Quasi-peak	Average
0.15-0.5	66 to 56*	56 to 46*
0.5-5	56	46
5-30	60	50

*Decreases with the logarithm of the frequency.

3.6.2 Measuring Instruments

The section 4.0 of List of Measuring Equipment of this test report is used for test.

3.6.3 Test Procedures

1. The EUT was placed 0.4 meter from the conducting wall of the shielding room was kept at least 80 centimeters from any other grounded conducting surface.
2. Connect EUT to the power mains through a line impedance stabilization network (LISN).
3. All the support units are connecting to the other LISN.
4. The LISN provides 50 ohm coupling impedance for the measuring instrument.
5. The FCC states that a 50 ohm, 50 microhenry LISN should be used.
6. Both sides of AC line were checked for maximum conducted interference.
7. The frequency range from 150 kHz to 30 MHz was searched.
8. Set the test-receiver system to Peak Detect Function and specified bandwidth (IF Bandwidth = 9kHz) with Maximum Hold Mode. Then measurement is also conducted by Average Detector and Quasi-Peak Detector Function respectively.

3.6.4 Test Setup

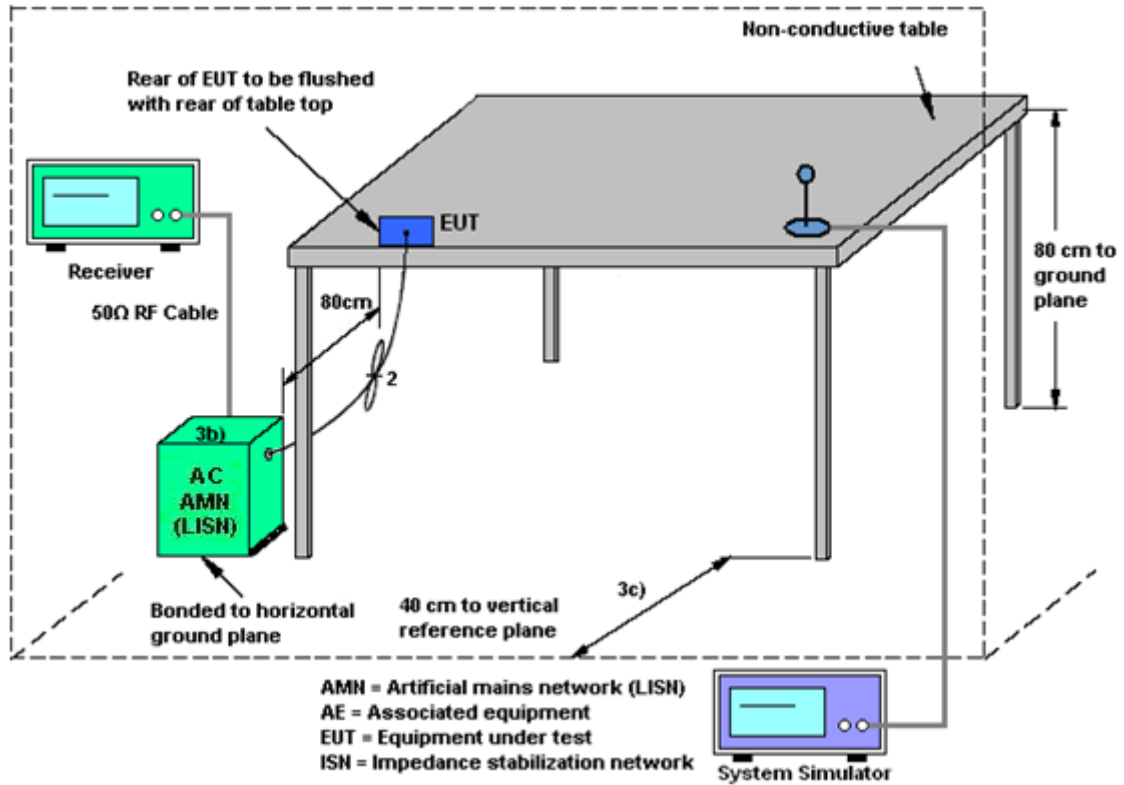

3.6.5 Test Result of AC Conducted Emission

Please refer to Appendix B.



3.7 Antenna Requirements

3.7.1 Standard Applicable

If directional gain of transmitting antennas is greater than 6dBi, the power shall be reduced by the same level in dB comparing to gain minus 6dBi. The use of a permanently attached antenna or of an antenna that uses a unique coupling to the intentional radiator shall be considered sufficient to comply with the rule.

3.7.2 Antenna Anti-Replacement Construction

An embedded-in antenna design is used.

3.7.3 Antenna Gain

The antenna peak gain of EUT is less than 6 dBi. Therefore, it is not necessary to reduce maximum peak output power limit.



4 List of Measuring Equipment

Instrument	Manufacturer	Model No.	Serial No.	Characteristics	Calibration Date	Test Date	Due Date	Remark
Spectrum Analyzer	R&S	FSV40	101078	10Hz~40GHz	Apr. 16, 2020	Aug. 29, 2020~ Sep. 04, 2020	Apr. 15, 2021	Conducted (TH01-SZ)
Pulse Power Sensor	Anritsu	MA2411B	1207253	30MHz~40GHz	Dec. 26, 2019	Aug. 29, 2020~ Sep. 04, 2020	Dec. 25, 2020	Conducted (TH01-SZ)
Power Meter	Anritsu	ML2495A	1218010	50MHz Bandwidth	Dec. 26, 2019	Aug. 29, 2020~ Sep. 04, 2020	Dec. 25, 2020	Conducted (TH01-SZ)
EMI Test Receiver	Keysight	N9038A	MY564000 04	3Hz~8.5GHz;M ax 30dBm	Oct.18, 2019	Sep. 07, 2020	Oct.17, 2020	Radiation (03CH06-KS)
EXA Spectrum Analyzer	Keysight	N9010A	MY551502 08	10Hz-44GHz	Apr. 14, 2020	Sep. 07, 2020	Apr.13, 2021	Radiation (03CH06-KS)
Loop Antenna	R&S	HFH2-Z2	100321	9kHz~30MHz	Nov. 10, 2019	Sep. 07, 2020	Nov. 09, 2020	Radiation (03CH06-KS)
Bilog Antenna	TeseQ	CBL6111D	49921	30MHz-1GHz	May. 29, 2020	Sep. 07, 2020	May. 28, 2021	Radiation (03CH06-KS)
Double Ridge Horn Antenna	ETS-Lindgren	3117	00218652	1GHz~18GHz	Apr. 27, 2020	Sep. 07, 2020	Apr. 26, 2021	Radiation (03CH06-KS)
SHF-EHF Horn	Com-power	AH-840	101115	18GHz~40GHz	Nov. 10, 2019	Sep. 07, 2020	Nov. 09, 2020	Radiation (03CH06-KS)
Amplifier	SONOMA	310N	187289	9KHz ~1GHZ	Apr. 14, 2020	Sep. 07, 2020	Apr. 13, 2021	Radiation (03CH06-KS)
Amplifier	MITEQ	EM18G40GG A	060728	18~40GHz	Jan. 08, 2020	Sep. 07, 2020	Jan. 07, 2021	Radiation (03CH06-KS)
high gain Amplifier	MITEQ	AMF-7D-0010 1800-30-10P	2025788	1Ghz-18Ghz	Jan. 02, 2020	Sep. 07, 2020	Jan. 03, 2021	Radiation (03CH06-KS)
Amplifier	Keysight	83017A	MY532702 03	500MHz~26.5G Hz	Apr. 15, 2020	Sep. 07, 2020	Apr. 14, 2021	Radiation (03CH06-KS)
AC Power Source	Chroma	61601	F1040900 04	N/A	NCR	Sep. 07, 2020	NCR	Radiation (03CH06-KS)
Turn Table	ChamPro	EM 1000-T	060762-T	0~360 degree	NCR	Sep. 07, 2020	NCR	Radiation (03CH06-KS)
Antenna Mast	ChamPro	EM 1000-A	060762-A	1 m~4 m	NCR	Sep. 07, 2020	NCR	Radiation (03CH06-KS)
EMI Receiver	R&S	ESR7	101630	9kHz~7GHz;	Dec. 26, 2019	Sep. 02, 2020	Dec. 25, 2020	Conduction (CO01-SZ)
AC LISN	EMCO	3816/2SH	00103912	9kHz~30MHz	Oct. 17, 2019	Sep. 02, 2020	Oct. 16, 2020	Conduction (CO01-SZ)
AC LISN (for auxiliary equipment)	EMCO	3816/2SH	00103892	9kHz~30MHz	Oct. 17, 2019	Sep. 02, 2020	Oct. 16, 2020	Conduction (CO01-SZ)
AC Power Source	Chroma	61602	616020000 891	100Vac~250Vac	Jul. 21, 2020	Sep. 02, 2020	Jul. 20, 2021	Conduction (CO01-SZ)

NCR: No Calibration Required



5 Uncertainty of Evaluation

The measurement uncertainties shown below were calculated in accordance with the requirements of ANSI 63.10-2013. All the measurement uncertainty value were shown with a coverage K=2 to indicate 95% level of confidence. The measurement data show herein meets or exceeds the CISPR measurement uncertainty values specified in CISPR 16-4-2 and can be compared directly to specified limit to determine compliance.

Uncertainty of Conducted Emission Measurement (150 kHz ~ 30 MHz)

Measuring Uncertainty for a Level of Confidence of 95% (U = 2Uc(y))	2.7dB
---	-------

Uncertainty of Radiated Emission Measurement (30 MHz ~ 1000 MHz)

Measuring Uncertainty for a Level of Confidence of 95% (U = 2Uc(y))	5.0dB
---	-------

Uncertainty of Radiated Emission Measurement (1000 MHz ~ 18000 MHz)

Measuring Uncertainty for a Level of Confidence of 95% (U = 2Uc(y))	5.0dB
---	-------

Uncertainty of Radiated Emission Measurement (18000 MHz ~ 40000 MHz)

Measuring Uncertainty for a Level of Confidence of 95% (U = 2Uc(y))	5.0dB
---	-------



Appendix A. Conducted Test Results

Appendix A. Test Result of Conducted Test Items

Test Engineer:	Wu Shi Mao	Temperature:	21~25	°C
Test Date:	2020/8/29~2020/09/04	Relative Humidity:	51~54	%

TEST RESULTS DATA
6dB and 99% Occupied Bandwidth

Mod.	Data Rate	N _{TX}	CH.	Freq. (MHz)	99% Occupied BW (MHz)	6dB BW (MHz)	6dB BW Limit (MHz)	Pass/Fail
BLE	1Mbps	1	0	2402	1.027	0.667	0.50	Pass
BLE	1Mbps	1	19	2440	1.027	0.669	0.50	Pass
BLE	1Mbps	1	39	2480	1.027	0.667	0.50	Pass

TEST RESULTS DATA
Peak Power Table

Mod.	Data Rate	N _{TX}	CH.	Freq. (MHz)	Peak Conducted Power (dBm)	Conducted Power Limit (dBm)	DG (dBi)	EIRP Power (dBm)	EIRP Power Limit (dBm)	Pass /Fail
BLE	1Mbps	1	0	2402	7.41	30.00	-2.40	5.01	36.00	Pass
BLE	1Mbps	1	19	2440	6.98	30.00	-2.40	4.58	36.00	Pass
BLE	1Mbps	1	39	2480	7.02	30.00	-2.40	4.62	36.00	Pass

TEST RESULTS DATA
Peak Power Density

Mod.	Data Rate	N _{TX}	CH.	Freq. (MHz)	Peak PSD (dBm /100kHz)	Peak PSD (dBm /3kHz)	DG (dBi)	Peak PSD Limit (dBm /3kHz)	Pass/Fail
BLE	1Mbps	1	0	2402	1.73	-10.65	-2.40	8.00	Pass
BLE	1Mbps	1	19	2440	2.18	-10.33	-2.40	8.00	Pass
BLE	1Mbps	1	39	2480	2.78	-9.60	-2.40	8.00	Pass

Note: PSD (dBm/ 100kHz) is a reference level used for Conducted Band Edges and Conducted Spurious Emission 20dBc limit.

Appendix A. Test Result of Conducted Test Items

Test Engineer:	Wu Shi Mao	Temperature:	21~25	°C
Test Date:	2020/8/29~2020/09/04	Relative Humidity:	51~54	%

TEST RESULTS DATA
6dB and 99% Occupied Bandwidth

Mod.	Data Rate	NTX	CH.	Freq. (MHz)	99% Occupied BW (MHz)	6dB BW (MHz)	6dB BW Limit (MHz)	Pass/Fail
BLE	2Mbps	1	0	2402	2.042	1.159	0.50	Pass
BLE	2Mbps	1	19	2440	2.046	1.171	0.50	Pass
BLE	2Mbps	1	39	2480	2.046	1.167	0.50	Pass

TEST RESULTS DATA
Peak Power Table

Mod.	Data Rate	NTX	CH.	Freq. (MHz)	Peak Conducted Power (dBm)	Conducted Power Limit (dBm)	DG (dBi)	EIRP Power (dBm)	EIRP Power Limit (dBm)	Pass /Fail
BLE	2Mbps	1	0	2402	7.49	30.00	-2.40	5.09	36.00	Pass
BLE	2Mbps	1	19	2440	7.09	30.00	-2.40	4.69	36.00	Pass
BLE	2Mbps	1	39	2480	7.01	30.00	-2.40	4.61	36.00	Pass

TEST RESULTS DATA
Peak Power Density

Mod.	Data Rate	NTX	CH.	Freq. (MHz)	Peak PSD (dBm /100kHz)	Peak PSD (dBm /3kHz)	DG (dBi)	Peak PSD Limit (dBm /3kHz)	Pass/Fail
BLE	2Mbps	1	0	2402	1.59	-14.23	-2.40	8.00	Pass
BLE	2Mbps	1	19	2440	2.02	-13.78	-2.40	8.00	Pass
BLE	2Mbps	1	39	2480	2.65	-13.08	-2.40	8.00	Pass

Note: PSD (dBm/ 100kHz) is a reference level used for Conducted Band Edges and Conducted Spurious Emission 20dBc limit.



Appendix B. AC Conducted Emission Test Results

Test Engineer :	XieYuQiang	Temperature :	22~25°C
		Relative Humidity :	50~55%
Test Voltage :	120Vac / 60Hz	Phase :	Line
Remark :	All emissions not reported here are more than 10 dB below the prescribed limit.		

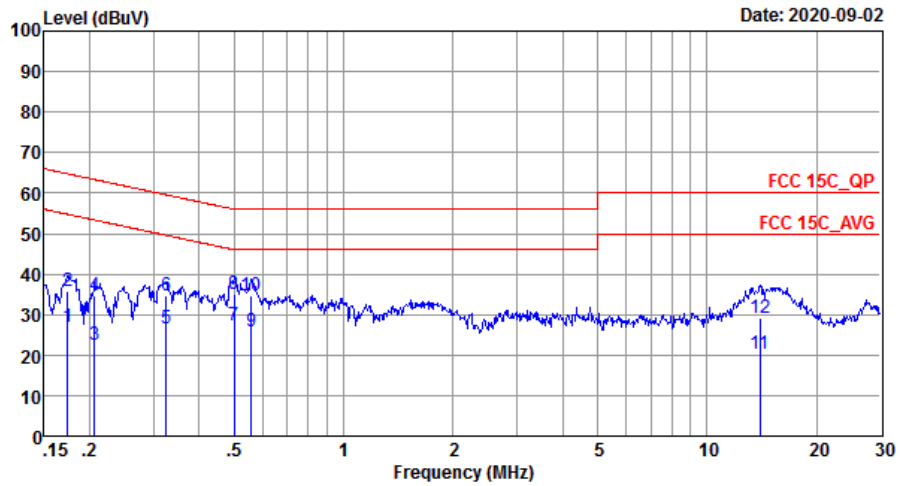

Site : C001-SZ
Condition: FCC 15C_QP LISN_20200719_L LINE

IMEI : 004401117394011

	Freq	Level	Over Limit	Limit Line	Read Level	LISN Factor	Cable Loss	Remark
			dB	dBuV	dBuV	dB	dB	
1	0.17	26.94	-27.83	54.77	16.90	0.03	10.01	Average
2	0.17	35.84	-28.93	64.77	25.80	0.03	10.01	QP
3	0.21	22.34	-31.02	53.36	12.30	0.03	10.01	Average
4	0.21	34.64	-28.72	63.36	24.60	0.03	10.01	QP
5	0.33	26.44	-23.13	49.57	16.40	0.03	10.01	Average
6	0.33	34.74	-24.83	59.57	24.70	0.03	10.01	QP
7 *	0.50	27.28	-18.73	46.01	17.20	0.02	10.06	Average
8	0.50	34.98	-21.03	56.01	24.90	0.02	10.06	QP
9	0.56	25.68	-20.32	46.00	15.60	0.02	10.06	Average
10	0.56	34.58	-21.42	56.00	24.50	0.02	10.06	QP
11	13.99	20.37	-29.63	50.00	9.61	0.48	10.28	Average
12	13.99	29.07	-30.93	60.00	18.31	0.48	10.28	QP



Test Engineer :	XieYuQiang	Temperature :	22~25°C
		Relative Humidity :	50~55%
Test Voltage :	120Vac / 60Hz	Phase :	Neutral
Remark :	All emissions not reported here are more than 10 dB below the prescribed limit.		

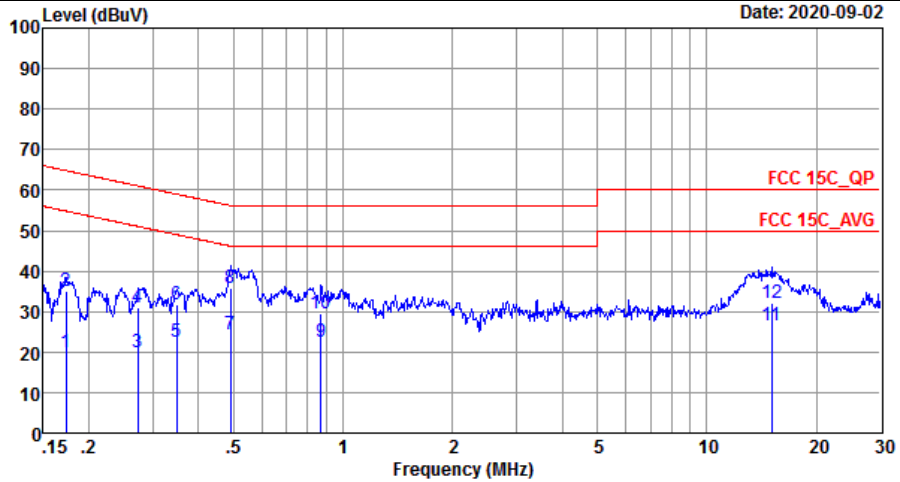

Site : C001-SZ
 Condition: FCC 15C QP LISN_20200719_N NEUTRAL

IMEI : 004401117394011

	Freq	Level	Over Limit	Limit Line	Read Level	LISN Factor	Cable Loss	Remark
			dB	dBuV	dBuV	dB	dB	
1	0.17	19.94	-34.87	54.81	9.90	0.03	10.01	Average
2	0.17	35.04	-29.77	64.81	25.00	0.03	10.01	QP
3	0.27	20.04	-30.99	51.03	10.00	0.03	10.01	Average
4	0.27	31.14	-29.89	61.03	21.10	0.03	10.01	QP
5	0.35	22.63	-26.37	49.00	12.60	0.02	10.01	Average
6	0.35	31.63	-27.37	59.00	21.60	0.02	10.01	QP
7	0.49	24.28	-21.86	46.14	14.20	0.02	10.06	Average
8 *	0.49	35.88	-20.26	56.14	25.80	0.02	10.06	QP
9	0.87	22.40	-23.60	46.00	12.30	0.04	10.06	Average
10	0.87	29.50	-26.50	56.00	19.40	0.04	10.06	QP
11	15.07	26.42	-23.58	50.00	15.80	0.33	10.29	Average
12	15.07	32.22	-27.78	60.00	21.60	0.33	10.29	QP

Note:

- Level(dBμV) = Read Level(dBμV) + LISN Factor(dB) + Cable Loss(dB)
- Over Limit(dB) = Level(dBμV) – Limit Line(dBμV)



Appendix C. Radiated Spurious Emission

2.4GHz 2400~2483.5MHz

BLE (Band Edge @ 3m)

BLE	Note	Frequency	Level	Over Limit	Limit Line	Read Level	Antenna Factor	Path Loss	Preamp Factor	Ant Pos	Table Pos	Peak Avg.	Pol.
		(MHz)	(dBμV/m)	(dB)	(dBμV/m)	(dBμV)	(dB/m)	(dB)	(dB)	(cm)	(deg)	(P/A)	(H/V)
BLE CH 00 2402MHz		2376.3	53.97	-20.03	74	48.47	32.1	7.4	34	110	170	P	H
		2381.89	44.02	-9.98	54	38.51	32.1	7.4	33.99	110	170	A	H
	*	2402	89.92	-	-	84.27	32.2	7.43	33.98	110	170	P	H
	*	2402	89.38	-	-	83.73	32.2	7.43	33.98	110	170	A	H
		2349	54.3	-19.7	74	49.07	31.9	7.34	34.01	100	340	P	V
		2383.06	44.33	-9.67	54	38.82	32.1	7.4	33.99	100	340	A	V
	*	2402	85.43	-	-	79.78	32.2	7.43	33.98	100	340	P	V
	*	2402	84.85	-	-	79.2	32.2	7.43	33.98	100	340	A	V
BLE CH 39 2480MHz		2498.92	54.27	-19.73	74	48.67	31.94	7.59	33.93	152	172	P	H
		2498.44	44.38	-9.62	54	38.78	31.94	7.59	33.93	152	172	A	H
	*	2480	90.59	-	-	84.98	31.99	7.56	33.94	152	172	P	H
	*	2480	90.07	-	-	84.46	31.99	7.56	33.94	152	172	A	H
		2494.72	54.18	-19.82	74	48.58	31.94	7.59	33.93	259	24	P	V
		2497.96	44.13	-9.87	54	38.53	31.94	7.59	33.93	259	24	A	V
	*	2480	86.52	-	-	80.91	31.99	7.56	33.94	259	24	P	V
	*	2480	85.94	-	-	80.33	31.99	7.56	33.94	259	24	A	V
Remark	1. No other spurious found. 2. All results are PASS against Peak and Average limit line.												



2.4GHz 2400~2483.5MHz
BLE (Harmonic @ 3m)

Table with 14 columns: BLE, Note, Frequency (MHz), Level (dBµV/m), Over Limit (dB), Limit Line (dBµV/m), Read Level (dBµV), Antenna Factor (dB/m), Path Loss (dB), Preamp Factor (dB), Ant Pos (cm), Table Pos (deg), Peak Avg. (P/A), Pol. (H/V). Rows include BLE CH 00 (2402MHz) and BLE CH 19 (2440MHz) and BLE CH 39 (2480MHz) with multiple frequency entries.

Remark

- 1. No other spurious found.
2. All results are PASS against Peak and Average limit line.



Emission below 1GHz

2.4GHz BLE (LF)

BLE	Note	Frequency	Level	Over	Limit	Read	Antenna	Path	Preamp	Ant	Table	Peak	Pol.
				Limit	Line	Level	Factor	Loss	Factor	Pos	Pos	Avg.	
		(MHz)	(dBμV/m)	(dB)	(dBμV/m)	(dBμV)	(dB/m)	(dB)	(dB)	(cm)	(deg)	(P/A)	(H/V)
2.4GHz BLE LF		30.97	18.67	-21.33	40	26.12	24.57	1.26	33.28	100	360	P	H
		93.05	18.68	-24.82	43.5	34.39	15.19	2.18	33.08	-	-	P	H
		128.94	17.51	-25.99	43.5	30.51	17.6	2.56	33.16	-	-	P	H
		223.03	18.06	-27.94	46	32.22	15.63	3.36	33.15	-	-	P	H
		481.05	24.48	-21.52	46	28.73	23.65	4.94	32.84	-	-	P	H
		961.2	29.8	-24.2	54	23.95	30.91	6.96	32.02	-	-	P	H
		32.91	21.98	-18.02	40	30.41	23.51	1.3	33.24	-	-	P	V
		54.25	18.68	-21.32	40	36.74	13.4	1.66	33.12	-	-	P	V
		135.73	16.48	-27.02	43.5	29.48	17.54	2.63	33.17	-	-	P	V
		271.53	17.03	-28.97	46	26.85	19.6	3.72	33.14	-	-	P	V
		481.05	22.79	-23.21	46	27.04	23.65	4.94	32.84	-	-	P	V
	955.38	29.29	-16.71	46	23.41	30.95	6.94	32.01	200	0	P	V	
Remark	1. No other spurious found. 2. All results are PASS against limit line.												



Note symbol

*	Fundamental Frequency which can be ignored. However, the level of any unwanted emissions shall not exceed the level of the fundamental frequency.
!	Test result is over limit line.
P/A	Peak or Average
H/V	Horizontal or Vertical



A calculation example for radiated spurious emission is shown as below:

BLE	Note	Frequency	Level	Over	Limit	Read	Antenna	Path	Preamp	Ant	Table	Peak	Pol.
		(MHz)	(dBμV/m)	(dB)	(dBμV/m)	(dBμV)	(dB/m)	(dB)	(dB)	(cm)	(deg)	(P/A)	(H/V)
BLE CH 00 2402MHz		2390	55.45	-18.55	74	54.51	32.22	4.58	35.86	103	308	P	H
		2390	43.54	-10.46	54	42.6	32.22	4.58	35.86	103	308	A	H

1. Path Loss(dB) = Cable loss(dB) + Filter loss(dB) + Attenuator loss(dB)
2. Level(dBμV/m) =
Antenna Factor(dB/m) + Path Loss(dB) + Read Level(dBμV) - Preamp Factor(dB)
3. Over Limit(dB) = Level(dBμV/m) – Limit Line(dBμV/m)

For Peak Limit @ 2390MHz:

1. Level(dBμV/m)
= Antenna Factor(dB/m) + Path Loss(dB) + Read Level(dBμV) - Preamp Factor(dB)
= 32.22(dB/m) + 4.58(dB) + 54.51(dBμV) – 35.86 (dB)
= 55.45 (dBμV/m)
2. Over Limit(dB)
= Level(dBμV/m) – Limit Line(dBμV/m)
= 55.45(dBμV/m) – 74(dBμV/m)
= -18.55(dB)

For Average Limit @ 2390MHz:

1. Level(dBμV/m)
= Antenna Factor(dB/m) + Path Loss(dB) + Read Level(dBμV) - Preamp Factor(dB)
= 32.22(dB/m) + 4.58(dB) + 42.6(dBμV) – 35.86 (dB)
= 43.54 (dBμV/m)
2. Over Limit(dB)
= Level(dBμV/m) – Limit Line(dBμV/m)
= 43.54(dBμV/m) – 54(dBμV/m)
= -10.46(dB)

Both peak and average measured complies with the limit line, so test result is “PASS”.



Appendix D. Duty Cycle Plots

Band	Duty Cycle(%)	T(ms)	1/T(kHz)	VBW Setting
Bluetooth v4.2 LE	62.28	0.391	2.556	2.7KHz

Bluetooth v4.2 LE

