

SAR TEST REPORT



The following samples were submitted and identified on behalf of the client as:

Product Name Tablet
Brand Name SHARP
Prepared for SHARP CORPORATION
Company Address 2-13-1, HACHIHONMATSU-IIDA,
 HIGASHI-HIROSHIMA-SHI, HIROSHIMA PREFECTURE
 739-0192, JAPAN
 IEEE/ANSI C95.1-1992, IEEE 1528-2013,
 KDB616217D04v01r02,KDB865664D01v01r04,
Standards KDB865664D02v01r02,KDB941225D01v03r01,
 KDB941225D05v02r05,KDB447498D01v06,
 KDB248227D01v02r02
FCC ID APYHRO00284
Date of Receipt May. 15, 2020
Date of Test(s) May. 19, 2020 ~ Jun. 06, 2020
Date of Issue Jun. 16, 2020

In the configuration tested, the EUT complied with the standards specified above.

Remarks:

This report details the results of the testing carried out on one sample, the results contained in this test report do not relate to other samples of the same product. The manufacturer should ensure that all products in series production are in conformity with the product sample detailed in this report.

This report may only be reproduced and distributed in full. If the product in this report is used in any configuration other than that detailed in the report, the manufacturer must ensure the new system complies with all relevant standards. Any mention of SGS Taiwan Ltd. Central RF Lab or testing done by SGS Taiwan Ltd. Central RF Lab in connection with distribution or use of the product described in this report must be approved by SGS Taiwan Ltd. Central RF Lab in writing.

Signed on behalf of SGS

Clerk / Ruby Ou	Engineer / Bond Tsai	Asst. Manager / John Yeh
Ruby Ou	Bond Tsai	John Yeh

Date: Jun. 16, 2020

Unless otherwise stated the results shown in this test report refer only to the sample(s) tested and such sample(s) are retained for 90 days only.

除非另有說明，此報告結果僅對測試之樣品負責，同時此樣品僅保留90天。本報告未經本公司書面許可，不可部份複製。

This document is issued by the Company subject to its General Conditions of Service printed overleaf, available on request or accessible at <http://www.sgs.com.tw/Terms-and-Conditions>, and for electronic format documents, subject to Terms and Conditions for Electronic Documents at <http://www.sgs.com.tw/Terms-and-Conditions>. Attention is drawn to the limitation of liability, indemnification and jurisdiction issues defined therein. Any holder of this document is advised that information contained hereon reflects the Company's findings at the time of its intervention only and within the limits of Client's instructions, if any. The Company's sole responsibility is to its Client and this document does not exonerate parties to a transaction from exercising all their rights and obligations under the transaction documents. This document cannot be reproduced except in full, without prior written approval of the Company. Any unauthorized alteration, forgery or falsification of the content or appearance of this document is unlawful and offenders may be prosecuted to the fullest extent of the law.

Revision History

Report Number	Revision	Description	Issue Date
E5/2020/40009	Rev.00	Initial creation of document	Jun. 16, 2020

Unless otherwise stated the results shown in this test report refer only to the sample(s) tested and such sample(s) are retained for 90 days only.

除非另有說明，此報告結果僅對測試之樣品負責，同時此樣品僅保留90天。本報告未經本公司書面許可，不可部份複製。

This document is issued by the Company subject to its General Conditions of Service printed overleaf, available on request or accessible at <http://www.sgs.com.tw/Terms-and-Conditions> and for electronic format documents, subject to Terms and Conditions for Electronic Documents at <http://www.sgs.com.tw/Terms-and-Conditions>. Attention is drawn to the limitation of liability, indemnification and jurisdiction issues defined therein. Any holder of this document is advised that information contained hereon reflects the Company's findings at the time of its intervention only and within the limits of Client's instructions, if any. The Company's sole responsibility is to its Client and this document does not exonerate parties to a transaction from exercising all their rights and obligations under the transaction documents. This document cannot be reproduced except in full, without prior written approval of the Company. Any unauthorized alteration, forgery or falsification of the content or appearance of this document is unlawful and offenders may be prosecuted to the fullest extent of the law.

Contents

1. General Information	4
1.1 Testing Laboratory.....	4
1.2 Details of Applicant.....	4
1.3 Description of EUT.....	5
1.4 Test Environment.....	38
1.5 Operation Description.....	38
1.6 Proximity sensor operation description.....	40
1.7 The SAR Measurement System.....	65
1.8 System Components.....	67
1.9 SAR System Verification.....	69
1.0 Tissue Simulant Fluid for the Frequency Band.....	71
1.11 Evaluation Procedures.....	73
1.12 Probe Calibration Procedures.....	74
1.13 Test Standards and Limits.....	77
2. Summary of Results	79
2.1 Decision rules.....	79
2.2 Summary of Results.....	79
2.3 Reporting statements of conformity.....	83
3. Simultaneous Transmission Analysis	84
3.1 Estimated SAR calculation.....	85
3.2 SPLSR evaluation and analysis.....	85
4. Instruments List	95
5. Measurements	96
6. SAR System Performance Verification	114
7. Uncertainty Budget	119
Appendixes	121
E5202040009 SAR_Appendix A Photographs.....	121
E5202040009 SAR_Appendix B DAE & Probe Cal. Certificate.....	121
E5202040009 SAR_Appendix C Phantom Description & Dipole Cal. Certificate.....	121

Unless otherwise stated the results shown in this test report refer only to the sample(s) tested and such sample(s) are retained for 90 days only.

除非另有說明，此報告結果僅對測試之樣品負責，同時此樣品僅保留90天。本報告未經本公司書面許可，不可部份複製。

This document is issued by the Company subject to its General Conditions of Service printed overleaf, available on request or accessible at <http://www.sgs.com.tw/Terms-and-Conditions> and for electronic format documents, subject to Terms and Conditions for Electronic Documents at <http://www.sgs.com.tw/Terms-and-Conditions>. Attention is drawn to the limitation of liability, indemnification and jurisdiction issues defined therein. Any holder of this document is advised that information contained hereon reflects the Company's findings at the time of its intervention only and within the limits of Client's instructions, if any. The Company's sole responsibility is to its Client and this document does not exonerate parties to a transaction from exercising all their rights and obligations under the transaction documents. This document cannot be reproduced except in full, without prior written approval of the Company. Any unauthorized alteration, forgery or falsification of the content or appearance of this document is unlawful and offenders may be prosecuted to the fullest extent of the law.

1. General Information

1.1 Testing Laboratory

SGS Taiwan Ltd. Central RF Lab	
No. 2, Keji 1st Rd., Guishan Township, Taoyuan County, 33383, Taiwan	
Tel	+886-2-2299-3279
Fax	+886-2-2298-0488
Internet	http://www.tw.sgs.com/

1.2 Details of Applicant

Company Name	SHARP CORPORATION
Company Address	2-13-1, HACHIHONMATSU-IIDA, HIGASHI-HIROSHIMA-SHI, HIROSHIMA PREFECTURE 739-0192, JAPAN

Unless otherwise stated the results shown in this test report refer only to the sample(s) tested and such sample(s) are retained for 90 days only.

除非另有說明，此報告結果僅對測試之樣品負責，同時此樣品僅保留90天。本報告未經本公司書面許可，不可部份複製。

This document is issued by the Company subject to its General Conditions of Service printed overleaf, available on request or accessible at <http://www.sgs.com.tw/Terms-and-Conditions> and for electronic format documents, subject to Terms and Conditions for Electronic Documents at <http://www.sgs.com.tw/Terms-and-Conditions>. Attention is drawn to the limitation of liability, indemnification and jurisdiction issues defined therein. Any holder of this document is advised that information contained hereon reflects the Company's findings at the time of its intervention only and within the limits of Client's instructions, if any. The Company's sole responsibility is to its Client and this document does not exonerate parties to a transaction from exercising all their rights and obligations under the transaction documents. This document cannot be reproduced except in full, without prior written approval of the Company. Any unauthorized alteration, forgery or falsification of the content or appearance of this document is unlawful and offenders may be prosecuted to the fullest extent of the law.

SGS Taiwan Ltd. No.134,Wu Kung Road, New Taipei Industrial Park, Wuku District, New Taipei City, Taiwan/新北市五股區新北產業園區五工路 134 號

1.3 Description of EUT

Product Name	Tablet		
Brand Name	SHARP		
FCC ID	APYHRO00284		
Mode of Operation	<input checked="" type="checkbox"/> WCDMA <input checked="" type="checkbox"/> HSDPA <input checked="" type="checkbox"/> HSUPA <input checked="" type="checkbox"/> LTE FDD <input checked="" type="checkbox"/> WLAN802.11 a/b/g/n(20M)/ac(20M/40M/80M) <input checked="" type="checkbox"/> Bluetooth		
Duty Cycle	WCDMA	1	
	LTE FDD	1	
	WLAN802.11 a/b/g/n(20M)/ac(20M/40M/80M)	Refer to page 33-37	
	Bluetooth	76.8%	
TX Frequency Range (MHz)	WCDMA Band V	824	— 849
	LTE FDD Band 5	824	— 849
	WLAN802.11 b/g/n(20M)	2412	— 2462
	WLAN802.11 a/n(20M)/ac(20M) 5.2G	5180	— 5240
	WLAN802.11 n(40M)/ac(40M) 5.2G	5190	— 5230
	WLAN802.11 ac(80M) 5.2G	5210	
	WLAN802.11 a/n(20M)/ac(20M) 5.3G	5260	— 5320
	WLAN802.11 n(40M)/ac(40M) 5.3G	5270	— 5310
	WLAN802.11 ac(80M) 5.3G	5290	
	WLAN802.11 a/n/ac(20M) 5.6G	5500	— 5720
	WLAN802.11 n/ac(40M) 5.6G	5510	— 5710
	WLAN802.11 ac(80M) 5.6G	5530	— 5690
	Bluetooth	2402	— 2480
Channel Number (ARFCN)	WCDMA Band V	4132	— 4233
	LTE FDD Band 5	20407	— 20643
	WLAN802.11 b/g/n(20M)	1	— 11

Unless otherwise stated the results shown in this test report refer only to the sample(s) tested and such sample(s) are retained for 90 days only.

除非另有說明，此報告結果僅對測試之樣品負責，同時此樣品僅保留90天。本報告未經本公司書面許可，不可部份複製。

This document is issued by the Company subject to its General Conditions of Service printed overleaf, available on request or accessible at <http://www.sgs.com.tw/Terms-and-Conditions> and for electronic format documents, subject to Terms and Conditions for Electronic Documents at <http://www.sgs.com.tw/Terms-and-Conditions>. Attention is drawn to the limitation of liability, indemnification and jurisdiction issues defined therein. Any holder of this document is advised that information contained hereon reflects the Company's findings at the time of its intervention only and within the limits of Client's instructions, if any. The Company's sole responsibility is to its Client and this document does not exonerate parties to a transaction from exercising all their rights and obligations under the transaction documents. This document cannot be reproduced except in full, without prior written approval of the Company. Any unauthorized alteration, forgery or falsification of the content or appearance of this document is unlawful and offenders may be prosecuted to the fullest extent of the law.

SGS Taiwan Ltd. No.134,Wu Kung Road, New Taipei Industrial Park, Wuku District, New Taipei City, Taiwan/新北市五股區新北產業園區五工路 134 號

Channel Number (ARFCN)	WLAN802.11 a/n(20M)/ac(20M) 5.2G	36	—	48
	WLAN802.11 n(40M)/ac(40M) 5.2G	38	—	46
	WLAN802.11 ac(80M) 5.2G			42
	WLAN802.11 a/n(20M)/ac(20M) 5.3G	52	—	64
	WLAN802.11 n(40M)/ac(40M) 5.3G	54	—	62
	WLAN802.11 ac(80M) 5.3G			58
	WLAN802.11 a/n/ac(20M) 5.6G	100	—	144
	WLAN802.11 n/ac(40M) 5.6G	102	—	142
	WLAN802.11 ac(80M) 5.6G	106	—	138
	Bluetooth	0	—	78

Unless otherwise stated the results shown in this test report refer only to the sample(s) tested and such sample(s) are retained for 90 days only.

除非另有說明，此報告結果僅對測試之樣品負責，同時此樣品僅保留90天。本報告未經本公司書面許可，不可部份複製。

This document is issued by the Company subject to its General Conditions of Service printed overleaf, available on request or accessible at <http://www.sgs.com.tw/Terms-and-Conditions> and for electronic format documents, subject to Terms and Conditions for Electronic Documents at <http://www.sgs.com.tw/Terms-and-Conditions>. Attention is drawn to the limitation of liability, indemnification and jurisdiction issues defined therein. Any holder of this document is advised that information contained hereon reflects the Company's findings at the time of its intervention only and within the limits of Client's instructions, if any. The Company's sole responsibility is to its Client and this document does not exonerate parties to a transaction from exercising all their rights and obligations under the transaction documents. This document cannot be reproduced except in full, without prior written approval of the Company. Any unauthorized alteration, forgery or falsification of the content or appearance of this document is unlawful and offenders may be prosecuted to the fullest extent of the law.

Full power

Max. SAR (1g) (Unit: W/Kg)					
Antenna	Band	Measured	Reported	Channel	Position
WWAN	WCDMA Band V	1.13	1.37	4233	Back side
	LTE Band 5	1.13	1.13	20600	Back side

Max. SAR (1g) (Unit: W/Kg)					
Antenna	Band	Measured	Reported	Channel	Position
WIFI/BT	WLAN 802.11b	0.17	0.17	11	Back side
	WLAN 802.11g	0.41	0.44	1	Back side
	Bluetooth(GFSK)	0.00	0.00	78	Back side
	WLAN 802.11n(40M) 5.2G	1.09	1.25	46	Top side
	WLAN 802.11ac(40M) 5.2G	0.91	1.07	46	Top side
	WLAN 802.11n(40M) 5.3G	1.04	1.11	54	Top side
	WLAN 802.11ac(40M) 5.3G	0.98	1.07	54	Top side
	WLAN 802.11ac(80M) 5.6G	0.69	0.70	122	Top side

Unless otherwise stated the results shown in this test report refer only to the sample(s) tested and such sample(s) are retained for 90 days only.

除非另有說明，此報告結果僅對測試之樣品負責，同時此樣品僅保留90天。本報告未經本公司書面許可，不可部份複製。

This document is issued by the Company subject to its General Conditions of Service printed overleaf, available on request or accessible at <http://www.sgs.com.tw/Terms-and-Conditions> and for electronic format documents, subject to Terms and Conditions for Electronic Documents at <http://www.sgs.com.tw/Terms-and-Conditions>. Attention is drawn to the limitation of liability, indemnification and jurisdiction issues defined therein. Any holder of this document is advised that information contained hereon reflects the Company's findings at the time of its intervention only and within the limits of Client's instructions, if any. The Company's sole responsibility is to its Client and this document does not exonerate parties to a transaction from exercising all their rights and obligations under the transaction documents. This document cannot be reproduced except in full, without prior written approval of the Company. Any unauthorized alteration, forgery or falsification of the content or appearance of this document is unlawful and offenders may be prosecuted to the fullest extent of the law.

Reduced power

Max. SAR (1g) (Unit: W/Kg)					
Antenna	Band	Measured	Reported	Channel	Position
WWAN	WCDMA Band V	0.66	0.88	4233	Top side
	LTE Band 5	0.61	0.62	20600	Top side

Max. SAR (1g) (Unit: W/Kg)					
Antenna	Band	Measured	Reported	Channel	Position
WIFI/BT	WLAN 802.11b	0.59	0.59	6	Back side
	WLAN 802.11n(40M) 5.2G	0.78	0.80	46	Top side
	WLAN 802.11ac(80M) 5.2G	0.81	0.84	42	Top side
	WLAN 802.11n(40M) 5.3G	0.73	0.76	62	Top side
	WLAN 802.11ac(80M) 5.3G	0.83	0.86	58	Top side
	WLAN 802.11ac(80M) 5.6G	0.37	0.38	138	Top side

Simultaneous Transmission SAR (1g) (Unit: W/Kg)			
Antenna	mode	sum	Scenarios
WIFI/BT	DSS	0.88	Back side of WCDMA Band V + Bluetooth
	DTS	1.57	Back side of LTE Band 5 + 2.4GHz WLAN
	NII	1.48	Back side of LTE Band 5 + 5GHz WLAN

Unless otherwise stated the results shown in this test report refer only to the sample(s) tested and such sample(s) are retained for 90 days only.

除非另有說明，此報告結果僅對測試之樣品負責，同時此樣品僅保留90天。本報告未經本公司書面許可，不可部份複製。

This document is issued by the Company subject to its General Conditions of Service printed overleaf, available on request or accessible at <http://www.sgs.com.tw/Terms-and-Conditions> and for electronic format documents, subject to Terms and Conditions for Electronic Documents at <http://www.sgs.com.tw/Terms-and-Conditions>. Attention is drawn to the limitation of liability, indemnification and jurisdiction issues defined therein. Any holder of this document is advised that information contained hereon reflects the Company's findings at the time of its intervention only and within the limits of Client's instructions, if any. The Company's sole responsibility is to its Client and this document does not exonerate parties to a transaction from exercising all their rights and obligations under the transaction documents. This document cannot be reproduced except in full, without prior written approval of the Company. Any unauthorized alteration, forgery or falsification of the content or appearance of this document is unlawful and offenders may be prosecuted to the fullest extent of the law.

SGS Taiwan Ltd. No.134,Wu Kung Road, New Taipei Industrial Park, Wuku District, New Taipei City, Taiwan/新北市五股區新北產業園區五工路 134 號

WCDMA Band V - HSDPA / HSUPA Conducted power table (Full power):

Band		WCDMA V		
TX Channel		4132	4183	4233
Frequency (MHz)		826.4	836.6	846.6
Max. Rated Avg. Power+Max. Tolerance (dBm)		25.00		
3GPP Rel 99	RMC 12.2Kbps	24.21	24.27	24.16
3GPP Rel 5	HSDPA Subtest-1	21.18	21.25	21.07
	HSDPA Subtest-2	21.22	21.23	21.10
	HSDPA Subtest-3	21.20	21.28	21.13
	HSDPA Subtest-4	21.24	21.26	21.11
3GPP Rel 6	HSUPA Subtest-1	21.24	21.25	21.13
	HSUPA Subtest-2	20.73	20.75	20.69
	HSUPA Subtest-3	20.70	20.73	20.62
	HSUPA Subtest-4	20.79	20.74	20.70
	HSUPA Subtest-5	21.25	21.31	21.16

Unless otherwise stated the results shown in this test report refer only to the sample(s) tested and such sample(s) are retained for 90 days only.

除非另有說明，此報告結果僅對測試之樣品負責，同時此樣品僅保留90天。本報告未經本公司書面許可，不可部份複製。

This document is issued by the Company subject to its General Conditions of Service printed overleaf, available on request or accessible at <http://www.sgs.com.tw/Terms-and-Conditions> and for electronic format documents, subject to Terms and Conditions for Electronic Documents at <http://www.sgs.com.tw/Terms-and-Conditions>. Attention is drawn to the limitation of liability, indemnification and jurisdiction issues defined therein. Any holder of this document is advised that information contained hereon reflects the Company's findings at the time of its intervention only and within the limits of Client's instructions, if any. The Company's sole responsibility is to its Client and this document does not exonerate parties to a transaction from exercising all their rights and obligations under the transaction documents. This document cannot be reproduced except in full, without prior written approval of the Company. Any unauthorized alteration, forgery or falsification of the content or appearance of this document is unlawful and offenders may be prosecuted to the fullest extent of the law.

SGS Taiwan Ltd. No.134,Wu Kung Road, New Taipei Industrial Park, Wuku District, New Taipei City, Taiwan/新北市五股區新北產業園區五工路 134 號

WCDMA Band V - HSDPA / HSUPA Conducted power table (Reduced power):

Band		WCDMA V		
TX Channel		4132	4183	4233
Frequency (MHz)		826.4	836.6	846.6
Max. Rated Avg. Power+Max. Tolerance (dBm)		16.50		
3GPP Rel 99	RMC 12.2Kbps	15.13	15.14	15.23
3GPP Rel 5	HSDPA Subtest-1	12.09	12.07	12.07
	HSDPA Subtest-2	12.11	12.07	12.16
	HSDPA Subtest-3	12.08	12.12	12.12
	HSDPA Subtest-4	12.13	12.05	12.14
3GPP Rel 6	HSUPA Subtest-1	12.10	12.11	12.14
	HSUPA Subtest-2	11.61	11.61	11.69
	HSUPA Subtest-3	11.59	11.57	11.61
	HSUPA Subtest-4	11.69	11.54	11.71
	HSUPA Subtest-5	12.08	12.14	12.25

Unless otherwise stated the results shown in this test report refer only to the sample(s) tested and such sample(s) are retained for 90 days only.

除非另有說明，此報告結果僅對測試之樣品負責，同時此樣品僅保留90天。本報告未經本公司書面許可，不可部份複製。

This document is issued by the Company subject to its General Conditions of Service printed overleaf, available on request or accessible at <http://www.sgs.com.tw/Terms-and-Conditions> and for electronic format documents, subject to Terms and Conditions for Electronic Documents at <http://www.sgs.com.tw/Terms-and-Conditions>. Attention is drawn to the limitation of liability, indemnification and jurisdiction issues defined therein. Any holder of this document is advised that information contained hereon reflects the Company's findings at the time of its intervention only and within the limits of Client's instructions, if any. The Company's sole responsibility is to its Client and this document does not exonerate parties to a transaction from exercising all their rights and obligations under the transaction documents. This document cannot be reproduced except in full, without prior written approval of the Company. Any unauthorized alteration, forgery or falsification of the content or appearance of this document is unlawful and offenders may be prosecuted to the fullest extent of the law.

LTE FDD Band 5 - conducted power table (Full power):

FDD Band 5									
BW(Mhz)	Modulation	RB Size	RB Offset	Frequency (MHz)	Channel	Conducted power (dBm)	Target Power + Max. Tolerance (dBm)	MPR Allowed per 3GPP(dB)	
10	QPSK	1 RB	0	829	20450	24.91	25	0	
				836.5	20525	24.93	25	0	
				844	20600	24.99	25	0	
			25	829	20450	24.95	25	0	
				836.5	20525	24.97	25	0	
				844	20600	24.98	25	0	
			49	829	20450	24.92	25	0	
				836.5	20525	24.96	25	0	
				844	20600	24.93	25	0	
		25 RB	0	829	20450	23.90	24	0-1	
				836.5	20525	23.94	24	0-1	
				844	20600	23.92	24	0-1	
			12	829	20450	23.91	24	0-1	
				836.5	20525	23.93	24	0-1	
				844	20600	23.95	24	0-1	
			25	829	20450	23.96	24	0-1	
				836.5	20525	23.87	24	0-1	
				844	20600	23.86	24	0-1	
			50RB	829	20450	23.88	24	0-1	
				836.5	20525	23.91	24	0-1	
				844	20600	23.89	24	0-1	
		16-QAM	1 RB	0	829	20450	23.88	24	0-1
					836.5	20525	23.92	24	0-1
					844	20600	23.99	24	0-1
				25	829	20450	23.87	24	0-1
					836.5	20525	23.97	24	0-1
					844	20600	23.96	24	0-1
				49	829	20450	23.85	24	0-1
					836.5	20525	23.98	24	0-1
					844	20600	23.81	24	0-1
	25 RB			0	829	20450	22.95	23	0-2
					836.5	20525	22.99	23	0-2
					844	20600	22.91	23	0-2
			12	829	20450	22.97	23	0-2	
				836.5	20525	23.00	23	0-2	
				844	20600	22.94	23	0-2	
			25	829	20450	22.98	23	0-2	
				836.5	20525	22.94	23	0-2	
				844	20600	22.86	23	0-2	
			500RB	829	20450	22.93	23	0-2	
				836.5	20525	22.96	23	0-2	
				844	20600	22.91	23	0-2	

Unless otherwise stated the results shown in this test report refer only to the sample(s) tested and such sample(s) are retained for 90 days only.

除非另有說明，此報告結果僅對測試之樣品負責，同時此樣品僅保留90天。本報告未經本公司書面許可，不可部份複製。

This document is issued by the Company subject to its General Conditions of Service printed overleaf, available on request or accessible at <http://www.sgs.com.tw/Terms-and-Conditions> and for electronic format documents, subject to Terms and Conditions for Electronic Documents at <http://www.sgs.com.tw/Terms-and-Conditions>. Attention is drawn to the limitation of liability, indemnification and jurisdiction issues defined therein. Any holder of this document is advised that information contained hereon reflects the Company's findings at the time of its intervention only and within the limits of Client's instructions, if any. The Company's sole responsibility is to its Client and this document does not exonerate parties to a transaction from exercising all their rights and obligations under the transaction documents. This document cannot be reproduced except in full, without prior written approval of the Company. Any unauthorized alteration, forgery or falsification of the content or appearance of this document is unlawful and offenders may be prosecuted to the fullest extent of the law.

FDD Band 5								
BW(Mhz)	Modulation	RB Size	RB Offset	Frequency (MHz)	Channel	Conducted power (dBm)	Target Power + Max. Tolerance (dBm)	MPR Allowed per 3GPP(dB)
10	64-QAM	1 RB	0	829	20450	23.98	24	0-1
				836.5	20525	23.90	24	0-1
				844	20600	23.90	24	0-1
			25	829	20450	23.77	24	0-1
				836.5	20525	23.94	24	0-1
				844	20600	23.88	24	0-1
			49	829	20450	23.80	24	0-1
				836.5	20525	23.90	24	0-1
				844	20600	23.81	24	0-1
		25 RB	0	829	20450	22.85	23	0-2
				836.5	20525	22.96	23	0-2
				844	20600	22.82	23	0-2
			12	829	20450	22.90	23	0-2
				836.5	20525	22.99	23	0-2
				844	20600	22.91	23	0-2
			25	829	20450	22.89	23	0-2
				836.5	20525	22.88	23	0-2
				844	20600	22.77	23	0-2
			500RB	829	20450	22.91	23	0-2
				836.5	20525	22.93	23	0-2
				844	20600	22.82	23	0-2

Unless otherwise stated the results shown in this test report refer only to the sample(s) tested and such sample(s) are retained for 90 days only.

除非另有說明，此報告結果僅對測試之樣品負責，同時此樣品僅保留90天。本報告未經本公司書面許可，不可部份複製。

This document is issued by the Company subject to its General Conditions of Service printed overleaf, available on request or accessible at <http://www.sgs.com.tw/Terms-and-Conditions> and for electronic format documents, subject to Terms and Conditions for Electronic Documents at <http://www.sgs.com.tw/Terms-and-Conditions>. Attention is drawn to the limitation of liability, indemnification and jurisdiction issues defined therein. Any holder of this document is advised that information contained hereon reflects the Company's findings at the time of its intervention only and within the limits of Client's instructions, if any. The Company's sole responsibility is to its Client and this document does not exonerate parties to a transaction from exercising all their rights and obligations under the transaction documents. This document cannot be reproduced except in full, without prior written approval of the Company. Any unauthorized alteration, forgery or falsification of the content or appearance of this document is unlawful and offenders may be prosecuted to the fullest extent of the law.

FDD Band 5									
BW(Mhz)	Modulation	RB Size	RB Offset	Frequency (MHz)	Channel	Conducted power (dBm)	Target Power + Max. Tolerance (dBm)	MPR Allowed per 3GPP(dB)	
5	QPSK	1 RB	0	826.5	20425	24.90	25	0	
				836.5	20525	24.89	25	0	
				846.5	20625	24.96	25	0	
			12	826.5	20425	24.88	25	0	
				836.5	20525	24.96	25	0	
				846.5	20625	24.93	25	0	
			24	826.5	20425	24.91	25	0	
				836.5	20525	24.92	25	0	
				846.5	20625	24.90	25	0	
		12 RB	0	826.5	20425	23.80	24	0-1	
				836.5	20525	23.86	24	0-1	
				846.5	20625	23.83	24	0-1	
			6	826.5	20425	23.85	24	0-1	
				836.5	20525	23.92	24	0-1	
				846.5	20625	23.89	24	0-1	
			13	826.5	20425	23.89	24	0-1	
				836.5	20525	23.79	24	0-1	
				846.5	20625	23.79	24	0-1	
		25RB	826.5	20425	23.83	24	0-1		
			836.5	20525	23.91	24	0-1		
			846.5	20625	23.86	24	0-1		
		16-QAM	1 RB	0	826.5	20425	23.80	24	0-1
					836.5	20525	23.92	24	0-1
					846.5	20625	23.92	24	0-1
	12			826.5	20425	23.78	24	0-1	
				836.5	20525	23.96	24	0-1	
				846.5	20625	23.87	24	0-1	
	24			826.5	20425	23.84	24	0-1	
				836.5	20525	23.97	24	0-1	
				846.5	20625	23.78	24	0-1	
	12 RB			0	826.5	20425	22.89	23	0-2
					836.5	20525	22.98	23	0-2
					846.5	20625	22.89	23	0-2
			6	826.5	20425	22.88	23	0-2	
				836.5	20525	22.99	23	0-2	
				846.5	20625	22.93	23	0-2	
			13	826.5	20425	22.96	23	0-2	
				836.5	20525	22.87	23	0-2	
				846.5	20625	22.83	23	0-2	
	25RB		826.5	20425	22.92	23	0-2		
			836.5	20525	22.87	23	0-2		
			846.5	20625	22.83	23	0-2		

Unless otherwise stated the results shown in this test report refer only to the sample(s) tested and such sample(s) are retained for 90 days only.

除非另有說明，此報告結果僅對測試之樣品負責，同時此樣品僅保留90天。本報告未經本公司書面許可，不可部份複製。

This document is issued by the Company subject to its General Conditions of Service printed overleaf, available on request or accessible at <http://www.sgs.com.tw/Terms-and-Conditions> and for electronic format documents, subject to Terms and Conditions for Electronic Documents at <http://www.sgs.com.tw/Terms-and-Conditions>. Attention is drawn to the limitation of liability, indemnification and jurisdiction issues defined therein. Any holder of this document is advised that information contained hereon reflects the Company's findings at the time of its intervention only and within the limits of Client's instructions, if any. The Company's sole responsibility is to its Client and this document does not exonerate parties to a transaction from exercising all their rights and obligations under the transaction documents. This document cannot be reproduced except in full, without prior written approval of the Company. Any unauthorized alteration, forgery or falsification of the content or appearance of this document is unlawful and offenders may be prosecuted to the fullest extent of the law.

SGS Taiwan Ltd. No.134,Wu Kung Road, New Taipei Industrial Park, Wuku District, New Taipei City, Taiwan/新北市五股區新北產業園區五工路 134 號

FDD Band 5								
BW(Mhz)	Modulation	RB Size	RB Offset	Frequency (MHz)	Channel	Conducted power (dBm)	Target Power + Max. Tolerance (dBm)	MPR Allowed per 3GPP(dB)
5	64-QAM	1 RB	0	826.5	20425	23.97	24	0-1
				836.5	20525	23.89	24	0-1
				846.5	20625	23.90	24	0-1
			12	826.5	20425	23.70	24	0-1
				836.5	20525	23.86	24	0-1
				846.5	20625	23.83	24	0-1
			24	826.5	20425	23.79	24	0-1
				836.5	20525	23.87	24	0-1
				846.5	20625	23.78	24	0-1
		12 RB	0	826.5	20425	22.76	23	0-2
				836.5	20525	22.91	23	0-2
				846.5	20625	22.79	23	0-2
			6	826.5	20425	22.82	23	0-2
				836.5	20525	22.90	23	0-2
				846.5	20625	22.85	23	0-2
			13	826.5	20425	22.81	23	0-2
				836.5	20525	22.80	23	0-2
				846.5	20625	22.70	23	0-2
		25RB	826.5	20425	22.84	23	0-2	
			836.5	20525	22.86	23	0-2	
			846.5	20625	22.77	23	0-2	

Unless otherwise stated the results shown in this test report refer only to the sample(s) tested and such sample(s) are retained for 90 days only.

除非另有說明，此報告結果僅對測試之樣品負責，同時此樣品僅保留90天。本報告未經本公司書面許可，不可部份複製。

This document is issued by the Company subject to its General Conditions of Service printed overleaf, available on request or accessible at <http://www.sgs.com.tw/Terms-and-Conditions> and for electronic format documents, subject to Terms and Conditions for Electronic Documents at <http://www.sgs.com.tw/Terms-and-Conditions>. Attention is drawn to the limitation of liability, indemnification and jurisdiction issues defined therein. Any holder of this document is advised that information contained hereon reflects the Company's findings at the time of its intervention only and within the limits of Client's instructions, if any. The Company's sole responsibility is to its Client and this document does not exonerate parties to a transaction from exercising all their rights and obligations under the transaction documents. This document cannot be reproduced except in full, without prior written approval of the Company. Any unauthorized alteration, forgery or falsification of the content or appearance of this document is unlawful and offenders may be prosecuted to the fullest extent of the law.

FDD Band 5									
BW(Mhz)	Modulation	RB Size	RB Offset	Frequency (MHz)	Channel	Conducted power (dBm)	Target Power + Max. Tolerance (dBm)	MPR Allowed per 3GPP(dB)	
3	QPSK	1 RB	0	825.5	20415	24.88	25	0	
				836.5	20525	24.85	25	0	
				847.5	20635	24.94	25	0	
			7	825.5	20415	24.83	25	0	
				836.5	20525	24.91	25	0	
				847.5	20635	24.88	25	0	
		14	825.5	20415	24.85	25	0		
			836.5	20525	24.84	25	0		
			847.5	20635	24.86	25	0		
		8 RB	0	825.5	20415	23.75	24	0-1	
				836.5	20525	23.82	24	0-1	
				847.5	20635	23.78	24	0-1	
			4	825.5	20415	23.82	24	0-1	
				836.5	20525	23.85	24	0-1	
				847.5	20635	23.82	24	0-1	
			7	825.5	20415	23.85	24	0-1	
				836.5	20525	23.78	24	0-1	
				847.5	20635	23.73	24	0-1	
			15RB	825.5	20415	23.83	24	0-1	
				836.5	20525	23.84	24	0-1	
				847.5	20635	23.85	24	0-1	
		16-QAM	1 RB	0	825.5	20415	23.79	24	0-1
					836.5	20525	23.90	24	0-1
					847.5	20635	23.92	24	0-1
	7			825.5	20415	23.76	24	0-1	
				836.5	20525	23.91	24	0-1	
				847.5	20635	23.86	24	0-1	
	14			825.5	20415	23.76	24	0-1	
				836.5	20525	23.95	24	0-1	
				847.5	20635	23.70	24	0-1	
	8 RB			0	825.5	20415	22.82	23	0-2
					836.5	20525	22.93	23	0-2
					847.5	20635	22.82	23	0-2
			4	825.5	20415	22.86	23	0-2	
				836.5	20525	22.96	23	0-2	
				847.5	20635	22.91	23	0-2	
			7	825.5	20415	22.89	23	0-2	
				836.5	20525	22.86	23	0-2	
				847.5	20635	22.76	23	0-2	
	15RB		825.5	20415	22.90	23	0-2		
			836.5	20525	22.85	23	0-2		
			847.5	20635	22.79	23	0-2		

Unless otherwise stated the results shown in this test report refer only to the sample(s) tested and such sample(s) are retained for 90 days only.

除非另有說明，此報告結果僅對測試之樣品負責，同時此樣品僅保留90天。本報告未經本公司書面許可，不可部份複製。

This document is issued by the Company subject to its General Conditions of Service printed overleaf, available on request or accessible at <http://www.sgs.com.tw/Terms-and-Conditions> and for electronic format documents, subject to Terms and Conditions for Electronic Documents at <http://www.sgs.com.tw/Terms-and-Conditions>. Attention is drawn to the limitation of liability, indemnification and jurisdiction issues defined therein. Any holder of this document is advised that information contained hereon reflects the Company's findings at the time of its intervention only and within the limits of Client's instructions, if any. The Company's sole responsibility is to its Client and this document does not exonerate parties to a transaction from exercising all their rights and obligations under the transaction documents. This document cannot be reproduced except in full, without prior written approval of the Company. Any unauthorized alteration, forgery or falsification of the content or appearance of this document is unlawful and offenders may be prosecuted to the fullest extent of the law.

FDD Band 5								
BW(Mhz)	Modulation	RB Size	RB Offset	Frequency (MHz)	Channel	Conducted power (dBm)	Target Power + Max. Tolerance (dBm)	MPR Allowed per 3GPP(dB)
3	64-QAM	1 RB	0	825.5	20415	23.95	24	0-1
				836.5	20525	23.89	24	0-1
				847.5	20635	23.90	24	0-1
			7	825.5	20415	23.64	24	0-1
				836.5	20525	23.84	24	0-1
				847.5	20635	23.80	24	0-1
			14	825.5	20415	23.75	24	0-1
				836.5	20525	23.79	24	0-1
				847.5	20635	23.73	24	0-1
		8 RB	0	825.5	20415	22.71	23	0-2
				836.5	20525	22.88	23	0-2
				847.5	20635	22.78	23	0-2
			4	825.5	20415	22.81	23	0-2
				836.5	20525	22.85	23	0-2
				847.5	20635	22.83	23	0-2
			7	825.5	20415	22.74	23	0-2
				836.5	20525	22.74	23	0-2
				847.5	20635	22.63	23	0-2
		15RB	825.5	20415	22.77	23	0-2	
			836.5	20525	22.85	23	0-2	
			847.5	20635	22.72	23	0-2	

Unless otherwise stated the results shown in this test report refer only to the sample(s) tested and such sample(s) are retained for 90 days only.

除非另有說明，此報告結果僅對測試之樣品負責，同時此樣品僅保留90天。本報告未經本公司書面許可，不可部份複製。

This document is issued by the Company subject to its General Conditions of Service printed overleaf, available on request or accessible at <http://www.sgs.com.tw/Terms-and-Conditions> and for electronic format documents, subject to Terms and Conditions for Electronic Documents at <http://www.sgs.com.tw/Terms-and-Conditions>. Attention is drawn to the limitation of liability, indemnification and jurisdiction issues defined therein. Any holder of this document is advised that information contained hereon reflects the Company's findings at the time of its intervention only and within the limits of Client's instructions, if any. The Company's sole responsibility is to its Client and this document does not exonerate parties to a transaction from exercising all their rights and obligations under the transaction documents. This document cannot be reproduced except in full, without prior written approval of the Company. Any unauthorized alteration, forgery or falsification of the content or appearance of this document is unlawful and offenders may be prosecuted to the fullest extent of the law.

FDD Band 5									
BW(Mhz)	Modulation	RB Size	RB Offset	Frequency (MHz)	Channel	Conducted power (dBm)	Target Power + Max. Tolerance (dBm)	MPR Allowed per 3GPP(dB)	
1.4	QPSK	1 RB	0	824.7	20407	24.82	25	0	
				836.5	20525	24.83	25	0	
				848.3	20643	24.91	25	0	
			2	824.7	20407	24.81	25	0	
				836.5	20525	24.89	25	0	
				848.3	20643	24.87	25	0	
		5	824.7	20407	24.87	25	0		
			836.5	20525	24.88	25	0		
			848.3	20643	24.83	25	0		
		3 RB	0	824.7	20407	23.73	24	0-1	
				836.5	20525	23.75	24	0-1	
				848.3	20643	23.78	24	0-1	
			2	824.7	20407	23.75	24	0-1	
				836.5	20525	23.80	24	0-1	
				848.3	20643	23.79	24	0-1	
			3	824.7	20407	23.81	24	0-1	
				836.5	20525	23.74	24	0-1	
				848.3	20643	23.71	24	0-1	
			6RB	824.7	20407	23.77	24	0-1	
				836.5	20525	23.82	24	0-1	
				848.3	20643	23.75	24	0-1	
		16-QAM	1 RB	0	824.7	20407	23.70	24	0-1
					836.5	20525	23.85	24	0-1
					848.3	20643	23.83	24	0-1
	2			824.7	20407	23.73	24	0-1	
				836.5	20525	23.86	24	0-1	
				848.3	20643	23.77	24	0-1	
	5			824.7	20407	23.75	24	0-1	
				836.5	20525	23.89	24	0-1	
				848.3	20643	23.73	24	0-1	
	3 RB			0	824.7	20407	22.83	23	0-2
					836.5	20525	22.87	23	0-2
					848.3	20643	22.79	23	0-2
			2	824.7	20407	22.80	23	0-2	
				836.5	20525	22.91	23	0-2	
				848.3	20643	22.87	23	0-2	
			3	824.7	20407	22.85	23	0-2	
				836.5	20525	22.80	23	0-2	
				848.3	20643	22.71	23	0-2	
			6RB	824.7	20407	22.84	23	0-2	
				836.5	20525	22.77	23	0-2	
				848.3	20643	22.78	23	0-2	

Unless otherwise stated the results shown in this test report refer only to the sample(s) tested and such sample(s) are retained for 90 days only.

除非另有說明，此報告結果僅對測試之樣品負責，同時此樣品僅保留90天。本報告未經本公司書面許可，不可部份複製。

This document is issued by the Company subject to its General Conditions of Service printed overleaf, available on request or accessible at <http://www.sgs.com.tw/Terms-and-Conditions> and for electronic format documents, subject to Terms and Conditions for Electronic Documents at <http://www.sgs.com.tw/Terms-and-Conditions>. Attention is drawn to the limitation of liability, indemnification and jurisdiction issues defined therein. Any holder of this document is advised that information contained hereon reflects the Company's findings at the time of its intervention only and within the limits of Client's instructions, if any. The Company's sole responsibility is to its Client and this document does not exonerate parties to a transaction from exercising all their rights and obligations under the transaction documents. This document cannot be reproduced except in full, without prior written approval of the Company. Any unauthorized alteration, forgery or falsification of the content or appearance of this document is unlawful and offenders may be prosecuted to the fullest extent of the law.

FDD Band 5								
BW(Mhz)	Modulation	RB Size	RB Offset	Frequency (MHz)	Channel	Conducted power (dBm)	Target Power + Max. Tolerance (dBm)	MPR Allowed per 3GPP(dB)
1.4	64-QAM	1 RB	0	824.7	20407	23.90	24	0-1
				836.5	20525	23.78	24	0-1
				848.3	20643	23.83	24	0-1
			2	824.7	20407	23.66	24	0-1
				836.5	20525	23.77	24	0-1
				848.3	20643	23.75	24	0-1
			5	824.7	20407	23.74	24	0-1
				836.5	20525	23.79	24	0-1
				848.3	20643	23.69	24	0-1
		3 RB	0	824.7	20407	22.70	23	0-2
				836.5	20525	22.79	23	0-2
				848.3	20643	22.72	23	0-2
			2	824.7	20407	22.75	23	0-2
				836.5	20525	22.86	23	0-2
				848.3	20643	22.76	23	0-2
			3	824.7	20407	22.75	23	0-2
				836.5	20525	22.72	23	0-2
				848.3	20643	22.62	23	0-2
			6RB	824.7	20407	22.79	23	0-2
				836.5	20525	22.82	23	0-2
				848.3	20643	22.66	23	0-2

Unless otherwise stated the results shown in this test report refer only to the sample(s) tested and such sample(s) are retained for 90 days only.

除非另有說明，此報告結果僅對測試之樣品負責，同時此樣品僅保留90天。本報告未經本公司書面許可，不可部份複製。

This document is issued by the Company subject to its General Conditions of Service printed overleaf, available on request or accessible at <http://www.sgs.com.tw/Terms-and-Conditions> and for electronic format documents, subject to Terms and Conditions for Electronic Documents at <http://www.sgs.com.tw/Terms-and-Conditions>. Attention is drawn to the limitation of liability, indemnification and jurisdiction issues defined therein. Any holder of this document is advised that information contained hereon reflects the Company's findings at the time of its intervention only and within the limits of Client's instructions, if any. The Company's sole responsibility is to its Client and this document does not exonerate parties to a transaction from exercising all their rights and obligations under the transaction documents. This document cannot be reproduced except in full, without prior written approval of the Company. Any unauthorized alteration, forgery or falsification of the content or appearance of this document is unlawful and offenders may be prosecuted to the fullest extent of the law.

LTE FDD Band 5 - conducted power table (Reduced power):

FDD Band 5									
BW(Mhz)	Modulation	RB Size	RB Offset	Frequency (MHz)	Channel	Conducted power (dBm)	Target Power + Max. Tolerance (dBm)	MPR Allowed per 3GPP(dB)	
10	QPSK	1 RB	0	829	20450	16.27	16.5	0	
				836.5	20525	16.20	16.5	0	
				844	20600	16.37	16.5	0	
			25	829	20450	16.33	16.5	0	
				836.5	20525	16.36	16.5	0	
				844	20600	16.39	16.5	0	
			49	829	20450	16.38	16.5	0	
				836.5	20525	16.34	16.5	0	
				844	20600	16.28	16.5	0	
			25 RB	0	829	20450	16.03	16.5	0-1
					836.5	20525	16.04	16.5	0-1
					844	20600	16.07	16.5	0-1
		12		829	20450	15.96	16.5	0-1	
				836.5	20525	16.07	16.5	0-1	
				844	20600	16.08	16.5	0-1	
		25		829	20450	16.05	16.5	0-1	
				836.5	20525	15.99	16.5	0-1	
				844	20600	16.02	16.5	0-1	
		50RB		829	20450	16.02	16.5	0-1	
				836.5	20525	16.06	16.5	0-1	
				844	20600	15.99	16.5	0-1	
		16-QAM	1 RB	0	829	20450	16.27	16.5	0-1
					836.5	20525	16.29	16.5	0-1
					844	20600	16.35	16.5	0-1
	25			829	20450	16.35	16.5	0-1	
				836.5	20525	16.33	16.5	0-1	
				844	20600	16.29	16.5	0-1	
	49			829	20450	16.36	16.5	0-1	
				836.5	20525	16.32	16.5	0-1	
				844	20600	16.22	16.5	0-1	
	25 RB			0	829	20450	16.13	16.5	0-2
					836.5	20525	16.16	16.5	0-2
					844	20600	16.17	16.5	0-2
			12	829	20450	16.16	16.5	0-2	
				836.5	20525	16.17	16.5	0-2	
				844	20600	16.16	16.5	0-2	
			25	829	20450	16.15	16.5	0-2	
				836.5	20525	16.14	16.5	0-2	
				844	20600	16.12	16.5	0-2	
			500RB	829	20450	16.13	16.5	0-2	
				836.5	20525	16.18	16.5	0-2	
				844	20600	16.16	16.5	0-2	

Unless otherwise stated the results shown in this test report refer only to the sample(s) tested and such sample(s) are retained for 90 days only.

除非另有說明，此報告結果僅對測試之樣品負責，同時此樣品僅保留90天。本報告未經本公司書面許可，不可部份複製。

This document is issued by the Company subject to its General Conditions of Service printed overleaf, available on request or accessible at <http://www.sgs.com.tw/Terms-and-Conditions> and for electronic format documents, subject to Terms and Conditions for Electronic Documents at <http://www.sgs.com.tw/Terms-and-Conditions>. Attention is drawn to the limitation of liability, indemnification and jurisdiction issues defined therein. Any holder of this document is advised that information contained hereon reflects the Company's findings at the time of its intervention only and within the limits of Client's instructions, if any. The Company's sole responsibility is to its Client and this document does not exonerate parties to a transaction from exercising all their rights and obligations under the transaction documents. This document cannot be reproduced except in full, without prior written approval of the Company. Any unauthorized alteration, forgery or falsification of the content or appearance of this document is unlawful and offenders may be prosecuted to the fullest extent of the law.

FDD Band 5								
BW(Mhz)	Modulation	RB Size	RB Offset	Frequency (MHz)	Channel	Conducted power (dBm)	Target Power + Max. Tolerance (dBm)	MPR Allowed per 3GPP(dB)
10	64-QAM	1 RB	0	829	20450	16.26	16.5	0-1
				836.5	20525	16.27	16.5	0-1
				844	20600	16.33	16.5	0-1
			25	829	20450	16.34	16.5	0-1
				836.5	20525	16.32	16.5	0-1
				844	20600	16.29	16.5	0-1
			49	829	20450	16.31	16.5	0-1
				836.5	20525	16.31	16.5	0-1
				844	20600	16.20	16.5	0-1
		25 RB	0	829	20450	16.13	16.5	0-2
				836.5	20525	16.15	16.5	0-2
				844	20600	16.12	16.5	0-2
			12	829	20450	16.14	16.5	0-2
				836.5	20525	16.15	16.5	0-2
				844	20600	16.16	16.5	0-2
			25	829	20450	16.14	16.5	0-2
				836.5	20525	16.11	16.5	0-2
				844	20600	16.08	16.5	0-2
			500RB	829	20450	16.09	16.5	0-2
				836.5	20525	16.16	16.5	0-2
				844	20600	16.11	16.5	0-2

Unless otherwise stated the results shown in this test report refer only to the sample(s) tested and such sample(s) are retained for 90 days only.

除非另有說明，此報告結果僅對測試之樣品負責，同時此樣品僅保留90天。本報告未經本公司書面許可，不可部份複製。

This document is issued by the Company subject to its General Conditions of Service printed overleaf, available on request or accessible at <http://www.sgs.com.tw/Terms-and-Conditions> and for electronic format documents, subject to Terms and Conditions for Electronic Documents at <http://www.sgs.com.tw/Terms-and-Conditions>. Attention is drawn to the limitation of liability, indemnification and jurisdiction issues defined therein. Any holder of this document is advised that information contained hereon reflects the Company's findings at the time of its intervention only and within the limits of Client's instructions, if any. The Company's sole responsibility is to its Client and this document does not exonerate parties to a transaction from exercising all their rights and obligations under the transaction documents. This document cannot be reproduced except in full, without prior written approval of the Company. Any unauthorized alteration, forgery or falsification of the content or appearance of this document is unlawful and offenders may be prosecuted to the fullest extent of the law.

FDD Band 5									
BW(Mhz)	Modulation	RB Size	RB Offset	Frequency (MHz)	Channel	Conducted power (dBm)	Target Power + Max. Tolerance (dBm)	MPR Allowed per 3GPP(dB)	
5	QPSK	1 RB	0	826.5	20425	16.22	16.5	0	
				836.5	20525	16.15	16.5	0	
				846.5	20625	16.33	16.5	0	
			12	826.5	20425	16.29	16.5	0	
				836.5	20525	16.34	16.5	0	
				846.5	20625	16.35	16.5	0	
		24	826.5	20425	16.36	16.5	0		
			836.5	20525	16.31	16.5	0		
			846.5	20625	16.24	16.5	0		
		12 RB	0	826.5	20425	15.98	16.5	0-1	
				836.5	20525	16.03	16.5	0-1	
				846.5	20625	16.05	16.5	0-1	
			6	826.5	20425	15.96	16.5	0-1	
				836.5	20525	16.04	16.5	0-1	
				846.5	20625	16.06	16.5	0-1	
			13	826.5	20425	16.01	16.5	0-1	
				836.5	20525	15.98	16.5	0-1	
				846.5	20625	15.97	16.5	0-1	
			25RB	826.5	20425	16.01	16.5	0-1	
				836.5	20525	16.05	16.5	0-1	
				846.5	20625	15.98	16.5	0-1	
		16-QAM	1 RB	0	826.5	20425	16.24	16.5	0-1
					836.5	20525	16.25	16.5	0-1
					846.5	20625	16.31	16.5	0-1
	12			826.5	20425	16.33	16.5	0-1	
				836.5	20525	16.30	16.5	0-1	
				846.5	20625	16.28	16.5	0-1	
	24			826.5	20425	16.35	16.5	0-1	
				836.5	20525	16.32	16.5	0-1	
				846.5	20625	16.19	16.5	0-1	
	12 RB			0	826.5	20425	16.11	16.5	0-2
					836.5	20525	16.15	16.5	0-2
					846.5	20625	16.16	16.5	0-2
			6	826.5	20425	16.13	16.5	0-2	
				836.5	20525	16.16	16.5	0-2	
				846.5	20625	16.14	16.5	0-2	
			13	826.5	20425	16.11	16.5	0-2	
				836.5	20525	16.12	16.5	0-2	
				846.5	20625	16.09	16.5	0-2	
			25RB	826.5	20425	16.10	16.5	0-2	
				836.5	20525	16.17	16.5	0-2	
				846.5	20625	16.12	16.5	0-2	

Unless otherwise stated the results shown in this test report refer only to the sample(s) tested and such sample(s) are retained for 90 days only.

除非另有說明，此報告結果僅對測試之樣品負責，同時此樣品僅保留90天。本報告未經本公司書面許可，不可部份複製。

This document is issued by the Company subject to its General Conditions of Service printed overleaf, available on request or accessible at <http://www.sgs.com.tw/Terms-and-Conditions> and for electronic format documents, subject to Terms and Conditions for Electronic Documents at <http://www.sgs.com.tw/Terms-and-Conditions>. Attention is drawn to the limitation of liability, indemnification and jurisdiction issues defined therein. Any holder of this document is advised that information contained hereon reflects the Company's findings at the time of its intervention only and within the limits of Client's instructions, if any. The Company's sole responsibility is to its Client and this document does not exonerate parties to a transaction from exercising all their rights and obligations under the transaction documents. This document cannot be reproduced except in full, without prior written approval of the Company. Any unauthorized alteration, forgery or falsification of the content or appearance of this document is unlawful and offenders may be prosecuted to the fullest extent of the law.

FDD Band 5								
BW(Mhz)	Modulation	RB Size	RB Offset	Frequency (MHz)	Channel	Conducted power (dBm)	Target Power + Max. Tolerance (dBm)	MPR Allowed per 3GPP(dB)
5	64-QAM	1 RB	0	826.5	20425	16.25	16.5	0-1
				836.5	20525	16.25	16.5	0-1
				846.5	20625	16.29	16.5	0-1
			12	826.5	20425	16.32	16.5	0-1
				836.5	20525	16.29	16.5	0-1
				846.5	20625	16.28	16.5	0-1
			24	826.5	20425	16.31	16.5	0-1
				836.5	20525	16.27	16.5	0-1
				846.5	20625	16.17	16.5	0-1
		12 RB	0	826.5	20425	16.09	16.5	0-2
				836.5	20525	16.10	16.5	0-2
				846.5	20625	16.12	16.5	0-2
			6	826.5	20425	16.12	16.5	0-2
				836.5	20525	16.13	16.5	0-2
				846.5	20625	16.14	16.5	0-2
			13	826.5	20425	16.13	16.5	0-2
				836.5	20525	16.09	16.5	0-2
				846.5	20625	16.05	16.5	0-2
		25RB	826.5	20425	16.07	16.5	0-2	
			836.5	20525	16.16	16.5	0-2	
			846.5	20625	16.08	16.5	0-2	

Unless otherwise stated the results shown in this test report refer only to the sample(s) tested and such sample(s) are retained for 90 days only.

除非另有說明，此報告結果僅對測試之樣品負責，同時此樣品僅保留90天。本報告未經本公司書面許可，不可部份複製。

This document is issued by the Company subject to its General Conditions of Service printed overleaf, available on request or accessible at <http://www.sgs.com.tw/Terms-and-Conditions> and for electronic format documents, subject to Terms and Conditions for Electronic Documents at <http://www.sgs.com.tw/Terms-and-Conditions>. Attention is drawn to the limitation of liability, indemnification and jurisdiction issues defined therein. Any holder of this document is advised that information contained hereon reflects the Company's findings at the time of its intervention only and within the limits of Client's instructions, if any. The Company's sole responsibility is to its Client and this document does not exonerate parties to a transaction from exercising all their rights and obligations under the transaction documents. This document cannot be reproduced except in full, without prior written approval of the Company. Any unauthorized alteration, forgery or falsification of the content or appearance of this document is unlawful and offenders may be prosecuted to the fullest extent of the law.

FDD Band 5									
BW(Mhz)	Modulation	RB Size	RB Offset	Frequency (MHz)	Channel	Conducted power (dBm)	Target Power + Max. Tolerance (dBm)	MPR Allowed per 3GPP(dB)	
3	QPSK	1 RB	0	825.5	20415	16.23	16.5	0	
				836.5	20525	16.19	16.5	0	
				847.5	20635	16.36	16.5	0	
			7	825.5	20415	16.33	16.5	0	
				836.5	20525	16.33	16.5	0	
				847.5	20635	16.38	16.5	0	
		14	825.5	20415	16.34	16.5	0		
			836.5	20525	16.32	16.5	0		
			847.5	20635	16.27	16.5	0		
		8 RB	0	825.5	20415	16.01	16.5	0-1	
				836.5	20525	16.01	16.5	0-1	
				847.5	20635	16.04	16.5	0-1	
			4	825.5	20415	15.94	16.5	0-1	
				836.5	20525	16.06	16.5	0-1	
				847.5	20635	16.08	16.5	0-1	
			7	825.5	20415	16.04	16.5	0-1	
				836.5	20525	15.95	16.5	0-1	
				847.5	20635	16.01	16.5	0-1	
			15RB	825.5	20415	16.00	16.5	0-1	
				836.5	20525	16.03	16.5	0-1	
				847.5	20635	15.96	16.5	0-1	
		16-QAM	1 RB	0	825.5	20415	16.24	16.5	0-1
					836.5	20525	16.25	16.5	0-1
					847.5	20635	16.33	16.5	0-1
	7			825.5	20415	16.30	16.5	0-1	
				836.5	20525	16.29	16.5	0-1	
				847.5	20635	16.25	16.5	0-1	
	14			825.5	20415	16.32	16.5	0-1	
				836.5	20525	16.31	16.5	0-1	
				847.5	20635	16.19	16.5	0-1	
	8 RB			0	825.5	20415	16.11	16.5	0-2
					836.5	20525	16.12	16.5	0-2
					847.5	20635	16.14	16.5	0-2
			4	825.5	20415	16.13	16.5	0-2	
				836.5	20525	16.13	16.5	0-2	
				847.5	20635	16.12	16.5	0-2	
	7		825.5	20415	16.13	16.5	0-2		
			836.5	20525	16.10	16.5	0-2		
			847.5	20635	16.10	16.5	0-2		
	15RB		825.5	20415	16.11	16.5	0-2		
			836.5	20525	16.15	16.5	0-2		
			847.5	20635	16.12	16.5	0-2		

Unless otherwise stated the results shown in this test report refer only to the sample(s) tested and such sample(s) are retained for 90 days only.

除非另有說明，此報告結果僅對測試之樣品負責，同時此樣品僅保留90天。本報告未經本公司書面許可，不可部份複製。

This document is issued by the Company subject to its General Conditions of Service printed overleaf, available on request or accessible at <http://www.sgs.com.tw/Terms-and-Conditions> and for electronic format documents, subject to Terms and Conditions for Electronic Documents at <http://www.sgs.com.tw/Terms-and-Conditions>. Attention is drawn to the limitation of liability, indemnification and jurisdiction issues defined therein. Any holder of this document is advised that information contained hereon reflects the Company's findings at the time of its intervention only and within the limits of Client's instructions, if any. The Company's sole responsibility is to its Client and this document does not exonerate parties to a transaction from exercising all their rights and obligations under the transaction documents. This document cannot be reproduced except in full, without prior written approval of the Company. Any unauthorized alteration, forgery or falsification of the content or appearance of this document is unlawful and offenders may be prosecuted to the fullest extent of the law.

FDD Band 5								
BW(Mhz)	Modulation	RB Size	RB Offset	Frequency (MHz)	Channel	Conducted power (dBm)	Target Power + Max. Tolerance (dBm)	MPR Allowed per 3GPP(dB)
3	64-QAM	1 RB	0	825.5	20415	16.26	16.5	0-1
				836.5	20525	16.23	16.5	0-1
				847.5	20635	16.32	16.5	0-1
			7	825.5	20415	16.34	16.5	0-1
				836.5	20525	16.31	16.5	0-1
				847.5	20635	16.25	16.5	0-1
			14	825.5	20415	16.27	16.5	0-1
				836.5	20525	16.30	16.5	0-1
				847.5	20635	16.16	16.5	0-1
		8 RB	0	825.5	20415	16.08	16.5	0-2
				836.5	20525	16.14	16.5	0-2
				847.5	20635	16.11	16.5	0-2
			4	825.5	20415	16.14	16.5	0-2
				836.5	20525	16.14	16.5	0-2
				847.5	20635	16.13	16.5	0-2
			7	825.5	20415	16.14	16.5	0-2
				836.5	20525	16.08	16.5	0-2
				847.5	20635	16.07	16.5	0-2
		15RB	825.5	20415	16.07	16.5	0-2	
			836.5	20525	16.12	16.5	0-2	
			847.5	20635	16.11	16.5	0-2	

Unless otherwise stated the results shown in this test report refer only to the sample(s) tested and such sample(s) are retained for 90 days only.

除非另有說明，此報告結果僅對測試之樣品負責，同時此樣品僅保留90天。本報告未經本公司書面許可，不可部份複製。

This document is issued by the Company subject to its General Conditions of Service printed overleaf, available on request or accessible at <http://www.sgs.com.tw/Terms-and-Conditions> and for electronic format documents, subject to Terms and Conditions for Electronic Documents at <http://www.sgs.com.tw/Terms-and-Conditions>. Attention is drawn to the limitation of liability, indemnification and jurisdiction issues defined therein. Any holder of this document is advised that information contained hereon reflects the Company's findings at the time of its intervention only and within the limits of Client's instructions, if any. The Company's sole responsibility is to its Client and this document does not exonerate parties to a transaction from exercising all their rights and obligations under the transaction documents. This document cannot be reproduced except in full, without prior written approval of the Company. Any unauthorized alteration, forgery or falsification of the content or appearance of this document is unlawful and offenders may be prosecuted to the fullest extent of the law.

FDD Band 5									
BW(Mhz)	Modulation	RB Size	RB Offset	Frequency (MHz)	Channel	Conducted power (dBm)	Target Power + Max. Tolerance (dBm)	MPR Allowed per 3GPP(dB)	
1.4	QPSK	1 RB	0	824.7	20407	16.24	16.5	0	
				836.5	20525	16.17	16.5	0	
				848.3	20643	16.33	16.5	0	
			2	824.7	20407	16.33	16.5	0	
				836.5	20525	16.34	16.5	0	
				848.3	20643	16.36	16.5	0	
		5	824.7	20407	16.33	16.5	0		
			836.5	20525	16.34	16.5	0		
			848.3	20643	16.25	16.5	0		
		3 RB	0	824.7	20407	16.00	16.5	0-1	
				836.5	20525	16.03	16.5	0-1	
				848.3	20643	16.02	16.5	0-1	
			2	824.7	20407	15.95	16.5	0-1	
				836.5	20525	16.06	16.5	0-1	
				848.3	20643	16.06	16.5	0-1	
		3	824.7	20407	16.03	16.5	0-1		
			836.5	20525	15.98	16.5	0-1		
			848.3	20643	16.01	16.5	0-1		
		6RB	824.7	20407	16.00	16.5	0-1		
			836.5	20525	16.04	16.5	0-1		
			848.3	20643	15.96	16.5	0-1		
		16-QAM	1 RB	0	824.7	20407	16.26	16.5	0-1
					836.5	20525	16.25	16.5	0-1
					848.3	20643	16.32	16.5	0-1
	2			824.7	20407	16.32	16.5	0-1	
				836.5	20525	16.28	16.5	0-1	
				848.3	20643	16.29	16.5	0-1	
	5			824.7	20407	16.32	16.5	0-1	
				836.5	20525	16.27	16.5	0-1	
				848.3	20643	16.17	16.5	0-1	
	3 RB			0	824.7	20407	16.10	16.5	0-2
					836.5	20525	16.16	16.5	0-2
					848.3	20643	16.12	16.5	0-2
			2	824.7	20407	16.15	16.5	0-2	
				836.5	20525	16.16	16.5	0-2	
				848.3	20643	16.15	16.5	0-2	
	3		824.7	20407	16.12	16.5	0-2		
			836.5	20525	16.11	16.5	0-2		
			848.3	20643	16.09	16.5	0-2		
	6RB		824.7	20407	16.13	16.5	0-2		
			836.5	20525	16.15	16.5	0-2		
			848.3	20643	16.11	16.5	0-2		

Unless otherwise stated the results shown in this test report refer only to the sample(s) tested and such sample(s) are retained for 90 days only.

除非另有說明，此報告結果僅對測試之樣品負責，同時此樣品僅保留90天。本報告未經本公司書面許可，不可部份複製。

This document is issued by the Company subject to its General Conditions of Service printed overleaf, available on request or accessible at <http://www.sgs.com.tw/Terms-and-Conditions> and for electronic format documents, subject to Terms and Conditions for Electronic Documents at <http://www.sgs.com.tw/Terms-and-Conditions>. Attention is drawn to the limitation of liability, indemnification and jurisdiction issues defined therein. Any holder of this document is advised that information contained hereon reflects the Company's findings at the time of its intervention only and within the limits of Client's instructions, if any. The Company's sole responsibility is to its Client and this document does not exonerate parties to a transaction from exercising all their rights and obligations under the transaction documents. This document cannot be reproduced except in full, without prior written approval of the Company. Any unauthorized alteration, forgery or falsification of the content or appearance of this document is unlawful and offenders may be prosecuted to the fullest extent of the law.

FDD Band 5								
BW(Mhz)	Modulation	RB Size	RB Offset	Frequency (MHz)	Channel	Conducted power (dBm)	Target Power + Max. Tolerance (dBm)	MPR Allowed per 3GPP(dB)
1.4	64-QAM	1 RB	0	824.7	20407	16.23	16.5	0-1
				836.5	20525	16.23	16.5	0-1
				848.3	20643	16.29	16.5	0-1
			2	824.7	20407	16.33	16.5	0-1
				836.5	20525	16.30	16.5	0-1
				848.3	20643	16.27	16.5	0-1
			5	824.7	20407	16.29	16.5	0-1
				836.5	20525	16.27	16.5	0-1
				848.3	20643	16.17	16.5	0-1
		3 RB	0	824.7	20407	16.12	16.5	0-2
				836.5	20525	16.14	16.5	0-2
				848.3	20643	16.09	16.5	0-2
			2	824.7	20407	16.14	16.5	0-2
				836.5	20525	16.13	16.5	0-2
				848.3	20643	16.16	16.5	0-2
			3	824.7	20407	16.09	16.5	0-2
				836.5	20525	16.10	16.5	0-2
				848.3	20643	16.04	16.5	0-2
		6RB	824.7	20407	16.06	16.5	0-2	
			836.5	20525	16.11	16.5	0-2	
			848.3	20643	16.09	16.5	0-2	

Unless otherwise stated the results shown in this test report refer only to the sample(s) tested and such sample(s) are retained for 90 days only.

除非另有說明，此報告結果僅對測試之樣品負責，同時此樣品僅保留90天。本報告未經本公司書面許可，不可部份複製。

This document is issued by the Company subject to its General Conditions of Service printed overleaf, available on request or accessible at <http://www.sgs.com.tw/Terms-and-Conditions> and for electronic format documents, subject to Terms and Conditions for Electronic Documents at <http://www.sgs.com.tw/Terms-and-Conditions>. Attention is drawn to the limitation of liability, indemnification and jurisdiction issues defined therein. Any holder of this document is advised that information contained hereon reflects the Company's findings at the time of its intervention only and within the limits of Client's instructions, if any. The Company's sole responsibility is to its Client and this document does not exonerate parties to a transaction from exercising all their rights and obligations under the transaction documents. This document cannot be reproduced except in full, without prior written approval of the Company. Any unauthorized alteration, forgery or falsification of the content or appearance of this document is unlawful and offenders may be prosecuted to the fullest extent of the law.

WLAN802.11 a/b/g/n(20M)/ac(20M/40M/80M) conducted power table :
Full power:

WIFI/BT						
Band	Mode	Channel	Frequency (MHz)	Data Rate	Max. Rated Avg. Power + Max. Tolerance (dBm)	Average power (dBm)
2450 MHz	802.11b	1	2412	1Mbps	12.50	12.23
		6	2437		12.50	12.16
		11	2462		14.50	14.36
	802.11g	1	2412	6Mbps	19.00	18.79
		6	2437		19.00	18.59
		11	2462		18.00	17.57
	802.11n20-HT0	1	2412	MCS0	19.00	18.71
		6	2437		19.00	18.50
		11	2462		17.50	17.44

WIFI/BT						
Band	Mode	Channel	Frequency (MHz)	Data Rate	Max. Rated Avg. Power + Max. Tolerance (dBm)	Average power (dBm)
5.15-5.25 GHz	802.11a	36	5180	6Mbps	19.00	18.98
		44	5220		19.00	18.80
		48	5240		19.00	18.97
	802.11n20-HT0	36	5180	MCS0	19.00	18.97
		44	5220		19.00	18.61
		48	5240		19.00	18.98
	802.11ac20-VHT0	36	5180	MCS0	19.00	18.61
		44	5220		19.00	18.55
		48	5240		19.00	18.86
	802.11n40-HT0	38	5190	MCS0	12.50	12.31
		46	5230		19.00	18.45
	802.11ac40-VHT0	38	5190	MCS0	12.50	12.17
		46	5230		19.00	18.33
	802.11ac80-VHT0	42	5210	MCS0	11.50	11.49

Unless otherwise stated the results shown in this test report refer only to the sample(s) tested and such sample(s) are retained for 90 days only.

除非另有說明，此報告結果僅對測試之樣品負責，同時此樣品僅保留90天。本報告未經本公司書面許可，不可部份複製。

This document is issued by the Company subject to its General Conditions of Service printed overleaf, available on request or accessible at <http://www.sgs.com.tw/Terms-and-Conditions> and for electronic format documents, subject to Terms and Conditions for Electronic Documents at <http://www.sgs.com.tw/Terms-and-Conditions>. Attention is drawn to the limitation of liability, indemnification and jurisdiction issues defined therein. Any holder of this document is advised that information contained hereon reflects the Company's findings at the time of its intervention only and within the limits of Client's instructions, if any. The Company's sole responsibility is to its Client and this document does not exonerate parties to a transaction from exercising all their rights and obligations under the transaction documents. This document cannot be reproduced except in full, without prior written approval of the Company. Any unauthorized alteration, forgery or falsification of the content or appearance of this document is unlawful and offenders may be prosecuted to the fullest extent of the law.

WIFI/BT						
Band	Mode	Channel	Frequency (MHz)	Data Rate	Max. Rated Avg. Power + Max. Tolerance (dBm)	Average power (dBm)
5.25-5.35 GHz	802.11a	52	5260	6Mbps	19.00	18.96
		60	5300		19.00	18.22
		64	5320		19.00	18.86
	802.11n20-HT0	52	5260	MCS0	19.00	18.94
		60	5300		19.00	18.27
		64	5320		19.00	18.75
	802.11ac20-VHT0	52	5260	MCS0	19.00	18.90
		60	5300		19.00	18.06
		64	5320		19.00	18.62
	802.11n40-HT0	54	5270	MCS0	19.00	18.76
		62	5310		14.50	14.29
	802.11ac40-VHT0	54	5270	MCS0	19.00	18.67
62		5310	14.50		14.16	
802.11ac80-VHT0	58	5290	MCS0	13.00	12.66	

WIFI/BT						
Band	Mode	Channel	Frequency (MHz)	Data Rate	Max. Rated Avg. Power + Max. Tolerance (dBm)	Average power (dBm)
5600 MHz	802.11a	100	5500	6Mbps	19.00	18.95
		116	5580		19.00	18.98
		140	5700		19.00	18.63
		144	5720		19.00	18.99
	802.11n20-HT0	100	5500	MCS0	19.00	18.96
		116	5580		19.00	18.99
		140	5700		19.00	18.51
		144	5720		19.00	18.98
	802.11ac20-VHT0	100	5500	MCS0	19.00	18.85
		116	5580		19.00	18.93
		140	5700		19.00	18.49
		144	5720		19.00	18.94
	802.11n40-HT0	102	5510	MCS0	15.50	15.12
		110	5550		19.00	18.70
		134	5670		19.00	18.62
		142	5710		19.00	18.98
	802.11ac40-VHT0	102	5510	MCS0	15.00	14.99
		110	5550		19.00	18.67
		134	5670		19.00	18.55
		142	5710		19.00	18.95
	802.11ac80-VHT0	106	5530	MCS0	14.00	13.54
		122	5610		19.00	18.98
		138	5690		19.00	18.96

Unless otherwise stated the results shown in this test report refer only to the sample(s) tested and such sample(s) are retained for 90 days only.

除非另有說明，此報告結果僅對測試之樣品負責，同時此樣品僅保留90天。本報告未經本公司書面許可，不可部份複製。

This document is issued by the Company subject to its General Conditions of Service printed overleaf, available on request or accessible at <http://www.sgs.com.tw/Terms-and-Conditions> and for electronic format documents, subject to Terms and Conditions for Electronic Documents at <http://www.sgs.com.tw/Terms-and-Conditions>. Attention is drawn to the limitation of liability, indemnification and jurisdiction issues defined therein. Any holder of this document is advised that information contained hereon reflects the Company's findings at the time of its intervention only and within the limits of Client's instructions, if any. The Company's sole responsibility is to its Client and this document does not exonerate parties to a transaction from exercising all their rights and obligations under the transaction documents. This document cannot be reproduced except in full, without prior written approval of the Company. Any unauthorized alteration, forgery or falsification of the content or appearance of this document is unlawful and offenders may be prosecuted to the fullest extent of the law.

SGS Taiwan Ltd. No.134,Wu Kung Road, New Taipei Industrial Park, Wuku District, New Taipei City, Taiwan/新北市五股區新北產業園區五工路 134 號

Reduced power:

WIFI/BT						
Band	Mode	Channel	Frequency (MHz)	Data Rate	Max. Rated Avg. Power + Max. Tolerance (dBm)	Average power (dBm)
2450 MHz	802.11b	1	2412	1Mbps	11.50	11.30
		6	2437		11.50	11.47
		11	2462		11.50	11.33
	802.11g	1	2412	6Mbps	11.50	11.21
		6	2437		11.50	11.29
		11	2462		11.50	11.32
	802.11n20-HT0	1	2412	MCS0	11.50	11.36
		6	2437		11.50	11.40
		11	2462		11.50	11.41

WIFI/BT						
Band	Mode	Channel	Frequency (MHz)	Data Rate	Max. Rated Avg. Power + Max. Tolerance (dBm)	Average power (dBm)
5.15-5.25 GHz	802.11a	36	5180	6Mbps	7.50	7.06
		44	5220		7.50	7.13
		48	5240		7.50	7.09
	802.11n20-HT0	36	5180	MCS0	7.50	7.20
		44	5220		7.50	7.24
		48	5240		7.50	7.33
	802.11ac20-VHT0	36	5180	MCS0	7.50	7.36
		44	5220		7.50	7.15
		48	5240		7.50	7.37
	802.11n40-HT0	38	5190	MCS0	7.50	7.13
		46	5230		7.50	7.45
	802.11ac40-VHT0	38	5190	MCS0	7.50	7.27
		46	5230		7.50	7.21
	802.11ac80-VHT0	42	5210	MCS0	7.50	7.43

Unless otherwise stated the results shown in this test report refer only to the sample(s) tested and such sample(s) are retained for 90 days only.

除非另有說明，此報告結果僅對測試之樣品負責，同時此樣品僅保留90天。本報告未經本公司書面許可，不可部份複製。

This document is issued by the Company subject to its General Conditions of Service printed overleaf, available on request or accessible at <http://www.sgs.com.tw/Terms-and-Conditions> and for electronic format documents, subject to Terms and Conditions for Electronic Documents at <http://www.sgs.com.tw/Terms-and-Conditions>. Attention is drawn to the limitation of liability, indemnification and jurisdiction issues defined therein. Any holder of this document is advised that information contained hereon reflects the Company's findings at the time of its intervention only and within the limits of Client's instructions, if any. The Company's sole responsibility is to its Client and this document does not exonerate parties to a transaction from exercising all their rights and obligations under the transaction documents. This document cannot be reproduced except in full, without prior written approval of the Company. Any unauthorized alteration, forgery or falsification of the content or appearance of this document is unlawful and offenders may be prosecuted to the fullest extent of the law.

WIFI/BT						
Band	Mode	Channel	Frequency (MHz)	Data Rate	Max. Rated Avg. Power + Max. Tolerance (dBm)	Average power (dBm)
5.25-5.35 GHz	802.11a	52	5260	6Mbps	7.50	7.11
		60	5300		7.50	7.38
		64	5320		7.50	7.40
	802.11n20-HT0	52	5260	MCS0	7.50	7.46
		60	5300		7.50	7.33
		64	5320		7.50	7.31
	802.11ac20-VHT0	52	5260	MCS0	7.50	7.22
		60	5300		7.50	7.26
		64	5320		7.50	7.23
	802.11n40-HT0	54	5270	MCS0	7.50	7.30
		62	5310		7.50	7.37
	802.11ac40-VHT0	54	5270	MCS0	7.50	7.25
		62	5310		7.50	7.28
	802.11ac80-VHT0	58	5290	MCS0	7.50	7.40

WIFI/BT						
Band	Mode	Channel	Frequency (MHz)	Data Rate	Max. Rated Avg. Power + Max. Tolerance (dBm)	Average power (dBm)
5600 MHz	802.11a	100	5500	6Mbps	7.50	7.44
		116	5580		7.50	7.37
		140	5700		7.50	7.10
		144	5720		7.50	7.34
	802.11n20-HT0	100	5500	MCS0	7.50	7.27
		116	5580		7.50	7.21
		140	5700		7.50	7.15
		144	5720		7.50	7.17
	802.11ac20-VHT0	100	5500	MCS0	7.50	7.26
		116	5580		7.50	7.39
		140	5700		7.50	7.41
	802.11n40-HT0	102	5510	MCS0	7.50	7.09
		110	5550		7.50	7.12
		134	5670		7.50	7.04
		142	5710		7.50	7.31
	802.11ac40-VHT0	102	5510	MCS0	7.50	7.36
		110	5550		7.50	7.06
		134	5670		7.50	7.18
		142	5710		7.50	7.22
	802.11ac80-VHT0	106	5530	MCS0	7.50	7.33
		122	5610		7.50	7.45
		138	5690		7.50	7.49

Unless otherwise stated the results shown in this test report refer only to the sample(s) tested and such sample(s) are retained for 90 days only.

除非另有說明，此報告結果僅對測試之樣品負責，同時此樣品僅保留90天。本報告未經本公司書面許可，不可部份複製。

This document is issued by the Company subject to its General Conditions of Service printed overleaf, available on request or accessible at <http://www.sgs.com.tw/Terms-and-Conditions> and for electronic format documents, subject to Terms and Conditions for Electronic Documents at <http://www.sgs.com.tw/Terms-and-Conditions>. Attention is drawn to the limitation of liability, indemnification and jurisdiction issues defined therein. Any holder of this document is advised that information contained hereon reflects the Company's findings at the time of its intervention only and within the limits of Client's instructions, if any. The Company's sole responsibility is to its Client and this document does not exonerate parties to a transaction from exercising all their rights and obligations under the transaction documents. This document cannot be reproduced except in full, without prior written approval of the Company. Any unauthorized alteration, forgery or falsification of the content or appearance of this document is unlawful and offenders may be prosecuted to the fullest extent of the law.

SGS Taiwan Ltd. No.134,Wu Kung Road, New Taipei Industrial Park, Wuku District, New Taipei City, Taiwan/新北市五股區新北產業園區五工路 134 號

Bluetooth conducted power table:

Mode	Channel	Frequency (MHz)	Average power (dBm)			Max. Rated Avg. Power + Max. Tolerance (dBm)
			1Mbps	2Mbps	3Mbps	
BR/EDR	CH 00	2402	8.57	8.36	8.38	9.50
	CH 39	2441	8.91	8.58	8.60	
	CH 78	2480	9.18	8.78	8.80	
Mode	Channel	Frequency (MHz)	GFSK			
			Max. Rated Avg.Power + Max. Tolerance (dBm)	Average Output Power (dBm)		
LE	CH 00	2402	5	4.14		
	CH 19	2442		4.66		
	CH 39	2480		4.99		

Unless otherwise stated the results shown in this test report refer only to the sample(s) tested and such sample(s) are retained for 90 days only.

除非另有說明，此報告結果僅對測試之樣品負責，同時此樣品僅保留90天。本報告未經本公司書面許可，不可部份複製。

This document is issued by the Company subject to its General Conditions of Service printed overleaf, available on request or accessible at <http://www.sgs.com.tw/Terms-and-Conditions> and for electronic format documents, subject to Terms and Conditions for Electronic Documents at <http://www.sgs.com.tw/Terms-and-Conditions>. Attention is drawn to the limitation of liability, indemnification and jurisdiction issues defined therein. Any holder of this document is advised that information contained hereon reflects the Company's findings at the time of its intervention only and within the limits of Client's instructions, if any. The Company's sole responsibility is to its Client and this document does not exonerate parties to a transaction from exercising all their rights and obligations under the transaction documents. This document cannot be reproduced except in full, without prior written approval of the Company. Any unauthorized alteration, forgery or falsification of the content or appearance of this document is unlawful and offenders may be prosecuted to the fullest extent of the law.

BT_duty(2.88/3.75=0.768)

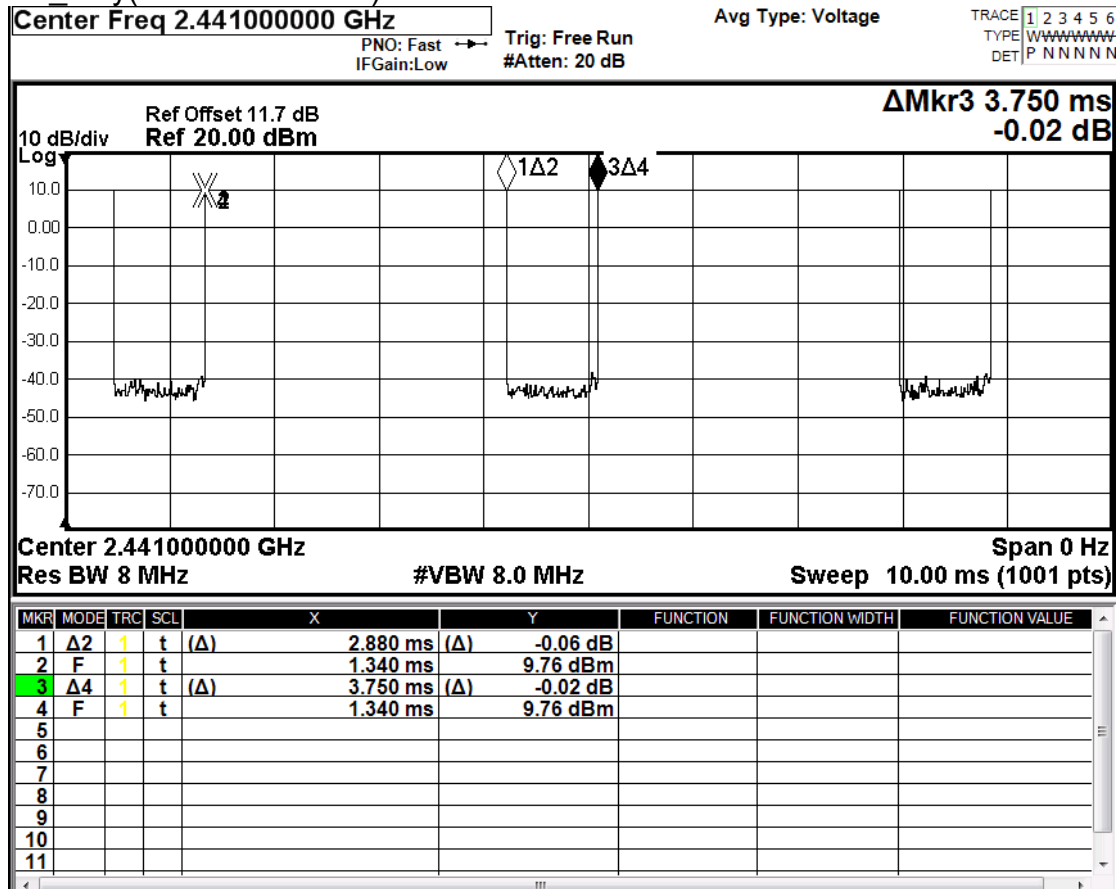

Unless otherwise stated the results shown in this test report refer only to the sample(s) tested and such sample(s) are retained for 90 days only.

除非另有說明，此報告結果僅對測試之樣品負責，同時此樣品僅保留90天。本報告未經本公司書面許可，不可部份複製。

This document is issued by the Company subject to its General Conditions of Service printed overleaf, available on request or accessible at <http://www.sgs.com.tw/Terms-and-Conditions> and for electronic format documents, subject to Terms and Conditions for Electronic Documents at <http://www.sgs.com.tw/Terms-and-Conditions>. Attention is drawn to the limitation of liability, indemnification and jurisdiction issues defined therein. Any holder of this document is advised that information contained hereon reflects the Company's findings at the time of its intervention only and within the limits of Client's instructions, if any. The Company's sole responsibility is to its Client and this document does not exonerate parties to a transaction from exercising all their rights and obligations under the transaction documents. This document cannot be reproduced except in full, without prior written approval of the Company. Any unauthorized alteration, forgery or falsification of the content or appearance of this document is unlawful and offenders may be prosecuted to the fullest extent of the law.

2.4G b_duty (8.34/8.38=0.995)

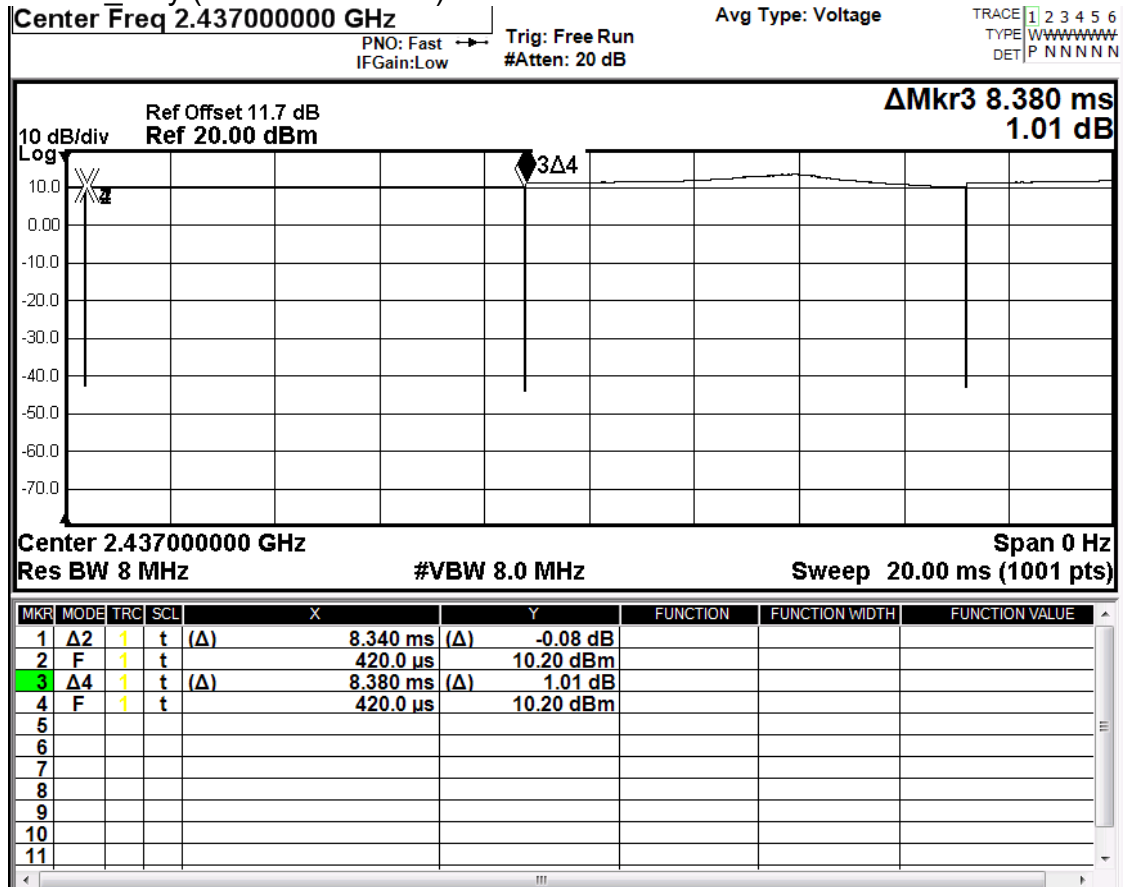

Unless otherwise stated the results shown in this test report refer only to the sample(s) tested and such sample(s) are retained for 90 days only.

除非另有說明，此報告結果僅對測試之樣品負責，同時此樣品僅保留90天。本報告未經本公司書面許可，不可部份複製。

This document is issued by the Company subject to its General Conditions of Service printed overleaf, available on request or accessible at <http://www.sgs.com.tw/Terms-and-Conditions> and for electronic format documents, subject to Terms and Conditions for Electronic Documents at <http://www.sgs.com.tw/Terms-and-Conditions>. Attention is drawn to the limitation of liability, indemnification and jurisdiction issues defined therein. Any holder of this document is advised that information contained hereon reflects the Company's findings at the time of its intervention only and within the limits of Client's instructions, if any. The Company's sole responsibility is to its Client and this document does not exonerate parties to a transaction from exercising all their rights and obligations under the transaction documents. This document cannot be reproduced except in full, without prior written approval of the Company. Any unauthorized alteration, forgery or falsification of the content or appearance of this document is unlawful and offenders may be prosecuted to the fullest extent of the law.

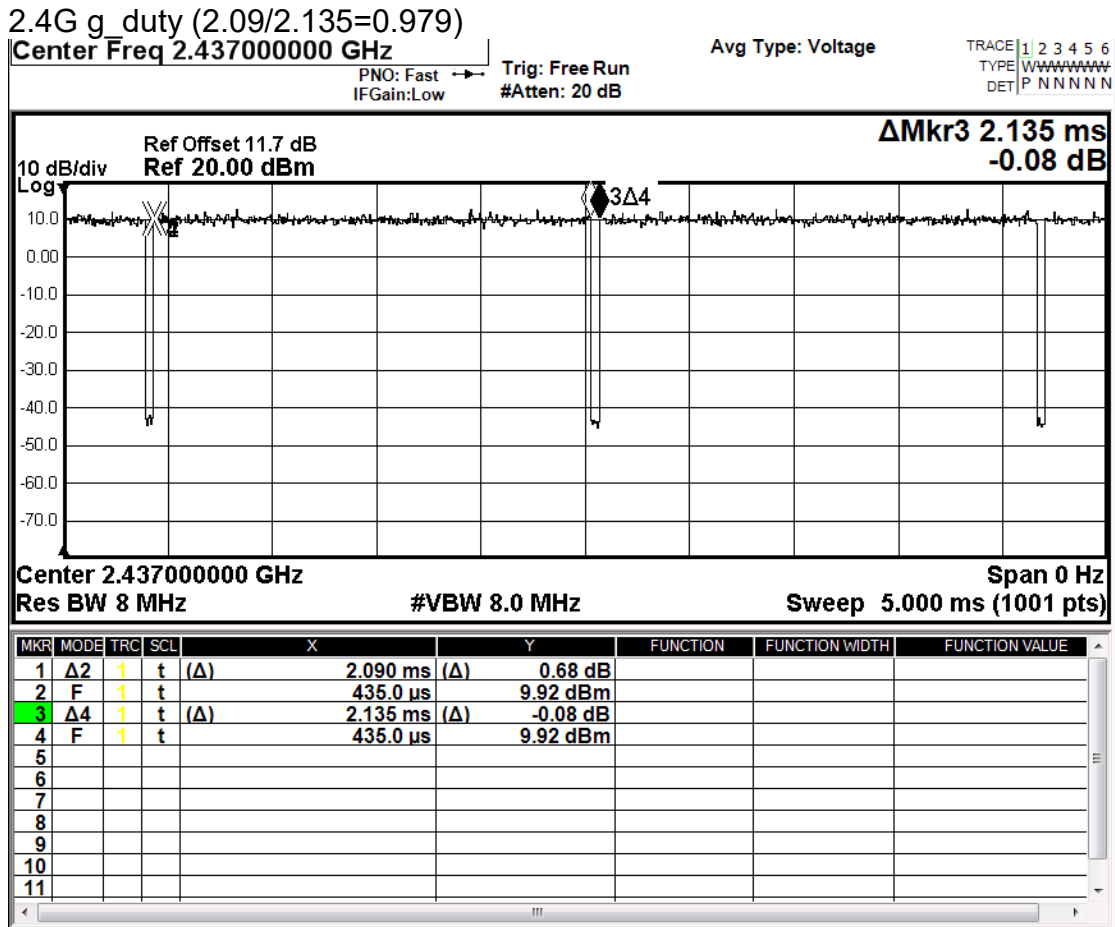

Unless otherwise stated the results shown in this test report refer only to the sample(s) tested and such sample(s) are retained for 90 days only.

除非另有說明，此報告結果僅對測試之樣品負責，同時此樣品僅保留90天。本報告未經本公司書面許可，不可部份複製。

This document is issued by the Company subject to its General Conditions of Service printed overleaf, available on request or accessible at <http://www.sgs.com.tw/Terms-and-Conditions> and for electronic format documents, subject to Terms and Conditions for Electronic Documents at <http://www.sgs.com.tw/Terms-and-Conditions>. Attention is drawn to the limitation of liability, indemnification and jurisdiction issues defined therein. Any holder of this document is advised that information contained hereon reflects the Company's findings at the time of its intervention only and within the limits of Client's instructions, if any. The Company's sole responsibility is to its Client and this document does not exonerate parties to a transaction from exercising all their rights and obligations under the transaction documents. This document cannot be reproduced except in full, without prior written approval of the Company. Any unauthorized alteration, forgery or falsification of the content or appearance of this document is unlawful and offenders may be prosecuted to the fullest extent of the law.

5G n40_duty(3.97/4.02=0.988)

Center Freq 5.19000000 GHz

Avg Type: Voltage

TRACE 1 2 3 4 5 6
TYPE WWWWWWW
DET P NNNNN

PN0: Fast → Trig: Free Run
IFGain:Low #Atten: 20 dB

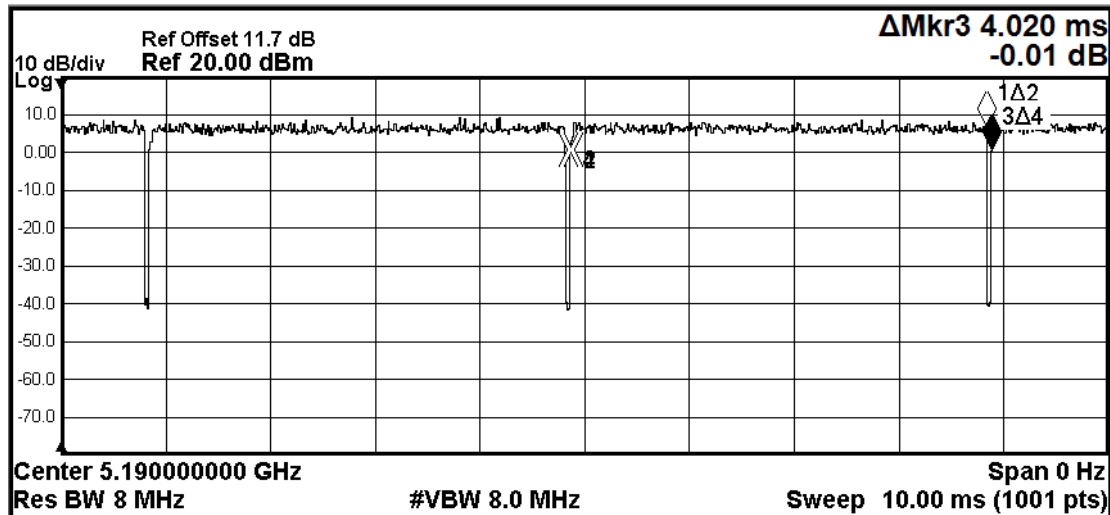

MKR	MODE	TRC	SCL	X	Y	FUNCTION	FUNCTION WIDTH	FUNCTION VALUE
1	Δ2	1	t	(Δ) 3.970 ms	(Δ) 6.04 dB			
2	F	1	t	4.860 ms	0.49 dBm			
3	Δ4	1	t	(Δ) 4.020 ms	(Δ) -0.01 dB			
4	F	1	t	4.860 ms	0.49 dBm			
5								
6								
7								
8								
9								
10								
11								

Unless otherwise stated the results shown in this test report refer only to the sample(s) tested and such sample(s) are retained for 90 days only.

除非另有說明，此報告結果僅對測試之樣品負責，同時此樣品僅保留90天。本報告未經本公司書面許可，不可部份複製。

This document is issued by the Company subject to its General Conditions of Service printed overleaf, available on request or accessible at <http://www.sgs.com.tw/Terms-and-Conditions> and for electronic format documents, subject to Terms and Conditions for Electronic Documents at <http://www.sgs.com.tw/Terms-and-Conditions>. Attention is drawn to the limitation of liability, indemnification and jurisdiction issues defined therein. Any holder of this document is advised that information contained hereon reflects the Company's findings at the time of its intervention only and within the limits of Client's instructions, if any. The Company's sole responsibility is to its Client and this document does not exonerate parties to a transaction from exercising all their rights and obligations under the transaction documents. This document cannot be reproduced except in full, without prior written approval of the Company. Any unauthorized alteration, forgery or falsification of the content or appearance of this document is unlawful and offenders may be prosecuted to the fullest extent of the law.

SGS Taiwan Ltd. No.134,Wu Kung Road, New Taipei Industrial Park, Wuku District, New Taipei City, Taiwan/新北市五股區新北產業園區五工路 134 號

5G ac40_duty(3.96/4.00=0.990)

Center Freq 5.190000000 GHz

Avg Type: Voltage

TRACE 1 2 3 4 5 6
TYPE W W W W W W W W
DET P N N N N N

PN0: Fast → Trig: Free Run
IFGain:Low #Atten: 20 dB

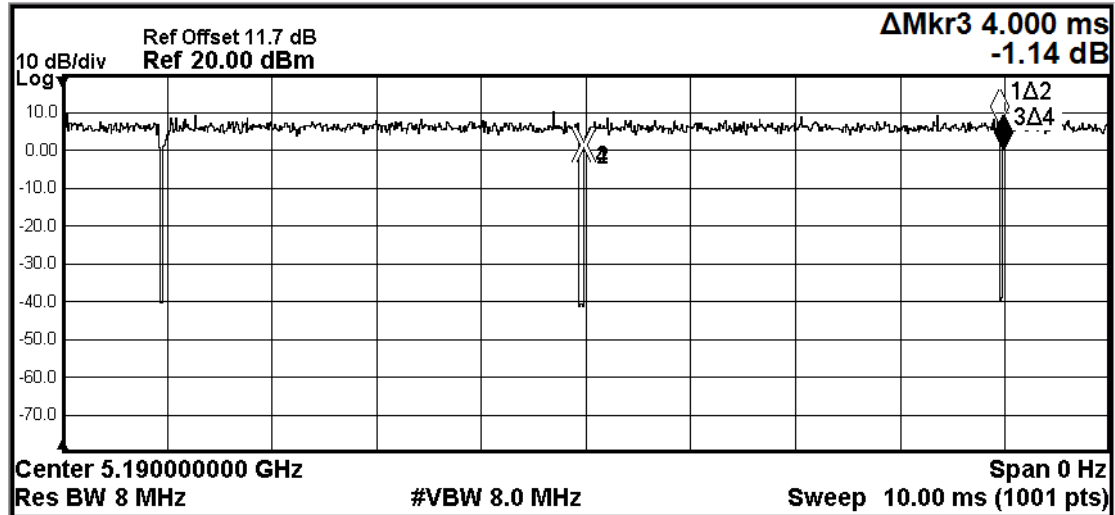

MKR	MODE	TRC	SCL		X	Y	FUNCTION	FUNCTION WIDTH	FUNCTION VALUE
1	Δ2	1	t	(Δ)	3.960 ms	5.71 dB			
2	F	1	t		4.980 ms	1.07 dBm			
3	Δ4	1	t	(Δ)	4.000 ms	-1.14 dB			
4	F	1	t		4.980 ms	1.07 dBm			
5									
6									
7									
8									
9									
10									
11									

Unless otherwise stated the results shown in this test report refer only to the sample(s) tested and such sample(s) are retained for 90 days only.

除非另有說明，此報告結果僅對測試之樣品負責，同時此樣品僅保留90天。本報告未經本公司書面許可，不可部份複製。

This document is issued by the Company subject to its General Conditions of Service printed overleaf, available on request or accessible at <http://www.sgs.com.tw/Terms-and-Conditions> and for electronic format documents, subject to Terms and Conditions for Electronic Documents at <http://www.sgs.com.tw/Terms-and-Conditions>. Attention is drawn to the limitation of liability, indemnification and jurisdiction issues defined therein. Any holder of this document is advised that information contained hereon reflects the Company's findings at the time of its intervention only and within the limits of Client's instructions, if any. The Company's sole responsibility is to its Client and this document does not exonerate parties to a transaction from exercising all their rights and obligations under the transaction documents. This document cannot be reproduced except in full, without prior written approval of the Company. Any unauthorized alteration, forgery or falsification of the content or appearance of this document is unlawful and offenders may be prosecuted to the fullest extent of the law.

SGS Taiwan Ltd. No.134,Wu Kung Road, New Taipei Industrial Park, Wuku District, New Taipei City, Taiwan/新北市五股區新北產業園區五工路 134 號

5G ac80_duty(3.96/4.01=0.988)

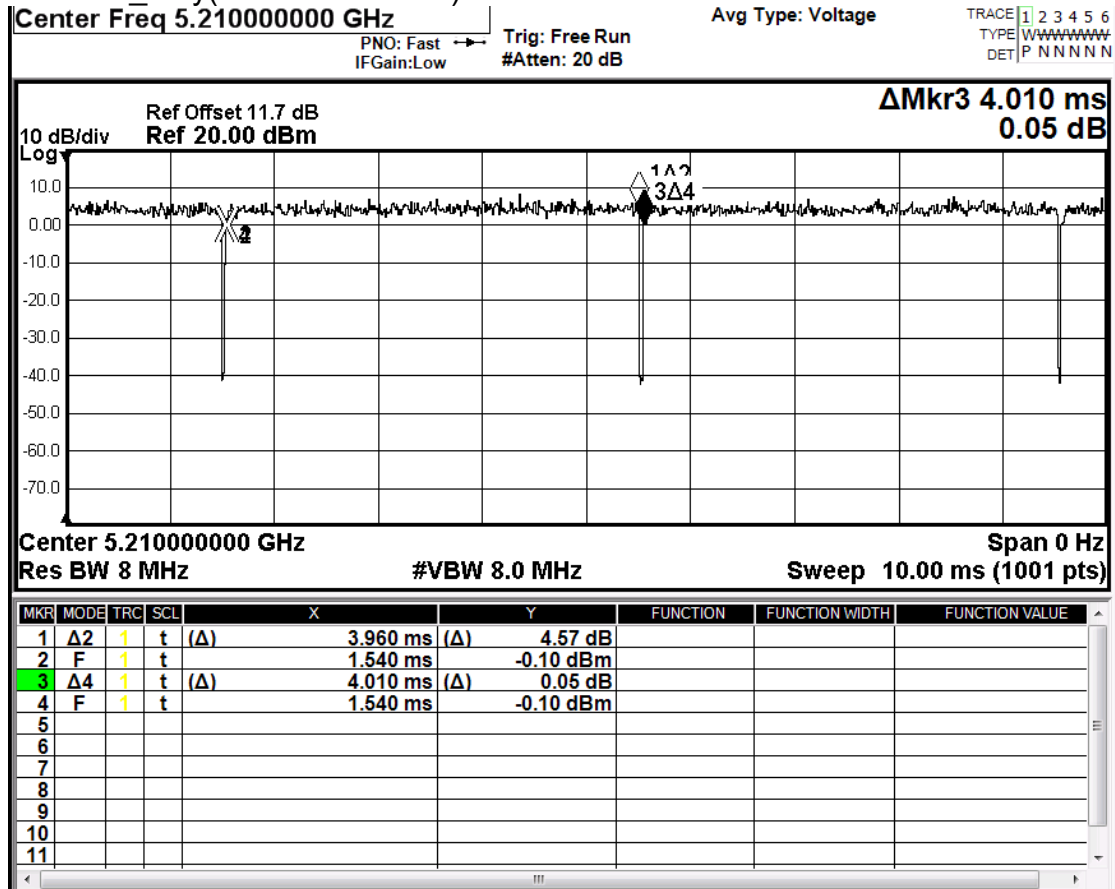

Unless otherwise stated the results shown in this test report refer only to the sample(s) tested and such sample(s) are retained for 90 days only.

除非另有說明，此報告結果僅對測試之樣品負責，同時此樣品僅保留90天。本報告未經本公司書面許可，不可部份複製。

This document is issued by the Company subject to its General Conditions of Service printed overleaf, available on request or accessible at <http://www.sgs.com.tw/Terms-and-Conditions> and for electronic format documents, subject to Terms and Conditions for Electronic Documents at <http://www.sgs.com.tw/Terms-and-Conditions>. Attention is drawn to the limitation of liability, indemnification and jurisdiction issues defined therein. Any holder of this document is advised that information contained hereon reflects the Company's findings at the time of its intervention only and within the limits of Client's instructions, if any. The Company's sole responsibility is to its Client and this document does not exonerate parties to a transaction from exercising all their rights and obligations under the transaction documents. This document cannot be reproduced except in full, without prior written approval of the Company. Any unauthorized alteration, forgery or falsification of the content or appearance of this document is unlawful and offenders may be prosecuted to the fullest extent of the law.

1.4 Test Environment

Ambient Temperature: 22±2° C

Tissue Simulating Liquid: 22±2° C

1.5 Operation Description

For WWAN, the EUT is controlled by using a Radio Communication Tester, and the communication between the EUT and the tester is established by air link.

For WLAN, using chipset specific software to control the EUT, and makes it transmit in maximum power. The EUT is set to maximum power level during all tests, and at the beginning of each test the battery is fully charged.

For WWAN/WLAN, the device used the proximity sensor collocated with WWAN/WLAN antennas to reduce maximum output power.

WCDMA B V / LTE B5 / WLAN

Back/top_0mm with reduced power

Back_11mm / top_7mm / edges_0mm with full power

Note:

802.11b DSSS SAR Test Requirements:

1. SAR is measured for 2.4 GHz 802.11b DSSS mode using the highest measured maximum output power channel, when the reported SAR of the highest measured maximum output power channel for the exposure configuration is ≤ 0.8 W/kg, no further SAR testing is required for 802.11b DSSS in that exposure configuration.
2. When the reported SAR is > 0.8 W/kg, SAR is required for that exposure configuration using the next highest measured output power channel. When any reported SAR is > 1.2 W/kg, SAR is required for the third channel; i.e., all channels require testing.

802.11g/n OFDM SAR Test Exclusion Requirements:

3. SAR is not required for 802.11g/n since the highest reported SAR for DSSS is adjusted by the ratio of OFDM to DSSS specified maximum output power and the adjusted SAR is ≤ 1.2 W/kg.

Unless otherwise stated the results shown in this test report refer only to the sample(s) tested and such sample(s) are retained for 90 days only.
除非另有說明，此報告結果僅對測試之樣品負責，同時此樣品僅保留90天。本報告未經本公司書面許可，不可部份複製。

This document is issued by the Company subject to its General Conditions of Service printed overleaf, available on request or accessible at <http://www.sgs.com.tw/Terms-and-Conditions> and for electronic format documents, subject to Terms and Conditions for Electronic Documents at <http://www.sgs.com.tw/Terms-and-Conditions>. Attention is drawn to the limitation of liability, indemnification and jurisdiction issues defined therein. Any holder of this document is advised that information contained hereon reflects the Company's findings at the time of its intervention only and within the limits of Client's instructions, if any. The Company's sole responsibility is to its Client and this document does not exonerate parties to a transaction from exercising all their rights and obligations under the transaction documents. This document cannot be reproduced except in full, without prior written approval of the Company. Any unauthorized alteration, forgery or falsification of the content or appearance of this document is unlawful and offenders may be prosecuted to the fullest extent of the law.

SGS Taiwan Ltd. No.134,Wu Kung Road, New Taipei Industrial Park, Wuku District, New Taipei City, Taiwan/新北市五股區新北產業園區五工路 134 號

Initial Test Configuration:

4. An initial test configuration is determined for OFDM transmission modes according to the channel bandwidth, modulation and data rate combination(s) with the highest maximum output power specified for production units in each standalone and aggregated frequency band.
5. SAR is measured using the highest measured maximum output power channel. When the reported SAR of the initial test configuration is > 0.8 W/kg, SAR measurement is required for the subsequent next highest measured output power channel(s) in the initial test configuration until the reported SAR is ≤ 1.2 W/kg or all required channels are tested.
6. When the highest reported SAR for the initial test configuration is adjusted by the ratio of the subsequent test configuration to initial test configuration specified maximum output power and the adjusted SAR is > 1.2 W/kg, SAR is required for subsequent test configuration.
7. BT and WLAN use the same antenna path, but they can't transmit at the same time.
8. According to KDB447498 D01, testing of other required channels is not required when the reported 1-g SAR for the highest output channel is ≤ 0.8 W/kg, when the transmission band is ≤ 100 MHz.
9. According to KDB865664 D01, SAR measurement variability must be assessed for each frequency band. When the original highest measured SAR is ≥ 0.8 W/kg, repeated that measurement once. Perform a second repeated measurement only if the ratio of largest to smallest SAR for the original and first repeated measurements is > 1.20 or when the original or repeated measurement is ≥ 1.45 W/kg (~10% from the 1-g SAR limit)

Unless otherwise stated the results shown in this test report refer only to the sample(s) tested and such sample(s) are retained for 90 days only.
除非另有說明，此報告結果僅對測試之樣品負責，同時此樣品僅保留90天。本報告未經本公司書面許可，不可部份複製。

This document is issued by the Company subject to its General Conditions of Service printed overleaf, available on request or accessible at <http://www.sgs.com.tw/Terms-and-Conditions> and for electronic format documents, subject to Terms and Conditions for Electronic Documents at <http://www.sgs.com.tw/Terms-and-Conditions>. Attention is drawn to the limitation of liability, indemnification and jurisdiction issues defined therein. Any holder of this document is advised that information contained hereon reflects the Company's findings at the time of its intervention only and within the limits of Client's instructions, if any. The Company's sole responsibility is to its Client and this document does not exonerate parties to a transaction from exercising all their rights and obligations under the transaction documents. This document cannot be reproduced except in full, without prior written approval of the Company. Any unauthorized alteration, forgery or falsification of the content or appearance of this document is unlawful and offenders may be prosecuted to the fullest extent of the law.

1.6 Proximity sensor operation description

The P-sensor being used to reduce output power is capacitive in which when the object such as human body, metal or plastic is being approached, the sensing capacitance would be increased with the antenna pad. Once the capacitance is accumulated, and reached over the threshold as set in MCU of the microchip, the interruption signal is pulled low (High state without trigger) and further inform modem module of the transmitter to make power reduction.

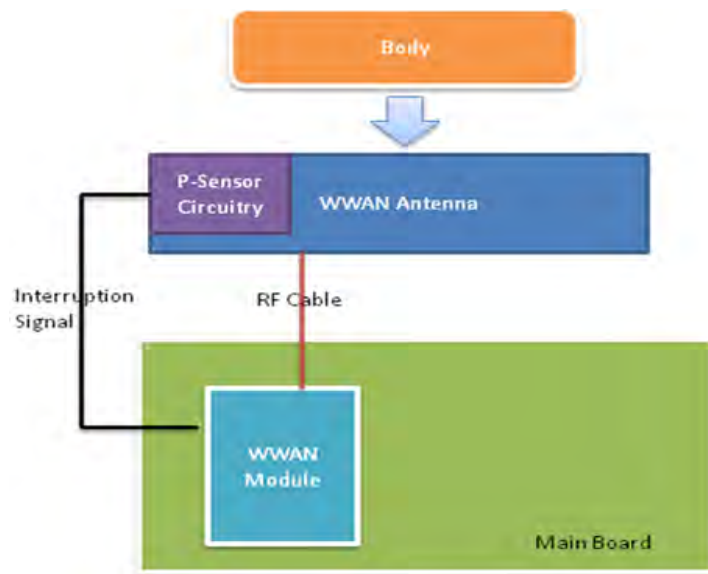

1.6.1 Proximity sensor measurement procedure

1. The proximity sensors are collocated with WWAN/WLAN antennas.
2. Output power is measured, and monitored by using the communication tester. A RF cables with sufficient length was being attached from the antenna port of the module, and used for the measurement. The appropriate loss attenuated from cable is compensated in the communication tester.

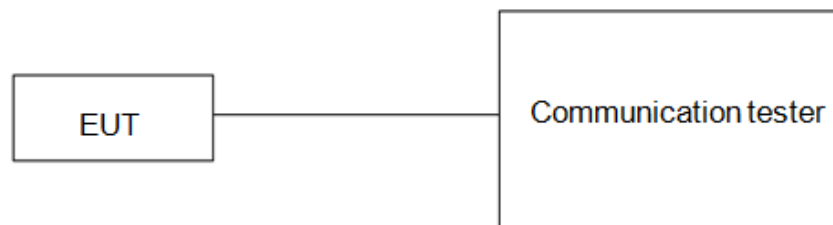

Unless otherwise stated the results shown in this test report refer only to the sample(s) tested and such sample(s) are retained for 90 days only.
除非另有說明，此報告結果僅對測試之樣品負責，同時此樣品僅保留90天。本報告未經本公司書面許可，不可部份複製。

This document is issued by the Company subject to its General Conditions of Service printed overleaf, available on request or accessible at <http://www.sgs.com.tw/Terms-and-Conditions> and for electronic format documents, subject to Terms and Conditions for Electronic Documents at <http://www.sgs.com.tw/Terms-and-Conditions>. Attention is drawn to the limitation of liability, indemnification and jurisdiction issues defined therein. Any holder of this document is advised that information contained hereon reflects the Company's findings at the time of its intervention only and within the limits of Client's instructions, if any. The Company's sole responsibility is to its Client and this document does not exonerate parties to a transaction from exercising all their rights and obligations under the transaction documents. This document cannot be reproduced except in full, without prior written approval of the Company. Any unauthorized alteration, forgery or falsification of the content or appearance of this document is unlawful and offenders may be prosecuted to the fullest extent of the law.

1.6.2 Trigger distances for back/top side

Test procedure:

1. The entire back surface or edge of the tablet is positioned below a flat phantom filled with the required tissue equivalent medium and positioned at least 20 mm further than the distance that triggers power reduction.
2. The back surface or edge is moved toward the phantom in 3 mm steps until the sensor triggers.
3. The back surface or edge is then moved back (further away) from the phantom until maximum output power is returned to the normal maximum level.
4. The back surface or edge is again moved toward the phantom, but in 1 mm steps, until it is at least 5 mm past the triggering point or touching the phantom
5. If the tablet is not touching the phantom, it is moved in 3 mm steps until it touches the phantom to confirm that the sensor remains triggered and the maximum power stays reduced.
6. The process is then reversed by moving the tablet away from the phantom to determine triggering release, until it is at least 10 mm beyond the point that triggers the return of normal maximum power.
7. The measured output power within ± 5 mm of the triggering points, or until the tablet is touching the phantom, for movements to and from the phantom should be tabulated.
8. To ensure all production units are compliant, it is generally necessary to reduce the triggering distance determined from the triggering tests by 1 mm, or more if it is necessary, and use the smallest distance for movements to and from the phantom, minus 1 mm, as the sensor triggering distance for determining the SAR measurement distance.
9. For backside of WWAN/WLAN antennas, the trigger distance of proximity sensor is 12mm.
10. For top side of WWAN/WLAN antennas, the trigger distance of proximity sensor is 8mm, and we perform the 1.6.3 tilt angle testing in next step.

Unless otherwise stated the results shown in this test report refer only to the sample(s) tested and such sample(s) are retained for 90 days only.

除非另有說明，此報告結果僅對測試之樣品負責，同時此樣品僅保留90天。本報告未經本公司書面許可，不可部份複製。

This document is issued by the Company subject to its General Conditions of Service printed overleaf, available on request or accessible at <http://www.sgs.com.tw/Terms-and-Conditions> and for electronic format documents, subject to Terms and Conditions for Electronic Documents at <http://www.sgs.com.tw/Terms-and-Conditions>. Attention is drawn to the limitation of liability, indemnification and jurisdiction issues defined therein. Any holder of this document is advised that information contained hereon reflects the Company's findings at the time of its intervention only and within the limits of Client's instructions, if any. The Company's sole responsibility is to its Client and this document does not exonerate parties to a transaction from exercising all their rights and obligations under the transaction documents. This document cannot be reproduced except in full, without prior written approval of the Company. Any unauthorized alteration, forgery or falsification of the content or appearance of this document is unlawful and offenders may be prosecuted to the fullest extent of the law.

1.6.3 Tilt angle testing

Test procedure:

1. The influence of table tilt angles to proximity sensor triggering is determined by positioning each tablet edge that contains a transmitting antenna, perpendicular to the flat phantom, at the smallest sensor triggering test distance determined in sections 1.6.2 by rotating the tablet around the edge next to the phantom in ≤ 10 deg increments until the tablet is ± 45 deg or more from the vertical position at 0 deg.
2. If sensor triggering is released and normal maximum output power is restored within the ± 45 deg range, the procedures in step 1) should be repeated by reducing the tablet to phantom separation distance by 1 mm until the proximity sensor no longer releases triggering, and maximum output power remains in the reduced mode.
3. The smallest separation distance determined in steps 1) and 2), minus 1 mm, is the sensor triggering distance for tablet tilt coverage. The smallest separation distance determined in sections 1.6.2, 1.6.3 minus 1 mm should be used in the SAR measurements.
4. The influence of tablet tilt angles to proximity sensor triggering is determined by positioning top side, please refer to table 1.6.5 and 1.6.6.
5. After the tilt angle testing for top side on WWAN/WLAN antennas, the sensor is not released during ± 45 deg, so $8-1=7$ mm is used for WWAN SAR measurement on top side.

Unless otherwise stated the results shown in this test report refer only to the sample(s) tested and such sample(s) are retained for 90 days only.
除非另有說明，此報告結果僅對測試之樣品負責，同時此樣品僅保留90天。本報告未經本公司書面許可，不可部份複製。

This document is issued by the Company subject to its General Conditions of Service printed overleaf, available on request or accessible at <http://www.sgs.com.tw/Terms-and-Conditions> and for electronic format documents, subject to Terms and Conditions for Electronic Documents at <http://www.sgs.com.tw/Terms-and-Conditions>. Attention is drawn to the limitation of liability, indemnification and jurisdiction issues defined therein. Any holder of this document is advised that information contained hereon reflects the Company's findings at the time of its intervention only and within the limits of Client's instructions, if any. The Company's sole responsibility is to its Client and this document does not exonerate parties to a transaction from exercising all their rights and obligations under the transaction documents. This document cannot be reproduced except in full, without prior written approval of the Company. Any unauthorized alteration, forgery or falsification of the content or appearance of this document is unlawful and offenders may be prosecuted to the fullest extent of the law.

1.6.4 Proximity sensor coverage

The following procedures do not apply and are not required for configurations where the antenna and sensor are collocated and the peak SAR location is overlapping with the sensor.

Test procedure:

1. The back surface or edges of the tablet is positioned at a test separation distance less than or equal to the distance required for back surface or edge triggering, with both the antenna and sensor pad located at least 20 mm laterally outside the edge (boundary) of the phantom, along the direction of maximum antenna and sensor offset.
2. The similar sequence of steps applied to determine sensor triggering distance in section 1.6.2 are used to verify back surface and edge sensor coverage by moving the tablet (sensor and antenna) horizontally toward the phantom while maintaining the same vertical separation between the back surface or edge and the phantom.
3. After the exact location where triggering of power reduction is determined, with respect to the sensor and antenna, the tablet movement should be continued, in 3 mm increments, until both the sensor and antenna(s) are fully under the phantom and at least 20 mm inside the phantom edge.
4. The process is then repeated from the other direction, at the opposite end of maximum antenna and sensor offset, by rotating the tablet 180 degrees.

Unless otherwise stated the results shown in this test report refer only to the sample(s) tested and such sample(s) are retained for 90 days only.
除非另有說明，此報告結果僅對測試之樣品負責，同時此樣品僅保留90天。本報告未經本公司書面許可，不可部份複製。

This document is issued by the Company subject to its General Conditions of Service printed overleaf, available on request or accessible at <http://www.sgs.com.tw/Terms-and-Conditions> and for electronic format documents, subject to Terms and Conditions for Electronic Documents at <http://www.sgs.com.tw/Terms-and-Conditions>. Attention is drawn to the limitation of liability, indemnification and jurisdiction issues defined therein. Any holder of this document is advised that information contained hereon reflects the Company's findings at the time of its intervention only and within the limits of Client's instructions, if any. The Company's sole responsibility is to its Client and this document does not exonerate parties to a transaction from exercising all their rights and obligations under the transaction documents. This document cannot be reproduced except in full, without prior written approval of the Company. Any unauthorized alteration, forgery or falsification of the content or appearance of this document is unlawful and offenders may be prosecuted to the fullest extent of the law.

1.6.5 Results

The measured output power within ± 5 mm of the triggering points, or until the tablet is touching the phantom, for movements to and from the phantom is tabulated in the following.

Back side

Moving device toward the phantom

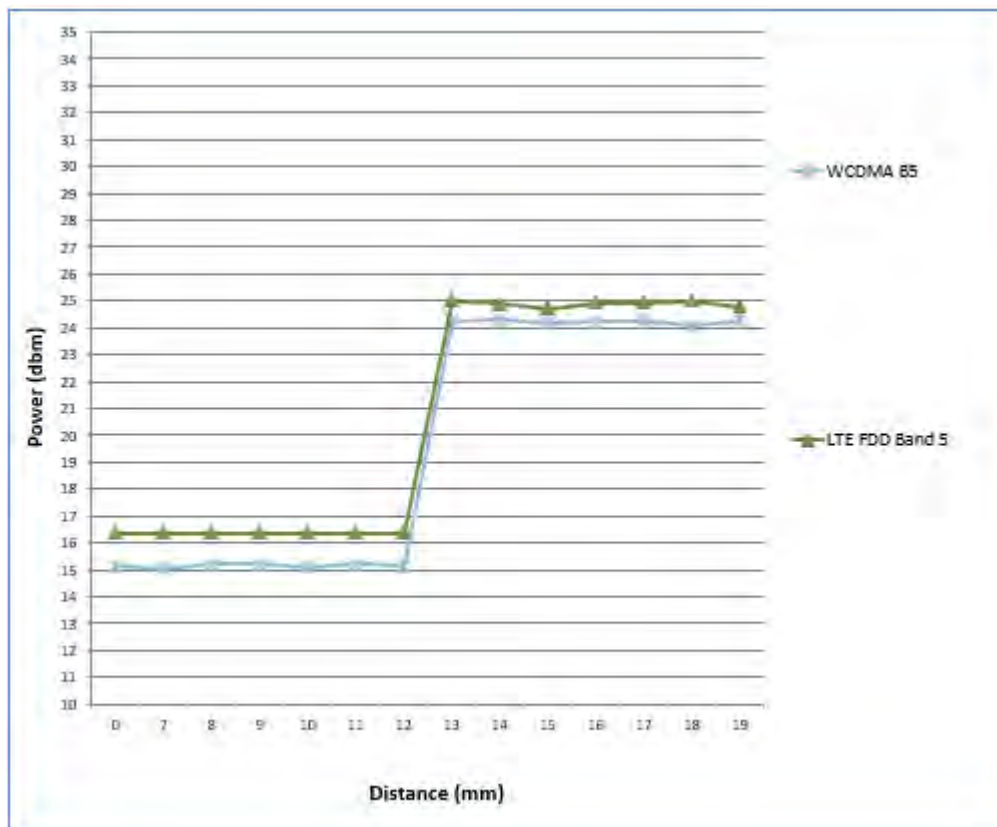

Unless otherwise stated the results shown in this test report refer only to the sample(s) tested and such sample(s) are retained for 90 days only.

除非另有說明，此報告結果僅對測試之樣品負責，同時此樣品僅保留90天。本報告未經本公司書面許可，不可部份複製。

This document is issued by the Company subject to its General Conditions of Service printed overleaf, available on request or accessible at <http://www.sgs.com.tw/Terms-and-Conditions> and for electronic format documents, subject to Terms and Conditions for Electronic Documents at <http://www.sgs.com.tw/Terms-and-Conditions>. Attention is drawn to the limitation of liability, indemnification and jurisdiction issues defined therein. Any holder of this document is advised that information contained hereon reflects the Company's findings at the time of its intervention only and within the limits of Client's instructions, if any. The Company's sole responsibility is to its Client and this document does not exonerate parties to a transaction from exercising all their rights and obligations under the transaction documents. This document cannot be reproduced except in full, without prior written approval of the Company. Any unauthorized alteration, forgery or falsification of the content or appearance of this document is unlawful and offenders may be prosecuted to the fullest extent of the law.

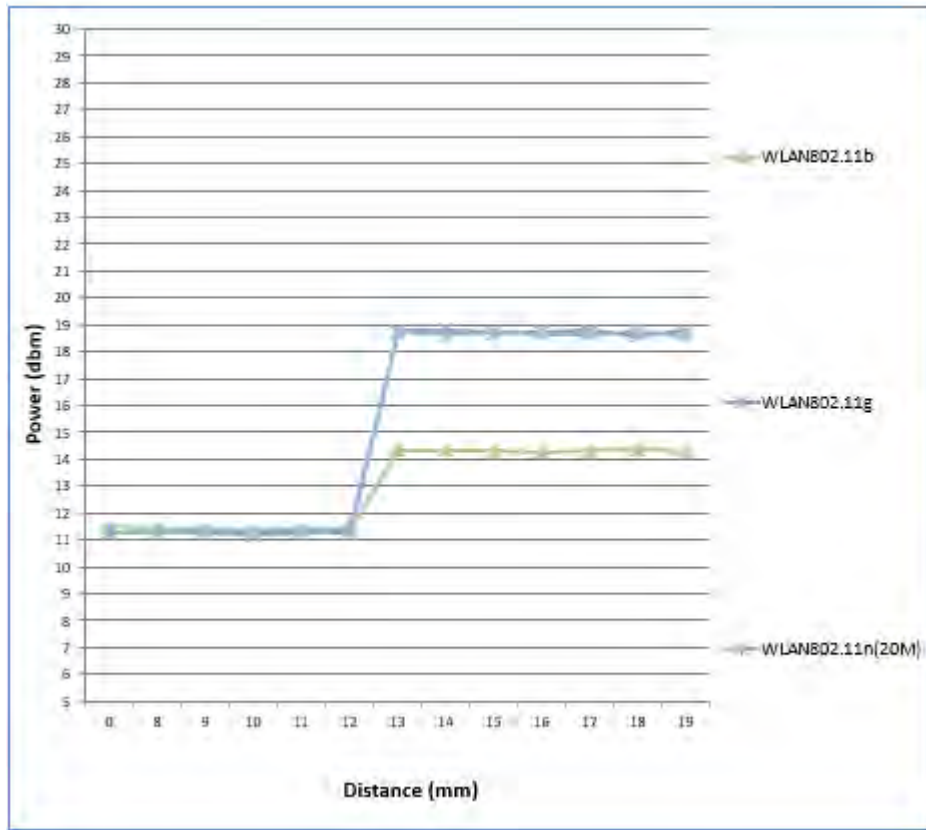

Unless otherwise stated the results shown in this test report refer only to the sample(s) tested and such sample(s) are retained for 90 days only.

除非另有說明，此報告結果僅對測試之樣品負責，同時此樣品僅保留90天。本報告未經本公司書面許可，不可部份複製。

This document is issued by the Company subject to its General Conditions of Service printed overleaf, available on request or accessible at <http://www.sgs.com.tw/Terms-and-Conditions> and for electronic format documents, subject to Terms and Conditions for Electronic Documents at <http://www.sgs.com.tw/Terms-and-Conditions>. Attention is drawn to the limitation of liability, indemnification and jurisdiction issues defined therein. Any holder of this document is advised that information contained hereon reflects the Company's findings at the time of its intervention only and within the limits of Client's instructions, if any. The Company's sole responsibility is to its Client and this document does not exonerate parties to a transaction from exercising all their rights and obligations under the transaction documents. This document cannot be reproduced except in full, without prior written approval of the Company. Any unauthorized alteration, forgery or falsification of the content or appearance of this document is unlawful and offenders may be prosecuted to the fullest extent of the law.

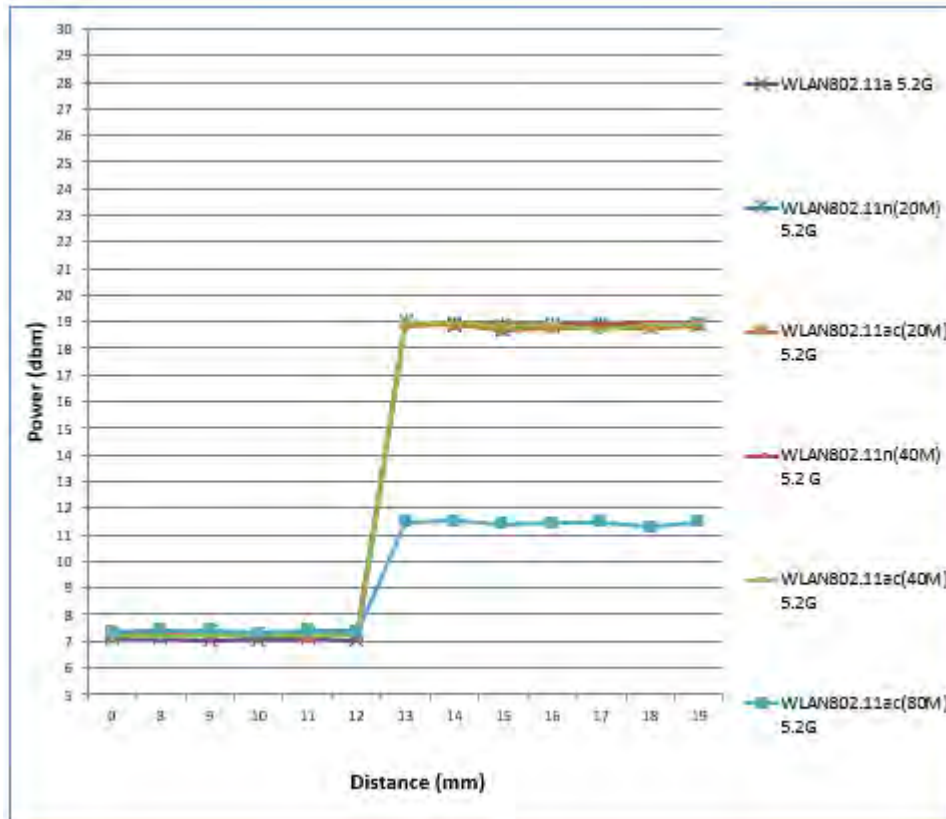

Unless otherwise stated the results shown in this test report refer only to the sample(s) tested and such sample(s) are retained for 90 days only.

除非另有說明，此報告結果僅對測試之樣品負責，同時此樣品僅保留90天。本報告未經本公司書面許可，不可部份複製。

This document is issued by the Company subject to its General Conditions of Service printed overleaf, available on request or accessible at <http://www.sgs.com.tw/Terms-and-Conditions> and for electronic format documents, subject to Terms and Conditions for Electronic Documents at <http://www.sgs.com.tw/Terms-and-Conditions>. Attention is drawn to the limitation of liability, indemnification and jurisdiction issues defined therein. Any holder of this document is advised that information contained hereon reflects the Company's findings at the time of its intervention only and within the limits of Client's instructions, if any. The Company's sole responsibility is to its Client and this document does not exonerate parties to a transaction from exercising all their rights and obligations under the transaction documents. This document cannot be reproduced except in full, without prior written approval of the Company. Any unauthorized alteration, forgery or falsification of the content or appearance of this document is unlawful and offenders may be prosecuted to the fullest extent of the law.

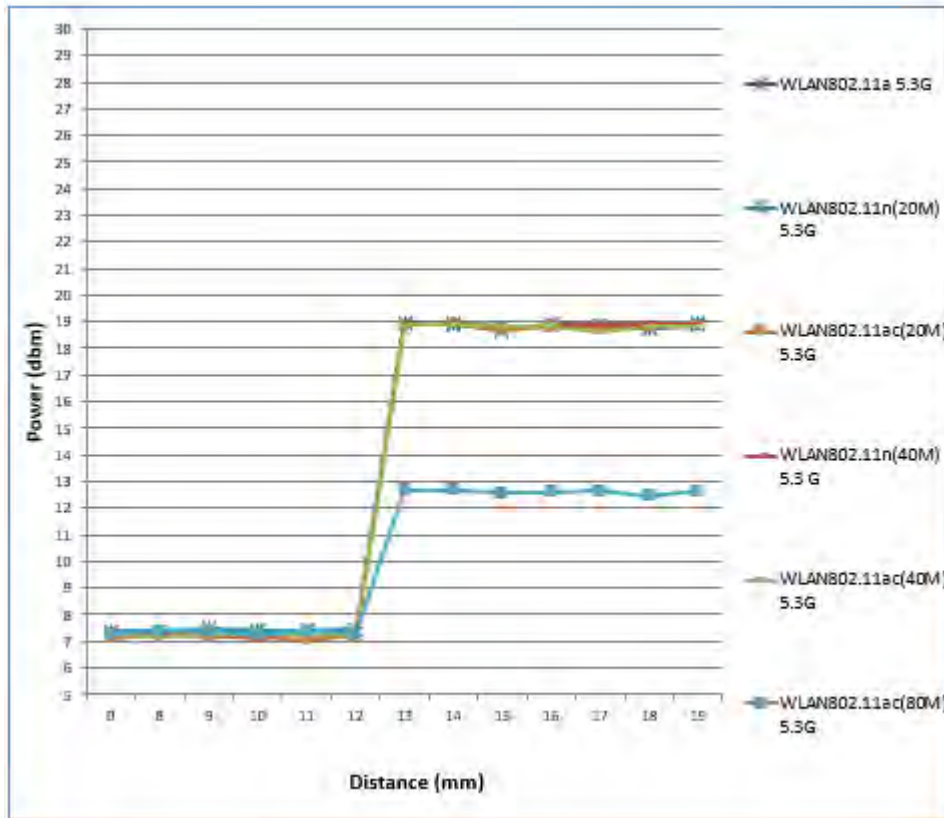

Unless otherwise stated the results shown in this test report refer only to the sample(s) tested and such sample(s) are retained for 90 days only.

除非另有說明，此報告結果僅對測試之樣品負責，同時此樣品僅保留90天。本報告未經本公司書面許可，不可部份複製。

This document is issued by the Company subject to its General Conditions of Service printed overleaf, available on request or accessible at <http://www.sgs.com.tw/Terms-and-Conditions> and for electronic format documents, subject to Terms and Conditions for Electronic Documents at <http://www.sgs.com.tw/Terms-and-Conditions>. Attention is drawn to the limitation of liability, indemnification and jurisdiction issues defined therein. Any holder of this document is advised that information contained hereon reflects the Company's findings at the time of its intervention only and within the limits of Client's instructions, if any. The Company's sole responsibility is to its Client and this document does not exonerate parties to a transaction from exercising all their rights and obligations under the transaction documents. This document cannot be reproduced except in full, without prior written approval of the Company. Any unauthorized alteration, forgery or falsification of the content or appearance of this document is unlawful and offenders may be prosecuted to the fullest extent of the law.

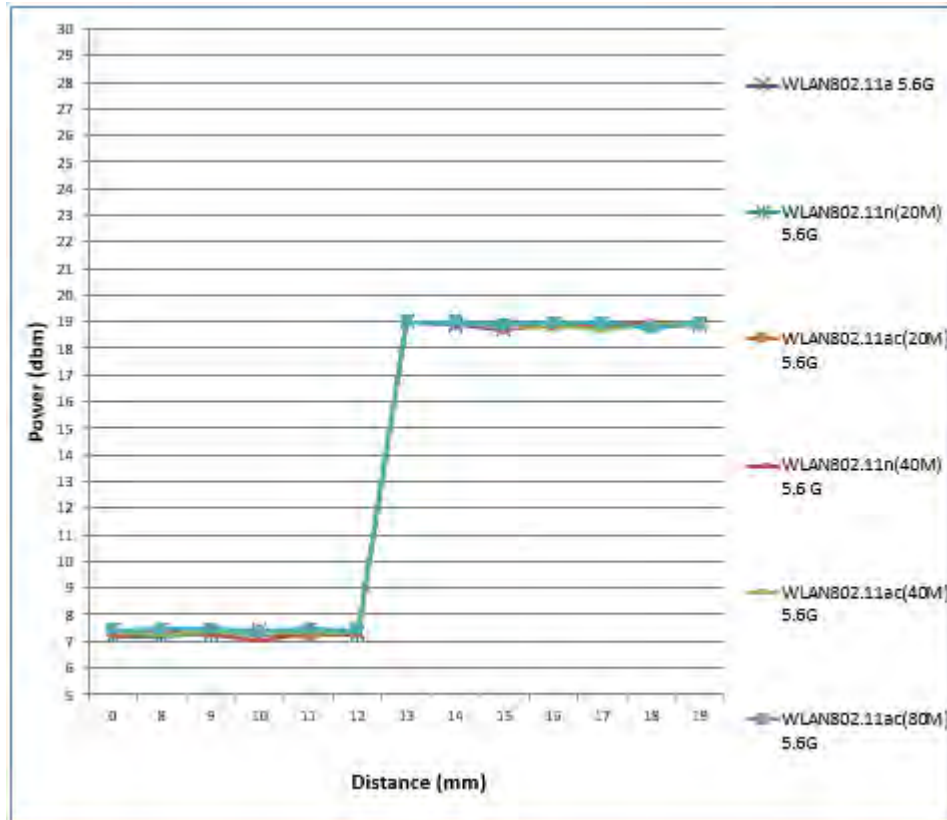

Unless otherwise stated the results shown in this test report refer only to the sample(s) tested and such sample(s) are retained for 90 days only.

除非另有說明，此報告結果僅對測試之樣品負責，同時此樣品僅保留90天。本報告未經本公司書面許可，不可部份複製。

This document is issued by the Company subject to its General Conditions of Service printed overleaf, available on request or accessible at <http://www.sgs.com.tw/Terms-and-Conditions> and for electronic format documents, subject to Terms and Conditions for Electronic Documents at <http://www.sgs.com.tw/Terms-and-Conditions>. Attention is drawn to the limitation of liability, indemnification and jurisdiction issues defined therein. Any holder of this document is advised that information contained hereon reflects the Company's findings at the time of its intervention only and within the limits of Client's instructions, if any. The Company's sole responsibility is to its Client and this document does not exonerate parties to a transaction from exercising all their rights and obligations under the transaction documents. This document cannot be reproduced except in full, without prior written approval of the Company. Any unauthorized alteration, forgery or falsification of the content or appearance of this document is unlawful and offenders may be prosecuted to the fullest extent of the law.

Moving device away from the phantom

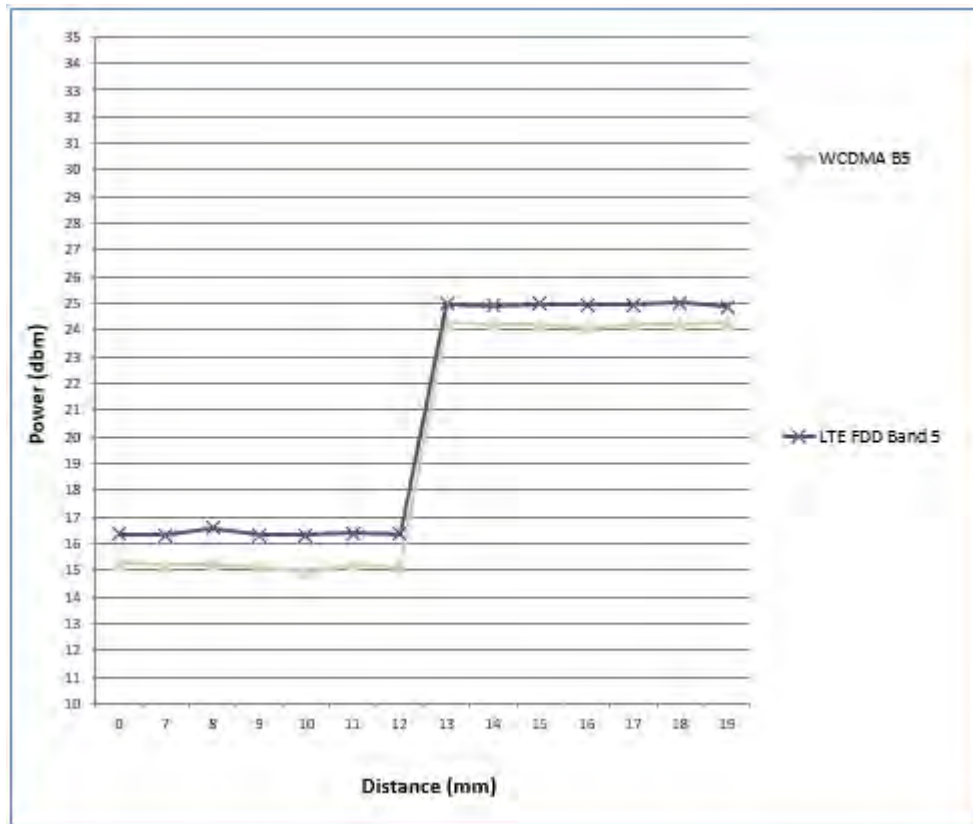

Unless otherwise stated the results shown in this test report refer only to the sample(s) tested and such sample(s) are retained for 90 days only.

除非另有說明，此報告結果僅對測試之樣品負責，同時此樣品僅保留90天。本報告未經本公司書面許可，不可部份複製。

This document is issued by the Company subject to its General Conditions of Service printed overleaf, available on request or accessible at <http://www.sgs.com.tw/Terms-and-Conditions> and for electronic format documents, subject to Terms and Conditions for Electronic Documents at <http://www.sgs.com.tw/Terms-and-Conditions>. Attention is drawn to the limitation of liability, indemnification and jurisdiction issues defined therein. Any holder of this document is advised that information contained hereon reflects the Company's findings at the time of its intervention only and within the limits of Client's instructions, if any. The Company's sole responsibility is to its Client and this document does not exonerate parties to a transaction from exercising all their rights and obligations under the transaction documents. This document cannot be reproduced except in full, without prior written approval of the Company. Any unauthorized alteration, forgery or falsification of the content or appearance of this document is unlawful and offenders may be prosecuted to the fullest extent of the law.

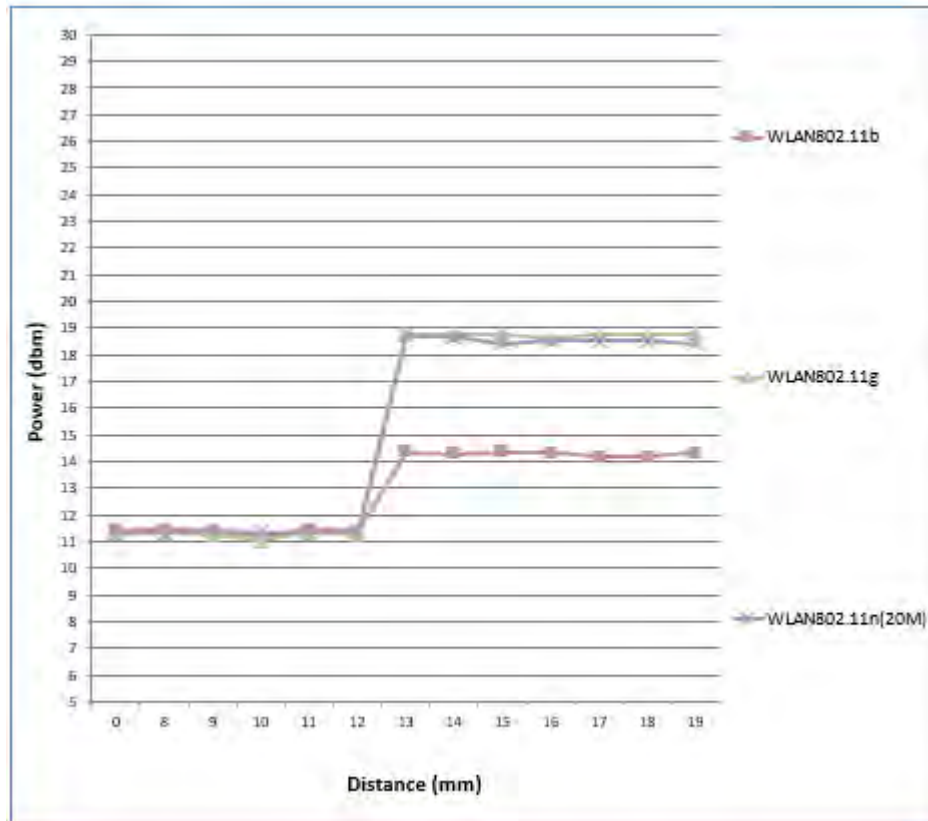

Unless otherwise stated the results shown in this test report refer only to the sample(s) tested and such sample(s) are retained for 90 days only.

除非另有說明，此報告結果僅對測試之樣品負責，同時此樣品僅保留90天。本報告未經本公司書面許可，不可部份複製。

This document is issued by the Company subject to its General Conditions of Service printed overleaf, available on request or accessible at <http://www.sgs.com.tw/Terms-and-Conditions> and for electronic format documents, subject to Terms and Conditions for Electronic Documents at <http://www.sgs.com.tw/Terms-and-Conditions>. Attention is drawn to the limitation of liability, indemnification and jurisdiction issues defined therein. Any holder of this document is advised that information contained hereon reflects the Company's findings at the time of its intervention only and within the limits of Client's instructions, if any. The Company's sole responsibility is to its Client and this document does not exonerate parties to a transaction from exercising all their rights and obligations under the transaction documents. This document cannot be reproduced except in full, without prior written approval of the Company. Any unauthorized alteration, forgery or falsification of the content or appearance of this document is unlawful and offenders may be prosecuted to the fullest extent of the law.

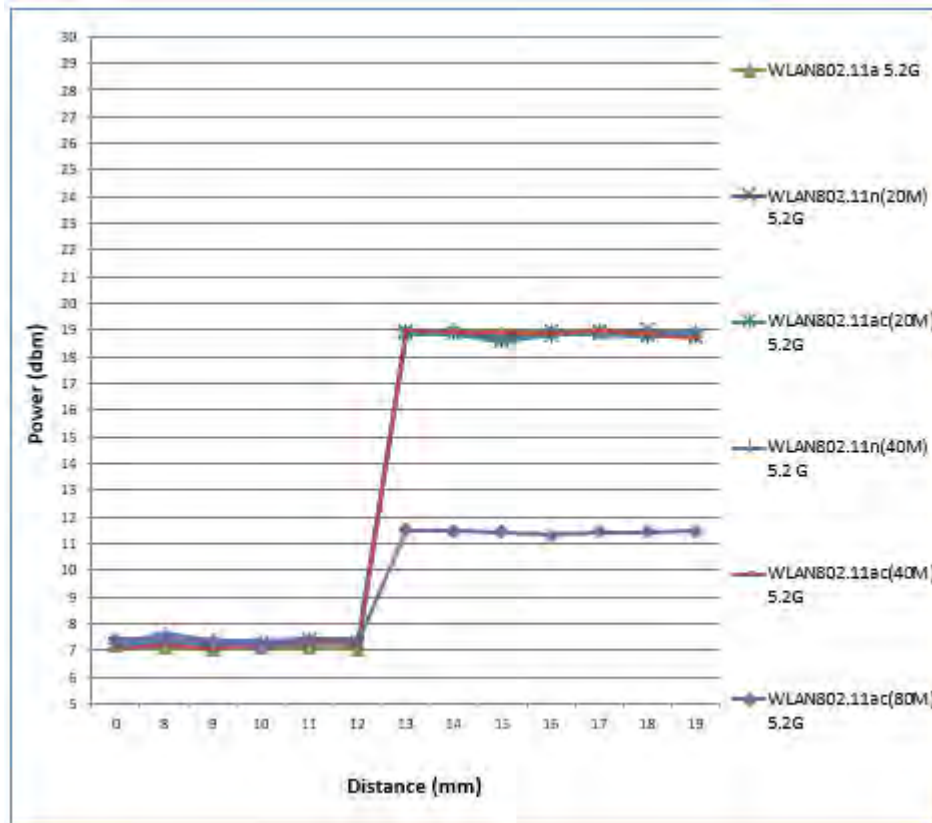

Unless otherwise stated the results shown in this test report refer only to the sample(s) tested and such sample(s) are retained for 90 days only.

除非另有說明，此報告結果僅對測試之樣品負責，同時此樣品僅保留90天。本報告未經本公司書面許可，不可部份複製。

This document is issued by the Company subject to its General Conditions of Service printed overleaf, available on request or accessible at <http://www.sgs.com.tw/Terms-and-Conditions> and for electronic format documents, subject to Terms and Conditions for Electronic Documents at <http://www.sgs.com.tw/Terms-and-Conditions>. Attention is drawn to the limitation of liability, indemnification and jurisdiction issues defined therein. Any holder of this document is advised that information contained hereon reflects the Company's findings at the time of its intervention only and within the limits of Client's instructions, if any. The Company's sole responsibility is to its Client and this document does not exonerate parties to a transaction from exercising all their rights and obligations under the transaction documents. This document cannot be reproduced except in full, without prior written approval of the Company. Any unauthorized alteration, forgery or falsification of the content or appearance of this document is unlawful and offenders may be prosecuted to the fullest extent of the law.

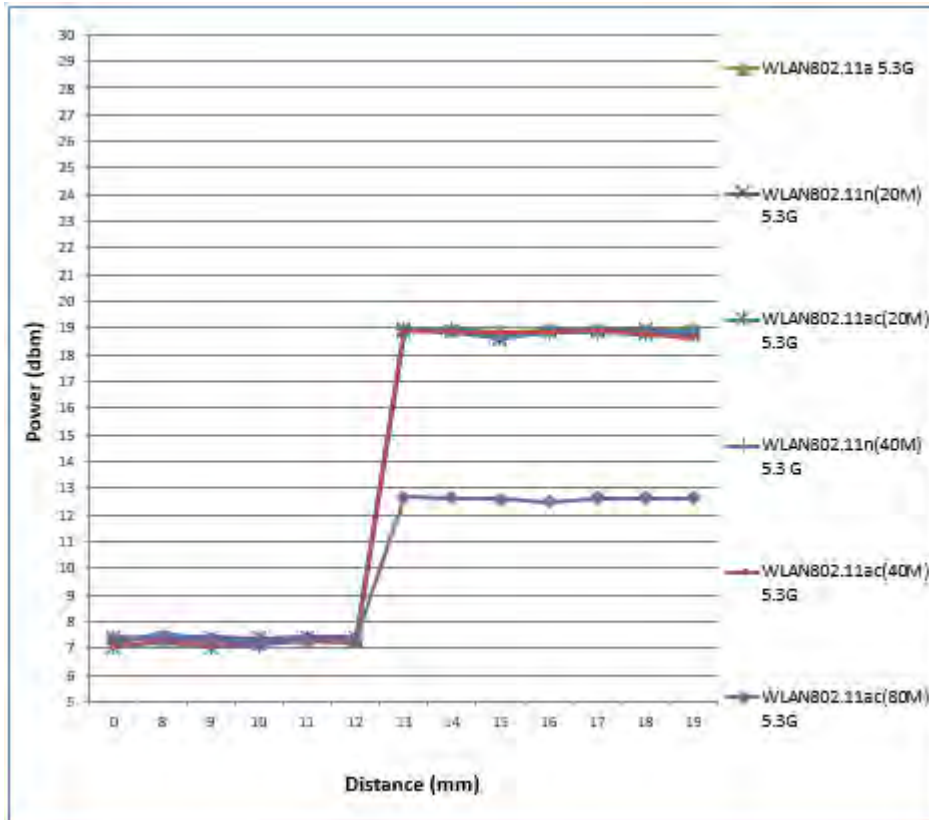

Unless otherwise stated the results shown in this test report refer only to the sample(s) tested and such sample(s) are retained for 90 days only.

除非另有說明，此報告結果僅對測試之樣品負責，同時此樣品僅保留90天。本報告未經本公司書面許可，不可部份複製。

This document is issued by the Company subject to its General Conditions of Service printed overleaf, available on request or accessible at <http://www.sgs.com.tw/Terms-and-Conditions> and for electronic format documents, subject to Terms and Conditions for Electronic Documents at <http://www.sgs.com.tw/Terms-and-Conditions>. Attention is drawn to the limitation of liability, indemnification and jurisdiction issues defined therein. Any holder of this document is advised that information contained hereon reflects the Company's findings at the time of its intervention only and within the limits of Client's instructions, if any. The Company's sole responsibility is to its Client and this document does not exonerate parties to a transaction from exercising all their rights and obligations under the transaction documents. This document cannot be reproduced except in full, without prior written approval of the Company. Any unauthorized alteration, forgery or falsification of the content or appearance of this document is unlawful and offenders may be prosecuted to the fullest extent of the law.

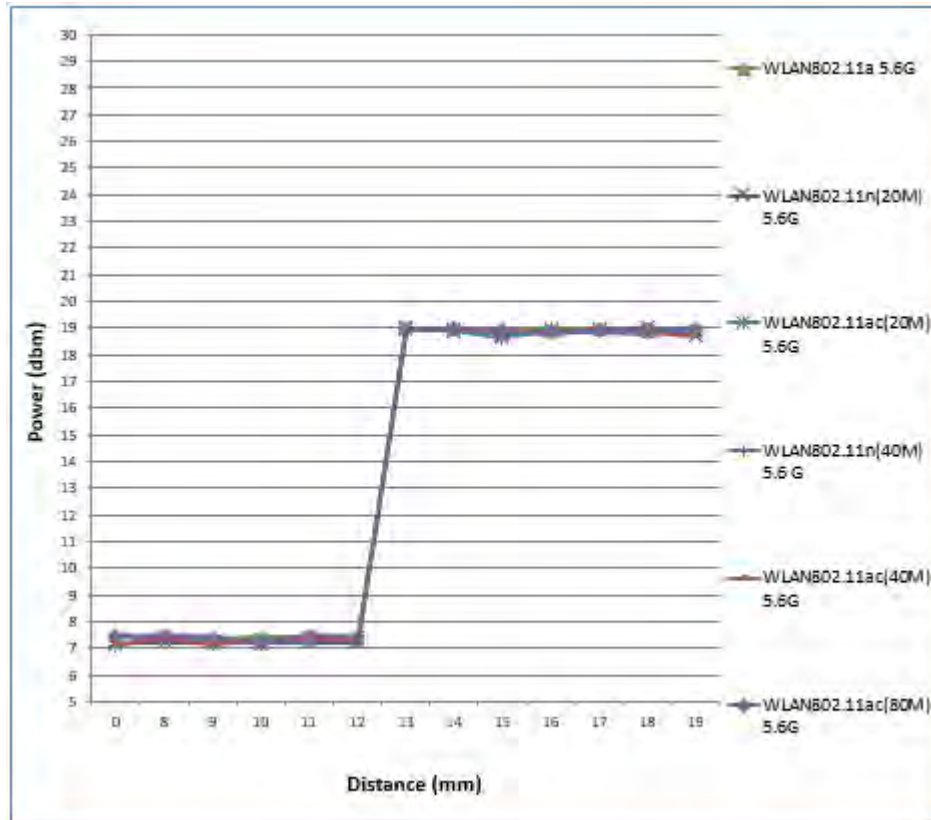

For WWAN/WLAN back side, the worst trigger distance of proximity sensor is 12mm, and we test backside SAR in 11mm with full power and 0mm with reduced power.

Unless otherwise stated the results shown in this test report refer only to the sample(s) tested and such sample(s) are retained for 90 days only.

除非另有說明，此報告結果僅對測試之樣品負責，同時此樣品僅保留90天。本報告未經本公司書面許可，不可部份複製。

This document is issued by the Company subject to its General Conditions of Service printed overleaf, available on request or accessible at <http://www.sgs.com.tw/Terms-and-Conditions> and for electronic format documents, subject to Terms and Conditions for Electronic Documents at <http://www.sgs.com.tw/Terms-and-Conditions>. Attention is drawn to the limitation of liability, indemnification and jurisdiction issues defined therein. Any holder of this document is advised that information contained hereon reflects the Company's findings at the time of its intervention only and within the limits of Client's instructions, if any. The Company's sole responsibility is to its Client and this document does not exonerate parties to a transaction from exercising all their rights and obligations under the transaction documents. This document cannot be reproduced except in full, without prior written approval of the Company. Any unauthorized alteration, forgery or falsification of the content or appearance of this document is unlawful and offenders may be prosecuted to the fullest extent of the law.

Top side

Moving device toward the phantom

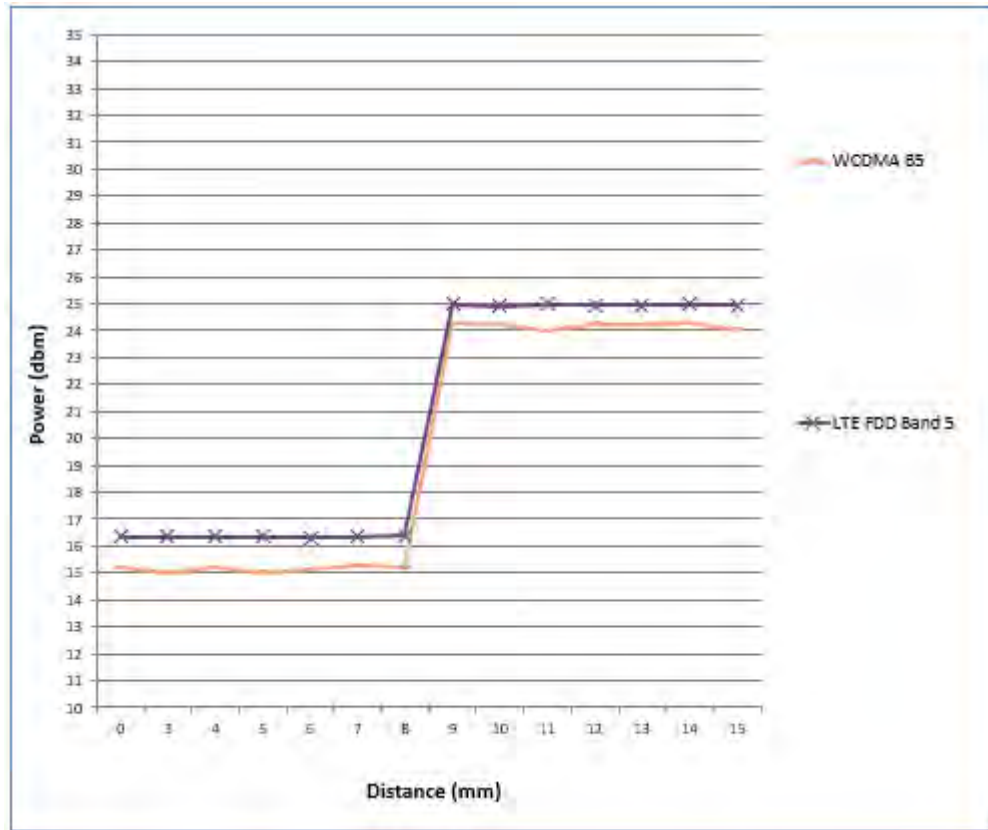

Unless otherwise stated the results shown in this test report refer only to the sample(s) tested and such sample(s) are retained for 90 days only.

除非另有說明，此報告結果僅對測試之樣品負責，同時此樣品僅保留90天。本報告未經本公司書面許可，不可部份複製。

This document is issued by the Company subject to its General Conditions of Service printed overleaf, available on request or accessible at <http://www.sgs.com.tw/Terms-and-Conditions> and for electronic format documents, subject to Terms and Conditions for Electronic Documents at <http://www.sgs.com.tw/Terms-and-Conditions>. Attention is drawn to the limitation of liability, indemnification and jurisdiction issues defined therein. Any holder of this document is advised that information contained hereon reflects the Company's findings at the time of its intervention only and within the limits of Client's instructions, if any. The Company's sole responsibility is to its Client and this document does not exonerate parties to a transaction from exercising all their rights and obligations under the transaction documents. This document cannot be reproduced except in full, without prior written approval of the Company. Any unauthorized alteration, forgery or falsification of the content or appearance of this document is unlawful and offenders may be prosecuted to the fullest extent of the law.

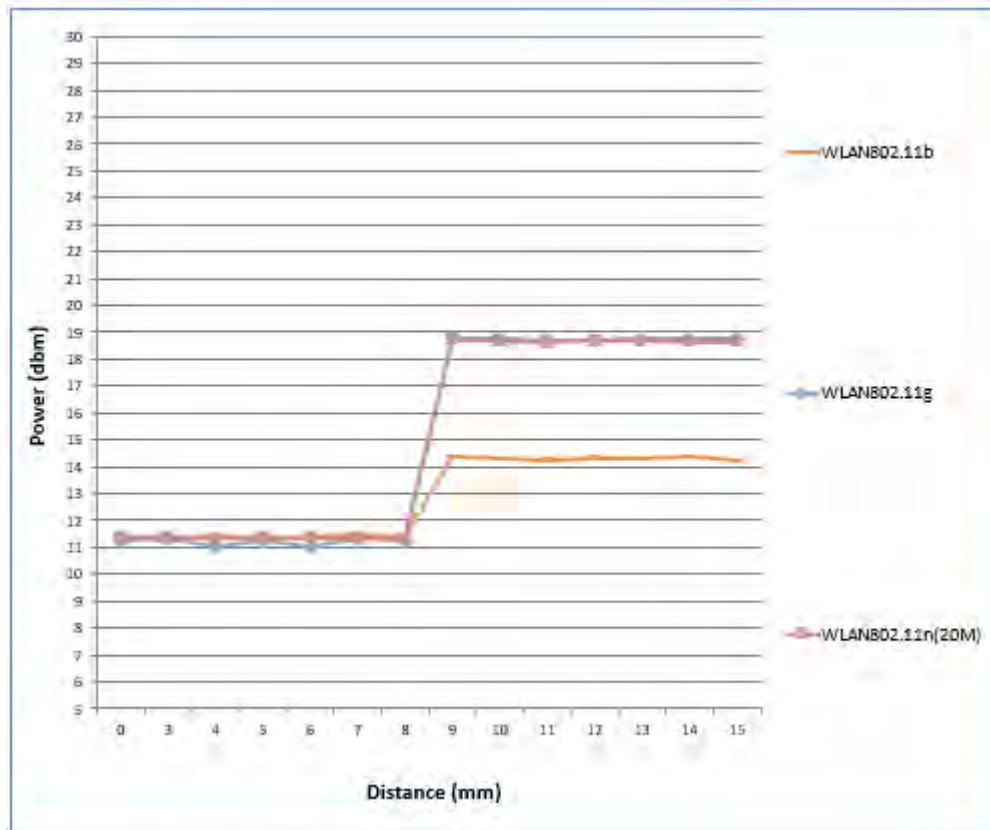

Unless otherwise stated the results shown in this test report refer only to the sample(s) tested and such sample(s) are retained for 90 days only.

除非另有說明，此報告結果僅對測試之樣品負責，同時此樣品僅保留90天。本報告未經本公司書面許可，不可部份複製。

This document is issued by the Company subject to its General Conditions of Service printed overleaf, available on request or accessible at <http://www.sgs.com.tw/Terms-and-Conditions> and for electronic format documents, subject to Terms and Conditions for Electronic Documents at <http://www.sgs.com.tw/Terms-and-Conditions>. Attention is drawn to the limitation of liability, indemnification and jurisdiction issues defined therein. Any holder of this document is advised that information contained hereon reflects the Company's findings at the time of its intervention only and within the limits of Client's instructions, if any. The Company's sole responsibility is to its Client and this document does not exonerate parties to a transaction from exercising all their rights and obligations under the transaction documents. This document cannot be reproduced except in full, without prior written approval of the Company. Any unauthorized alteration, forgery or falsification of the content or appearance of this document is unlawful and offenders may be prosecuted to the fullest extent of the law.

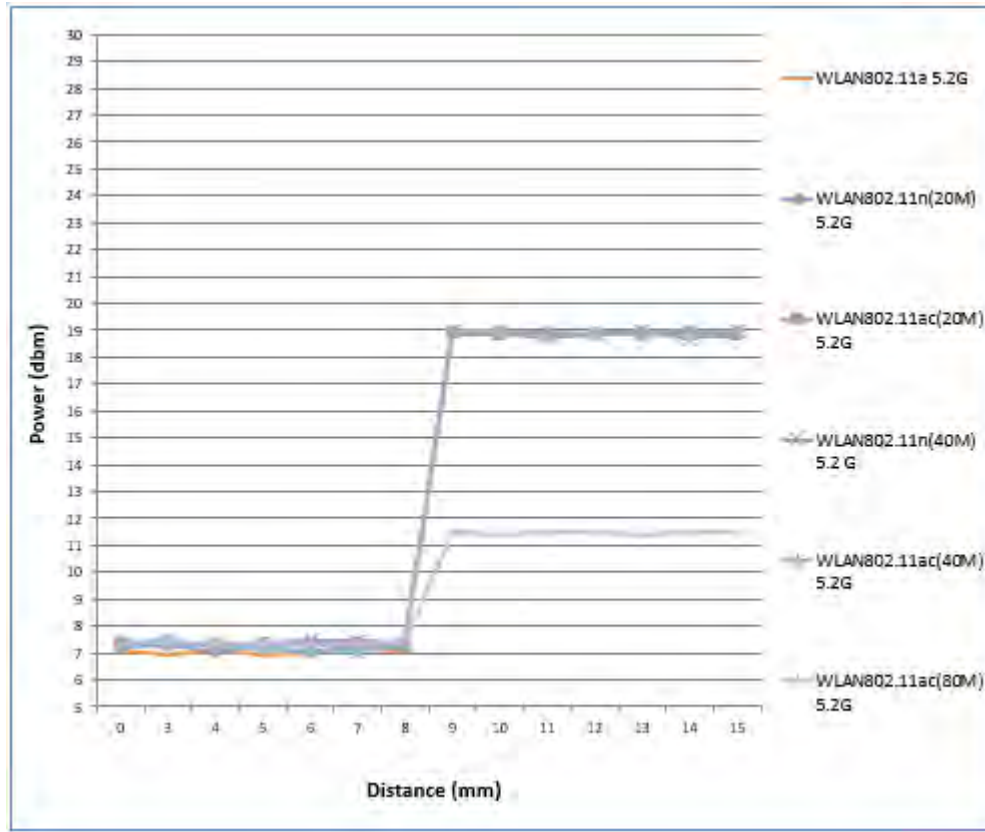

Unless otherwise stated the results shown in this test report refer only to the sample(s) tested and such sample(s) are retained for 90 days only.

除非另有說明，此報告結果僅對測試之樣品負責，同時此樣品僅保留90天。本報告未經本公司書面許可，不可部份複製。

This document is issued by the Company subject to its General Conditions of Service printed overleaf, available on request or accessible at <http://www.sgs.com.tw/Terms-and-Conditions> and for electronic format documents, subject to Terms and Conditions for Electronic Documents at <http://www.sgs.com.tw/Terms-and-Conditions>. Attention is drawn to the limitation of liability, indemnification and jurisdiction issues defined therein. Any holder of this document is advised that information contained hereon reflects the Company's findings at the time of its intervention only and within the limits of Client's instructions, if any. The Company's sole responsibility is to its Client and this document does not exonerate parties to a transaction from exercising all their rights and obligations under the transaction documents. This document cannot be reproduced except in full, without prior written approval of the Company. Any unauthorized alteration, forgery or falsification of the content or appearance of this document is unlawful and offenders may be prosecuted to the fullest extent of the law.

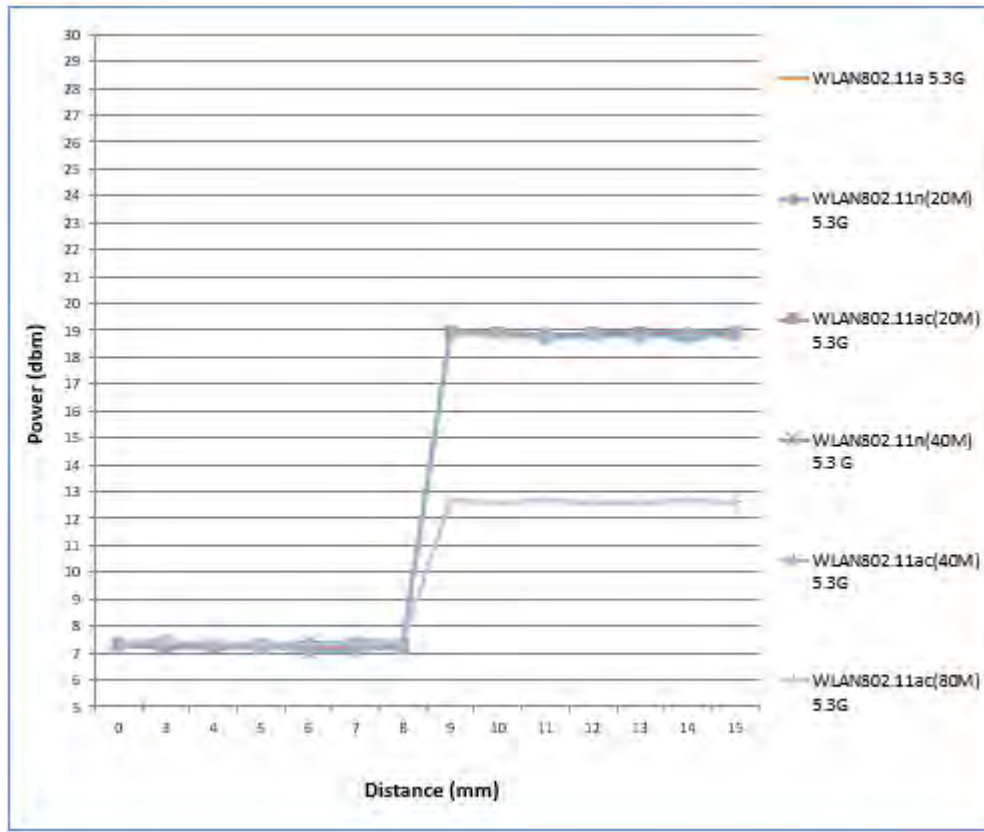

Unless otherwise stated the results shown in this test report refer only to the sample(s) tested and such sample(s) are retained for 90 days only.

除非另有說明，此報告結果僅對測試之樣品負責，同時此樣品僅保留90天。本報告未經本公司書面許可，不可部份複製。

This document is issued by the Company subject to its General Conditions of Service printed overleaf, available on request or accessible at <http://www.sgs.com.tw/Terms-and-Conditions> and for electronic format documents, subject to Terms and Conditions for Electronic Documents at <http://www.sgs.com.tw/Terms-and-Conditions>. Attention is drawn to the limitation of liability, indemnification and jurisdiction issues defined therein. Any holder of this document is advised that information contained hereon reflects the Company's findings at the time of its intervention only and within the limits of Client's instructions, if any. The Company's sole responsibility is to its Client and this document does not exonerate parties to a transaction from exercising all their rights and obligations under the transaction documents. This document cannot be reproduced except in full, without prior written approval of the Company. Any unauthorized alteration, forgery or falsification of the content or appearance of this document is unlawful and offenders may be prosecuted to the fullest extent of the law.

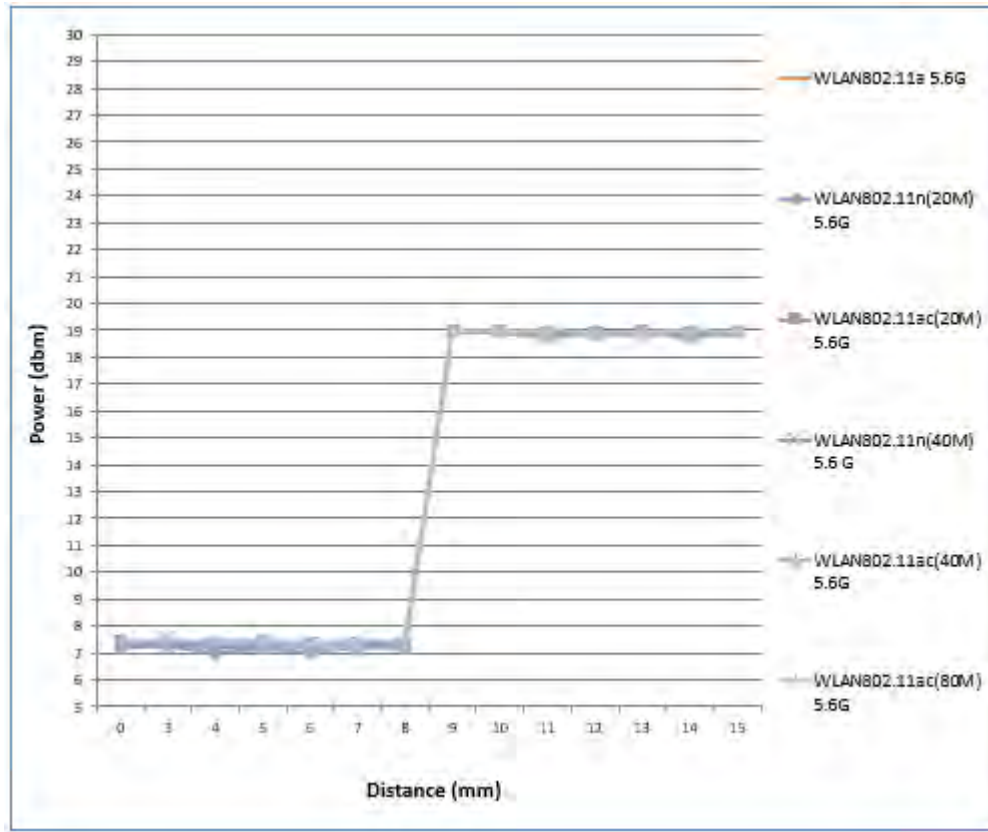

Unless otherwise stated the results shown in this test report refer only to the sample(s) tested and such sample(s) are retained for 90 days only.

除非另有說明，此報告結果僅對測試之樣品負責，同時此樣品僅保留90天。本報告未經本公司書面許可，不可部份複製。

This document is issued by the Company subject to its General Conditions of Service printed overleaf, available on request or accessible at <http://www.sgs.com.tw/Terms-and-Conditions> and for electronic format documents, subject to Terms and Conditions for Electronic Documents at <http://www.sgs.com.tw/Terms-and-Conditions>. Attention is drawn to the limitation of liability, indemnification and jurisdiction issues defined therein. Any holder of this document is advised that information contained hereon reflects the Company's findings at the time of its intervention only and within the limits of Client's instructions, if any. The Company's sole responsibility is to its Client and this document does not exonerate parties to a transaction from exercising all their rights and obligations under the transaction documents. This document cannot be reproduced except in full, without prior written approval of the Company. Any unauthorized alteration, forgery or falsification of the content or appearance of this document is unlawful and offenders may be prosecuted to the fullest extent of the law.

Moving device away from the phantom

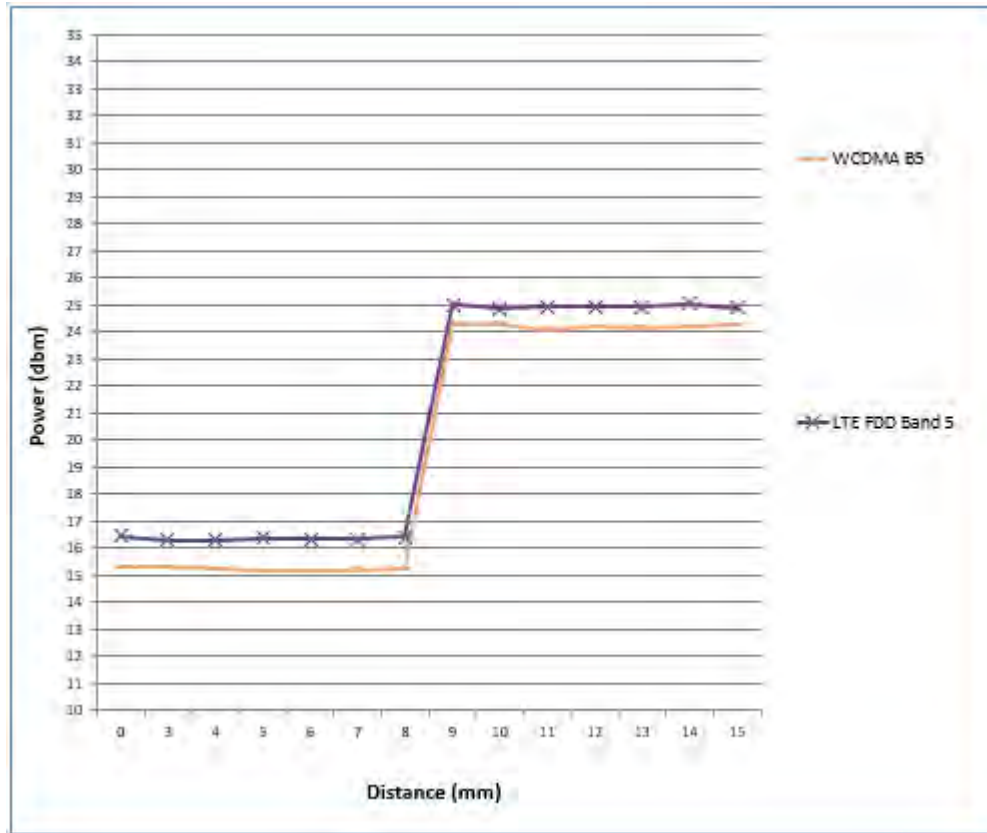

Unless otherwise stated the results shown in this test report refer only to the sample(s) tested and such sample(s) are retained for 90 days only.

除非另有說明，此報告結果僅對測試之樣品負責，同時此樣品僅保留90天。本報告未經本公司書面許可，不可部份複製。

This document is issued by the Company subject to its General Conditions of Service printed overleaf, available on request or accessible at <http://www.sgs.com.tw/Terms-and-Conditions> and for electronic format documents, subject to Terms and Conditions for Electronic Documents at <http://www.sgs.com.tw/Terms-and-Conditions>. Attention is drawn to the limitation of liability, indemnification and jurisdiction issues defined therein. Any holder of this document is advised that information contained hereon reflects the Company's findings at the time of its intervention only and within the limits of Client's instructions, if any. The Company's sole responsibility is to its Client and this document does not exonerate parties to a transaction from exercising all their rights and obligations under the transaction documents. This document cannot be reproduced except in full, without prior written approval of the Company. Any unauthorized alteration, forgery or falsification of the content or appearance of this document is unlawful and offenders may be prosecuted to the fullest extent of the law.

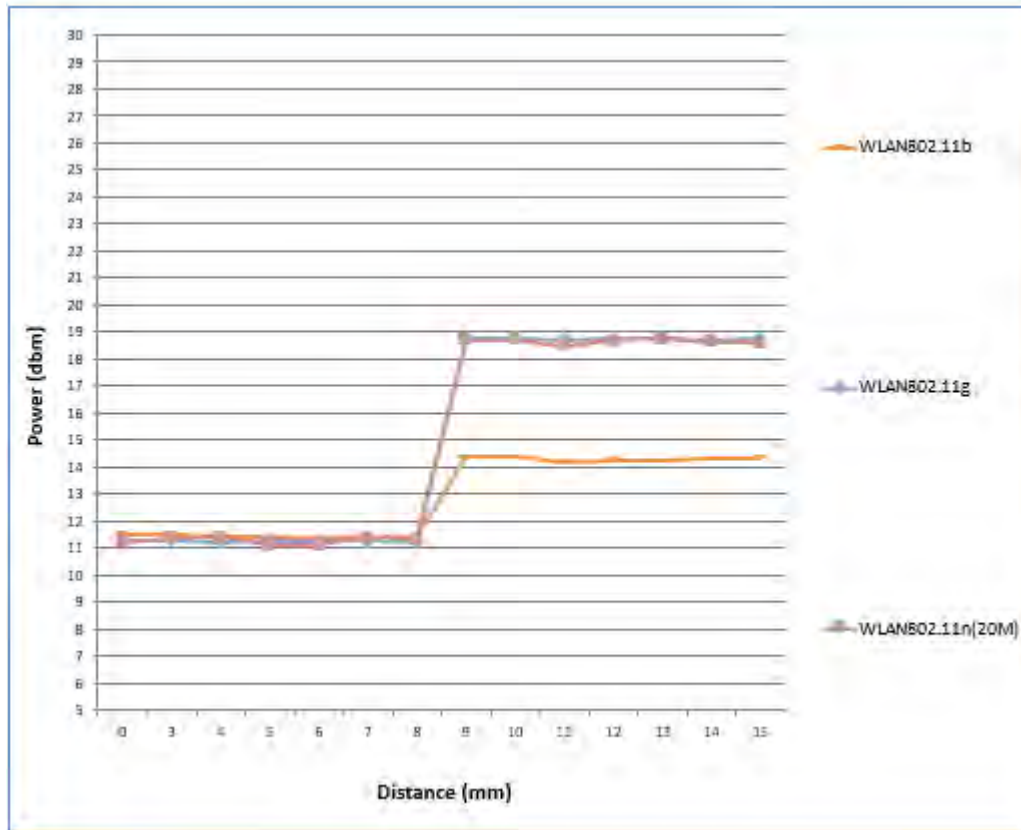

Unless otherwise stated the results shown in this test report refer only to the sample(s) tested and such sample(s) are retained for 90 days only.

除非另有說明，此報告結果僅對測試之樣品負責，同時此樣品僅保留90天。本報告未經本公司書面許可，不可部份複製。

This document is issued by the Company subject to its General Conditions of Service printed overleaf, available on request or accessible at <http://www.sgs.com.tw/Terms-and-Conditions> and for electronic format documents, subject to Terms and Conditions for Electronic Documents at <http://www.sgs.com.tw/Terms-and-Conditions>. Attention is drawn to the limitation of liability, indemnification and jurisdiction issues defined therein. Any holder of this document is advised that information contained hereon reflects the Company's findings at the time of its intervention only and within the limits of Client's instructions, if any. The Company's sole responsibility is to its Client and this document does not exonerate parties to a transaction from exercising all their rights and obligations under the transaction documents. This document cannot be reproduced except in full, without prior written approval of the Company. Any unauthorized alteration, forgery or falsification of the content or appearance of this document is unlawful and offenders may be prosecuted to the fullest extent of the law.

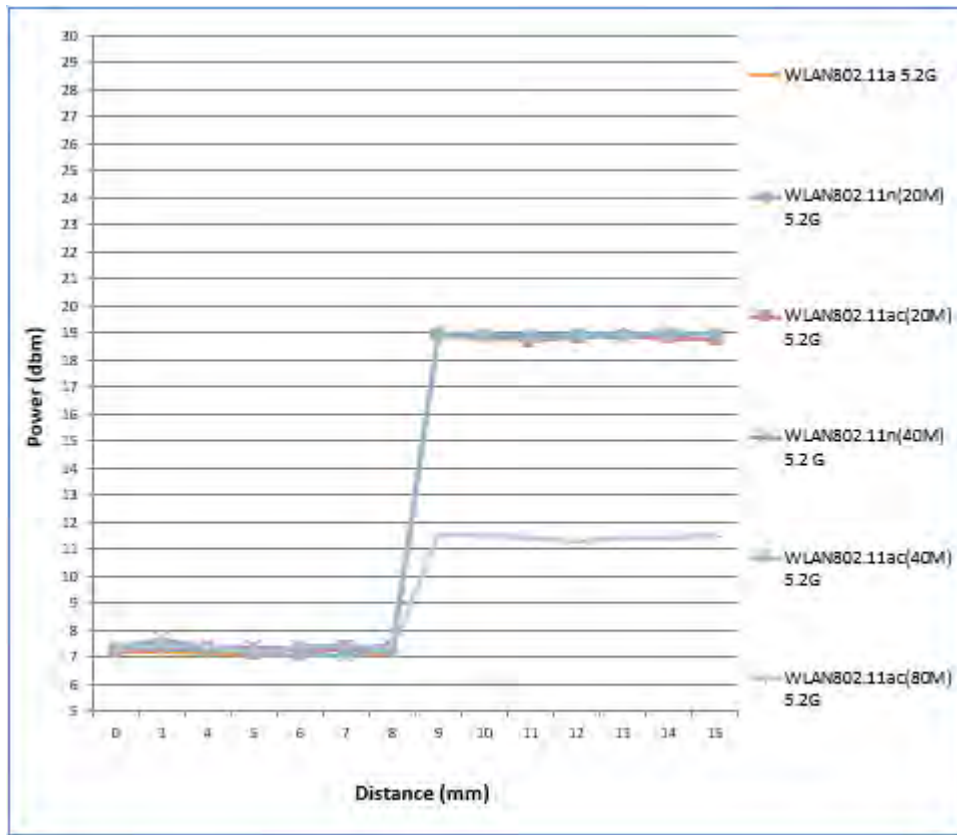

Unless otherwise stated the results shown in this test report refer only to the sample(s) tested and such sample(s) are retained for 90 days only.

除非另有說明，此報告結果僅對測試之樣品負責，同時此樣品僅保留90天。本報告未經本公司書面許可，不可部份複製。

This document is issued by the Company subject to its General Conditions of Service printed overleaf, available on request or accessible at <http://www.sgs.com.tw/Terms-and-Conditions> and for electronic format documents, subject to Terms and Conditions for Electronic Documents at <http://www.sgs.com.tw/Terms-and-Conditions>. Attention is drawn to the limitation of liability, indemnification and jurisdiction issues defined therein. Any holder of this document is advised that information contained hereon reflects the Company's findings at the time of its intervention only and within the limits of Client's instructions, if any. The Company's sole responsibility is to its Client and this document does not exonerate parties to a transaction from exercising all their rights and obligations under the transaction documents. This document cannot be reproduced except in full, without prior written approval of the Company. Any unauthorized alteration, forgery or falsification of the content or appearance of this document is unlawful and offenders may be prosecuted to the fullest extent of the law.

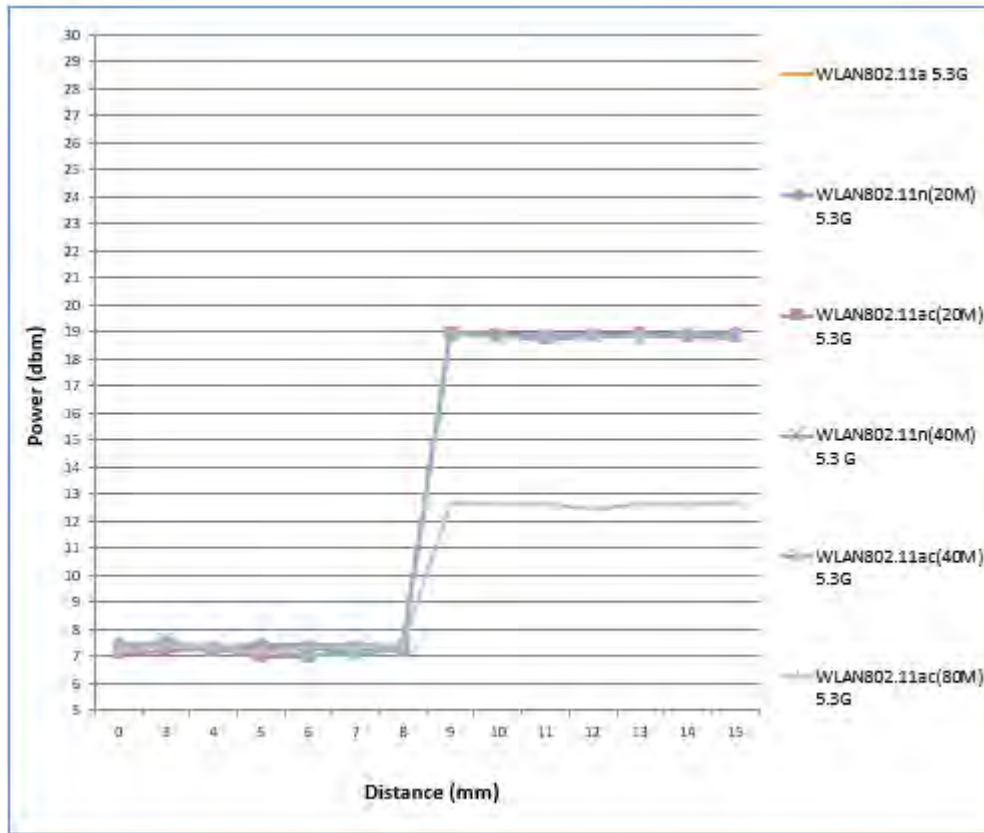

Unless otherwise stated the results shown in this test report refer only to the sample(s) tested and such sample(s) are retained for 90 days only.

除非另有說明，此報告結果僅對測試之樣品負責，同時此樣品僅保留90天。本報告未經本公司書面許可，不可部份複製。

This document is issued by the Company subject to its General Conditions of Service printed overleaf, available on request or accessible at <http://www.sgs.com.tw/Terms-and-Conditions> and for electronic format documents, subject to Terms and Conditions for Electronic Documents at <http://www.sgs.com.tw/Terms-and-Conditions>. Attention is drawn to the limitation of liability, indemnification and jurisdiction issues defined therein. Any holder of this document is advised that information contained hereon reflects the Company's findings at the time of its intervention only and within the limits of Client's instructions, if any. The Company's sole responsibility is to its Client and this document does not exonerate parties to a transaction from exercising all their rights and obligations under the transaction documents. This document cannot be reproduced except in full, without prior written approval of the Company. Any unauthorized alteration, forgery or falsification of the content or appearance of this document is unlawful and offenders may be prosecuted to the fullest extent of the law.

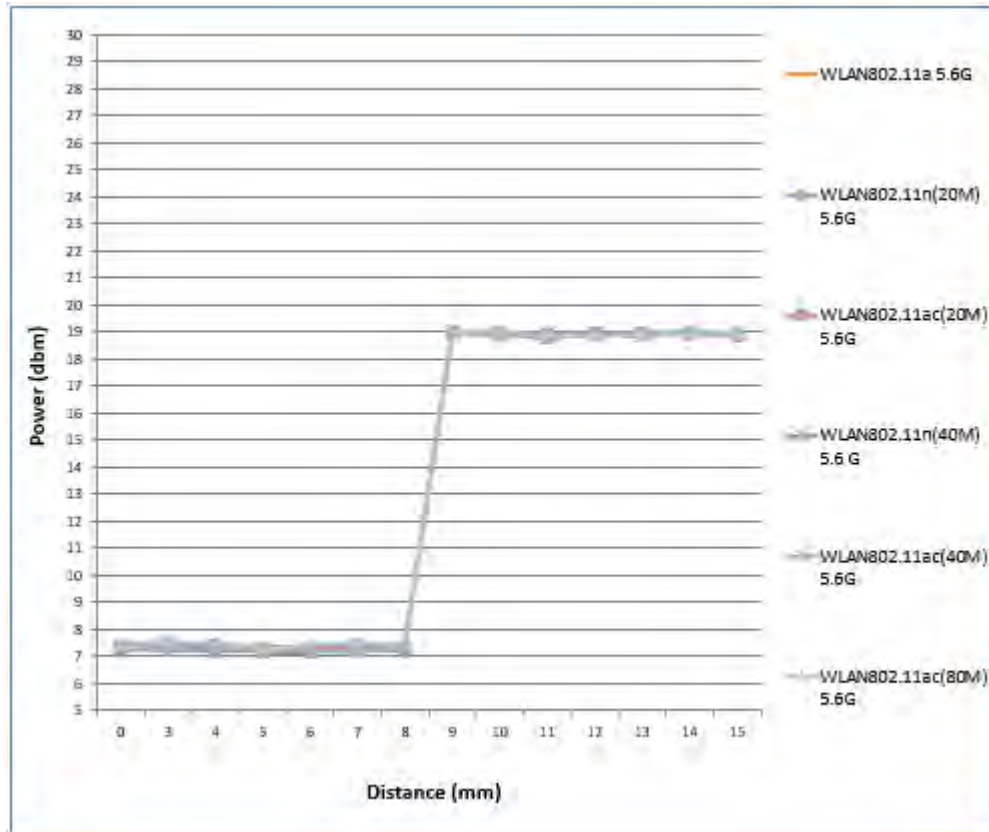

Table 1.6.5 Tilt angle test results for WWAN/WLAN top side

P-sensor ON/OFF	-50 deg	-45 deg	-40 deg	-30 deg	-20 deg	-10 deg	0 deg	10 deg	20 deg	30 deg	40 deg	45 deg	50 deg
8mm	ON	ON	ON	ON	ON	ON	ON	ON	ON	ON	ON	ON	ON

During the tilt angle testing for WWAN/WLAN top side, the sensor is not released in 8mm, so 8-1=7mm is used in the SAR measurement.

Note:

1. The triggering variations and hysteresis effect has been evaluated separately according to the tissue-equivalent medium required for each frequency band, and sensor triggering does not change with different tissue-equivalent media.
2. Conducted power is monitored qualitatively to identify the general triggering characteristics and recorded quantitatively, versus spacing.

Unless otherwise stated the results shown in this test report refer only to the sample(s) tested and such sample(s) are retained for 90 days only.

除非另有說明，此報告結果僅對測試之樣品負責，同時此樣品僅保留90天。本報告未經本公司書面許可，不可部份複製。
 This document is issued by the Company subject to its General Conditions of Service printed overleaf, available on request or accessible at <http://www.sgs.com.tw/Terms-and-Conditions> and for electronic format documents, subject to Terms and Conditions for Electronic Documents at <http://www.sgs.com.tw/Terms-and-Conditions>. Attention is drawn to the limitation of liability, indemnification and jurisdiction issues defined therein. Any holder of this document is advised that information contained hereon reflects the Company's findings at the time of its intervention only and within the limits of Client's instructions, if any. The Company's sole responsibility is to its Client and this document does not exonerate parties to a transaction from exercising all their rights and obligations under the transaction documents. This document cannot be reproduced except in full, without prior written approval of the Company. Any unauthorized alteration, forgery or falsification of the content or appearance of this document is unlawful and offenders may be prosecuted to the fullest extent of the law.

1.6.6 Operation description for P-sensor

Power Reduction Design Specification (for P-sensor)

The mechanism of power reduction is used for WWAN/WLAN. The reduced power scenario for each technology/band is defined in Table1-1. With P-sensor mechanism, please refer to WWAN/WLAN reduced power table in section 1.3 to be the WWAN/WLAN default power when P-sensor failure or malfunction.

Table1-1 : The power reduction scenario table

Transmission mode	Band	Power Reduction
WWAN	WCDMA B V / LTE B5	YES
WLAN	All	YES

Unless otherwise stated the results shown in this test report refer only to the sample(s) tested and such sample(s) are retained for 90 days only.

除非另有說明，此報告結果僅對測試之樣品負責，同時此樣品僅保留90天。本報告未經本公司書面許可，不可部份複製。

This document is issued by the Company subject to its General Conditions of Service printed overleaf, available on request or accessible at <http://www.sgs.com.tw/Terms-and-Conditions> and for electronic format documents, subject to Terms and Conditions for Electronic Documents at <http://www.sgs.com.tw/Terms-and-Conditions>. Attention is drawn to the limitation of liability, indemnification and jurisdiction issues defined therein. Any holder of this document is advised that information contained hereon reflects the Company's findings at the time of its intervention only and within the limits of Client's instructions, if any. The Company's sole responsibility is to its Client and this document does not exonerate parties to a transaction from exercising all their rights and obligations under the transaction documents. This document cannot be reproduced except in full, without prior written approval of the Company. Any unauthorized alteration, forgery or falsification of the content or appearance of this document is unlawful and offenders may be prosecuted to the fullest extent of the law.

1.7 The SAR Measurement System

A block diagram of the SAR measurement System is given in Fig. a. This SAR Measurement System uses a Computer-controlled 3-D stepper motor system (SPEAG DASY 5 professional system). The model EX3DV4 field probe is used to determine the internal electric fields. The SAR can be obtained from the equation $SAR = \sigma (|E_{i}|^2) / \rho$ where σ and ρ are the conductivity and mass density of the tissue-simulant.

The DASY 5 system for performing compliance tests consists of the following items:

1. A standard high precision 6-axis robot (Staubli RX family) with controller, teach pendant and software. An arm extension is for accommodating the data acquisition electronics (DAE).
2. A dosimetric probe, i.e., an isotropic E-field probe optimized and calibrated for usage in tissue simulating liquid. The probe is equipped with an optical surface detector system.
3. A data acquisition electronics (DAE) which performs the signal amplification, signal multiplexing, AD-conversion, offset measurements, mechanical surface detection, collision detection, etc. The unit is battery powered with standard or rechargeable batteries. The signal is optically transmitted to the EOC.

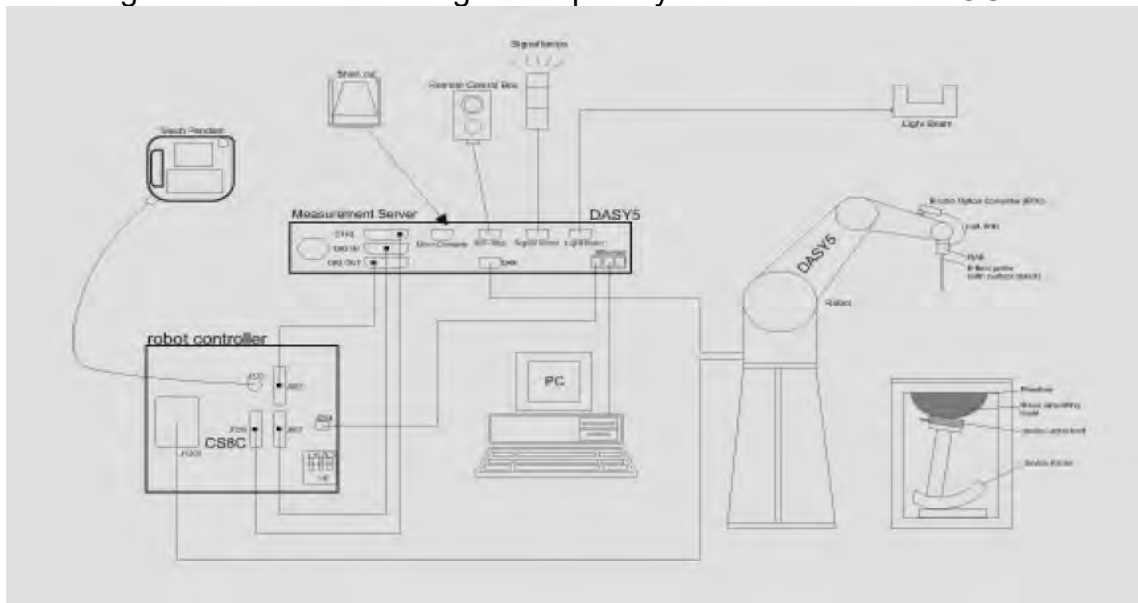

Fig. a The block diagram of SAR system

Unless otherwise stated the results shown in this test report refer only to the sample(s) tested and such sample(s) are retained for 90 days only.
除非另有說明，此報告結果僅對測試之樣品負責，同時此樣品僅保留90天。本報告未經本公司書面許可，不可部份複製。

This document is issued by the Company subject to its General Conditions of Service printed overleaf, available on request or accessible at <http://www.sgs.com.tw/Terms-and-Conditions> and for electronic format documents, subject to Terms and Conditions for Electronic Documents at <http://www.sgs.com.tw/Terms-and-Conditions>. Attention is drawn to the limitation of liability, indemnification and jurisdiction issues defined therein. Any holder of this document is advised that information contained hereon reflects the Company's findings at the time of its intervention only and within the limits of Client's instructions, if any. The Company's sole responsibility is to its Client and this document does not exonerate parties to a transaction from exercising all their rights and obligations under the transaction documents. This document cannot be reproduced except in full, without prior written approval of the Company. Any unauthorized alteration, forgery or falsification of the content or appearance of this document is unlawful and offenders may be prosecuted to the fullest extent of the law.

4. The Electro-optical converter (EOC) performs the conversion between optical and electrical of the signals for the digital communication to the DAE and for the analog signal from the optical surface detection. The EOC is connected to the measurement server.
5. The function of the measurement server is to perform the time critical tasks such as signal filtering, control of the robot operation and fast movement interrupts.
6. A probe alignment unit which improves the (absolute) accuracy of the probe positioning.
7. A computer operating Windows 7.
8. DASY 5 software.
9. Remote control with teach pendant and additional circuitry for robot safety such as warning lamps, etc.
10. Tissue simulating liquid mixed according to the given recipes.
11. Validation dipole kits allowing to validate the proper functioning of the system.

Unless otherwise stated the results shown in this test report refer only to the sample(s) tested and such sample(s) are retained for 90 days only.

除非另有說明，此報告結果僅對測試之樣品負責，同時此樣品僅保留90天。本報告未經本公司書面許可，不可部份複製。

This document is issued by the Company subject to its General Conditions of Service printed overleaf, available on request or accessible at <http://www.sgs.com.tw/Terms-and-Conditions> and for electronic format documents, subject to Terms and Conditions for Electronic Documents at <http://www.sgs.com.tw/Terms-and-Conditions>. Attention is drawn to the limitation of liability, indemnification and jurisdiction issues defined therein. Any holder of this document is advised that information contained hereon reflects the Company's findings at the time of its intervention only and within the limits of Client's instructions, if any. The Company's sole responsibility is to its Client and this document does not exonerate parties to a transaction from exercising all their rights and obligations under the transaction documents. This document cannot be reproduced except in full, without prior written approval of the Company. Any unauthorized alteration, forgery or falsification of the content or appearance of this document is unlawful and offenders may be prosecuted to the fullest extent of the law.

1.8 System Components

EX3DV4 E-Field Probe

Construction	Symmetrical design with triangular core Built-in shielding against static charges PEEK enclosure material (resistant to organic solvents, e.g., DGBE)	
Calibration	Basic Broad Band Calibration in air Conversion Factors (CF) for HSL 835/2450/5200/5300/5600 MHz Additional CF for other liquids and frequencies upon request	
Frequency	10 MHz to > 6 GHz	
Directivity	± 0.3 dB in HSL (rotation around probe axis) ± 0.5 dB in tissue material (rotation normal to probe axis)	
Dynamic Range	10 µW/g to > 100 mW/g Linearity: ± 0.2 dB (noise: typically < 1 µW/g)	
Dimensions	Tip diameter: 2.5 mm	
Application	High precision dosimetric measurements in any exposure scenario (e.g., very strong gradient fields). Only probe which enables compliance testing for frequencies up to 6 GHz with precision of better 30%.	

Unless otherwise stated the results shown in this test report refer only to the sample(s) tested and such sample(s) are retained for 90 days only.
除非另有說明，此報告結果僅對測試之樣品負責，同時此樣品僅保留90天。本報告未經本公司書面許可，不可部份複製。

This document is issued by the Company subject to its General Conditions of Service printed overleaf, available on request or accessible at <http://www.sgs.com.tw/Terms-and-Conditions> and for electronic format documents, subject to Terms and Conditions for Electronic Documents at <http://www.sgs.com.tw/Terms-and-Conditions>. Attention is drawn to the limitation of liability, indemnification and jurisdiction issues defined therein. Any holder of this document is advised that information contained hereon reflects the Company's findings at the time of its intervention only and within the limits of Client's instructions, if any. The Company's sole responsibility is to its Client and this document does not exonerate parties to a transaction from exercising all their rights and obligations under the transaction documents. This document cannot be reproduced except in full, without prior written approval of the Company. Any unauthorized alteration, forgery or falsification of the content or appearance of this document is unlawful and offenders may be prosecuted to the fullest extent of the law.

SGS Taiwan Ltd. | No.134,Wu Kung Road, New Taipei Industrial Park, Wuku District, New Taipei City, Taiwan/新北市五股區新北產業園區五工路 134 號

PHANTOM

Model	ELI	
Construction	The ELI phantom is used for compliance testing of handheld and body-mounted wireless devices in the frequency range of 30 MHz to 6 GHz. ELI is fully compatible with the IEC 62209-2 standard and all known tissue simulating liquids. ELI has been optimized regarding its performance and can be integrated into our standard phantom tables. A cover prevents evaporation of the liquid. Reference markings on the phantom allow installation of the complete setup, including all predefined phantom positions and measurement grids, by teaching three points. The phantom is compatible with all SPEAG dosimetric probes and dipoles.	
Shell Thickness	2 ± 0.2 mm	
Filling Volume	Approx. 30 liters	
Dimensions	Major axis: 600 mm Minor axis: 400 mm	

DEVICE HOLDER

Construction	The device holder (Supporter) for Notebook is made by POM (polyoxymethylene resin) , which is non-metal and non-conductive. The height can be adjusted to fit varies kind of notebooks.	
		Device Holder

Unless otherwise stated the results shown in this test report refer only to the sample(s) tested and such sample(s) are retained for 90 days only.

除非另有說明，此報告結果僅對測試之樣品負責，同時此樣品僅保留90天。本報告未經本公司書面許可，不可部份複製。

This document is issued by the Company subject to its General Conditions of Service printed overleaf, available on request or accessible at <http://www.sgs.com.tw/Terms-and-Conditions> and for electronic format documents, subject to Terms and Conditions for Electronic Documents at <http://www.sgs.com.tw/Terms-and-Conditions>. Attention is drawn to the limitation of liability, indemnification and jurisdiction issues defined therein. Any holder of this document is advised that information contained hereon reflects the Company's findings at the time of its intervention only and within the limits of Client's instructions, if any. The Company's sole responsibility is to its Client and this document does not exonerate parties to a transaction from exercising all their rights and obligations under the transaction documents. This document cannot be reproduced except in full, without prior written approval of the Company. Any unauthorized alteration, forgery or falsification of the content or appearance of this document is unlawful and offenders may be prosecuted to the fullest extent of the law.

1.9 SAR System Verification

The microwave circuit arrangement for system verification is sketched in Fig. b. The daily system accuracy verification occurs within the flat section of the SAM phantom. A SAR measurement was performed to see if the measured SAR was within $\pm 10\%$ from the target SAR values. These tests were done at 835/2450/5200/5300/5600 MHz. The tests were conducted on the same days as the measurement of the DUT. The obtained results from the system accuracy verification are displayed in the table 1 (SAR values are normalized to 1W forward power delivered to the dipole). During the tests, the liquid depth above the ear reference points was $\geq 15 \text{ cm} \pm 5 \text{ mm}$ (frequency $\leq 3 \text{ GHz}$) or $\geq 10 \text{ cm} \pm 5 \text{ mm}$ (frequency $> 3 \text{ GHz}$) in all the cases. It is seen that the system is operating within its specification, as the results are within acceptable tolerance of the reference values.

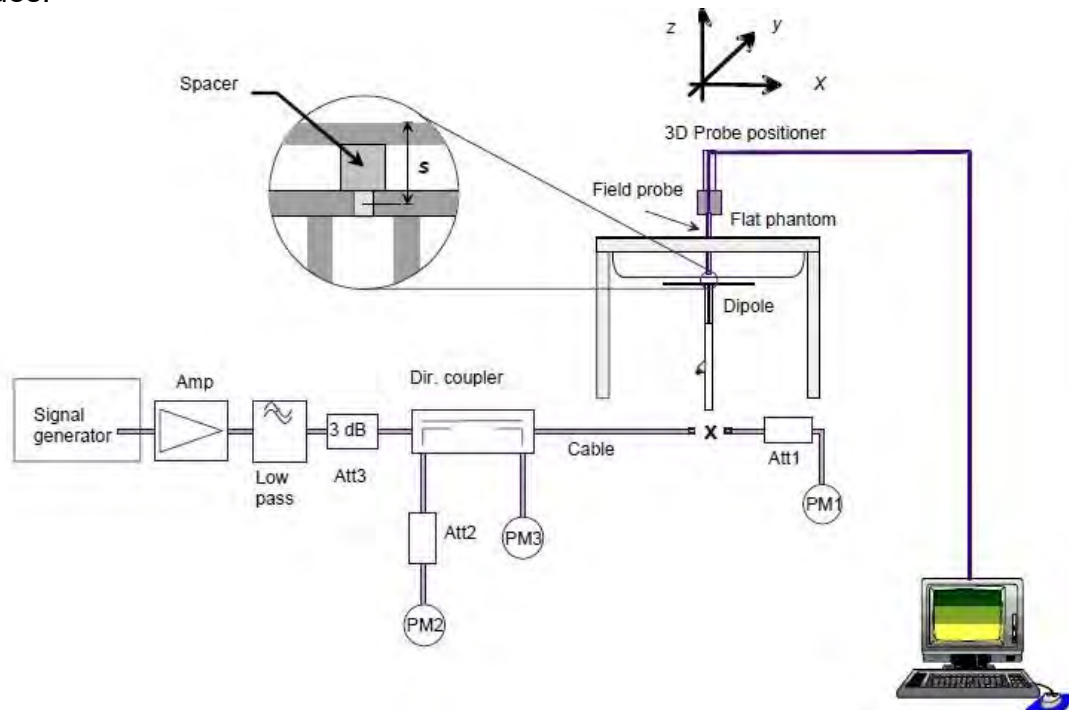

Fig. b The block diagram of system verification

Unless otherwise stated the results shown in this test report refer only to the sample(s) tested and such sample(s) are retained for 90 days only.
 除非另有說明，此報告結果僅對測試之樣品負責，同時此樣品僅保留90天。本報告未經本公司書面許可，不可部份複製。

This document is issued by the Company subject to its General Conditions of Service printed overleaf, available on request or accessible at <http://www.sgs.com.tw/Terms-and-Conditions> and for electronic format documents, subject to Terms and Conditions for Electronic Documents at <http://www.sgs.com.tw/Terms-and-Conditions>. Attention is drawn to the limitation of liability, indemnification and jurisdiction issues defined therein. Any holder of this document is advised that information contained hereon reflects the Company's findings at the time of its intervention only and within the limits of Client's instructions, if any. The Company's sole responsibility is to its Client and this document does not exonerate parties to a transaction from exercising all their rights and obligations under the transaction documents. This document cannot be reproduced except in full, without prior written approval of the Company. Any unauthorized alteration, forgery or falsification of the content or appearance of this document is unlawful and offenders may be prosecuted to the fullest extent of the law.

Validation Kit	S/N	Frequency (MHz)		1W Target SAR-1g (mW/g)	pin=250mW Measured SAR-1g (mW/g)	Measured SAR-1g normalized to 1W (mW/g)	Deviation (%)	Measured Date
D835V2	4d063	835	Head	9.57	2.44	9.76	1.99%	May. 20, 2020
D2450V2	727	2450	Head	52.6	13.30	53.2	1.14%	Jun. 04, 2020
Validation Kit	S/N	Frequency (MHz)		1W Target SAR-1g (mW/g)	Pin=100mW Measured SAR-1g (mW/g)	Measured SAR-1g normalized to 1W (mW/g)	Deviation (%)	Measured Date
D5GHzV2	1023	5200	Head	80.1	8.13	81.3	1.50%	Jun. 05, 2020
		5300	Head	82.8	8.25	82.5	-0.36%	Jun. 06, 2020
		5600	Head	83.1	8.42	84.2	1.32%	May. 24, 2020

Table 1. Results of system validation

Unless otherwise stated the results shown in this test report refer only to the sample(s) tested and such sample(s) are retained for 90 days only.

除非另有說明，此報告結果僅對測試之樣品負責，同時此樣品僅保留90天。本報告未經本公司書面許可，不可部份複製。

This document is issued by the Company subject to its General Conditions of Service printed overleaf, available on request or accessible at <http://www.sgs.com.tw/Terms-and-Conditions> and for electronic format documents, subject to Terms and Conditions for Electronic Documents at <http://www.sgs.com.tw/Terms-and-Conditions>. Attention is drawn to the limitation of liability, indemnification and jurisdiction issues defined therein. Any holder of this document is advised that information contained hereon reflects the Company's findings at the time of its intervention only and within the limits of Client's instructions, if any. The Company's sole responsibility is to its Client and this document does not exonerate parties to a transaction from exercising all their rights and obligations under the transaction documents. This document cannot be reproduced except in full, without prior written approval of the Company. Any unauthorized alteration, forgery or falsification of the content or appearance of this document is unlawful and offenders may be prosecuted to the fullest extent of the law.

1.0 Tissue Simulant Fluid for the Frequency Band

The dielectric properties for this Head-simulant fluid were measured by using the Agilent Model 85070E Dielectric Probe (rates frequency band 200 MHz to 20 GHz) in conjunction with Network Analyzer.

All dielectric parameters of tissue simulates were measured within 24 hours of SAR measurements. The measured conductivity and permittivity are all within $\pm 5\%$ of the target values.

The depth of the tissue simulant in the flat section of the phantom was $\geq 15 \text{ cm} \pm 5 \text{ mm}$ (Frequency $\leq 3\text{G}$) or $\geq 10 \text{ cm} \pm 5 \text{ mm}$ (Frequency $>3\text{G}$) during all tests. (Fig. 2)

Tissue Type	Measurement Date	Measured Frequency (MHz)	Target Dielectric Constant, ϵ_r	Target Conductivity, σ (S/m)	Measured Dielectric Constant, ϵ_r	Measured Conductivity, σ (S/m)	% dev ϵ_r	% dev σ
Head	May, 20. 2020	826.4	41.545	0.899	41.216	0.890	-0.79%	-1.04%
		829	41.531	0.900	41.199	0.891	-0.80%	-0.95%
		835	41.500	0.900	41.183	0.892	-0.76%	-0.89%
		836.5	41.500	0.902	41.176	0.893	-0.78%	-0.96%
		836.6	41.500	0.902	41.156	0.892	-0.83%	-1.08%
		844	41.500	0.910	41.147	0.901	-0.85%	-0.96%
		846.6	41.500	0.912	41.189	0.903	-0.75%	-1.04%
	Jun, 04. 2020	2412	39.268	1.766	38.912	1.749	-0.91%	-0.98%
		2437	39.223	1.788	38.819	1.768	-1.03%	-1.14%
		2441	39.216	1.792	38.840	1.773	-0.96%	-1.06%
		2450	39.200	1.800	38.788	1.781	-1.05%	-1.06%
		2462	39.185	1.813	38.812	1.793	-0.95%	-1.11%
	Jun, 05. 2020	5190	35.997	4.645	35.727	4.611	-0.75%	-0.73%
		5200	35.986	4.655	35.698	4.623	-0.80%	-0.69%
		5210	35.974	4.665	35.690	4.632	-0.79%	-0.71%
		5230	35.951	4.686	35.660	4.651	-0.81%	-0.74%
	Jun, 06. 2020	5270	35.906	4.727	35.633	4.695	-0.76%	-0.67%
		5290	35.883	4.747	35.589	4.716	-0.82%	-0.66%
		5300	35.871	4.758	35.581	4.727	-0.81%	-0.64%
		5310	35.860	4.768	35.559	4.734	-0.84%	-0.71%
	May, 24. 2020	5600	35.529	5.065	35.255	5.028	-0.77%	-0.73%
		5610	35.517	5.075	35.247	5.041	-0.76%	-0.67%
		5690	35.426	5.157	35.132	5.123	-0.83%	-0.66%

Table 2. Dielectric Parameters of Tissue Simulant Fluid

Unless otherwise stated the results shown in this test report refer only to the sample(s) tested and such sample(s) are retained for 90 days only.

除非另有說明，此報告結果僅對測試之樣品負責，同時此樣品僅保留90天。本報告未經本公司書面許可，不可部份複製。

This document is issued by the Company subject to its General Conditions of Service printed overleaf, available on request or accessible at <http://www.sgs.com.tw/Terms-and-Conditions>, and for electronic format documents, subject to Terms and Conditions for Electronic Documents at <http://www.sgs.com.tw/Terms-and-Conditions>. Attention is drawn to the limitation of liability, indemnification and jurisdiction issues defined therein. Any holder of this document is advised that information contained hereon reflects the Company's findings at the time of its intervention only and within the limits of Client's instructions, if any. The Company's sole responsibility is to its Client and this document does not exonerate parties to a transaction from exercising all their rights and obligations under the transaction documents. This document cannot be reproduced except in full, without prior written approval of the Company. Any unauthorized alteration, forgery or falsification of the content or appearance of this document is unlawful and offenders may be prosecuted to the fullest extent of the law.

The composition of the tissue simulating liquid:

Frequency (MHz)	Mode	Ingredient						Total amount
		DGMBE	Water	Salt	Preventol D-7	Cellulose	Sugar	
850	Head	—	532.98 g	18.3 g	2.4 g	3.2 g	766 g	1.3L(Kg)
2450	Head	550ml	450ml	—	—	—	—	1.0L(Kg)

Simulating Liquids for 5 GHz, Manufactured by SPEAG:

Ingredients	Water	Esters, Emulsifiers, Inhibitors	Sodium and Salt
(% by weight)	60-80	20-40	0-1.5

Table 3. Recipes for tissue simulating liquid

Unless otherwise stated the results shown in this test report refer only to the sample(s) tested and such sample(s) are retained for 90 days only.

除非另有說明，此報告結果僅對測試之樣品負責，同時此樣品僅保留90天。本報告未經本公司書面許可，不可部份複製。

This document is issued by the Company subject to its General Conditions of Service printed overleaf, available on request or accessible at <http://www.sgs.com.tw/Terms-and-Conditions> and for electronic format documents, subject to Terms and Conditions for Electronic Documents at <http://www.sgs.com.tw/Terms-and-Conditions>. Attention is drawn to the limitation of liability, indemnification and jurisdiction issues defined therein. Any holder of this document is advised that information contained hereon reflects the Company's findings at the time of its intervention only and within the limits of Client's instructions, if any. The Company's sole responsibility is to its Client and this document does not exonerate parties to a transaction from exercising all their rights and obligations under the transaction documents. This document cannot be reproduced except in full, without prior written approval of the Company. Any unauthorized alteration, forgery or falsification of the content or appearance of this document is unlawful and offenders may be prosecuted to the fullest extent of the law.

SGS Taiwan Ltd. No.134,Wu Kung Road, New Taipei Industrial Park, Wuku District, New Taipei City, Taiwan/新北市五股區新北產業園區五工路 134 號

1.11 Evaluation Procedures

The entire evaluation of the spatial peak values is performed within the Post-processing engine (SEMCAD). The system always gives the maximum values for the 1 g and 10 g cubes. The algorithm to find the cube with highest averaged SAR is divided into the following stages:

1. The extraction of the measured data (grid and values) from the Zoom Scan.
2. The calculation of the SAR value at every measurement point based on all stored data (A/D values and measurement parameters)
3. The generation of a high-resolution mesh within the measured volume
4. The interpolation of all measured values from the measurement grid to the high-resolution grid
5. The extrapolation of the entire 3-D field distribution to the phantom surface over the distance from sensor to surface
6. The calculation of the averaged SAR within masses of 1g and 10g.

The probe is calibrated at the center of the dipole sensors that is located 1 to 2.7mm away from the probe tip. During measurements, the probe stops shortly above the phantom surface, depending on the probe and the surface detecting system. Both distances are included as parameters in the probe configuration file. The software always knows exactly how far away the measured point is from the surface. As the probe cannot directly measure at the surface, the values between the deepest measured point and the surface must be extrapolated. The angle between the probe axis and the surface normal line is less than 30 degree.

In the Area Scan, the gradient of the interpolation function is evaluated to find all the extreme of the SAR distribution. The uncertainty on the locations of the extreme is less than 1/20 of the grid size. Only local maximum within -2 dB of the global maximum are searched and passed for the Cube Scan measurement. In the Cube Scan, the interpolation function is used to extrapolate the Peak SAR from the lowest measurement points to the inner phantom surface (the extrapolation distance). The uncertainty increases with the extrapolation distance. To keep the uncertainty within 1% for the 1 g and 10 g cubes, the extrapolation distance should not be larger than 5mm.

The maximum search is automatically performed after each area scan measurement. It is based on splines in two or three dimensions. The procedure can find the maximum for most SAR distributions even with relatively large grid spacing. After the area scanning measurement, the probe is automatically moved to a position at the interpolated maximum. The following scan can directly use this position for reference, e.g., for a finer resolution grid or the cube evaluations. The 1g and 10g peak evaluations are only available for the predefined cube 7x7x7 scans. The routines are verified and optimized for the grid dimensions used in these cube measurements.

The measured volume of 30x30x30mm contains about 30g of tissue.

The first procedure is an extrapolation (incl. Boundary correction) to get the points between the lowest measured plane and the surface. The next step uses 3D

Unless otherwise stated the results shown in this test report refer only to the sample(s) tested and such sample(s) are retained for 90 days only.

除非另有說明，此報告結果僅對測試之樣品負責，同時此樣品僅保留90天。本報告未經本公司書面許可，不可部份複製。

This document is issued by the Company subject to its General Conditions of Service printed overleaf, available on request or accessible at <http://www.sgs.com.tw/Terms-and-Conditions> and for electronic format documents, subject to Terms and Conditions for Electronic Documents at <http://www.sgs.com.tw/Terms-and-Conditions>. Attention is drawn to the limitation of liability, indemnification and jurisdiction issues defined therein. Any holder of this document is advised that information contained herein reflects the Company's findings at the time of its intervention only and within the limits of Client's instructions, if any. The Company's sole responsibility is to its Client and this document does not exonerate parties to a transaction from exercising all their rights and obligations under the transaction documents. This document cannot be reproduced except in full, without prior written approval of the Company. Any unauthorized alteration, forgery or falsification of the content or appearance of this document is unlawful and offenders may be prosecuted to the fullest extent of the law.

SGS Taiwan Ltd. No.134,Wu Kung Road, New Taipei Industrial Park, Wuku District, New Taipei City, Taiwan/新北市五股區新北產業園區五工路 134 號

interpolation to get all points within the measured volume. In the last step, a 1g cube is placed numerically into the volume and its averaged SAR is calculated. This cube is moved around until the highest averaged SAR is found. If the highest SAR is found at the edge of the measured volume, the system will issue a warning: higher SAR values might be found outside of the measured volume. In that case the cube measurement can be repeated, using the new interpolated maximum as the center.

1.12 Probe Calibration Procedures

For the calibration of E-field probes in lossy liquids, an electric field with an accurately known field strength must be produced within the measured liquid. For standardization purposes it would be desirable if all measurements which are necessary to assess the correct field strength would be traceable to standardized measurement procedures. In the following two different calibration techniques are summarized:

1.12.1 Transfer Calibration with Temperature Probes

In lossy liquids the specific absorption rate (SAR) is related both to the electric field (E) and the temperature gradient ($\delta T / \delta t$) in the liquid.

$$SAR = C \frac{\delta T}{\delta t},$$

whereby σ is the conductivity, ρ the density and c the heat capacity of the liquid.

Hence, the electric field in lossy liquid can be measured indirectly by measuring the temperature gradient in the liquid. Non-disturbing temperature probes (optical probes or thermistor probes with resistive lines) with high spatial resolution (<1-2 mm) and fast reaction time (<1 s) are available and can be easily calibrated with high precision [1]. The setup and the exciting source have no influence on the calibration; only the relative positioning uncertainties of the standard temperature probe and the E-field probe to be calibrated must be considered. However, several problems limit the available accuracy of probe calibrations with temperature probes:

Unless otherwise stated the results shown in this test report refer only to the sample(s) tested and such sample(s) are retained for 90 days only.

除非另有說明，此報告結果僅對測試之樣品負責，同時此樣品僅保留90天。本報告未經本公司書面許可，不可部份複製。

This document is issued by the Company subject to its General Conditions of Service printed overleaf, available on request or accessible at <http://www.sgs.com.tw/Terms-and-Conditions> and for electronic format documents, subject to Terms and Conditions for Electronic Documents at <http://www.sgs.com.tw/Terms-and-Conditions>. Attention is drawn to the limitation of liability, indemnification and jurisdiction issues defined therein. Any holder of this document is advised that information contained hereon reflects the Company's findings at the time of its intervention only and within the limits of Client's instructions, if any. The Company's sole responsibility is to its Client and this document does not exonerate parties to a transaction from exercising all their rights and obligations under the transaction documents. This document cannot be reproduced except in full, without prior written approval of the Company. Any unauthorized alteration, forgery or falsification of the content or appearance of this document is unlawful and offenders may be prosecuted to the fullest extent of the law.

- The temperature gradient is not directly measurable but must be evaluated from temperature measurements at different time steps. Special precaution is necessary to avoid measurement errors caused by temperature gradients due to energy equalizing effects or convection currents in the liquid. Such effects cannot be completely avoided, as the measured field itself destroys the thermal equilibrium in the liquid. With a careful setup these errors can be kept small.
- The measured volume around the temperature probe is not well defined. It is difficult to calculate the energy transfer from a surrounding gradient temperature field into the probe. These effects must be considered, since temperature probes are calibrated in liquid with homogeneous temperatures. There is no traceable standard for temperature rise measurements.
- The calibration depends on the assessment of the specific density, the heat capacity and the conductivity of the medium. While the specific density and heat capacity can be measured accurately with standardized procedures ($\sim 2\%$ for c ; much better for ρ), there is no standard for the measurement of the conductivity. Depending on the method and liquid, the error can well exceed $\pm 5\%$.
- Temperature rise measurements are not very sensitive and therefore are often performed at a higher power level than the E-field measurements. The nonlinearities in the system (e.g., power measurements, different components, etc.) must be considered.

Considering these problems, the possible accuracy of the calibration of E-field probes with temperature gradient measurements in a carefully designed setup is about $\pm 10\%$ (RSS) [2]. Recently, a setup which is a combination of the waveguide techniques and the thermal measurements was presented in [3]. The estimated uncertainty of the setup is $\pm 5\%$ (RSS) when the same liquid is used for the calibration and for actual measurements and $\pm 7-9\%$ (RSS) when not, which is in good agreement with the estimates given in [2].

1.11.2 Calibration with Analytical Fields

In this method a technical setup is used in which the field can be calculated analytically from measurements of other physical magnitudes (e.g., input power). This corresponds to the standard field method for probe calibration in air; however, there is no standard defined for fields in lossy liquids.

When using calculated fields in lossy liquids for probe calibration, several points must be considered in the assessment of the uncertainty:

- The setup must enable accurate determination of the incident power.
- The accuracy of the calculated field strength will depend on the assessment of the dielectric parameters of the liquid.
- Due to the small wavelength in liquids with high permittivity, even small

Unless otherwise stated the results shown in this test report refer only to the sample(s) tested and such sample(s) are retained for 90 days only.

除非另有說明，此報告結果僅對測試之樣品負責，同時此樣品僅保留90天。本報告未經本公司書面許可，不可部份複製。

This document is issued by the Company subject to its General Conditions of Service printed overleaf, available on request or accessible at <http://www.sgs.com.tw/Terms-and-Conditions> and for electronic format documents, subject to Terms and Conditions for Electronic Documents at <http://www.sgs.com.tw/Terms-and-Conditions>. Attention is drawn to the limitation of liability, indemnification and jurisdiction issues defined therein. Any holder of this document is advised that information contained herein reflects the Company's findings at the time of its intervention only and within the limits of Client's instructions, if any. The Company's sole responsibility is to its Client and this document does not exonerate parties to a transaction from exercising all their rights and obligations under the transaction documents. This document cannot be reproduced except in full, without prior written approval of the Company. Any unauthorized alteration, forgery or falsification of the content or appearance of this document is unlawful and offenders may be prosecuted to the fullest extent of the law.

setups might be above the resonant cutoff frequencies. The field distribution in the setup must be carefully checked for conformity with the theoretical field distribution.

References

1. N. Kuster, Q. Balzano, and J.C. Lin, Eds., *Mobile Communications Safety*, Chapman & Hall, London, 1997.
2. K. Meier, M. Burkhardt, T. Schmid, and N. Kuster, "Broadband calibration of E-field probes in lossy media", *IEEE Transactions on Microwave Theory and Techniques*, vol. 44, no. 10, pp. 1954-1962, Oct. 1996.
3. K. Jokela, P. Hyysalo, and L. Puranen, "Calibration of specific absorption rate (SAR) probes in waveguide at 900 MHz", *IEEE Transactions on Instrumentation and Measurements*, vol. 47, no. 2, pp. 432-438, Apr. 1998.

Unless otherwise stated the results shown in this test report refer only to the sample(s) tested and such sample(s) are retained for 90 days only.
除非另有說明，此報告結果僅對測試之樣品負責，同時此樣品僅保留90天。本報告未經本公司書面許可，不可部份複製。

This document is issued by the Company subject to its General Conditions of Service printed overleaf, available on request or accessible at <http://www.sgs.com.tw/Terms-and-Conditions> and for electronic format documents, subject to Terms and Conditions for Electronic Documents at <http://www.sgs.com.tw/Terms-and-Conditions>. Attention is drawn to the limitation of liability, indemnification and jurisdiction issues defined therein. Any holder of this document is advised that information contained hereon reflects the Company's findings at the time of its intervention only and within the limits of Client's instructions, if any. The Company's sole responsibility is to its Client and this document does not exonerate parties to a transaction from exercising all their rights and obligations under the transaction documents. This document cannot be reproduced except in full, without prior written approval of the Company. Any unauthorized alteration, forgery or falsification of the content or appearance of this document is unlawful and offenders may be prosecuted to the fullest extent of the law.

1.13 Test Standards and Limits

According to FCC 47CFR §2.1093(d) The limits to be used for evaluation are based generally on criteria published by the American National Standards Institute (ANSI) for localized specific absorption rate (“SAR”) in Section 4.2 of “IEEE Standard for Safety Levels with Respect to Human Exposure to Radio Frequency Electromagnetic Fields, 3 kHz to 300 GHz,” ANSI/IEEE C95.1, By the Institute of Electrical and Electronics Engineers, Inc., New York, New York 10017. These criteria for SAR evaluation are similar to those recommended by the National Council on Radiation Protection and Measurements (NCRP) in “Biological Effects and Exposure Criteria for Radio frequency Electromagnetic Fields,” NCRP Report No. 86, Section 17.4.5. Copyright NCRP, 1986, Bethesda, Maryland 20814. SAR is a measure of the rate of energy absorption due to exposure to an RF transmitting source. SAR values have been related to threshold levels for potential biological hazards. The criteria to be used are specified in paragraphs (d)(1) and (d)(2) of this section and shall apply for portable devices transmitting in the frequency range from 100 kHz to 6 GHz. Portable devices that transmit at frequencies above 6 GHz are to be evaluated in terms of the MPE limits specified in § 1.1310 of this chapter. Measurements and calculations to demonstrate compliance with MPE field strength or power density limits for devices operating above 6 GHz should be made at a minimum distance of 5 cm from the radiating source.

- (1) Limits for Occupational/Controlled exposure: 0.4 W/kg as averaged over the whole-body and spatial peak SAR not exceeding 8 W/kg as averaged over any 1 gram of tissue (defined as a tissue volume in the shape of a cube). Exceptions are the hands, wrists, feet and ankles where the spatial peak SAR shall not exceed 20 W/kg, as averaged over an 10 grams of tissue (defined as a tissue volume in the shape of a cube).
- (2) Occupational/Controlled limits apply when persons are exposed as a consequence of their employment provided these persons are fully aware of and exercise control over their exposure. Awareness of exposure can be accomplished by use of warning labels or by specific training or education through appropriate means, such as an RF safety program in a work environment.
- (3) Limits for General Population/Uncontrolled exposure: 0.08 W/kg as averaged over the whole-body and spatial peak SAR not exceeding 1.6 W/kg as averaged over any 1 gram of tissue (defined as a tissue volume in the shape of a cube). Exceptions are the hands, wrists, feet and ankles where the spatial peak SAR shall not exceed 4 W/kg, as averaged over any 10 grams of tissue (defined as a tissue volume in the shape of a cube). General Population/Uncontrolled limits apply when the general public may be exposed, or when persons that are exposed as a consequence of their employment may not be fully aware of the potential for exposure or do not

Unless otherwise stated the results shown in this test report refer only to the sample(s) tested and such sample(s) are retained for 90 days only.

除非另有說明，此報告結果僅對測試之樣品負責，同時此樣品僅保留90天。本報告未經本公司書面許可，不可部份複製。

This document is issued by the Company subject to its General Conditions of Service printed overleaf, available on request or accessible at <http://www.sgs.com.tw/Terms-and-Conditions> and for electronic format documents, subject to Terms and Conditions for Electronic Documents at <http://www.sgs.com.tw/Terms-and-Conditions>. Attention is drawn to the limitation of liability, indemnification and jurisdiction issues defined therein. Any holder of this document is advised that information contained herein reflects the Company's findings at the time of its intervention only and within the limits of Client's instructions, if any. The Company's sole responsibility is to its Client and this document does not exonerate parties to a transaction from exercising all their rights and obligations under the transaction documents. This document cannot be reproduced except in full, without prior written approval of the Company. Any unauthorized alteration, forgery or falsification of the content or appearance of this document is unlawful and offenders may be prosecuted to the fullest extent of the law.

SGS Taiwan Ltd. No.134,Wu Kung Road, New Taipei Industrial Park, Wuku District, New Taipei City, Taiwan/新北市五股區新北產業園區五工路 134 號

exercise control over their exposure. Warning labels placed on consumer devices such as cellular telephones will not be sufficient reason to allow these devices to be evaluated subject to limits for occupational/controlled exposure in paragraph (d)(1) of this section. (Table 4.)

Human Exposure	Uncontrolled Environment General Population	Controlled Environment Occupational
Spatial Peak SAR (Brain)	1.60 W/kg	8.00 W/kg
Spatial Average SAR (Whole Body)	0.08 W/kg	0.40 W/kg
Spatial Peak SAR (Hands/Feet/Ankle/Wrist)	4.00 W/kg	20.00 W/kg

Table 4. RF exposure limits

Notes:

1. Uncontrolled environments are defined as locations where there is potential exposure of individuals who have no knowledge or control of their potential exposure.
2. Controlled environments are defined as locations where there is potential exposure of individuals who have knowledge of their potential exposure and can exercise control over their exposure.

Unless otherwise stated the results shown in this test report refer only to the sample(s) tested and such sample(s) are retained for 90 days only.

除非另有說明，此報告結果僅對測試之樣品負責，同時此樣品僅保留90天。本報告未經本公司書面許可，不可部份複製。

This document is issued by the Company subject to its General Conditions of Service printed overleaf, available on request or accessible at <http://www.sgs.com.tw/Terms-and-Conditions> and for electronic format documents, subject to Terms and Conditions for Electronic Documents at <http://www.sgs.com.tw/Terms-and-Conditions>. Attention is drawn to the limitation of liability, indemnification and jurisdiction issues defined therein. Any holder of this document is advised that information contained hereon reflects the Company's findings at the time of its intervention only and within the limits of Client's instructions, if any. The Company's sole responsibility is to its Client and this document does not exonerate parties to a transaction from exercising all their rights and obligations under the transaction documents. This document cannot be reproduced except in full, without prior written approval of the Company. Any unauthorized alteration, forgery or falsification of the content or appearance of this document is unlawful and offenders may be prosecuted to the fullest extent of the law.

SGS Taiwan Ltd. No.134,Wu Kung Road, New Taipei Industrial Park, Wuku District, New Taipei City, Taiwan/新北市五股區新北產業園區五工路 134 號

2. Summary of Results

2.1 Decision rules

Reported measurement data comply with IEEE 1528-2013:

Determining compliance shall be based on the results of the compliance measurement, not taking into account measurement instrumentation uncertainty.

2.2 Summary of Results

Full power

WCDMA Band V

Mode	Position	Distance (mm)	CH	Freq. (MHz)	Max. Rated Avg. Power + Max.Tolerance (dBm)	Measured Avg. Power (dBm)	Scaling	Averaged SAR over 1g (W/kg)		Plot page
								Measured	Reported	
WCDMA Band V	Back side	11	4132	826.4	25.0	24.21	119.95%	0.939	1.126	-
	Back side	11	4183	836.6	25.0	24.27	118.30%	1.110	1.313	-
	Back side	11	4233	846.6	25.0	24.16	121.34%	1.130	1.371	96
	Back side*	11	4233	846.6	25.0	24.16	121.34%	1.090	1.323	-
	Top side	7	4132	826.4	25.0	24.21	119.95%	0.795	0.954	-
	Top side	7	4183	836.6	25.0	24.27	118.30%	0.916	1.084	-
	Top side	7	4233	846.6	25.0	24.16	121.34%	0.834	1.012	-
	Top side*	7	4183	836.6	25.0	24.27	118.30%	0.911	1.078	-
	Bottom side	0	4183	836.6	25.0	24.27	118.30%	0.018	0.021	-
	Right side	0	4183	836.6	25.0	24.27	118.30%	0.085	0.101	-
Left side	0	4183	836.6	25.0	24.27	118.30%	0.100	0.118	-	

* - repeated at the highest SAR measurement according to the KDB 865664 D01

Unless otherwise stated the results shown in this test report refer only to the sample(s) tested and such sample(s) are retained for 90 days only.

除非另有說明，此報告結果僅對測試之樣品負責，同時此樣品僅保留90天。本報告未經本公司書面許可，不可部份複製。

This document is issued by the Company subject to its General Conditions of Service printed overleaf, available on request or accessible at <http://www.sgs.com.tw/Terms-and-Conditions> and for electronic format documents, subject to Terms and Conditions for Electronic Documents at <http://www.sgs.com.tw/Terms-and-Conditions>. Attention is drawn to the limitation of liability, indemnification and jurisdiction issues defined therein. Any holder of this document is advised that information contained hereon reflects the Company's findings at the time of its intervention only and within the limits of Client's instructions, if any. The Company's sole responsibility is to its Client and this document does not exonerate parties to a transaction from exercising all their rights and obligations under the transaction documents. This document cannot be reproduced except in full, without prior written approval of the Company. Any unauthorized alteration, forgery or falsification of the content or appearance of this document is unlawful and offenders may be prosecuted to the fullest extent of the law.

LTE FDD Band 5

Mode	Bandwidth (MHz)	Modulation	RB Size	RB start	Position	Distance (mm)	CH	Freq. (MHz)	Max. Rated Avg. Power + Max. Tolerance (dBm)	Measured Avg. Power (dBm)	Scaling	Averaged SAR over 1g (W/kg)		Plot page		
												Measured	Reported			
LTE Band 5	10MHz	QPSK	1 RB	0	Back side	11	20600	844	25	24.99	100.23%	1.130	1.133	97		
					Back side*	11	20600	844	25	24.99	100.23%	1.110	1.113	-		
					Top side	7	20600	844	25	24.99	100.23%	1.000	1.002	-		
					Top side*	7	20600	844	25	24.99	100.23%	0.989	0.991	-		
					Bottom side	0	20600	844	25	24.99	100.23%	0.019	0.019	-		
					Right side	0	20600	844	25	24.99	100.23%	0.044	0.044	-		
				25	Left side	0	20600	844	25	24.99	100.23%	0.106	0.106	-		
					Back side	11	20450	829	25	24.95	101.16%	0.953	0.964	-		
					Back side	11	20525	836.5	25	24.97	100.69%	0.962	0.969	-		
					Top side	7	20450	829	25	24.95	101.16%	0.925	0.936	-		
				25 RB	0	Top side	7	20525	836.5	25	24.97	100.69%	0.974	0.981	-	
						Back side	11	20525	836.5	24	23.94	101.39%	0.811	0.822	-	
					25	12	Back side	11	20600	844	24	23.95	101.16%	0.793	0.802	-
						25	Back side	11	20450	829	24	23.96	100.93%	0.828	0.836	-
							Top side	7	20450	829	24	23.96	100.93%	0.758	0.765	-
						Bottom side	0	20450	829	24	23.96	100.93%	0.015	0.015	-	
				50 RB	Right side	0	20450	829	24	23.96	100.93%	0.040	0.040	-		
					Left side	0	20450	829	24	23.96	100.93%	0.073	0.074	-		
					Back side	11	20450	829	24	23.88	102.80%	0.893	0.918	-		
						11	20525	836.5	24	23.91	102.09%	0.927	0.946	-		
					Top side	7	20600	844	24	23.89	102.57%	0.902	0.925	-		
						7	20525	836.5	24	23.91	102.09%	0.773	0.789	-		
				Bottom side	0	20525	836.5	24	23.91	102.09%	0.013	0.013	-			
				Right side	0	20525	836.5	24	23.91	102.09%	0.039	0.040	-			
				Left side	0	20525	836.5	24	23.91	102.09%	0.078	0.080	-			

* - repeated at the highest SAR measurement according to the KDB 865664 D01

Unless otherwise stated the results shown in this test report refer only to the sample(s) tested and such sample(s) are retained for 90 days only.

除非另有說明，此報告結果僅對測試之樣品負責，同時此樣品僅保留90天。本報告未經本公司書面許可，不可部份複製。

This document is issued by the Company subject to its General Conditions of Service printed overleaf, available on request or accessible at <http://www.sgs.com.tw/Terms-and-Conditions> and for electronic format documents, subject to Terms and Conditions for Electronic Documents at <http://www.sgs.com.tw/Terms-and-Conditions>. Attention is drawn to the limitation of liability, indemnification and jurisdiction issues defined therein. Any holder of this document is advised that information contained hereon reflects the Company's findings at the time of its intervention only and within the limits of Client's instructions, if any. The Company's sole responsibility is to its Client and this document does not exonerate parties to a transaction from exercising all their rights and obligations under the transaction documents. This document cannot be reproduced except in full, without prior written approval of the Company. Any unauthorized alteration, forgery or falsification of the content or appearance of this document is unlawful and offenders may be prosecuted to the fullest extent of the law.

WIFI/BT

Mode	Position	Distance (mm)	CH	Freq. (MHz)	Max. Rated Avg. Power + Max. Tolerance (dBm)	Measured Avg. Power (dBm)	Duty Cycle Scaling	Power Scaling	Averaged SAR over 1g (W/kg)		Plot page
									Measured	Reported	
WLAN 802.11b	Back side	11	11	2462	14.50	14.36	1.005	103.28%	0.165	0.171	98
	Top side	7	11	2462	14.50	14.36	1.005	103.28%	0.060	0.062	-
	Bottom side	0	11	2462	14.50	14.36	1.005	103.28%	0.001	0.001	-
	Right side	0	11	2462	14.50	14.36	1.005	103.28%	0.035	0.036	-
	Left side	0	11	2462	14.50	14.36	1.005	103.28%	0.016	0.017	-
WLAN 802.11g	Back side	11	1	2412	19.00	18.79	1.022	104.95%	0.406	0.435	99
	Top side	7	1	2412	19.00	18.79	1.022	104.95%	0.158	0.169	-
	Bottom side	0	1	2412	19.00	18.79	1.022	104.95%	0.001	0.001	-
	Right side	0	1	2412	19.00	18.79	1.022	104.95%	0.097	0.104	-
	Left side	0	1	2412	19.00	18.79	1.022	104.95%	0.040	0.043	-
Bluetooth (GFSK)	Back side	0	78	2480	9.50	9.18	1.302	107.65%	0.002	0.002	100
	Top side	0	78	2480	9.50	9.18	1.302	107.65%	0.001	0.001	-
	Bottom side	0	78	2480	9.50	9.18	1.302	107.65%	0.001	0.001	-
	Right side	0	78	2480	9.50	9.18	1.302	107.65%	0.001	0.001	-
	Left side	0	78	2480	9.50	9.18	1.302	107.65%	0.001	0.001	-
WLAN 802.11n(40M) 5.2G	Back side	11	46	5230	19.00	18.45	1.013	113.50%	0.495	0.569	-
	Top side	7	46	5230	19.00	18.45	1.013	113.50%	1.090	1.253	101
	Top side*	7	46	5230	19.00	18.45	1.013	113.50%	1.030	1.184	-
	Bottom side	0	46	5230	19.00	18.45	1.013	113.50%	0.029	0.033	-
	Right side	0	46	5230	19.00	18.45	1.013	113.50%	0.024	0.028	-
	Left side	0	46	5230	19.00	18.45	1.013	113.50%	0.007	0.008	-
WLAN 802.11ac(40M) 5.2G	Top side	7	46	5230	19.00	18.33	1.010	116.68%	0.907	1.069	102
	Top side*	7	46	5230	19.00	18.33	1.010	116.68%	0.903	1.064	-
WLAN 802.11n(40M) 5.3G	Back side	11	54	5270	19.00	18.76	1.013	105.68%	0.511	0.547	-
	Top side	7	54	5270	19.00	18.76	1.013	105.68%	1.040	1.113	103
	Top side*	7	54	5270	19.00	18.76	1.013	105.68%	0.995	1.065	-
	Bottom side	0	54	5270	19.00	18.76	1.013	105.68%	0.027	0.029	-
	Right side	0	54	5270	19.00	18.76	1.013	105.68%	0.032	0.034	-
WLAN 802.11ac(40M) 5.3G	Left side	0	54	5270	19.00	18.76	1.013	105.68%	0.009	0.009	-
	Top side	7	54	5270	19.00	18.67	1.010	107.89%	0.984	1.072	104
WLAN 802.11ac(80M) 5.6G	Top side*	7	54	5270	19.00	18.67	1.010	107.89%	0.971	1.058	-
	Back side	11	122	5610	19.00	18.98	1.013	100.44%	0.377	0.383	-
	Top side	7	122	5610	19.00	18.98	1.013	100.44%	0.685	0.697	105
	Bottom side	0	122	5610	19.00	18.98	1.013	100.44%	0.019	0.019	-
	Right side	0	122	5610	19.00	18.98	1.013	100.44%	0.016	0.016	-
Left side	0	122	5610	19.00	18.98	1.013	100.44%	0.005	0.005	-	

* - repeated at the highest SAR measurement according to the KDB 865664 D01

Unless otherwise stated the results shown in this test report refer only to the sample(s) tested and such sample(s) are retained for 90 days only.

除非另有說明，此報告結果僅對測試之樣品負責，同時此樣品僅保留90天。本報告未經本公司書面許可，不可部份複製。

This document is issued by the Company subject to its General Conditions of Service printed overleaf, available on request or accessible at <http://www.sgs.com.tw/Terms-and-Conditions> and for electronic format documents, subject to Terms and Conditions for Electronic Documents at <http://www.sgs.com.tw/Terms-and-Conditions>. Attention is drawn to the limitation of liability, indemnification and jurisdiction issues defined therein. Any holder of this document is advised that information contained hereon reflects the Company's findings at the time of its intervention only and within the limits of Client's instructions, if any. The Company's sole responsibility is to its Client and this document does not exonerate parties to a transaction from exercising all their rights and obligations under the transaction documents. This document cannot be reproduced except in full, without prior written approval of the Company. Any unauthorized alteration, forgery or falsification of the content or appearance of this document is unlawful and offenders may be prosecuted to the fullest extent of the law.

Reduced power

WCDMA Band V

Mode	Position	Distance (mm)	CH	Freq. (MHz)	Max. Rated Avg. Power + Max.Tolerance (dBm)	Measured Avg. Power (dBm)	Scaling	Averaged SAR over 1g (W/kg)		Plot page
								Measured	Reported	
WCDMA Band V	Back side	0	4132	826.4	16.5	15.13	137.09%	0.584	0.801	-
	Back side	0	4183	836.6	16.5	15.14	136.77%	0.614	0.840	-
	Back side	0	4233	846.6	16.5	15.23	133.97%	0.657	0.880	106
	Back side*	0	4233	846.6	16.5	15.23	133.97%	0.652	0.873	-
	Top side	0	4183	836.6	16.5	15.14	136.77%	0.408	0.558	-

* - repeated at the highest SAR measurement according to the KDB 865664 D01

LTE FDD Band 5

Mode	Bandwidth (MHz)	Modulation	RB Size	RB start	Position	Distance (mm)	CH	Freq. (MHz)	Max. Rated Avg. Power + Max. Tolerance (dBm)	Measured Avg. Power (dBm)	Scaling	Averaged SAR over 1g (W/kg)		Plot page
												Measured	Reported	
LTE Band 5	10MHz	QPSK	1 RB	25	Back side	0	20525	836.5	16.5	16.36	103.28%	0.574	0.593	-
					Back side	0	20600	844	16.5	16.39	102.57%	0.605	0.621	107
					Top side	0	20600	844	16.5	16.39	102.57%	0.397	0.407	-
				49	Back side	0	20450	829	16.5	16.38	102.80%	0.570	0.586	-
					Back side	0	20600	844	16.5	16.08	110.15%	0.494	0.544	-
						Top side	0	20600	844	16.5	16.08	110.15%	0.369	0.406
			25 RB	12	Back side	0	20525	836.5	16.5	16.06	110.66%	0.466	0.516	-
						0	20525	836.5	16.5	16.06	110.66%	0.355	0.393	-
			50 RB		Back side	0	20525	836.5	16.5	16.06	110.66%	0.466	0.516	-
						0	20525	836.5	16.5	16.06	110.66%	0.355	0.393	-

Unless otherwise stated the results shown in this test report refer only to the sample(s) tested and such sample(s) are retained for 90 days only.

除非另有說明，此報告結果僅對測試之樣品負責，同時此樣品僅保留90天。本報告未經本公司書面許可，不可部份複製。

This document is issued by the Company subject to its General Conditions of Service printed overleaf, available on request or accessible at <http://www.sgs.com.tw/Terms-and-Conditions> and for electronic format documents, subject to Terms and Conditions for Electronic Documents at <http://www.sgs.com.tw/Terms-and-Conditions>. Attention is drawn to the limitation of liability, indemnification and jurisdiction issues defined therein. Any holder of this document is advised that information contained hereon reflects the Company's findings at the time of its intervention only and within the limits of Client's instructions, if any. The Company's sole responsibility is to its Client and this document does not exonerate parties to a transaction from exercising all their rights and obligations under the transaction documents. This document cannot be reproduced except in full, without prior written approval of the Company. Any unauthorized alteration, forgery or falsification of the content or appearance of this document is unlawful and offenders may be prosecuted to the fullest extent of the law.

WIFI/BT

Mode	Position	Distance (mm)	CH	Freq. (MHz)	Max. Rated Avg. Power + Max. Tolerance (dBm)	Measured Avg. Power (dBm)	Duty Cycle Scaling	Power Scaling	Averaged SAR over 1g (W/kg)		Plot page
									Measured	Reported	
WLAN 802.11b	Back side	0	6	2437	11.50	11.47	1.005	100.69%	0.585	0.592	108
	Top side	0	6	2437	11.50	11.47	1.005	100.69%	0.128	0.130	-
WLAN 802.11n(40M) 5.2G	Back side	0	46	5230	7.50	7.45	1.013	101.16%	0.781	0.800	109
WLAN 802.11ac(80M) 5.2G	Back side	0	42	5210	7.50	7.43	1.013	101.62%	0.812	0.836	110
	Back side*	0	42	5210	7.50	7.43	1.013	101.62%	0.799	0.822	-
	Top side	0	42	5210	7.50	7.43	1.013	101.62%	0.408	0.420	-
WLAN 802.11n(40M) 5.3G	Back side	0	62	5310	7.50	7.37	1.013	103.04%	0.726	0.757	111
WLAN 802.11ac(80M) 5.3G	Back side	0	58	5290	7.50	7.40	1.013	102.33%	0.828	0.858	112
	Back side*	0	58	5290	7.50	7.40	1.013	102.33%	0.811	0.840	-
	Top side	0	58	5290	7.50	7.40	1.013	102.33%	0.404	0.419	-
WLAN 802.11ac(80M) 5.6G	Back side	0	138	5690	7.50	7.49	1.013	100.23%	0.370	0.376	113
	Top side	0	138	5690	7.50	7.49	1.013	100.23%	0.176	0.179	-

* - repeated at the highest SAR measurement according to the KDB 865664 D01

Note:

$$\text{Power scaling} = \frac{\text{reported SAR}}{\text{measured SAR}} = \frac{P_2(\text{mW})}{P_1(\text{mW})} = 10^{\left(\frac{P_2 - P_1}{10}\right)}(\text{dBm})$$

Reported SAR = measured SAR * Power scaling * Duty cycle scaling

Where P2 is maximum specified power, P1 is measured conducted power

2.3 Reporting statements of conformity

The conformity statement in this report is based solely on the test results, measurement uncertainty is excluded.

Unless otherwise stated the results shown in this test report refer only to the sample(s) tested and such sample(s) are retained for 90 days only.

除非另有說明，此報告結果僅對測試之樣品負責，同時此樣品僅保留90天。本報告未經本公司書面許可，不可部份複製。

This document is issued by the Company subject to its General Conditions of Service printed overleaf, available on request or accessible at <http://www.sgs.com.tw/Terms-and-Conditions> and for electronic format documents, subject to Terms and Conditions for Electronic Documents at <http://www.sgs.com.tw/Terms-and-Conditions>. Attention is drawn to the limitation of liability, indemnification and jurisdiction issues defined therein. Any holder of this document is advised that information contained hereon reflects the Company's findings at the time of its intervention only and within the limits of Client's instructions, if any. The Company's sole responsibility is to its Client and this document does not exonerate parties to a transaction from exercising all their rights and obligations under the transaction documents. This document cannot be reproduced except in full, without prior written approval of the Company. Any unauthorized alteration, forgery or falsification of the content or appearance of this document is unlawful and offenders may be prosecuted to the fullest extent of the law.

3. Simultaneous Transmission Analysis

Simultaneous Transmission Scenarios:

Simultaneous Transmit Configurations	Body
WWAN + 2.4GHz WLAN	Yes
WWAN + 5GHz WLAN	Yes
WWAN + BT	Yes

Unless otherwise stated the results shown in this test report refer only to the sample(s) tested and such sample(s) are retained for 90 days only.
除非另有說明，此報告結果僅對測試之樣品負責，同時此樣品僅保留90天。本報告未經本公司書面許可，不可部份複製。

This document is issued by the Company subject to its General Conditions of Service printed overleaf, available on request or accessible at <http://www.sgs.com.tw/Terms-and-Conditions> and for electronic format documents, subject to Terms and Conditions for Electronic Documents at <http://www.sgs.com.tw/Terms-and-Conditions>. Attention is drawn to the limitation of liability, indemnification and jurisdiction issues defined therein. Any holder of this document is advised that information contained hereon reflects the Company's findings at the time of its intervention only and within the limits of Client's instructions, if any. The Company's sole responsibility is to its Client and this document does not exonerate parties to a transaction from exercising all their rights and obligations under the transaction documents. This document cannot be reproduced except in full, without prior written approval of the Company. Any unauthorized alteration, forgery or falsification of the content or appearance of this document is unlawful and offenders may be prosecuted to the fullest extent of the law.

3.1 Estimated SAR calculation

According to KDB447498 D01v06 – When standalone SAR test exclusion applies to an antenna that transmits simultaneously with other antennas, the standalone SAR must be estimated according to following to determine simultaneous transmission SAR test exclusion:

$$\text{Estimated SAR} = \frac{\text{Max. tune up power (mW)}}{\text{Min. test separation distance(mm)}} \times \frac{\sqrt{f(\text{GHz})}}{7.5}$$

If the minimum test separation distance is < 5mm, a distance of 5mm is used for estimated SAR calculation. When the test separation distance is >50mm, the 0.4W/kg is used for SAR-1g.

3.2 SPLSR evaluation and analysis

Per KDB447498D01, when the sum of SAR is larger than the limit, SAR test exclusion is determined by the SAR sum to peak location separation ratio(SPLSR).

The simultaneous transmitting antennas in each operating mode and exposure condition combination must be considered one pair at a time to determine the SAR to peak location separation ratio to qualify for test exclusion.

The ratio is determined by $(\text{SAR1} + \text{SAR2})^{1.5}/R_i$, rounded to two decimal digits, and must be ≤ 0.04 for all antenna pairs in the configuration to qualify for 1-g SAR test exclusion.

SAR1 and SAR2 are the highest reported or estimated SAR for each antenna in the pair, and R_i is the separation distance between the peak SAR locations for the antenna pair in mm.

When standalone test exclusion applies, SAR is estimated; the peak location is assumed to be at the feed-point or geometric center of the antenna.

Unless otherwise stated the results shown in this test report refer only to the sample(s) tested and such sample(s) are retained for 90 days only.

除非另有說明，此報告結果僅對測試之樣品負責，同時此樣品僅保留90天。本報告未經本公司書面許可，不可部份複製。

This document is issued by the Company subject to its General Conditions of Service printed overleaf, available on request or accessible at <http://www.sgs.com.tw/Terms-and-Conditions>, and for electronic format documents, subject to Terms and Conditions for Electronic Documents at <http://www.sgs.com.tw/Terms-and-Conditions>. Attention is drawn to the limitation of liability, indemnification and jurisdiction issues defined therein. Any holder of this document is advised that information contained hereon reflects the Company's findings at the time of its intervention only and within the limits of Client's instructions, if any. The Company's sole responsibility is to its Client and this document does not exonerate parties to a transaction from exercising all their rights and obligations under the transaction documents. This document cannot be reproduced except in full, without prior written approval of the Company. Any unauthorized alteration, forgery or falsification of the content or appearance of this document is unlawful and offenders may be prosecuted to the fullest extent of the law.

reported SAR WWAN and 2.4 GHz WLAN, Σ SAR evaluation						
Frequency band	Position	Distance (mm)	SAR / W/kg		Σ SAR	SPLSR
			WWAN	WLAN		
WCDMA Band V	Back side	11	1.371	0.435	1.806	Analyzed as below
	Top side	7	1.084	0.169	1.253	Σ SAR<1.6, Not required
	Back side	0	0.880	0.592	1.472	Σ SAR<1.6, Not required
	Top side	0	0.558	0.13	0.688	Σ SAR<1.6, Not required
	Bottom side	0	0.021	0.001	0.022	Σ SAR<1.6, Not required
	Right side	0	0.101	0.104	0.205	Σ SAR<1.6, Not required
	Left side	0	0.118	0.043	0.161	Σ SAR<1.6, Not required
LTE FDD Band 5	Back side	11	1.133	0.435	1.568	Σ SAR<1.6, Not required
	Top side	7	1.002	0.169	1.171	Σ SAR<1.6, Not required
	Back side	0	0.621	0.592	1.213	Σ SAR<1.6, Not required
	Top side	0	0.407	0.13	0.537	Σ SAR<1.6, Not required
	Bottom side	0	0.019	0.001	0.020	Σ SAR<1.6, Not required
	Right side	0	0.044	0.104	0.148	Σ SAR<1.6, Not required
	Left side	0	0.106	0.043	0.149	Σ SAR<1.6, Not required

Unless otherwise stated the results shown in this test report refer only to the sample(s) tested and such sample(s) are retained for 90 days only.

除非另有說明，此報告結果僅對測試之樣品負責，同時此樣品僅保留90天。本報告未經本公司書面許可，不可部份複製。

This document is issued by the Company subject to its General Conditions of Service printed overleaf, available on request or accessible at <http://www.sgs.com.tw/Terms-and-Conditions>, and for electronic format documents, subject to Terms and Conditions for Electronic Documents at <http://www.sgs.com.tw/Terms-and-Conditions>. Attention is drawn to the limitation of liability, indemnification and jurisdiction issues defined therein. Any holder of this document is advised that information contained hereon reflects the Company's findings at the time of its intervention only and within the limits of Client's instructions, if any. The Company's sole responsibility is to its Client and this document does not exonerate parties to a transaction from exercising all their rights and obligations under the transaction documents. This document cannot be reproduced except in full, without prior written approval of the Company. Any unauthorized alteration, forgery or falsification of the content or appearance of this document is unlawful and offenders may be prosecuted to the fullest extent of the law.

SGS Taiwan Ltd. No.134,Wu Kung Road, New Taipei Industrial Park, Wuku District, New Taipei City, Taiwan/新北市五股區新北產業園區五工路 134 號

WCDMA Band V + 2.4 GHz WLAN

Conditions	Position / Distance	SAR Value (W/kg)	Coordinates (cm)			Σ SAR (W/kg)	Peak Location Separation Distance (mm)	SPLSR	Simultaneous Transmission SAR Test
			x	y	z				
WCDMA Band V	Back side 11mm	1.371	7.90	-4.92	0.45	1.806	89.06	0.027	SPLSR<0.04, Not required
WIFI/BT		0.435	7.02	3.94	0.57				



Unless otherwise stated the results shown in this test report refer only to the sample(s) tested and such sample(s) are retained for 90 days only.

除非另有說明，此報告結果僅對測試之樣品負責，同時此樣品僅保留90天。本報告未經本公司書面許可，不可部份複製。

This document is issued by the Company subject to its General Conditions of Service printed overleaf, available on request or accessible at <http://www.sgs.com.tw/Terms-and-Conditions> and for electronic format documents, subject to Terms and Conditions for Electronic Documents at <http://www.sgs.com.tw/Terms-and-Conditions>. Attention is drawn to the limitation of liability, indemnification and jurisdiction issues defined therein. Any holder of this document is advised that information contained hereon reflects the Company's findings at the time of its intervention only and within the limits of Client's instructions, if any. The Company's sole responsibility is to its Client and this document does not exonerate parties to a transaction from exercising all their rights and obligations under the transaction documents. This document cannot be reproduced except in full, without prior written approval of the Company. Any unauthorized alteration, forgery or falsification of the content or appearance of this document is unlawful and offenders may be prosecuted to the fullest extent of the law.

reported SAR WWAN and 5 GHz WLAN, Σ SAR evaluation						
Frequency band	Position	Distance (mm)	SAR / W/kg		Σ SAR	SPLSR
			WWAN	WLAN		
WCDMA Band V	Back side	11	1.371	0.569	1.940	Analyzed as below
	Top side	7	1.084	1.253	2.337	Analyzed as below
	Back side	0	0.880	0.858	1.738	Analyzed as below
	Top side	0	0.558	0.420	0.978	Σ SAR<1.6, Not required
	Bottom side	0	0.021	0.033	0.054	Σ SAR<1.6, Not required
	Right side	0	0.101	0.034	0.135	Σ SAR<1.6, Not required
	Left side	0	0.118	0.009	0.127	Σ SAR<1.6, Not required
LTE FDD Band 5	Back side	11	1.133	0.569	1.702	Analyzed as below
	Top side	7	1.002	1.253	2.255	Analyzed as below
	Back side	0	0.621	0.858	1.479	Σ SAR<1.6, Not required
	Top side	0	0.407	0.420	0.827	Σ SAR<1.6, Not required
	Bottom side	0	0.019	0.033	0.052	Σ SAR<1.6, Not required
	Right side	0	0.044	0.034	0.078	Σ SAR<1.6, Not required
	Left side	0	0.106	0.009	0.115	Σ SAR<1.6, Not required

Unless otherwise stated the results shown in this test report refer only to the sample(s) tested and such sample(s) are retained for 90 days only.

除非另有說明，此報告結果僅對測試之樣品負責，同時此樣品僅保留90天。本報告未經本公司書面許可，不可部份複製。

This document is issued by the Company subject to its General Conditions of Service printed overleaf, available on request or accessible at <http://www.sgs.com.tw/Terms-and-Conditions>, and for electronic format documents, subject to Terms and Conditions for Electronic Documents at <http://www.sgs.com.tw/Terms-and-Conditions>. Attention is drawn to the limitation of liability, indemnification and jurisdiction issues defined therein. Any holder of this document is advised that information contained hereon reflects the Company's findings at the time of its intervention only and within the limits of Client's instructions, if any. The Company's sole responsibility is to its Client and this document does not exonerate parties to a transaction from exercising all their rights and obligations under the transaction documents. This document cannot be reproduced except in full, without prior written approval of the Company. Any unauthorized alteration, forgery or falsification of the content or appearance of this document is unlawful and offenders may be prosecuted to the fullest extent of the law.

WCDMA Band V + 5 GHz WLAN

Conditions	Position / Distance	SAR Value (W/kg)	Coordinates (cm)			ΣSAR (W/kg)	Peak Location Separation Distance (mm)	SPLSR	Simultaneous Transmission SAR Test
			x	y	z				
WCDMA Band V	Back side 11mm	1.371	7.90	-4.92	0.45	1.940	76.44	0.035	SPLSR<0.04, Not required
WIFI/BT		0.569	7.80	2.72	0.52				

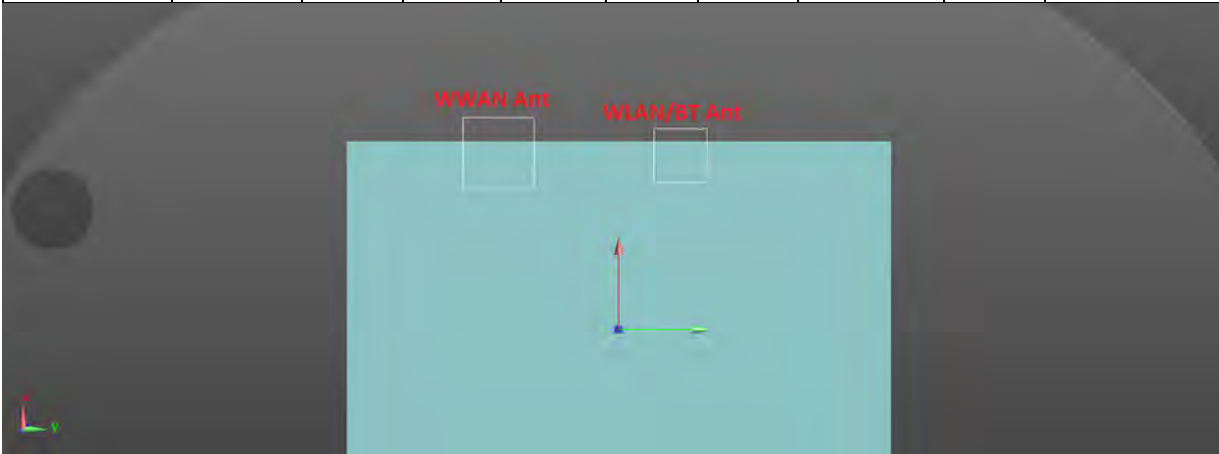

Unless otherwise stated the results shown in this test report refer only to the sample(s) tested and such sample(s) are retained for 90 days only.

除非另有說明，此報告結果僅對測試之樣品負責，同時此樣品僅保留90天。本報告未經本公司書面許可，不可部份複製。

This document is issued by the Company subject to its General Conditions of Service printed overleaf, available on request or accessible at <http://www.sgs.com.tw/Terms-and-Conditions> and for electronic format documents, subject to Terms and Conditions for Electronic Documents at <http://www.sgs.com.tw/Terms-and-Conditions>. Attention is drawn to the limitation of liability, indemnification and jurisdiction issues defined therein. Any holder of this document is advised that information contained hereon reflects the Company's findings at the time of its intervention only and within the limits of Client's instructions, if any. The Company's sole responsibility is to its Client and this document does not exonerate parties to a transaction from exercising all their rights and obligations under the transaction documents. This document cannot be reproduced except in full, without prior written approval of the Company. Any unauthorized alteration, forgery or falsification of the content or appearance of this document is unlawful and offenders may be prosecuted to the fullest extent of the law.

WCDMA Band V + 5 GHz WLAN

Conditions	Position / Distance	SAR Value (W/kg)	Coordinates (cm)			ΣSAR (W/kg)	Peak Location Separation Distance (mm)	SPLSR	Simultaneous Transmission SAR Test
			x	y	z				
WCDMA Band V	Top side 7mm	1.084	-0.95	-5.06	0.34	2.337	92.95	0.038	SPLSR<0.04, Not required
WIFI/BT		1.253	-0.66	3.52	0.43				

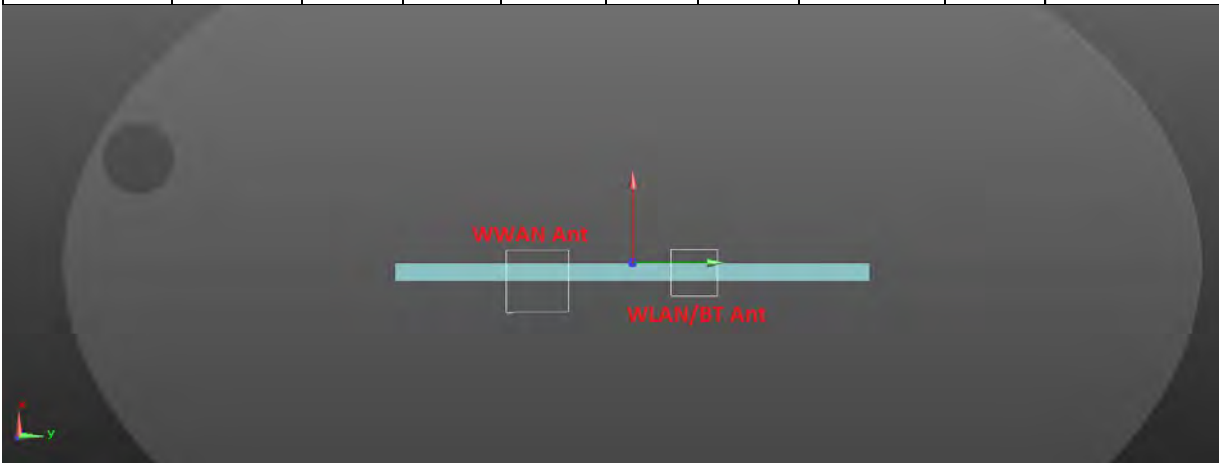

Unless otherwise stated the results shown in this test report refer only to the sample(s) tested and such sample(s) are retained for 90 days only.

除非另有說明，此報告結果僅對測試之樣品負責，同時此樣品僅保留90天。本報告未經本公司書面許可，不可部份複製。

This document is issued by the Company subject to its General Conditions of Service printed overleaf, available on request or accessible at <http://www.sgs.com.tw/Terms-and-Conditions> and for electronic format documents, subject to Terms and Conditions for Electronic Documents at <http://www.sgs.com.tw/Terms-and-Conditions>. Attention is drawn to the limitation of liability, indemnification and jurisdiction issues defined therein. Any holder of this document is advised that information contained hereon reflects the Company's findings at the time of its intervention only and within the limits of Client's instructions, if any. The Company's sole responsibility is to its Client and this document does not exonerate parties to a transaction from exercising all their rights and obligations under the transaction documents. This document cannot be reproduced except in full, without prior written approval of the Company. Any unauthorized alteration, forgery or falsification of the content or appearance of this document is unlawful and offenders may be prosecuted to the fullest extent of the law.

WCDMA Band V + 5 GHz WLAN

Conditions	Position / Distance	SAR Value (W/kg)	Coordinates (cm)			Σ SAR (W/kg)	Peak Location Separation Distance (mm)	SPLSR	Simultaneous Transmission SAR Test
			x	y	z				
WCDMA Band V	Back side 0mm	0.880	7.76	-4.40	0.48	1.738	63.04	0.036	SPLSR<0.04, Not required
WIFI/BT		0.858	7.60	1.90	0.59				



Unless otherwise stated the results shown in this test report refer only to the sample(s) tested and such sample(s) are retained for 90 days only.

除非另有說明，此報告結果僅對測試之樣品負責，同時此樣品僅保留90天。本報告未經本公司書面許可，不可部份複製。

This document is issued by the Company subject to its General Conditions of Service printed overleaf, available on request or accessible at <http://www.sgs.com.tw/Terms-and-Conditions> and for electronic format documents, subject to Terms and Conditions for Electronic Documents at <http://www.sgs.com.tw/Terms-and-Conditions>. Attention is drawn to the limitation of liability, indemnification and jurisdiction issues defined therein. Any holder of this document is advised that information contained hereon reflects the Company's findings at the time of its intervention only and within the limits of Client's instructions, if any. The Company's sole responsibility is to its Client and this document does not exonerate parties to a transaction from exercising all their rights and obligations under the transaction documents. This document cannot be reproduced except in full, without prior written approval of the Company. Any unauthorized alteration, forgery or falsification of the content or appearance of this document is unlawful and offenders may be prosecuted to the fullest extent of the law.

LTE Band 5 + 5 GHz WLAN

Conditions	Position / Distance	SAR Value (W/kg)	Coordinates (cm)			Σ SAR (W/kg)	Peak Location Separation Distance (mm)	SPLSR	Simultaneous Transmission SAR Test
			x	y	z				
LTE Band 5	Back side 11mm	1.133	7.90	-4.93	0.45	1.702	76.55	0.029	SPLSR<0.04, Not required
WIFI/BT		0.569	7.80	2.72	0.52				



Unless otherwise stated the results shown in this test report refer only to the sample(s) tested and such sample(s) are retained for 90 days only.

除非另有說明，此報告結果僅對測試之樣品負責，同時此樣品僅保留90天。本報告未經本公司書面許可，不可部份複製。

This document is issued by the Company subject to its General Conditions of Service printed overleaf, available on request or accessible at <http://www.sgs.com.tw/Terms-and-Conditions> and for electronic format documents, subject to Terms and Conditions for Electronic Documents at <http://www.sgs.com.tw/Terms-and-Conditions>. Attention is drawn to the limitation of liability, indemnification and jurisdiction issues defined therein. Any holder of this document is advised that information contained hereon reflects the Company's findings at the time of its intervention only and within the limits of Client's instructions, if any. The Company's sole responsibility is to its Client and this document does not exonerate parties to a transaction from exercising all their rights and obligations under the transaction documents. This document cannot be reproduced except in full, without prior written approval of the Company. Any unauthorized alteration, forgery or falsification of the content or appearance of this document is unlawful and offenders may be prosecuted to the fullest extent of the law.

LTE Band 5 + 5 GHz WLAN

Conditions	Position / Distance	SAR Value (W/kg)	Coordinates (cm)			Σ SAR (W/kg)	Peak Location Separation Distance (mm)	SPLSR	Simultaneous Transmission SAR Test
			x	y	z				
LTE Band 5	Top side 7mm	1.002	-0.95	-5.06	0.35	2.255	85.86	0.039	SPLSR<0.04, Not required
WIFI/BT		1.253	-0.66	3.52	0.43				

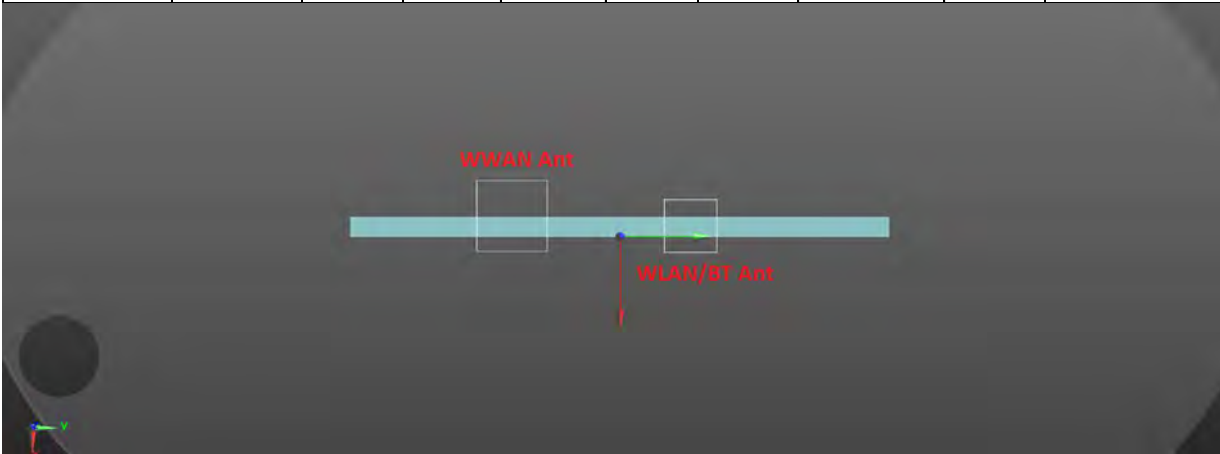

Unless otherwise stated the results shown in this test report refer only to the sample(s) tested and such sample(s) are retained for 90 days only.

除非另有說明，此報告結果僅對測試之樣品負責，同時此樣品僅保留90天。本報告未經本公司書面許可，不可部份複製。

This document is issued by the Company subject to its General Conditions of Service printed overleaf, available on request or accessible at <http://www.sgs.com.tw/Terms-and-Conditions> and for electronic format documents, subject to Terms and Conditions for Electronic Documents at <http://www.sgs.com.tw/Terms-and-Conditions>. Attention is drawn to the limitation of liability, indemnification and jurisdiction issues defined therein. Any holder of this document is advised that information contained hereon reflects the Company's findings at the time of its intervention only and within the limits of Client's instructions, if any. The Company's sole responsibility is to its Client and this document does not exonerate parties to a transaction from exercising all their rights and obligations under the transaction documents. This document cannot be reproduced except in full, without prior written approval of the Company. Any unauthorized alteration, forgery or falsification of the content or appearance of this document is unlawful and offenders may be prosecuted to the fullest extent of the law.

reported SAR WWAN and Bluetooth, Σ SAR evaluation						
Frequency band	Position	Distance (mm)	SAR / W/kg		Σ SAR	SPLSR
			WWAN	BT		
WCDMA Band V	Back side	0	0.880	0.002	0.882	Σ SAR<1.6, Not required
	Top side	0	0.558	0.001	0.559	Σ SAR<1.6, Not required
	Bottom side	0	0.021	0.001	0.022	Σ SAR<1.6, Not required
	Right side	0	0.101	0.001	0.102	Σ SAR<1.6, Not required
	Left side	0	0.118	0.001	0.119	Σ SAR<1.6, Not required
LTE FDD Band 5	Back side	0	0.621	0.002	0.623	Σ SAR<1.6, Not required
	Top side	0	0.407	0.001	0.408	Σ SAR<1.6, Not required
	Bottom side	0	0.019	0.001	0.020	Σ SAR<1.6, Not required
	Right side	0	0.044	0.001	0.045	Σ SAR<1.6, Not required
	Left side	0	0.106	0.001	0.107	Σ SAR<1.6, Not required

Unless otherwise stated the results shown in this test report refer only to the sample(s) tested and such sample(s) are retained for 90 days only.

除非另有說明，此報告結果僅對測試之樣品負責，同時此樣品僅保留90天。本報告未經本公司書面許可，不可部份複製。

This document is issued by the Company subject to its General Conditions of Service printed overleaf, available on request or accessible at <http://www.sgs.com.tw/Terms-and-Conditions>, and for electronic format documents, subject to Terms and Conditions for Electronic Documents at <http://www.sgs.com.tw/Terms-and-Conditions>. Attention is drawn to the limitation of liability, indemnification and jurisdiction issues defined therein. Any holder of this document is advised that information contained hereon reflects the Company's findings at the time of its intervention only and within the limits of Client's instructions, if any. The Company's sole responsibility is to its Client and this document does not exonerate parties to a transaction from exercising all their rights and obligations under the transaction documents. This document cannot be reproduced except in full, without prior written approval of the Company. Any unauthorized alteration, forgery or falsification of the content or appearance of this document is unlawful and offenders may be prosecuted to the fullest extent of the law.

4. Instruments List

Manufacturer	Device	Type	Serial number	Date of last calibration	Date of next calibration
SPEAG	Dosimetric E-Field Probe	EX3DV4	3665	Aug.30,2019	Aug.29,2020
SPEAG	System Validation Dipole	D835V2	4d063	Aug.23,2019	Aug.22,2020
		D2450V2	727	Apr.22,2020	Apr.21,2021
		D5GHzV2	1023	Jan.28,2020	Jan.27,2021
SPEAG	Data acquisition Electronics	DAE4	547	Mar.17,2020	Mar.16,2021
SPEAG	Software	DASY 52 V52.10.3	N/A	Calibration not required	Calibration not required
SPEAG	Phantom	ELI	N/A	Calibration not required	Calibration not required
Agilent	Network Analyzer	E5071C	MY46100433	Dec.13,2019	Dec.12,2020
Agilent	Dielectric Probe Kit	85070E	MY44300677	Calibration not required	Calibration not required
Agilent	Dual-directional coupler	772D	MY46151242	Jul.30,2019	Jul.29,2020
		778D	MY48220468	Jul.30,2019	Jul.29,2020
Agilent	Signal Generator	N5181A	MY50144142	Dec.12,2019	Dec.11,2020
Agilent	Power Meter	ML2496A	1337004	Sep.19,2019	Sep.18,2020
Agilent	Power Sensor	MA2411B	1306052	Sep.19,2019	Sep.18,2020
Changzhou Xinwang	Digital thermometer	DTM-303A	TP190085	Dec.16,2019	Dec.15,2020
Anritsu	Radio Communication Test	MT8820C	6201061049	Dec.08,2019	Dec.07,2020

Unless otherwise stated the results shown in this test report refer only to the sample(s) tested and such sample(s) are retained for 90 days only.

除非另有說明，此報告結果僅對測試之樣品負責，同時此樣品僅保留90天。本報告未經本公司書面許可，不可部份複製。

This document is issued by the Company subject to its General Conditions of Service printed overleaf, available on request or accessible at <http://www.sgs.com.tw/Terms-and-Conditions>, and for electronic format documents, subject to Terms and Conditions for Electronic Documents at <http://www.sgs.com.tw/Terms-and-Conditions>. Attention is drawn to the limitation of liability, indemnification and jurisdiction issues defined therein. Any holder of this document is advised that information contained hereon reflects the Company's findings at the time of its intervention only and within the limits of Client's instructions, if any. The Company's sole responsibility is to its Client and this document does not exonerate parties to a transaction from exercising all their rights and obligations under the transaction documents. This document cannot be reproduced except in full, without prior written approval of the Company. Any unauthorized alteration, forgery or falsification of the content or appearance of this document is unlawful and offenders may be prosecuted to the fullest extent of the law.

5. Measurements

Date: 2020/5/20

Report No. : E5/2020/40009

WCDMA Band V_Body_Back side_CH 4233_11mm

Communication System: WCDMA; Frequency: 846.6 MHz; Duty Cycle: 1:1

Medium parameters used: $f = 847$ MHz; $\sigma = 0.903$ S/m; $\epsilon_r = 41.189$; $\rho = 1000$ kg/m³

Phantom section: Flat Section

Ambient temperature: 22.3°C; Liquid temperature: 21.6°C

DASY5 Configuration:

- Probe: EX3DV4 - SN3665; ConvF(9.47, 9.47, 9.47); Calibrated: 2019/8/30
- Sensor-Surface: 2mm (Mechanical Surface Detection)
- Electronics: DAE4 Sn547; Calibrated: 2020/3/17
- Phantom: ELI
- DASY52 52.10.3(1513); SEMCAD X 14.6.13(7474)

Area Scan (61x91x1): Interpolated grid: dx=15 mm, dy=15 mm

Maximum value of SAR (interpolated) = 1.61 W/kg

Zoom Scan (5x5x7)/Cube 0: Measurement grid: dx=8mm, dy=8mm, dz=5mm

Reference Value = 6.288 V/m; Power Drift = -0.02 dB

Peak SAR (extrapolated) = 2.01 W/kg

SAR(1 g) = 1.13 W/kg; SAR(10 g) = 0.652 W/kg

Smallest distance from peaks to all points 3 dB below = 11.2 mm

Ratio of SAR at M2 to SAR at M1 = 60.2%

Maximum value of SAR (measured) = 1.62 W/kg

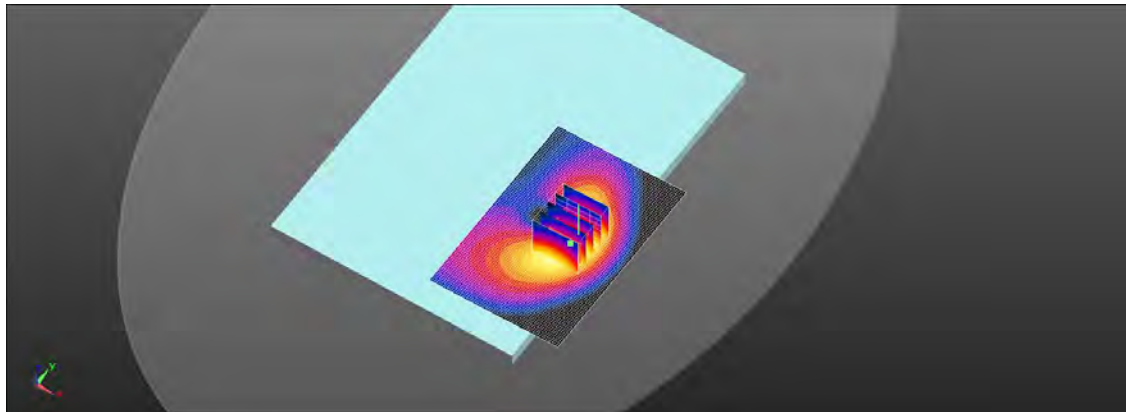
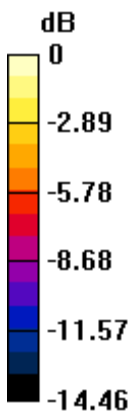

0 dB = 1.62 W/kg = 2.09 dBW/kg

Unless otherwise stated the results shown in this test report refer only to the sample(s) tested and such sample(s) are retained for 90 days only.

除非另有說明，此報告結果僅對測試之樣品負責，同時此樣品僅保留90天。本報告未經本公司書面許可，不可部份複製。

This document is issued by the Company subject to its General Conditions of Service printed overleaf, available on request or accessible at <http://www.sgs.com.tw/Terms-and-Conditions> and for electronic format documents, subject to Terms and Conditions for Electronic Documents at <http://www.sgs.com.tw/Terms-and-Conditions>. Attention is drawn to the limitation of liability, indemnification and jurisdiction issues defined therein. Any holder of this document is advised that information contained hereon reflects the Company's findings at the time of its intervention only and within the limits of Client's instructions, if any. The Company's sole responsibility is to its Client and this document does not exonerate parties to a transaction from exercising all their rights and obligations under the transaction documents. This document cannot be reproduced except in full, without prior written approval of the Company. Any unauthorized alteration, forgery or falsification of the content or appearance of this document is unlawful and offenders may be prosecuted to the fullest extent of the law.

Date: 2020/5/20

Report No. : E5/2020/40009
LTE Band 5 (10MHz)_Body_Back side_CH 20600_QPSK_1-0_11mm

Communication System: LTE; Frequency: 844 MHz; Duty Cycle: 1:1

 Medium parameters used: $f = 844 \text{ MHz}$; $\sigma = 0.901 \text{ S/m}$; $\epsilon_r = 41.147$; $\rho = 1000 \text{ kg/m}^3$

Phantom section: Flat Section

Ambient temperature: 22.3°C; Liquid temperature: 21.6°C

DASY5 Configuration:

- Probe: EX3DV4 - SN3665; ConvF(9.47, 9.47, 9.47); Calibrated: 2019/8/30
- Sensor-Surface: 2mm (Mechanical Surface Detection)
- Electronics: DAE4 Sn547; Calibrated: 2020/3/17
- Phantom: ELI
- DASY52 52.10.3(1513); SEMCAD X 14.6.13(7474)

Area Scan (61x91x1): Interpolated grid: dx=15 mm, dy=15 mm

Maximum value of SAR (interpolated) = 1.48 W/kg

Zoom Scan (5x5x7)/Cube 0: Measurement grid: dx=8mm, dy=8mm, dz=5mm

Reference Value = 6.251 V/m; Power Drift = 0.05 dB

Peak SAR (extrapolated) = 1.91 W/kg

SAR(1 g) = 1.13 W/kg; SAR(10 g) = 0.656 W/kg

Smallest distance from peaks to all points 3 dB below = 11.2 mm

Ratio of SAR at M2 to SAR at M1 = 60.8%

Maximum value of SAR (measured) = 1.52 W/kg

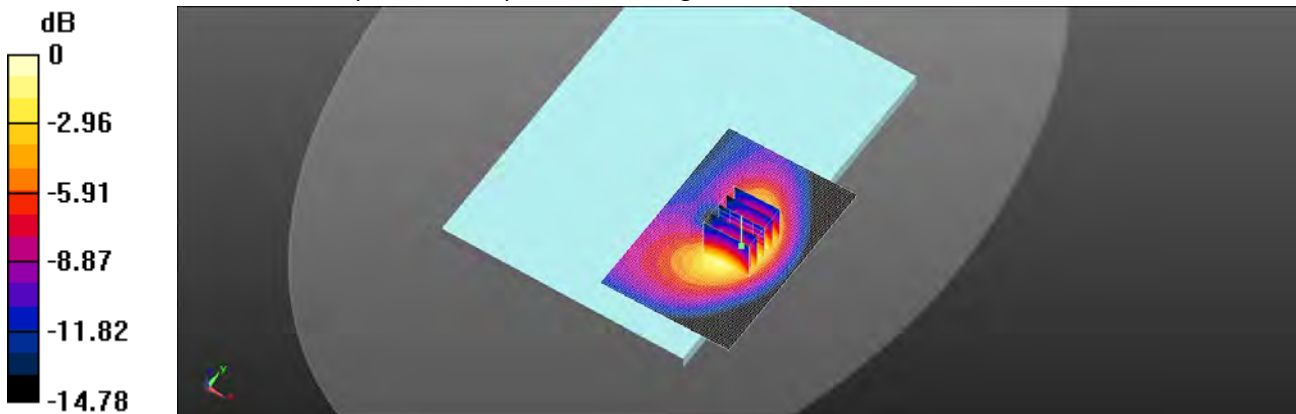

0 dB = 1.52 W/kg = 1.82 dBW/kg

Unless otherwise stated the results shown in this test report refer only to the sample(s) tested and such sample(s) are retained for 90 days only.

除非另有說明，此報告結果僅對測試之樣品負責，同時此樣品僅保留90天。本報告未經本公司書面許可，不可部份複製。

 This document is issued by the Company subject to its General Conditions of Service printed overleaf, available on request or accessible at <http://www.sgs.com.tw/Terms-and-Conditions> and for electronic format documents, subject to Terms and Conditions for Electronic Documents at <http://www.sgs.com.tw/Terms-and-Conditions>. Attention is drawn to the limitation of liability, indemnification and jurisdiction issues defined therein. Any holder of this document is advised that information contained hereon reflects the Company's findings at the time of its intervention only and within the limits of Client's instructions, if any. The Company's sole responsibility is to its Client and this document does not exonerate parties to a transaction from exercising all their rights and obligations under the transaction documents. This document cannot be reproduced except in full, without prior written approval of the Company. Any unauthorized alteration, forgery or falsification of the content or appearance of this document is unlawful and offenders may be prosecuted to the fullest extent of the law.

Date: 2020/6/4

Report No. : E5/2020/40009

WLAN 802.11b_Body_Back side_CH 11_11mm_WIFI_BT

Communication System: WLAN; Frequency: 2462 MHz; Duty Cycle: 1:0.995

Medium parameters used: $f = 2462$ MHz; $\sigma = 1.793$ S/m; $\epsilon_r = 38.812$; $\rho = 3000$ kg/m³

Phantom section: Flat Section

Ambient temperature: 22.1°C; Liquid temperature: 21.7°C

DASY5 Configuration:

- Probe: EX3DV4 - SN3665; ConvF(7.36, 7.36, 7.36); Calibrated: 2019/8/3
- Sensor-Surface: 2mm (Mechanical Surface Detection)
- Electronics: DAE4 Sn547; Calibrated: 2020/3/17
- Phantom: ELI
- DASY52 52.10.3(1513); SEMCAD X 14.6.13(7474)

Area Scan (71x91x1): Interpolated grid: dx=12 mm, dy=12 mm

Maximum value of SAR (interpolated) = 0.210 W/kg

Zoom Scan (7x7x7)/Cube 0: Measurement grid: dx=5mm, dy=5mm, dz=5mm

Reference Value = 1.992 V/m; Power Drift = -0.06 dB

Peak SAR (extrapolated) = 0.271 W/kg

SAR(1 g) = 0.165 W/kg; SAR(10 g) = 0.100 W/kg

Smallest distance from peaks to all points 3 dB below = 11.3 mm

Ratio of SAR at M2 to SAR at M1 = 53.2%

Maximum value of SAR (measured) = 0.199 W/kg

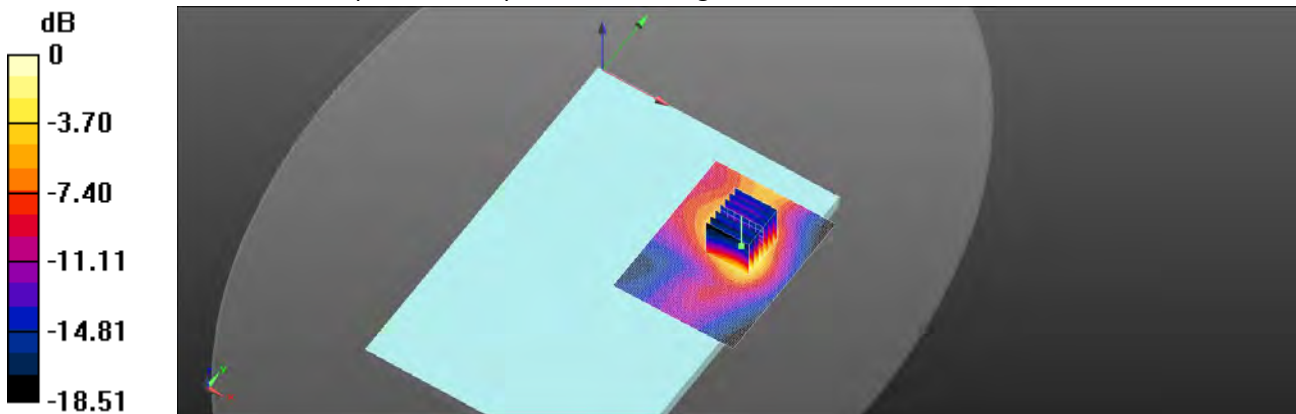

0 dB = 0.199 W/kg = -7.00 dBW/kg

Unless otherwise stated the results shown in this test report refer only to the sample(s) tested and such sample(s) are retained for 90 days only.

除非另有說明，此報告結果僅對測試之樣品負責，同時此樣品僅保留90天。本報告未經本公司書面許可，不可部份複製。

This document is issued by the Company subject to its General Conditions of Service printed overleaf, available on request or accessible at <http://www.sgs.com.tw/Terms-and-Conditions> and for electronic format documents, subject to Terms and Conditions for Electronic Documents at <http://www.sgs.com.tw/Terms-and-Conditions>. Attention is drawn to the limitation of liability, indemnification and jurisdiction issues defined therein. Any holder of this document is advised that information contained hereon reflects the Company's findings at the time of its intervention only and within the limits of Client's instructions, if any. The Company's sole responsibility is to its Client and this document does not exonerate parties to a transaction from exercising all their rights and obligations under the transaction documents. This document cannot be reproduced except in full, without prior written approval of the Company. Any unauthorized alteration, forgery or falsification of the content or appearance of this document is unlawful and offenders may be prosecuted to the fullest extent of the law.

SGS Taiwan Ltd.

No.134,Wu Kung Road, New Taipei Industrial Park, Wuku District, New Taipei City, Taiwan/新北市五股區新北產業園區五工路 134 號

台灣檢驗科技股份有限公司

t (886-2) 2299-3279

f (886-2) 2298-0488

www.sgs.com.tw

Member of SGS Group

Date: 2020/6/4

Report No. : E5/2020/40009

WLAN 802.11g_Body_Back side_CH 1_11mm_WIFI_BT

Communication System: WLAN; Frequency: 2412 MHz; Duty Cycle: 1:0.979

Medium parameters used: $f = 2412$ MHz; $\sigma = 1.749$ S/m; $\epsilon_r = 38.912$; $\rho = 1000$ kg/m³

Phantom section: Flat Section

Ambient temperature: 22.1°C; Liquid temperature: 21.7°C

DASY5 Configuration:

- Probe: EX3DV4 - SN3665; ConvF(7.36, 7.36, 7.36); Calibrated: 2019/8/3
- Sensor-Surface: 2mm (Mechanical Surface Detection)
- Electronics: DAE4 Sn547; Calibrated: 2020/3/17
- Phantom: ELI
- DASY52 52.10.3(1513); SEMCAD X 14.6.13(7474)

Area Scan (71x91x1): Interpolated grid: dx=12 mm, dy=12 mm

Maximum value of SAR (interpolated) = 0.630 W/kg

Zoom Scan (7x7x7)/Cube 0: Measurement grid: dx=5mm, dy=5mm, dz=5mm

Reference Value = 2.795 V/m; Power Drift = -0.02 dB

Peak SAR (extrapolated) = 0.813 W/kg

SAR(1 g) = 0.406 W/kg; SAR(10 g) = 0.207 W/kg

Smallest distance from peaks to all points 3 dB below = 10.3 mm

Ratio of SAR at M2 to SAR at M1 = 50.9%

Maximum value of SAR (measured) = 0.598 W/kg

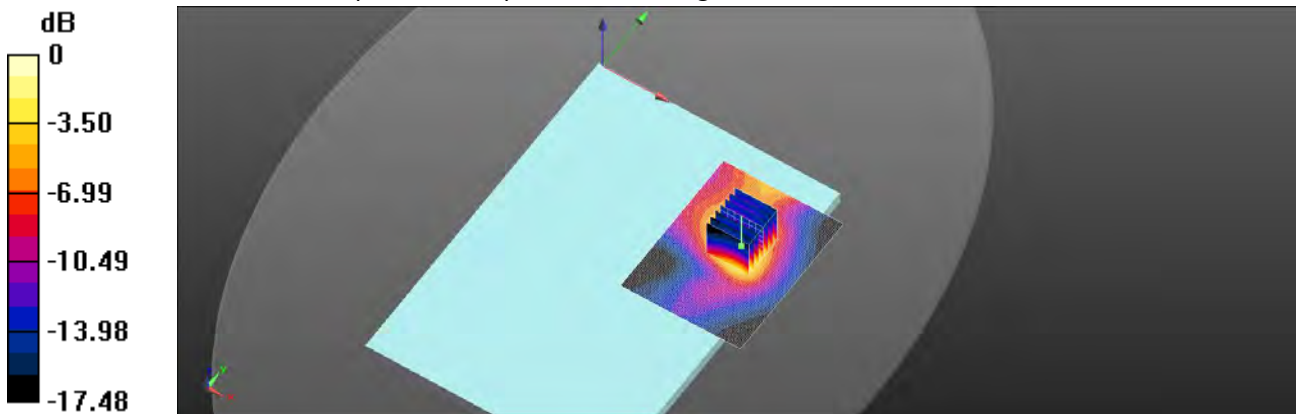

0 dB = 0.598 W/kg = -2.23 dBW/kg

Unless otherwise stated the results shown in this test report refer only to the sample(s) tested and such sample(s) are retained for 90 days only.

除非另有說明，此報告結果僅對測試之樣品負責，同時此樣品僅保留90天。本報告未經本公司書面許可，不可部份複製。

This document is issued by the Company subject to its General Conditions of Service printed overleaf, available on request or accessible at <http://www.sgs.com.tw/Terms-and-Conditions> and for electronic format documents, subject to Terms and Conditions for Electronic Documents at <http://www.sgs.com.tw/Terms-and-Conditions>. Attention is drawn to the limitation of liability, indemnification and jurisdiction issues defined therein. Any holder of this document is advised that information contained hereon reflects the Company's findings at the time of its intervention only and within the limits of Client's instructions, if any. The Company's sole responsibility is to its Client and this document does not exonerate parties to a transaction from exercising all their rights and obligations under the transaction documents. This document cannot be reproduced except in full, without prior written approval of the Company. Any unauthorized alteration, forgery or falsification of the content or appearance of this document is unlawful and offenders may be prosecuted to the fullest extent of the law.

SGS Taiwan Ltd.

No.134,Wu Kung Road, New Taipei Industrial Park, Wuku District, New Taipei City, Taiwan/新北市五股區新北產業園區五工路 134 號

台灣檢驗科技股份有限公司

t (886-2) 2299-3279

f (886-2) 2298-0488

www.sgs.com.tw

Member of SGS Group

Date: 2020/6/4

Report No. : E5/2020/40009

Bluetooth(GFSK)_Body_Back side_CH 39_0mm_WIFI_BT

Communication System: Bluetooth; Frequency: 2441 MHz; Duty Cycle: 1:0.768

Medium parameters used: $f = 2441 \text{ MHz}$; $\sigma = 1.773 \text{ S/m}$; $\epsilon_r = 38.84$; $\rho = 1000 \text{ kg/m}^3$

Phantom section: Flat Section

Ambient temperature: 22.1°C; Liquid temperature: 21.7°C

DASY5 Configuration:

- Probe: EX3DV4 - SN3665; ConvF(7.36, 7.36, 7.36); Calibrated: 2019/8/3
- Sensor-Surface: 2mm (Mechanical Surface Detection)
- Electronics: DAE4 Sn547; Calibrated: 2020/3/17
- Phantom: ELI
- DASY52 52.10.3(1513); SEMCAD X 14.6.13(7474)

Area Scan (91x91x1): Interpolated grid: dx=12 mm, dy=12 mm

Maximum value of SAR (interpolated) = 0.00197 W/kg

Zoom Scan (7x7x7)/Cube 0: Measurement grid: dx=5mm, dy=5mm, dz=5mm

Reference Value = 1.149 V/m; Power Drift = -0.03 dB

Peak SAR (extrapolated) = 0.00376 W/kg

SAR(1 g) = 0.00163 W/kg; SAR(10 g) = 0.00124 W/kg

Ratio of SAR at M2 to SAR at M1 = 41.9%

Maximum value of SAR (measured) = 0.00271 W/kg

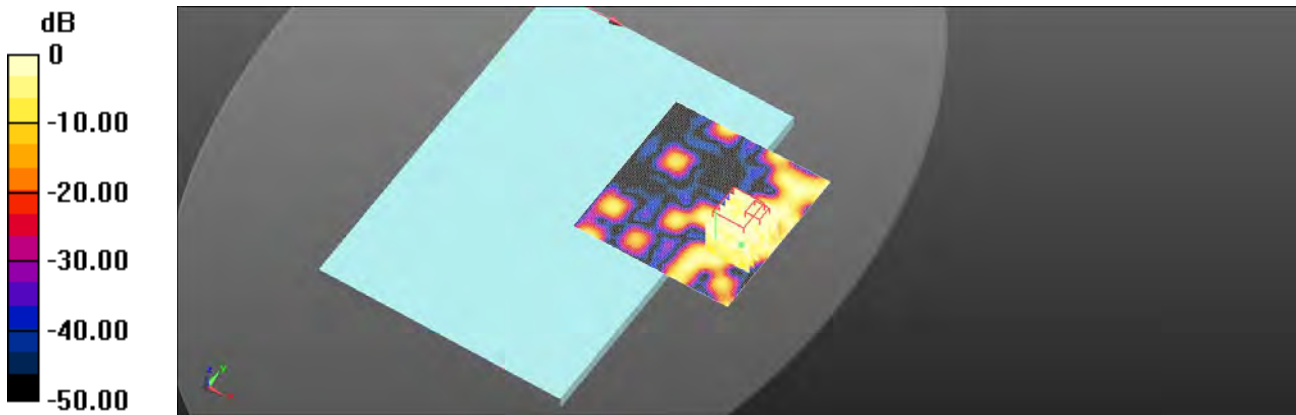

0 dB = 0.00271 W/kg = -25.66 dBW/kg

Unless otherwise stated the results shown in this test report refer only to the sample(s) tested and such sample(s) are retained for 90 days only.

除非另有說明，此報告結果僅對測試之樣品負責，同時此樣品僅保留90天。本報告未經本公司書面許可，不可部份複製。

This document is issued by the Company subject to its General Conditions of Service printed overleaf, available on request or accessible at <http://www.sgs.com.tw/Terms-and-Conditions> and for electronic format documents, subject to Terms and Conditions for Electronic Documents at <http://www.sgs.com.tw/Terms-and-Conditions>. Attention is drawn to the limitation of liability, indemnification and jurisdiction issues defined therein. Any holder of this document is advised that information contained hereon reflects the Company's findings at the time of its intervention only and within the limits of Client's instructions, if any. The Company's sole responsibility is to its Client and this document does not exonerate parties to a transaction from exercising all their rights and obligations under the transaction documents. This document cannot be reproduced except in full, without prior written approval of the Company. Any unauthorized alteration, forgery or falsification of the content or appearance of this document is unlawful and offenders may be prosecuted to the fullest extent of the law.

Date: 2020/6/5

Report No. : E5/2020/40009

WLAN 802.11n(40M) 5.2G_Body_Top side_CH 46_7mm_WIFI_BT

Communication System: WLAN; Frequency: 5230 MHz; Duty Cycle: 1:0.988

Medium parameters used: $f = 5230 \text{ MHz}$; $\sigma = 4.651 \text{ S/m}$; $\epsilon_r = 35.66$; $\rho = 1000 \text{ kg/m}^3$

Phantom section: Flat Section

Ambient temperature: 22.1°C; Liquid temperature: 21.8°C

DASY5 Configuration:

- Probe: EX3DV4 - SN3665; ConvF(5.28, 5.28, 5.28); Calibrated: 2019/8/30
- Sensor-Surface: 2mm (Mechanical Surface Detection)
- Electronics: DAE4 Sn547; Calibrated: 2020/3/17
- Phantom: ELI
- DASY52 52.10.3(1513); SEMCAD X 14.6.13(7474)

Area Scan (61x81x1): Interpolated grid: dx=10 mm, dy=10 mm

Maximum value of SAR (interpolated) = 2.00 W/kg

Zoom Scan (7x7x12)/Cube 0: Measurement grid: dx=4mm, dy=4mm, dz=2mm

Reference Value = 7.465 V/m; Power Drift = -0.05 dB

Peak SAR (extrapolated) = 4.22 W/kg

SAR(1 g) = 1.09 W/kg; SAR(10 g) = 0.407 W/kg

Smallest distance from peaks to all points 3 dB below = 9.7 mm

Ratio of SAR at M2 to SAR at M1 = 52.7%

Maximum value of SAR (measured) = 1.99 W/kg

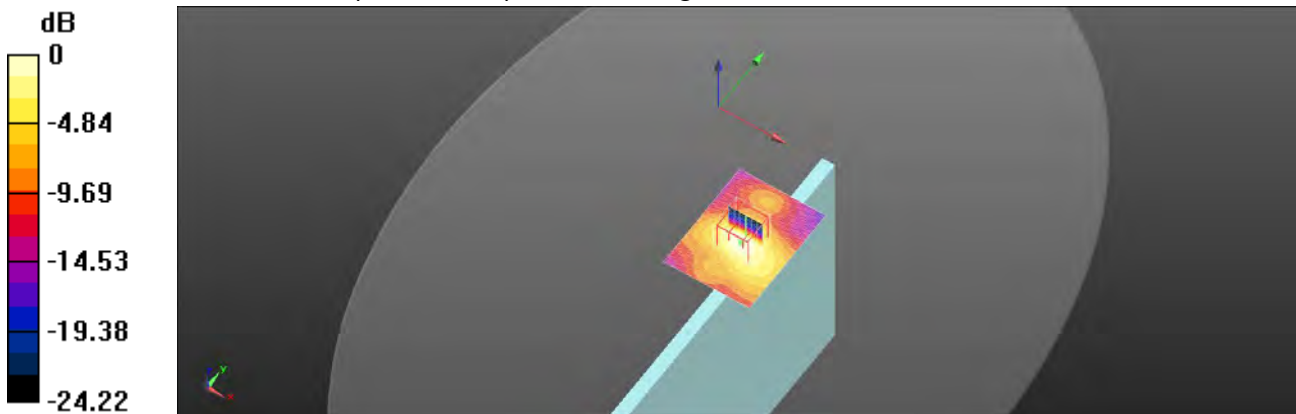

0 dB = 1.99 W/kg = 3.00 dBW/kg

Unless otherwise stated the results shown in this test report refer only to the sample(s) tested and such sample(s) are retained for 90 days only.

除非另有說明，此報告結果僅對測試之樣品負責，同時此樣品僅保留90天。本報告未經本公司書面許可，不可部份複製。

This document is issued by the Company subject to its General Conditions of Service printed overleaf, available on request or accessible at <http://www.sgs.com.tw/Terms-and-Conditions> and for electronic format documents, subject to Terms and Conditions for Electronic Documents at <http://www.sgs.com.tw/Terms-and-Conditions>. Attention is drawn to the limitation of liability, indemnification and jurisdiction issues defined therein. Any holder of this document is advised that information contained hereon reflects the Company's findings at the time of its intervention only and within the limits of Client's instructions, if any. The Company's sole responsibility is to its Client and this document does not exonerate parties to a transaction from exercising all their rights and obligations under the transaction documents. This document cannot be reproduced except in full, without prior written approval of the Company. Any unauthorized alteration, forgery or falsification of the content or appearance of this document is unlawful and offenders may be prosecuted to the fullest extent of the law.

SGS Taiwan Ltd.

No.134,Wu Kung Road, New Taipei Industrial Park, Wuku District, New Taipei City, Taiwan/新北市五股區新北產業園區五工路 134 號

台灣檢驗科技股份有限公司

t (886-2) 2299-3279

f (886-2) 2298-0488

www.sgs.com.tw

Member of SGS Group

Date: 2020/6/5

Report No. : E5/2020/40009

WLAN 802.11ac(40M) 5.2G_Body_Top side_CH 46_7mm_WIFI_BT

Communication System: WLAN; Frequency: 5230 MHz; Duty Cycle: 1:0.990

Medium parameters used: $f = 5230 \text{ MHz}$; $\sigma = 4.651 \text{ S/m}$; $\epsilon_r = 35.66$; $\rho = 1000 \text{ kg/m}^3$

Phantom section: Flat Section

Ambient temperature: 22.1°C; Liquid temperature: 21.8°C

DASY5 Configuration:

- Probe: EX3DV4 - SN3665; ConvF(5.28, 5.28, 5.28); Calibrated: 2019/8/30
- Sensor-Surface: 2mm (Mechanical Surface Detection)
- Electronics: DAE4 Sn547; Calibrated: 2020/3/17
- Phantom: ELI
- DASY52 52.10.3(1513); SEMCAD X 14.6.13(7474)

Area Scan (61x91x1): Interpolated grid: dx=10 mm, dy=10 mm

Maximum value of SAR (interpolated) = 1.70 W/kg

Zoom Scan (7x7x12)/Cube 0: Measurement grid: dx=4mm, dy=4mm, dz=2mm

Reference Value = 6.971 V/m; Power Drift = -0.03 dB

Peak SAR (extrapolated) = 3.41 W/kg

SAR(1 g) = 0.907 W/kg; SAR(10 g) = 0.338 W/kg

Smallest distance from peaks to all points 3 dB below = 10 mm

Ratio of SAR at M2 to SAR at M1 = 52.4%

Maximum value of SAR (measured) = 1.64 W/kg

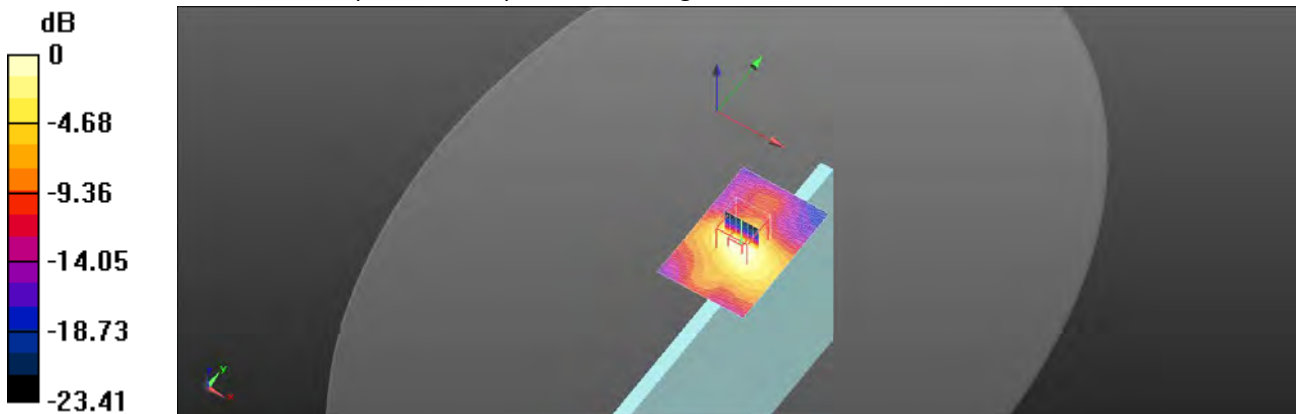

0 dB = 1.64 W/kg = 2.14 dBW/kg

Unless otherwise stated the results shown in this test report refer only to the sample(s) tested and such sample(s) are retained for 90 days only.

除非另有說明，此報告結果僅對測試之樣品負責，同時此樣品僅保留90天。本報告未經本公司書面許可，不可部份複製。

This document is issued by the Company subject to its General Conditions of Service printed overleaf, available on request or accessible at <http://www.sgs.com.tw/Terms-and-Conditions> and for electronic format documents, subject to Terms and Conditions for Electronic Documents at <http://www.sgs.com.tw/Terms-and-Conditions>. Attention is drawn to the limitation of liability, indemnification and jurisdiction issues defined therein. Any holder of this document is advised that information contained hereon reflects the Company's findings at the time of its intervention only and within the limits of Client's instructions, if any. The Company's sole responsibility is to its Client and this document does not exonerate parties to a transaction from exercising all their rights and obligations under the transaction documents. This document cannot be reproduced except in full, without prior written approval of the Company. Any unauthorized alteration, forgery or falsification of the content or appearance of this document is unlawful and offenders may be prosecuted to the fullest extent of the law.

Date: 2020/6/6

Report No. : E5/2020/40009

WLAN 802.11n(40M) 5.3G_Body_Top side_CH 54_7mm_WIFI_BT

Communication System: WLAN; Frequency: 5270 MHz; Duty Cycle: 1:0.988

Medium parameters used: $f = 5270 \text{ MHz}$; $\sigma = 4.695 \text{ S/m}$; $\epsilon_r = 35.633$; $\rho = 1000 \text{ kg/m}^3$

Phantom section: Flat Section

Ambient temperature: 22.4°C; Liquid temperature: 21.7°C

DASY5 Configuration:

- Probe: EX3DV4 - SN3665; ConvF(5.18, 5.18, 5.18); Calibrated: 2019/8/30
- Sensor-Surface: 2mm (Mechanical Surface Detection)
- Electronics: DAE4 Sn547; Calibrated: 2020/3/17
- Phantom: ELI
- DASY52 52.10.3(1513); SEMCAD X 14.6.13(7474)

Area Scan (61x81x1): Interpolated grid: dx=10 mm, dy=10 mm

Maximum value of SAR (interpolated) = 2.22 W/kg

Zoom Scan (7x7x12)/Cube 0: Measurement grid: dx=4mm, dy=4mm, dz=2mm

Reference Value = 7.725 V/m; Power Drift = -0.01 dB

Peak SAR (extrapolated) = 4.22 W/kg

SAR(1 g) = 1.04 W/kg; SAR(10 g) = 0.383 W/kg

Smallest distance from peaks to all points 3 dB below = 10 mm

Ratio of SAR at M2 to SAR at M1 = 51.4%

Maximum value of SAR (measured) = 1.97 W/kg



0 dB = 1.97 W/kg = 2.94 dBW/kg

Unless otherwise stated the results shown in this test report refer only to the sample(s) tested and such sample(s) are retained for 90 days only.

除非另有說明，此報告結果僅對測試之樣品負責，同時此樣品僅保留90天。本報告未經本公司書面許可，不可部份複製。

This document is issued by the Company subject to its General Conditions of Service printed overleaf, available on request or accessible at <http://www.sgs.com.tw/Terms-and-Conditions> and for electronic format documents, subject to Terms and Conditions for Electronic Documents at <http://www.sgs.com.tw/Terms-and-Conditions>. Attention is drawn to the limitation of liability, indemnification and jurisdiction issues defined therein. Any holder of this document is advised that information contained hereon reflects the Company's findings at the time of its intervention only and within the limits of Client's instructions, if any. The Company's sole responsibility is to its Client and this document does not exonerate parties to a transaction from exercising all their rights and obligations under the transaction documents. This document cannot be reproduced except in full, without prior written approval of the Company. Any unauthorized alteration, forgery or falsification of the content or appearance of this document is unlawful and offenders may be prosecuted to the fullest extent of the law.

Date: 2020/6/6

Report No. : E5/2020/40009

WLAN 802.11ac(40M) 5.3G_Body_Top side_CH 54_7mm_WIFI_BT

Communication System: WLAN; Frequency: 5270 MHz; Duty Cycle: 1:0.990

Medium parameters used: $f = 5270 \text{ MHz}$; $\sigma = 4.695 \text{ S/m}$; $\epsilon_r = 35.633$; $\rho = 1000 \text{ kg/m}^3$

Phantom section: Flat Section

Ambient temperature: 22.4°C; Liquid temperature: 21.7°C

DASY5 Configuration:

- Probe: EX3DV4 - SN3665; ConvF(5.18, 5.18, 5.18); Calibrated: 2019/8/30
- Sensor-Surface: 2mm (Mechanical Surface Detection)
- Electronics: DAE4 Sn547; Calibrated: 2020/3/17
- Phantom: ELI
- DASY52 52.10.3(1513); SEMCAD X 14.6.13(7474)

Area Scan (61x81x1): Interpolated grid: dx=10 mm, dy=10 mm

Maximum value of SAR (interpolated) = 1.65 W/kg

Zoom Scan (7x7x12)/Cube 0: Measurement grid: dx=4mm, dy=4mm, dz=2mm

Reference Value = 6.627 V/m; Power Drift = 0.02 dB

Peak SAR (extrapolated) = 3.93 W/kg

SAR(1 g) = 0.984 W/kg; SAR(10 g) = 0.363 W/kg

Smallest distance from peaks to all points 3 dB below = 10.2 mm

Ratio of SAR at M2 to SAR at M1 = 51.8%

Maximum value of SAR (measured) = 1.88 W/kg

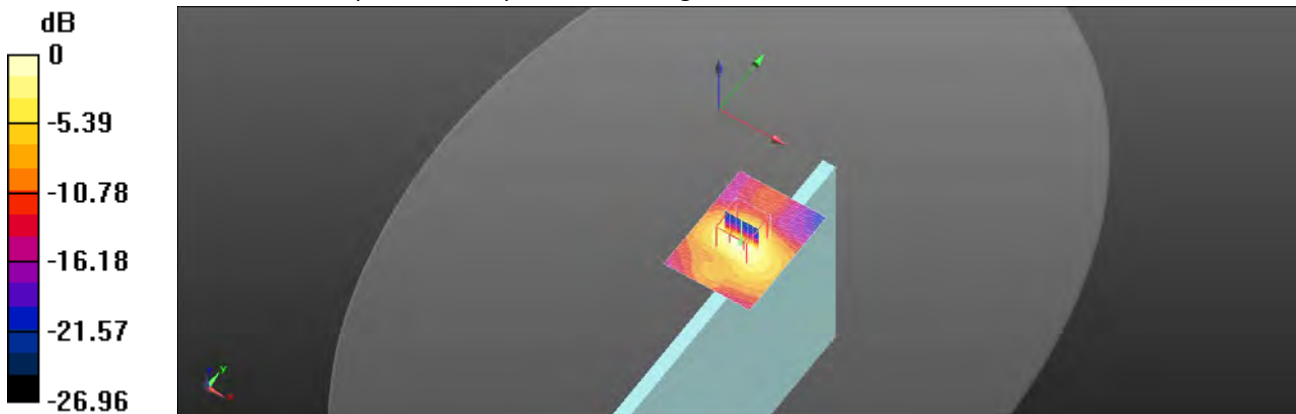

0 dB = 1.88 W/kg = 2.74 dBW/kg

Unless otherwise stated the results shown in this test report refer only to the sample(s) tested and such sample(s) are retained for 90 days only.

除非另有說明，此報告結果僅對測試之樣品負責，同時此樣品僅保留90天。本報告未經本公司書面許可，不可部份複製。

This document is issued by the Company subject to its General Conditions of Service printed overleaf, available on request or accessible at <http://www.sgs.com.tw/Terms-and-Conditions> and for electronic format documents, subject to Terms and Conditions for Electronic Documents at <http://www.sgs.com.tw/Terms-and-Conditions>. Attention is drawn to the limitation of liability, indemnification and jurisdiction issues defined therein. Any holder of this document is advised that information contained hereon reflects the Company's findings at the time of its intervention only and within the limits of Client's instructions, if any. The Company's sole responsibility is to its Client and this document does not exonerate parties to a transaction from exercising all their rights and obligations under the transaction documents. This document cannot be reproduced except in full, without prior written approval of the Company. Any unauthorized alteration, forgery or falsification of the content or appearance of this document is unlawful and offenders may be prosecuted to the fullest extent of the law.

SGS Taiwan Ltd.

No.134,Wu Kung Road, New Taipei Industrial Park, Wuku District, New Taipei City, Taiwan/新北市五股區新北產業園區五工路 134 號

台灣檢驗科技股份有限公司

t (886-2) 2299-3279

f (886-2) 2298-0488

www.sgs.com.tw

Member of SGS Group

Date: 2020/5/24

Report No. : E5/2020/40009

WLAN 802.11ac(80M) 5.6G_Body_Top side_CH 122_7mm_WIFI_BT

Communication System: WLAN; Frequency: 5610 MHz; Duty Cycle: 1:0.988

Medium parameters used: $f = 5610 \text{ MHz}$; $\sigma = 5.041 \text{ S/m}$; $\epsilon_r = 35.247$; $\rho = 1000 \text{ kg/m}^3$

Phantom section: Flat Section

Ambient temperature: 22.2°C; Liquid temperature: 21.9°C

DASY5 Configuration:

- Probe: EX3DV4 - SN3665; ConvF(4.99, 4.99, 4.99); Calibrated: 2019/8/30
- Sensor-Surface: 2mm (Mechanical Surface Detection)
- Electronics: DAE4 Sn547; Calibrated: 2020/3/17
- Phantom: ELI
- DASY52 52.10.3(1513); SEMCAD X 14.6.13(7474)

Area Scan (61x81x1): Interpolated grid: dx=10 mm, dy=10 mm

Maximum value of SAR (interpolated) = 1.27 W/kg

Zoom Scan (7x7x12)/Cube 0: Measurement grid: dx=4mm, dy=4mm, dz=2mm

Reference Value = 7.800 V/m; Power Drift = -0.05 dB

Peak SAR (extrapolated) = 3.14 W/kg

SAR(1 g) = 0.685 W/kg; SAR(10 g) = 0.255 W/kg

Smallest distance from peaks to all points 3 dB below = 9.3 mm

Ratio of SAR at M2 to SAR at M1 = 48%

Maximum value of SAR (measured) = 1.30 W/kg

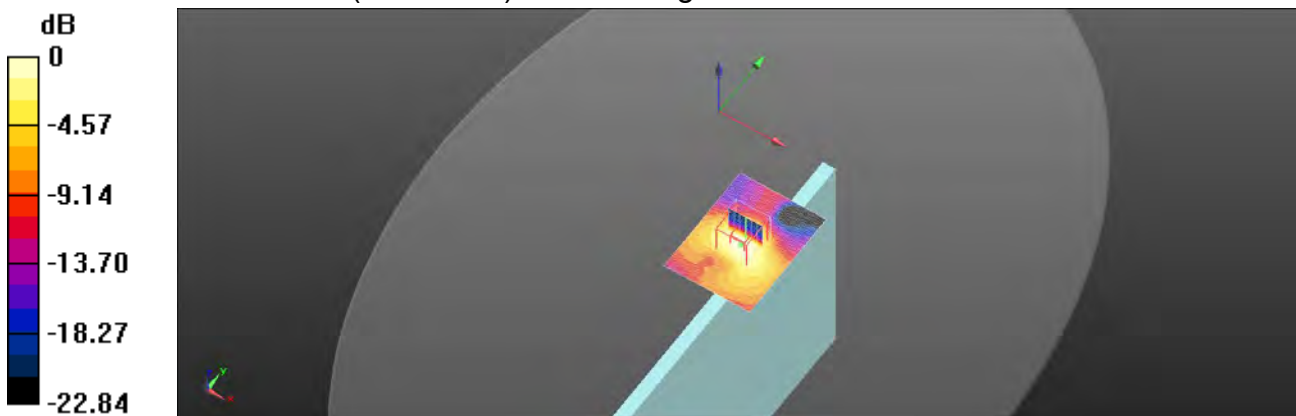

0 dB = 1.30 W/kg = 1.14 dBW/kg

Unless otherwise stated the results shown in this test report refer only to the sample(s) tested and such sample(s) are retained for 90 days only.

除非另有說明，此報告結果僅對測試之樣品負責，同時此樣品僅保留90天。本報告未經本公司書面許可，不可部份複製。

This document is issued by the Company subject to its General Conditions of Service printed overleaf, available on request or accessible at <http://www.sgs.com.tw/Terms-and-Conditions> and for electronic format documents, subject to Terms and Conditions for Electronic Documents at <http://www.sgs.com.tw/Terms-and-Conditions>. Attention is drawn to the limitation of liability, indemnification and jurisdiction issues defined therein. Any holder of this document is advised that information contained hereon reflects the Company's findings at the time of its intervention only and within the limits of Client's instructions, if any. The Company's sole responsibility is to its Client and this document does not exonerate parties to a transaction from exercising all their rights and obligations under the transaction documents. This document cannot be reproduced except in full, without prior written approval of the Company. Any unauthorized alteration, forgery or falsification of the content or appearance of this document is unlawful and offenders may be prosecuted to the fullest extent of the law.

Date: 2020/5/20

Report No. : E5/2020/40009

WCDMA Band V_Body_Back side_CH 4233_0mm

Communication System: WCDMA; Frequency: 846.6 MHz; Duty Cycle: 1:1

Medium parameters used: $f = 847 \text{ MHz}$; $\sigma = 0.903 \text{ S/m}$; $\epsilon_r = 41.189$; $\rho = 1000 \text{ kg/m}^3$

Phantom section: Flat Section

Ambient temperature: 22.3°C; Liquid temperature: 21.6°C

DASY5 Configuration:

- Probe: EX3DV4 - SN3665; ConvF(9.47, 9.47, 9.47); Calibrated: 2019/8/30
- Sensor-Surface: 2mm (Mechanical Surface Detection)
- Electronics: DAE4 Sn547; Calibrated: 2020/3/17
- Phantom: ELI
- DASY52 52.10.3(1513); SEMCAD X 14.6.13(7474)

Area Scan (61x71x1): Interpolated grid: dx=15 mm, dy=15 mm

Maximum value of SAR (interpolated) = 0.893 W/kg

Zoom Scan (5x5x7)/Cube 0: Measurement grid: dx=8mm, dy=8mm, dz=5mm

Reference Value = 0.7980 V/m; Power Drift = 0.04 dB

Peak SAR (extrapolated) = 1.50 W/kg

SAR(1 g) = 0.657 W/kg; SAR(10 g) = 0.318 W/kg

Smallest distance from peaks to all points 3 dB below = 8.4 mm

Ratio of SAR at M2 to SAR at M1 = 42.5%

Maximum value of SAR (measured) = 1.10 W/kg

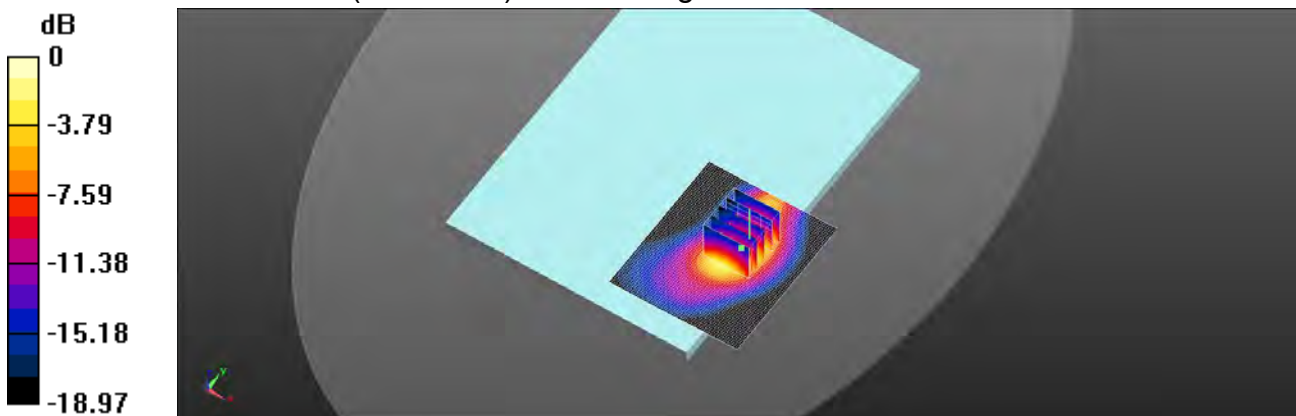

0 dB = 1.10 W/kg = 0.42 dBW/kg

Unless otherwise stated the results shown in this test report refer only to the sample(s) tested and such sample(s) are retained for 90 days only.
除非另有說明，此報告結果僅對測試之樣品負責，同時此樣品僅保留90天。本報告未經本公司書面許可，不可部份複製。

This document is issued by the Company subject to its General Conditions of Service printed overleaf, available on request or accessible at <http://www.sgs.com.tw/Terms-and-Conditions> and for electronic format documents, subject to Terms and Conditions for Electronic Documents at <http://www.sgs.com.tw/Terms-and-Conditions>. Attention is drawn to the limitation of liability, indemnification and jurisdiction issues defined therein. Any holder of this document is advised that information contained hereon reflects the Company's findings at the time of its intervention only and within the limits of Client's instructions, if any. The Company's sole responsibility is to its Client and this document does not exonerate parties to a transaction from exercising all their rights and obligations under the transaction documents. This document cannot be reproduced except in full, without prior written approval of the Company. Any unauthorized alteration, forgery or falsification of the content or appearance of this document is unlawful and offenders may be prosecuted to the fullest extent of the law.

Date: 2020/5/20

Report No. : E5/2020/40009
LTE Band 5 (10MHz)_Body_Back side_CH 20600_QPSK_1-25_0mm

Communication System: LTE; Frequency: 844 MHz; Duty Cycle: 1:1

 Medium parameters used: $f = 844 \text{ MHz}$; $\sigma = 0.901 \text{ S/m}$; $\epsilon_r = 41.147$; $\rho = 1000 \text{ kg/m}^3$

Phantom section: Flat Section

Ambient temperature: 22.3°C; Liquid temperature: 21.6°C

DASY5 Configuration:

- Probe: EX3DV4 - SN3665; ConvF(9.47, 9.47, 9.47); Calibrated: 2019/8/30
- Sensor-Surface: 2mm (Mechanical Surface Detection)
- Electronics: DAE4 Sn547; Calibrated: 2020/3/17
- Phantom: ELI
- DASY52 52.10.3(1513); SEMCAD X 14.6.13(7474)

Area Scan (61x71x1): Interpolated grid: dx=15 mm, dy=15 mm

Maximum value of SAR (interpolated) = 0.817 W/kg

Zoom Scan (5x5x7)/Cube 0: Measurement grid: dx=8mm, dy=8mm, dz=5mm

Reference Value = 0.9260 V/m; Power Drift = 0.05 dB

Peak SAR (extrapolated) = 1.41 W/kg

SAR(1 g) = 0.605 W/kg; SAR(10 g) = 0.292 W/kg

Smallest distance from peaks to all points 3 dB below = 8.4 mm

Ratio of SAR at M2 to SAR at M1 = 45.2%

Maximum value of SAR (measured) = 1.03 W/kg

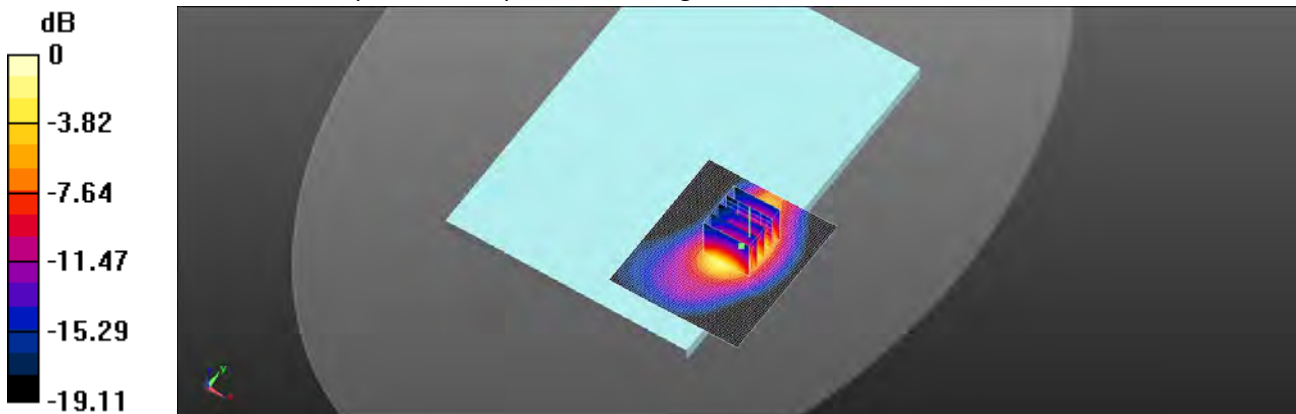

0 dB = 1.03 W/kg = 0.14 dBW/kg

Unless otherwise stated the results shown in this test report refer only to the sample(s) tested and such sample(s) are retained for 90 days only.

除非另有說明，此報告結果僅對測試之樣品負責，同時此樣品僅保留90天。本報告未經本公司書面許可，不可部份複製。

 This document is issued by the Company subject to its General Conditions of Service printed overleaf, available on request or accessible at <http://www.sgs.com.tw/Terms-and-Conditions> and for electronic format documents, subject to Terms and Conditions for Electronic Documents at <http://www.sgs.com.tw/Terms-and-Conditions>. Attention is drawn to the limitation of liability, indemnification and jurisdiction issues defined therein. Any holder of this document is advised that information contained hereon reflects the Company's findings at the time of its intervention only and within the limits of Client's instructions, if any. The Company's sole responsibility is to its Client and this document does not exonerate parties to a transaction from exercising all their rights and obligations under the transaction documents. This document cannot be reproduced except in full, without prior written approval of the Company. Any unauthorized alteration, forgery or falsification of the content or appearance of this document is unlawful and offenders may be prosecuted to the fullest extent of the law.

Date: 2020/6/4

Report No. : E5/2020/40009

WLAN 802.11b_Body_Back side_CH 6_0mm_WIFI_BT

Communication System: WLAN; Frequency: 2437 MHz; Duty Cycle: 1:0.995

Medium parameters used: $f = 2437 \text{ MHz}$; $\sigma = 1.768 \text{ S/m}$; $\epsilon_r = 38.819$; $\rho = 1000 \text{ kg/m}^3$

Phantom section: Flat Section

Ambient temperature: 22.1°C; Liquid temperature: 21.7°C

DASY5 Configuration:

- Probe: EX3DV4 - SN3665; ConvF(7.36, 7.36, 7.36); Calibrated: 2019/8/3
- Sensor-Surface: 2mm (Mechanical Surface Detection)
- Electronics: DAE4 Sn547; Calibrated: 2020/3/17
- Phantom: ELI
- DASY52 52.10.3(1513); SEMCAD X 14.6.13(7474)

Area Scan (71x81x1): Interpolated grid: dx=12 mm, dy=12 mm

Maximum value of SAR (interpolated) = 1.04 W/kg

Zoom Scan (7x7x7)/Cube 0: Measurement grid: dx=5mm, dy=5mm, dz=5mm

Reference Value = 0.7950 V/m; Power Drift = 0.01 dB

Peak SAR (extrapolated) = 1.71 W/kg

SAR(1 g) = 0.585 W/kg; SAR(10 g) = 0.223 W/kg

Smallest distance from peaks to all points 3 dB below = 8.7 mm

Ratio of SAR at M2 to SAR at M1 = 44.9%

Maximum value of SAR (measured) = 1.08 W/kg

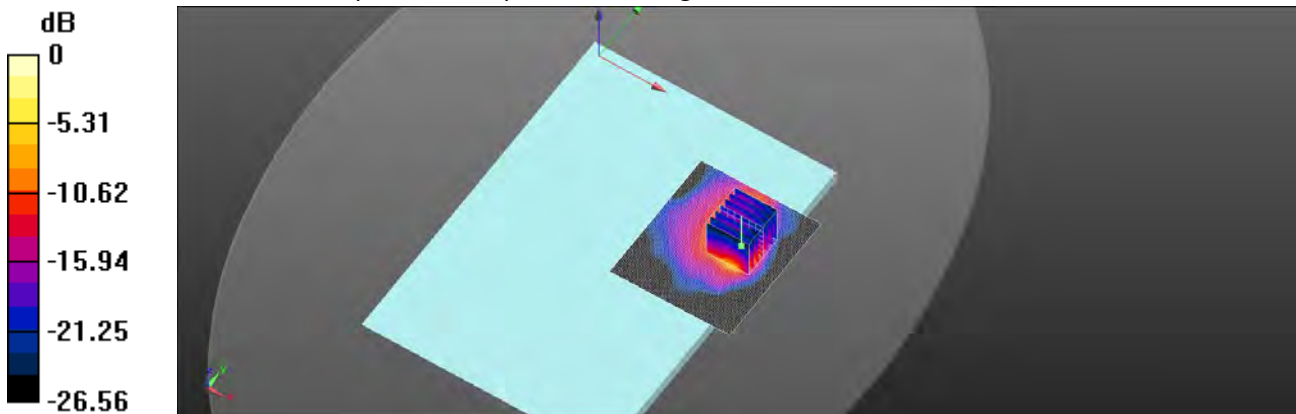

0 dB = 1.08 W/kg = 0.34 dBW/kg

Unless otherwise stated the results shown in this test report refer only to the sample(s) tested and such sample(s) are retained for 90 days only.

除非另有說明，此報告結果僅對測試之樣品負責，同時此樣品僅保留90天。本報告未經本公司書面許可，不可部份複製。

This document is issued by the Company subject to its General Conditions of Service printed overleaf, available on request or accessible at <http://www.sgs.com.tw/Terms-and-Conditions> and for electronic format documents, subject to Terms and Conditions for Electronic Documents at <http://www.sgs.com.tw/Terms-and-Conditions>. Attention is drawn to the limitation of liability, indemnification and jurisdiction issues defined therein. Any holder of this document is advised that information contained hereon reflects the Company's findings at the time of its intervention only and within the limits of Client's instructions, if any. The Company's sole responsibility is to its Client and this document does not exonerate parties to a transaction from exercising all their rights and obligations under the transaction documents. This document cannot be reproduced except in full, without prior written approval of the Company. Any unauthorized alteration, forgery or falsification of the content or appearance of this document is unlawful and offenders may be prosecuted to the fullest extent of the law.

SGS Taiwan Ltd.

No.134,Wu Kung Road, New Taipei Industrial Park, Wuku District, New Taipei City, Taiwan/新北市五股區新北產業園區五工路 134 號

台灣檢驗科技股份有限公司

t (886-2) 2299-3279

f (886-2) 2298-0488

www.sgs.com.tw

Member of SGS Group

Date: 2020/6/5

Report No. : E5/2020/40009

WLAN 802.11n(40M) 5.2G_Body_Back side_CH 46_0mm_WIFI_BT

Communication System: WLAN; Frequency: 5230 MHz; Duty Cycle: 1:0.988

Medium parameters used: $f = 5230$ MHz; $\sigma = 4.651$ S/m; $\epsilon_r = 35.66$; $\rho = 1000$ kg/m³

Phantom section: Flat Section

Ambient temperature: 22.1°C; Liquid temperature: 21.8°C

DASY5 Configuration:

- Probe: EX3DV4 - SN3665; ConvF(5.28, 5.28, 5.28); Calibrated: 2019/8/30
- Sensor-Surface: 2mm (Mechanical Surface Detection)
- Electronics: DAE4 Sn547; Calibrated: 2020/3/17
- Phantom: ELI
- DASY52 52.10.3(1513); SEMCAD X 14.6.13(7474)

Area Scan (81x101x1): Interpolated grid: dx=10 mm, dy=10 mm

Maximum value of SAR (interpolated) = 1.86 W/kg

Zoom Scan (7x7x12)/Cube 0: Measurement grid: dx=4mm, dy=4mm, dz=2mm

Reference Value = 1.654 V/m; Power Drift = -0.86 dB

Peak SAR (extrapolated) = 3.98 W/kg

SAR(1 g) = 0.781 W/kg; SAR(10 g) = 0.208 W/kg

Smallest distance from peaks to all points 3 dB below = 7.1 mm

Ratio of SAR at M2 to SAR at M1 = 52.8%

Maximum value of SAR (measured) = 1.73 W/kg

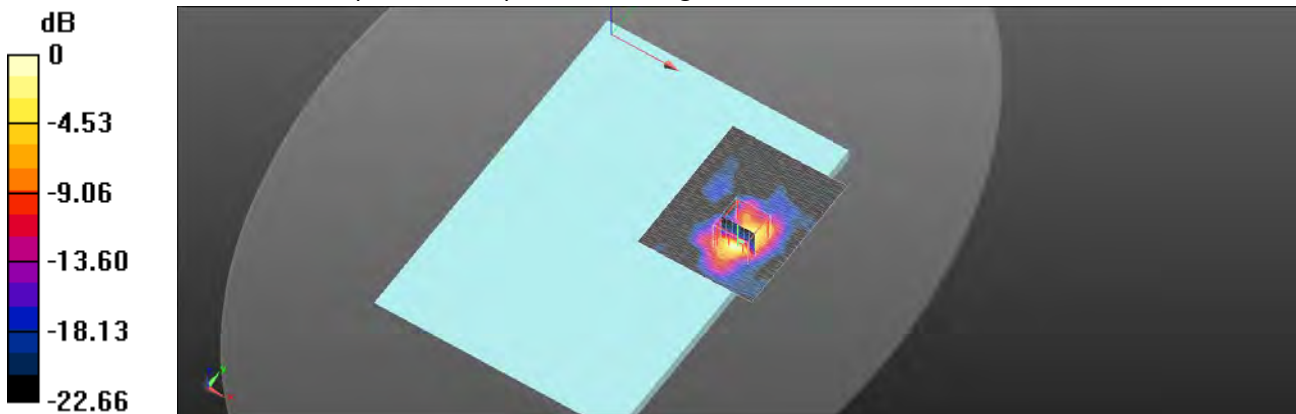

0 dB = 1.73 W/kg = 2.39 dBW/kg

Unless otherwise stated the results shown in this test report refer only to the sample(s) tested and such sample(s) are retained for 90 days only.

除非另有說明，此報告結果僅對測試之樣品負責，同時此樣品僅保留90天。本報告未經本公司書面許可，不可部份複製。

This document is issued by the Company subject to its General Conditions of Service printed overleaf, available on request or accessible at <http://www.sgs.com.tw/Terms-and-Conditions> and for electronic format documents, subject to Terms and Conditions for Electronic Documents at <http://www.sgs.com.tw/Terms-and-Conditions>. Attention is drawn to the limitation of liability, indemnification and jurisdiction issues defined therein. Any holder of this document is advised that information contained hereon reflects the Company's findings at the time of its intervention only and within the limits of Client's instructions, if any. The Company's sole responsibility is to its Client and this document does not exonerate parties to a transaction from exercising all their rights and obligations under the transaction documents. This document cannot be reproduced except in full, without prior written approval of the Company. Any unauthorized alteration, forgery or falsification of the content or appearance of this document is unlawful and offenders may be prosecuted to the fullest extent of the law.

SGS Taiwan Ltd.

No.134,Wu Kung Road, New Taipei Industrial Park, Wuku District, New Taipei City, Taiwan/新北市五股區新北產業園區五工路 134 號

台灣檢驗科技股份有限公司

t (886-2) 2299-3279

f (886-2) 2298-0488

www.sgs.com.tw

Member of SGS Group

Date: 2020/6/5

Report No. : E5/2020/40009

WLAN 802.11ac(80M) 5.2G_Body_Back side_CH 42_0mm_WIFI_BT

Communication System: WLAN; Frequency: 5210 MHz; Duty Cycle: 1:0.988

Medium parameters used: $f = 5210 \text{ MHz}$; $\sigma = 4.632 \text{ S/m}$; $\epsilon_r = 35.69$; $\rho = 1000 \text{ kg/m}^3$

Phantom section: Flat Section

Ambient temperature: 22.1°C; Liquid temperature: 21.8°C

DASY5 Configuration:

- Probe: EX3DV4 - SN3665; ConvF(5.28, 5.28, 5.28); Calibrated: 2019/8/30
- Sensor-Surface: 2mm (Mechanical Surface Detection)
- Electronics: DAE4 Sn547; Calibrated: 2020/3/17
- Phantom: ELI
- DASY52 52.10.3(1513); SEMCAD X 14.6.13(7474)

Area Scan (81x101x1): Interpolated grid: dx=10 mm, dy=10 mm

Maximum value of SAR (interpolated) = 2.12 W/kg

Zoom Scan (7x7x12)/Cube 0: Measurement grid: dx=4mm, dy=4mm, dz=2mm

Reference Value = 2.679 V/m; Power Drift = 0.05 dB

Peak SAR (extrapolated) = 4.34 W/kg

SAR(1 g) = 0.812 W/kg; SAR(10 g) = 0.240 W/kg

Smallest distance from peaks to all points 3 dB below = 7.1 mm

Ratio of SAR at M2 to SAR at M1 = 56.6%

Maximum value of SAR (measured) = 1.84 W/kg

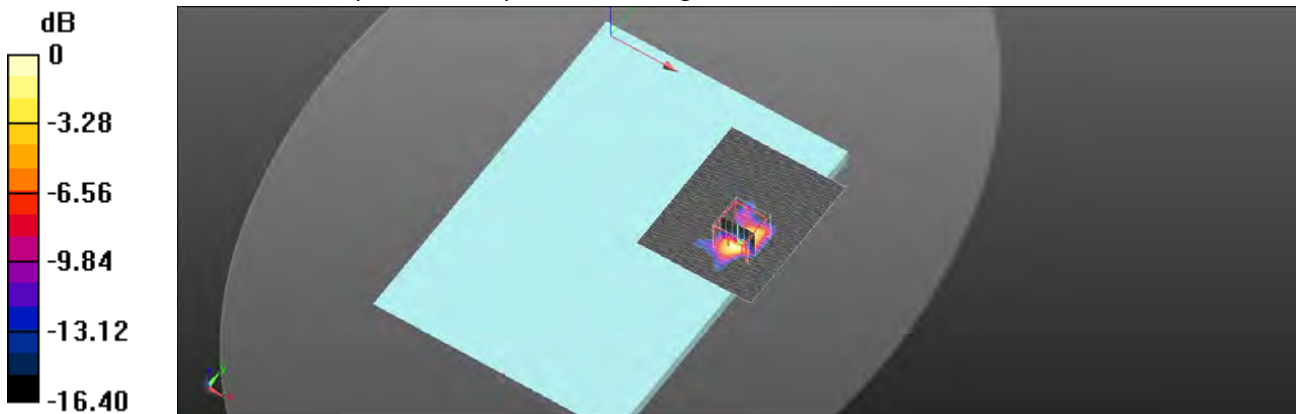

0 dB = 1.84 W/kg = 2.66 dBW/kg

Unless otherwise stated the results shown in this test report refer only to the sample(s) tested and such sample(s) are retained for 90 days only.

除非另有說明，此報告結果僅對測試之樣品負責，同時此樣品僅保留90天。本報告未經本公司書面許可，不可部份複製。

This document is issued by the Company subject to its General Conditions of Service printed overleaf, available on request or accessible at <http://www.sgs.com.tw/Terms-and-Conditions> and for electronic format documents, subject to Terms and Conditions for Electronic Documents at <http://www.sgs.com.tw/Terms-and-Conditions>. Attention is drawn to the limitation of liability, indemnification and jurisdiction issues defined therein. Any holder of this document is advised that information contained hereon reflects the Company's findings at the time of its intervention only and within the limits of Client's instructions, if any. The Company's sole responsibility is to its Client and this document does not exonerate parties to a transaction from exercising all their rights and obligations under the transaction documents. This document cannot be reproduced except in full, without prior written approval of the Company. Any unauthorized alteration, forgery or falsification of the content or appearance of this document is unlawful and offenders may be prosecuted to the fullest extent of the law.

SGS Taiwan Ltd.

No.134,Wu Kung Road, New Taipei Industrial Park, Wuku District, New Taipei City, Taiwan/新北市五股區新北產業園區五工路 134 號

台灣檢驗科技股份有限公司

t (886-2) 2299-3279

f (886-2) 2298-0488

www.sgs.com.tw

Member of SGS Group

Date: 2020/6/6

Report No. : E5/2020/40009

WLAN 802.11n(40M) 5.3G_Body_Back side_CH 62_0mm_WIFI_BT

Communication System: WLAN; Frequency: 5310 MHz; Duty Cycle: 1:0.988

Medium parameters used: $f = 5310 \text{ MHz}$; $\sigma = 4.734 \text{ S/m}$; $\epsilon_r = 35.559$; $\rho = 1000 \text{ kg/m}^3$

Phantom section: Flat Section

Ambient temperature: 22.4°C; Liquid temperature: 21.7°C

DASY5 Configuration:

- Probe: EX3DV4 - SN3665; ConvF(5.18, 5.18, 5.18); Calibrated: 2019/8/30
- Sensor-Surface: 2mm (Mechanical Surface Detection)
- Electronics: DAE4 Sn547; Calibrated: 2020/3/17
- Phantom: ELI
- DASY52 52.10.3(1513); SEMCAD X 14.6.13(7474)

Area Scan (81x101x1): Interpolated grid: dx=10 mm, dy=10 mm

Maximum value of SAR (interpolated) = 1.72 W/kg

Zoom Scan (7x7x12)/Cube 0: Measurement grid: dx=4mm, dy=4mm, dz=2mm

Reference Value = 1.456 V/m; Power Drift = 0.03 dB

Peak SAR (extrapolated) = 3.98 W/kg

SAR(1 g) = 0.726 W/kg; SAR(10 g) = 0.190 W/kg

Smallest distance from peaks to all points 3 dB below = 8.1 mm

Ratio of SAR at M2 to SAR at M1 = 59.3%

Maximum value of SAR (measured) = 1.56 W/kg

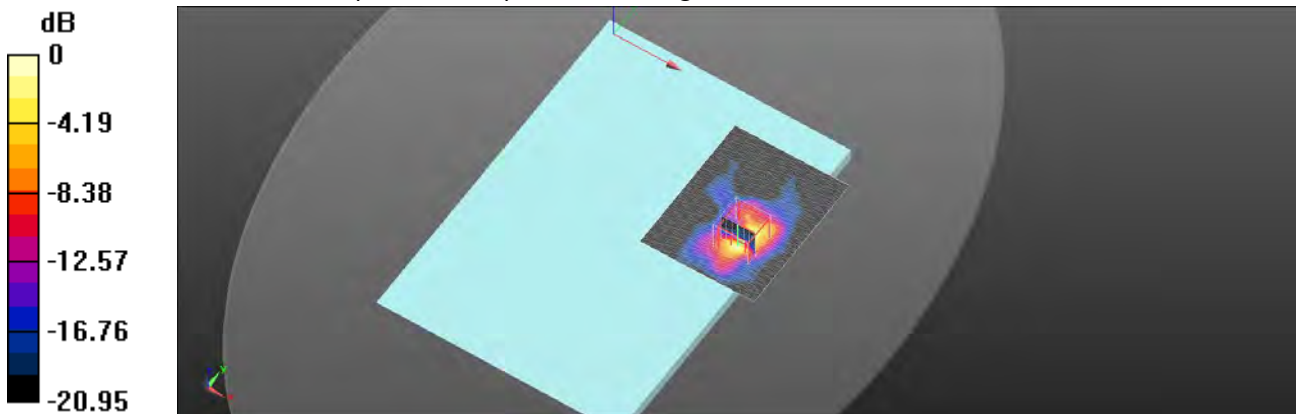

0 dB = 1.56 W/kg = 1.93 dBW/kg

Unless otherwise stated the results shown in this test report refer only to the sample(s) tested and such sample(s) are retained for 90 days only.

除非另有說明，此報告結果僅對測試之樣品負責，同時此樣品僅保留90天。本報告未經本公司書面許可，不可部份複製。

This document is issued by the Company subject to its General Conditions of Service printed overleaf, available on request or accessible at <http://www.sgs.com.tw/Terms-and-Conditions> and for electronic format documents, subject to Terms and Conditions for Electronic Documents at <http://www.sgs.com.tw/Terms-and-Conditions>. Attention is drawn to the limitation of liability, indemnification and jurisdiction issues defined therein. Any holder of this document is advised that information contained hereon reflects the Company's findings at the time of its intervention only and within the limits of Client's instructions, if any. The Company's sole responsibility is to its Client and this document does not exonerate parties to a transaction from exercising all their rights and obligations under the transaction documents. This document cannot be reproduced except in full, without prior written approval of the Company. Any unauthorized alteration, forgery or falsification of the content or appearance of this document is unlawful and offenders may be prosecuted to the fullest extent of the law.

Date: 2020/6/6

Report No. : E5/2020/40009
WLAN 802.11ac(80M) 5.3G_Body_Back side_CH 58_0mm_WIFI_BT

Communication System: WLAN; Frequency: 5290 MHz; Duty Cycle: 1:0.988

 Medium parameters used: $f = 5290 \text{ MHz}$; $\sigma = 4.716 \text{ S/m}$; $\epsilon_r = 35.589$; $\rho = 1000 \text{ kg/m}^3$

Phantom section: Flat Section

 Ambient temperature: 22.4°C ; Liquid temperature: 21.7°C

DASY5 Configuration:

- Probe: EX3DV4 - SN3665; ConvF(5.18, 5.18, 5.18); Calibrated: 2019/8/30
- Sensor-Surface: 2mm (Mechanical Surface Detection)
- Electronics: DAE4 Sn547; Calibrated: 2020/3/17
- Phantom: ELI
- DASY52 52.10.3(1513); SEMCAD X 14.6.13(7474)

Area Scan (81x101x1): Interpolated grid: $dx=10 \text{ mm}$, $dy=10 \text{ mm}$

 Maximum value of SAR (interpolated) = 2.04 W/kg
Zoom Scan (7x7x12)/Cube 0: Measurement grid: $dx=4\text{mm}$, $dy=4\text{mm}$, $dz=2\text{mm}$

 Reference Value = 3.079 V/m ; Power Drift = -0.01 dB

 Peak SAR (extrapolated) = 4.43 W/kg
SAR(1 g) = 0.828 W/kg ; SAR(10 g) = 0.234 W/kg

 Smallest distance from peaks to all points 3 dB below = 7.9 mm

 Ratio of SAR at M2 to SAR at M1 = 55.2%

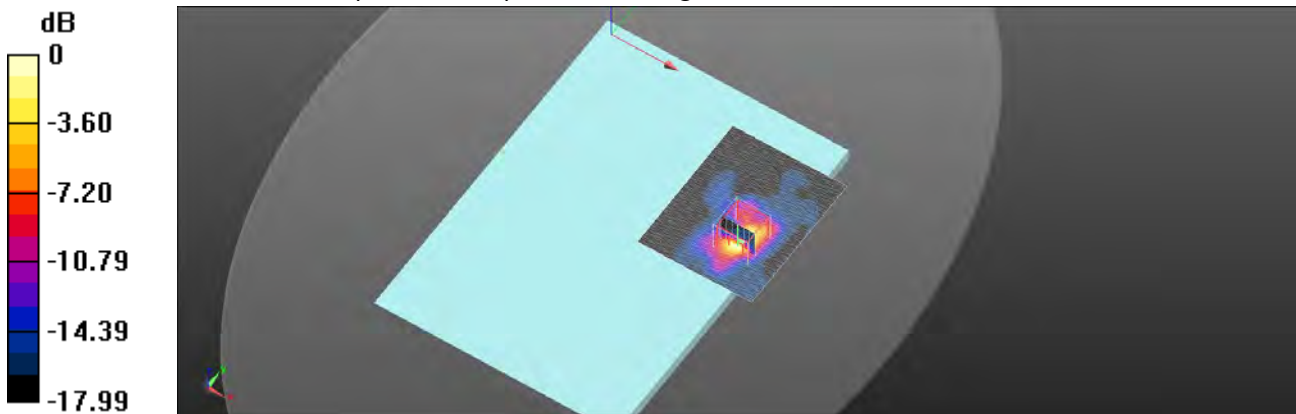
 Maximum value of SAR (measured) = 1.88 W/kg

 $0 \text{ dB} = 1.88 \text{ W/kg} = 2.73 \text{ dBW/kg}$

Unless otherwise stated the results shown in this test report refer only to the sample(s) tested and such sample(s) are retained for 90 days only.

除非另有說明，此報告結果僅對測試之樣品負責，同時此樣品僅保留90天。本報告未經本公司書面許可，不可部份複製。

 This document is issued by the Company subject to its General Conditions of Service printed overleaf, available on request or accessible at <http://www.sgs.com.tw/Terms-and-Conditions> and for electronic format documents, subject to Terms and Conditions for Electronic Documents at <http://www.sgs.com.tw/Terms-and-Conditions>. Attention is drawn to the limitation of liability, indemnification and jurisdiction issues defined therein. Any holder of this document is advised that information contained hereon reflects the Company's findings at the time of its intervention only and within the limits of Client's instructions, if any. The Company's sole responsibility is to its Client and this document does not exonerate parties to a transaction from exercising all their rights and obligations under the transaction documents. This document cannot be reproduced except in full, without prior written approval of the Company. Any unauthorized alteration, forgery or falsification of the content or appearance of this document is unlawful and offenders may be prosecuted to the fullest extent of the law.

Date: 2020/5/24

Report No. : E5/2020/40009

WLAN 802.11ac(80M) 5.6G_Body_Back side_CH 138_0mm_WIFI_BT

Communication System: WLAN; Frequency: 5690 MHz; Duty Cycle: 1:0.988

Medium parameters used: $f = 5690$ MHz; $\sigma = 5.123$ S/m; $\epsilon_r = 35.132$; $\rho = 1000$ kg/m³

Phantom section: Flat Section

Ambient temperature: 22.2°C; Liquid temperature: 21.9°C

DASY5 Configuration:

- Probe: EX3DV4 - SN3665; ConvF(4.99, 4.99, 4.99); Calibrated: 2019/8/30
- Sensor-Surface: 2mm (Mechanical Surface Detection)
- Electronics: DAE4 Sn547; Calibrated: 2020/3/17
- Phantom: ELI
- DASY52 52.10.3(1513); SEMCAD X 14.6.13(7474)

Area Scan (81x101x1): Interpolated grid: dx=10 mm, dy=10 mm

Maximum value of SAR (interpolated) = 0.961 W/kg

Zoom Scan (7x7x12)/Cube 0: Measurement grid: dx=4mm, dy=4mm, dz=2mm

Reference Value = 2.351 V/m; Power Drift = -0.01 dB

Peak SAR (extrapolated) = 3.08 W/kg

SAR(1 g) = 0.370 W/kg; SAR(10 g) = 0.096 W/kg

Smallest distance from peaks to all points 3 dB below = 7.6 mm

Ratio of SAR at M2 to SAR at M1 = 49.7%

Maximum value of SAR (measured) = 0.855 W/kg

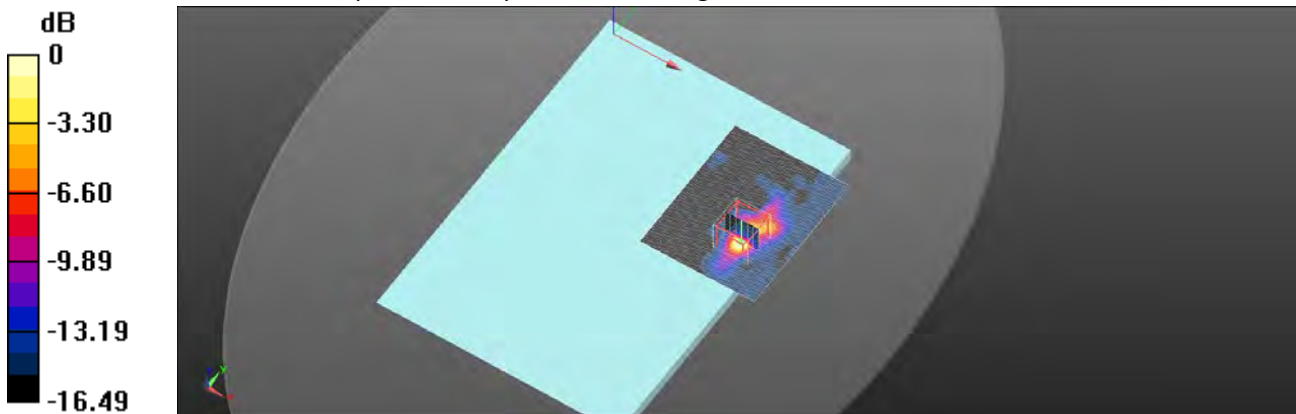

0 dB = 0.855 W/kg = -0.68 dBW/kg

Unless otherwise stated the results shown in this test report refer only to the sample(s) tested and such sample(s) are retained for 90 days only.

除非另有說明，此報告結果僅對測試之樣品負責，同時此樣品僅保留90天。本報告未經本公司書面許可，不可部份複製。

This document is issued by the Company subject to its General Conditions of Service printed overleaf, available on request or accessible at <http://www.sgs.com.tw/Terms-and-Conditions> and for electronic format documents, subject to Terms and Conditions for Electronic Documents at <http://www.sgs.com.tw/Terms-and-Conditions>. Attention is drawn to the limitation of liability, indemnification and jurisdiction issues defined therein. Any holder of this document is advised that information contained hereon reflects the Company's findings at the time of its intervention only and within the limits of Client's instructions, if any. The Company's sole responsibility is to its Client and this document does not exonerate parties to a transaction from exercising all their rights and obligations under the transaction documents. This document cannot be reproduced except in full, without prior written approval of the Company. Any unauthorized alteration, forgery or falsification of the content or appearance of this document is unlawful and offenders may be prosecuted to the fullest extent of the law.

SGS Taiwan Ltd.

No.134,Wu Kung Road, New Taipei Industrial Park, Wuku District, New Taipei City, Taiwan/新北市五股區新北產業園區五工路 134 號

台灣檢驗科技股份有限公司

t (886-2) 2299-3279

f (886-2) 2298-0488

www.sgs.com.tw

Member of SGS Group

6. SAR System Performance Verification

Date: 2020/5/20

Report No. : E5/2020/40009
Dipole 835 MHz_SN:4d063

Communication System: CW; Frequency: 835 MHz; Duty Cycle: 1:1

 Medium parameters used: $f = 835 \text{ MHz}$; $\sigma = 0.892 \text{ S/m}$; $\epsilon_r = 41.183$; $\rho = 1000 \text{ kg/m}^3$

Phantom section: Flat Section

 Ambient temperature: 22.3°C ; Liquid temperature: 21.6°C

DASY5 Configuration:

- Probe: EX3DV4 - SN3665; ConvF(9.47, 9.47, 9.47); Calibrated: 2019/8/30
- Sensor-Surface: 2mm (Mechanical Surface Detection)
- Electronics: DAE4 Sn547; Calibrated: 2020/3/17
- Phantom: ELI
- DASY52 52.10.3(1513); SEMCAD X 14.6.13(7474)

Area Scan (51x71x1): Interpolated grid: $dx=15 \text{ mm}$, $dy=15 \text{ mm}$

 Maximum value of SAR (interpolated) = 3.04 W/kg
Zoom Scan (7x7x7)/Cube 0: Measurement grid: $dx=5\text{mm}$, $dy=5\text{mm}$, $dz=5\text{mm}$

 Reference Value = 57.89 V/m ; Power Drift = 0.01 dB

 Peak SAR (extrapolated) = 3.64 W/kg
SAR(1 g) = 2.44 W/kg ; SAR(10 g) = 1.6 W/kg

 Smallest distance from peaks to all points 3 dB below = 8.8 mm

 Ratio of SAR at M2 to SAR at M1 = 66.8%

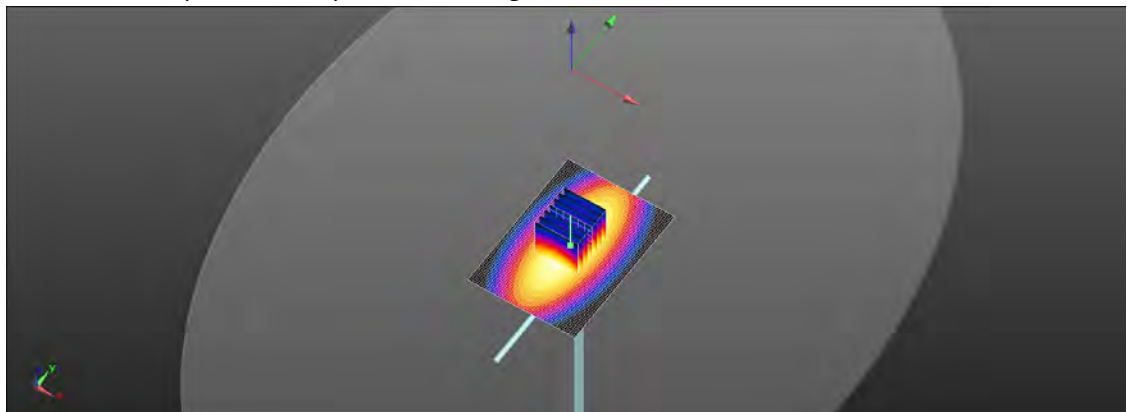
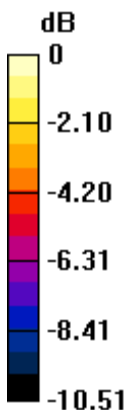
 Maximum value of SAR (measured) = 3.10 W/kg

 $0 \text{ dB} = 3.10 \text{ W/kg} = 4.91 \text{ dBW/kg}$

Unless otherwise stated the results shown in this test report refer only to the sample(s) tested and such sample(s) are retained for 90 days only.

除非另有說明，此報告結果僅對測試之樣品負責，同時此樣品僅保留90天。本報告未經本公司書面許可，不可部份複製。

This document is issued by the Company subject to its General Conditions of Service printed overleaf, available on request or accessible at <http://www.sgs.com.tw/Terms-and-Conditions> and for electronic format documents, subject to Terms and Conditions for Electronic Documents at <http://www.sgs.com.tw/Terms-and-Conditions>. Attention is drawn to the limitation of liability, indemnification and jurisdiction issues defined therein. Any holder of this document is advised that information contained hereon reflects the Company's findings at the time of its intervention only and within the limits of Client's instructions, if any. The Company's sole responsibility is to its Client and this document does not exonerate parties to a transaction from exercising all their rights and obligations under the transaction documents. This document cannot be reproduced except in full, without prior written approval of the Company. Any unauthorized alteration, forgery or falsification of the content or appearance of this document is unlawful and offenders may be prosecuted to the fullest extent of the law.

SGS Taiwan Ltd.

No.134,Wu Kung Road, New Taipei Industrial Park, Wuku District, New Taipei City, Taiwan/新北市五股區新北產業園區五工路 134 號

台灣檢驗科技股份有限公司

t (886-2) 2299-3279

f (886-2) 2298-0488

www.sgs.com.tw

Member of SGS Group

Date: 2020/6/4

Report No. : E5/2020/40009
Dipole 2450 MHz_SN:727

Communication System: CW; Frequency: 2450 MHz; Duty Cycle: 1:1

 Medium parameters used: $f = 2450$ MHz; $\sigma = 1.781$ S/m; $\epsilon_r = 38.788$; $\rho = 1000$ kg/m³

Phantom section: Flat Section

Ambient temperature: 22.1°C; Liquid temperature: 21.7°C

DASY5 Configuration:

- Probe: EX3DV4 - SN3665; ConvF(7.36, 7.36, 7.36); Calibrated: 2019/8/3
- Sensor-Surface: 2mm (Mechanical Surface Detection)
- Electronics: DAE4 Sn547; Calibrated: 2020/3/17
- Phantom: ELI
- DASY52 52.10.3(1513); SEMCAD X 14.6.13(7474)

Area Scan (71x91x1): Interpolated grid: dx=12 mm, dy=12 mm

Maximum value of SAR (interpolated) = 21.1 W/kg

Zoom Scan (7x7x7)/Cube 0: Measurement grid: dx=5mm, dy=5mm, dz=5mm

Reference Value = 107.2 V/m; Power Drift = -0.02 dB

Peak SAR (extrapolated) = 29.4 W/kg

SAR(1 g) = 13.3 W/kg; SAR(10 g) = 6.14 W/kg

Smallest distance from peaks to all points 3 dB below = 9.5 mm

Ratio of SAR at M2 to SAR at M1 = 43.6%

Maximum value of SAR (measured) = 20.7 W/kg

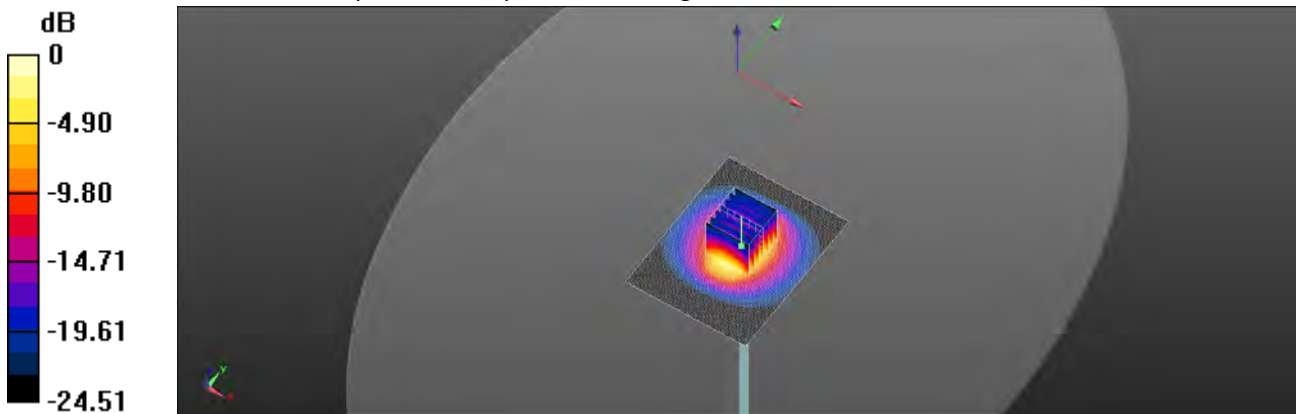

0 dB = 20.7 W/kg = 13.16 dBW/kg

Unless otherwise stated the results shown in this test report refer only to the sample(s) tested and such sample(s) are retained for 90 days only.

除非另有說明，此報告結果僅對測試之樣品負責，同時此樣品僅保留90天。本報告未經本公司書面許可，不可部份複製。

 This document is issued by the Company subject to its General Conditions of Service printed overleaf, available on request or accessible at <http://www.sgs.com.tw/Terms-and-Conditions> and for electronic format documents, subject to Terms and Conditions for Electronic Documents at <http://www.sgs.com.tw/Terms-and-Conditions>. Attention is drawn to the limitation of liability, indemnification and jurisdiction issues defined therein. Any holder of this document is advised that information contained hereon reflects the Company's findings at the time of its intervention only and within the limits of Client's instructions, if any. The Company's sole responsibility is to its Client and this document does not exonerate parties to a transaction from exercising all their rights and obligations under the transaction documents. This document cannot be reproduced except in full, without prior written approval of the Company. Any unauthorized alteration, forgery or falsification of the content or appearance of this document is unlawful and offenders may be prosecuted to the fullest extent of the law.

Date: 2020/6/5

Report No. : E5/2020/40009

Dipole 5200 MHz_SN:1023

Communication System: CW; Frequency: 5200 MHz; Duty Cycle: 1:1

Medium parameters used: $f = 5200$ MHz; $\sigma = 4.623$ S/m; $\epsilon_r = 35.698$; $\rho = 1000$ kg/m³

Phantom section: Flat Section

Ambient temperature: 22.1°C; Liquid temperature: 21.8°C

DASY5 Configuration:

- Probe: EX3DV4 - SN3665; ConvF(5.28, 5.28, 5.28); Calibrated: 2019/8/30
- Sensor-Surface: 2mm (Mechanical Surface Detection)
- Electronics: DAE4 Sn547; Calibrated: 2020/3/17
- Phantom: ELI
- DASY52 52.10.3(1513); SEMCAD X 14.6.13(7474)

Area Scan (61x81x1): Interpolated grid: dx=10 mm, dy=10 mm

Maximum value of SAR (interpolated) = 18.7 W/kg

Zoom Scan (7x7x12)/Cube 0: Measurement grid: dx=4mm, dy=4mm, dz=2mm

Reference Value = 62.01 V/m; Power Drift = 0.02 dB

Peak SAR (extrapolated) = 37.8 W/kg

SAR(1 g) = 8.13 W/kg; SAR(10 g) = 2.31 W/kg

Smallest distance from peaks to all points 3 dB below = 7.4 mm

Ratio of SAR at M2 to SAR at M1 = 50.9%

Maximum value of SAR (measured) = 17.8 W/kg

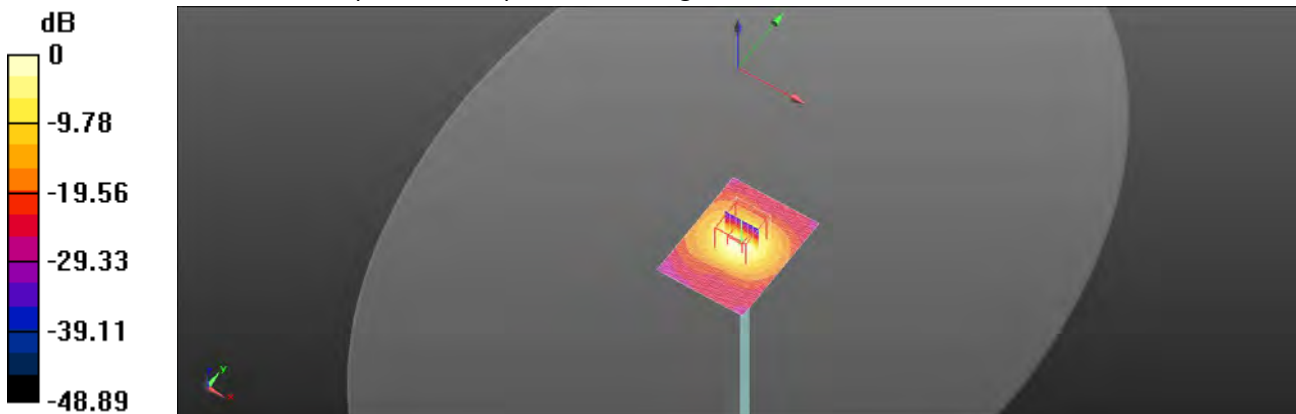

0 dB = 17.8 W/kg = 12.51 dBW/kg

Unless otherwise stated the results shown in this test report refer only to the sample(s) tested and such sample(s) are retained for 90 days only.

除非另有說明，此報告結果僅對測試之樣品負責，同時此樣品僅保留90天。本報告未經本公司書面許可，不可部份複製。

This document is issued by the Company subject to its General Conditions of Service printed overleaf, available on request or accessible at <http://www.sgs.com.tw/Terms-and-Conditions> and for electronic format documents, subject to Terms and Conditions for Electronic Documents at <http://www.sgs.com.tw/Terms-and-Conditions>. Attention is drawn to the limitation of liability, indemnification and jurisdiction issues defined therein. Any holder of this document is advised that information contained hereon reflects the Company's findings at the time of its intervention only and within the limits of Client's instructions, if any. The Company's sole responsibility is to its Client and this document does not exonerate parties to a transaction from exercising all their rights and obligations under the transaction documents. This document cannot be reproduced except in full, without prior written approval of the Company. Any unauthorized alteration, forgery or falsification of the content or appearance of this document is unlawful and offenders may be prosecuted to the fullest extent of the law.

SGS Taiwan Ltd.

No.134,Wu Kung Road, New Taipei Industrial Park, Wuku District, New Taipei City, Taiwan/新北市五股區新北產業園區五工路 134 號

台灣檢驗科技股份有限公司

t (886-2) 2299-3279

f (886-2) 2298-0488

www.sgs.com.tw

Member of SGS Group

Date: 2020/6/6

Report No. : E5/2020/40009

Dipole 5300 MHz_SN:1023

Communication System: CW; Frequency: 5300 MHz; Duty Cycle: 1:1

Medium parameters used: $f = 5300 \text{ MHz}$; $\sigma = 4.727 \text{ S/m}$; $\epsilon_r = 35.581$; $\rho = 1000 \text{ kg/m}^3$

Phantom section: Flat Section

Ambient temperature: 22.4°C; Liquid temperature: 21.7°C

DASY5 Configuration:

- Probe: EX3DV4 - SN3665; ConvF(5.18, 5.18, 5.18); Calibrated: 2019/8/30
- Sensor-Surface: 2mm (Mechanical Surface Detection)
- Electronics: DAE4 Sn547; Calibrated: 2020/3/17
- Phantom: ELI
- DASY52 52.10.3(1513); SEMCAD X 14.6.13(7474)

Area Scan (61x81x1): Interpolated grid: $dx=10 \text{ mm}$, $dy=10 \text{ mm}$

Maximum value of SAR (interpolated) = 18.6 W/kg

Zoom Scan (7x7x12)/Cube 0: Measurement grid: $dx=4\text{mm}$, $dy=4\text{mm}$, $dz=2\text{mm}$

Reference Value = 56.87 V/m; Power Drift = 0.02 dB

Peak SAR (extrapolated) = 37.0 W/kg

SAR(1 g) = 8.25 W/kg; SAR(10 g) = 2.31 W/kg

Smallest distance from peaks to all points 3 dB below = 8.5 mm

Ratio of SAR at M2 to SAR at M1 = 50.4%

Maximum value of SAR (measured) = 17.3 W/kg

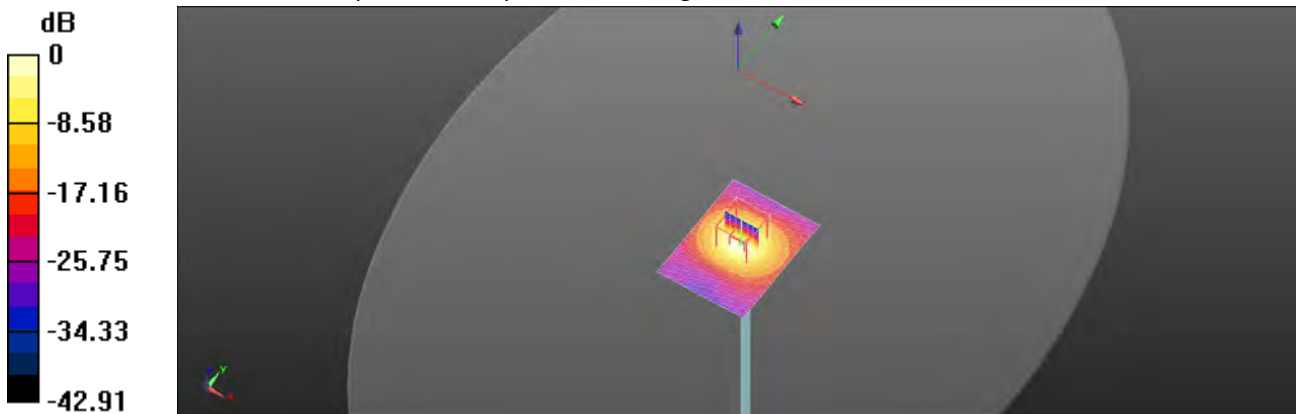

0 dB = 17.3 W/kg = 12.37 dBW/kg

Unless otherwise stated the results shown in this test report refer only to the sample(s) tested and such sample(s) are retained for 90 days only.

除非另有說明，此報告結果僅對測試之樣品負責，同時此樣品僅保留90天。本報告未經本公司書面許可，不可部份複製。

This document is issued by the Company subject to its General Conditions of Service printed overleaf, available on request or accessible at <http://www.sgs.com.tw/Terms-and-Conditions> and for electronic format documents, subject to Terms and Conditions for Electronic Documents at <http://www.sgs.com.tw/Terms-and-Conditions>. Attention is drawn to the limitation of liability, indemnification and jurisdiction issues defined therein. Any holder of this document is advised that information contained hereon reflects the Company's findings at the time of its intervention only and within the limits of Client's instructions, if any. The Company's sole responsibility is to its Client and this document does not exonerate parties to a transaction from exercising all their rights and obligations under the transaction documents. This document cannot be reproduced except in full, without prior written approval of the Company. Any unauthorized alteration, forgery or falsification of the content or appearance of this document is unlawful and offenders may be prosecuted to the fullest extent of the law.

Date: 2020/5/24

Report No. : E5/2020/40009

Dipole 5600 MHz_SN:1023

Communication System: CW; Frequency: 5600 MHz; Duty Cycle: 1:1

Medium parameters used: $f = 5600$ MHz; $\sigma = 5.028$ S/m; $\epsilon_r = 35.255$; $\rho = 1000$ kg/m³

Phantom section: Flat Section

Ambient temperature: 22.2°C; Liquid temperature: 21.9°C

DASY5 Configuration:

- Probe: EX3DV4 - SN3665; ConvF(4.99, 4.99, 4.99); Calibrated: 2019/8/30
- Sensor-Surface: 2mm (Mechanical Surface Detection)
- Electronics: DAE4 Sn547; Calibrated: 2020/3/17
- Phantom: ELI
- DASY52 52.10.3(1513); SEMCAD X 14.6.13(7474)

Area Scan (61x81x1): Interpolated grid: dx=10 mm, dy=10 mm

Maximum value of SAR (interpolated) = 20.1 W/kg

Zoom Scan (7x7x12)/Cube 0: Measurement grid: dx=4mm, dy=4mm, dz=2mm

Reference Value = 56.16 V/m; Power Drift = -0.03 dB

Peak SAR (extrapolated) = 41.6 W/kg

SAR(1 g) = 8.42 W/kg; SAR(10 g) = 2.34 W/kg

Smallest distance from peaks to all points 3 dB below = 7.1 mm

Ratio of SAR at M2 to SAR at M1 = 47.7%

Maximum value of SAR (measured) = 18.2 W/kg

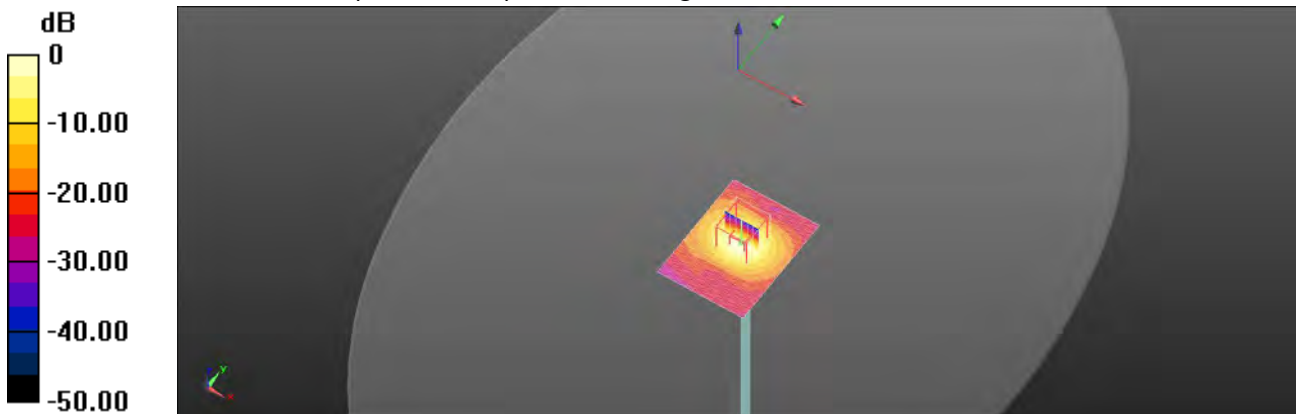

0 dB = 18.2 W/kg = 12.61 dBW/kg

Unless otherwise stated the results shown in this test report refer only to the sample(s) tested and such sample(s) are retained for 90 days only.

除非另有說明，此報告結果僅對測試之樣品負責，同時此樣品僅保留90天。本報告未經本公司書面許可，不可部份複製。

This document is issued by the Company subject to its General Conditions of Service printed overleaf, available on request or accessible at <http://www.sgs.com.tw/Terms-and-Conditions> and for electronic format documents, subject to Terms and Conditions for Electronic Documents at <http://www.sgs.com.tw/Terms-and-Conditions>. Attention is drawn to the limitation of liability, indemnification and jurisdiction issues defined therein. Any holder of this document is advised that information contained hereon reflects the Company's findings at the time of its intervention only and within the limits of Client's instructions, if any. The Company's sole responsibility is to its Client and this document does not exonerate parties to a transaction from exercising all their rights and obligations under the transaction documents. This document cannot be reproduced except in full, without prior written approval of the Company. Any unauthorized alteration, forgery or falsification of the content or appearance of this document is unlawful and offenders may be prosecuted to the fullest extent of the law.

SGS Taiwan Ltd.

No.134,Wu Kung Road, New Taipei Industrial Park, Wuku District, New Taipei City, Taiwan/新北市五股區新北產業園區五工路 134 號

台灣檢驗科技股份有限公司

t (886-2) 2299-3279

f (886-2) 2298-0488

www.sgs.com.tw

Member of SGS Group

7. Uncertainty Budget

Measurement Uncertainty evaluation template for DUT SAR test (3-6G)

A	c	D	e		f	g	h=c * f / e	i=c * g / e	k
Source of Uncertainty	Tolerance/ Uncertainty	Probability Distributio	Div	Div Value	ci (1g)	ci (10g)	Standard uncertainty	Standard uncertainty	vi, or Veff
Measurement system									
Probe calibration	6.55%	N	1	1	1	1	6.55%	6.55%	∞
<i>Isotropy, Axial</i>	3.50%	R	√3	1.732	1	1	2.02%	2.02%	∞
<i>Isotropy, Hemispherical</i>	9.60%	R	√3	1.732	1	1	5.54%	5.54%	∞
Modulation Response	2.40%	R	√3	1.732	1	1	1.40%	1.40%	∞
Boundary Effect	1.00%	R	√3	1.732	1	1	0.58%	0.58%	∞
Linearity	4.70%	R	√3	1.732	1	1	2.71%	2.71%	∞
Detection Limits	1.00%	R	√3	1.732	1	1	0.58%	0.58%	∞
Readout Electronics	0.30%	N	1	1	1	1	0.30%	0.30%	∞
Response time	0.80%	R	√3	1.732	1	1	0.46%	0.46%	∞
Integration Time	2.60%	R	√3	1.732	1	1	1.50%	1.50%	∞
Measurement drift (class A evaluation)									
RF ambient condition - noise	3.00%	R	√3	1.732	1	1	1.73%	1.73%	∞
RF ambient conditions - reflections	3.00%	R	√3	1.732	1	1	1.73%	1.73%	∞
Probe positioner Mechanical restrictions	0.40%	R	√3	1.732	1	1	0.23%	0.23%	∞
Probe Positioning with respect to phantom shell	2.90%	R	√3	1.732	1	1	1.67%	1.67%	∞
Post-processing	1.00%	R	√3	1.732	1	1	0.58%	0.58%	∞
Max SAR Eval	1.00%	R	√3	1.732	1	1	0.58%	0.58%	∞
Test Sample related									
Test sample positioning	2.90%	N	1	1	1	1	2.90%	2.90%	M-1
Device Holder Uncertainty	3.60%	N	1	1	1	1	3.60%	3.60%	M-1
Drift of output power	5.00%	R	√3	1.732	1	1	2.89%	2.89%	∞
Phantom and Setup									
Phantom Uncertainty	4.00%	R	√3	1.732	1	1	2.31%	2.31%	∞
Liquid permittivity (mea.)	0.84%	N	1	1	0.64	0.43	0.54%	0.36%	M
Liquid Conductivity (mea.)	0.74%	N	1	1	0.6	0.49	0.44%	0.36%	M
Combined standard uncertainty		RSS					11.74%	11.72%	
Expant uncertainty (95% confidence interval), K=2							23.47%	23.44%	

Unless otherwise stated the results shown in this test report refer only to the sample(s) tested and such sample(s) are retained for 90 days only.

除非另有說明，此報告結果僅對測試之樣品負責，同時此樣品僅保留90天。本報告未經本公司書面許可，不可部份複製。

This document is issued by the Company subject to its General Conditions of Service printed overleaf, available on request or accessible at <http://www.sgs.com.tw/Terms-and-Conditions> and for electronic format documents, subject to Terms and Conditions for Electronic Documents at <http://www.sgs.com.tw/Terms-and-Conditions>. Attention is drawn to the limitation of liability, indemnification and jurisdiction issues defined therein. Any holder of this document is advised that information contained hereon reflects the Company's findings at the time of its intervention only and within the limits of Client's instructions, if any. The Company's sole responsibility is to its Client and this document does not exonerate parties to a transaction from exercising all their rights and obligations under the transaction documents. This document cannot be reproduced except in full, without prior written approval of the Company. Any unauthorized alteration, forgery or falsification of the content or appearance of this document is unlawful and offenders may be prosecuted to the fullest extent of the law.

Measurement Uncertainty evaluation template for DUT SAR test (0.3-3G)

A	c	D	e		f	g	h=c * f / e	i=c * g / e	k
Source of Uncertainty	Tolerance/ Uncertainty	Probability Distributio	Div	Div Value	ci (1g)	ci (10g)	Standard uncertainty	Standard uncertainty	vi, or Veff
Measurement system									
Probe calibration	6.00%	N	1	1	1	1	6.00%	6.00%	∞
<i>Isotropy, Axial</i>	3.50%	R	√3	1.732	1	1	2.02%	2.02%	∞
<i>Isotropy, Hemispherical</i>	9.60%	R	√3	1.732	1	1	5.54%	5.54%	∞
Modulation Response	2.40%	R	√3	1.732	1	1	1.40%	1.40%	∞
Boundary Effect	1.00%	R	√3	1.732	1	1	0.58%	0.58%	∞
Linearity	4.70%	R	√3	1.732	1	1	2.71%	2.71%	∞
Detection Limits	1.00%	R	√3	1.732	1	1	0.58%	0.58%	∞
Readout Electronics	0.30%	N	1	1	1	1	0.30%	0.30%	∞
Response time	0.80%	R	√3	1.732	1	1	0.46%	0.46%	∞
Integration Time	2.60%	R	√3	1.732	1	1	1.50%	1.50%	∞
Measurement drift (class A evaluation)	1.75%	R	√3	1.732	1	1	1.01%	1.01%	∞
RF ambient condition - noise	3.00%	R	√3	1.732	1	1	1.73%	1.73%	∞
RF ambient conditions - reflections	3.00%	R	√3	1.732	1	1	1.73%	1.73%	∞
Probe positioner Mechanical restrictions	0.40%	R	√3	1.732	1	1	0.23%	0.23%	∞
Probe Positioning with respect to phantom shell	2.90%	R	√3	1.732	1	1	1.67%	1.67%	∞
Post-processing	1.00%	R	√3	1.732	1	1	0.58%	0.58%	∞
Max SAR Eval	1.00%	R	√3	1.732	1	1	0.58%	0.58%	∞
Test Sample related									
Test sample positioning	2.90%	N	1	1	1	1	2.90%	2.90%	M-1
Device Holder Uncertainty	3.60%	N	1	1	1	1	3.60%	3.60%	M-1
Drift of output power	5.00%	R	√3	1.732	1	1	2.89%	2.89%	∞
Phantom and Setup									
Phantom Uncertainty	4.00%	R	√3	1.732	1	1	2.31%	2.31%	∞
Liquid permittivity (mea.)	1.05%	N	1	1	0.64	0.43	0.67%	0.45%	M
Liquid Conductivity (mea.)	1.14%	N	1	1	0.6	0.49	0.68%	0.56%	M
Combined standard uncertainty		RSS					11.46%	11.43%	
Expart uncertainty (95% confidence interval), K=2							22.92%	22.86%	

Unless otherwise stated the results shown in this test report refer only to the sample(s) tested and such sample(s) are retained for 90 days only.

除非另有說明，此報告結果僅對測試之樣品負責，同時此樣品僅保留90天。本報告未經本公司書面許可，不可部份複製。

This document is issued by the Company subject to its General Conditions of Service printed overleaf, available on request or accessible at <http://www.sgs.com.tw/Terms-and-Conditions> and for electronic format documents, subject to Terms and Conditions for Electronic Documents at <http://www.sgs.com.tw/Terms-and-Conditions>. Attention is drawn to the limitation of liability, indemnification and jurisdiction issues defined therein. Any holder of this document is advised that information contained hereon reflects the Company's findings at the time of its intervention only and within the limits of Client's instructions, if any. The Company's sole responsibility is to its Client and this document does not exonerate parties to a transaction from exercising all their rights and obligations under the transaction documents. This document cannot be reproduced except in full, without prior written approval of the Company. Any unauthorized alteration, forgery or falsification of the content or appearance of this document is unlawful and offenders may be prosecuted to the fullest extent of the law.

Appendixes

Refer to separated files for the following appendixes.

E5202040009 SAR_Appendix A Photographs

E5202040009 SAR_Appendix B DAE & Probe Cal. Certificate

E5202040009 SAR_Appendix C Phantom Description & Dipole Cal. Certificate

- End of report -

Unless otherwise stated the results shown in this test report refer only to the sample(s) tested and such sample(s) are retained for 90 days only.
除非另有說明，此報告結果僅對測試之樣品負責，同時此樣品僅保留90天。本報告未經本公司書面許可，不可部份複製。

This document is issued by the Company subject to its General Conditions of Service printed overleaf, available on request or accessible at <http://www.sgs.com.tw/Terms-and-Conditions> and for electronic format documents, subject to Terms and Conditions for Electronic Documents at <http://www.sgs.com.tw/Terms-and-Conditions>. Attention is drawn to the limitation of liability, indemnification and jurisdiction issues defined therein. Any holder of this document is advised that information contained hereon reflects the Company's findings at the time of its intervention only and within the limits of Client's instructions, if any. The Company's sole responsibility is to its Client and this document does not exonerate parties to a transaction from exercising all their rights and obligations under the transaction documents. This document cannot be reproduced except in full, without prior written approval of the Company. Any unauthorized alteration, forgery or falsification of the content or appearance of this document is unlawful and offenders may be prosecuted to the fullest extent of the law.