



FCC CERTIFICATION REPORT

Test Report No. : MH/2019/A0148
Applicant : Sharp Corporation, Mobile Communication B.U.
Address : 2-13-1, Hachihonmatsu-lida, Higashi-hiroshima-shi, Hiroshima, 739-0192, Japan
Manufacturer : Sharp Corporation
Address : 1 Takumi-cho, Sakai-ku, Sakai City, Osaka 590-8522, Japan

Equipment Under Test (EUT) :
Product Name : Smart phone

Standards : FCC Part 15, Subpart B, Class B
FCC Designation Numbers : 916890 / TW1087

Date of Receipt : Oct. 31, 2019
Date of Test : Nov. 09 ~ 20, 2019
Date of Issue : Nov. 27, 2019

Test Result :	PASS
----------------------	-------------

In the configuration tested, the EUT complied with the standards specified above.

Remarks :

This report details the results of the testing carried out on one sample, the results contained in this test report do not relate to other samples of the same product. The manufacturer should ensure that all products in series production are in conformity with the product sample detailed in this report.

The conformity assessment statement in this report is based solely on the test results, measurement uncertainty is excluded.

This report may only be reproduced and distributed in full. If the product in this report is used in any configuration other than that detailed in the report, the manufacturer must ensure the new system complies with all relevant standards. Any mention of SGS Taiwan Electronics & Communication Laboratory or testing done by SGS Taiwan Electronics & Communication Laboratory in connection with distribution or use of the product described in this report must be approved by SGS Taiwan Electronics & Communication Laboratory in writing.

Tested By:

Jeffrey Chou

Date

Nov. 27, 2019

Jeffrey Chou (Engineer)

Approved By

Eddy Cheng

Date

Nov. 27, 2019

Eddy Cheng (Asst. Supervisor)



Unless otherwise stated the results shown in this test report refer only to the sample(s) tested and such sample(s) are retained for 90 days only.

除非另有說明，此報告結果僅對測試之樣品負責，同時此樣品僅保留90天。本報告未經本公司書面許可，不可部份複製。

This document is issued by the Company subject to its General Conditions of Service printed overleaf, available on request or accessible at www.sgs.com/terms_and_conditions.htm and for electronic format documents, subject to Terms and Conditions for Electronic Documents at www.sgs.com/terms_e-document.htm. Attention is drawn to the limitation of liability, indemnification and jurisdiction issues defined therein. Any holder of this document is advised that information contained hereon reflects the Company's findings at the time of its intervention only and within the limits of Client's instructions, if any. The Company's sole responsibility is to its Client and this document does not exonerate parties to a transaction from exercising all their rights and obligations under the transaction documents. This document cannot be reproduced except in full, without prior written approval of the Company. Any unauthorized alteration, forgery or falsification of the content or appearance of this document is unlawful and offenders may be prosecuted to the fullest extent of the law.

SGS Taiwan Ltd.

No.134,Wu Kung Road, New Taipei Industrial Park, Wuku District, New Taipei City, Taiwan 24803/新北市五股區新北產業園區五工路 134 號

台灣檢驗科技股份有限公司

t (886-2) 2299-3279

f (886-2) 2298-0488

www.tw.sgs.com

Member of SGS Group



Revision History

Revision	Description	Issue Date	Remark
00	Original.	Nov. 27, 2019	MH/2019/A0148

Unless otherwise stated the results shown in this test report refer only to the sample(s) tested and such sample(s) are retained for 90 days only.

除非另有說明，此報告結果僅對測試之樣品負責，同時此樣品僅保留90天。本報告未經本公司書面許可，不可部份複製。

This document is issued by the Company subject to its General Conditions of Service printed overleaf, available on request or accessible at www.sgs.com/terms_and_conditions.htm and for electronic format documents, subject to Terms and Conditions for Electronic Documents at www.sgs.com/terms_e-document.htm. Attention is drawn to the limitation of liability, indemnification and jurisdiction issues defined therein. Any holder of this document is advised that information contained hereon reflects the Company's findings at the time of its intervention only and within the limits of Client's instructions, if any. The Company's sole responsibility is to its Client and this document does not exonerate parties to a transaction from exercising all their rights and obligations under the transaction documents. This document cannot be reproduced except in full, without prior written approval of the Company. Any unauthorized alteration, forgery or falsification of the content or appearance of this document is unlawful and offenders may be prosecuted to the fullest extent of the law.

SGS Taiwan Ltd.

No.134,Wu Kung Road, New Taipei Industrial Park, Wuku District, New Taipei City, Taiwan 24803/新北市五股區新北產業園區五工路 134 號

台灣檢驗科技股份有限公司

t (886-2) 2299-3279

f (886-2) 2298-0488

www.tw.sgs.com

Member of SGS Group



Contents

1. GENERAL INFORMATION	4
1.1 APPLICANT & MANUFACTURER INFORMATION	4
1.2 GENERAL DESCRIPTION OF EUT	4
1.3 DETAILS OF EUT	4
1.4 OPERATION PROCEDURE	6
1.5 DESCRIPTION OF SUPPORT UNITS	7
1.6 MODIFICATION LIST.....	7
1.7 ACCESSORIES CABLE LIST	7
1.8 TEST SET-UP CONFIGURATION	8
1.9 MEASUREMENT PROCEDURE.....	9
1.10 STANDARDS APPLICABLE FOR TESTING	9
1.11 SUMMARY OF RESULTS.....	9
2. EMISSION	10
2.1 TEST RESULTS	10
2.2 FREQUENCY RANGE	10
2.3 LIMITS OF CONDUCTED AND RADIATED EMISSION.....	10
2.3.1 LIMITS OF CONDUCTED EMISSION.....	10
2.3.2 LIMITS OF RADIATED EMISSIONS.....	11
2.4. TEST OF CONDUCTED EMISSION	12
2.4.1 TEST EQUIPMENTS	12
2.4.2 OPERATING ENVIRONMENT	12
2.4.3 MEASUREMENT LEVEL CALCULATION.....	12
2.4.4 MEASUREMENT DATA:	13
2.5 TEST OF RADIATED EMISSION	19
2.5.1 TEST EQUIPMENTS	19
2.5.2 OPERATING ENVIRONMENT	21
2.5.3 MEASUREMENT LEVEL CALCULATION.....	21
2.5.4 MEASUREMENT DATA	22
3. PHOTOGRAPHS OF TEST	46

Unless otherwise stated the results shown in this test report refer only to the sample(s) tested and such sample(s) are retained for 90 days only.

除非另有說明，此報告結果僅對測試之樣品負責，同時此樣品僅保留90天。本報告未經本公司書面許可，不可部份複製。

This document is issued by the Company subject to its General Conditions of Service printed overleaf, available on request or accessible at www.sgs.com/terms_and_conditions.htm and for electronic format documents, subject to Terms and Conditions for Electronic Documents at www.sgs.com/terms_e-document.htm. Attention is drawn to the limitation of liability, indemnification and jurisdiction issues defined therein. Any holder of this document is advised that information contained hereon reflects the Company's findings at the time of its intervention only and within the limits of Client's instructions, if any. The Company's sole responsibility is to its Client and this document does not exonerate parties to a transaction from exercising all their rights and obligations under the transaction documents. This document cannot be reproduced except in full, without prior written approval of the Company. Any unauthorized alteration, forgery or falsification of the content or appearance of this document is unlawful and offenders may be prosecuted to the fullest extent of the law.



1. General Information

1.1 Applicant & Manufacturer Information

Applicant : Sharp Corporation, Mobile Communication B.U.
 Address of Applicant : 2-13-1, Hachihonmatsu-lida, Higashi-hiroshima-shi,
 Hiroshima, 739-0192, Japan
 Manufacturer : Sharp Corporation
 Address of Manufacturer : 1 Takumi-cho, Sakai-ku, Sakai City, Osaka 590-
 8522, Japan

1.2 General Description of EUT

Product Name : Smart phone

1.3 Details of EUT

Power Supply : AC 100~240V, 50/60Hz
 Highest operate description : 5850 MHz
 Battery : 3.85V, 3130mAh, 12.05Wh
 Worst case : CE worst case : Config 1
 Below RE worst case : Config 2
 Above RE worst case : Config 1

FCC ID : APYHRO00280	UFS memory	LPDDR4X SDRAM	PCB(MAIN)	PCB(ANT)	(Select which one is worst case)
1st Source	Vendor A	Vendor A	Vendor A	Vendor A	V
2nd Source	Vendor B	Vendor B	Vendor B	Vendor B	Worst case
3rd Source	Vendor A	Vendor C	Vendor A	Vendor B	V

Unless otherwise stated the results shown in this test report refer only to the sample(s) tested and such sample(s) are retained for 90 days only.

除非另有說明，此報告結果僅對測試之樣品負責，同時此樣品僅保留90天。本報告未經本公司書面許可，不可部份複製。

This document is issued by the Company subject to its General Conditions of Service printed overleaf, available on request or accessible at www.sgs.com/terms_and_conditions.htm and for electronic format documents, subject to Terms and Conditions for Electronic Documents at www.sgs.com/terms_e-document.htm. Attention is drawn to the limitation of liability, indemnification and jurisdiction issues defined therein. Any holder of this document is advised that information contained hereon reflects the Company's findings at the time of its intervention only and within the limits of Client's instructions, if any. The Company's sole responsibility is to its Client and this document does not exonerate parties to a transaction from exercising all their rights and obligations under the transaction documents. This document cannot be reproduced except in full, without prior written approval of the Company. Any unauthorized alteration, forgery or falsification of the content or appearance of this document is unlawful and offenders may be prosecuted to the fullest extent of the law.



Accessories List: AC Charger : DVE/DSA-10PF06-05 FUS 050200 Data Cable : KingPower/K201-05130 Conversion Cable : Partron/RUITZA533AFZZ PHF : Ambibio/AB-HI02JS	Config 1	Config 2	Config 3	Config 4
Applicable standard	FCC 15B			
Accessories	EUT + AC Adaptor +USB Cable	EUT +USB Cable	EUT +Conversion Cable +PHF	EUT + AC Adaptor +USB Cable +PHF
Main function	Speech	Data Link	Camera	RX Receive
Additional function	BT+WIFI +GPS+NFC			
Description				
radiated emission	GSM 850, 1900 WCDMA BII, IV, V LTE B02, 04, 05, 07, 12, 13, 17, 38	Data R/W	MP3/ ;REC mode (Front/Back) ;play REC	GSM 850 WCDMA BV LTE B05
conducted emission (DC Power)	NA	NA	NA	NA
conducted emission (AC Power)	GSM 850, 1900 WCDMA BII, IV, V LTE B02, 04, 05, 07, 12, 13, 17, 38	Data R/W	NA	GSM 850 WCDMA BV LTE B05

Unless otherwise stated the results shown in this test report refer only to the sample(s) tested and such sample(s) are retained for 90 days only.

除非另有說明，此報告結果僅對測試之樣品負責，同時此樣品僅保留90天。本報告未經本公司書面許可，不可部份複製。

This document is issued by the Company subject to its General Conditions of Service printed overleaf, available on request or accessible at www.sgs.com/terms_and_conditions.htm and for electronic format documents, subject to Terms and Conditions for Electronic Documents at www.sgs.com/terms_e-document.htm. Attention is drawn to the limitation of liability, indemnification and jurisdiction issues defined therein. Any holder of this document is advised that information contained hereon reflects the Company's findings at the time of its intervention only and within the limits of Client's instructions, if any. The Company's sole responsibility is to its Client and this document does not exonerate parties to a transaction from exercising all their rights and obligations under the transaction documents. This document cannot be reproduced except in full, without prior written approval of the Company. Any unauthorized alteration, forgery or falsification of the content or appearance of this document is unlawful and offenders may be prosecuted to the fullest extent of the law.



1.4 Operation Procedure

Config 1

1. Let EUT install with SIM card, connect to the specified Adapter with USB cable and turn it on.
2. Turn on BT and Link BT Speaker.
3. Turn on Wifi, link to the WiFi-AP with same NB and NB ping EUT IP address.
4. Set up a GPS simulator and execute GPS Test.app.
5. Confirm the NFC function before and after the test.
6. Set up the base station and set the link/idle according to Config.
7. Start testing.

Config 2

1. Let EUT install with SIM card, connect to NB with USB cable and turn it on.
2. Turn on BT and Link BT Speaker.
3. Turn on Wifi, link to the WiFi-AP with same NB and NB ping EUT IP address.
4. Set up a GPS simulator and execute GPS Test.app.
5. Confirm the NFC function before and after the test.
6. NB performs data read/write with EUT according to Config.
7. Start testing.

Config 3

1. Let EUT install with SIM card, connect to Conversion Cable to switch to Earphone and turn it on.
2. Turn on BT and Link BT Speaker.
3. Turn on Wifi, link to the WiFi-AP with same NB and NB ping EUT IP address.
4. Set up a GPS simulator and execute GPS Test.app.
5. Confirm the NFC function before and after the test.
6. Perform Camera (Front/Back) Record / Play REC / MP3 function according to Config.
7. Start testing.

Config 4

1. Let EUT install with SIM card, connect to the specified Adapter with USB cable and turn it on.
2. Turn on BT and Link BT Speaker.
3. Turn on Wifi, link to the WiFi-AP with same NB and NB ping EUT IP address.
4. Set up a GPS simulator and execute GPS Test.app.
5. Confirm the NFC function before and after the test.
6. Set up the base station and set the link according to Config.
7. Start testing.

Unless otherwise stated the results shown in this test report refer only to the sample(s) tested and such sample(s) are retained for 90 days only.

除非另有說明，此報告結果僅對測試之樣品負責，同時此樣品僅保留90天。本報告未經本公司書面許可，不可部份複製。

This document is issued by the Company subject to its General Conditions of Service printed overleaf, available on request or accessible at www.sgs.com/terms_and_conditions.htm and for electronic format documents, subject to Terms and Conditions for Electronic Documents at www.sgs.com/terms_e-document.htm. Attention is drawn to the limitation of liability, indemnification and jurisdiction issues defined therein. Any holder of this document is advised that information contained hereon reflects the Company's findings at the time of its intervention only and within the limits of Client's instructions, if any. The Company's sole responsibility is to its Client and this document does not exonerate parties to a transaction from exercising all their rights and obligations under the transaction documents. This document cannot be reproduced except in full, without prior written approval of the Company. Any unauthorized alteration, forgery or falsification of the content or appearance of this document is unlawful and offenders may be prosecuted to the fullest extent of the law.



1.5 Description of Support Units

PRODUCT	MANUFACTURER	MODEL NO.	SERIAL NO.
SIM Card	R&S	CMW-Z05	8952530076180138474
BT Speaker	Creative	MF8090	YFMF8090245R00855Y
Radio Communication Analyzer	R&S	CMU200	102189
Radio Communication Analyzer	R&S	CMW500	1201.002K50-152303-Zr
AP	BUFFALO	WZR-HP-G300NH2	44066221202559[[G]]
GPS Signal Generator	Spectracom	GSG53 GNSS4	200218
Mouse	Logitech	M-U0026	1738HS05FGU8
Notebook(CE)	HP	ProBook 4440s	2CE3031N4X
Notebook (RE, HRE)	DELL	P56F	59WSJ72
Adapter	DVE	DSA-10PF06-05 FUS 050200	N/A
Earphone	Ambibio	AB-HI02JS	N/A

Support Equipment Used in Tested Cable

Cable Type	Core	Length	Shielding/Non-shielding
USB Cable	N/A	1.8m	Shielding
USB cable	N/A	1m	Shielding
Earphone cable	N/A	1.15m	Non-shielding
USB Conversion Cable	N/A	0.16	Non-shielding

1.6 Modification List

No modification was made by SGS Taiwan Electronics & Communication Laboratory.

1.7 Accessories Cable List

Cable Type	Core	Length	Shielding/Non-shielding
N/A	N/A	N/A	N/A

Unless otherwise stated the results shown in this test report refer only to the sample(s) tested and such sample(s) are retained for 90 days only.

除非另有說明，此報告結果僅對測試之樣品負責，同時此樣品僅保留90天。本報告未經本公司書面許可，不可部份複製。

This document is issued by the Company subject to its General Conditions of Service printed overleaf, available on request or accessible at www.sgs.com/terms_and_conditions.htm and for electronic format documents, subject to Terms and Conditions for Electronic Documents at www.sgs.com/terms_e-document.htm. Attention is drawn to the limitation of liability, indemnification and jurisdiction issues defined therein. Any holder of this document is advised that information contained hereon reflects the Company's findings at the time of its intervention only and within the limits of Client's instructions, if any. The Company's sole responsibility is to its Client and this document does not exonerate parties to a transaction from exercising all their rights and obligations under the transaction documents. This document cannot be reproduced except in full, without prior written approval of the Company. Any unauthorized alteration, forgery or falsification of the content or appearance of this document is unlawful and offenders may be prosecuted to the fullest extent of the law.



1.8 Test Set-Up Configuration

Config 1 & 4

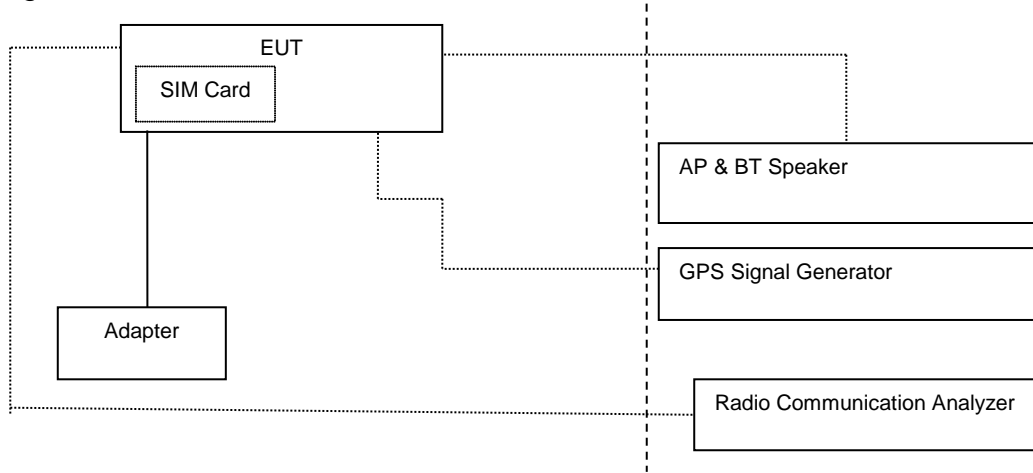

Config 2

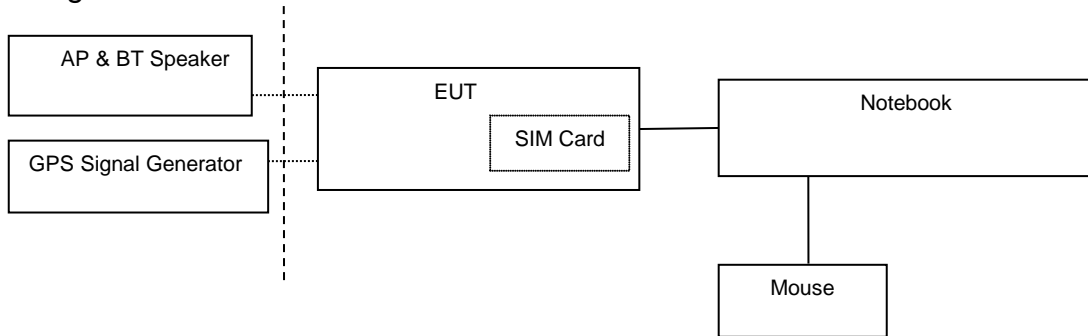

Config 3

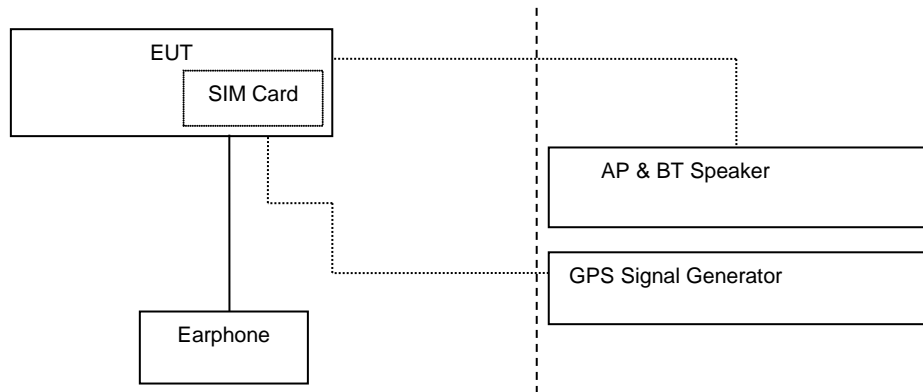

Unless otherwise stated the results shown in this test report refer only to the sample(s) tested and such sample(s) are retained for 90 days only.

除非另有說明，此報告結果僅對測試之樣品負責，同時此樣品僅保留90天。本報告未經本公司書面許可，不可部份複製。

This document is issued by the Company subject to its General Conditions of Service printed overleaf, available on request or accessible at www.sgs.com/terms_and_conditions.htm and for electronic format documents, subject to Terms and Conditions for Electronic Documents at www.sgs.com/terms_e-document.htm. Attention is drawn to the limitation of liability, indemnification and jurisdiction issues defined therein. Any holder of this document is advised that information contained hereon reflects the Company's findings at the time of its intervention only and within the limits of Client's instructions, if any. The Company's sole responsibility is to its Client and this document does not exonerate parties to a transaction from exercising all their rights and obligations under the transaction documents. This document cannot be reproduced except in full, without prior written approval of the Company. Any unauthorized alteration, forgery or falsification of the content or appearance of this document is unlawful and offenders may be prosecuted to the fullest extent of the law.



1.9 Measurement Procedure

Conducted Emission Testing was performed according to ANSI C63.4:2014 in a shielded room with peripherals placed on a table, 0.8m high over a metal floor. It was located more than required distance away from the shielded room wall.

Radiated Emission Testing was performed according to ANSI C63.4:2014 at the 3/10m semi-anechoic chamber. The EUT was placed on a 0.8m high table along with the peripherals. The turn table was placed 10m distance from the antenna. Cables were placed in a position to produce maximum emissions as determined by experimentation, and operation mode was selected for production of maximum emission.

The frequencies and amplitudes of maximum emission were measured at varying azimuths, antenna heights and antenna polarities. Maximum emission levels are then reported.

1.10 Standards Applicable for Testing

Tests to be carried out under FCC Part 15, Subpart B/CISPR 22

Test Standards	Status
FCC Part 15, Subpart B/ CISPR 22	Applicable
Deviation from Standard	No deviation

1.11 Decision Rules of Results

Reported measurement data comply with ANSI C63.4:2014

Determining compliance shall be based on the results of the compliance measurement, not taking into account measurement instrumentation uncertainty.

1.12 Summary of Results

Highest Emission					
Standard	Test Type	Result	Phase/Pol.	Frequency(MHz)	Margin(dB)
FCC Part 15 Subpart B Class B	Conducted Emission	PASS	Line	0.5900	-11.37 (AVG)
			Neutral	1.6220	-18.46 (QP)
	Radiated Emission	PASS	Ver.	167.9800	-6.04 (QP)

1.13 Reporting Statements of Conformity

The conformity statement in this report is based solely on the test results, measurement uncertainty is excluded.

Unless otherwise stated the results shown in this test report refer only to the sample(s) tested and such sample(s) are retained for 90 days only.

除非另有說明，此報告結果僅對測試之樣品負責，同時此樣品僅保留90天。本報告未經本公司書面許可，不可部份複製。

This document is issued by the Company subject to its General Conditions of Service printed overleaf, available on request or accessible at www.sgs.com/terms_and_conditions.htm and for electronic format documents, subject to Terms and Conditions for Electronic Documents at www.sgs.com/terms_e-document.htm. Attention is drawn to the limitation of liability, indemnification and jurisdiction issues defined therein. Any holder of this document is advised that information contained hereon reflects the Company's findings at the time of its intervention only and within the limits of Client's instructions, if any. The Company's sole responsibility is to its Client and this document does not exonerate parties to a transaction from exercising all their rights and obligations under the transaction documents. This document cannot be reproduced except in full, without prior written approval of the Company. Any unauthorized alteration, forgery or falsification of the content or appearance of this document is unlawful and offenders may be prosecuted to the fullest extent of the law.

SGS Taiwan Ltd.

No.134,Wu Kung Road, New Taipei Industrial Park, Wuku District, New Taipei City, Taiwan 24803/新北市五股區新北產業園區五工路 134 號

台灣檢驗科技股份有限公司

t (886-2) 2299-3279

f (886-2) 2298-0488

www.tw.sgs.com

Member of SGS Group



2. EMISSION

2.1 Test Results

	Results
Conducted Emission	Pass
Radiated Emission	Pass

2.2 Frequency Range

FCC Part 15, Subpart B:

Conducted Emission : 150 kHz - 30 MHz

Radiated Emission : See below table

Highest frequency generated or Upper frequency of measurement used in the device or on which the device operates or tunes (MHz) range (MHz)

Below 1.705	30
1.705 - 108	1000
108 - 500	2000
500 - 1000	5000
Above 1000	5th harmonic of the highest frequency or 40 GHz, whichever is lower

2.3 Limits of Conducted and Radiated Emission

2.3.1 Limits of Conducted Emission

FCC Part 15, Subpart B/CISPR 22:

FREQUENCY (MHz)	Class A (dBuV)		Class B (dBuV)	
	Quasi - peak	Average	Quasi - peak	Average
0.15 - 0.5	79	66	66 - 56	56 - 46
0.50 - 5.0	73	60	56	46
5.0 - 30.0	73	60	60	50

Note : (1) The lower limit shall apply at the transition frequencies.

(2) The limit decreases linearly with the logarithm of the frequency in the range 0.15 to 0.50 MHz.

(3) All emanation from a class A/B digital device or system, including any network of conductors and apparatus connected there to, shall not exceed the level of field strengths specified above.

Unless otherwise stated the results shown in this test report refer only to the sample(s) tested and such sample(s) are retained for 90 days only.

除非另有說明，此報告結果僅對測試之樣品負責，同時此樣品僅保留90天。本報告未經本公司書面許可，不可部份複製。

This document is issued by the Company subject to its General Conditions of Service printed overleaf, available on request or accessible at www.sgs.com/terms_and_conditions.htm and for electronic format documents, subject to Terms and Conditions for Electronic Documents at www.sgs.com/terms_e-document.htm. Attention is drawn to the limitation of liability, indemnification and jurisdiction issues defined therein. Any holder of this document is advised that information contained hereon reflects the Company's findings at the time of its intervention only and within the limits of Client's instructions, if any. The Company's sole responsibility is to its Client and this document does not exonerate parties to a transaction from exercising all their rights and obligations under the transaction documents. This document cannot be reproduced except in full, without prior written approval of the Company. Any unauthorized alteration, forgery or falsification of the content or appearance of this document is unlawful and offenders may be prosecuted to the fullest extent of the law.



2.3.2 Limits of Radiated Emissions

FCC Part 15, Subpart B Limit:

- Detector Function : Quasi – Peak

FREQUENCY (MHz)	Class A (at 10m)	Class B (at 3m)
	dBuV/m	dBuV/m
30~88	39	40
88~216	43.5	43.5
216~960	46.44	46
Above 960	49.54	54

- Detector Function : Peak , Average

FREQUENCY (MHz)	Class A (dBuV/m) (at 3m)		Class B (dBuV/m) (at 3m)	
	Peak	Average	Peak	Average
Above 1000	79.3	59.3	73.9	53.9

CISPR 22 Limit:

- Detector Function : Quasi – Peak

FREQUENCY (MHz)	Class A (at 10m)	Class B (at 10m)
	dBuV/m	dBuV/m
30-230	40	30
230-1000	47	37

NOTE 1 The lower limit shall apply at the transition frequency.

NOTE 2 Additional provisions may be required for cases where interference occurs.

FREQUENCY (GHz)	Class A (dBuV/m) (at 3m)		Class B (dBuV/m) (at 3m)	
	Average	Peak	Average	Peak
1~3	56	76	50	70
3~6	60	80	54	74

NOTE The lower limit applies at the transition frequency.

Unless otherwise stated the results shown in this test report refer only to the sample(s) tested and such sample(s) are retained for 90 days only.

除非另有說明，此報告結果僅對測試之樣品負責，同時此樣品僅保留90天。本報告未經本公司書面許可，不可部份複製。

This document is issued by the Company subject to its General Conditions of Service printed overleaf, available on request or accessible at www.sgs.com/terms_and_conditions.htm and for electronic format documents, subject to Terms and Conditions for Electronic Documents at www.sgs.com/terms_e-document.htm. Attention is drawn to the limitation of liability, indemnification and jurisdiction issues defined therein. Any holder of this document is advised that information contained hereon reflects the Company's findings at the time of its intervention only and within the limits of Client's instructions, if any. The Company's sole responsibility is to its Client and this document does not exonerate parties to a transaction from exercising all their rights and obligations under the transaction documents. This document cannot be reproduced except in full, without prior written approval of the Company. Any unauthorized alteration, forgery or falsification of the content or appearance of this document is unlawful and offenders may be prosecuted to the fullest extent of the law.



2.4. Test of Conducted Emission

2.4.1 Test Equipments

SGS Conducted_Emission HWAYA Conducted Room No.A EMC					
EQUIPMENT TYPE	Manufacturer	Model Number	Serial Number	Calibration Date	Calibration Due
EMI Test Receiver	R&S	ESCI 3	101311	2019/7/2	2020/7/1
Coaxial Cables	EMC Instruments Corp	EMCRG58-BM-BM-3000	160812	2019/8/12	2020/8/11
LISN	Schwarzbeck	NSLK 8127	8127-648	2019/7/12	2020/7/11
Pulse Limiter	Narda S.T.S.	PMM PL01	1110X30602	2019/8/12	2020/8/11
LISN	Schwarzbeck	NSLK 8128	NSLK8128-300	2019/9/16	2020/9/15
Communication Tester	R&S	CMU 200	119988	2019/2/22	2020/2/21
Communication Tester	R&S	CMW 500	152303	2019/2/22	2020/2/21
Communication Tester	Anritsu	MT8820C	6201465315	N.C.R.	N.C.R.
Test S/W	Farad	EZ-EMC	Ver. SGS-03A2	N.C.R.	N.C.R.

SGS Taiwan LTD. Electronics & Communication Laboratory
 No.2, Keji 1st Rd., Guishan District, Taoyuan City 33383, Taiwan (R.O.C.)
 Measurement Uncertainty of Conducted Emission
 Expanded uncertainty Ulab(K=2) of conducted emission is 2.25 dB
 Theory values uncertainty Ucispr 16-4-2 :2011+A1_2014 (K=2) of AC mains conducted Emission is 3.44dB

2.4.2 Operating Environment

Temperature : 22 degree C

Humidity : 57 %RH

Atmospheric Pressure : 1017 hpa

2.4.3 Measurement Level Calculation

Factor = LISN insertion loss + Cable loss + Pulse Limiter Insertion Loss

Measurement Level = Reading Level + Factor

Over (Margin) = Measurement Level – Limit

Unless otherwise stated the results shown in this test report refer only to the sample(s) tested and such sample(s) are retained for 90 days only.

除非另有說明，此報告結果僅對測試之樣品負責，同時此樣品僅保留90天。本報告未經本公司書面許可，不可部份複製。

This document is issued by the Company subject to its General Conditions of Service printed overleaf, available on request or accessible at www.sgs.com/terms_and_conditions.htm and for electronic format documents, subject to Terms and Conditions for Electronic Documents at www.sgs.com/terms_e-document.htm. Attention is drawn to the limitation of liability, indemnification and jurisdiction issues defined therein. Any holder of this document is advised that information contained hereon reflects the Company's findings at the time of its intervention only and within the limits of Client's instructions, if any. The Company's sole responsibility is to its Client and this document does not exonerate parties to a transaction from exercising all their rights and obligations under the transaction documents. This document cannot be reproduced except in full, without prior written approval of the Company. Any unauthorized alteration, forgery or falsification of the content or appearance of this document is unlawful and offenders may be prosecuted to the fullest extent of the law.

SGS Taiwan Ltd.

No.134,Wu Kung Road, New Taipei Industrial Park, Wuku District, New Taipei City, Taiwan 24803/新北市五股區新北產業園區五工路 134 號

台灣檢驗科技股份有限公司

t (886-2) 2299-3279

f (886-2) 2298-0488

www.tw.sgs.com

Member of SGS Group



2.4.4 Measurement Data:

Config_1_L

Site: : Conduction Room A	Date: 2019/11/12	Time: 下午 10:46:10
Limit: FCC Class B Conduction(QP)	Phase: L1	Temperature: 22 °C
Mode: Config 1	Power: AC 120V/60Hz	Humidity: 57 %
Report: File :MH-2019-A0148		Air Pressure: 1017 hpa
Tester: Jeffrey Chou		
Note: GSM 850		

SGS Taiwan Ltd.-Electronics & Communication Laboratory Address: No.2, Keji 1st Rd., Guishan District, Taoyuan City, Taiwan 333

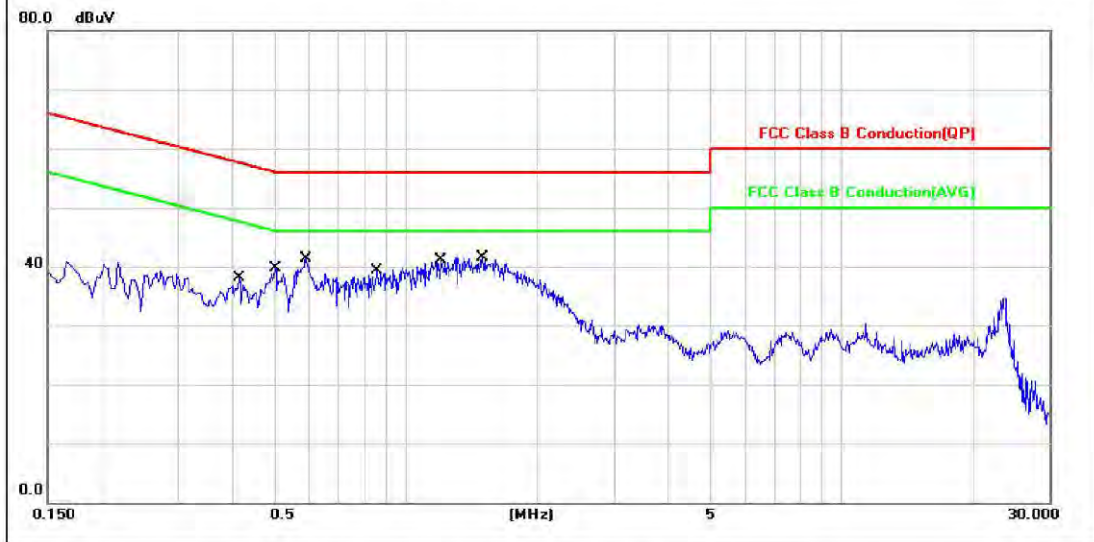

No.	Mk	Freq. (MHz)	Reading (dBuV)	Factor (dB)	Measurement (dBuV)	Limit (dBuV)	Over (dB)	Detector	Comment
1		0.4140	33.28	0.13	33.41	57.57	-24.16	QP	
2		0.4140	20.69	0.13	20.82	47.57	-26.75	AVG	
3		0.5020	35.14	0.13	35.27	56.00	-20.73	QP	
4		0.5020	26.74	0.13	26.87	46.00	-19.13	AVG	
5		0.5900	39.15	0.15	39.30	56.00	-16.70	QP	
6	*	0.5900	34.48	0.15	34.63	46.00	-11.37	AVG	
7		0.8580	34.61	0.21	34.82	56.00	-21.18	QP	
8		0.8580	23.77	0.21	23.98	46.00	-22.02	AVG	
9		1.1980	36.00	0.24	36.24	56.00	-19.76	QP	
10		1.1980	25.31	0.24	25.55	46.00	-20.45	AVG	
11		1.4980	36.43	0.25	36.68	56.00	-19.32	QP	
12		1.4980	26.39	0.25	26.64	46.00	-19.36	AVG	

*:Maximum data x:Over limit l:over margin

Unless otherwise stated the results shown in this test report refer only to the sample(s) tested and such sample(s) are retained for 90 days only.

除非另有說明，此報告結果僅對測試之樣品負責，同時此樣品僅保留90天。本報告未經本公司書面許可，不可部份複製。

This document is issued by the Company subject to its General Conditions of Service printed overleaf, available on request or accessible at www.sgs.com/terms_and_conditions.htm and for electronic format documents, subject to Terms and Conditions for Electronic Documents at www.sgs.com/terms_e-document.htm. Attention is drawn to the limitation of liability, indemnification and jurisdiction issues defined therein. Any holder of this document is advised that information contained hereon reflects the Company's findings at the time of its intervention only and within the limits of Client's instructions, if any. The Company's sole responsibility is to its Client and this document does not exonerate parties to a transaction from exercising all their rights and obligations under the transaction documents. This document cannot be reproduced except in full, without prior written approval of the Company. Any unauthorized alteration, forgery or falsification of the content or appearance of this document is unlawful and offenders may be prosecuted to the fullest extent of the law.



Config_1_N

Site: : Conduction Room A	Date: 2019/11/12	Time: 下午 10:43:23
Limit: FCC Class B Conduction(QP)	Phase: N	Temperature: 22 °C
Mode: Config 1	Power: AC 120V/60Hz	Humidity: 57 %
Report: File :MH-2019-A0148		Air Pressure: 1017 hpa
Tester: Jeffrey Chou		
Note: GSM 850		

SGS Taiwan Ltd.-Electronics & Communication Laboratory Address: No.2, Keji 1st Rd., Guishan District, Taoyuan City, Taiwan 333

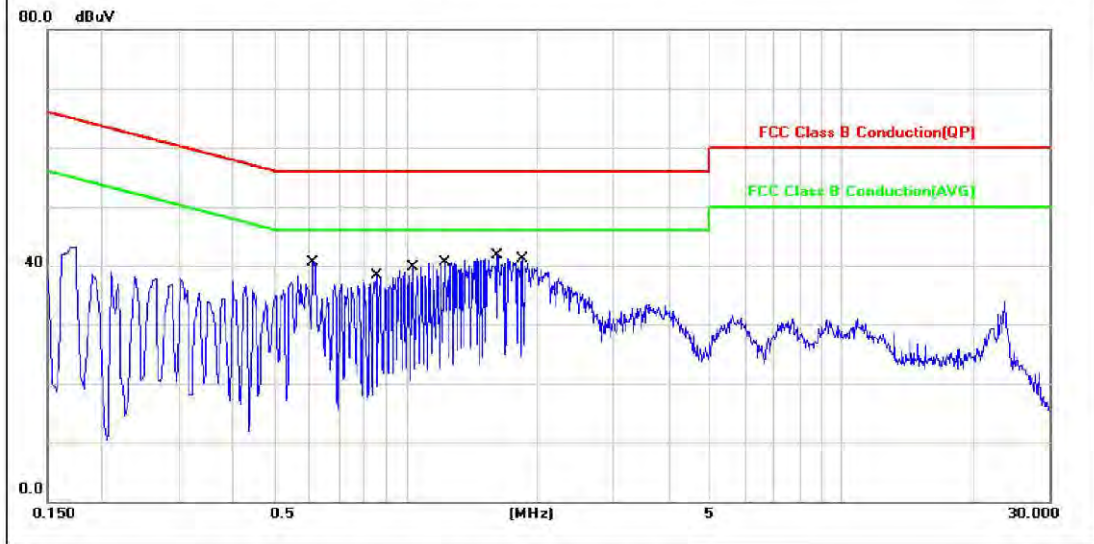

No.	Mk	Freq. (MHz)	Reading (dBuV)	Factor (dB)	Measurement (dBuV)	Limit (dBuV)	Over (dB)	Detector	Comment
1		0.6100	36.22	0.14	36.36	56.00	-19.64	QP	
2		0.6100	26.29	0.14	26.43	46.00	-19.57	AVG	
3		0.8540	34.11	0.20	34.31	56.00	-21.69	QP	
4		0.8540	21.14	0.20	21.34	46.00	-24.66	AVG	
5		1.0420	35.10	0.23	35.33	56.00	-20.67	QP	
6		1.0420	21.90	0.23	22.13	46.00	-23.87	AVG	
7		1.2300	36.24	0.23	36.47	56.00	-19.53	QP	
8		1.2300	23.20	0.23	23.43	46.00	-22.57	AVG	
9	*	1.6220	37.30	0.24	37.54	56.00	-18.46	QP	
10		1.6220	25.30	0.24	25.54	46.00	-20.46	AVG	
11		1.8580	37.03	0.24	37.27	56.00	-18.73	QP	
12		1.8580	24.41	0.24	24.65	46.00	-21.35	AVG	

*:Maximum data x:Over limit l:over margin

Unless otherwise stated the results shown in this test report refer only to the sample(s) tested and such sample(s) are retained for 90 days only.
 除非另有說明，此報告結果僅對測試之樣品負責，同時此樣品僅保留90天。本報告未經本公司書面許可，不可部份複製。
 This document is issued by the Company subject to its General Conditions of Service printed overleaf, available on request or accessible at www.sgs.com/terms_and_conditions.htm and for electronic format documents, subject to Terms and Conditions for Electronic Documents at www.sgs.com/terms_e-document.htm. Attention is drawn to the limitation of liability, indemnification and jurisdiction issues defined therein. Any holder of this document is advised that information contained hereon reflects the Company's findings at the time of its intervention only and within the limits of Client's instructions, if any. The Company's sole responsibility is to its Client and this document does not exonerate parties to a transaction from exercising all their rights and obligations under the transaction documents. This document cannot be reproduced except in full, without prior written approval of the Company. Any unauthorized alteration, forgery or falsification of the content or appearance of this document is unlawful and offenders may be prosecuted to the fullest extent of the law.

Config_2_L

Site: Conduction Room A	Date: 2019/11/12	Time: 下午 06:25:08
Limit: FCC Class B Conduction(QP)	Phase: L1	Temperature: 22 °C
Mode: Config 2	Power: From System	Humidity: 57 %
Report: File :MH-2019-A0148		Air Pressure: 1017 hpa
Tester: Jeffrey Chou		
Note: AC 120V/60Hz , Data Write		

SGS Taiwan Ltd. Electronics & Communication Laboratory Address: No 2, Keji 1st Rd., Guishan District, Taoyuan City, Taiwan 333

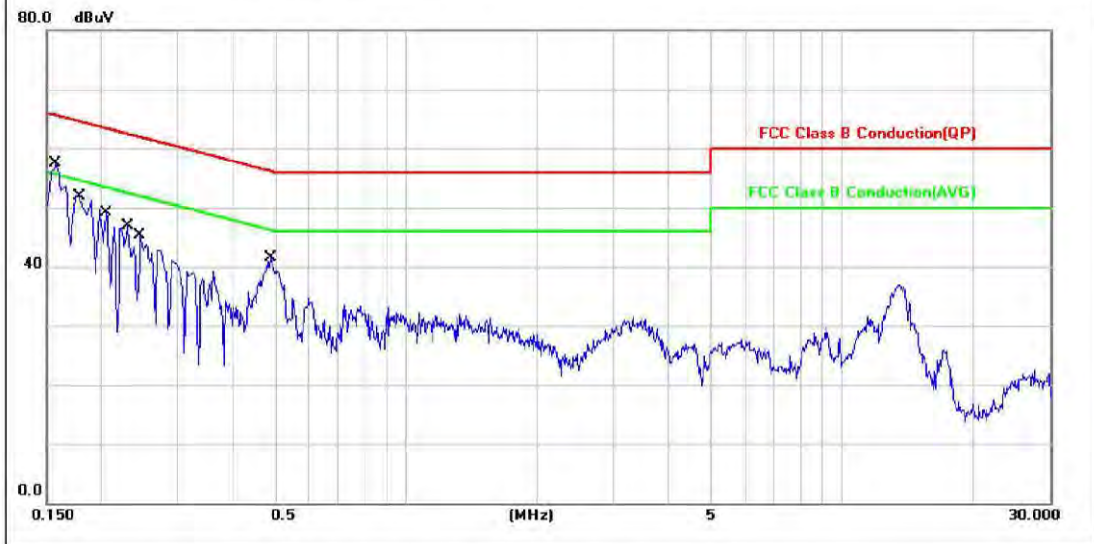

No.	Mk	Freq. (MHz)	Reading (dBuV)	Factor (dB)	Measurement (dBuV)	Limit (dBuV)	Over (dB)	Detector	Comment
1	*	0.1580	50.69	0.05	50.74	65.57	-14.83	QP	
2		0.1580	39.36	0.05	39.41	55.57	-16.16	AVG	
3		0.1780	45.03	0.09	45.12	64.58	-19.46	QP	
4		0.1780	21.03	0.09	21.12	54.58	-33.46	AVG	
5		0.2060	42.59	0.13	42.72	63.37	-20.65	QP	
6		0.2060	28.16	0.13	28.29	53.37	-25.08	AVG	
7		0.2300	39.32	0.13	39.45	62.45	-23.00	QP	
8		0.2300	21.06	0.13	21.19	52.45	-31.26	AVG	
9		0.2460	37.90	0.13	38.03	61.89	-23.86	QP	
10		0.2460	19.49	0.13	19.62	51.89	-32.27	AVG	
11		0.4900	39.38	0.13	39.51	56.17	-16.66	QP	
12		0.4900	30.54	0.13	30.67	46.17	-15.50	AVG	

*:Maximum data x:Over limit !:over margin

Unless otherwise stated the results shown in this test report refer only to the sample(s) tested and such sample(s) are retained for 90 days only.

除非另有說明，此報告結果僅對測試之樣品負責，同時此樣品僅保留90天。本報告未經本公司書面許可，不可部份複製。

This document is issued by the Company subject to its General Conditions of Service printed overleaf, available on request or accessible at www.sgs.com/terms_and_conditions.htm and for electronic format documents, subject to Terms and Conditions for Electronic Documents at www.sgs.com/terms_e-document.htm. Attention is drawn to the limitation of liability, indemnification and jurisdiction issues defined therein. Any holder of this document is advised that information contained hereon reflects the Company's findings at the time of its intervention only and within the limits of Client's instructions, if any. The Company's sole responsibility is to its Client and this document does not exonerate parties to a transaction from exercising all their rights and obligations under the transaction documents. This document cannot be reproduced except in full, without prior written approval of the Company. Any unauthorized alteration, forgery or falsification of the content or appearance of this document is unlawful and offenders may be prosecuted to the fullest extent of the law.



Config_2_N

Site: : Conduction Room A	Date: 2019/11/12	Time: 下午 06:29:52
Limit: FCC Class B Conduction(QP)	Phase: N	Temperature: 22 °C
Mode: Config 2	Power: From System	Humidity: 57 %
Report: File :MH-2019-A0148		Air Pressure: 1017 hpa
Tester: Jeffrey Chou		
Note: AC 120V/60Hz , Data Write		

SGS Taiwan Ltd.-Electronics & Communication Laboratory Address: No.2, Keji 1st Rd., Guishan District, Taoyuan City, Taiwan 333

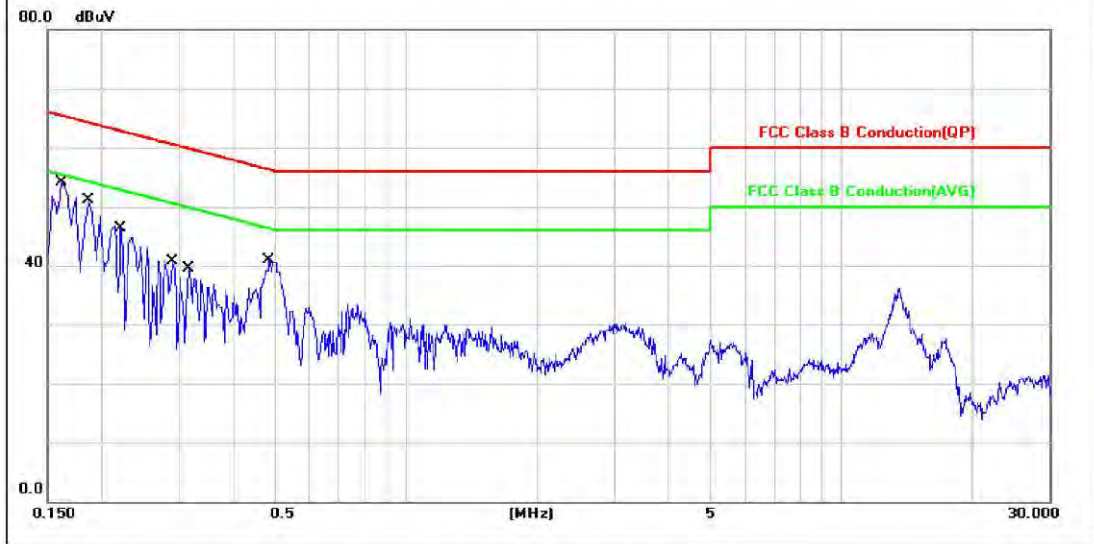

No.	Mk	Freq.	Reading	Factor	Measurement	Limit	Over	Detector	Comment
		(MHz)	(dBuV)	(dB)	(dBuV)	(dBuV)	(dB)		
1		0.1620	49.68	0.04	49.72	65.36	-15.64	QP	
2		0.1620	39.91	0.04	39.95	55.36	-15.41	AVG	
3		0.1864	43.55	0.08	43.63	64.20	-20.57	QP	
4		0.1864	17.27	0.08	17.35	54.20	-36.85	AVG	
5		0.2220	38.85	0.11	38.96	62.74	-23.78	QP	
6		0.2220	13.18	0.11	13.29	52.74	-39.45	AVG	
7		0.2900	33.96	0.11	34.07	60.52	-26.45	QP	
8		0.2900	21.07	0.11	21.18	50.52	-29.34	AVG	
9		0.3180	32.04	0.11	32.15	59.76	-27.61	QP	
10		0.3180	20.50	0.11	20.61	49.76	-29.15	AVG	
11		0.4860	38.33	0.11	38.44	56.24	-17.80	QP	
12	*	0.4860	31.29	0.11	31.40	46.24	-14.84	AVG	

*:Maximum data x:Over limit l:over margin

Unless otherwise stated the results shown in this test report refer only to the sample(s) tested and such sample(s) are retained for 90 days only.

除非另有說明，此報告結果僅對測試之樣品負責，同時此樣品僅保留90天。本報告未經本公司書面許可，不可部份複製。

This document is issued by the Company subject to its General Conditions of Service printed overleaf, available on request or accessible at www.sgs.com/terms_and_conditions.htm and for electronic format documents, subject to Terms and Conditions for Electronic Documents at www.sgs.com/terms_e-document.htm. Attention is drawn to the limitation of liability, indemnification and jurisdiction issues defined therein. Any holder of this document is advised that information contained hereon reflects the Company's findings at the time of its intervention only and within the limits of Client's instructions, if any. The Company's sole responsibility is to its Client and this document does not exonerate parties to a transaction from exercising all their rights and obligations under the transaction documents. This document cannot be reproduced except in full, without prior written approval of the Company. Any unauthorized alteration, forgery or falsification of the content or appearance of this document is unlawful and offenders may be prosecuted to the fullest extent of the law.



Config_4_L

Site: Conduction Room A	Date: 2019/11/12	Time: 下午 10:12:06
Limit: FCC Class B Conduction(QP)	Phase: L1	Temperature: 22 °C
Mode: Config 4	Power: AC 120V/60Hz	Humidity: 57 %RH
Report: MH-2019-A0148		Air Pressure: 1017 hpa
Tester: Jeffrey Chou		
Note: GSM 850		

SGS Taiwan Ltd.-Electronics & Communication Laboratory Address: No.2, Keji 1st Rd., Guishan District, Taoyuan City, Taiwan 333

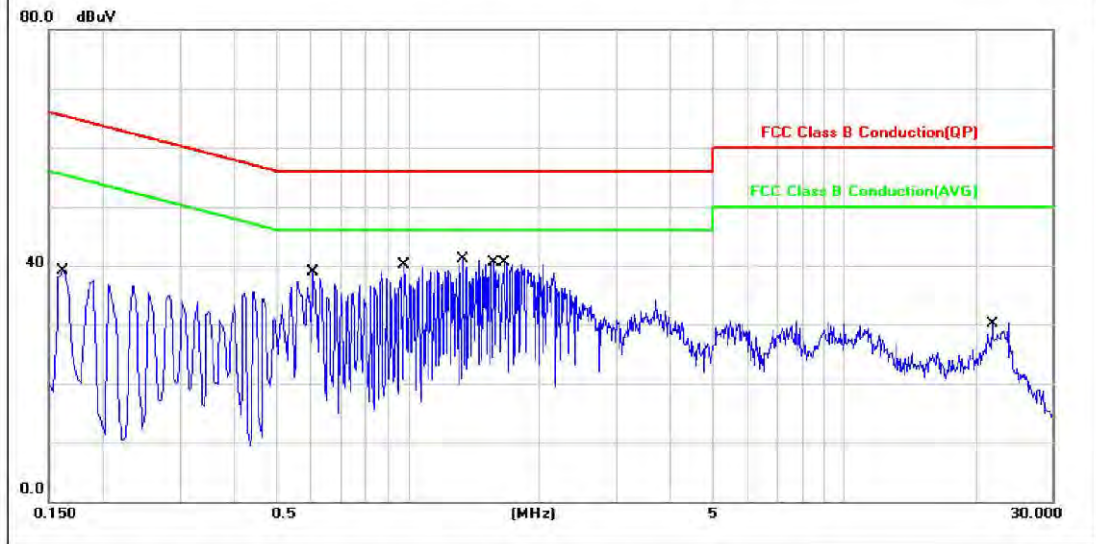

No.	Mk	Freq. (MHz)	Reading (dBuV)	Factor (dB)	Measurement (dBuV)	Limit (dBuV)	Over (dB)	Detector	Comment
1		0.1620	39.16	0.04	39.20	65.36	-26.16	QP	
2		0.1620	28.16	0.04	28.20	55.36	-27.16	AVG	
3		0.6060	38.56	0.14	38.70	56.00	-17.30	QP	
4		0.6060	28.76	0.14	28.90	46.00	-17.10	AVG	
5		0.9820	34.97	0.23	35.20	56.00	-20.80	QP	
6		0.9820	22.47	0.23	22.70	46.00	-23.30	AVG	
7		1.3340	34.07	0.23	34.30	56.00	-21.70	QP	
8	*	1.5740	30.36	0.24	30.60	46.00	-15.40	AVG	
9		1.6660	35.36	0.24	35.60	56.00	-20.40	QP	
10		1.6660	28.36	0.24	28.60	46.00	-17.40	AVG	
11		21.8940	34.56	0.64	35.20	60.00	-24.80	QP	
12		21.8940	24.56	0.64	25.20	50.00	-24.80	AVG	

*:Maximum data x:Over limit !:over margin

Unless otherwise stated the results shown in this test report refer only to the sample(s) tested and such sample(s) are retained for 90 days only.
 除非另有說明，此報告結果僅對測試之樣品負責，同時此樣品僅保留90天。本報告未經本公司書面許可，不可部份複製。
 This document is issued by the Company subject to its General Conditions of Service printed overleaf, available on request or accessible at www.sgs.com/terms_and_conditions.htm and for electronic format documents, subject to Terms and Conditions for Electronic Documents at www.sgs.com/terms_e-document.htm. Attention is drawn to the limitation of liability, indemnification and jurisdiction issues defined therein. Any holder of this document is advised that information contained hereon reflects the Company's findings at the time of its intervention only and within the limits of Client's instructions, if any. The Company's sole responsibility is to its Client and this document does not exonerate parties to a transaction from exercising all their rights and obligations under the transaction documents. This document cannot be reproduced except in full, without prior written approval of the Company. Any unauthorized alteration, forgery or falsification of the content or appearance of this document is unlawful and offenders may be prosecuted to the fullest extent of the law.

Config_4_N

Site: Conduction Room A	Date: 2019/11/12	Time: 下午 10:12:46
Limit: FCC Class B Conduction(QP)	Phase: N	Temperature: 22 °C
Mode: Config 4	Power: AC 120V/60Hz	Humidity: 57 %RH
Report: MH-2019-A0148		Air Pressure: 1017 hpa
Tester: Jeffrey Chou		
Note: GSM 850		

SGS Taiwan Ltd.-Electronics & Communication Laboratory Address: No.2, Keji 1st Rd., Guishan District, Taoyuan City, Taiwan 333

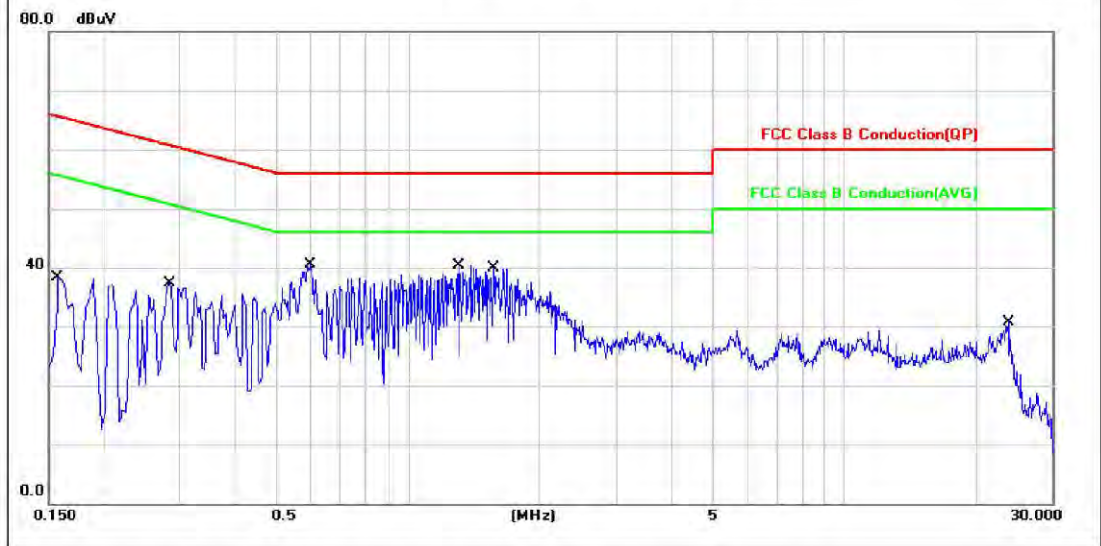

No.	Mk	Freq. (MHz)	Reading (dBuV)	Factor (dB)	Measurement (dBuV)	Limit (dBuV)	Over (dB)	Detector	Comment
1		0.1580	38.35	0.05	38.40	65.57	-27.17	QP	
2		0.1580	28.45	0.05	28.50	55.57	-27.07	AVG	
3		0.2860	36.37	0.13	36.50	60.64	-24.14	QP	
4		0.2860	27.27	0.13	27.40	50.64	-23.24	AVG	
5	*	0.5980	40.35	0.15	40.50	56.00	-15.50	QP	
6		0.5980	30.25	0.15	30.40	46.00	-15.60	AVG	
7		1.3140	35.25	0.25	35.50	56.00	-20.50	QP	
8		1.3140	23.15	0.25	23.40	46.00	-22.60	AVG	
9		1.5740	39.65	0.25	39.90	56.00	-16.10	QP	
10		1.5740	26.15	0.25	26.40	46.00	-19.60	AVG	
11		23.8260	30.42	1.08	31.50	60.00	-28.50	QP	
12		23.8260	26.52	1.08	27.60	50.00	-22.40	AVG	

*:Maximum data x:Over limit !:over margin

Unless otherwise stated the results shown in this test report refer only to the sample(s) tested and such sample(s) are retained for 90 days only.
 除非另有說明，此報告結果僅對測試之樣品負責，同時此樣品僅保留90天。本報告未經本公司書面許可，不可部份複製。
 This document is issued by the Company subject to its General Conditions of Service printed overleaf, available on request or accessible at www.sgs.com/terms_and_conditions.htm and for electronic format documents, subject to Terms and Conditions for Electronic Documents at www.sgs.com/terms_e-document.htm. Attention is drawn to the limitation of liability, indemnification and jurisdiction issues defined therein. Any holder of this document is advised that information contained hereon reflects the Company's findings at the time of its intervention only and within the limits of Client's instructions, if any. The Company's sole responsibility is to its Client and this document does not exonerate parties to a transaction from exercising all their rights and obligations under the transaction documents. This document cannot be reproduced except in full, without prior written approval of the Company. Any unauthorized alteration, forgery or falsification of the content or appearance of this document is unlawful and offenders may be prosecuted to the fullest extent of the law.



2.5 Test of Radiated Emission

2.5.1 Test Equipments

Below 1GHz

SGS Radiated_Below_1GHz HWAYA 10m_EMC					
EQUIPMENT TYPE	Manufacturer	Model Number	Serial Number	Calibration Date	Calibration Due
EMI Test Receiver	R&S	ESCI 7	100924	2019/2/1	2020/1/31
EMI Test Receiver	R&S	ESCI 3	101343	2019/2/1	2020/1/31
Broadband Antenna	SCHWAZBECK	VULB9168	9168-628	2019/9/9	2020/9/8
Broadband Antenna	SCHWAZBECK	VULB9168	9168-629	2019/9/9	2020/9/8
Pre Amplifier	EMC Instruments Corp.	EMC330	980178	2019/3/31	2020/3/30
Pre Amplifier	EMC Instruments Corp.	EMC330	980179	2019/3/31	2020/3/30
Coaxial Cable	EMC Instruments	EMCCFD400-NM-NM	150917	2019/9/18	2020/9/17
Coaxial Cable	EMC Instruments	EMCCFD400-NM-NM	150919	2019/9/18	2020/9/17
Coaxial Cable	EMC Instruments	EMCCFD400-NM-NM	150820	2019/9/18	2020/9/17
Coaxial Cable	EMC Instruments	EMCCFD400-NM-NM	150918	2019/9/18	2020/9/17
Coaxial Cable	EMC Instruments	EMCCFD400-NM-NM	150821	2019/9/18	2020/9/17
Coaxial Cable	EMC Instruments	EMCCFD400-NM-NM	150822	2019/9/18	2020/9/17
Universal Digital Radio Communication Tester	R&S	CMU 200	119988	2019/2/22	2020/2/21
Wideband Radio Communication Tester	R&S	CMW 500	152303	2019/2/22	2020/2/21
Radio Communication Analyzer	Anritsu	MT8820C	6201465315	N.C.R.	N.C.R.
Controller	MF	MF-7802	N/A	N.C.R.	N.C.R.
Controller	MF	MF-7802	N/A	N.C.R.	N.C.R.
Antenna Master	MF	N/A	N/A	N.C.R.	N.C.R.
Antenna Master	MF	N/A	N/A	N.C.R.	N.C.R.
Antenna Master	MF	N/A	N/A	N.C.R.	N.C.R.
Turn Table	MF	N/A	N/A	N.C.R.	N.C.R.
Site NSA	Chance Most	10M Chamber	10M SAC	2018/12/31	2019/12/30
Test S/W	Farad	EZ-EMC	Ver. SGS-03A2	N.C.R.	N.C.R.

SGS Taiwan LTD. Electronics & Communication Laboratory
 No.2, Keji 1st Rd., Guishan District, Taoyuan City 33383, Taiwan (R.O.C.)
 Measurement Uncertainty of Radiated Emission
 Expanded uncertainty Ulab (K=2) of radiated emission is 4.09 dB. (30MHz ~ 1000MHz)
 Theory values uncertainty Ucispr 16-4-2:2011+A1:2014 (K=2) of radiated emission is 5.22 dB. (30MHz ~ 1000MHz)

Unless otherwise stated the results shown in this test report refer only to the sample(s) tested and such sample(s) are retained for 90 days only.

除非另有說明，此報告結果僅對測試之樣品負責，同時此樣品僅保留90天。本報告未經本公司書面許可，不可部份複製。

This document is issued by the Company subject to its General Conditions of Service printed overleaf, available on request or accessible at www.sgs.com/terms_and_conditions.htm and for electronic format documents, subject to Terms and Conditions for Electronic Documents at www.sgs.com/terms_e-document.htm. Attention is drawn to the limitation of liability, indemnification and jurisdiction issues defined therein. Any holder of this document is advised that information contained hereon reflects the Company's findings at the time of its intervention only and within the limits of Client's instructions, if any. The Company's sole responsibility is to its Client and this document does not exonerate parties to a transaction from exercising all their rights and obligations under the transaction documents. This document cannot be reproduced except in full, without prior written approval of the Company. Any unauthorized alteration, forgery or falsification of the content or appearance of this document is unlawful and offenders may be prosecuted to the fullest extent of the law.



Above 1GHz

SGS Radiated_Above_1GHz HWAYA 966B EMC					
EQUIPMENT TYPE	Manufacturer	Model Number	Serial Number	Calibration Date	Calibration Due
Spectrum Analyzer	R&S	FSV 40	101419	2019/5/22	2020/5/21
EMI Test Receiver	R&S	ESR 7	101507	2019/9/4	2020/9/3
Horn Antenna	SCHWARZBECK	BBHA9120D	BBHA9120D673	2019/11/4	2020/11/3
Pre Amplifier	R&S	SCU-18	10203	2019/3/26	2020/3/25
Coaxial Cable	Huber+Suhner	SUCCOFLEX 104	MY 5817/4	2019/3/26	2020/3/25
Coaxial Cable	EMC Instruments	EMC104-SM-SM	140923	2019/9/30	2020/9/29
Coaxial Cable	EMC Instruments	EMC104-SM-SM	140925	2019/9/30	2020/9/29
Coaxial Cable	EMC Instruments	EMC104-SM-SM	140927	2019/9/30	2020/9/29
Coaxial Cable	Huber+Suhner	SUCOFLEX 102	MY 2651/2	2019/6/5	2020/6/4
Coaxial Cable	Huber+Suhner	SUCOFLEX 102	MY 2153/2	2019/6/5	2020/6/4
Universal Digital Radio Communication Tester	R&S	CMU 200	119988	2019/2/22	2020/2/21
Wideband Radio Communication Tester	R&S	CMW 500	152303	2019/2/22	2020/2/21
Radio Communication Analyzer	Anritsu	MT8820C	6201465315	N.C.R.	N.C.R.
Controller	MF-7802	N/A	N/A	N.C.R.	N.C.R.
Antenna Master	MF	N/A	N/A	N.C.R.	N.C.R.
Turn Table	MF	N/A	N/A	N.C.R.	N.C.R.
Site VSWR	SGS	966 Chamber B	SAC-B	2019/10/8	2020/10/7
Test S/W	Farad	EZ-EMC	Ver. SGS-03A2-1	N.C.R.	N.C.R.

SGS Taiwan LTD. Electronics & Communication Laboratory
 No.2, Keji 1st Rd., Guishan District, Taoyuan City 33383, Taiwan (R.O.C.)
 Measurement Uncertainty of Radiated Emission
 Expanded uncertainty (k=2) of radiated emission measurement is 5.06 dB. (1-6GHz)
 Expanded uncertainty (k=2) of radiated emission measurement is 5.15 dB. (6-18GHz)
 Theory values uncertainty Ucispr 16-4-2:2011+A1:2014 (K=2) of radiated emission measurement is 5.18 dB.(1-6GHz)
 Theory values uncertainty Ucispr 16-4-2:2011+A1:2014 (K=2) of radiated emission measurement is 5.48 dB.(6-18GHz)

Unless otherwise stated the results shown in this test report refer only to the sample(s) tested and such sample(s) are retained for 90 days only.

除非另有說明，此報告結果僅對測試之樣品負責，同時此樣品僅保留90天。本報告未經本公司書面許可，不可部份複製。

This document is issued by the Company subject to its General Conditions of Service printed overleaf, available on request or accessible at www.sgs.com/terms_and_conditions.htm and for electronic format documents, subject to Terms and Conditions for Electronic Documents at www.sgs.com/terms_e-document.htm. Attention is drawn to the limitation of liability, indemnification and jurisdiction issues defined therein. Any holder of this document is advised that information contained hereon reflects the Company's findings at the time of its intervention only and within the limits of Client's instructions, if any. The Company's sole responsibility is to its Client and this document does not exonerate parties to a transaction from exercising all their rights and obligations under the transaction documents. This document cannot be reproduced except in full, without prior written approval of the Company. Any unauthorized alteration, forgery or falsification of the content or appearance of this document is unlawful and offenders may be prosecuted to the fullest extent of the law.

SGS Taiwan Ltd.

No.134,Wu Kung Road, New Taipei Industrial Park, Wuku District, New Taipei City, Taiwan 24803/新北市五股區新北產業園區五工路 134 號

台灣檢驗科技股份有限公司

t (886-2) 2299-3279

f (886-2) 2298-0488

www.tw.sgs.com

Member of SGS Group



SGS Radiated_Above_1GHz HWAYA 966A EMC					
EQUIPMENT TYPE	Manufacturer	Model Number	Serial Number	Calibration Date	Calibration Due
Spectrum Analyzer	R&S	FSV 40	101419	2019/5/22	2020/5/21
EMI Test Receiver	R&S	ESR 7	101459	2019/2/25	2020/2/24
Horn Antenna	SCHWARZBECK	BBHA9120D	BBHA9120D673	2019/11/4	2020/11/3
Horn Antenna	Schwarzbeck	BBHA9170	BBHA9170-184	2018/12/27	2019/12/26
Pre Amplifier	EMC Instruments Corp.	EMC012645B	980216	2019/4/25	2020/4/24
Pre Amplifier	EMC Instruments Corp.	EMC184045B	980135	2019/10/27	2020/10/26
Coaxial Cable	JUNFLOW	MWX221-NMSNMS	J0778929	2019/4/23	2020/4/22
Coaxial Cable	Huber+Suhner	SUCCOFLEX 104PEA	30255/4PEA	2019/4/23	2020/4/22
Coaxial Cable	EMC Instruments	EMC104-SM-SM	140927	2019/4/23	2020/4/22
Coaxial Cable	Huber+Suhner	SUCOFLEX 102	MY 2651/2	2019/6/5	2020/6/4
Coaxial Cable	Huber+Suhner	SUCOFLEX 102	MY 2153/2	2019/6/5	2020/6/4
Universal Digital Radio Communication Tester	R&S	CMU 200	119988	2019/2/22	2020/2/21
Wideband Radio Communication Tester	R&S	CMW 500	152303	2019/2/22	2020/2/21
Radio Communication Analyzer	Anritsu	MT8820C	6201465315	N.C.R.	N.C.R.
Controller	MF	MF-7802	N.C.R.	N.C.R.	N.C.R.
Antenna Master	MF	N/A	N/A	N.C.R.	N.C.R.
Turn Table	MF	N/A	N/A	N.C.R.	N.C.R.
Site VSWR	SGS	966 Chamber A	SAC-A	2019/1/12	2020/1/11
Test S/W	Farad	EZ-EMC	Ver. SGS-03A2	N.C.R.	N.C.R.

SGS Taiwan LTD. Electronics & Communication Laboratory
 No.2, Keji 1st Rd., Guishan District, Taoyuan City 33383, Taiwan (R.O.C.)
 Measurement Uncertainty of Radiated Emission
 Expanded uncertainty (k=2) of radiated emission measurement is 5.05 dB. (1-6GHz)
 Expanded uncertainty (k=2) of radiated emission measurement is 5.07 dB. (6-18GHz)
 Expanded uncertainty Ulab (k=2) of radiated emission measurement is 5.19 dB. (18-26GHz)
 Expanded uncertainty Ulab (k=2) of radiated emission measurement is 5.14 dB. (26-40GHz)
 Theory values uncertainty Ucispr 16-4-2:2011+A1:2014 (K=2) of radiated emission measurement is 5.18 dB.(1-6GHz)
 Theory values uncertainty Ucispr 16-4-2:2011+A1:2014 (K=2) of radiated emission measurement is 5.48 dB.(6-18GHz)
 Theory values uncertainty Ucispr 16-4-2:2011+A1:2014 (K=2) of radiated emission measurement is ---- dB.(18-26GHz)
 Theory values uncertainty Ucispr 16-4-2:2011+A1:2014 (K=2) of radiated emission measurement is ---- dB.(26-40GHz)

2.5.2 Operating Environment

Temperature : 22 degree C Humidity : 65 %RH
 Atmospheric Pressure : 1014 hpa

2.5.3 Measurement Level Calculation

Correction Factor = Antenna Factor + Cable loss- Amplifier Gain
 Measurement Level = Reading Level + Correction Factor
 Over (Margin) = Measurement Level – Limit

Unless otherwise stated the results shown in this test report refer only to the sample(s) tested and such sample(s) are retained for 90 days only.

除非另有說明，此報告結果僅對測試之樣品負責，同時此樣品僅保留90天。本報告未經本公司書面許可，不可部份複製。

This document is issued by the Company subject to its General Conditions of Service printed overleaf, available on request or accessible at www.sgs.com/terms_and_conditions.htm and for electronic format documents, subject to Terms and Conditions for Electronic Documents at www.sgs.com/terms_e-document.htm. Attention is drawn to the limitation of liability, indemnification and jurisdiction issues defined therein. Any holder of this document is advised that information contained hereon reflects the Company's findings at the time of its intervention only and within the limits of Client's instructions, if any. The Company's sole responsibility is to its Client and this document does not exonerate parties to a transaction from exercising all their rights and obligations under the transaction documents. This document cannot be reproduced except in full, without prior written approval of the Company. Any unauthorized alteration, forgery or falsification of the content or appearance of this document is unlawful and offenders may be prosecuted to the fullest extent of the law.



2.5.4 Measurement Data

Below 1GHz

Config_1_H

Site: SGS 10m Chamber	Date: 2019/11/9	Time: 上午 04:43:46
Limit: CISPR22 Class B 10m Radiation	Polarization: Horizontal	Temperature: 21 °C
Mode: Config 1	Power: AC 120V/60Hz	Humidity: 67 %
Report: File :MH-2019-A0148	Distance: 10m	Air Pressure: 1014 hpa
Tester: Jeffrey Chou		
Note: GSM 1900		

SGS Taiwan Ltd.-Electronics & Communication Laboratory - Address: No.2, Keq 1st Rd., Gaishan District, Taoyuan City, Taiwan 333

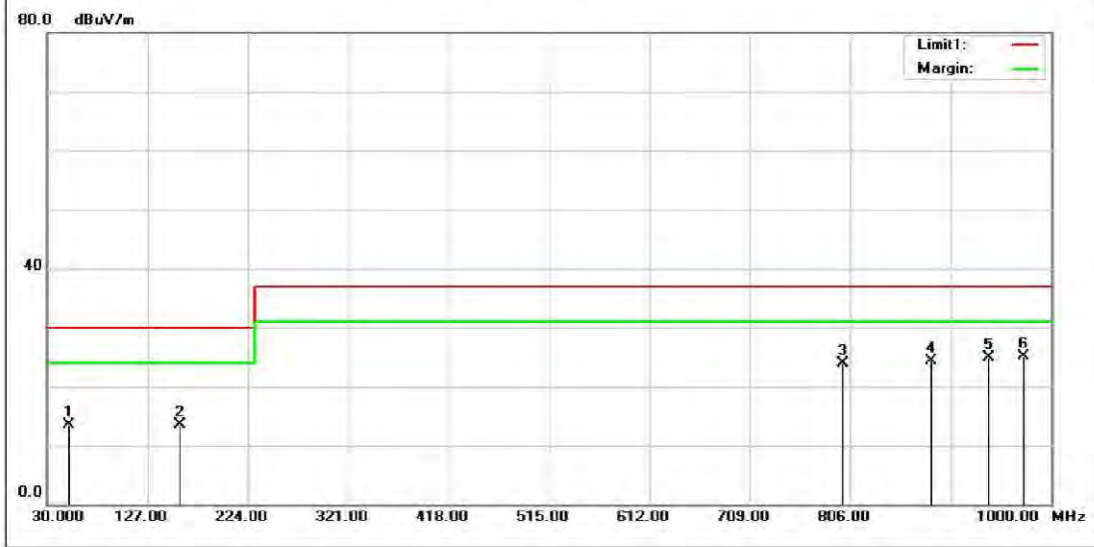

No.	Mk	Freq. (MHz)	Reading (dBuV)	Factor (dB/m)	Measurement (dBuV/m)	Limit (dBuV/m)	Over (dB)	Height (cm)	Degree (deg.)	Detector	Comment
1		51.3400	24.59	-11.12	13.47	30.00	-16.53			QP	
2		158.0400	24.52	-10.99	13.53	30.00	-16.47			QP	
3		798.2400	23.70	0.17	23.87	37.00	-13.13			QP	
4		884.5700	23.79	0.49	24.28	37.00	-12.72			QP	
5		939.8600	23.70	1.18	24.88	37.00	-12.12			QP	
6	*	973.8100	23.51	1.52	25.03	37.00	-11.97	399	338	QP	

*:Maximum data x:Over limit l:over margin

Unless otherwise stated the results shown in this test report refer only to the sample(s) tested and such sample(s) are retained for 90 days only.
 除非另有說明，此報告結果僅對測試之樣品負責，同時此樣品僅保留90天。本報告未經本公司書面許可，不可部份複製。
 This document is issued by the Company subject to its General Conditions of Service printed overleaf, available on request or accessible at www.sgs.com/terms_and_conditions.htm and for electronic format documents, subject to Terms and Conditions for Electronic Documents at www.sgs.com/terms_e-document.htm. Attention is drawn to the limitation of liability, indemnification and jurisdiction issues defined therein. Any holder of this document is advised that information contained hereon reflects the Company's findings at the time of its intervention only and within the limits of Client's instructions, if any. The Company's sole responsibility is to its Client and this document does not exonerate parties to a transaction from exercising all their rights and obligations under the transaction documents. This document cannot be reproduced except in full, without prior written approval of the Company. Any unauthorized alteration, forgery or falsification of the content or appearance of this document is unlawful and offenders may be prosecuted to the fullest extent of the law.



Config_1_V

Site: SGS 10m Chamber	Date: 2019/11/9	Time: 上午 04:43:45
Limit: CISPR22 Class B 10m Radiation	Polarization: Vertical	Temperature: 21 °C
Mode: Config 1	Power: AC 120V/60Hz	Humidity: 67 %
Report: File :MH-2019-A0148	Distance: 10m	Air Pressure: 1014 hpa
Tester: Jeffrey Chou		
Note: GSM 1900		

SGS Taiwan Ltd. Electronics & Communication Laboratory Address: No.2, Keji 1st Rd., Guishan District, Taoyuan City, Taiwan 333

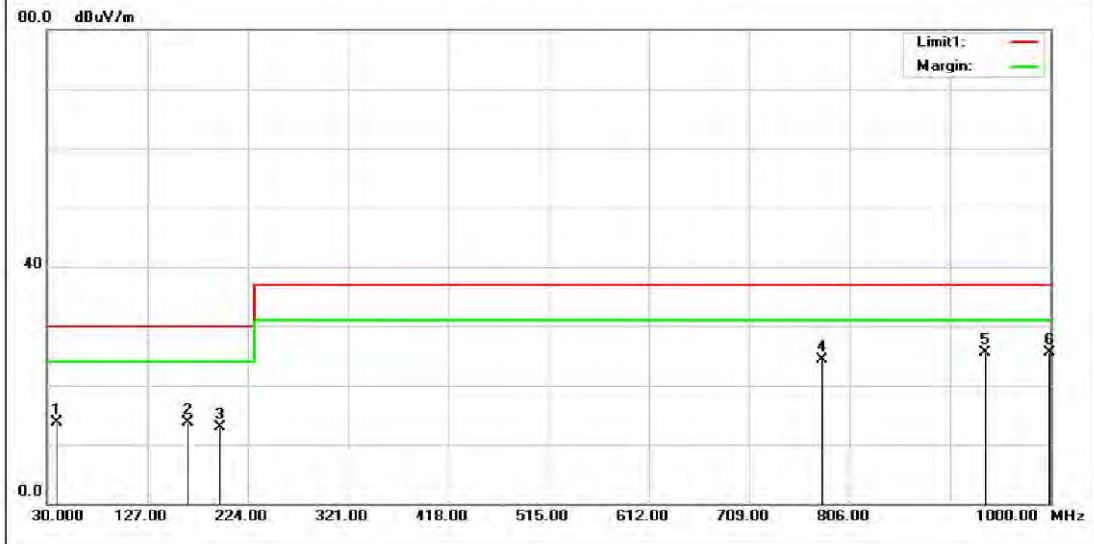

No.	Mk	Freq. (MHz)	Reading (dBuV)	Factor (dB/m)	Measurement (dBuV/m)	Limit (dBuV/m)	Over (dB)	Height (cm)	Degree (deg.)	Detector	Comment
1		39.7000	25.08	-11.28	13.80	30.00	-16.20			QP	
2		165.8000	24.33	-10.72	13.61	30.00	-16.39			QP	
3		197.8100	26.71	-13.74	12.97	30.00	-17.03			QP	
4		778.8400	22.94	1.34	24.28	37.00	-12.72			QP	
5		936.9500	23.00	2.45	25.45	37.00	-11.55			QP	
6	*	999.0300	22.90	2.68	25.58	37.00	-11.42	300	0	QP	

*:Maximum data x:Over limit !:over margin

Unless otherwise stated the results shown in this test report refer only to the sample(s) tested and such sample(s) are retained for 90 days only.

除非另有說明，此報告結果僅對測試之樣品負責，同時此樣品僅保留90天。本報告未經本公司書面許可，不可部份複製。

This document is issued by the Company subject to its General Conditions of Service printed overleaf, available on request or accessible at www.sgs.com/terms_and_conditions.htm and for electronic format documents, subject to Terms and Conditions for Electronic Documents at www.sgs.com/terms_e-document.htm. Attention is drawn to the limitation of liability, indemnification and jurisdiction issues defined therein. Any holder of this document is advised that information contained hereon reflects the Company's findings at the time of its intervention only and within the limits of Client's instructions, if any. The Company's sole responsibility is to its Client and this document does not exonerate parties to a transaction from exercising all their rights and obligations under the transaction documents. This document cannot be reproduced except in full, without prior written approval of the Company. Any unauthorized alteration, forgery or falsification of the content or appearance of this document is unlawful and offenders may be prosecuted to the fullest extent of the law.

Config_2_H

Site: SGS 10m Chamber	Date: 2019/11/11	Time: 下午 06:22:40
Limit: CISPR22 Class B 10m Radiation	Polarization: Horizontal	Temperature: 21 °C
Mode: Config 2	Power: From System	Humidity: 67 %
Report: File :MH-2019-A0148	Distance: 10m	Air Pressure: 1014 hpa
Tester: Jeffrey Chou		
Note: Data Write		

SGS Taiwan Ltd.-Electronics & Communication Laboratory Address: No.2, Keq 1st Rd., Gushan District, Taoyuan City, Taiwan 333

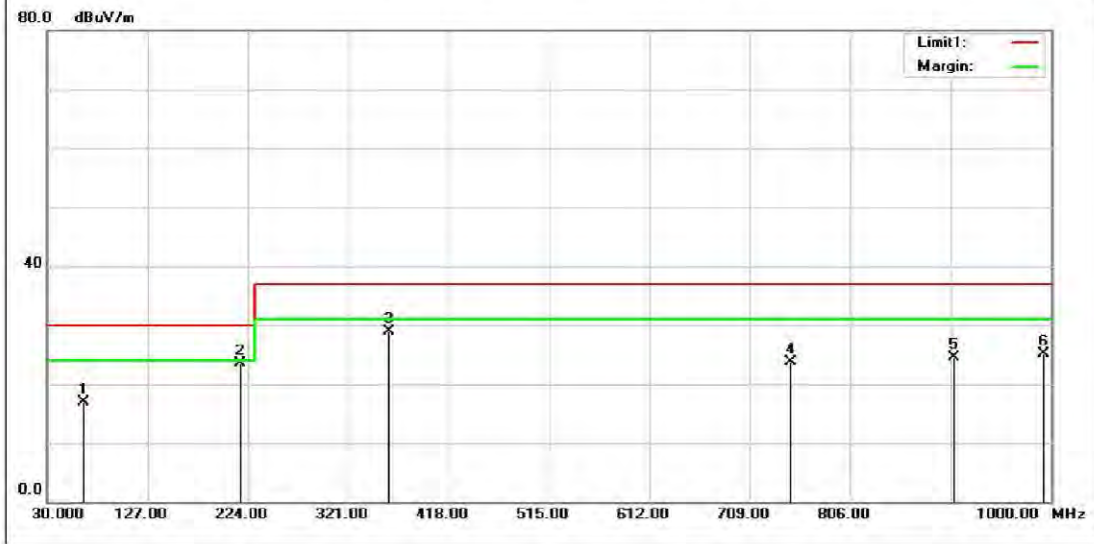

No.	Mk	Freq. (MHz)	Reading (dBuV)	Factor (dB/m)	Measurement (dBuV/m)	Limit (dBuV/m)	Over (dB)	Height (cm)	Degree (deg.)	Detector	Comment
1		64.4500	29.27	-12.39	16.88	30.00	-13.12			QP	
2	*	215.9900	38.13	-14.62	23.51	30.00	-6.49	399	285	QP	
3		360.0200	38.02	-9.10	28.92	37.00	-8.08			QP	
4		748.7700	23.46	0.17	23.63	37.00	-13.37			QP	
5		905.9100	23.79	0.75	24.54	37.00	-12.46			QP	
6		993.2100	23.50	1.64	25.14	37.00	-11.86			QP	

*:Maximum data x:Over limit !:over margin

Unless otherwise stated the results shown in this test report refer only to the sample(s) tested and such sample(s) are retained for 90 days only.
 除非另有說明，此報告結果僅對測試之樣品負責，同時此樣品僅保留90天。本報告未經本公司書面許可，不可部份複製。
 This document is issued by the Company subject to its General Conditions of Service printed overleaf, available on request or accessible at www.sgs.com/terms_and_conditions.htm and for electronic format documents, subject to Terms and Conditions for Electronic Documents at www.sgs.com/terms_e-document.htm. Attention is drawn to the limitation of liability, indemnification and jurisdiction issues defined therein. Any holder of this document is advised that information contained hereon reflects the Company's findings at the time of its intervention only and within the limits of Client's instructions, if any. The Company's sole responsibility is to its Client and this document does not exonerate parties to a transaction from exercising all their rights and obligations under the transaction documents. This document cannot be reproduced except in full, without prior written approval of the Company. Any unauthorized alteration, forgery or falsification of the content or appearance of this document is unlawful and offenders may be prosecuted to the fullest extent of the law.



Config_2_V

Site: SGS 10m Chamber	Date: 2019/11/11	Time: 下午 06:22:39
Limit: CISPR22 Class B 10m Radiation	Polarization: Vertical	Temperature: 21 °C
Mode: Config 2	Power: From System	Humidity: 67 %
Report: File :MH-2019-A0148	Distance: 10m	Air Pressure: 1014 hpa
Tester: Jeffrey Chou		
Note: Data Write		

SGS Taiwan Ltd. Electronics & Communication Laboratory Address: No 2, Keji 1st Rd., Guishan District, Taoyuan City, Taiwan 333

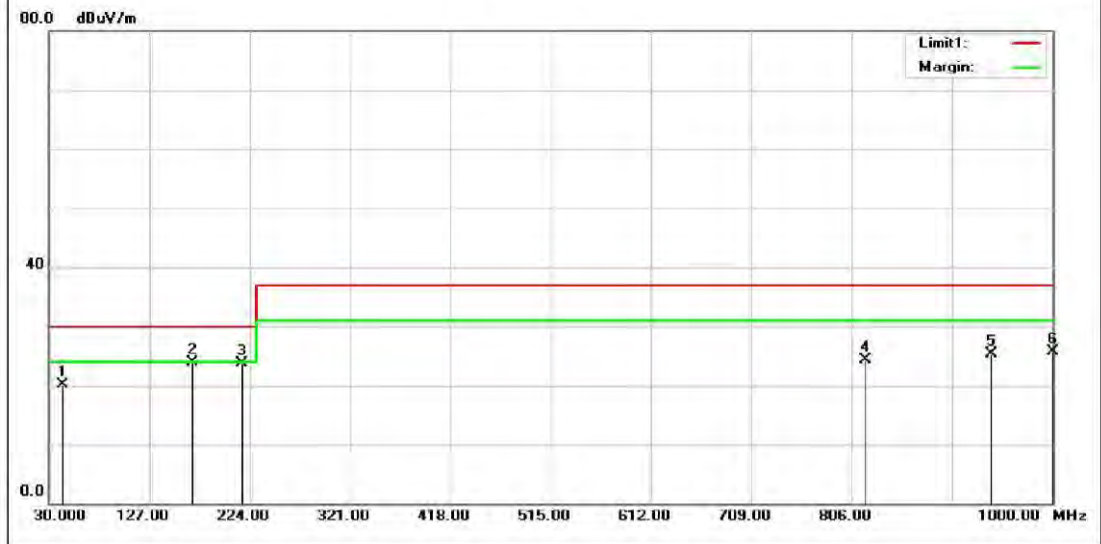

No.	Mk	Freq. (MHz)	Reading (dBuV)	Factor (dB/m)	Measurement (dBuV/m)	Limit (dBuV/m)	Over (dB)	Height (cm)	Degree (deg.)	Detector	Comment
1		42.7100	30.96	-10.88	20.08	30.00	-9.92			QP	
2	*	167.9800	34.68	-10.72	23.96	30.00	-6.04	100	59	QP	
3		215.9900	37.60	-13.96	23.64	30.00	-6.36			QP	
4		819.5800	22.76	1.58	24.34	37.00	-12.66			QP	
5		940.8300	22.89	2.47	25.36	37.00	-11.64			QP	
6		1000.0000	23.07	2.70	25.77	37.00	-11.23			QP	

*:Maximum data x:Over limit l:over margin

Unless otherwise stated the results shown in this test report refer only to the sample(s) tested and such sample(s) are retained for 90 days only.

除非另有說明，此報告結果僅對測試之樣品負責，同時此樣品僅保留90天。本報告未經本公司書面許可，不可部份複製。

This document is issued by the Company subject to its General Conditions of Service printed overleaf, available on request or accessible at www.sgs.com/terms_and_conditions.htm and for electronic format documents, subject to Terms and Conditions for Electronic Documents at www.sgs.com/terms_e-document.htm. Attention is drawn to the limitation of liability, indemnification and jurisdiction issues defined therein. Any holder of this document is advised that information contained hereon reflects the Company's findings at the time of its intervention only and within the limits of Client's instructions, if any. The Company's sole responsibility is to its Client and this document does not exonerate parties to a transaction from exercising all their rights and obligations under the transaction documents. This document cannot be reproduced except in full, without prior written approval of the Company. Any unauthorized alteration, forgery or falsification of the content or appearance of this document is unlawful and offenders may be prosecuted to the fullest extent of the law.



Config_3_H

Site: SGS 10m Chamber	Date: 2019/11/11	Time: 下午 10:14:09
Limit: CISPR22 Class B 10m Radiation	Polarization: Horizontal	Temperature: 21 °C
Mode: Config 3	Power: From Battery	Humidity: 67 %
Report: File :MH-2019-A0148	Distance: 10m	Air Pressure: 1014 hpa
Tester: Jeffrey Chou		
Note: MP3		

SGS Taiwan Ltd.-Electronics & Communication Laboratory Address: No.2, Keq 1st Rd., Guishan District, Taoyuan City, Taiwan 333

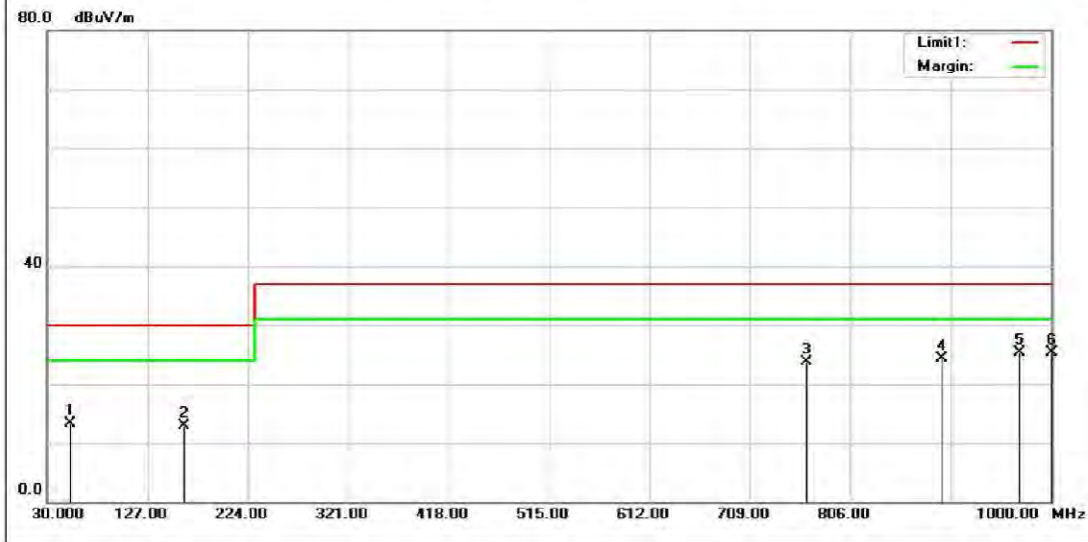

No.	Mk	Freq. (MHz)	Reading (dBuV)	Factor (dB/m)	Measurement (dBuV/m)	Limit (dBuV/m)	Over (dB)	Height (cm)	Degree (deg.)	Detector	Comment
1		52.3100	24.55	-11.18	13.37	30.00	-16.63			QP	
2		161.9200	23.89	-11.00	12.89	30.00	-17.11			QP	
3		763.3200	23.48	0.32	23.80	37.00	-13.20			QP	
4		894.2700	23.78	0.60	24.38	37.00	-12.62			QP	
5		968.9600	23.66	1.58	25.24	37.00	-11.76			QP	
6	*	1000.0000	23.63	1.70	25.33	37.00	-11.67	101	356	QP	

*:Maximum data x:Over limit l:over margin

Unless otherwise stated the results shown in this test report refer only to the sample(s) tested and such sample(s) are retained for 90 days only.

除非另有說明，此報告結果僅對測試之樣品負責，同時此樣品僅保留90天。本報告未經本公司書面許可，不可部份複製。

This document is issued by the Company subject to its General Conditions of Service printed overleaf, available on request or accessible at www.sgs.com/terms_and_conditions.htm and for electronic format documents, subject to Terms and Conditions for Electronic Documents at www.sgs.com/terms_e-document.htm. Attention is drawn to the limitation of liability, indemnification and jurisdiction issues defined therein. Any holder of this document is advised that information contained hereon reflects the Company's findings at the time of its intervention only and within the limits of Client's instructions, if any. The Company's sole responsibility is to its Client and this document does not exonerate parties to a transaction from exercising all their rights and obligations under the transaction documents. This document cannot be reproduced except in full, without prior written approval of the Company. Any unauthorized alteration, forgery or falsification of the content or appearance of this document is unlawful and offenders may be prosecuted to the fullest extent of the law.



Config_3_V

Site: SGS 10m Chamber	Date: 2019/11/11	Time: 下午 10:14:08
Limit: CISPR22 Class B 10m Radiation	Polarization: Vertical	Temperature: 21 °C
Mode: Config 3	Power: From Battery	Humidity: 67 %
Report: File :MH-2019-A0148	Distance: 10m	Air Pressure: 1014 hpa
Tester: Jeffrey Chou		
Note: MP3		

SGS Taiwan Ltd. Electronics & Communication Laboratory Address: No 2, Keji 1st Rd., Guishan District, Taoyuan City, Taiwan 333

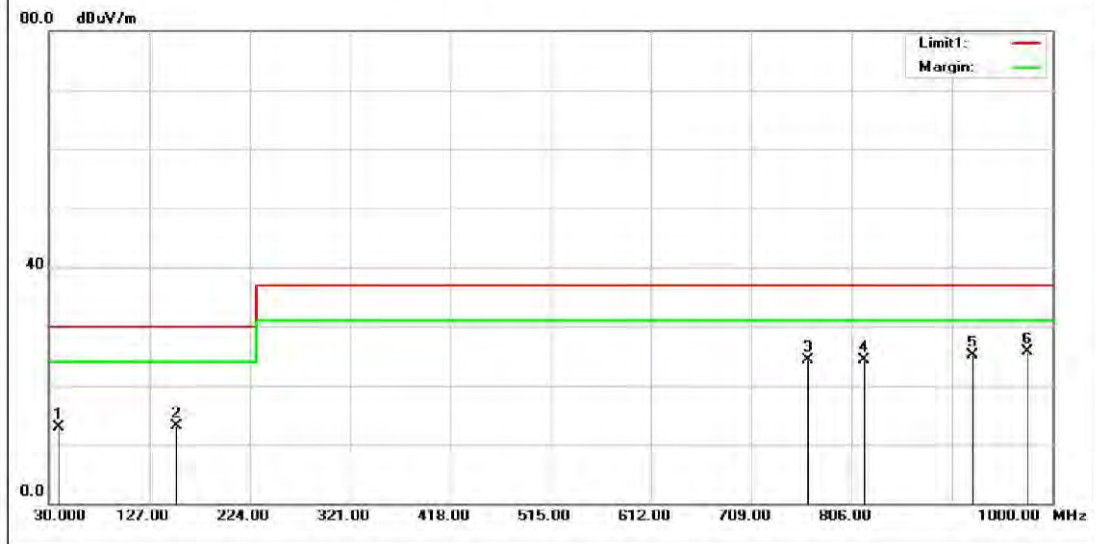

No.	Mk	Freq. (MHz)	Reading (dBuV)	Factor (dB/m)	Measurement (dBuV/m)	Limit (dBuV/m)	Over (dB)	Height (cm)	Degree (deg.)	Detector	Comment
1		39.7000	24.18	-11.28	12.90	30.00	-17.10			QP	
2		153.1900	24.06	-10.92	13.14	30.00	-16.86			QP	
3		764.2900	22.89	1.37	24.26	37.00	-12.74			QP	
4		818.6100	22.73	1.54	24.27	37.00	-12.73			QP	
5		922.4000	22.99	2.19	25.18	37.00	-11.82			QP	
6	*	975.7500	22.95	2.70	25.65	37.00	-11.35	155	360	QP	

*:Maximum data x:Over limit l:over margin

Unless otherwise stated the results shown in this test report refer only to the sample(s) tested and such sample(s) are retained for 90 days only.

除非另有說明，此報告結果僅對測試之樣品負責，同時此樣品僅保留90天。本報告未經本公司書面許可，不可部份複製。

This document is issued by the Company subject to its General Conditions of Service printed overleaf, available on request or accessible at www.sgs.com/terms_and_conditions.htm and for electronic format documents, subject to Terms and Conditions for Electronic Documents at www.sgs.com/terms_e-document.htm. Attention is drawn to the limitation of liability, indemnification and jurisdiction issues defined therein. Any holder of this document is advised that information contained hereon reflects the Company's findings at the time of its intervention only and within the limits of Client's instructions, if any. The Company's sole responsibility is to its Client and this document does not exonerate parties to a transaction from exercising all their rights and obligations under the transaction documents. This document cannot be reproduced except in full, without prior written approval of the Company. Any unauthorized alteration, forgery or falsification of the content or appearance of this document is unlawful and offenders may be prosecuted to the fullest extent of the law.



Config_4_H

Site: SGS 10m Chamber	Date: 2019/11/19	Time: 下午 11:11:31
Limit: CISPR22 Class B 10m Radiation	Polarization: Horizontal	Temperature: 20 °C
Mode: Config 4	Power: AC 120V/60Hz	Humidity: 65 %
Report: File :MH-2019-A0148	Distance: 10m	Air Pressure: 1012 hpa
Tester: Jeffrey Chou		
Note: LTE B05		

SGS Taiwan Ltd.-Electronics & Communication Laboratory Address: No.2, Keq 1st Rd., Gushan District, Taoyuan City, Taiwan 333

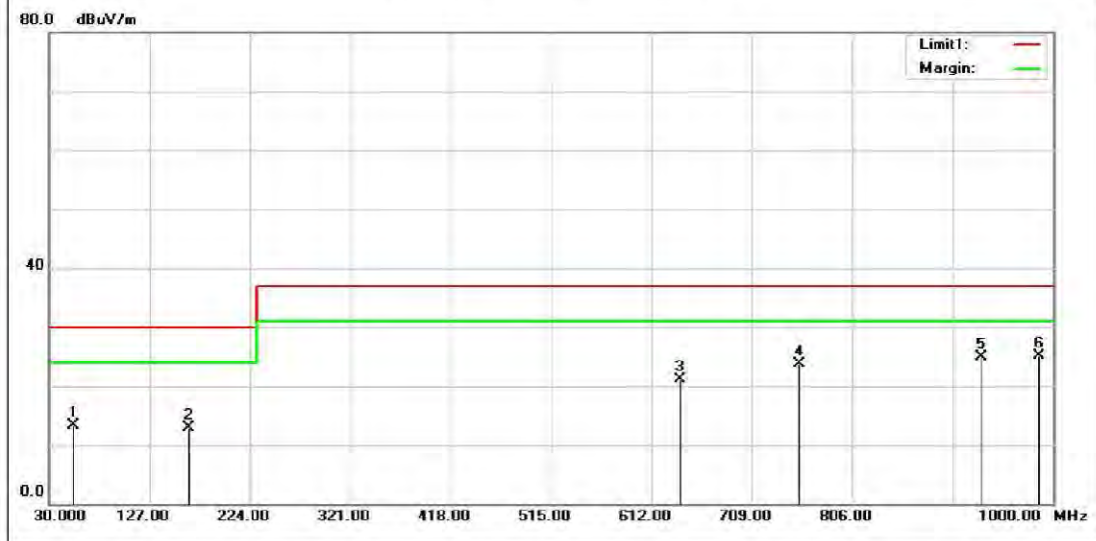

No.	Mk	Freq. (MHz)	Reading (dBuV)	Factor (dB/m)	Measurement (dBuV/m)	Limit (dBuV/m)	Over (dB)	Height (cm)	Degree (deg.)	Detector	Comment
1		53.2800	24.57	-11.20	13.37	30.00	-16.63			QP	
2		164.8300	24.09	-11.22	12.87	30.00	-17.13			QP	
3		639.1600	23.58	-2.51	21.07	37.00	-15.93			QP	
4		754.5900	23.50	0.17	23.67	37.00	-13.33			QP	
5		930.1600	23.61	1.26	24.87	37.00	-12.13			QP	
6	*	986.4200	23.56	1.63	25.19	37.00	-11.81	300	360	QP	

*:Maximum data x:Over limit !:over margin

Unless otherwise stated the results shown in this test report refer only to the sample(s) tested and such sample(s) are retained for 90 days only.

除非另有說明，此報告結果僅對測試之樣品負責，同時此樣品僅保留90天。本報告未經本公司書面許可，不可部份複製。

This document is issued by the Company subject to its General Conditions of Service printed overleaf, available on request or accessible at www.sgs.com/terms_and_conditions.htm and for electronic format documents, subject to Terms and Conditions for Electronic Documents at www.sgs.com/terms_e-document.htm. Attention is drawn to the limitation of liability, indemnification and jurisdiction issues defined therein. Any holder of this document is advised that information contained hereon reflects the Company's findings at the time of its intervention only and within the limits of Client's instructions, if any. The Company's sole responsibility is to its Client and this document does not exonerate parties to a transaction from exercising all their rights and obligations under the transaction documents. This document cannot be reproduced except in full, without prior written approval of the Company. Any unauthorized alteration, forgery or falsification of the content or appearance of this document is unlawful and offenders may be prosecuted to the fullest extent of the law.



Config_4_V

Site: SGS 10m Chamber	Date: 2019/11/19	Time: 下午 11:11:29
Limit: CISPR22 Class B 10m Radiation	Polarization: Vertical	Temperature: 20 °C
Mode: Config 4	Power: AC 120V/60Hz	Humidity: 65 %
Report: File :MH-2019-A0148	Distance: 10m	Air Pressure: 1012 hpa
Tester: Jeffrey Chou		
Note: LTE B05		

SGS Taiwan Ltd. Electronics & Communication Laboratory Address: No 2, Keji 1st Rd., Guishan District, Taoyuan City, Taiwan 333

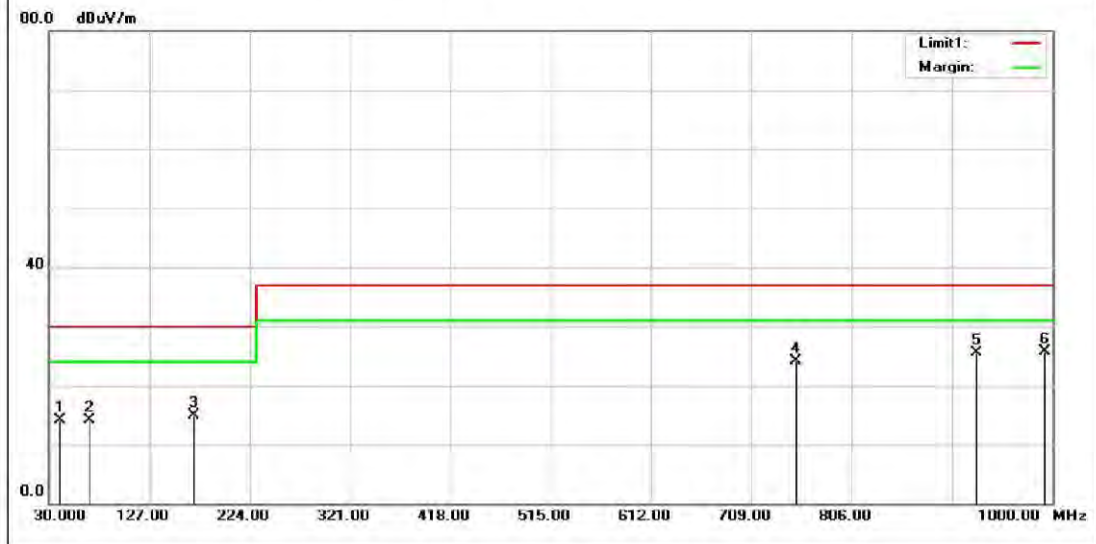

No.	Mk	Freq. (MHz)	Reading (dBuV)	Factor (dB/m)	Measurement (dBuV/m)	Limit (dBuV/m)	Over (dB)	Height (cm)	Degree (deg.)	Detector	Comment
1		40.6400	25.43	-11.25	14.18	30.00	-15.82			QP	
2		68.8000	26.85	-12.75	14.10	30.00	-15.90			QP	
3		170.6500	25.81	-11.00	14.81	30.00	-15.19			QP	
4		751.6800	22.86	1.30	24.16	37.00	-12.84			QP	
5		927.2500	23.21	2.26	25.47	37.00	-11.53			QP	
6	*	992.2400	23.11	2.60	25.71	37.00	-11.29	100	0	QP	

*:Maximum data x:Over limit l:over margin

Unless otherwise stated the results shown in this test report refer only to the sample(s) tested and such sample(s) are retained for 90 days only.

除非另有說明，此報告結果僅對測試之樣品負責，同時此樣品僅保留90天。本報告未經本公司書面許可，不可部份複製。

This document is issued by the Company subject to its General Conditions of Service printed overleaf, available on request or accessible at www.sgs.com/terms_and_conditions.htm and for electronic format documents, subject to Terms and Conditions for Electronic Documents at www.sgs.com/terms_e-document.htm. Attention is drawn to the limitation of liability, indemnification and jurisdiction issues defined therein. Any holder of this document is advised that information contained hereon reflects the Company's findings at the time of its intervention only and within the limits of Client's instructions, if any. The Company's sole responsibility is to its Client and this document does not exonerate parties to a transaction from exercising all their rights and obligations under the transaction documents. This document cannot be reproduced except in full, without prior written approval of the Company. Any unauthorized alteration, forgery or falsification of the content or appearance of this document is unlawful and offenders may be prosecuted to the fullest extent of the law.



Above 1GHz

1GHz ~ 18GHz

Config_1_H

Site: SGS 966 Chamber B	Date: 2019/11/15	Time: 上午 07:15:26
Limit: FCC Class B 1G-18G(Peak)	Polarization: Horizontal	Temperature: 22 °C
Mode: Config 1	Power: AC 120/60Hz	Humidity: 65 %
Report: MH-2019-A0148	Distance: 3m	Air Pressure: 1014 hpa
Tester: Ken Chen		
Note: GSM 850		

SGS Taiwan Ltd.-Electronics & Communication Laboratory Address: No 2, Keji 1st Rd., Guishan District, Taoyuan City, Taiwan 333

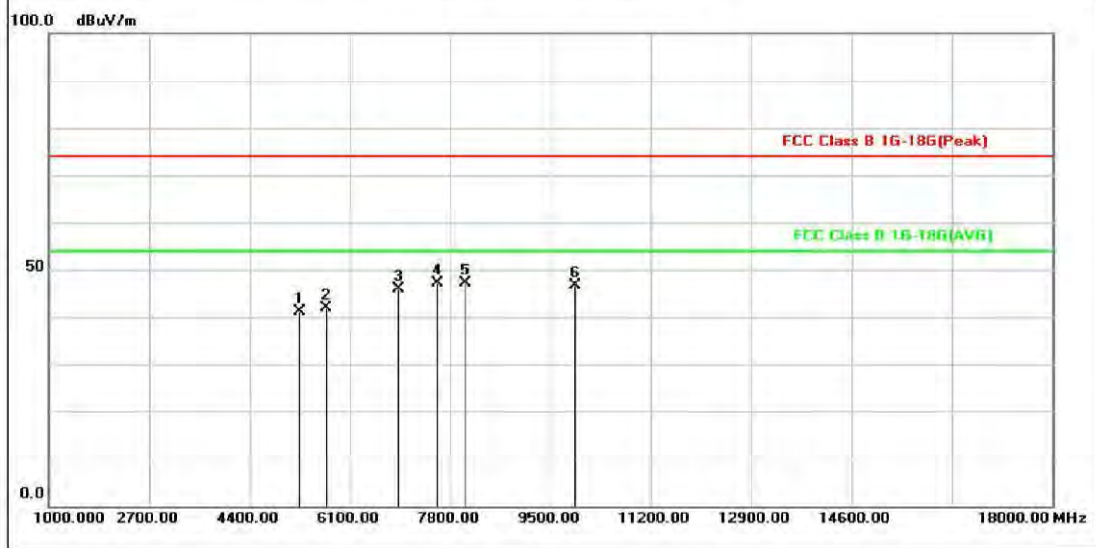

No.	Mk	Freq. (MHz)	Reading (dBuV)	Factor (dB/m)	Measurement (dBuV/m)	Limit (dBuV/m)	Over (dB)	Height (cm)	Degree (deg.)	Detector	Comment
1		5250.000	46.90	-5.85	41.05	74.00	-32.95			peak	
2		5709.000	47.00	-5.22	41.78	74.00	-32.22			peak	
3		6916.000	46.30	-0.45	45.85	74.00	-28.15			peak	
4	*	7579.000	45.80	1.29	47.09	74.00	-26.91	100	35	peak	
5		8055.000	44.66	2.43	47.09	74.00	-26.91			peak	
6		9908.000	42.97	3.55	46.52	74.00	-27.48			peak	

*:Maximum data x:Over limit !:over margin

Unless otherwise stated the results shown in this test report refer only to the sample(s) tested and such sample(s) are retained for 90 days only.

除非另有說明，此報告結果僅對測試之樣品負責，同時此樣品僅保留90天。本報告未經本公司書面許可，不可部份複製。

This document is issued by the Company subject to its General Conditions of Service printed overleaf, available on request or accessible at www.sgs.com/terms_and_conditions.htm and for electronic format documents, subject to Terms and Conditions for Electronic Documents at www.sgs.com/terms_e-document.htm. Attention is drawn to the limitation of liability, indemnification and jurisdiction issues defined therein. Any holder of this document is advised that information contained hereon reflects the Company's findings at the time of its intervention only and within the limits of Client's instructions, if any. The Company's sole responsibility is to its Client and this document does not exonerate parties to a transaction from exercising all their rights and obligations under the transaction documents. This document cannot be reproduced except in full, without prior written approval of the Company. Any unauthorized alteration, forgery or falsification of the content or appearance of this document is unlawful and offenders may be prosecuted to the fullest extent of the law.



Config_1_V

Site: SGS 966 Chamber B	Date: 2019/11/15	Time: 上午 06:58:40
Limit: FCC Class B 1G-18G(Peak)	Polarization: Vertical	Temperature: 22 °C
Mode: Config 1	Power: AC 120/60Hz	Humidity: 65 %
Report: MH-2019-A0148	Distance: 3m	Air Pressure: 1014 hpa
Tester: Ken Chen		
Note: GSM 850		

SGS Taiwan Ltd.-Electronics & Communication Laboratory Address: No.2, Kej 1st Rd., Guishan District, Taoyuan City, Taiwan 333

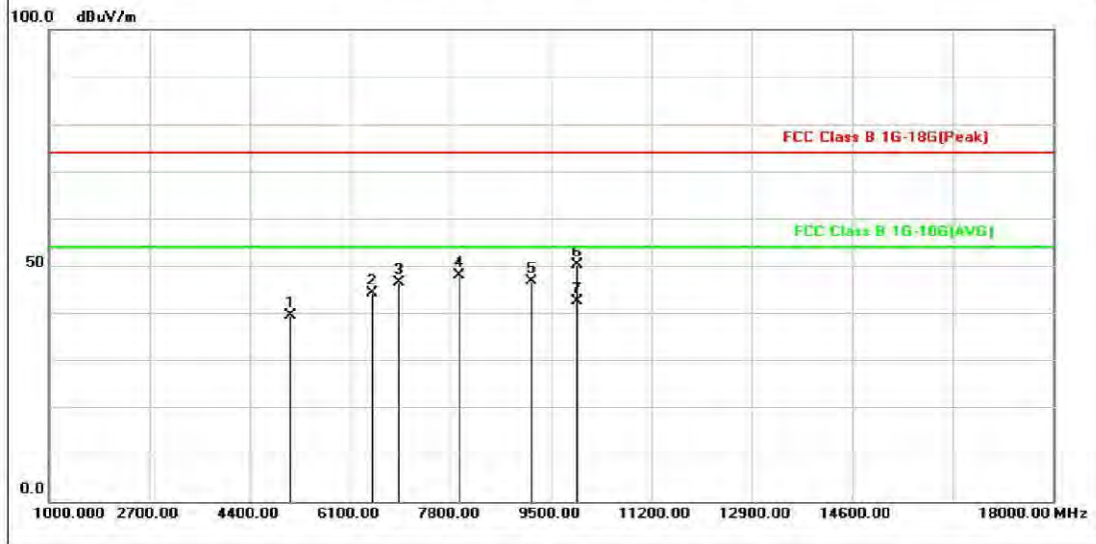

No.	Mk	Freq. (MHz)	Reading (dBuV)	Factor (dB/m)	Measurement (dBuV/m)	Limit (dBuV/m)	Over (dB)	Height (cm)	Degree (deg.)	Detector	Comment
1		5097.000	44.51	-5.13	39.38	74.00	-34.62			peak	
2		6474.000	46.41	-2.35	44.06	74.00	-29.94			peak	
3		6933.000	46.67	-0.35	46.32	74.00	-27.68			peak	
4		7953.000	45.50	2.47	47.97	74.00	-26.03			peak	
5		9160.000	45.35	1.38	46.73	74.00	-27.27			peak	
6		9942.000	46.61	3.42	50.03	74.00	-23.97	100	27	peak	
7	*	9942.000	39.08	3.42	42.50	54.00	-11.50	100	27	AVG	

*:Maximum data x:Over limit |:over margin

Unless otherwise stated the results shown in this test report refer only to the sample(s) tested and such sample(s) are retained for 90 days only.
 除非另有說明，此報告結果僅對測試之樣品負責，同時此樣品僅保留90天。本報告未經本公司書面許可，不可部份複製。
 This document is issued by the Company subject to its General Conditions of Service printed overleaf, available on request or accessible at www.sgs.com/terms_and_conditions.htm and for electronic format documents, subject to Terms and Conditions for Electronic Documents at www.sgs.com/terms_e-document.htm. Attention is drawn to the limitation of liability, indemnification and jurisdiction issues defined therein. Any holder of this document is advised that information contained hereon reflects the Company's findings at the time of its intervention only and within the limits of Client's instructions, if any. The Company's sole responsibility is to its Client and this document does not exonerate parties to a transaction from exercising all their rights and obligations under the transaction documents. This document cannot be reproduced except in full, without prior written approval of the Company. Any unauthorized alteration, forgery or falsification of the content or appearance of this document is unlawful and offenders may be prosecuted to the fullest extent of the law.

Config_2_H

Site: SGS 966 Chamber B	Date: 2019/11/15	Time: 上午 08:24:30
Limit: FCC Class B 1G-18G(Peak)	Polarization: Horizontal	Temperature: 22 °C
Mode: Config 2	Power: AC 120/60Hz	Humidity: 65 %
Report: MH-2019-A0148	Distance: 3m	Air Pressure: 1014 hpa
Tester: Ken Chen		
Note: Data External Read		

SGS Taiwan Ltd.-Electronics & Communication Laboratory Address: No.2, Kej 1st Rd., Guishan District, Taoyuan City, Taiwan 333

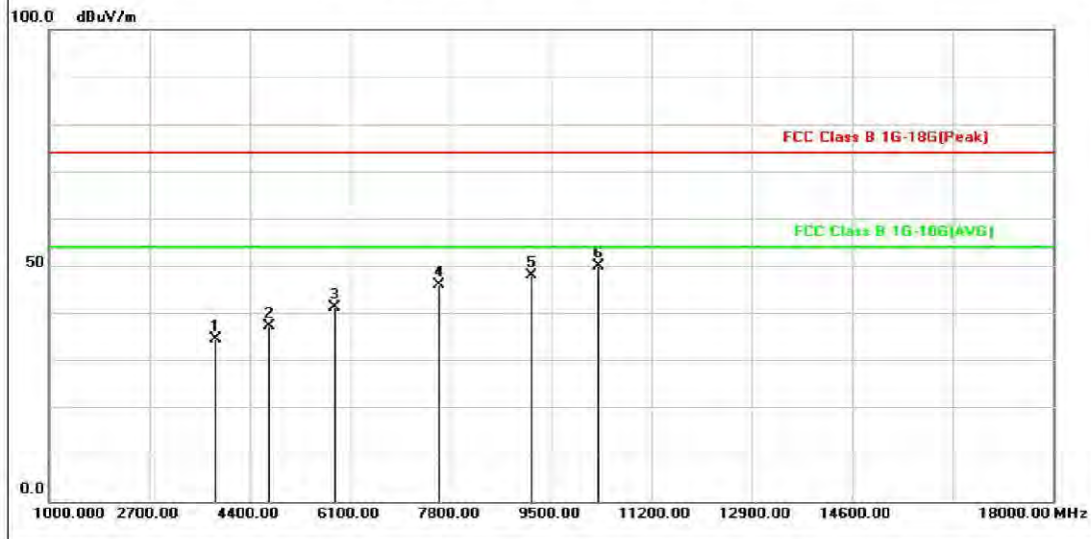

No.	Mk	Freq. (MHz)	Reading (dBuV)	Factor (dB/m)	Measurement (dBuV/m)	Limit (dBuV/m)	Over (dB)	Height (cm)	Degree (deg.)	Detector	Comment
1		3822.000	43.48	-9.00	34.48	74.00	-39.52			peak	
2		4723.000	44.49	-7.36	37.13	74.00	-36.87			peak	
3		5845.000	45.99	-4.78	41.21	74.00	-32.79			peak	
4		7613.000	44.37	1.51	45.88	74.00	-28.12			peak	
5		9177.000	44.26	3.68	47.94	74.00	-26.06			peak	
6	*	10299.000	43.93	5.90	49.83	74.00	-24.17	100	247	peak	

*:Maximum data x:Over limit l:over margin

Unless otherwise stated the results shown in this test report refer only to the sample(s) tested and such sample(s) are retained for 90 days only.

除非另有說明，此報告結果僅對測試之樣品負責，同時此樣品僅保留90天。本報告未經本公司書面許可，不可部份複製。

This document is issued by the Company subject to its General Conditions of Service printed overleaf, available on request or accessible at www.sgs.com/terms_and_conditions.htm and for electronic format documents, subject to Terms and Conditions for Electronic Documents at www.sgs.com/terms_e-document.htm. Attention is drawn to the limitation of liability, indemnification and jurisdiction issues defined therein. Any holder of this document is advised that information contained hereon reflects the Company's findings at the time of its intervention only and within the limits of Client's instructions, if any. The Company's sole responsibility is to its Client and this document does not exonerate parties to a transaction from exercising all their rights and obligations under the transaction documents. This document cannot be reproduced except in full, without prior written approval of the Company. Any unauthorized alteration, forgery or falsification of the content or appearance of this document is unlawful and offenders may be prosecuted to the fullest extent of the law.

Config_2_V

Site: SGS 966 Chamber B	Date: 2019/11/15	Time: 上午 07:48:10
Limit: FCC Class B 1G-18G(Peak)	Polarization: Vertical	Temperature: 22 °C
Mode: Config 2	Power: AC 120/60Hz	Humidity: 65 %
Report: MH-2019-A0148	Distance: 3m	Air Pressure: 1014 hpa
Tester: Ken Chen		
Note: Data External Read		

SGS Taiwan Ltd.-Electronics & Communication Laboratory Address: No.2, Keji 1st Rd., Guishan District, Taoyuan City, Taiwan 333

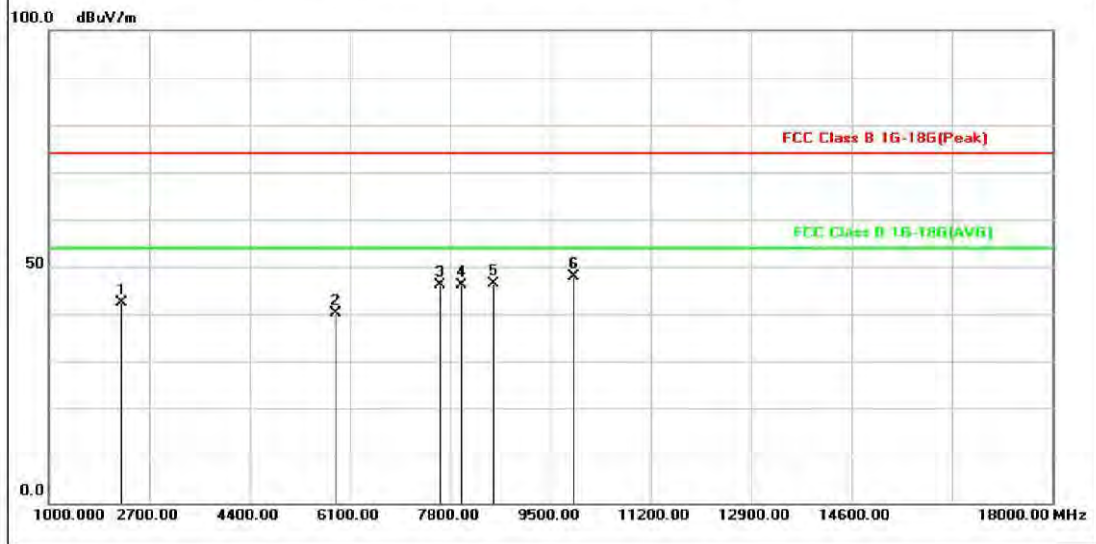

No.	Mk	Freq. (MHz)	Reading (dBuV)	Factor (dB/m)	Measurement (dBuV/m)	Limit (dBuV/m)	Over (dB)	Height (cm)	Degree (deg.)	Detector	Comment
1		2241.000	54.95	-12.46	42.49	74.00	-31.51			peak	
2		5862.000	44.78	-4.68	40.10	74.00	-33.90			peak	
3		7630.000	44.53	1.49	46.02	74.00	-27.98			peak	
4		7987.000	43.62	2.42	46.04	74.00	-27.96			peak	
5		8531.000	44.39	1.87	46.26	74.00	-27.74			peak	
6	*	9891.000	42.30	5.63	47.93	74.00	-26.07	100	210	peak	

*:Maximum data x:Over limit !:over margin

Unless otherwise stated the results shown in this test report refer only to the sample(s) tested and such sample(s) are retained for 90 days only.

除非另有說明，此報告結果僅對測試之樣品負責，同時此樣品僅保留90天。本報告未經本公司書面許可，不可部份複製。

This document is issued by the Company subject to its General Conditions of Service printed overleaf, available on request or accessible at www.sgs.com/terms_and_conditions.htm and for electronic format documents, subject to Terms and Conditions for Electronic Documents at www.sgs.com/terms_e-document.htm. Attention is drawn to the limitation of liability, indemnification and jurisdiction issues defined therein. Any holder of this document is advised that information contained hereon reflects the Company's findings at the time of its intervention only and within the limits of Client's instructions, if any. The Company's sole responsibility is to its Client and this document does not exonerate parties to a transaction from exercising all their rights and obligations under the transaction documents. This document cannot be reproduced except in full, without prior written approval of the Company. Any unauthorized alteration, forgery or falsification of the content or appearance of this document is unlawful and offenders may be prosecuted to the fullest extent of the law.

Config_3_H

Site: SGS 966 Chamber B	Date: 2019/11/15	Time: 上午 09:24:01
Limit: FCC Class B 1G-18G(Peak)	Polarization: Horizontal	Temperature: 22 °C
Mode: Config 3	Power: AC 120/60Hz	Humidity: 65 %
Report: MH-2019-A0148	Distance: 3m	Air Pressure: 1014 hpa
Tester: Ken Chen		
Note: REC mode(Front)		

SGS Taiwan Ltd.-Electronics & Communication Laboratory Address: No.2, Kej 1st Rd., Guishan District, Taoyuan City, Taiwan 333

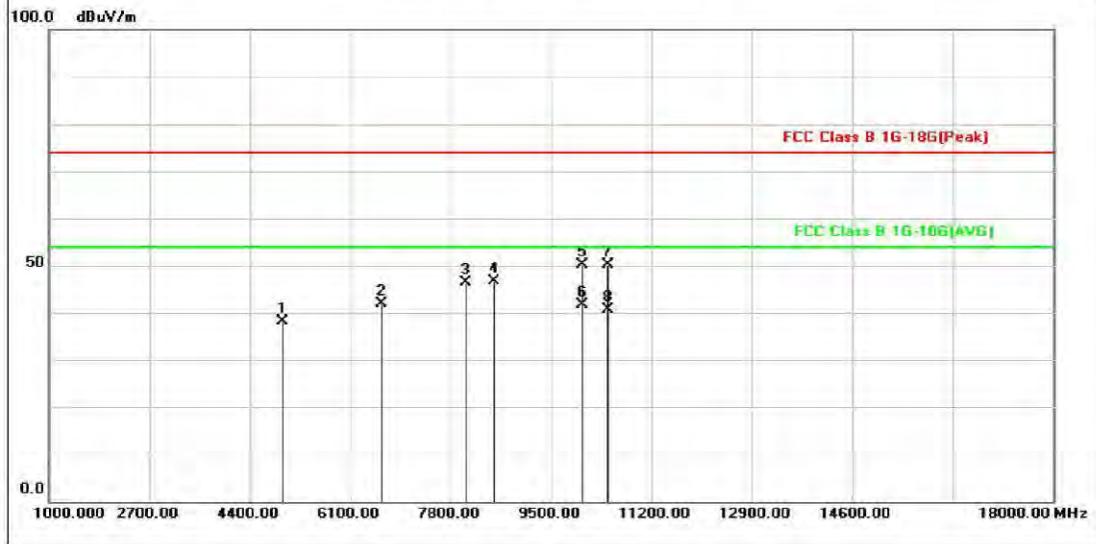

No.	Mk	Freq. (MHz)	Reading (dBuV)	Factor (dB/m)	Measurement (dBuV/m)	Limit (dBuV/m)	Over (dB)	Height (cm)	Degree (deg.)	Detector	Comment
1		4961.000	45.32	-7.17	38.15	74.00	-35.85			peak	
2		6627.000	43.94	-1.99	41.95	74.00	-32.05			peak	
3		8055.000	43.81	2.45	46.26	74.00	-27.74			peak	
4		8531.000	44.77	1.87	46.64	74.00	-27.36			peak	
5		10027.000	44.65	5.60	50.25	74.00	-23.75	100	240	peak	
6	*	10027.000	35.93	5.60	41.53	54.00	-12.47	100	240	AVG	
7		10469.000	43.62	6.50	50.12	74.00	-23.88			peak	
8		10469.000	34.20	6.50	40.70	54.00	-13.30			AVG	

*:Maximum data x:Over limit |:over margin

Unless otherwise stated the results shown in this test report refer only to the sample(s) tested and such sample(s) are retained for 90 days only.

除非另有說明，此報告結果僅對測試之樣品負責，同時此樣品僅保留90天。本報告未經本公司書面許可，不可部份複製。

This document is issued by the Company subject to its General Conditions of Service printed overleaf, available on request or accessible at www.sgs.com/terms_and_conditions.htm and for electronic format documents, subject to Terms and Conditions for Electronic Documents at www.sgs.com/terms_e-document.htm. Attention is drawn to the limitation of liability, indemnification and jurisdiction issues defined therein. Any holder of this document is advised that information contained hereon reflects the Company's findings at the time of its intervention only and within the limits of Client's instructions, if any. The Company's sole responsibility is to its Client and this document does not exonerate parties to a transaction from exercising all their rights and obligations under the transaction documents. This document cannot be reproduced except in full, without prior written approval of the Company. Any unauthorized alteration, forgery or falsification of the content or appearance of this document is unlawful and offenders may be prosecuted to the fullest extent of the law.



Config_3_V

Site: SGS 966 Chamber B	Date: 2019/11/15	Time: 上午 08:49:25
Limit: FCC Class B 1G-18G(Peak)	Polarization: Vertical	Temperature: 22 °C
Mode: Config 3	Power: AC 120/60Hz	Humidity: 65 %
Report: MH-2019-A0148	Distance: 3m	Air Pressure: 1014 hpa
Tester: Ken Chen		
Note: REC mode(Front)		

SGS Taiwan Ltd.-Electronics & Communication Laboratory Address: No.2, Keji 1st Rd., Guishan District, Taoyuan City, Taiwan 333

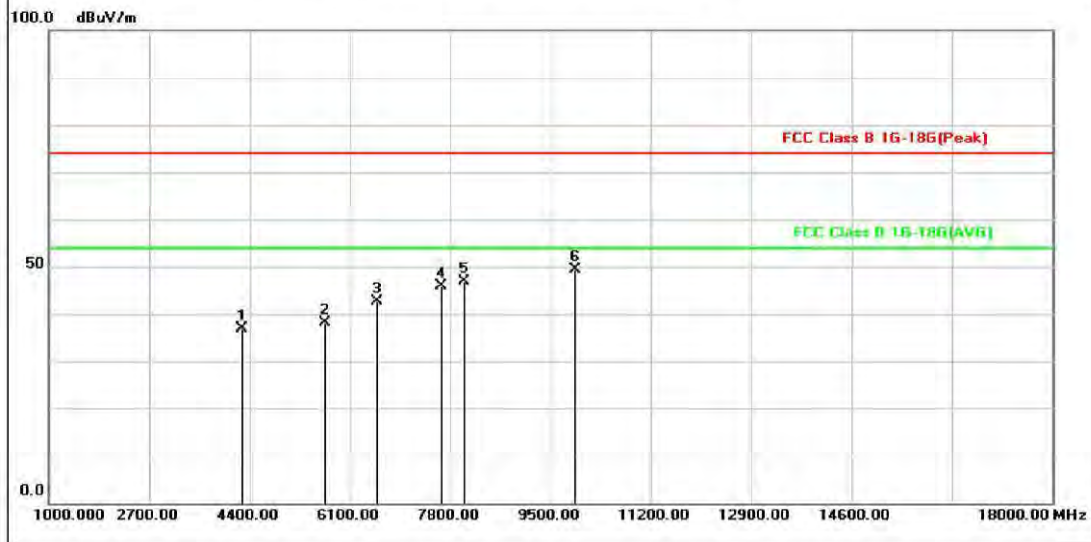

No.	Mk	Freq. (MHz)	Reading (dBuV)	Factor (dB/m)	Measurement (dBuV/m)	Limit (dBuV/m)	Over (dB)	Height (cm)	Degree (deg.)	Detector	Comment
1		4264.000	45.02	-8.19	36.83	74.00	-37.17			peak	
2		5675.000	43.69	-5.67	38.02	74.00	-35.98			peak	
3		6559.000	44.75	-2.13	42.62	74.00	-31.38			peak	
4		7647.000	44.51	1.47	45.98	74.00	-28.02			peak	
5		8038.000	44.43	2.47	46.90	74.00	-27.10			peak	
6	*	9925.000	43.73	5.59	49.32	74.00	-24.68	100	68	peak	

*:Maximum data x:Over limit !:over margin

Unless otherwise stated the results shown in this test report refer only to the sample(s) tested and such sample(s) are retained for 90 days only.

除非另有說明，此報告結果僅對測試之樣品負責，同時此樣品僅保留90天。本報告未經本公司書面許可，不可部份複製。

This document is issued by the Company subject to its General Conditions of Service printed overleaf, available on request or accessible at www.sgs.com/terms_and_conditions.htm and for electronic format documents, subject to Terms and Conditions for Electronic Documents at www.sgs.com/terms_e-document.htm. Attention is drawn to the limitation of liability, indemnification and jurisdiction issues defined therein. Any holder of this document is advised that information contained hereon reflects the Company's findings at the time of its intervention only and within the limits of Client's instructions, if any. The Company's sole responsibility is to its Client and this document does not exonerate parties to a transaction from exercising all their rights and obligations under the transaction documents. This document cannot be reproduced except in full, without prior written approval of the Company. Any unauthorized alteration, forgery or falsification of the content or appearance of this document is unlawful and offenders may be prosecuted to the fullest extent of the law.



Config_4_H

Site: SGS 966 Chamber B	Date: 2019/11/15	Time: 上午 10:19:02
Limit: FCC Class B 1G-18G(Peak)	Polarization: Horizontal	Temperature: 22 °C
Mode: Config 4	Power: AC 120/60Hz	Humidity: 65 %
Report: MH-2019-A0148	Distance: 3m	Air Pressure: 1014 hpa
Tester: Ken Chen		
Note: GSM 850		

SGS Taiwan Ltd. Electronics & Communication Laboratory Address: No 2, Keji 1st Rd., Guishan District, Taoyuan City, Taiwan 333

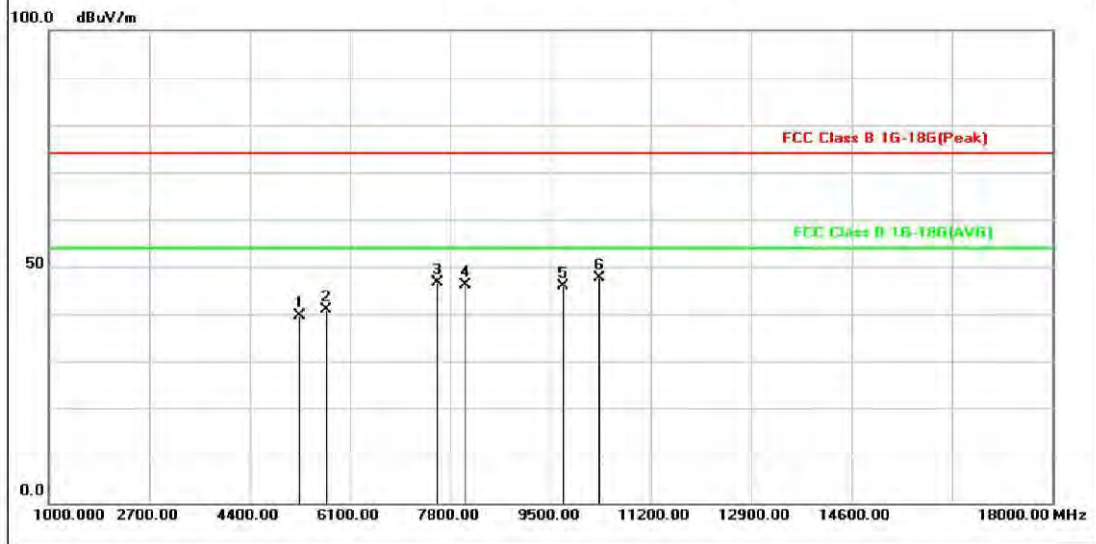

No.	Mk	Freq. (MHz)	Reading (dBuV)	Factor (dB/m)	Measurement (dBuV/m)	Limit (dBuV/m)	Over (dB)	Height (cm)	Degree (deg.)	Detector	Comment
1		5250.000	45.40	-5.85	39.55	74.00	-34.45			peak	
2		5709.000	46.00	-5.22	40.78	74.00	-33.22			peak	
3		7579.000	45.30	1.29	46.59	74.00	-27.41			peak	
4		8055.000	43.66	2.43	46.09	74.00	-27.91			peak	
5		9721.000	43.11	2.67	45.78	74.00	-28.22			peak	
6	*	10333.000	43.63	3.90	47.53	74.00	-26.47	100	57	peak	

*:Maximum data x:Over limit !:over margin

Unless otherwise stated the results shown in this test report refer only to the sample(s) tested and such sample(s) are retained for 90 days only.

除非另有說明，此報告結果僅對測試之樣品負責，同時此樣品僅保留90天。本報告未經本公司書面許可，不可部份複製。

This document is issued by the Company subject to its General Conditions of Service printed overleaf, available on request or accessible at www.sgs.com/terms_and_conditions.htm and for electronic format documents, subject to Terms and Conditions for Electronic Documents at www.sgs.com/terms_e-document.htm. Attention is drawn to the limitation of liability, indemnification and jurisdiction issues defined therein. Any holder of this document is advised that information contained hereon reflects the Company's findings at the time of its intervention only and within the limits of Client's instructions, if any. The Company's sole responsibility is to its Client and this document does not exonerate parties to a transaction from exercising all their rights and obligations under the transaction documents. This document cannot be reproduced except in full, without prior written approval of the Company. Any unauthorized alteration, forgery or falsification of the content or appearance of this document is unlawful and offenders may be prosecuted to the fullest extent of the law.

Config_4_V

Site: SGS 966 Chamber B	Date: 2019/11/15	Time: 上午 09:49:50
Limit: FCC Class B 1G-18G(Peak)	Polarization: Vertical	Temperature: 22 °C
Mode: Config 4	Power: AC 120/60Hz	Humidity: 65 %
Report: MH-2019-A0148	Distance: 3m	Air Pressure: 1014 hpa
Tester: Ken Chen		
Note: GSM 850		

SGS Taiwan Ltd.-Electronics & Communication Laboratory Address: No.2, Kej 1st Rd., Guishan District, Taoyuan City, Taiwan 333

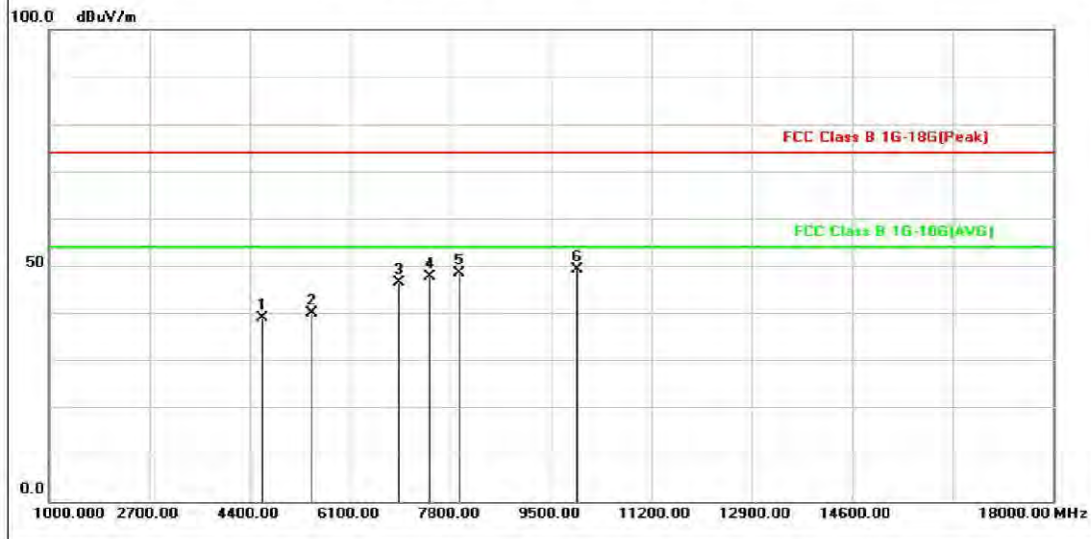

No.	Mk	Freq. (MHz)	Reading (dBuV)	Factor (dB/m)	Measurement (dBuV/m)	Limit (dBuV/m)	Over (dB)	Height (cm)	Degree (deg.)	Detector	Comment
1		4621.000	45.27	-6.49	38.78	74.00	-35.22			peak	
2		5454.000	45.46	-5.48	39.98	74.00	-34.02			peak	
3		6933.000	46.67	-0.35	46.32	74.00	-27.68			peak	
4		7443.000	46.22	1.29	47.51	74.00	-26.49			peak	
5		7953.000	46.00	2.47	48.47	74.00	-25.53			peak	
6	*	9942.000	45.61	3.42	49.03	74.00	-24.97	100	28	peak	

*:Maximum data x:Over limit |:over margin

Unless otherwise stated the results shown in this test report refer only to the sample(s) tested and such sample(s) are retained for 90 days only.

除非另有說明，此報告結果僅對測試之樣品負責，同時此樣品僅保留90天。本報告未經本公司書面許可，不可部份複製。

This document is issued by the Company subject to its General Conditions of Service printed overleaf, available on request or accessible at www.sgs.com/terms_and_conditions.htm and for electronic format documents, subject to Terms and Conditions for Electronic Documents at www.sgs.com/terms_e-document.htm. Attention is drawn to the limitation of liability, indemnification and jurisdiction issues defined therein. Any holder of this document is advised that information contained hereon reflects the Company's findings at the time of its intervention only and within the limits of Client's instructions, if any. The Company's sole responsibility is to its Client and this document does not exonerate parties to a transaction from exercising all their rights and obligations under the transaction documents. This document cannot be reproduced except in full, without prior written approval of the Company. Any unauthorized alteration, forgery or falsification of the content or appearance of this document is unlawful and offenders may be prosecuted to the fullest extent of the law.

18GHz ~ 40GHz

Config_1_H

Site: SGS 966 Chamber A	Date: 2019/11/20	Time: 下午 04:58:10
Limit: FCC Class B 18G-40G(Peak)	Polarization: Horizontal	Temperature: 22 °C
Mode: Config 1	Power: AC 120V/60Hz	Humidity: 59 %
Report: MH-2019-A0148	Distance: 1m	Air Pressure: 995 hpa
Tester: Boris Liao		
Note: GSM 850		

SGS Taiwan Ltd.-Electronics & Communication Laboratory Address: No.2, Keji 1st Rd., Guishan District, Taoyuan City, Taiwan 333

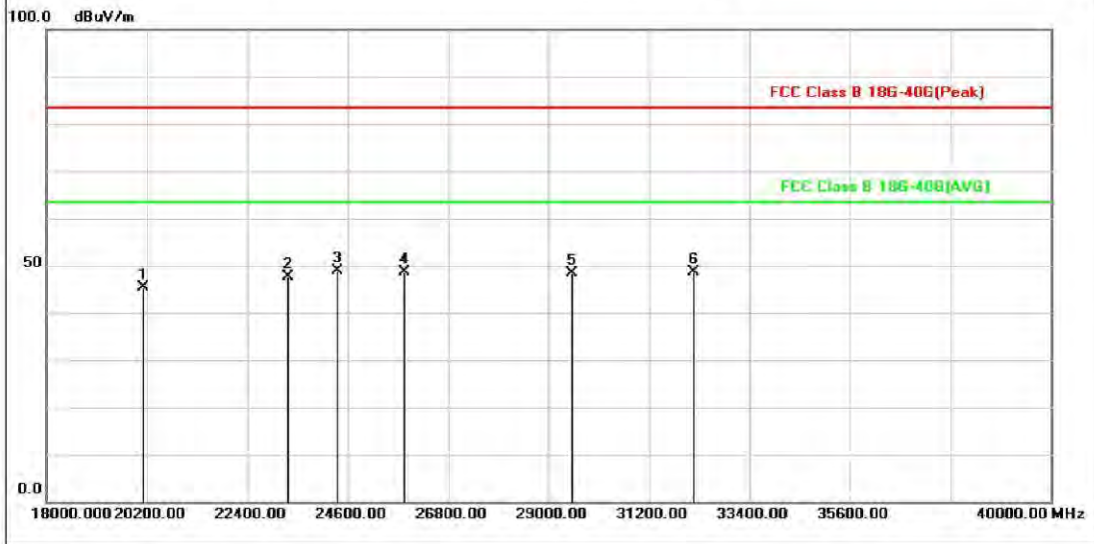

No.	Mk	Freq. (MHz)	Reading (dBuV)	Factor (dB/m)	Measurement (dBuV/m)	Limit (dBuV/m)	Over (dB)	Height (cm)	Degree (deg.)	Detector	Comment
1		20112.000	44.10	1.29	45.39	83.50	-38.11			peak	
2		23302.000	44.06	3.50	47.56	83.50	-35.94			peak	
3	*	24380.000	44.26	4.53	48.79	83.50	-34.71	100	287	peak	
4		25854.000	44.36	4.28	48.64	83.50	-34.86			peak	
5		29506.000	44.14	4.20	48.34	83.50	-35.16			peak	
6		32190.000	42.00	6.74	48.74	83.50	-34.76			peak	

*:Maximum data x:Over limit !:over margin

Unless otherwise stated the results shown in this test report refer only to the sample(s) tested and such sample(s) are retained for 90 days only.

除非另有說明，此報告結果僅對測試之樣品負責，同時此樣品僅保留90天。本報告未經本公司書面許可，不可部份複製。

This document is issued by the Company subject to its General Conditions of Service printed overleaf, available on request or accessible at www.sgs.com/terms_and_conditions.htm and for electronic format documents, subject to Terms and Conditions for Electronic Documents at www.sgs.com/terms_e-document.htm. Attention is drawn to the limitation of liability, indemnification and jurisdiction issues defined therein. Any holder of this document is advised that information contained hereon reflects the Company's findings at the time of its intervention only and within the limits of Client's instructions, if any. The Company's sole responsibility is to its Client and this document does not exonerate parties to a transaction from exercising all their rights and obligations under the transaction documents. This document cannot be reproduced except in full, without prior written approval of the Company. Any unauthorized alteration, forgery or falsification of the content or appearance of this document is unlawful and offenders may be prosecuted to the fullest extent of the law.

Config_1_V

Site: SGS 966 Chamber A	Date: 2019/11/20	Time: 下午 04:50:55
Limit: FCC Class B 18G-40G(Peak)	Polarization: Vertical	Temperature: 22 °C
Mode: Config 1	Power: AC 120V/60Hz	Humidity: 59 %
Report: MH-2019-A0148	Distance: 1m	Air Pressure: 995 hpa
Tester: Boris Liao		
Note: GSM 850		

SGS Taiwan Ltd.-Electronics & Communication Laboratory Address: No.2, Keji 1st Rd., Guishan District, Taoyuan City, Taiwan 333

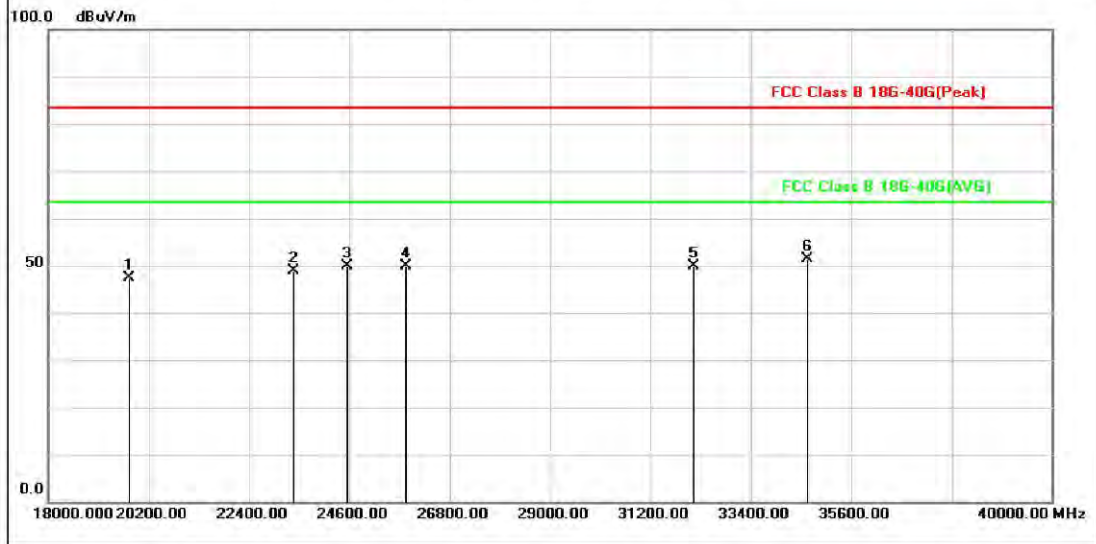

No.	Mk	Freq (MHz)	Reading (dBuV)	Factor (dB/m)	Measurement (dBuV/m)	Limit (dBuV/m)	Over (dB)	Height (cm)	Degree (deg.)	Detector	Comment
1		19760.000	46.44	1.06	47.50	83.50	-36.00			peak	
2		23390.000	45.28	3.59	48.87	83.50	-34.63			peak	
3		24556.000	45.01	4.77	49.78	83.50	-33.72			peak	
4		25832.000	45.57	4.26	49.83	83.50	-33.67			peak	
5		32146.000	43.15	6.80	49.95	83.50	-33.55			peak	
6	*	34654.000	43.84	7.43	51.27	83.50	-32.23	100	201	peak	

*:Maximum data x:Over limit !:over margin

Unless otherwise stated the results shown in this test report refer only to the sample(s) tested and such sample(s) are retained for 90 days only.
 除非另有說明，此報告結果僅對測試之樣品負責，同時此樣品僅保留90天。本報告未經本公司書面許可，不可部份複製。
 This document is issued by the Company subject to its General Conditions of Service printed overleaf, available on request or accessible at www.sgs.com/terms_and_conditions.htm and for electronic format documents, subject to Terms and Conditions for Electronic Documents at www.sgs.com/terms_e-document.htm. Attention is drawn to the limitation of liability, indemnification and jurisdiction issues defined therein. Any holder of this document is advised that information contained hereon reflects the Company's findings at the time of its intervention only and within the limits of Client's instructions, if any. The Company's sole responsibility is to its Client and this document does not exonerate parties to a transaction from exercising all their rights and obligations under the transaction documents. This document cannot be reproduced except in full, without prior written approval of the Company. Any unauthorized alteration, forgery or falsification of the content or appearance of this document is unlawful and offenders may be prosecuted to the fullest extent of the law.



Config_2_H

Site: SGS 966 Chamber A	Date: 2019/11/20	Time: 下午 05:09:36
Limit: FCC Class B 18G-40G(Peak)	Polarization: Horizontal	Temperature: 22 °C
Mode: Config 2	Power: From System	Humidity: 59 %
Report: MH-2019-A0148	Distance: 1m	Air Pressure: 995 hpa
Tester: Boris Liao		
Note: Data External Read		

SGS Taiwan Ltd.-Electronics & Communication Laboratory Address: No.2, Keji 1st Rd., Guishan District, Taoyuan City, Taiwan 333

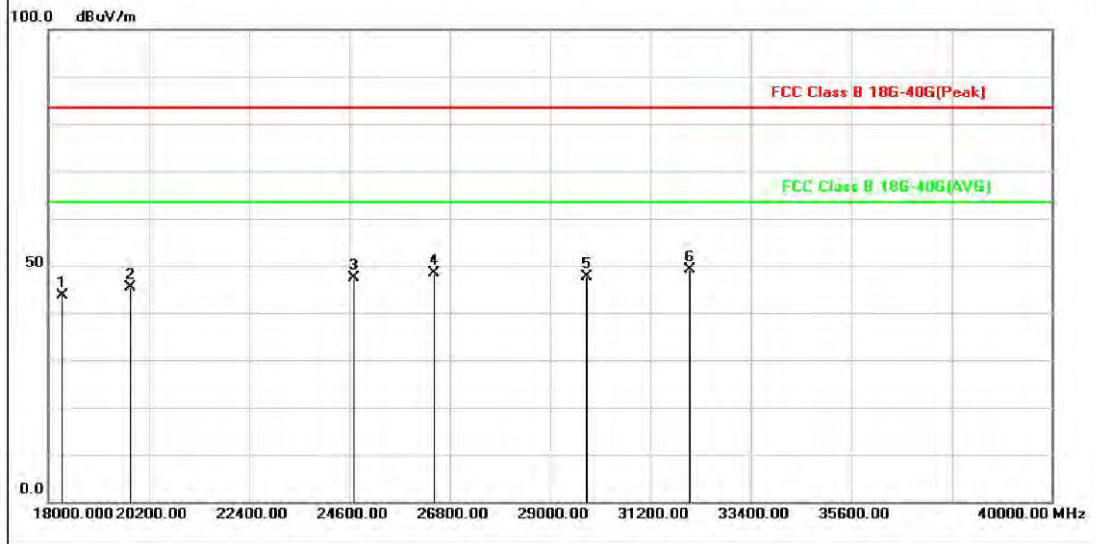

No.	Mk	Freq (MHz)	Reading (dBuV)	Factor (dB/m)	Measurement (dBuV/m)	Limit (dBuV/m)	Over (dB)	Height (cm)	Degree (deg.)	Detector	Comment
1		18308.000	44.14	-0.61	43.53	83.50	-39.97			peak	
2		19804.000	44.23	1.13	45.36	83.50	-38.14			peak	
3		24688.000	42.80	4.68	47.48	83.50	-36.02			peak	
4		26448.000	44.36	3.95	48.31	83.50	-35.19			peak	
5		29792.000	43.41	4.32	47.73	83.50	-35.77			peak	
6	*	32058.000	42.32	6.91	49.23	83.50	-34.27	105	274	peak	

*:Maximum data x:Over limit !:over margin

Unless otherwise stated the results shown in this test report refer only to the sample(s) tested and such sample(s) are retained for 90 days only.

除非另有說明，此報告結果僅對測試之樣品負責，同時此樣品僅保留90天。本報告未經本公司書面許可，不可部份複製。

This document is issued by the Company subject to its General Conditions of Service printed overleaf, available on request or accessible at www.sgs.com/terms_and_conditions.htm and for electronic format documents, subject to Terms and Conditions for Electronic Documents at www.sgs.com/terms_e-document.htm. Attention is drawn to the limitation of liability, indemnification and jurisdiction issues defined therein. Any holder of this document is advised that information contained hereon reflects the Company's findings at the time of its intervention only and within the limits of Client's instructions, if any. The Company's sole responsibility is to its Client and this document does not exonerate parties to a transaction from exercising all their rights and obligations under the transaction documents. This document cannot be reproduced except in full, without prior written approval of the Company. Any unauthorized alteration, forgery or falsification of the content or appearance of this document is unlawful and offenders may be prosecuted to the fullest extent of the law.



Config_2_V

Site: SGS 966 Chamber A	Date: 2019/11/20	Time: 下午 05:17:23
Limit: FCC Class B 18G-40G(Peak)	Polarization: Vertical	Temperature: 22 °C
Mode: Config 2	Power: From System	Humidity: 59 %
Report: MH-2019-A0148	Distance: 1m	Air Pressure: 995 hpa
Tester: Boris Liao		
Note: Data External Read		

SGS Taiwan Ltd.-Electronics & Communication Laboratory Address: No.2, Keji 1st Rd., Guishan District, Taoyuan City, Taiwan 333

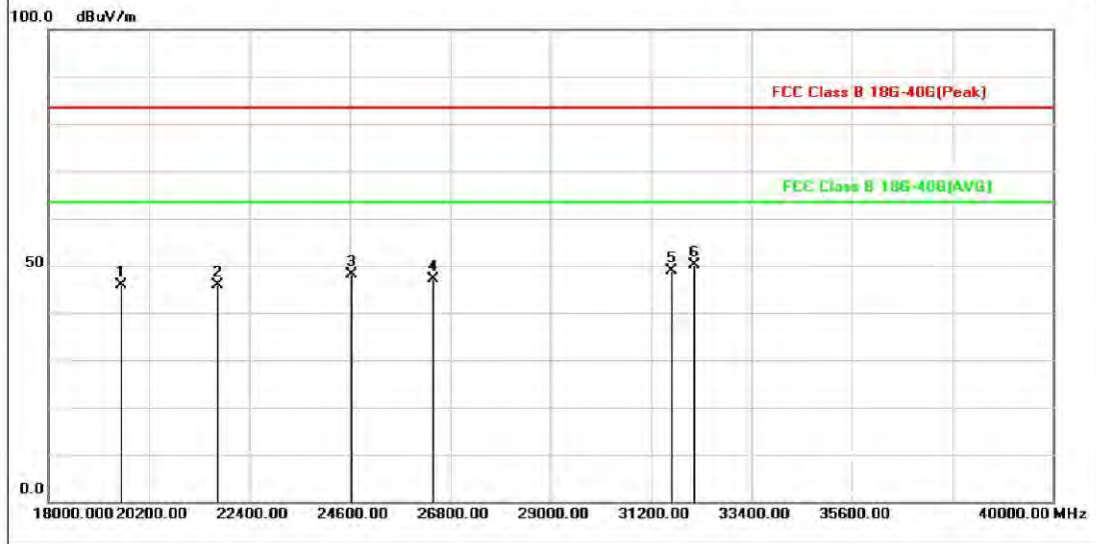

No.	Mk	Freq. (MHz)	Reading (dBuV)	Factor (dB/m)	Measurement (dBuV/m)	Limit (dBuV/m)	Over (dB)	Height (cm)	Degree (deg.)	Detector	Comment
1		19584.000	44.99	0.81	45.80	83.50	-37.70			peak	
2		21718.000	43.46	2.35	45.81	83.50	-37.69			peak	
3		24644.000	43.30	4.71	48.01	83.50	-35.49			peak	
4		26426.000	43.12	3.97	47.09	83.50	-36.41			peak	
5		31662.000	42.73	6.13	48.86	83.50	-34.64			peak	
6	*	32146.000	43.35	6.80	50.15	83.50	-33.35	103	241	peak	

*:Maximum data x:Over limit !:over margin

Unless otherwise stated the results shown in this test report refer only to the sample(s) tested and such sample(s) are retained for 90 days only.

除非另有說明，此報告結果僅對測試之樣品負責，同時此樣品僅保留90天。本報告未經本公司書面許可，不可部份複製。

This document is issued by the Company subject to its General Conditions of Service printed overleaf, available on request or accessible at www.sgs.com/terms_and_conditions.htm and for electronic format documents, subject to Terms and Conditions for Electronic Documents at www.sgs.com/terms_e-document.htm. Attention is drawn to the limitation of liability, indemnification and jurisdiction issues defined therein. Any holder of this document is advised that information contained hereon reflects the Company's findings at the time of its intervention only and within the limits of Client's instructions, if any. The Company's sole responsibility is to its Client and this document does not exonerate parties to a transaction from exercising all their rights and obligations under the transaction documents. This document cannot be reproduced except in full, without prior written approval of the Company. Any unauthorized alteration, forgery or falsification of the content or appearance of this document is unlawful and offenders may be prosecuted to the fullest extent of the law.

Config_3_H

Site: SGS 966 Chamber A	Date: 2019/11/20	Time: 下午 05:40:16
Limit: FCC Class B 18G-40G(Peak)	Polarization: Horizontal	Temperature: 22 °C
Mode: Config 3	Power: AC 120V/60Hz	Humidity: 59 %
Report: MH-2019-A0148	Distance: 1m	Air Pressure: 995 hpa
Tester: Boris Liao		
Note: REC Mode(Front)		

SGS Taiwan Ltd.-Electronics & Communication Laboratory Address: No.2, Keji 1st Rd., Guishan District, Taoyuan City, Taiwan 333

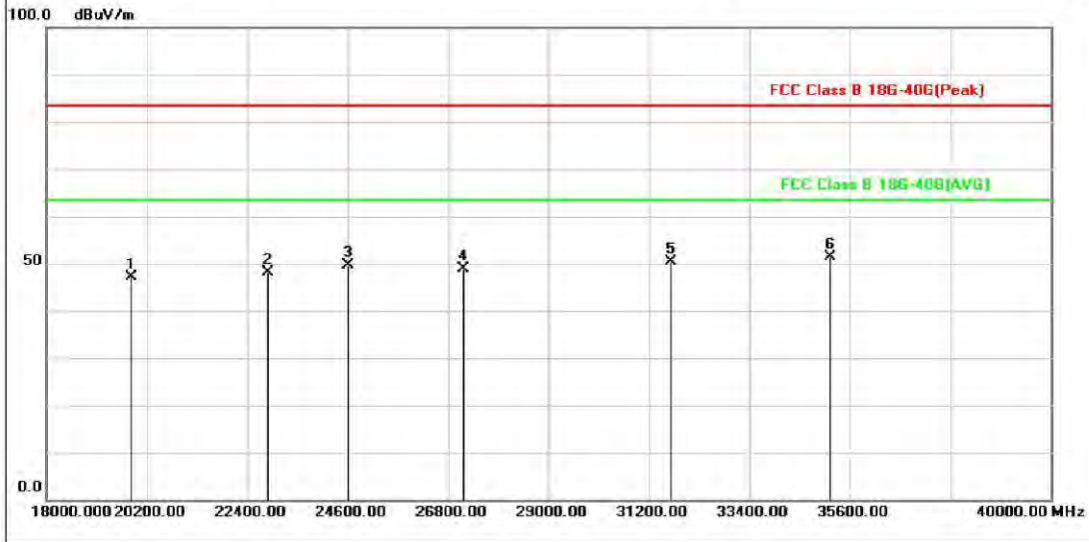

No.	Mk	Freq. (MHz)	Reading (dBuV)	Factor (dB/m)	Measurement (dBuV/m)	Limit (dBuV/m)	Over (dB)	Height (cm)	Degree (deg.)	Detector	Comment
1		19848.000	46.01	1.19	47.20	83.50	-36.30			peak	
2		22840.000	44.79	3.24	48.03	83.50	-35.47			peak	
3		24622.000	44.94	4.72	49.66	83.50	-33.84			peak	
4		27130.000	44.77	4.21	48.98	83.50	-34.52			peak	
5		31684.000	44.18	6.18	50.36	83.50	-33.14			peak	
6	*	35160.000	43.72	7.75	51.47	83.50	-32.03	100	320	peak	

*:Maximum data x:Over limit !:over margin

Unless otherwise stated the results shown in this test report refer only to the sample(s) tested and such sample(s) are retained for 90 days only.

除非另有說明，此報告結果僅對測試之樣品負責，同時此樣品僅保留90天。本報告未經本公司書面許可，不可部份複製。

This document is issued by the Company subject to its General Conditions of Service printed overleaf, available on request or accessible at www.sgs.com/terms_and_conditions.htm and for electronic format documents, subject to Terms and Conditions for Electronic Documents at www.sgs.com/terms_e-document.htm. Attention is drawn to the limitation of liability, indemnification and jurisdiction issues defined therein. Any holder of this document is advised that information contained hereon reflects the Company's findings at the time of its intervention only and within the limits of Client's instructions, if any. The Company's sole responsibility is to its Client and this document does not exonerate parties to a transaction from exercising all their rights and obligations under the transaction documents. This document cannot be reproduced except in full, without prior written approval of the Company. Any unauthorized alteration, forgery or falsification of the content or appearance of this document is unlawful and offenders may be prosecuted to the fullest extent of the law.



Config_3_V

Site: SGS 966 Chamber A	Date: 2019/11/20	Time: 下午 05:28:25
Limit: FCC Class B 18G-40G(Peak)	Polarization: Vertical	Temperature: 22 °C
Mode: Config 3	Power: AC 120V/60Hz	Humidity: 59 %
Report: MH-2019-A0148	Distance: 1m	Air Pressure: 995 hpa
Tester: Boris Liao		
Note: REC Mode(Front)		

SGS Taiwan Ltd.-Electronics & Communication Laboratory Address: No.2, Keji 1st Rd., Guishan District, Taoyuan City, Taiwan 333

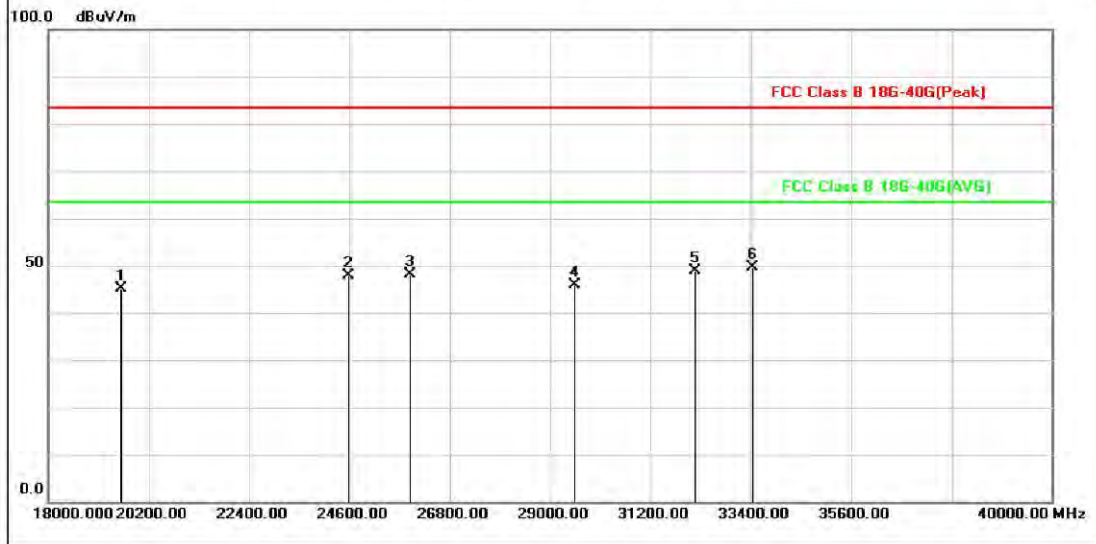

No.	Mk	Freq (MHz)	Reading (dBuV)	Factor (dB/m)	Measurement (dBuV/m)	Limit (dBuV/m)	Over (dB)	Height (cm)	Degree (deg.)	Detector	Comment
1		19606.000	44.38	0.85	45.23	83.50	-38.27			peak	
2		24578.000	43.22	4.76	47.98	83.50	-35.52			peak	
3		25920.000	43.71	4.34	48.05	83.50	-35.45			peak	
4		29528.000	41.67	4.21	45.88	83.50	-37.62			peak	
5		32168.000	42.22	6.76	48.98	83.50	-34.52			peak	
6	*	33444.000	42.69	6.87	49.56	83.50	-33.94	106	305	peak	

*:Maximum data x:Over limit !:over margin

Unless otherwise stated the results shown in this test report refer only to the sample(s) tested and such sample(s) are retained for 90 days only.
 除非另有說明，此報告結果僅對測試之樣品負責，同時此樣品僅保留90天。本報告未經本公司書面許可，不可部份複製。
 This document is issued by the Company subject to its General Conditions of Service printed overleaf, available on request or accessible at www.sgs.com/terms_and_conditions.htm and for electronic format documents, subject to Terms and Conditions for Electronic Documents at www.sgs.com/terms_e-document.htm. Attention is drawn to the limitation of liability, indemnification and jurisdiction issues defined therein. Any holder of this document is advised that information contained hereon reflects the Company's findings at the time of its intervention only and within the limits of Client's instructions, if any. The Company's sole responsibility is to its Client and this document does not exonerate parties to a transaction from exercising all their rights and obligations under the transaction documents. This document cannot be reproduced except in full, without prior written approval of the Company. Any unauthorized alteration, forgery or falsification of the content or appearance of this document is unlawful and offenders may be prosecuted to the fullest extent of the law.

Config_4_H

Site: SGS 966 Chamber A	Date: 2019/11/20	Time: 下午 05:50:38
Limit: FCC Class B 18G-40G(Peak)	Polarization: Horizontal	Temperature: 22 °C
Mode: Config 4	Power: AC 120V/60Hz	Humidity: 59 %
Report: MH-2019-A0148	Distance: 1m	Air Pressure: 995 hpa
Tester: Boris Liao		
Note: GSM 850		

SGS Taiwan Ltd.-Electronics & Communication Laboratory Address: No.2, Keji 1st Rd., Guishan District, Taoyuan City, Taiwan 333

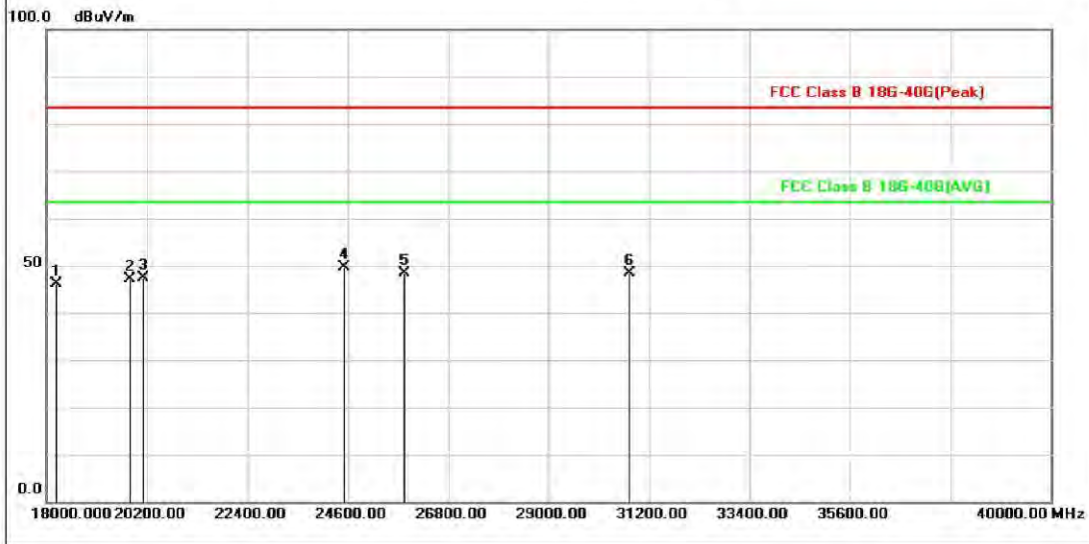

No.	Mk	Freq. (MHz)	Reading (dBuV)	Factor (dB/m)	Measurement (dBuV/m)	Limit (dBuV/m)	Over (dB)	Height (cm)	Degree (deg.)	Detector	Comment
1		18220.000	46.70	-0.52	46.18	83.50	-37.32			peak	
2		19826.000	46.10	1.15	47.25	83.50	-36.25			peak	
3		20134.000	46.05	1.26	47.31	83.50	-36.19			peak	
4	*	24512.000	44.88	4.80	49.68	83.50	-33.82	105	198	peak	
5		25854.000	44.14	4.28	48.42	83.50	-35.08			peak	
6		30782.000	43.97	4.42	48.39	83.50	-35.11			peak	

*:Maximum data x:Over limit !:over margin

Unless otherwise stated the results shown in this test report refer only to the sample(s) tested and such sample(s) are retained for 90 days only.

除非另有說明，此報告結果僅對測試之樣品負責，同時此樣品僅保留90天。本報告未經本公司書面許可，不可部份複製。

This document is issued by the Company subject to its General Conditions of Service printed overleaf, available on request or accessible at www.sgs.com/terms_and_conditions.htm and for electronic format documents, subject to Terms and Conditions for Electronic Documents at www.sgs.com/terms_e-document.htm. Attention is drawn to the limitation of liability, indemnification and jurisdiction issues defined therein. Any holder of this document is advised that information contained hereon reflects the Company's findings at the time of its intervention only and within the limits of Client's instructions, if any. The Company's sole responsibility is to its Client and this document does not exonerate parties to a transaction from exercising all their rights and obligations under the transaction documents. This document cannot be reproduced except in full, without prior written approval of the Company. Any unauthorized alteration, forgery or falsification of the content or appearance of this document is unlawful and offenders may be prosecuted to the fullest extent of the law.



Config_4_V

Site: SGS 966 Chamber A	Date: 2019/11/20	Time: 下午 05:59:45
Limit: FCC Class B 18G-40G(Peak)	Polarization: Vertical	Temperature: 22 °C
Mode: Config 4	Power: AC 120V/60Hz	Humidity: 59 %
Report: MH-2019-A0148	Distance: 1m	Air Pressure: 995 hpa
Tester: Boris Liao		
Note: GSM 850		

SGS Taiwan Ltd.-Electronics & Communication Laboratory Address: No.2, Keji 1st Rd., Guishan District, Taoyuan City, Taiwan 333

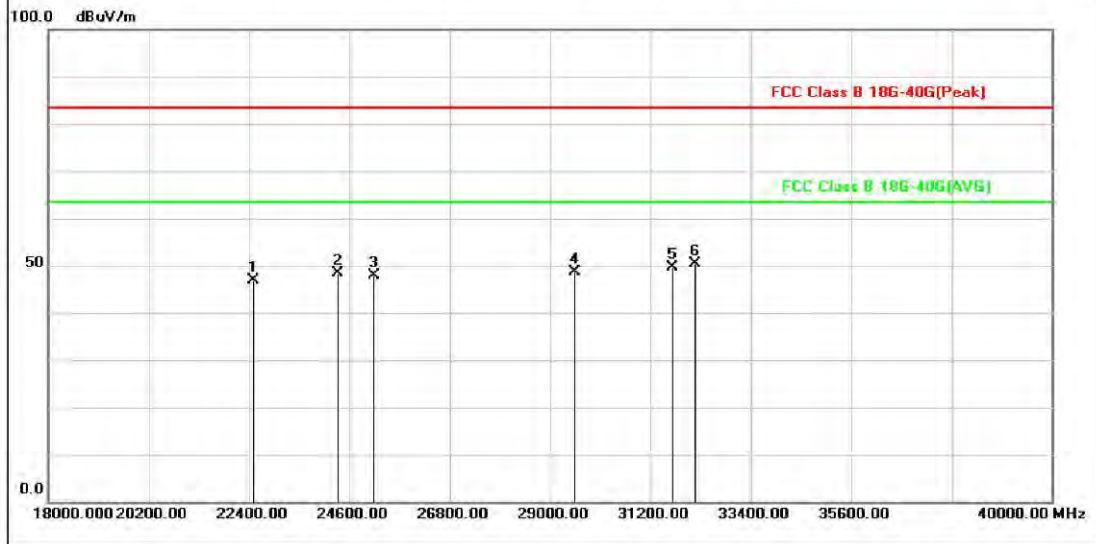

No.	Mk	Freq (MHz)	Reading (dBuV)	Factor (dB/m)	Measurement (dBuV/m)	Limit (dBuV/m)	Over (dB)	Height (cm)	Degree (deg.)	Detector	Comment
1		22488.000	43.61	3.28	46.89	83.50	-36.61			peak	
2		24358.000	43.97	4.48	48.45	83.50	-35.05			peak	
3		25128.000	43.49	4.37	47.86	83.50	-35.64			peak	
4		29528.000	44.32	4.21	48.53	83.50	-34.97			peak	
5		31684.000	43.46	6.18	49.64	83.50	-33.86			peak	
6	*	32168.000	43.62	6.76	50.38	83.50	-33.12	100	288	peak	

*:Maximum data x:Over limit !:over margin

Unless otherwise stated the results shown in this test report refer only to the sample(s) tested and such sample(s) are retained for 90 days only.

除非另有說明，此報告結果僅對測試之樣品負責，同時此樣品僅保留90天。本報告未經本公司書面許可，不可部份複製。

This document is issued by the Company subject to its General Conditions of Service printed overleaf, available on request or accessible at www.sgs.com/terms_and_conditions.htm and for electronic format documents, subject to Terms and Conditions for Electronic Documents at www.sgs.com/terms_e-document.htm. Attention is drawn to the limitation of liability, indemnification and jurisdiction issues defined therein. Any holder of this document is advised that information contained hereon reflects the Company's findings at the time of its intervention only and within the limits of Client's instructions, if any. The Company's sole responsibility is to its Client and this document does not exonerate parties to a transaction from exercising all their rights and obligations under the transaction documents. This document cannot be reproduced except in full, without prior written approval of the Company. Any unauthorized alteration, forgery or falsification of the content or appearance of this document is unlawful and offenders may be prosecuted to the fullest extent of the law.