



FCC RADIO TEST REPORT

FCC ID : APYHRO00276
Equipment : Smart phone
Brand Name : SHARP
Applicant : SHARP CORPORATION
2-13-1, Hachihonmatsu-lida, Higashi-hiroshima-shi,
Hiroshima pref. 739-0192, Japan
Manufacturer : SHARP CORPORATION
1 Takumi-Cho, Sakai-Ku, Sakai-Shi, Osaka 590-8522, Japan
Standard : 47 CFR Part 2, 22(H), 24(E)

The product was received on Jul. 16, 2019 and testing was started from Jul. 25, 2019 and completed on Aug. 06, 2019. We, SPORTON INTERNATIONAL INC. EMC & Wireless Communications Laboratory, would like to declare that the tested sample has been evaluated in accordance with the test procedures given in ANSI / TIA-603-E and has been in compliance with the applicable technical standards.

The report must not be used by the client to claim product certification, approval, or endorsement by TAF or any agency of government.

The test results in this report apply exclusively to the tested model / sample. Without written approval of SPORTON INTERNATIONAL INC. EMC & Wireless Communications Laboratory, the test report shall not be reproduced except in full.

Louis Wu

Approved by: Louis Wu

SPORTON INTERNATIONAL INC. EMC & Wireless Communications Laboratory

No. 52, Huaya 1st Rd., Guishan Dist., Taoyuan City, Taiwan (R.O.C.)



Table of Contents

History of this test report.....3

Summary of Test Result.....4

1 General Description5

 1.1 Product Feature of Equipment Under Test5

 1.2 Modification of EUT5

 1.3 Testing Location6

 1.4 Applicable Standards6

2 Test Configuration of Equipment Under Test7

 2.1 Test Mode.....7

 2.2 Connection Diagram of Test System7

 2.3 Support Unit used in test configuration8

 2.4 Measurement Results Explanation Example8

 2.5 Frequency List of Low/Middle/High Channels.....8

3 Conducted Test Result9

 3.1 Measuring Instruments.....9

 3.2 Conducted Output Power and ERP/EIRP10

 3.3 Peak-to-Average Ratio11

 3.4 99% Occupied Bandwidth and 26dB Bandwidth Measurement.....12

 3.5 Conducted Band Edge13

 3.6 Conducted Spurious Emission14

 3.7 Frequency Stability.....15

4 Radiated Test Items16

 4.1 Measuring Instruments.....16

 4.2 Test Setup16

 4.3 Test Result of Radiated Test.....16

 4.4 Field Strength of Spurious Radiation Measurement17

5 List of Measuring Equipment.....18

6 Uncertainty of Evaluation19

Appendix A. Test Results of Conducted Test

Appendix B. Test Results of ERP/EIRP and Radiated Test

Appendix C. Test Setup Photographs



History of this test report

Report No.	Version	Description	Issued Date
FG971613A	01	Initial issue of report	Aug. 21, 2019



Summary of Test Result

Report Clause	Ref Std. Clause	Test Items	Result (PASS/FAIL)	Remark
3.2	§2.1046	Conducted Output Power	Pass	-
	§22.913 (a)(2)	Effective Radiated Power		
	§24.232 (c)	Equivalent Isotropic Radiated Power		
3.3	§24.232 (d)	Peak-to-Average Ratio	Pass	-
3.4	§2.1049 §22.917 (b) §24.238 (b)	Occupied Bandwidth	Pass	-
3.5	§2.1051 §22.917 (a) §24.238 (a)	Band Edge Measurement	Pass	-
3.6	§2.1051 §22.917 (a) §24.238 (a)	Conducted Emission	Pass	-
3.7	§2.1055 §22.355	Frequency Stability Temperature & Voltage	Pass	-
	§2.1055 §24.235			-
4.4	§2.1053 §22.917 (a) §24.238 (a)	Field Strength of Spurious Radiation	Pass	Under limit 35.08 dB at 2544.000 MHz

Declaration of Conformity:

The test results with all measurement uncertainty excluded are presented in accordance with the regulation limits or requirements declared by manufacturers.

Comments and Explanations:

The declared of product specification for EUT presented in the report are provided by the manufacturer, and the manufacturer takes all the responsibilities for the accuracy of product specification.

Reviewed by: Wii Chang

Report Producer: Yimin Ho



1 General Description

1.1 Product Feature of Equipment Under Test

GSM/WCDMA/LTE, Bluetooth, Wi-Fi 2.4GHz 802.11b/g/n, Wi-Fi 5GHz 802.11a/n/ac, NFC, and GNSS.

Product Specification subjective to this standard	
Sample 1	1st vender parts
Sample 2	2nd vender parts
Antenna Type	WWAN: PIFA Antenna WLAN: ILA Antenna Bluetooth: ILA Antenna GPS / Glonass / BDS / Galileo: ILA Antenna NFC: Loop Antenna

Remark: All test items were performed with Sample 1.

1.2 Modification of EUT

No modifications are made to the EUT during all test items.



1.3 Testing Location

Test Site	SPORTON INTERNATIONAL INC. EMC & Wireless Communications Laboratory
Test Site Location	No.52, Huaya 1st Rd., Guishan Dist., Taoyuan City, Taiwan (R.O.C.) TEL: +886-3-327-3456 FAX: +886-3-328-4978
Test Site No.	Sporton Site No.
	TH03-HY
Test Engineer	Benjamin Lin
Temperature	21~24°C
Relative Humidity	51~55%

Note: The test site complies with ANSI C63.4 2014 requirement.

Test Site	SPORTON INTERNATIONAL INC. EMC & Wireless Communications Laboratory
Test Site Location	No.58, Aly. 75, Ln. 564, Wenhua 3rd, Rd., Guishan Dist., Taoyuan City, Taiwan (R.O.C.) TEL: +886-3-327-0868 FAX: +886-3-327-0855
Test Site No.	Sporton Site No.
	03CH11-HY
Test Engineer	Bill Kuo, Fu Chen, Troye Hsieh
Temperature	21.6~26°C
Relative Humidity	54.6~66.3%

Note: The test site complies with ANSI C63.4 2014 requirement.

FCC Designation No.: TW1190 and TW0007

1.4 Applicable Standards

According to the specifications of the manufacturer, the EUT must comply with the requirements of the following standards:

- ♦ ANSI C63.26-2015
- ♦ ANSI / TIA-603-E
- ♦ 47 CFR Part 2, 22(H), 24(E)
- ♦ FCC KDB 971168 D01 Power Meas. License Digital Systems v03r01
- ♦ FCC KDB 412172 D01 Determining ERP and EIRP v01r01

Remark:

1. All test items were verified and recorded according to the standards and without any deviation during the test.
2. This EUT has also been tested and complied with the requirements of FCC Part 15, Subpart B, recorded in a separate test report.

2 Test Configuration of Equipment Under Test

2.1 Test Mode

Antenna port conducted and radiated test items were performed according to KDB 971168 D01 Power Meas. License Digital Systems v03r01 with maximum output power.

For radiated measurement, pre-scanned in three orthogonal panels, X, Y, Z. The worst cases (Z plane for PCS Band and Y plane for Cellular Band) were recorded in this report.

Radiated emissions were investigated as following frequency range:

1. 30 MHz to 9000 MHz for GSM850 and WCDMA Band V.
2. 30 MHz to 19100 MHz for GSM1900.

All modes and data rates and positions were investigated.

Test modes are chosen to be reported as the worst case configuration below:

Test Modes		
Band	Radiated TCs	Conducted TCs
GSM 850	■ GPRS Class 8 Link	■ GPRS Class 8 Link
GSM 1900	■ GPRS Class 8 Link	■ GPRS Class 8 Link
WCDMA Band V	■ RMC 12.2Kbps Link	■ RMC 12.2Kbps Link

2.2 Connection Diagram of Test System

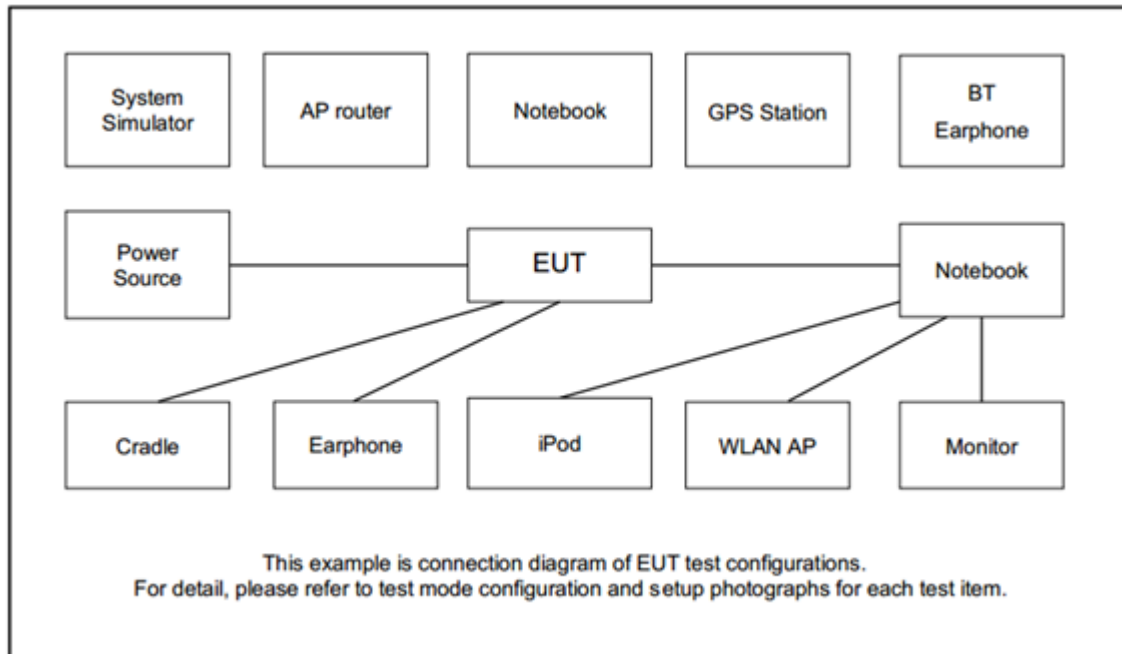



2.3 Support Unit used in test configuration

Item	Equipment	Trade Name	Model No.	FCC ID	Data Cable	Power Cord
1.	System Simulator	R&S	CMU 200	N/A	N/A	Unshielded, 1.8 m
2.	Earphone	SHARP	RPHOEA007AFZZ	N/A	Unshielded, 1.2m	N/A

2.4 Measurement Results Explanation Example

For all conducted test items:

The offset level is set in the spectrum analyzer to compensate the RF cable loss and attenuator factor between RF conducted output port and spectrum analyzer. With the offset compensation, the spectrum analyzer reading level will be exactly the RF output level.

The spectrum analyzer offset is derived from RF cable loss and attenuator factor.

$$\text{Offset} = \text{RF cable loss} + \text{attenuator factor}.$$

The following shows an offset computation example with RF cable loss 4.2 dB and a 10dB attenuator.

Example:

$$\begin{aligned} \text{Offset(dB)} &= \text{RF cable loss(dB)} + \text{attenuator factor(dB)} \\ &= 4.2 + 10 = 14.2 \text{ (dB)} \end{aligned}$$

2.5 Frequency List of Low/Middle/High Channels

Frequency List				
Band	Channel/Frequency(MHz)	Lowest	Middle	Highest
GSM850	Channel	128	189	251
	Frequency	824.2	836.4	848.8
WCDMA Band V	Channel	4132	4182	4233
	Frequency	826.4	836.4	846.6
GSM1900	Channel	512	661	810
	Frequency	1850.2	1880.0	1909.8

3 Conducted Test Result

3.1 Measuring Instruments

See list of measuring instruments of this test report.

3.1.1 Test Setup

3.1.2 Conducted Output Power

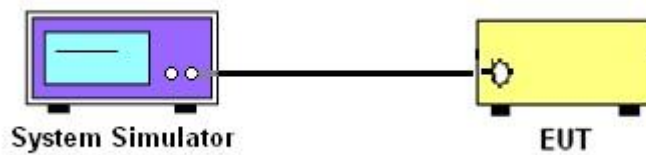

3.1.3 Peak-to-Average Ratio, Occupied Bandwidth, Conducted Band-Edge and Conducted Spurious Emission

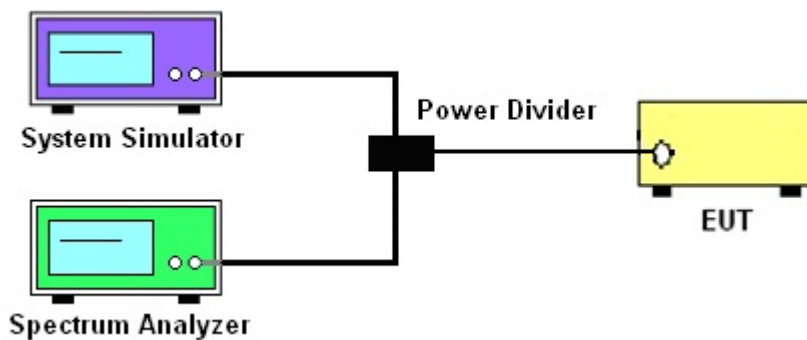

3.1.4 Frequency Stability

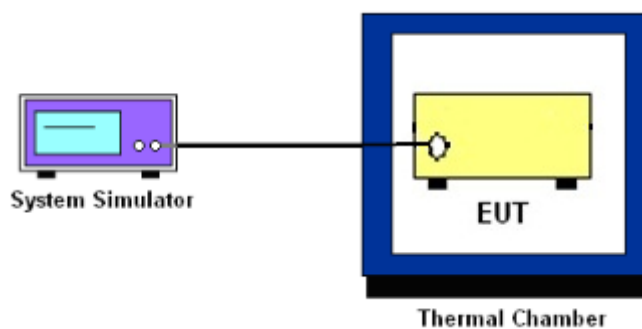

3.1.5 Test Result of Conducted Test

Please refer to Appendix A.



3.2 Conducted Output Power and ERP/EIRP

3.2.1 Description of the Conducted Output Power and ERP/EIRP

A system simulator was used to establish communication with the EUT. Its parameters were set to enforce EUT transmitting at the maximum power. The measured power in the radio frequency on the transmitter output terminals shall be reported.

The ERP of mobile transmitters must not exceed 7 Watts for GSM850 and WCDMA Band V.

The EIRP of mobile transmitters must not exceed 2 Watts for GSM1900.

According to KDB 412172 D01 Power Approach,

$EIRP = P_T + G_T - L_C$, $ERP = EIRP - 2.15$, where

P_T = transmitter output power in dBm

G_T = gain of the transmitting antenna in dBi

L_C = signal attenuation in the connecting cable between the transmitter and antenna in dB

3.2.2 Test Procedures

1. The transmitter output port was connected to the system simulator.
2. Set EUT at maximum power through system simulator.
3. Select lowest, middle, and highest channels for each band and different modulation.
4. Measure the maximum burst average power for GSM and maximum average power for other modulation signal.



3.3 Peak-to-Average Ratio

3.3.1 Description of the PAR Measurement

The peak-to-average ratio (PAR) of the transmission may not exceed 13 dB.

3.3.2 Test Procedures

The testing follows ANSI C63.26-2015 Section 5.2.6

1. The EUT was connected to spectrum analyzer and system simulator via a power divider.
2. Set EUT to transmit at maximum output power.
3. When the duty cycle is less than 98%, then signal gating will be implemented on the spectrum analyzer by triggering from the system simulator.
4. Set the CCDF (Complementary Cumulative Distribution Function) option of the spectrum analyzer.
5. Record the maximum PAPR level associated with a probability of 0.1%.



3.4 99% Occupied Bandwidth and 26dB Bandwidth Measurement

3.4.1 Description of 99% Occupied Bandwidth and 26dB Bandwidth Measurement

The occupied bandwidth is the width of a frequency band such that, below the lower and above the upper frequency limits, the mean powers emitted are each equal to a specified percentage 0.5% of the total mean transmitted power.

The 26 dB emission bandwidth is defined as the frequency range between two points, one above and one below the carrier frequency, at which the spectral density of the emission is attenuated 26 dB below the maximum in-band spectral density of the modulated signal. Spectral density (power per unit bandwidth) is to be measured with a detector of resolution bandwidth equal to approximately 1.0% of the emission bandwidth.

3.4.2 Test Procedures

The testing follows ANSI C63.26-2015 Section 5.4.3 (26dB) and Section 5.4.4 (99OB)

1. The EUT was connected to spectrum analyzer and system simulator via a power divider.
2. The spectrum analyzer center frequency is set to the nominal EUT channel center frequency. The span range for the spectrum analyzer shall be between two and five times the anticipated OBW.
3. The nominal resolution bandwidth (RBW) shall be in the range of 1 to 5 % of the anticipated OBW, and the VBW shall be at least 3 times the RBW.
4. Set the detection mode to peak, and the trace mode to max hold.
5. Determine the reference value: Set the EUT to transmit a modulated signal. Allow the trace to stabilize. Set the spectrum analyzer marker to the highest level of the displayed trace.
(this is the reference value)
6. Determine the “-26 dB down amplitude” as equal to (Reference Value – X).
7. Place two markers, one at the lowest and the other at the highest frequency of the envelope of the spectral display such that each marker is at or slightly below the “-X dB down amplitude” determined in step 6. If a marker is below this “-X dB down amplitude” value it shall be placed as close as possible to this value. The OBW is the positive frequency difference between the two markers.
8. Use the 99 % power bandwidth function of the spectrum analyzer and report the measured bandwidth.



3.5 Conducted Band Edge

3.5.1 Description of Conducted Band Edge Measurement

The power of any emission outside of the authorized operating frequency ranges must be lower than the transmitter power (P) by a factor of at least $43 + 10 \log (P)$ dB.

3.5.2 Test Procedures

The testing follows FCC KDB 971168 D01 v03r01 Section 6.1.

1. The EUT was connected to the spectrum analyzer and system simulator via a power divider.
2. The RF output of EUT was connected to the spectrum analyzer by an RF cable and attenuator. The path loss was compensated to the results for each measurement.
3. The band edges of low and high channels for the highest RF powers were measured.
4. The RF fundamental frequency should be excluded against the limit line in the operating frequency band.
5. The limit line is derived from $43 + 10\log(P)$ dB below the transmitter power P(Watts)



3.6 Conducted Spurious Emission

3.6.1 Description of Conducted Spurious Emission Measurement

The power of any emission outside of the authorized operating frequency ranges must be lower than the transmitter power (P) by a factor of at least $43 + 10 \log (P)$ dB.

It is measured by means of a calibrated spectrum analyzer and scanned from 30 MHz up to a frequency including its 10th harmonic.

3.6.2 Test Procedures

The testing follows FCC KDB 971168 D01 v03r01 Section 6.1.

1. The EUT was connected to the spectrum analyzer and system simulator via a power divider.
2. The RF output of EUT was connected to the spectrum analyzer by an RF cable and attenuator. The path loss was compensated to the results for each measurement.
3. The middle channel for the highest RF power within the transmitting frequency was measured.
4. The conducted spurious emission for the whole frequency range was taken.
5. The RF fundamental frequency should be excluded against the limit line in the operating frequency band.
6. The limit line is derived from $43 + 10\log(P)$ dB below the transmitter power P(Watts)



3.7 Frequency Stability

3.7.1 Description of Frequency Stability Measurement

22.355

The frequency stability shall be measured by variation of ambient temperature and variation of primary supply voltage to ensure that the fundamental emission stays within the authorized frequency block. The frequency stability of the transmitter shall be maintained within $\pm 0.00025\%$ ($\pm 2.5\text{ppm}$) of the center frequency.

24.235

The frequency stability shall be sufficient to ensure that the fundamental emission stays within the authorized frequency block.

3.7.2 Test Procedures for Temperature Variation

The testing follows FCC KDB 971168 D01 v03r01 Section 9.0.

1. The EUT was set up in the thermal chamber and connected with the system simulator.
2. With power OFF, the temperature was decreased to -30°C and the EUT was stabilized before testing. Power was applied and the maximum change in frequency was recorded within one minute.
3. With power OFF, the temperature was raised in 10°C steps up to 50°C . The EUT was stabilized at each step for at least half an hour. Power was applied and the maximum frequency change was recorded within one minute.

3.7.3 Test Procedures for Voltage Variation

The testing follows FCC KDB 971168 D01 v03r01 Section 9.0.

1. The EUT was placed in a temperature chamber at $20\pm 5^{\circ}\text{C}$ and connected with the system simulator.
2. The power supply voltage to the EUT was varied from 85% to 115% of the nominal value measured at the input to the EUT.
3. The variation in frequency was measured for the worst case.

4 Radiated Test Items

4.1 Measuring Instruments

See list of measuring instruments of this test report.

4.2 Test Setup

For radiated test from 30MHz to 1GHz

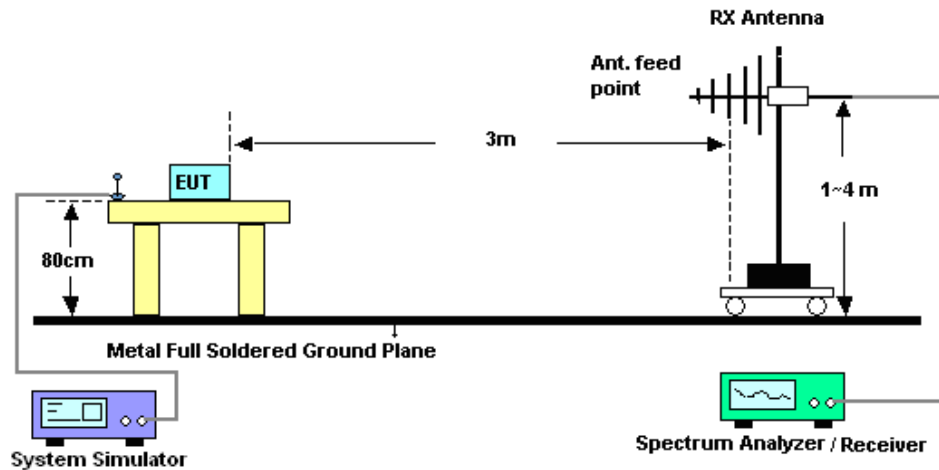

For radiated test above 1GHz

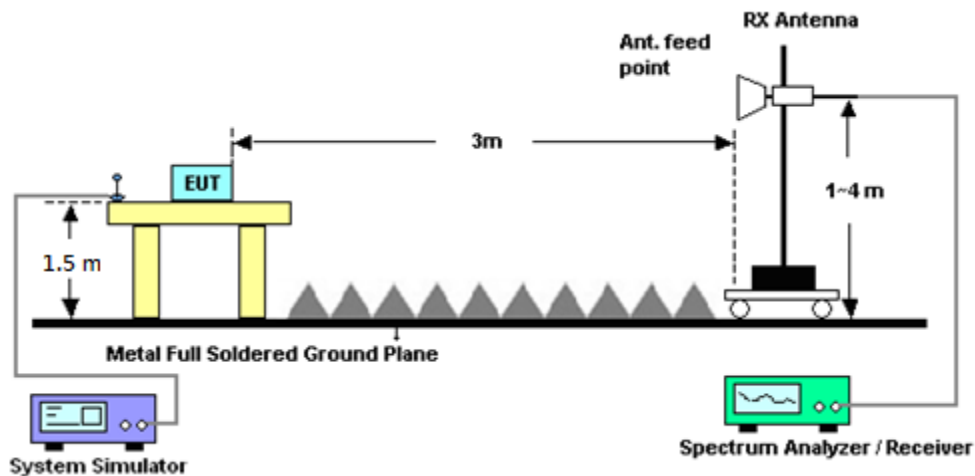

4.3 Test Result of Radiated Test

Please refer to Appendix B.



4.4 Field Strength of Spurious Radiation Measurement

4.4.1 Description of Field Strength of Spurious Radiated Measurement

The power of any emission outside of the authorized operating frequency ranges must be attenuated below the transmitter power (P) by a factor of at least $43 + 10 \log (P)$ dB. The spectrum is scanned from 30 MHz up to a frequency including its 10th harmonic.

4.4.2 Test Procedures

The testing follows FCC KDB 971168 D01 v03r01 Section 7 and ANSI / TIA-603-E Section 2.2.12.

1. The EUT was placed on a rotatable wooden table 0.8 meters for frequency below 1GHz and 1.5 meter for frequency above 1GHz above the ground.
2. The EUT was set 3 meters from the receiving antenna, which was mounted on the antenna tower.
3. The table was rotated 360 degrees to determine the position of the highest spurious emission.
4. The height of the receiving antenna is varied between one meter and four meters to search for the maximum spurious emission for both horizontal and vertical polarizations.
5. Make the measurement with the spectrum analyzer's RBW = 1MHz, VBW = 3MHz, taking record of maximum spurious emission.
6. A horn antenna was substituted in place of the EUT and was driven by a signal generator.
7. Tune the output power of signal generator to the same emission level with EUT maximum spurious emission.
8. Taking the record of output power at antenna port.
9. Repeat step 7 to step 8 for another polarization.
10. $EIRP (dBm) = S.G. Power - Tx Cable Loss + Tx Antenna Gain$
11. $ERP (dBm) = EIRP - 2.15$
12. The RF fundamental frequency should be excluded against the limit line in the operating frequency band.
13. The limit line is derived from $43 + 10\log(P)$ dB below the transmitter power P(Watts)



5 List of Measuring Equipment

Instrument	Manufacturer	Model No.	Serial No.	Characteristics	Calibration Date	Test Date	Due Date	Remark
Preamplifier	EMEC	EM18G40G	060715	18GHz ~ 40GHz	Dec. 06, 2018	Jul. 27, 2019~ Aug. 06, 2019	Dec. 05, 2019	Radiation (03CH11-HY)
Amplifier	SONOMA	310N	187312	9kHz~1GHz	Dec. 04, 2018	Jul. 27, 2019~ Aug. 06, 2019	Dec. 03, 2019	Radiation (03CH11-HY)
Bilog Antenna	TESEQ	CBL 6111D&N-6-0 6	35414&AT- N0602	30MHz~1GHz	Oct. 13, 2018	Jul. 27, 2019~ Aug. 06, 2019	Oct. 12, 2019	Radiation (03CH11-HY)
Horn Antenna	SCHWARZBE CK	BBHA 9120 D	9120D-132 6	1GHz ~ 18GHz	Oct. 15, 2018	Jul. 27, 2019~ Aug. 06, 2019	Oct. 14, 2019	Radiation (03CH11-HY)
Horn Antenna	SCHWARZBE CK	BBHA 9120D	9120D-132 8	1GHz ~ 18GHz	Nov. 09, 2018	Jul. 27, 2019~ Aug. 06, 2019	Nov. 08, 2019	Radiation (03CH11-HY)
Loop Antenna	Rohde & Schwarz	HFH2-Z2	100488	9 kHz~30 MHz	Nov. 23, 2017	Jul. 27, 2019~ Aug. 06, 2019	Nov. 22, 2019	Radiation (03CH11-HY)
Preamplifier	Keysight	83017A	MY532701 48	1GHz~26.5GHz	Nov. 14, 2018	Jul. 27, 2019~ Aug. 06, 2019	Nov. 13, 2019	Radiation (03CH11-HY)
Spectrum Analyzer	Keysight	N9010A	MY542004 86	10Hz ~ 44GHz	Oct. 18, 2018	Jul. 27, 2019~ Aug. 06, 2019	Oct. 17, 2019	Radiation (03CH11-HY)
Filter	Wainwright	WHKX12-108 0-1200-1500- 60SS	SN2	1.2G High Pass	Sep. 17, 2018	Jul. 27, 2019~ Aug. 06, 2019	Sep. 16, 2019	Radiation (03CH11-HY)
Filter	Wainwright	WHKX12-270 0-3000-18000 -60SS	SN3	2.7G High Pass	Sep. 17, 2018	Jul. 27, 2019~ Aug. 06, 2019	Sep. 16, 2019	Radiation (03CH11-HY)
Antenna Mast	EMEC	AM-BS-4500- B	N/A	1~4m	N/A	Jul. 27, 2019~ Aug. 06, 2019	N/A	Radiation (03CH11-HY)
Turn Table	EMEC	TT 2000	N/A	0~360 Degree	N/A	Jul. 27, 2019~ Aug. 06, 2019	N/A	Radiation (03CH11-HY)
EMI Test Receiver	Keysight	N9038A (MXE)	MY532900 45	20MHz~8.4GHz	Jan. 19, 2019	Jul. 27, 2019~ Aug. 06, 2019	Jan. 18, 2020	Radiation (03CH11-HY)
SHF-EHF Horn Antenna	SCHWARZBE CK	BBHA 9170	BBHA9170 584	18GHz- 40GHz	Dec. 05, 2018	Jul. 27, 2019~ Aug. 06, 2019	Dec. 04, 2019	Radiation (03CH11-HY)
Software	Audix	E3 6.2009-8-24	RK-00104 2	N/A	N/A	Jul. 27, 2019~ Aug. 06, 2019	N/A	Radiation (03CH11-HY)
RF Cable	HUBER + SUHNER	SUCOFLEX 104	MY9837/4 PE	9kHz-30MHz	Mar. 13, 2019	Jul. 27, 2019~ Aug. 06, 2019	Mar. 12, 2020	Radiation (03CH11-HY)
RF Cable	HUBER + SUHNER	SUCOFLEX 102	MY2859/2	30MHz-40GHz	Mar. 13, 2019	Jul. 27, 2019~ Aug. 06, 2019	Mar. 12, 2020	Radiation (03CH11-HY)
RF Cable	HUBER + SUHNER	SUCOFLEX 104	MY9837/4 PE	30M-18G	Mar. 13, 2019	Jul. 27, 2019~ Aug. 06, 2019	Mar. 12, 2020	Radiation (03CH11-HY)
RF Cable	HUBER + SUHNER	SUCOFLEX 102	MY4274/2	30MHz-40GHz	Mar. 13, 2019	Jul. 27, 2019~ Aug. 06, 2019	Mar. 12, 2020	Radiation (03CH11-HY)
SMB100A Signal Generator	R&S	SMB100A	181147	100kHz~40GHz	Nov. 12, 2018	Jul. 27, 2019~ Aug. 06, 2019	Nov. 10, 2020	Radiation (03CH11-HY)
Spectrum Analyzer	Rohde & Schwarz	FSP30	101067	9kHz~30GHz	Jun. 13, 2019	Jul. 25, 2019~ Jul. 26, 2019	Jun. 12, 2020	Conducted (TH03-HY)
Temperature Chamber	ESPEC	SU-641	92013721	-30℃ ~70℃	Nov. 28, 2018	Jul. 25, 2019~ Jul. 26, 2019	Nov. 27, 2019	Conducted (TH03-HY)
Programmable Power Supply	GW Instek	PSS-2005	EL890001	Voltage:0~20V; Current:0~5A	Oct. 08, 2018	Jul. 25, 2019~ Jul. 26, 2019	Oct. 07, 2019	Conducted (TH03-HY)
Base Station (Measure)	Rohde & Schwarz	CMU200	117995	GSM / GPRS / WCDMA / CDMA	Aug. 10, 2018	Jul. 25, 2019~ Jul. 26, 2019	Aug. 09, 2019	Conducted (TH03-HY)



6 Uncertainty of Evaluation

Uncertainty of Radiated Emission Measurement (30 MHz ~ 1000 MHz)

Measuring Uncertainty for a Level of Confidence of 95% ($U = 2Uc(y)$)	3.37
---	------

Uncertainty of Radiated Emission Measurement (1 GHz ~ 18 GHz)

Measuring Uncertainty for a Level of Confidence of 95% ($U = 2Uc(y)$)	3.67
---	------

Uncertainty of Radiated Emission Measurement (18 GHz ~ 40 GHz)

Measuring Uncertainty for a Level of Confidence of 95% ($U = 2Uc(y)$)	4.03
---	------



Appendix A. Test Results of Conducted Test

Conducted Output Power(Average power)

Conducted Power (*Unit: dBm)						
Band	GSM850			GSM1900		
Channel	128	189	251	512	661	810
Frequency	824.2	836.4	848.8	1850.2	1880	1909.8
GSM	32.02	32.05	31.92	29.00	28.85	28.92
GPRS class 8	32.06	32.09	31.94	29.01	28.87	28.94
GPRS class 10	30.93	30.91	30.57	27.21	27.08	27.25
GPRS class 11	29.42	29.09	29.10	25.36	25.19	25.30
GPRS class 12	27.80	27.82	27.76	23.89	23.79	24.00

Conducted Power (*Unit: dBm)						
Band	WCDMA Band V			WCDMA Band II		
Channel	4132	4182	4233	9262	9400	9538
Frequency	826.4	836.4	846.6	1852.4	1880	1907.6
RMC 12.2K	23.79	23.87	23.94	-	-	-
HSDPA Subtest-1	22.81	22.87	22.97	-	-	-
HSDPA Subtest-2	22.87	22.88	22.96	-	-	-
HSDPA Subtest-3	22.35	22.38	22.49	-	-	-
HSDPA Subtest-4	22.32	22.39	22.47	-	-	-
HSUPA Subtest-1	22.85	22.90	22.88	-	-	-
HSUPA Subtest-2	20.85	20.92	20.87	-	-	-
HSUPA Subtest-3	21.87	21.93	21.87	-	-	-
HSUPA Subtest-4	20.82	20.89	20.93	-	-	-
HSUPA Subtest-5	22.90	22.90	22.90	-	-	-



A2. GSM

Peak-to-Average Ratio

Mode	GSM850	Limit: 13dB
Mod.	GPRS class 8	Result
Lowest CH	0.28	PASS
Middle CH	0.24	
Highest CH	0.28	

Mode	GSM1900	Limit: 13dB
Mod.	GPRS class 8	Result
Lowest CH	0.28	PASS
Middle CH	0.28	
Highest CH	0.28	

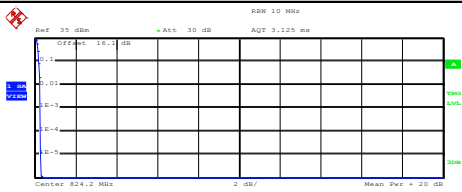
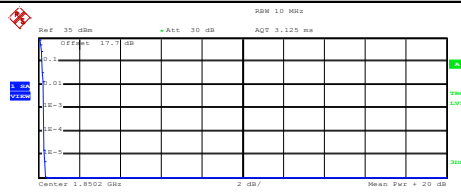
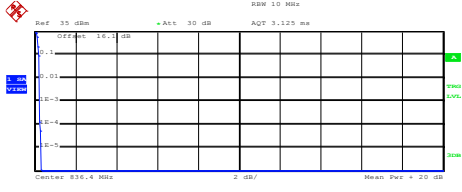
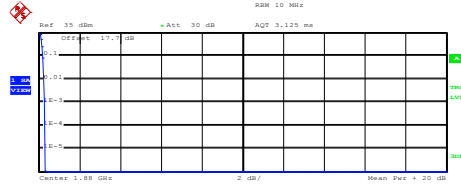
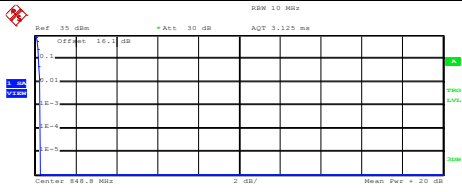
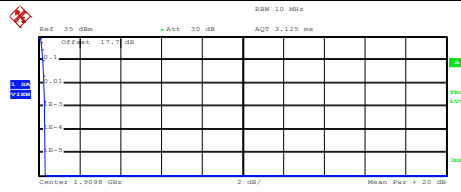

GSM850 (GPRS class 8)	GSM1900 (GPRS class 8)																
<p align="center">Lowest Channel</p>  <p>Complementary Cumulative Distribution Function (100000 samples) Trace 1 Mean 32.18 dBm Peak 32.50 dBm Crest 0.32 dB</p> <table border="1"> <tr><td>10 %</td><td>0.20 dB</td></tr> <tr><td>1 %</td><td>0.28 dB</td></tr> <tr><td>.1 %</td><td>0.28 dB</td></tr> <tr><td>.01 %</td><td>0.28 dB</td></tr> </table> <p>Date: 25.JUL.2019 11:12:48</p>	10 %	0.20 dB	1 %	0.28 dB	.1 %	0.28 dB	.01 %	0.28 dB	<p align="center">Lowest Channel</p>  <p>Complementary Cumulative Distribution Function (100000 samples) Trace 1 Mean 28.63 dBm Peak 28.97 dBm Crest 0.34 dB</p> <table border="1"> <tr><td>10 %</td><td>0.20 dB</td></tr> <tr><td>1 %</td><td>0.24 dB</td></tr> <tr><td>.1 %</td><td>0.28 dB</td></tr> <tr><td>.01 %</td><td>0.28 dB</td></tr> </table> <p>Date: 25.JUL.2019 16:53:25</p>	10 %	0.20 dB	1 %	0.24 dB	.1 %	0.28 dB	.01 %	0.28 dB
10 %	0.20 dB																
1 %	0.28 dB																
.1 %	0.28 dB																
.01 %	0.28 dB																
10 %	0.20 dB																
1 %	0.24 dB																
.1 %	0.28 dB																
.01 %	0.28 dB																
<p align="center">Middle Channel</p>  <p>Complementary Cumulative Distribution Function (100000 samples) Trace 1 Mean 32.19 dBm Peak 32.50 dBm Crest 0.31 dB</p> <table border="1"> <tr><td>10 %</td><td>0.20 dB</td></tr> <tr><td>1 %</td><td>0.24 dB</td></tr> <tr><td>.1 %</td><td>0.24 dB</td></tr> <tr><td>.01 %</td><td>0.24 dB</td></tr> </table> <p>Date: 25.JUL.2019 11:13:08</p>	10 %	0.20 dB	1 %	0.24 dB	.1 %	0.24 dB	.01 %	0.24 dB	<p align="center">Middle Channel</p>  <p>Complementary Cumulative Distribution Function (100000 samples) Trace 1 Mean 28.48 dBm Peak 28.76 dBm Crest 0.28 dB</p> <table border="1"> <tr><td>10 %</td><td>0.20 dB</td></tr> <tr><td>1 %</td><td>0.24 dB</td></tr> <tr><td>.1 %</td><td>0.28 dB</td></tr> <tr><td>.01 %</td><td>0.32 dB</td></tr> </table> <p>Date: 25.JUL.2019 16:53:41</p>	10 %	0.20 dB	1 %	0.24 dB	.1 %	0.28 dB	.01 %	0.32 dB
10 %	0.20 dB																
1 %	0.24 dB																
.1 %	0.24 dB																
.01 %	0.24 dB																
10 %	0.20 dB																
1 %	0.24 dB																
.1 %	0.28 dB																
.01 %	0.32 dB																
<p align="center">Highest Channel</p>  <p>Complementary Cumulative Distribution Function (100000 samples) Trace 1 Mean 32.25 dBm Peak 32.50 dBm Crest 0.26 dB</p> <table border="1"> <tr><td>10 %</td><td>0.20 dB</td></tr> <tr><td>1 %</td><td>0.24 dB</td></tr> <tr><td>.1 %</td><td>0.28 dB</td></tr> <tr><td>.01 %</td><td>0.28 dB</td></tr> </table> <p>Date: 25.JUL.2019 11:13:24</p>	10 %	0.20 dB	1 %	0.24 dB	.1 %	0.28 dB	.01 %	0.28 dB	<p align="center">Highest Channel</p>  <p>Complementary Cumulative Distribution Function (100000 samples) Trace 1 Mean 28.65 dBm Peak 28.97 dBm Crest 0.32 dB</p> <table border="1"> <tr><td>10 %</td><td>0.20 dB</td></tr> <tr><td>1 %</td><td>0.28 dB</td></tr> <tr><td>.1 %</td><td>0.28 dB</td></tr> <tr><td>.01 %</td><td>0.32 dB</td></tr> </table> <p>Date: 25.JUL.2019 16:53:56</p>	10 %	0.20 dB	1 %	0.28 dB	.1 %	0.28 dB	.01 %	0.32 dB
10 %	0.20 dB																
1 %	0.24 dB																
.1 %	0.28 dB																
.01 %	0.28 dB																
10 %	0.20 dB																
1 %	0.28 dB																
.1 %	0.28 dB																
.01 %	0.32 dB																



26dB Bandwidth

Mode	GSM850
Mod.	GPRS class 8
Lowest CH	0.313
Middle CH	0.308
Highest CH	0.315

Mode	GSM1900
Mod.	GPRS class 8
Lowest CH	0.295
Middle CH	0.305
Highest CH	0.314

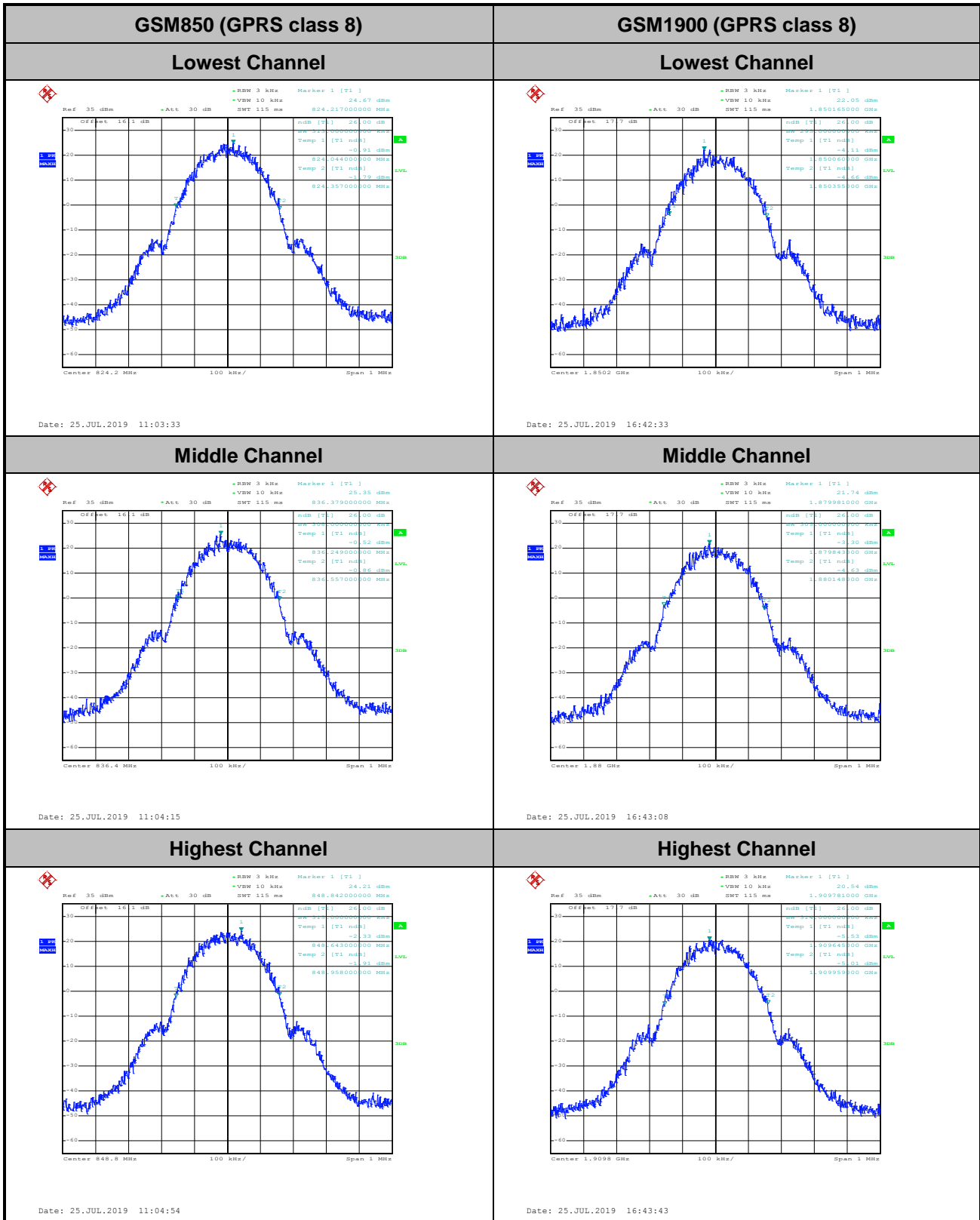



Occupied Bandwidth

Mode	GSM850
Mod.	GPRS class 8
Lowest CH	0.243
Middle CH	0.242
Highest CH	0.245

Mode	GSM1900
Mod.	GPRS class 8
Lowest CH	0.246
Middle CH	0.247
Highest CH	0.245

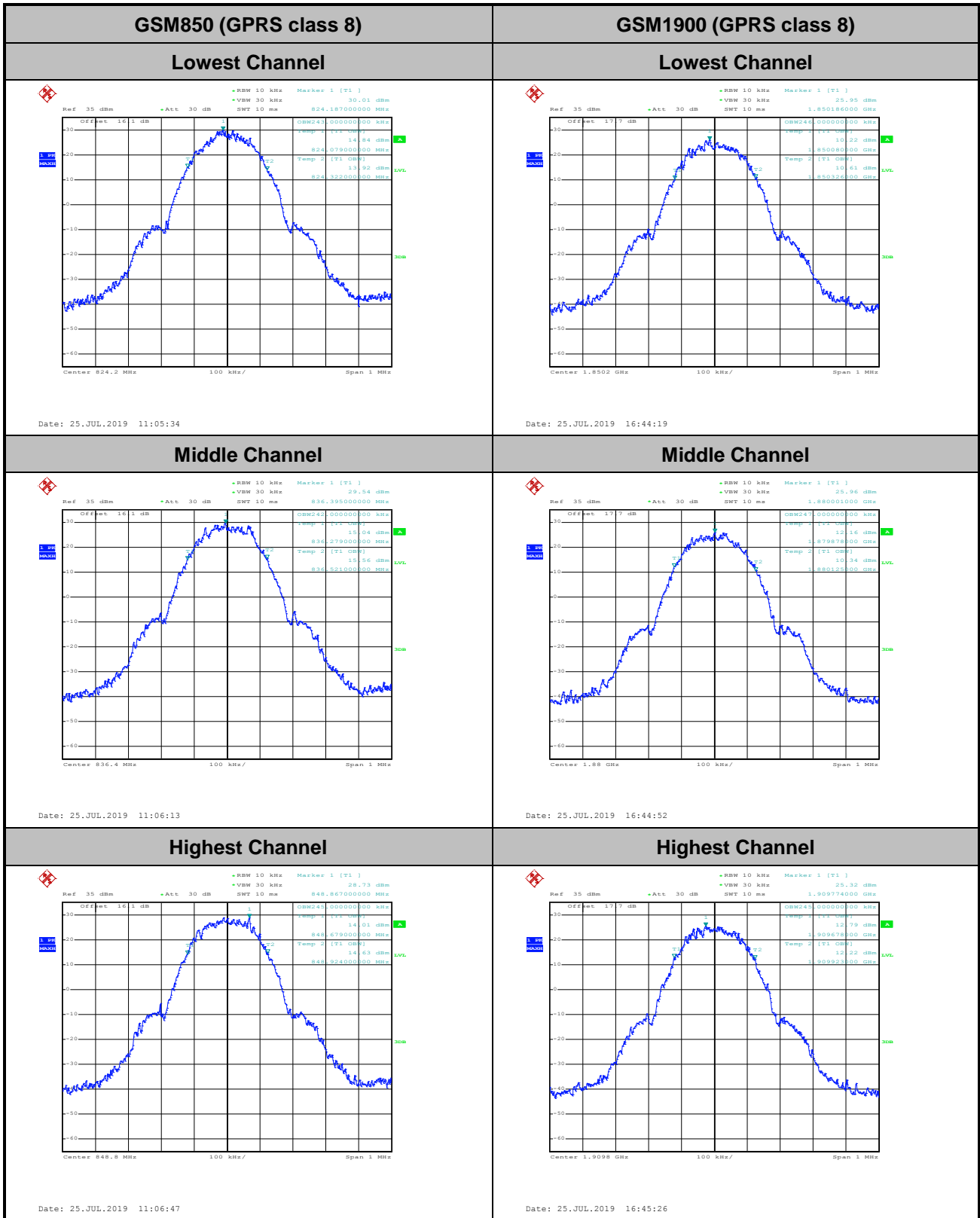



Conducted Band Edge

GSM850 (GPRS class 8)

Lowest Band Edge

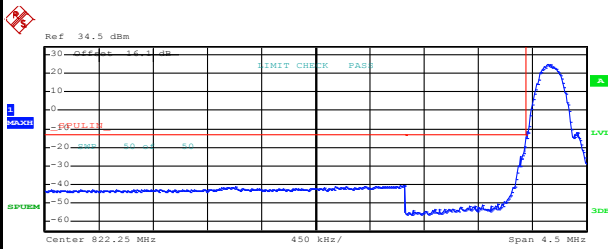

Start [Hz]	Stop [Hz]	RW [Hz]	Freq [Hz]	PwrAbs [dBm]	ΔLimit [dB]
820.000 M	823.000 M	100.00 M	822.994000 M	-40.44	-27.44
823.000 M	824.000 M	3.00 k	823.980000 M	-21.07	-8.07
824.000 M	824.500 M	10.00 k	824.175000 M	25.10	-9.90

Date: 25.JUL.2019 11:08:21

Highest Band Edge

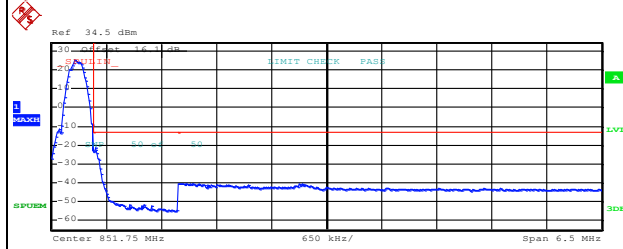

Start [Hz]	Stop [Hz]	RW [Hz]	Freq [Hz]	PwrAbs [dBm]	ΔLimit [dB]
848.500 M	849.000 M	10.00 k	848.778500 M	25.18	-9.82
849.000 M	850.000 M	3.00 k	849.016000 M	-21.51	-8.51
850.000 M	855.000 M	100.00 k	850.050000 M	-40.36	-27.36

Date: 25.JUL.2019 11:09:54

GSM1900 (GPRS class 8)

Lowest Band Edge

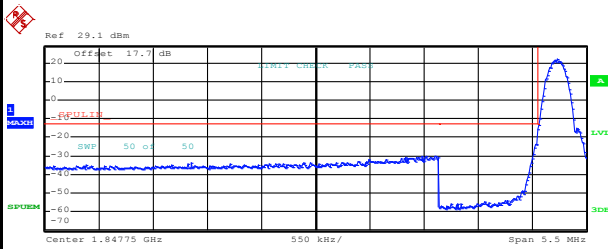

Start [Hz]	Stop [Hz]	RW [Hz]	Freq [Hz]	PwrAbs [dBm]	ΔLimit [dB]
1.845 G	1.849 G	1.00 M	1.848864 G	-30.11	-17.11
1.849 G	1.850 G	3.00 k	1.849984 G	-24.07	-11.07
1.850 G	1.851 G	10.00 k	1.850205 G	22.09	-12.91

Date: 25.JUL.2019 16:47:39

Highest Band Edge

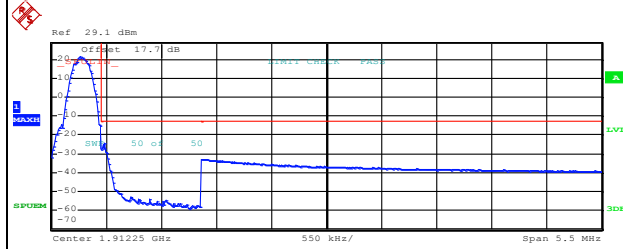

Start [Hz]	Stop [Hz]	RW [Hz]	Freq [Hz]	PwrAbs [dBm]	ΔLimit [dB]
1.910 G	1.910 G	10.00 k	1.909782 G	21.71	-13.29
1.910 G	1.911 G	3.00 k	1.910020 G	-24.13	-11.13
1.911 G	1.915 G	1.00 M	1.911016 G	-33.03	-20.03

Date: 25.JUL.2019 16:49:12

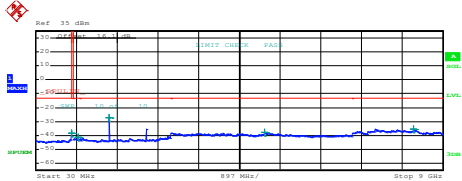
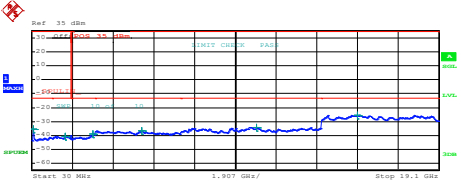
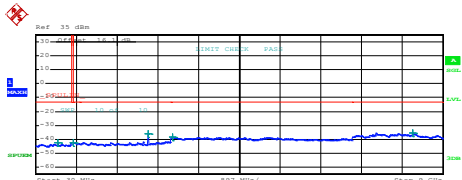
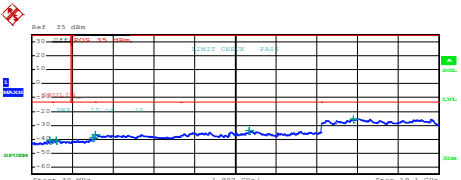
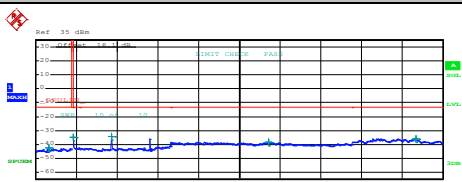
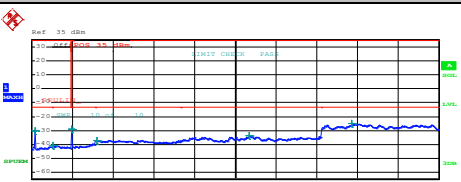

Conducted Spurious Emission

GSM850 (GPRS class 8)	GSM1900 (GPRS class 8)																																																																																										
<p align="center">Lowest Channel</p>	<p align="center">Lowest Channel</p>																																																																																										
 <table border="1" data-bbox="207 660 670 739"> <thead> <tr> <th>Start</th> <th>Stop</th> <th>RBW</th> <th>Freq</th> <th>PwrAbs</th> <th>ΔLimit</th> </tr> <tr> <th>[Hz]</th> <th>[Hz]</th> <th>[Hz]</th> <th>[Hz]</th> <th>[dBm]</th> <th>[dB]</th> </tr> </thead> <tbody> <tr> <td>30.000 M</td> <td>820.000 M</td> <td>1.00 M</td> <td>819.012500 M</td> <td>-38.62</td> <td>-25.82</td> </tr> <tr> <td>855.000 M</td> <td>1.000 G</td> <td>1.00 M</td> <td>900.270007 M</td> <td>-41.46</td> <td>-28.46</td> </tr> <tr> <td>1.000 G</td> <td>3.000 G</td> <td>1.00 M</td> <td>1.688000 G</td> <td>-27.00</td> <td>-24.00</td> </tr> <tr> <td>3.000 G</td> <td>7.000 G</td> <td>1.00 M</td> <td>5.074000 G</td> <td>-37.81</td> <td>-24.81</td> </tr> <tr> <td>7.000 G</td> <td>9.000 G</td> <td>1.00 M</td> <td>8.360000 G</td> <td>-35.73</td> <td>-22.73</td> </tr> </tbody> </table> <p>Date: 25.JUL.2019 11:10:49</p>	Start	Stop	RBW	Freq	PwrAbs	ΔLimit	[Hz]	[Hz]	[Hz]	[Hz]	[dBm]	[dB]	30.000 M	820.000 M	1.00 M	819.012500 M	-38.62	-25.82	855.000 M	1.000 G	1.00 M	900.270007 M	-41.46	-28.46	1.000 G	3.000 G	1.00 M	1.688000 G	-27.00	-24.00	3.000 G	7.000 G	1.00 M	5.074000 G	-37.81	-24.81	7.000 G	9.000 G	1.00 M	8.360000 G	-35.73	-22.73	 <table border="1" data-bbox="861 660 1324 739"> <thead> <tr> <th>Start</th> <th>Stop</th> <th>RBW</th> <th>Freq</th> <th>PwrAbs</th> <th>ΔLimit</th> </tr> <tr> <th>[Hz]</th> <th>[Hz]</th> <th>[Hz]</th> <th>[Hz]</th> <th>[dBm]</th> <th>[dB]</th> </tr> </thead> <tbody> <tr> <td>30.000 M</td> <td>1.000 G</td> <td>1.00 M</td> <td>111.055000 M</td> <td>-35.40</td> <td>-22.40</td> </tr> <tr> <td>1.000 G</td> <td>1.845 G</td> <td>1.00 M</td> <td>1.602907 G</td> <td>-40.56</td> <td>-27.56</td> </tr> <tr> <td>1.845 G</td> <td>3.000 G</td> <td>1.00 M</td> <td>2.881393 G</td> <td>-38.69</td> <td>-25.69</td> </tr> <tr> <td>3.000 G</td> <td>7.000 G</td> <td>1.00 M</td> <td>5.190000 G</td> <td>-36.74</td> <td>-23.74</td> </tr> <tr> <td>7.000 G</td> <td>13.600 G</td> <td>1.00 M</td> <td>10.559875 G</td> <td>-34.15</td> <td>-21.15</td> </tr> <tr> <td>13.600 G</td> <td>19.100 G</td> <td>1.00 M</td> <td>15.302938 G</td> <td>-29.25</td> <td>-16.25</td> </tr> </tbody> </table> <p>Date: 25.JUL.2019 16:51:20</p>	Start	Stop	RBW	Freq	PwrAbs	ΔLimit	[Hz]	[Hz]	[Hz]	[Hz]	[dBm]	[dB]	30.000 M	1.000 G	1.00 M	111.055000 M	-35.40	-22.40	1.000 G	1.845 G	1.00 M	1.602907 G	-40.56	-27.56	1.845 G	3.000 G	1.00 M	2.881393 G	-38.69	-25.69	3.000 G	7.000 G	1.00 M	5.190000 G	-36.74	-23.74	7.000 G	13.600 G	1.00 M	10.559875 G	-34.15	-21.15	13.600 G	19.100 G	1.00 M	15.302938 G	-29.25	-16.25
Start	Stop	RBW	Freq	PwrAbs	ΔLimit																																																																																						
[Hz]	[Hz]	[Hz]	[Hz]	[dBm]	[dB]																																																																																						
30.000 M	820.000 M	1.00 M	819.012500 M	-38.62	-25.82																																																																																						
855.000 M	1.000 G	1.00 M	900.270007 M	-41.46	-28.46																																																																																						
1.000 G	3.000 G	1.00 M	1.688000 G	-27.00	-24.00																																																																																						
3.000 G	7.000 G	1.00 M	5.074000 G	-37.81	-24.81																																																																																						
7.000 G	9.000 G	1.00 M	8.360000 G	-35.73	-22.73																																																																																						
Start	Stop	RBW	Freq	PwrAbs	ΔLimit																																																																																						
[Hz]	[Hz]	[Hz]	[Hz]	[dBm]	[dB]																																																																																						
30.000 M	1.000 G	1.00 M	111.055000 M	-35.40	-22.40																																																																																						
1.000 G	1.845 G	1.00 M	1.602907 G	-40.56	-27.56																																																																																						
1.845 G	3.000 G	1.00 M	2.881393 G	-38.69	-25.69																																																																																						
3.000 G	7.000 G	1.00 M	5.190000 G	-36.74	-23.74																																																																																						
7.000 G	13.600 G	1.00 M	10.559875 G	-34.15	-21.15																																																																																						
13.600 G	19.100 G	1.00 M	15.302938 G	-29.25	-16.25																																																																																						
<p align="center">Middle Channel</p>	<p align="center">Middle Channel</p>																																																																																										
 <table border="1" data-bbox="207 1176 670 1254"> <thead> <tr> <th>Start</th> <th>Stop</th> <th>RBW</th> <th>Freq</th> <th>PwrAbs</th> <th>ΔLimit</th> </tr> <tr> <th>[Hz]</th> <th>[Hz]</th> <th>[Hz]</th> <th>[Hz]</th> <th>[dBm]</th> <th>[dB]</th> </tr> </thead> <tbody> <tr> <td>30.000 M</td> <td>820.000 M</td> <td>1.00 M</td> <td>518.415000 M</td> <td>-42.29</td> <td>-29.29</td> </tr> <tr> <td>855.000 M</td> <td>1.000 G</td> <td>1.00 M</td> <td>800.038550 M</td> <td>-42.61</td> <td>-29.61</td> </tr> <tr> <td>1.000 G</td> <td>3.000 G</td> <td>1.00 M</td> <td>2.510000 G</td> <td>-35.89</td> <td>-22.89</td> </tr> <tr> <td>3.000 G</td> <td>7.000 G</td> <td>1.00 M</td> <td>5.036000 G</td> <td>-38.12</td> <td>-25.12</td> </tr> <tr> <td>7.000 G</td> <td>9.000 G</td> <td>1.00 M</td> <td>8.329500 G</td> <td>-35.18</td> <td>-22.18</td> </tr> </tbody> </table> <p>Date: 25.JUL.2019 11:11:39</p>	Start	Stop	RBW	Freq	PwrAbs	ΔLimit	[Hz]	[Hz]	[Hz]	[Hz]	[dBm]	[dB]	30.000 M	820.000 M	1.00 M	518.415000 M	-42.29	-29.29	855.000 M	1.000 G	1.00 M	800.038550 M	-42.61	-29.61	1.000 G	3.000 G	1.00 M	2.510000 G	-35.89	-22.89	3.000 G	7.000 G	1.00 M	5.036000 G	-38.12	-25.12	7.000 G	9.000 G	1.00 M	8.329500 G	-35.18	-22.18	 <table border="1" data-bbox="861 1176 1324 1254"> <thead> <tr> <th>Start</th> <th>Stop</th> <th>RBW</th> <th>Freq</th> <th>PwrAbs</th> <th>ΔLimit</th> </tr> <tr> <th>[Hz]</th> <th>[Hz]</th> <th>[Hz]</th> <th>[Hz]</th> <th>[dBm]</th> <th>[dB]</th> </tr> </thead> <tbody> <tr> <td>30.000 M</td> <td>1.000 G</td> <td>1.00 M</td> <td>857.167500 M</td> <td>-40.99</td> <td>-27.99</td> </tr> <tr> <td>1.000 G</td> <td>1.845 G</td> <td>1.00 M</td> <td>1.167521 G</td> <td>-40.78</td> <td>-27.78</td> </tr> <tr> <td>1.845 G</td> <td>3.000 G</td> <td>1.00 M</td> <td>2.904820 G</td> <td>-39.25</td> <td>-26.25</td> </tr> <tr> <td>3.000 G</td> <td>7.000 G</td> <td>1.00 M</td> <td>5.007000 G</td> <td>-36.72</td> <td>-23.72</td> </tr> <tr> <td>7.000 G</td> <td>13.600 G</td> <td>1.00 M</td> <td>10.227400 G</td> <td>-33.55</td> <td>-20.55</td> </tr> <tr> <td>13.600 G</td> <td>19.100 G</td> <td>1.00 M</td> <td>15.112500 G</td> <td>-25.37</td> <td>-12.37</td> </tr> </tbody> </table> <p>Date: 25.JUL.2019 16:52:11</p>	Start	Stop	RBW	Freq	PwrAbs	ΔLimit	[Hz]	[Hz]	[Hz]	[Hz]	[dBm]	[dB]	30.000 M	1.000 G	1.00 M	857.167500 M	-40.99	-27.99	1.000 G	1.845 G	1.00 M	1.167521 G	-40.78	-27.78	1.845 G	3.000 G	1.00 M	2.904820 G	-39.25	-26.25	3.000 G	7.000 G	1.00 M	5.007000 G	-36.72	-23.72	7.000 G	13.600 G	1.00 M	10.227400 G	-33.55	-20.55	13.600 G	19.100 G	1.00 M	15.112500 G	-25.37	-12.37
Start	Stop	RBW	Freq	PwrAbs	ΔLimit																																																																																						
[Hz]	[Hz]	[Hz]	[Hz]	[dBm]	[dB]																																																																																						
30.000 M	820.000 M	1.00 M	518.415000 M	-42.29	-29.29																																																																																						
855.000 M	1.000 G	1.00 M	800.038550 M	-42.61	-29.61																																																																																						
1.000 G	3.000 G	1.00 M	2.510000 G	-35.89	-22.89																																																																																						
3.000 G	7.000 G	1.00 M	5.036000 G	-38.12	-25.12																																																																																						
7.000 G	9.000 G	1.00 M	8.329500 G	-35.18	-22.18																																																																																						
Start	Stop	RBW	Freq	PwrAbs	ΔLimit																																																																																						
[Hz]	[Hz]	[Hz]	[Hz]	[dBm]	[dB]																																																																																						
30.000 M	1.000 G	1.00 M	857.167500 M	-40.99	-27.99																																																																																						
1.000 G	1.845 G	1.00 M	1.167521 G	-40.78	-27.78																																																																																						
1.845 G	3.000 G	1.00 M	2.904820 G	-39.25	-26.25																																																																																						
3.000 G	7.000 G	1.00 M	5.007000 G	-36.72	-23.72																																																																																						
7.000 G	13.600 G	1.00 M	10.227400 G	-33.55	-20.55																																																																																						
13.600 G	19.100 G	1.00 M	15.112500 G	-25.37	-12.37																																																																																						
<p align="center">Highest Channel</p>	<p align="center">Highest Channel</p>																																																																																										
 <table border="1" data-bbox="207 1691 670 1769"> <thead> <tr> <th>Start</th> <th>Stop</th> <th>RBW</th> <th>Freq</th> <th>PwrAbs</th> <th>ΔLimit</th> </tr> <tr> <th>[Hz]</th> <th>[Hz]</th> <th>[Hz]</th> <th>[Hz]</th> <th>[dBm]</th> <th>[dB]</th> </tr> </thead> <tbody> <tr> <td>30.000 M</td> <td>820.000 M</td> <td>1.00 M</td> <td>313.215000 M</td> <td>-42.59</td> <td>-29.59</td> </tr> <tr> <td>855.000 M</td> <td>1.000 G</td> <td>1.00 M</td> <td>850.036250 M</td> <td>-35.02</td> <td>-22.02</td> </tr> <tr> <td>1.000 G</td> <td>3.000 G</td> <td>1.00 M</td> <td>1.608000 G</td> <td>-34.37</td> <td>-21.37</td> </tr> <tr> <td>3.000 G</td> <td>7.000 G</td> <td>1.00 M</td> <td>5.156000 G</td> <td>-38.15</td> <td>-25.15</td> </tr> <tr> <td>7.000 G</td> <td>9.000 G</td> <td>1.00 M</td> <td>8.409500 G</td> <td>-35.77</td> <td>-22.77</td> </tr> </tbody> </table> <p>Date: 25.JUL.2019 11:12:30</p>	Start	Stop	RBW	Freq	PwrAbs	ΔLimit	[Hz]	[Hz]	[Hz]	[Hz]	[dBm]	[dB]	30.000 M	820.000 M	1.00 M	313.215000 M	-42.59	-29.59	855.000 M	1.000 G	1.00 M	850.036250 M	-35.02	-22.02	1.000 G	3.000 G	1.00 M	1.608000 G	-34.37	-21.37	3.000 G	7.000 G	1.00 M	5.156000 G	-38.15	-25.15	7.000 G	9.000 G	1.00 M	8.409500 G	-35.77	-22.77	 <table border="1" data-bbox="861 1691 1324 1769"> <thead> <tr> <th>Start</th> <th>Stop</th> <th>RBW</th> <th>Freq</th> <th>PwrAbs</th> <th>ΔLimit</th> </tr> <tr> <th>[Hz]</th> <th>[Hz]</th> <th>[Hz]</th> <th>[Hz]</th> <th>[dBm]</th> <th>[dB]</th> </tr> </thead> <tbody> <tr> <td>30.000 M</td> <td>1.000 G</td> <td>1.00 M</td> <td>171.620000 M</td> <td>-30.28</td> <td>-17.28</td> </tr> <tr> <td>1.000 G</td> <td>1.845 G</td> <td>1.00 M</td> <td>1.011396 G</td> <td>-40.65</td> <td>-27.65</td> </tr> <tr> <td>1.845 G</td> <td>3.000 G</td> <td>1.00 M</td> <td>2.953212 G</td> <td>-29.03</td> <td>-16.03</td> </tr> <tr> <td>3.000 G</td> <td>7.000 G</td> <td>1.00 M</td> <td>3.087000 G</td> <td>-36.99</td> <td>-23.99</td> </tr> <tr> <td>7.000 G</td> <td>13.600 G</td> <td>1.00 M</td> <td>10.215800 G</td> <td>-35.96</td> <td>-22.96</td> </tr> <tr> <td>13.600 G</td> <td>19.100 G</td> <td>1.00 M</td> <td>15.056525 G</td> <td>-25.04</td> <td>-12.04</td> </tr> </tbody> </table> <p>Date: 25.JUL.2019 16:53:02</p>	Start	Stop	RBW	Freq	PwrAbs	ΔLimit	[Hz]	[Hz]	[Hz]	[Hz]	[dBm]	[dB]	30.000 M	1.000 G	1.00 M	171.620000 M	-30.28	-17.28	1.000 G	1.845 G	1.00 M	1.011396 G	-40.65	-27.65	1.845 G	3.000 G	1.00 M	2.953212 G	-29.03	-16.03	3.000 G	7.000 G	1.00 M	3.087000 G	-36.99	-23.99	7.000 G	13.600 G	1.00 M	10.215800 G	-35.96	-22.96	13.600 G	19.100 G	1.00 M	15.056525 G	-25.04	-12.04
Start	Stop	RBW	Freq	PwrAbs	ΔLimit																																																																																						
[Hz]	[Hz]	[Hz]	[Hz]	[dBm]	[dB]																																																																																						
30.000 M	820.000 M	1.00 M	313.215000 M	-42.59	-29.59																																																																																						
855.000 M	1.000 G	1.00 M	850.036250 M	-35.02	-22.02																																																																																						
1.000 G	3.000 G	1.00 M	1.608000 G	-34.37	-21.37																																																																																						
3.000 G	7.000 G	1.00 M	5.156000 G	-38.15	-25.15																																																																																						
7.000 G	9.000 G	1.00 M	8.409500 G	-35.77	-22.77																																																																																						
Start	Stop	RBW	Freq	PwrAbs	ΔLimit																																																																																						
[Hz]	[Hz]	[Hz]	[Hz]	[dBm]	[dB]																																																																																						
30.000 M	1.000 G	1.00 M	171.620000 M	-30.28	-17.28																																																																																						
1.000 G	1.845 G	1.00 M	1.011396 G	-40.65	-27.65																																																																																						
1.845 G	3.000 G	1.00 M	2.953212 G	-29.03	-16.03																																																																																						
3.000 G	7.000 G	1.00 M	3.087000 G	-36.99	-23.99																																																																																						
7.000 G	13.600 G	1.00 M	10.215800 G	-35.96	-22.96																																																																																						
13.600 G	19.100 G	1.00 M	15.056525 G	-25.04	-12.04																																																																																						



Frequency Stability

Test Conditions	Middle Channel	GSM850 (GPRS class 8)	Limit
		Deviation (ppm)	2.5ppm
Temperature (°C)	Voltage (Volt)		Result
50	Normal Voltage	0.0012	PASS
40	Normal Voltage	0.0048	
30	Normal Voltage	0.0060	
20(Ref.)	Normal Voltage	0.0000	
10	Normal Voltage	0.0060	
0	Normal Voltage	0.0036	
-10	Normal Voltage	0.0072	
-20	Normal Voltage	0.0191	
-30	Normal Voltage	0.0311	
20	Maximum Voltage	0.0000	
20	Normal Voltage	0.0000	
20	Battery End Point	0.0012	

Test Conditions	Middle Channel	GSM1900 (GPRS class 8)	Limit
		Deviation (ppm)	Note 2.
Temperature (°C)	Voltage (Volt)		Result
50	Normal Voltage	0.0012	PASS
40	Normal Voltage	0.0048	
30	Normal Voltage	0.0060	
20(Ref.)	Normal Voltage	0.0000	
10	Normal Voltage	0.0060	
0	Normal Voltage	0.0036	
-10	Normal Voltage	0.0072	
-20	Normal Voltage	0.0191	
-30	Normal Voltage	0.0311	
20	Maximum Voltage	0.0000	
20	Normal Voltage	0.0000	
20	Battery End Point	0.0012	

Note:

1. Normal Voltage = 4.0V. ; Battery End Point (BEP) = 3.7 V. ; Maximum Voltage =4.0 V
2. The frequency fundamental emissions stay within the authorized frequency block.



A3. WCDMA

Peak-to-Average Ratio

Mode	WCDMA Band V	Limit: 13dB
Mod.	RMC 12.2Kbps	Result
Lowest CH	2.88	PASS
Middle CH	3.16	
Highest CH	3.24	

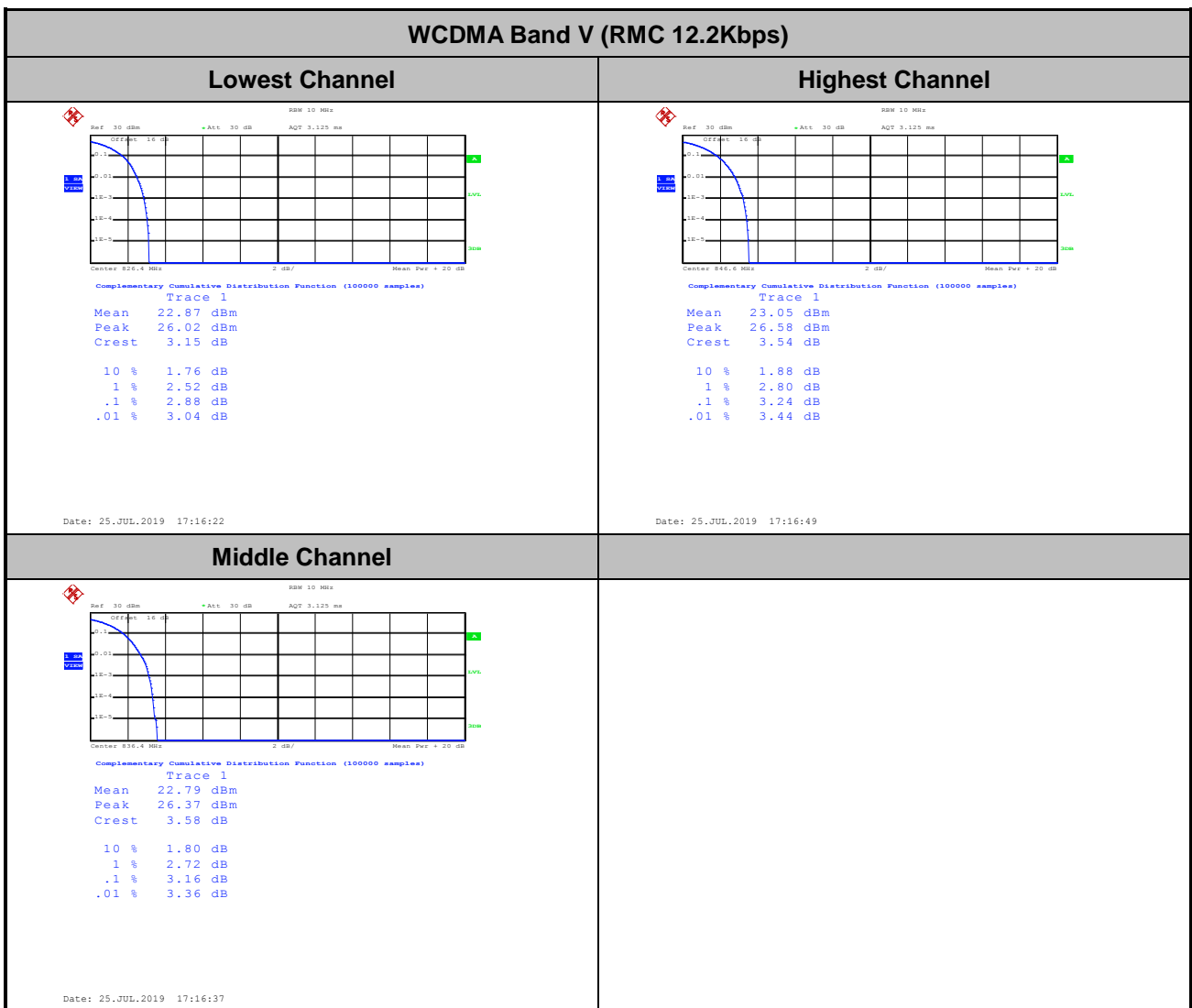



26dB Bandwidth

Mode	WCDMA Band V
Mod.	RMC 12.2Kbps
Lowest CH	4.71
Middle CH	4.73
Highest CH	4.73

WCDMA Band V (RMC 12.2Kbps)

Lowest Channel

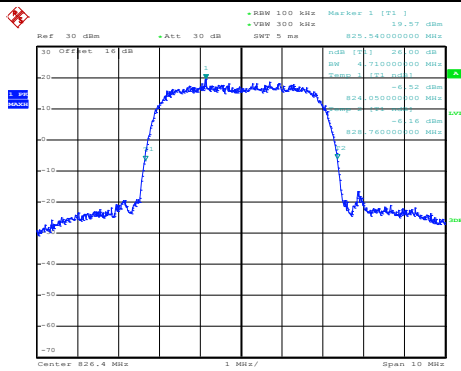

Date: 25.JUL.2019 17:02:54

Highest Channel

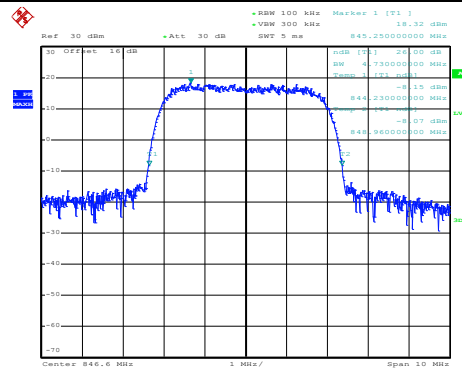

Date: 25.JUL.2019 17:04:03

Middle Channel

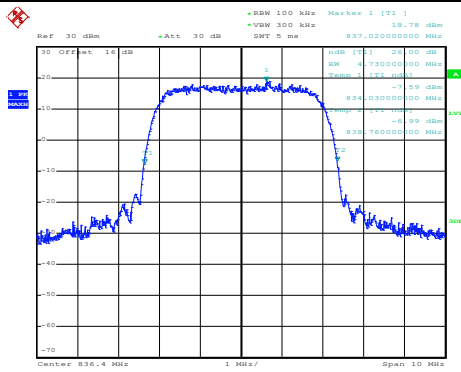

Date: 25.JUL.2019 17:03:28



Occupied Bandwidth

Mode	WCDMA Band V
Mod.	RMC 12.2Kbps
Lowest CH	4.14
Middle CH	4.15
Highest CH	4.15

WCDMA Band V (RMC 12.2Kbps)

Lowest Channel

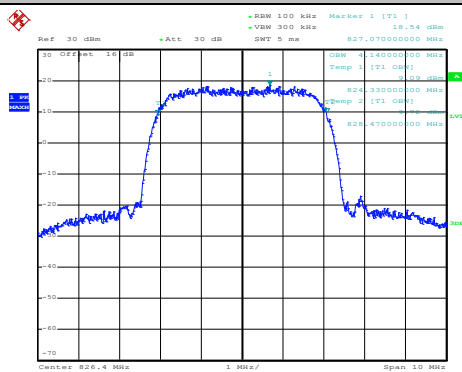

Date: 25.JUL.2019 17:04:44

Highest Channel

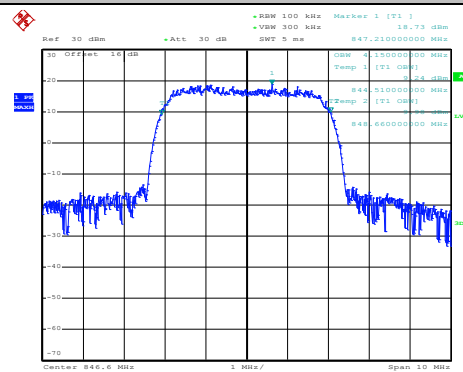

Date: 25.JUL.2019 17:05:53

Middle Channel

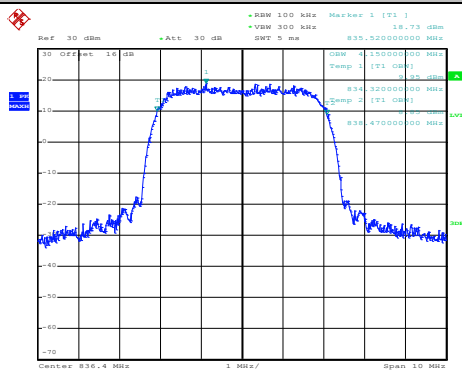

Date: 25.JUL.2019 17:05:18



Conducted Band Edge

WCDMA Band V (RMC 12.2Kbps)

Lowest Band Edge

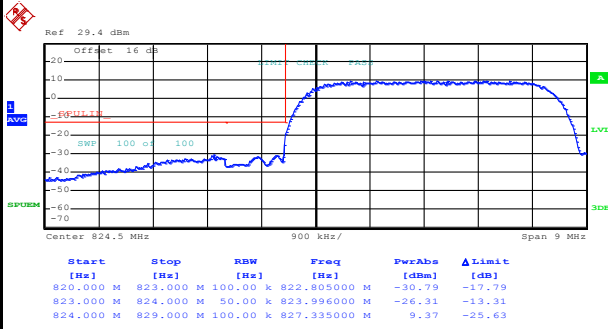

Date: 25.JUL.2019 17:09:19

Highest Band Edge

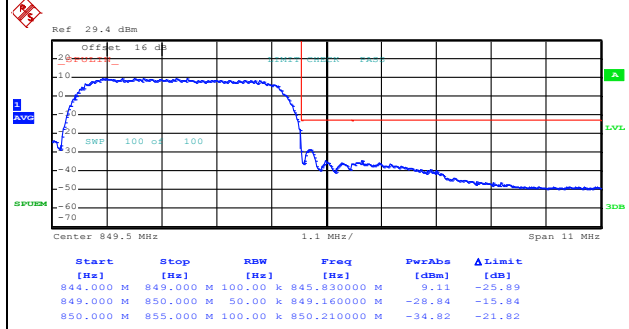

Date: 25.JUL.2019 17:12:10



Conducted Spurious Emission

WCDMA Band V (RMC 12.2Kbps)

Lowest Channel

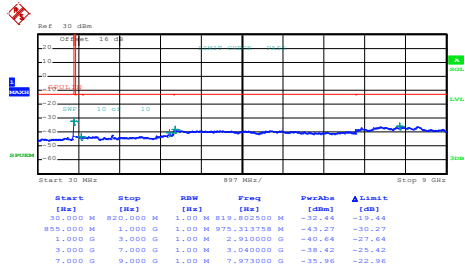

Date: 25.JUL.2019 17:13:42

Highest Channel

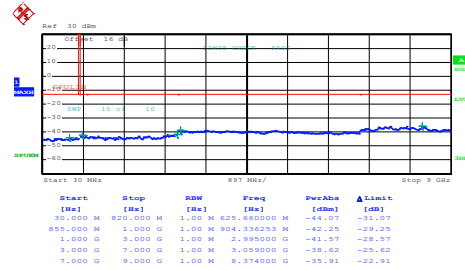

Date: 25.JUL.2019 17:15:49

Middle Channel

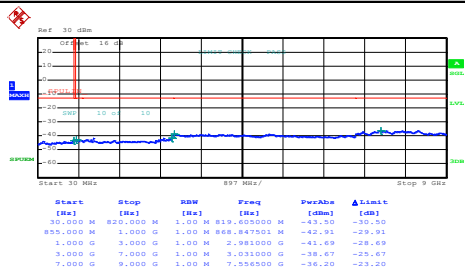

Date: 25.JUL.2019 17:14:55



Frequency Stability

Test Conditions	Middle Channel	WCDMA Band V (RMC 12.2Kbps)	Limit 2.5ppm
Temperature (°C)	Voltage (Volt)	Deviation (ppm)	Result
50	Normal Voltage	0.0000	PASS
40	Normal Voltage	0.0024	
30	Normal Voltage	0.0012	
20(Ref.)	Normal Voltage	0.0000	
10	Normal Voltage	0.0120	
0	Normal Voltage	0.0132	
-10	Normal Voltage	0.0132	
-20	Normal Voltage	0.0155	
-30	Normal Voltage	0.0155	
20	Maximum Voltage	0.0000	
20	Normal Voltage	0.0000	
20	Battery End Point	0.0024	

Note:

- 1. Normal Voltage = 4.0V. ; Battery End Point (BEP) = 3.7 V. ; Maximum Voltage =4.0 V
- 2. The frequency fundamental emissions stay within the authorized frequency block.



Appendix B. Test Results of ERP/EIRP and Radiated Test

ERP/EIRP

Channel	Mode	Conducted		ERP	
		Power (dBm)	Power (Watts)	ERP(dBm)	ERP(W)
Lowest	GSM850	32.06	1.6069	23.91	0.2460
Middle	GPRS class 8	32.09	1.6181	23.94	0.2477
Highest	(GT - LC = -6 dB)	31.94	1.5631	23.79	0.2393
Lowest	WCDMA Band V	23.79	0.2393	15.64	0.0366
Middle	RMC 12.2Kbps	23.87	0.2438	15.72	0.0373
Highest	(GT - LC = -6 dB)	23.94	0.2477	15.79	0.0379
Limit	ERP < 7W	Result		PASS	

Channel	Mode	Conducted		EIRP	
		Power (dBm)	Power (Watts)	EIRP(dBm)	EIRP(W)
Lowest	GSM1900	29.01	0.7962	25.91	0.3899
Middle	GPRS class 8	28.87	0.7709	25.77	0.3776
Highest	(GT - LC = -3.1 dB)	28.94	0.7834	25.84	0.3837
Limit	EIRP < 2W	Result		PASS	



Radiated Spurious Emission

Part 22H GPRS 850

GPRS 850									
Channel	Frequency (MHz)	ERP (dBm)	Limit (dBm)	Over Limit (dB)	SPA Reading (dBm)	S.G. Power (dBm)	TX Cable loss (dB)	TX Antenna Gain (dBi)	Polarization (H/V)
Lowest	1648	-53.78	-13	-40.78	-63.66	-60.73	0.53	9.63	H
	2472	-56.07	-13	-43.07	-69.53	-64.05	0.65	10.78	H
	3297	-58.38	-13	-45.38	-74.49	-67.46	0.76	11.99	H
									H
									H
									H
	1648	-54.79	-13	-41.79	-64.38	-61.74	0.53	9.63	V
	2472	-52.39	-13	-39.39	-66.34	-60.37	0.65	10.78	V
	3297	-58.78	-13	-45.78	-74.86	-67.86	0.76	11.99	V
									V
Middle	1672	-55.10	-13	-42.10	-65.14	-62.1	0.53	9.68	H
	2512	-54.75	-13	-41.75	-68.2	-62.75	0.66	10.81	H
	3346	-58.51	-13	-45.51	-74.74	-67.73	0.76	12.14	H
									H
									H
									H
	1672	-55.30	-13	-42.30	-64.94	-62.3	0.53	9.68	V
	2512	-49.08	-13	-36.08	-62.94	-57.08	0.66	10.81	V
	3346	-58.86	-13	-45.86	-74.83	-68.08	0.76	12.14	V
									V
Highest	1696	-58.51	-13	-45.51	-68.84	-65.56	0.53	9.73	H
	2544	-50.95	-13	-37.95	-64.45	-58.96	0.67	10.83	H
	3393	-58.54	-13	-45.54	-74.85	-67.9	0.77	12.28	H
									H
									H
									H
	1696	-57.60	-13	-44.60	-67.31	-64.65	0.53	9.73	V
	2544	-48.08	-13	-35.08	-61.95	-56.09	0.67	10.83	V
	3393	-58.89	-13	-45.89	-74.79	-68.25	0.77	12.28	V
									V

Remark: Spurious emissions within 30-1000MHz were found more than 20dB below limit line.



Part 22H WCDMA 850

WCDMA 850									
Channel	Frequency (MHz)	ERP (dBm)	Limit (dBm)	Over Limit (dB)	SPA Reading (dBm)	S.G. Power (dBm)	TX Cable loss (dB)	TX Antenna Gain (dBi)	Polarization (H/V)
Lowest	1650	-60.45	-13	-47.45	-70.34	-67.4	0.53	9.63	H
	2479	-60.02	-13	-47.02	-73.48	-68	0.65	10.78	H
	3306	-58.66	-13	-45.66	-74.78	-67.77	0.76	12.02	H
									H
									H
									H
	1650	-60.32	-13	-47.32	-69.92	-67.27	0.53	9.63	V
	2479	-60.09	-13	-47.09	-74.04	-68.07	0.65	10.78	V
	3306	-58.43	-13	-45.43	-74.52	-67.54	0.76	12.02	V
									V
									V
Middle	1672	-60.38	-13	-47.38	-70.42	-67.38	0.53	9.68	H
	2509	-60.48	-13	-47.48	-73.93	-68.48	0.66	10.81	H
	3346	-58.68	-13	-45.68	-74.91	-67.9	0.76	12.14	H
									H
									H
									H
	1672	-60.71	-13	-47.71	-70.35	-67.71	0.53	9.68	V
	2509	-59.85	-13	-46.85	-73.71	-67.85	0.66	10.81	V
	3346	-58.67	-13	-45.67	-74.64	-67.89	0.76	12.14	V
									V
									V
Highest	1695	-58.43	-13	-45.43	-68.76	-65.48	0.53	9.73	H
	2540	-60.44	-13	-47.44	-73.94	-68.45	0.67	10.82	H
	3386	-58.48	-13	-45.48	-74.79	-67.82	0.77	12.26	H
									H
									H
									H
	1695	-59.54	-13	-46.54	-69.24	-66.59	0.53	9.73	V
	2540	-59.86	-13	-46.86	-73.73	-67.87	0.67	10.82	V
	3386	-59.16	-13	-46.16	-75.06	-68.5	0.77	12.26	V
									V
									V

Remark: Spurious emissions within 30-1000MHz were found more than 20dB below limit line.



Part 24E GPRS 1900

GPRS 1900									
Channel	Frequency (MHz)	EIRP (dBm)	Limit (dBm)	Over Limit (dB)	SPA Reading (dBm)	S.G. Power (dBm)	TX Cable loss (dB)	TX Antenna Gain (dBi)	Polarization (H/V)
Lowest	3702	-52.42	-13	-39.42	-69.4	-64.21	0.72	12.52	H
	5550	-54.77	-13	-41.77	-76.58	-66.94	1.00	13.17	H
	7400.8	-52.78	-13	-39.78	-77.85	-62.18	1.18	10.58	H
									H
									H
									H
	3702	-50.87	-13	-37.87	-69.02	-62.66	0.72	12.52	V
	5550	-54.73	-13	-41.73	-76.63	-66.9	1.00	13.17	V
	7400.8	-52.98	-13	-39.98	-77.84	-62.38	1.18	10.58	V
									V
Middle	3762	-55.64	-13	-42.64	-72.77	-67.45	0.69	12.50	H
	5640	-53.91	-13	-40.91	-75.62	-66.04	0.98	13.12	H
	7520	-52.63	-13	-39.63	-77.55	-61.91	1.18	10.46	H
									H
									H
									H
	3762	-53.03	-13	-40.03	-71.37	-64.84	0.69	12.50	V
	5640	-54.58	-13	-41.58	-76.46	-66.71	0.98	13.12	V
	7520	-52.57	-13	-39.57	-77.54	-61.85	1.18	10.46	V
									V
Highest	3822	-56.09	-13	-43.09	-73.34	-67.87	0.69	12.47	H
	5729.4	-52.16	-13	-39.16	-73.87	-64.23	0.99	13.06	H
	7639.2	-51.57	-13	-38.57	-76.73	-61.18	1.18	10.79	H
									H
									H
									H
	3822	-55.74	-13	-42.74	-74.21	-67.52	0.69	12.47	V
	5729.4	-53.37	-13	-40.37	-75.29	-65.44	0.99	13.06	V
	7639.2	-51.96	-13	-38.96	-76.87	-61.57	1.18	10.79	V
									V

Remark: Spurious emissions within 30-1000MHz were found more than 20dB below limit line.