

FCC Test Report (PART 22)

Report No.: RF190617E03B-1

FCC ID: APYHRO00274

Received Date: July 09, 2019

Test Date: July 15 to 24, 2019

Issued Date: Aug. 22, 2019

Applicant: Sharp Corporation

Address: 1 Takumi-cho, Sakai-ku, Sakai City Osaka, 590-8522 Japan

Issued By: Bureau Veritas Consumer Products Services (H.K.) Ltd., Taoyuan Branch
Hsin Chu Laboratory

Lab Address: E-2, No.1, Li Hsin 1st Road, Hsinchu Science Park, Hsinchu City 300,
Taiwan R.O.C.

Test Location: E-2, No.1, Li Hsin 1st Road, Hsinchu Science Park, Hsinchu City 300,
Taiwan R.O.C.

**FCC Registration /
Designation Number:** 723255 / TW2022



This report is for your exclusive use. Any copying or replication of this report to or for any other person or entity, or use of our name or trademark, is permitted only with our prior written permission. This report sets forth our findings solely with respect to the test samples identified herein. The results set forth in this report are not indicative or representative of the quality or characteristics of the lot from which a test sample was taken or any similar or identical product unless specifically and expressly noted. Our report includes all of the tests requested by you and the results thereof based upon the information that you provided to us. You have 60 days from date of issuance of this report to notify us of any material error or omission caused by our negligence, provided, however, that such notice shall be in writing and shall specifically address the issue you wish to raise. A failure to raise such issue within the prescribed time shall constitute your unqualified acceptance of the completeness of this report, the tests conducted and the correctness of the report contents. Unless specific mention, the uncertainty of measurement has been explicitly taken into account to declare the compliance or non-compliance to the specification. The report must not be used by the client to claim product certification, approval, or endorsement by TAF or any government agencies.

Table of Contents

Release Control Record	4
1 Certificate of Conformity	5
2 Summary of Test Results	6
2.1 Measurement Uncertainty	6
2.2 Test Site and Instruments	7
3 General Information	9
3.1 General Description of EUT	9
3.2 Configuration of System under Test	12
3.2.1 Description of Support Units	13
3.3 Test Mode Applicability and Tested Channel Detail	14
3.4 EUT Operating Conditions	16
3.5 General Description of Applied Standards	17
4 Test Types and Results	18
4.1 Output Power Measurement	18
4.1.1 Limits of Output Power Measurement	18
4.1.2 Test Procedures	18
4.1.3 Test Setup	18
4.1.4 Test Results	19
4.2 Modulation characteristics Measurement	24
4.2.1 Limits of Modulation characteristics	24
4.2.2 Test Procedure	24
4.2.3 Test Setup	24
4.2.4 Test Results	25
4.3 Frequency Stability Measurement	27
4.3.1 Limits of Frequency Stability Measurement	27
4.3.2 Test Procedure	27
4.3.3 Test Setup	27
4.3.4 Test Results	28
4.4 Occupied Bandwidth Measurement	30
4.4.1 Test Procedure	30
4.4.2 Test Setup	30
4.4.3 Test Result (-26dB Bandwidth)	31
4.4.4 Test Result (Occupied Bandwidth)	33
4.5 Band Edge Measurement	35
4.5.1 Limits of Band Edge Measurement	35
4.5.2 Test Setup	35
4.5.3 Test Procedures	35
4.5.4 Test Results	36
4.6 Peak to Average Ratio	41
4.6.1 Limits of Peak to Average Ratio Measurement	41
4.6.2 Test Setup	41
4.6.3 Test Procedures	41
4.6.4 Test Results	42
4.7 Conducted Spurious Emissions	44
4.7.1 Limits of Conducted Spurious Emissions Measurement	44
4.7.2 Test Setup	44
4.7.3 Test Procedure	44
4.7.4 Test Results	45
4.8 Radiated Emission Measurement	50
4.8.1 Limits of Radiated Emission Measurement	50
4.8.2 Test Procedure	50
4.8.3 Deviation from Test Standard	50
4.8.4 Test Setup	51

4.8.5 Test Results	52
Appendix – Information of the Testing Laboratories	83

Release Control Record

Issue No.	Description	Date Issued
RF190617E03B-1	Original release.	Aug. 22, 2019

1 Certificate of Conformity

Product: Wireless router

Sample Status: ENGINEERING SAMPLE

Applicant: Sharp Corporation

Test Date: July 15 to 24, 2019

Standards: FCC Part 22, Subpart H

The above equipment has been tested by **Bureau Veritas Consumer Products Services (H.K.) Ltd., Taoyuan Branch**, and found compliance with the requirement of the above standards. The test record, data evaluation & Equipment Under Test (EUT) configurations represented herein are true and accurate accounts of the measurements of the sample's EMC characteristics under the conditions specified in this report.

Prepared by : Wendy Wu , **Date:** Aug. 22, 2019
Wendy Wu / Specialist

Approved by : May Chen , **Date:** Aug. 22, 2019
May Chen / Manager

2 Summary of Test Results

Applied Standard: FCC Part 22 & Part 2			
FCC Clause	Test Item	Result	Remarks
2.1046 22.913 (a)	Effective radiated power	PASS	Meet the requirement of limit.
---	Peak to Average Ratio	PASS	Meet the requirement of limit.
2.1047	Modulation characteristics	PASS	Meet the requirement
2.1055 22.355	Frequency Stability	PASS	Meet the requirement of limit.
2.1049	Occupied Bandwidth	PASS	Meet the requirement of limit.
22.917	Band Edge Measurements	PASS	Meet the requirement of limit.
2.1051 22.917	Conducted Spurious Emissions	PASS	Meet the requirement of limit.
2.1053 22.917	Radiated Spurious Emissions	PASS	Meet the requirement of limit. Minimum passing margin is -35.11dB at 3345.6MHz.

Note: Determining compliance based on the results of the compliance measurement, not taking into account measurement instrumentation uncertainty.

2.1 Measurement Uncertainty

Where relevant, the following measurement uncertainty levels have been estimated for tests performed on the EUT as specified in CISPR 16-4-2:

Measurement	Frequency	Expanded Uncertainty (k=2) (\pm)
Radiated Emissions up to 1 GHz	30MHz ~ 1GHz	4.8 dB
Radiated Emissions above 1 GHz	1GHz ~ 6GHz	5.1 dB
	6GHz ~ 18GHz	4.9 dB
	18GHz ~ 40GHz	5.2 dB

2.2 Test Site and Instruments

For radiated spurious emissions test:

DESCRIPTION & MANUFACTURER	MODEL NO.	SERIAL NO.	CALIBRATED DATE	CALIBRATED UNTIL
Test Receiver Keysight	N9038A	MY54450088	July 03, 2019	July 02, 2020
Pre-Amplifier EMCI	EMC001340	980142	Jan. 25, 2019	Jan. 24, 2020
Loop Antenna Electro-Metrics	EM-6879	269	Sep. 07, 2018	Sep. 06, 2019
RF Cable	NA	LOOPCAB-001	Jan. 14, 2019	Jan. 13, 2020
RF Cable	NA	LOOPCAB-002	Jan. 14, 2019	Jan. 13, 2020
Pre-Amplifier Mini-Circuits	ZFL-1000VH2B	AMP-ZFL-01	Oct. 30, 2018	Oct. 29, 2019
Trilog Broadband Antenna SCHWARZBECK	VULB 9168	9168-406	Nov. 22, 2018	Nov. 21, 2019
RF Cable	8D	966-4-1	Mar. 19, 2019	Mar. 18, 2020
RF Cable	8D	966-4-2	Mar. 19, 2019	Mar. 18, 2020
RF Cable	8D	966-4-3	Mar. 19, 2019	Mar. 18, 2020
Fixed attenuator Mini-Circuits	UNAT-5+	PAD-3m-4-01	Sep. 27, 2018	Sep. 26, 2019
Horn_Antenna SCHWARZBECK	BBHA 9120D	9120D-783	Nov. 25, 2018	Nov. 24, 2019
Pre-Amplifier EMCI	EMC12630SE	980385	Aug. 16, 2018	Aug. 15, 2019
RF Cable	EMC104-SM-SM-1200	160923	Jan. 28, 2019	Jan. 27, 2020
RF Cable	104 RF cable	131215	Jan. 10, 2019	Jan. 09, 2020
RF Cable	EMC104-SM-SM-6000	180418	May 03, 2019	May 02, 2020
Pre-Amplifier EMCI	EMC184045SE	980387	Jan. 28, 2019	Jan. 27, 2020
Horn_Antenna SCHWARZBECK	BBHA 9170	BBHA9170519	Nov. 25, 2018	Nov. 24, 2019
RF Cable	EMC102-KM-KM-1200	160924	Jan. 28, 2019	Jan. 27, 2020
RF Cable	EMC102-KM-KM-1200	160925	Jan. 28, 2019	Jan. 27, 2020
Software	ADT_Radiated_V8.7.08	NA	NA	NA
Boresight Antenna Tower & Turn Table Max-Full	MF-7802BS	MF780208530	NA	NA

Note:

1. The calibration interval of the above test instruments is 12 months and the calibrations are traceable to NML/ROC and NIST/USA.
2. The test was performed in 966 Chamber No. 4.
3. Loop antenna was used for all emissions below 30 MHz.
4. Tested Date: July 20 to 24, 2019

For other test:

DESCRIPTION & MANUFACTURER	MODEL NO.	SERIAL NO.	CALIBRATED DATE	CALIBRATED UNTIL
Spectrum Analyzer R&S	FSV40	100964	June 04, 2019	June 03, 2020
Power meter Anritsu	ML2495A	1014008	May 13, 2019	May 12, 2020
Power sensor Anritsu	MA2411B	0917122	May 13, 2019	May 12, 2020
Fixed Attenuator Mini-Circuits	MDCS18N-10	MDCS18N-10-01	Apr. 15, 2019	Apr. 14, 2020
AC Power Source Extech Electronics	6205	1440452	NA	NA
DC Power Supply Topward	6603D	795558	NA	NA
Temperature & Humidity Chamber Giant Force	GTH-150-40-SP-AR	MAA0812-008	Jan. 09, 2019	Jan. 08, 2020
True RMS Clamp Meter FLUKE	325	31130711WS	May 21, 2019	May 20, 2020
ESG Vector signal generator Agilent	E4438C	MY45094468/ 005 506 602 UK6 UNJ	Nov. 19, 2018	Nov. 18, 2019
Mech Switch Absorptive Mini-Circuits	MSP4TA-18+	0140	Feb. 11, 2019	Feb. 10, 2020
FXD ATTEN Mini-Circuits	BW-S3W2+	MN71981	Feb. 11, 2019	Feb. 10, 2020
Software	ADT_RF Test Software V6.6.5.4	NA	NA	NA
Universal Radio Communication Tester R&S	CMU200	121040	Apr. 17, 2019	Apr. 16, 2020
Spectrum Analyzer Keysight	N9030A	MY55410176	July 03, 2019	July 02, 2020

- NOTE:**
1. The test was performed in Oven room 2.
 2. The calibration interval of the above test instruments is 12 months and the calibrations are traceable to NML/ROC and NIST/USA.
 3. Tested Date: July 15 to 18, 2019

3 General Information

3.1 General Description of EUT

Product	Wireless router	
Status of EUT	ENGINEERING SAMPLE	
Power Supply Rating	Refer to Note	
Modulation Type	WCDMA, HSDPA, HSUPA, DC-HSDPA	BPSK
	LTE Band 5	QPSK, 16QAM, 64QAM
Operating Frequency	WCDMA Band 5	826.4MHz ~846.6MHz
	LTE Band 5	824.7MHz ~ 848.3MHz
Max. ERP Power	WCDMA Band 5	18.97dBm
	LTE Band 5 (Channel Bandwidth 1.4MHz)	18.53dBm
	LTE Band 5 (Channel Bandwidth 3MHz)	18.47dBm
	LTE Band 5 (Channel Bandwidth 5MHz)	18.62dBm
	LTE Band 5 (Channel Bandwidth 10MHz)	18.64dBm
Emission Designator	WCDMA Band 5	4M14F9W
	LTE Band 5 (Channel Bandwidth 1.4MHz)	QPSK: 1M09G7D 16QAM: 1M09D7W 64QAM: 1M09D7W
	LTE Band 5 (Channel Bandwidth 3MHz)	QPSK: 2M70G7D 16QAM: 2M68D7W 64QAM: 2M70D7W
	LTE Band 5 (Channel Bandwidth 5MHz)	QPSK: 4M50G7D 16QAM: 4M51D7W 64QAM: 4M51D7W
	LTE Band 5 (Channel Bandwidth 10MHz)	QPSK: 9M00G7D 16QAM: 9M00D7W 64QAM: 9M00D7W
Antenna Type	Refer to Note	
Antenna Connector	Refer to Note	
Accessory Device	Cradle x1 (Option, Model: J03W039.02) AC Adapter x 1	
Data Cable Supplied	NA	

Note:

1. Simultaneously transmission condition.

Condition	Technology	
1	WLAN	WWAN

Note: The emission of the simultaneous operation has been evaluated and no non-compliance was found.

2. The EUT must be supplied one power adapter or Battery as the following table:

Adapter		
Model No.	Spec.	
SB-AC19TCPD	Input: 100-240V, 0.7A, 50/60Hz Output: 5V/7V/9V/12V, 3.0A/3.0A/3.0A/2.25A DC output cable (Unshielded, 1.6m)	
Battery		
Brand	Model No.	Spec.
NA	UBATIA301AFN2	3.85 Vdc, 4000mAh

3. The antennas provided to the EUT, please refer to the following table:

Antenna No.	RF Chain No.	Antenna Net Gain(dBi)	Frequency range (MHz)	Antenna Type	Connector Type
1	Main	Please refer to below table	Please refer to below table	PIFA	NA
2	Aux	Please refer to below table	Please refer to below table	PIFA	NA
3	Aux / chain0	Please refer to below table	Please refer to below table	PIFA	NA
4	Aux / chain1	Please refer to below table	Please refer to below table	PIFA	NA

Antenna gain list					
Band	Freq. Range (MHz)	Gain (dBi)			
		Ant 1 (Main)	Ant 2 (Aux)	Ant 3 (Aux / chain0)	Ant 4 (Aux / chain1)
WLAN 2.4GHz	2.4~2.4835	NA	NA	-0.843	-0.484
WCDMA II (B2)	1850~1910	-2.01	-2.67	-2.67	-3.77
WCDMA IV (B4)	1710~1755	-2.63	-3.67	-3.67	-3.67
WCDMA V (B5)	824~849	-2.21	NA	NA	NA
LTE Band (2)	1850~1910	-2.01	-2.67	-2.67	-3.77
LTE Band (4)	1710~1755	-2.63	-3.67	-3.67	-3.67
LTE Band (5)	824~849	-2.21	NA	NA	NA
LTE Band (12)	698~716	-6.05	NA	NA	NA
LTE Band (17)	704~716	-6.05	NA	NA	NA

4. For radiated emissions, the EUT was pre-tested under the following modes:

Test Mode	Description
Mode A	Power from USB adapter (positioned: X-plane)
Mode B	Power from USB adapter (positioned: Y-plane)
Mode C	Power from USB adapter (positioned: Z-plane)
Mode D	Power from Battery (positioned: Z-plane)
Mode E	Power from Cradle

Note: From the above modes, the worst case was found in **Mode E**. Therefore only the test data of the mode was recorded in this report.

5. The above EUT information is declared by manufacturer and for more detailed features description, please refer to the manufacturer's specifications or User's Manual.

3.2 Configuration of System under Test

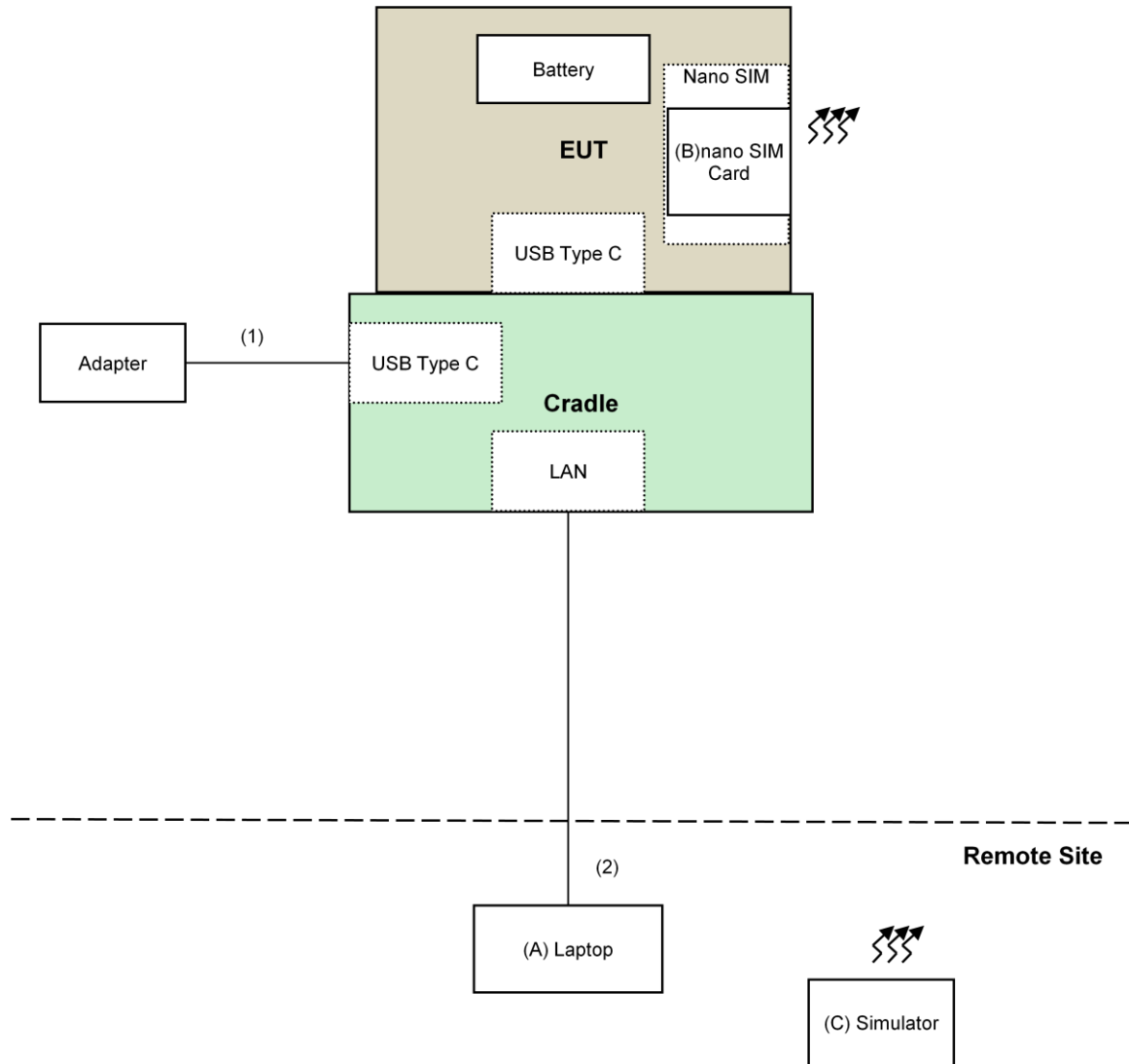

3.2.1 Description of Support Units

The EUT has been tested as an independent unit together with other necessary accessories or support units. The following support units or accessories were used to form a representative test configuration during the tests.

ID	Product	Brand	Model No.	Serial No.	FCC ID	Remarks
A.	Laptop	DELL	E6420	B92T3R1	FCC DoC	Provided by Lab
B.	SIM Card	NA	NA	NA	NA	Provided by Lab
C.	Simulator	Anritsu	MT8820C	6201127458	NA	Provided by Lab

Note:

1. All power cords of the above support units are non-shielded (1.8m).

ID	Descriptions	Qty.	Length (m)	Shielding (Yes/No)	Cores (Qty.)	Remarks
1.	DC Cable	1	1.6	No	0	Supplied by client
2.	RJ-45 Cable	1	10	No	0	Provided by Lab

3.3 Test Mode Applicability and Tested Channel Detail

Pre-Scan has been conducted to determine the worst-case mode from all possible combinations between available modulations, data rates, XYZ axis and antenna ports

The worst case was found when positioned on X-plane. Following channel(s) was (were) selected for the final test as listed below:

WCDMA Band 5 MODE

Test Item	Available Channel	Tested Channel	Mode
ERP	4132 to 4233	4132, 4182, 4233	WCDMA
Frequency Stability	4132 to 4233	4182	WCDMA
Occupied Bandwidth	4132 to 4233	4132, 4182, 4233	WCDMA
Peak to Average Ratio	4132 to 4233	4132, 4182, 4233	WCDMA
Band Edge	4132 to 4233	4132, 4233	WCDMA
Conducted Emission	4132 to 4233	4132, 4182, 4233	WCDMA
Radiated Emission Below 1GHz	4132 to 4233	4132, 4182, 4233	WCDMA
Radiated Emission Above 1GHz	4132 to 4233	4132, 4182, 4233	WCDMA

LTE Band 5

TEST ITEM	AVAILABLE CHANNEL	TESTED CHANNEL	CHANNEL BANDWIDTH	MODULATION	MODE
ERP	20407 to 20643	20407, 20525, 20643	1.4MHz	QPSK/16QAM/64QAM	1RB / 0 RB offset
	20415 to 20635	20415, 20525, 20635	3MHz	QPSK/16QAM/64QAM	1RB / 0 RB offset
	20425 to 20625	20425, 20525, 20625	5MHz	QPSK/16QAM/64QAM	1RB / 0 RB offset
	20450 to 20600	20450, 20525, 20600	10MHz	QPSK/16QAM/64QAM	1RB / 0 RB offset
Frequency Stability	20407 to 20643	20525	1.4MHz	QPSK	-
	20415 to 20635	20525	3MHz	QPSK	-
	20425 to 20625	20525	5MHz	QPSK	-
	20450 to 20600	20525	10MHz	QPSK	-
Occupied Bandwidth	20407 to 20643	20407, 20525, 20643	1.4MHz	QPSK/16QAM/64QAM	Full RB
	20415 to 20635	20415, 20525, 20635	3MHz	QPSK/16QAM/64QAM	Full RB
	20425 to 20625	20425, 20525, 20625	5MHz	QPSK/16QAM/64QAM	Full RB
	20450 to 20600	20450, 20525, 20600	10MHz	QPSK/16QAM/64QAM	Full RB
Peak to Average Ratio	20407 to 20643	20407, 20525, 20643	1.4MHz	QPSK/16QAM/64QAM	Full RB
	20415 to 20635	20415, 20525, 20635	3MHz	QPSK/16QAM/64QAM	Full RB
	20425 to 20625	20425, 20525, 20625	5MHz	QPSK/16QAM/64QAM	Full RB
	20450 to 20600	20450, 20525, 20600	10MHz	QPSK/16QAM/64QAM	Full RB
Band Edge	20407 to 20643	20407	1.4MHz	QPSK	1 RB / 0 RB Offset
		20643			1 RB / 5 RB Offset
		20407, 20643			6 RB / 0 RB Offset
	20415 to 20635	20415	3MHz	QPSK	1 RB / 0 RB Offset
		20635			1 RB / 14 RB Offset
		20415, 20635			15 RB / 0 RB Offset
	20425 to 20625	20425	5MHz	QPSK	1 RB / 0 RB Offset
		20625			1 RB / 24 RB Offset
		20425, 20625			25 RB / 0 RB Offset
	20450 to 20600	20450	10MHz	QPSK	1 RB / 0 RB Offset
		20600			1 RB / 49 RB Offset
		20450, 20600			50 RB / 0 RB Offset
Conducted Emission	20407 to 20643	20407, 20525, 20643	1.4MHz	QPSK	1RB / 0 RB offset
	20415 to 20635	20415, 20525, 20635	3MHz	QPSK	1RB / 0 RB offset
	20425 to 20625	20425, 20525, 20625	5MHz	QPSK	1RB / 0 RB offset
	20450 to 20600	20450, 20525, 20600	10MHz	QPSK	1RB / 0 RB offset
Radiated Emission	20407 to 20643	20407, 20525, 20643	1.4MHz	QPSK	1RB / 0 RB offset
	20415 to 20635	20415, 20525, 20635	3MHz	QPSK	1RB / 0 RB offset
	20425 to 20625	20425, 20525, 20625	5MHz	QPSK	1RB / 0 RB offset
	20450 to 20600	20450, 20525, 20600	10MHz	QPSK	1RB / 0 RB offset

NOTE:

All supported modulation types were evaluated. The Worst case of QPSK was selected. Therefore, the Band Edge, Frequency Stability, Condcudeted Emission and Radiated Emission were presented under QPSK mode only.

Test Condition:

Test Item	Environmental Conditions	Input Power (System)	Tested By
ERP	25deg. C, 63%RH	120Vac, 60Hz	Jyunchun Lin
Frequency Stability	25deg. C, 63%RH	120Vac, 60Hz	Jyunchun Lin
Occupied Bandwidth	25deg. C, 63%RH	120Vac, 60Hz	Jyunchun Lin
Band Edge	25deg. C, 63%RH	120Vac, 60Hz	Jyunchun Lin
Peak to Average Ratio	25deg. C, 63%RH	120Vac, 60Hz	Jyunchun Lin
Conducuted Emission	25deg. C, 63%RH	120Vac, 60Hz	Jyunchun Lin
Radiated Emission Below 1GHz	25deg. C, 75%RH	120Vac, 60Hz	Robert Cheng
Radiated Emission Above 1GHz	25deg. C, 75%RH	120Vac, 60Hz	Robert Cheng

3.4 EUT Operating Conditions

The communication simulator station system controlled a EUT to export maximum output power under transmission mode and specific channel frequency

3.5 General Description of Applied Standards

The EUT is a RF Product. According to the specifications of the manufacturer, it must comply with the requirements of the following standards:

FCC 47 CFR Part 2

FCC 47 CFR Part 22, Subpart H

KDB 971168 D01 Power Meas License Digital Systems v03r01

ANSI/TIA/EIA-603-E 2016

ANSI 63.26-2015

NOTE: All test items have been performed and recorded as per the above standards.

4 Test Types and Results

4.1 Output Power Measurement

4.1.1 Limits of Output Power Measurement

Mobile / Portable station are limited to 7 watts e.r.p.

4.1.2 Test Procedures

Conducted Power Measurement:

The EUT was set up for the maximum power with WCDMA / LTE link data modulation and link up with simulator. Set the EUT to transmit under low, middle and high channel and difference RB size/ RB offset for difference bandwidth record the power level shown on power meter.

EIRP / ERP Measurement:

- EIRP = Conducted Output power level + Antenna gain.
- ERP power can be calculated form EIRP power by subtracting the gain of dipole, ERP power = EIPR power - 2.15dBi.
- ERP = Conducted Output power level + Antenna gain (dBi) - Isotropically Factor (2.15dB).

4.1.3 Test Setup

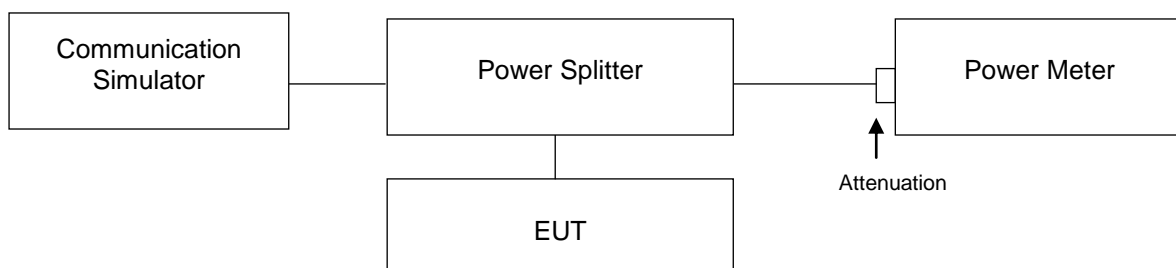

For the actual test configuration, please refer to the attached file (Test Setup Photo).

4.1.4 Test Results

CONDUCTED OUTPUT POWER (dBm)

WCDMA Band 5

Band	WCDMA V		
	4132	4182	4233
Channel	826.4	836.4	846.6
Frequency (MHz)	23.33	23.29	23.20
RMC	22.40	22.23	22.21
HSDPA Subtest-1	22.40	22.29	22.25
HSDPA Subtest-2	21.90	21.80	21.75
HSDPA Subtest-3	21.94	21.80	21.75
HSDPA Subtest-4	22.31	22.12	22.11
DC-HSDPA Subtest-1	22.30	22.18	22.16
DC-HSDPA Subtest-2	21.79	21.68	21.60
DC-HSDPA Subtest-3	21.84	21.70	21.70
DC-HSDPA Subtest-4	22.34	22.31	22.30
HSUPA Subtest-1	20.26	20.21	20.20
HSUPA Subtest-2	21.37	21.26	21.23
HSUPA Subtest-3	20.31	20.22	20.18
HSUPA Subtest-4	22.30	22.27	22.25
HSUPA Subtest-5			

LTE Band 5

Band / BW	RB Size	RB Offset	QPSK			3GPP MPR (dB)	16QAM			3GPP MPR (dB)	64QAM			3GPP MPR (dB)
			Low CH	Mid CH	High CH		Low CH	Mid CH	High CH		Low CH	Mid CH	High CH	
			20407	20525	20643		20407	20525	20643		20407	20525	20643	
			824.7	836.5	848.3		824.7	836.5	848.3		824.7	836.5	848.3	
			MHz	MHz	MHz		MHz	MHz	MHz		MHz	MHz	MHz	
5 / 1.4M	1	0	22.89	22.73	22.73	0	21.84	21.80	21.77	1	20.94	20.69	20.63	2
	1	2	22.79	22.79	22.70	0	21.83	21.78	21.69	1	20.76	20.60	20.71	2
	1	5	22.78	22.81	22.57	0	21.82	21.75	21.59	1	20.70	20.65	20.68	2
	3	0	21.97	21.95	21.56	0	20.83	20.83	20.84	1	20.79	20.71	20.79	2
	3	1	21.83	21.77	21.58	0	20.88	20.82	20.82	1	20.82	19.95	20.67	2
	3	3	21.87	21.77	21.69	0	20.79	20.87	20.80	1	20.76	20.05	20.77	2
	6	0	21.82	21.80	21.59	1	20.87	20.81	20.81	2	19.91	19.93	19.87	3

Band / BW	RB Size	RB Offset	QPSK			3GPP MPR (dB)	16QAM			3GPP MPR (dB)	64QAM			3GPP MPR (dB)
			Low CH	Mid CH	High CH		Low CH	Mid CH	High CH		Low CH	Mid CH	High CH	
			20415	20525	20635		20415	20525	20635		20415	20525	20635	
			825.5	836.5	847.5		825.5	836.5	847.5		825.5	836.5	847.5	
			MHz	MHz	MHz		MHz	MHz	MHz		MHz	MHz	MHz	
5 / 3M	1	0	22.83	22.77	22.80	0	21.87	21.78	21.75	1	20.81	20.67	20.75	2
	1	7	22.80	22.72	22.77	0	21.86	21.81	21.70	1	20.68	20.67	20.77	2
	1	14	22.71	22.79	22.72	0	21.80	21.76	21.59	1	20.63	20.67	20.56	2
	8	0	21.94	21.78	21.72	1	20.81	20.83	20.88	2	19.99	19.76	19.76	3
	8	3	21.89	21.85	21.68	1	20.73	20.84	20.64	2	19.80	18.87	19.71	3
	8	7	21.80	21.66	21.70	1	20.84	20.86	20.74	2	19.85	18.87	19.63	3
	15	0	21.87	21.74	21.79	1	20.86	20.76	20.82	2	19.75	19.88	19.78	3

Band / BW	RB Size	RB Offset	QPSK			3GPP MPR (dB)	16QAM			3GPP MPR (dB)	64QAM			3GPP MPR (dB)
			Low CH	Mid CH	High CH		Low CH	Mid CH	High CH		Low CH	Mid CH	High CH	
			20425	20525	20625		20425	20525	20625		20425	20525	20625	
			826.5	836.5	846.5		826.5	836.5	846.5		826.5	836.5	846.5	
			MHz	MHz	MHz		MHz	MHz	MHz		MHz	MHz	MHz	
5 / 5M	1	0	22.98	22.95	22.89	0	21.94	21.91	21.76	1	20.81	20.79	20.79	2
	1	12	22.90	22.89	22.88	0	21.92	21.91	21.83	1	20.78	20.79	20.72	2
	1	24	22.83	22.79	22.72	0	21.88	21.87	21.71	1	20.80	20.75	20.77	2
	12	0	21.96	21.91	21.80	1	20.93	20.93	20.89	2	19.95	19.86	19.81	3
	12	6	21.93	21.93	21.80	1	20.83	20.83	20.81	2	19.94	18.91	19.87	3
	12	13	21.86	21.87	21.83	1	20.85	20.88	20.76	2	19.82	19.04	19.72	3
	25	0	21.96	21.91	21.88	1	20.95	20.89	20.87	2	19.92	19.88	19.85	3

Band / BW	RB Size	RB Offset	QPSK			3GPP MPR (dB)	16QAM			3GPP MPR (dB)	64QAM			3GPP MPR (dB)
			Low CH	Mid CH	High CH		Low CH	Mid CH	High CH		Low CH	Mid CH	High CH	
			20450	20525	20600		20450	20525	20600		20450	20525	20600	
			829	836.5	844		829	836.5	844		829	836.5	844	
			MHz	MHz	MHz		MHz	MHz	MHz		MHz	MHz	MHz	
5 / 10M	1	0	23.00	22.95	22.89	0	21.97	21.96	21.85	1	20.91	20.87	20.83	2
	1	24	22.95	22.93	22.90	0	21.95	21.95	21.83	1	20.88	20.83	20.80	2
	1	49	22.88	22.87	22.81	0	21.90	21.90	21.80	1	20.85	20.80	20.77	2
	25	0	22.00	21.98	21.90	1	21.00	20.93	20.91	2	20.00	19.90	19.89	3
	25	12	21.95	21.93	21.85	1	20.90	20.90	20.87	2	19.95	19.00	19.87	3
	25	25	21.95	21.90	21.85	1	20.90	20.90	20.86	2	19.91	19.10	19.82	3
	50	0	22.00	21.93	21.90	1	21.00	20.95	20.92	2	20.00	19.95	19.90	3

ERP POWER

WCDMA

Band	WCDMA V		
Channel	4132	4182	4233
Frequency (MHz)	826.4	836.4	846.6
RMC 12.2K	23.33	23.29	23.20
Gain (dBi)	-2.21	-2.21	-2.21
Isotropically Factor (dB)	2.15	2.15	2.15
Max ERP Power (dBm)	18.97	18.93	18.84

LTE Band 5

Band / BW	RB Size	RB Offset	QPSK			3GPP MPR (dB)	16QAM			3GPP MPR (dB)	64QAM			3GPP MPR (dB)	
			Low CH	Mid CH	High CH		Low CH	Mid CH	High CH		Low CH	Mid CH	High CH		
			20407	20525	20643		20407	20525	20643		20407	20525	20643		
5 / 1.4M	1	0	824.7	836.5	848.3	0	824.7	836.5	848.3	1	824.7	836.5	848.3	2	
			MHz	MHz	MHz		MHz	MHz	MHz		MHz	MHz	MHz		MHz
			22.89	22.73	22.73		21.84	21.80	21.77		20.94	20.69	20.63		
			Gain (dBi)	-2.21	-2.21		-2.21	-2.21	-2.21		-2.21	-2.21	-2.21		
			Isotropically Factor (dB)	2.15	2.15	2.15	2.15	2.15	2.15	2.15	2.15				
			Max ERP Power (dBm)	18.53	18.37	18.37	17.48	17.44	17.41	16.58	16.33	16.27			

Band / BW	RB Size	RB Offset	QPSK			3GPP MPR (dB)	16QAM			3GPP MPR (dB)	64QAM			3GPP MPR (dB)
			Low CH	Mid CH	High CH		Low CH	Mid CH	High CH		Low CH	Mid CH	High CH	
			20415	20525	20635		20415	20525	20635		20415	20525	20635	
5 / 3M	1	0	825.5	836.5	847.5	0	825.5	836.5	847.5	1	825.5	836.5	847.5	2
			MHz	MHz	MHz		MHz	MHz	MHz		MHz	MHz	MHz	
			22.83	22.77	22.80		21.87	21.78	21.75		20.81	20.67	20.75	
			Gain (dBi)	-2.21	-2.21		-2.21	-2.21	-2.21		-2.21	-2.21	-2.21	
			Isotropically Factor (dB)	2.15	2.15	2.15	2.15	2.15	2.15	2.15	2.15			
			Max ERP Power (dBm)	18.47	18.41	18.44	17.51	17.42	17.39	16.45	16.31	16.39		

Band / BW	RB Size	RB Offset	QPSK			3GPP MPR (dB)	16QAM			3GPP MPR (dB)	64QAM			3GPP MPR (dB)
			Low CH	Mid CH	High CH		Low CH	Mid CH	High CH		Low CH	Mid CH	High CH	
			20425	20525	20625		20425	20525	20625		20425	20525	20625	
5 / 5M	1	0	826.5	836.5	846.5	0	826.5	836.5	846.5	1	826.5	836.5	846.5	2
			MHz	MHz	MHz		MHz	MHz	MHz		MHz	MHz	MHz	
			22.98	22.95	22.89		21.94	21.91	21.76		20.81	20.79	20.79	
			Gain (dBi)	-2.21	-2.21		-2.21	-2.21	-2.21		-2.21	-2.21	-2.21	
			Isotropically Factor (dB)	2.15	2.15	2.15	2.15	2.15	2.15	2.15	2.15			
			Max ERP Power (dBm)	18.62	18.59	18.53	17.58	17.55	17.40	16.45	16.43	16.43		

Band / BW	RB Size	RB Offset	QPSK			3GPP MPR (dB)	16QAM			3GPP MPR (dB)	64QAM			3GPP MPR (dB)	
			Low CH	Mid CH	High CH		Low CH	Mid CH	High CH		Low CH	Mid CH	High CH		
			20450	20525	20600		20450	20525	20600		20450	20525	20600		
			829	836.5	844		829	836.5	844		829	836.5	844		
			MHz	MHz	MHz		MHz	MHz	MHz		MHz	MHz	MHz		
5 / 10M	1	0	23.00	22.95	22.89	0	21.97	21.96	21.85	1	20.91	20.87	20.83	2	
Gain (dBi)			-2.21	-2.21	-2.21		-2.21	-2.21	-2.21		-2.21	-2.21	-2.21		-2.21
Isotropically Factor (dB)			2.15	2.15	2.15		2.15	2.15	2.15		2.15	2.15	2.15		2.15
Max ERP Power (dBm)			18.64	18.59	18.53		17.61	17.60	17.49		16.55	16.51	16.47		

4.2 Modulation characteristics Measurement

4.2.1 Limits of Modulation characteristics

N/A

4.2.2 Test Procedure

Connect the EUT to Communication Simulator via the antenna connector, The frequency band is set as EUT supported Modulation and Channels, the EUT output is matched with 50 ohm load, the waveform quality and constellation of the EUT was tested.

4.2.3 Test Setup



4.2.4 Test Results

WCDMA B5

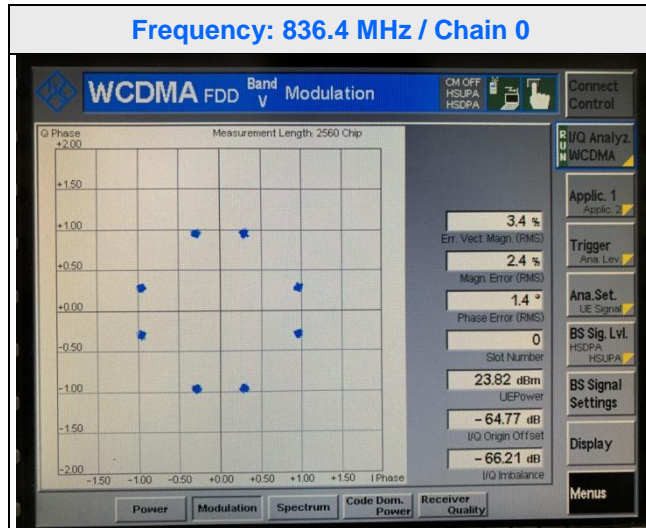

LTE Band 5

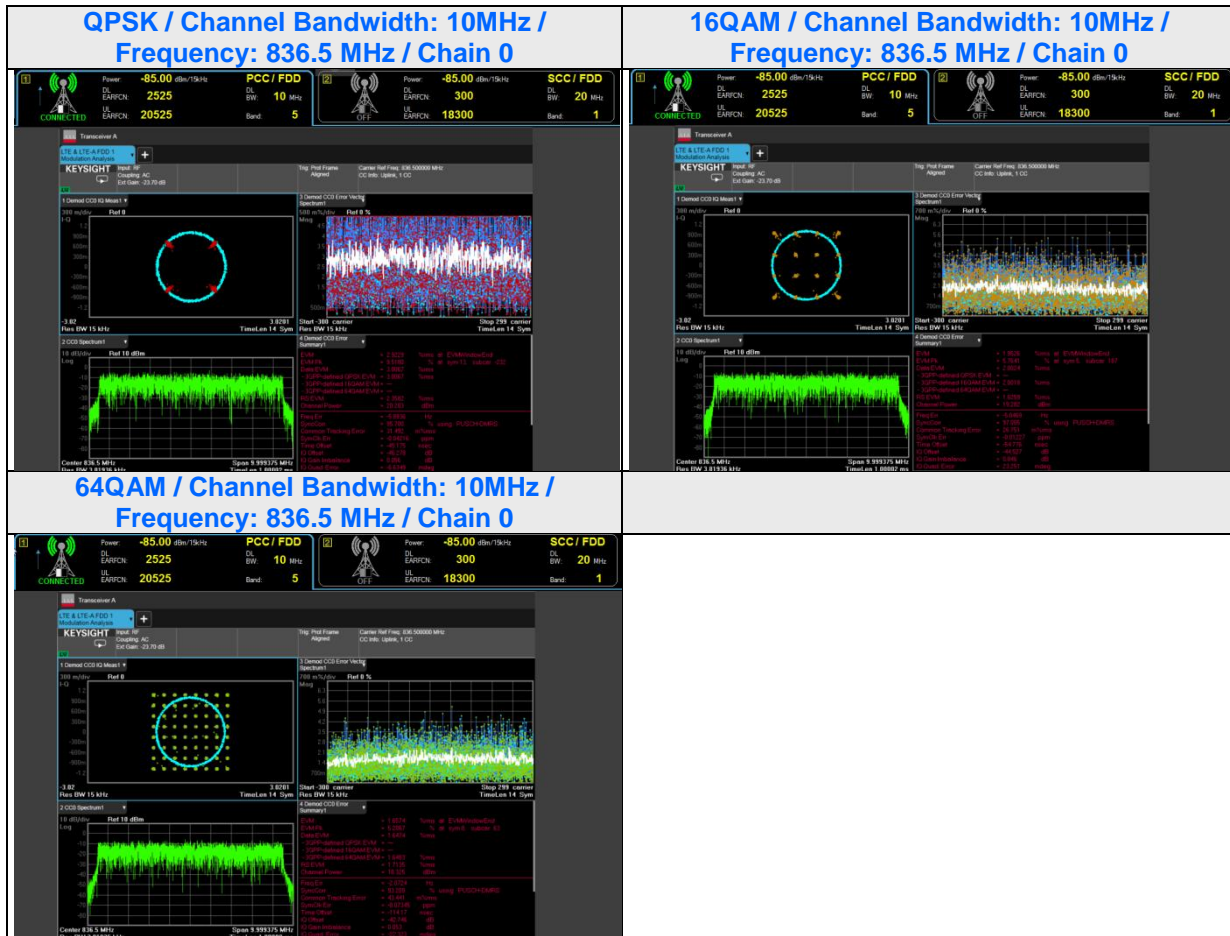

4.3 Frequency Stability Measurement

4.3.1 Limits of Frequency Stability Measurement

1.5 ppm is for base and fixed station. 2.5 ppm is for mobile station.

4.3.2 Test Procedure

- Device is placed at the oven room. The oven room could control the temperatures and humidity. Power warm up is at least 15 min and power applied should perform before recording frequency error.
- EUT is connected the external power supply to control the DC input power. The test voltage range is from minimum to maximum working voltage. Each step shall be record the frequency error rate.
- The temperature range step is 10 degrees in this test items. All temperature levels shall be hold the ± 0.5 °C during the measurement testing. The each temperature step shall be at least 0.5 hours, consider the EUT could be test under the stability condition.

NOTE: The frequency error was recorded frequency error from the communication simulator.

4.3.3 Test Setup

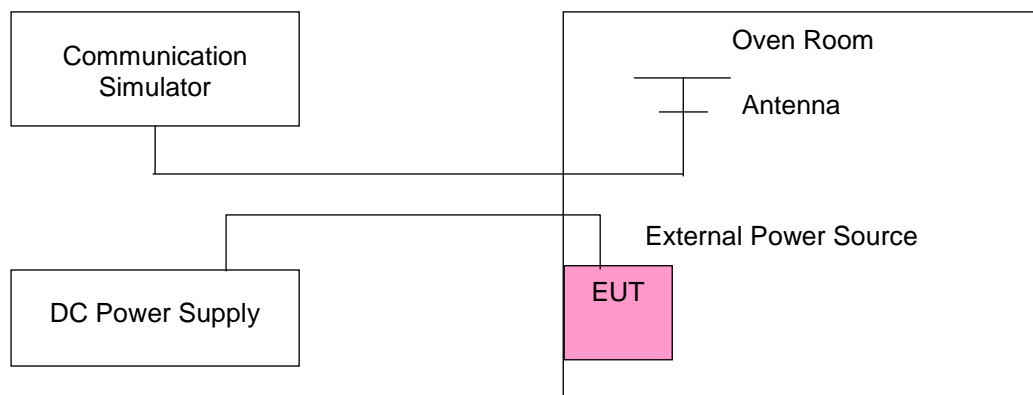

4.3.4 Test Results

WCDMA

Frequency Error vs. Voltage

Voltage (Volts)	Frequency Error (ppm)	Limit (ppm)
	WCDMA B5	
2.805	0.057	2.5
3.795	0.036	2.5

Frequency Error vs. Temperature.

TEMP. (°C)	Frequency Error (ppm)	Limit (ppm)
	WCDMA B5	
50	0.029	2.5
40	0.059	2.5
30	0.048	2.5
20	0.051	2.5
10	0.035	2.5
0	0.024	2.5
-10	0.039	2.5
-20	0.048	2.5
-30	0.055	2.5

LTE Band 5

Frequency Error vs. Voltage

Voltage (Volts)	Frequency Error (ppm)				Limit (ppm)
	LTE Band 5				
	1.4MHz	3MHz	5MHz	10MHz	
2.805	0.039	0.043	0.026	0.031	2.5
3.795	0.037	0.043	0.059	0.029	2.5

Frequency Error vs. Temperature

Temp. (°C)	Frequency Error (ppm)				Limit (ppm)
	LTE Band 5				
	1.4MHz	3MHz	5MHz	10MHz	
50	0.057	0.032	0.032	0.032	2.5
40	0.049	0.036	0.051	0.045	2.5
30	0.027	0.032	0.041	0.032	2.5
20	0.038	0.042	0.047	0.037	2.5
10	0.030	0.032	0.057	0.029	2.5
0	0.030	0.044	0.036	0.045	2.5
-10	0.029	0.030	0.024	0.036	2.5
-20	0.025	0.057	0.056	0.042	2.5
-30	0.033	0.054	0.030	0.059	2.5

4.4 Occupied Bandwidth Measurement

4.4.1 Test Procedure

All measurements were done at low, middle and high operational frequency range. The communication simulator station system controlled a EUT to export maximum output power under transmission mode and specific channel frequency. The bandwidth of the fundamental frequency was measured by spectrum analyzer with $RBW \geq 1\% \times OBW$ and $VBW \geq 3 \times RBW$.

Occupied Bandwidth Measurement:

Use OBW measurement function of Spectrum analyzer to measure 99 % occupied bandwidth.

26dB Bandwidth Measurement:

The emission bandwidth is defined as the width of the signal between two points, one below the carrier center frequency and one above the carrier center frequency, outside of which all emission are attenuated at least 26dB below the transmitter power.

4.4.2 Test Setup

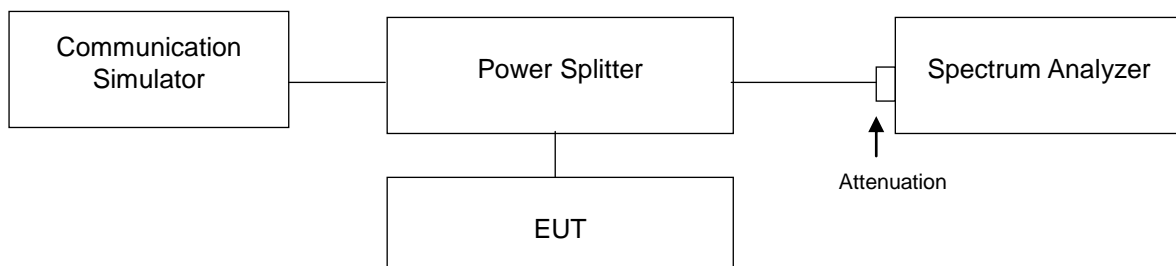

4.4.3 Test Result (-26dB Bandwidth)

Channel	Freq. (MHz)	-26dB Bandwidth (MHz)
		WCDMA B5
4132	826.4	4.65
4182	836.4	4.68
4233	846.6	4.69

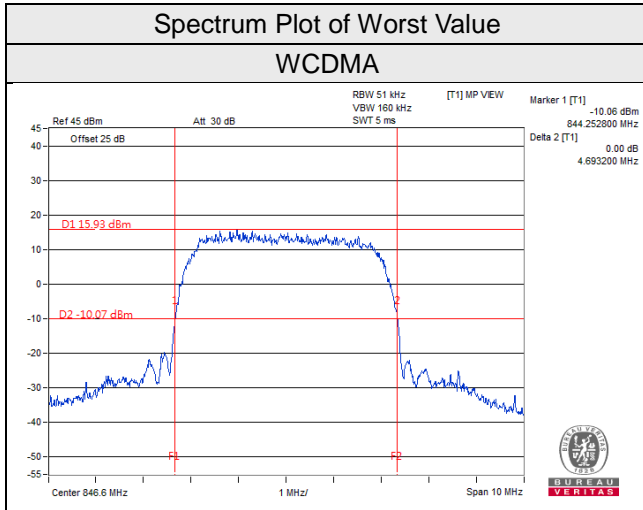

LTE Band 5									
Channel Bandwidth 1.4MHz					Channel Bandwidth 3MHz				
Channel	Frequency (MHz)	-26dB Bandwidth (MHz)			Channel	Frequency (MHz)	-26dB Bandwidth (MHz)		
		QPSK	16QAM	64QAM			QPSK	16QAM	64QAM
20407	824.7	1.24	1.24	1.24	20415	825.5	3.02	2.97	2.96
20525	836.5	1.24	1.24	1.24	20525	836.5	3.01	2.97	2.97
20643	848.3	1.24	1.23	1.24	20635	847.5	3.00	2.96	2.95
Channel Bandwidth 5MHz					Channel Bandwidth 10MHz				
Channel	Frequency (MHz)	-26dB Bandwidth (MHz)			Channel	Frequency (MHz)	-26dB Bandwidth (MHz)		
		QPSK	16QAM	64QAM			QPSK	16QAM	64QAM
20425	826.5	4.96	4.95	4.92	20450	829	9.85	9.82	9.80
20525	836.5	4.98	4.93	4.93	20525	836.5	9.83	9.83	9.79
20625	846.5	4.91	4.91	4.88	20600	844	9.82	9.81	9.78

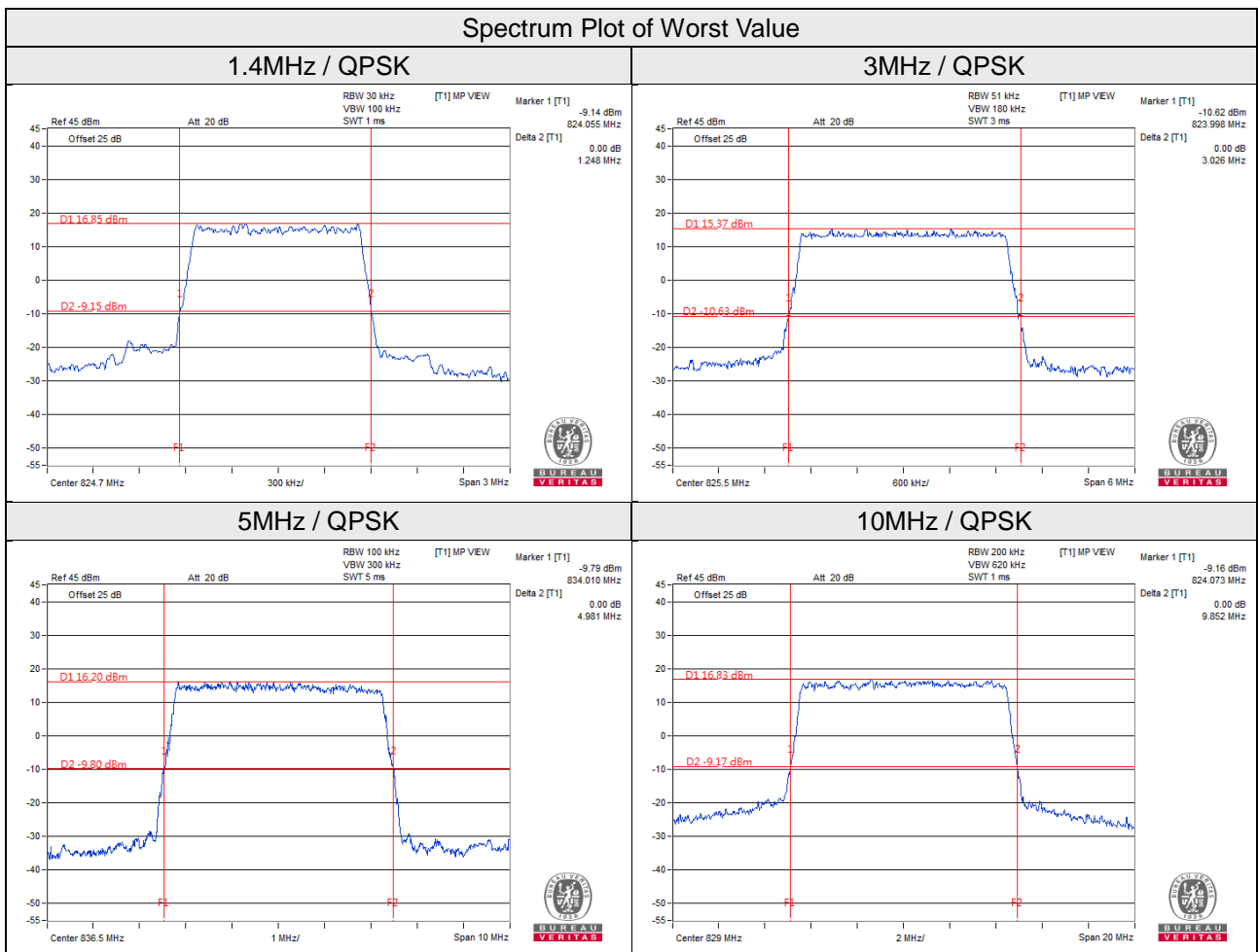

4.4.4 Test Result (Occupied Bandwidth)

Channel	Freq. (MHz)	99% Occupied Bandwidth (MHz)
		WCDMA
4132	826.4	4.13
4182	836.4	4.13
4233	846.6	4.14

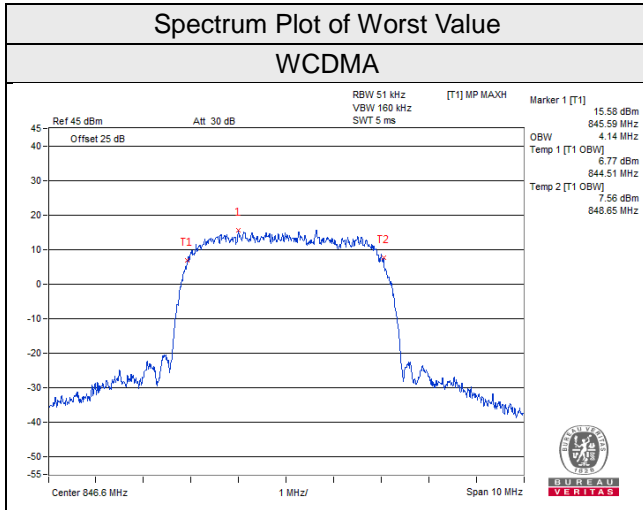

LTE Band 5									
Channel Bandwidth 1.4MHz					Channel Bandwidth 3MHz				
Channel	Frequency (MHz)	99% Occupied Bandwidth (MHz)			Channel	Frequency (MHz)	99% Occupied Bandwidth (MHz)		
		QPSK	16QAM	64QAM			QPSK	16QAM	64QAM
20407	824.7	1.09	1.09	1.09	20415	825.5	2.70	2.68	2.70
20525	836.5	1.08	1.09	1.08	20525	836.5	2.70	2.68	2.70
20643	848.3	1.09	1.09	1.09	20635	847.5	2.70	2.68	2.69
Channel Bandwidth 5MHz					Channel Bandwidth 10MHz				
Channel	Frequency (MHz)	99% Occupied Bandwidth (MHz)			Channel	Frequency (MHz)	99% Occupied Bandwidth (MHz)		
		QPSK	16QAM	64QAM			QPSK	16QAM	64QAM
20425	826.5	4.50	4.50	4.50	20450	829	9.00	8.96	9.00
20525	836.5	4.50	4.51	4.51	20525	836.5	9.00	9.00	8.98
20625	846.5	4.50	4.51	4.49	20600	844	8.98	8.96	8.98

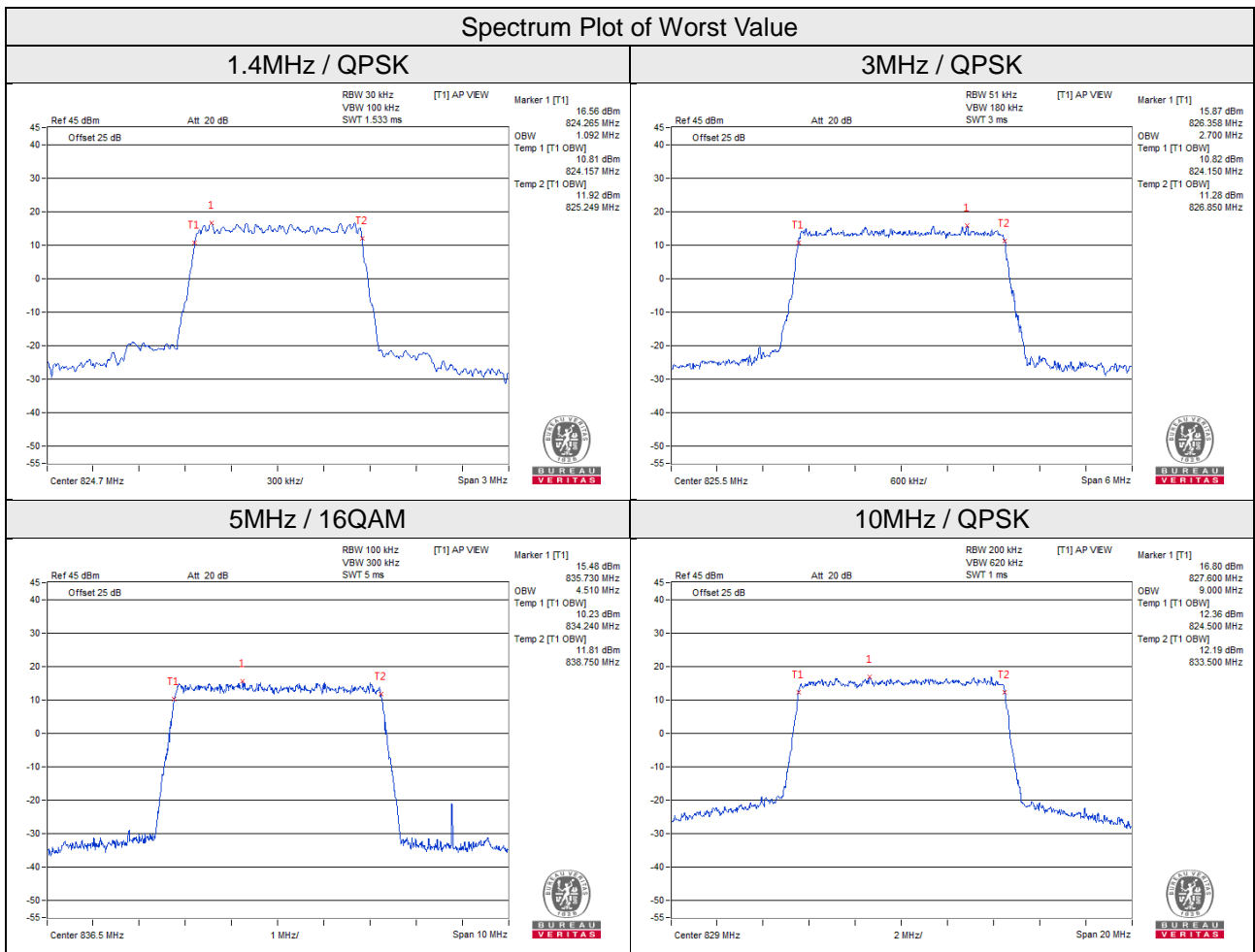

4.5 Band Edge Measurement

4.5.1 Limits of Band Edge Measurement

Power of any emission outside of the authorized operating frequency ranges must be attenuated below the transmitting power (P) by a factor of at least $43 + 10 \log(P)$ dB. In the 1 MHz bands immediately outside and adjacent to the frequency block a resolution bandwidth of at least one percent of the emission bandwidth of the fundamental emission of the transmitter may be employed.

4.5.2 Test Setup

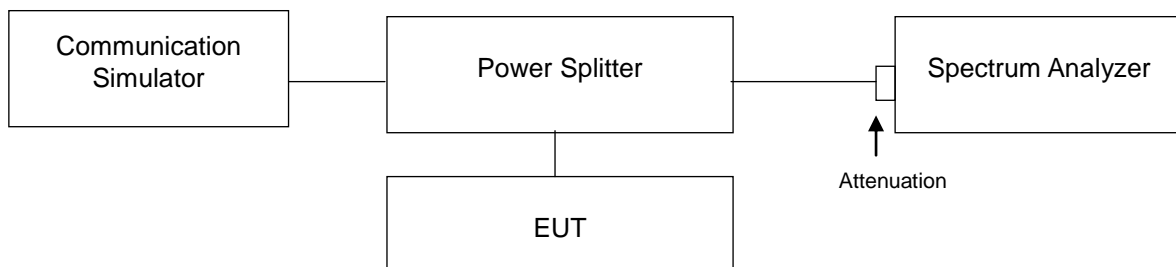

4.5.3 Test Procedures

- a. All measurements were done at low and high operational frequency range.
- b. The center frequency of spectrum is the band edge frequency and RB of the spectrum is $>1\%$ Emission Bandwidth and VB of the spectrum is $\geq 3*RB$.
- c. Record the max trace plot into the test report.

4.5.4 Test Results

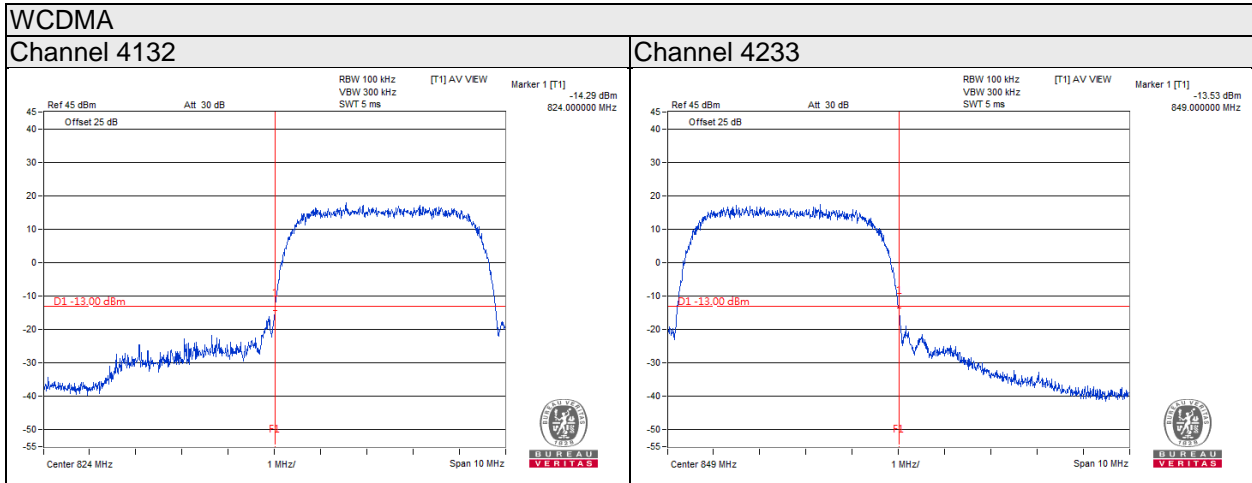

LTE Band 5 Channel Band width: 1.4MHz

Channel 20407

1 RB

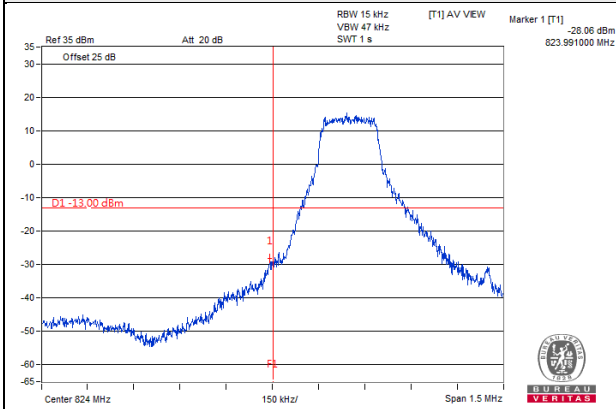

Channel 20643

1 RB

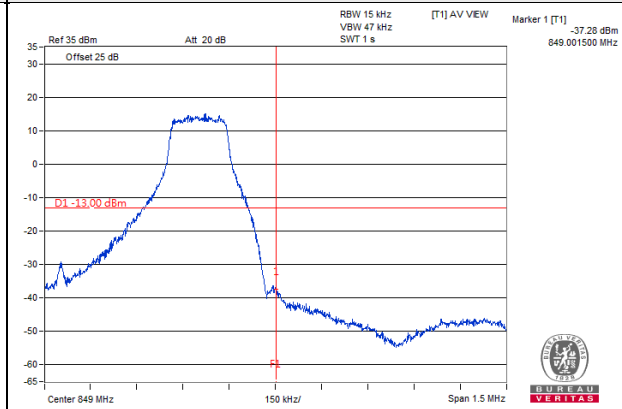

6 RB

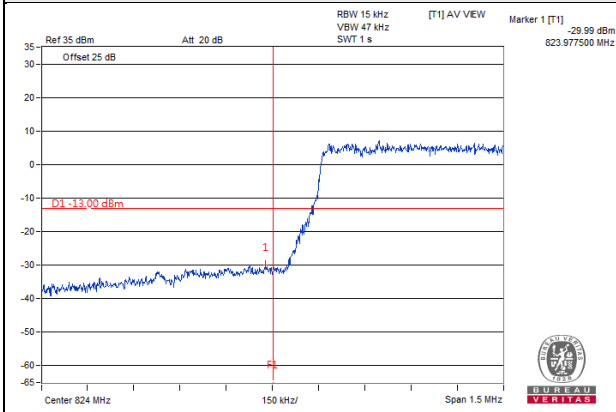

6 RB

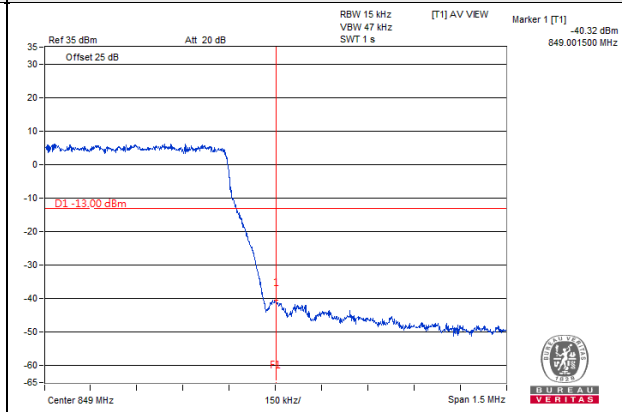

LTE Band 5 Channel Band width: 3MHz

Channel 20415

1 RB

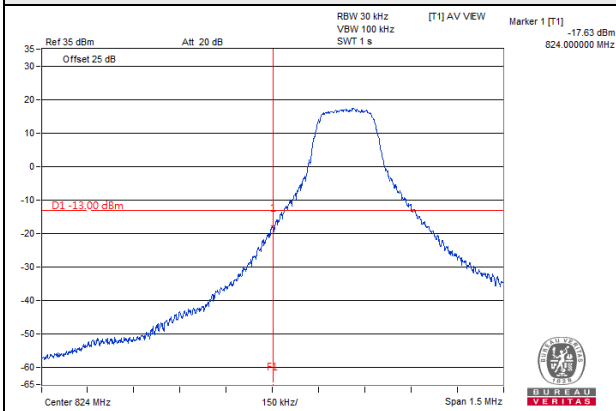

Channel 20635

1 RB

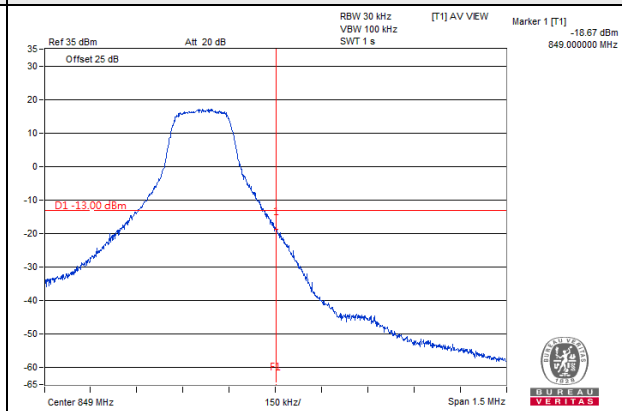

15 RB

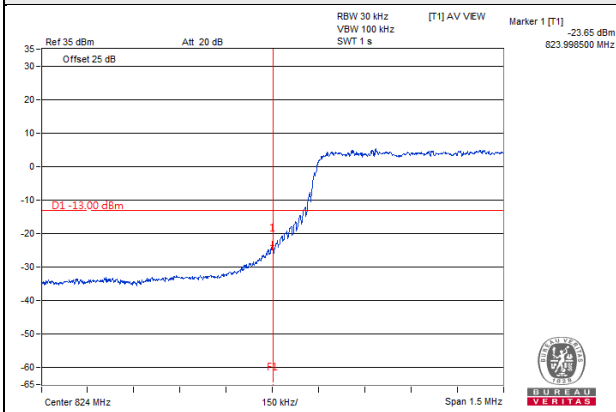

15 RB

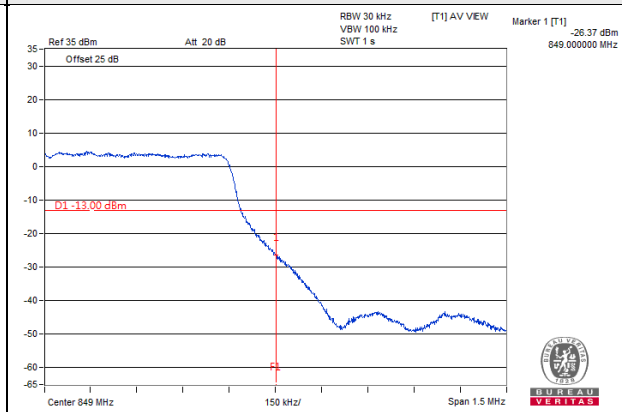

LTE Band 5 Channel Band width: 5MHz

Channel 20425

1 RB

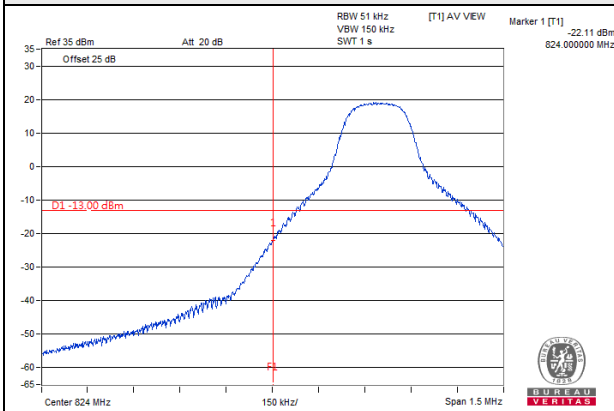

Channel 20625

1 RB

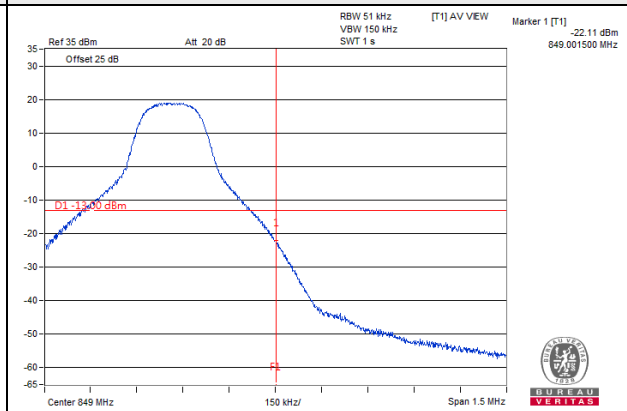

25 RB

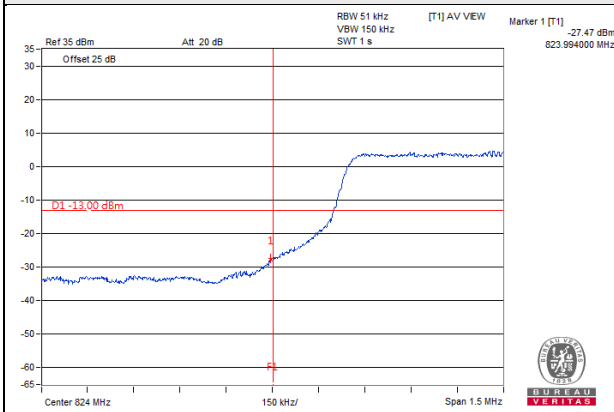

25 RB

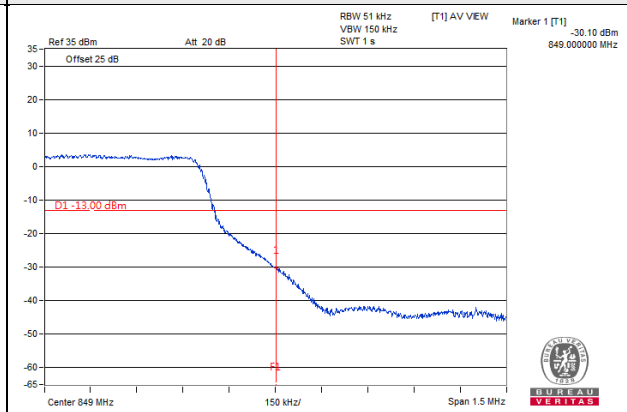

LTE Band 5 Channel Band width: 10MHz

Channel 20450

1 RB

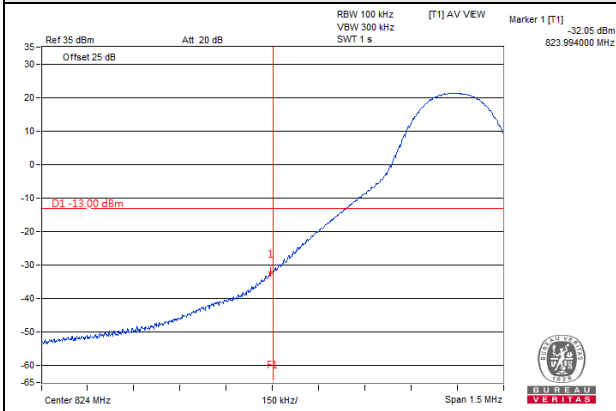

Channel 20600

1 RB

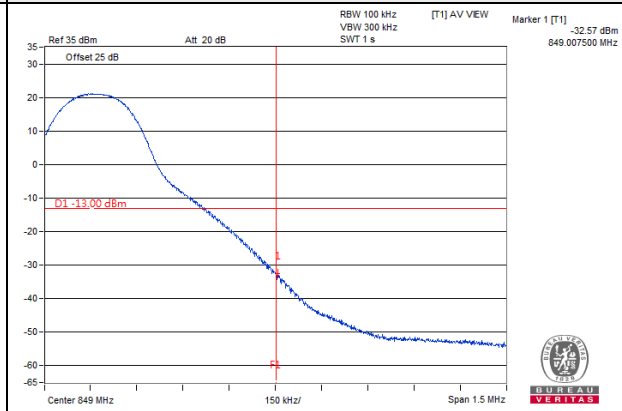

50 RB

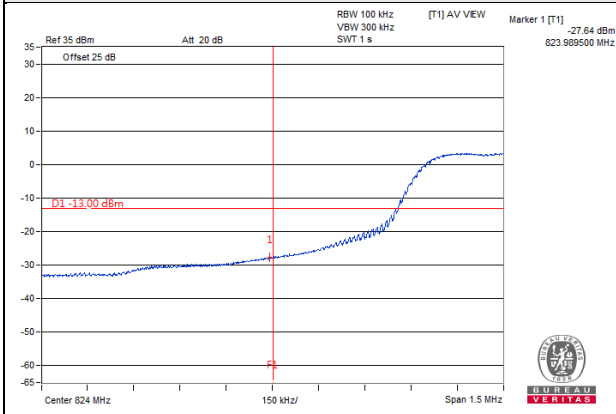

50 RB

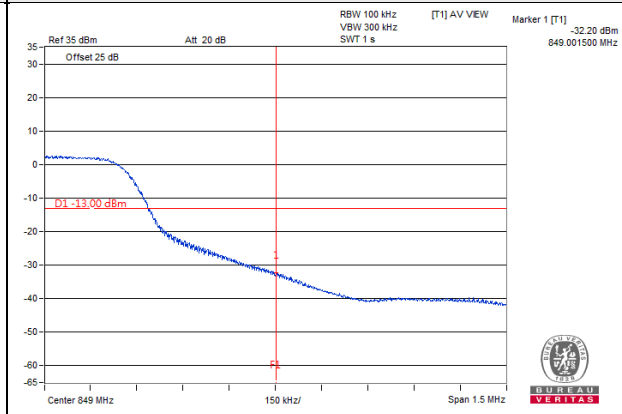

4.6 Peak to Average Ratio

4.5.1 Limits of Peak to Average Ratio Measurement

In measuring transmissions in this band using an average power technique, the peak to-average ratio (PAR) of the transmission may not exceed 13 dB

4.5.2 Test Setup

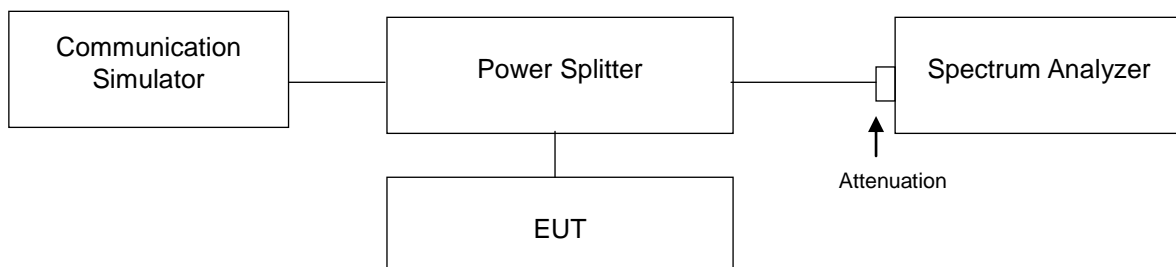

4.5.3 Test Procedures

1. Set resolution measurement bandwidth \geq signal's occupied bandwidth;
2. Set the number of counts to a value that stabilizes the measured CCDF curve;
3. Record the maximum PAPR level associated with a probability of 0.1%.

4.5.4 Test Results

Channel	Freq. (MHz)	Peak to Average Ratio (dB)
		WCDMA
4132	826.4	3.07
4183	836.4	3.09
4233	846.6	3.02

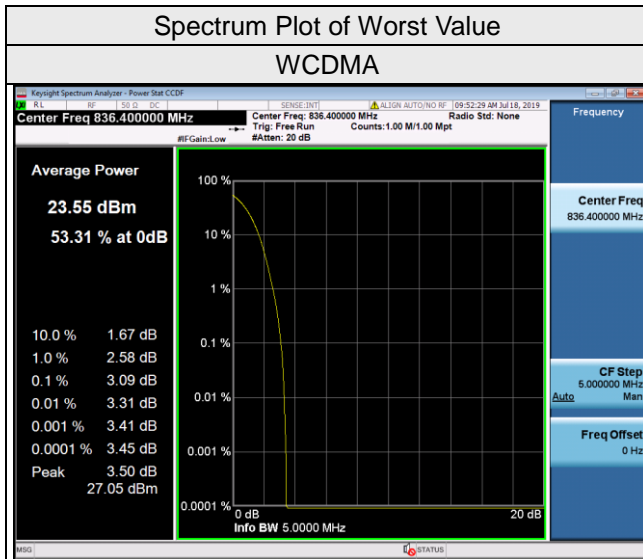

LTE Band 5									
Channel Bandwidth 1.4MHz					Channel Bandwidth 3MHz				
Channel	Frequency (MHz)	Peak To Average Ratio (dB)			Channel	Frequency (MHz)	Peak To Average Ratio (dB)		
		QPSK	16QAM	64QAM			QPSK	16QAM	64QAM
20407	824.7	4.94	6.12	6.72	20415	825.5	4.65	6.06	6.68
20525	836.5	4.88	6.08	6.64	20525	836.5	4.62	6.06	6.67
20643	848.3	4.91	6.10	6.64	20635	847.5	4.65	6.06	6.65
Channel Bandwidth 5MHz					Channel Bandwidth 10MHz				
Channel	Frequency (MHz)	Peak To Average Ratio (dB)			Channel	Frequency (MHz)	Peak To Average Ratio (dB)		
		QPSK	16QAM	64QAM			QPSK	16QAM	64QAM
20425	826.5	4.87	6.08	6.59	20450	829	4.70	5.85	6.54
20525	836.5	4.86	6.08	6.64	20525	836.5	4.83	6.10	6.63
20625	846.5	4.84	6.06	6.66	20600	844	4.70	6.02	6.53

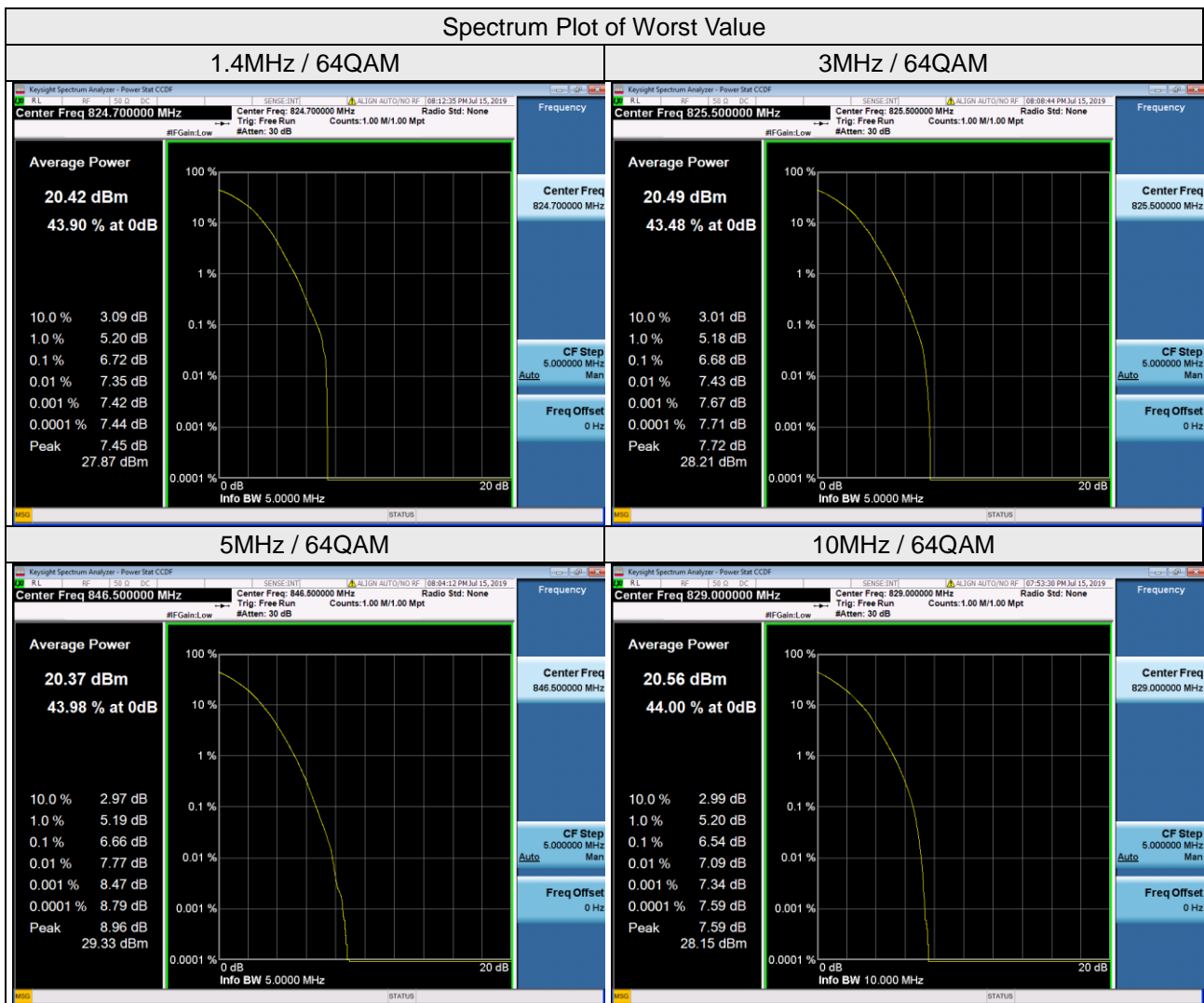

4.7 Conducted Spurious Emissions

4.7.1 Limits of Conducted Spurious Emissions Measurement

The power of any emission outside of the authorized operating frequency ranges must be attenuated below the transmitting power (P) by a factor of at least $43 + 10 \log(P)$ dB. The emission limit equal to -13dBm .

4.7.2 Test Setup

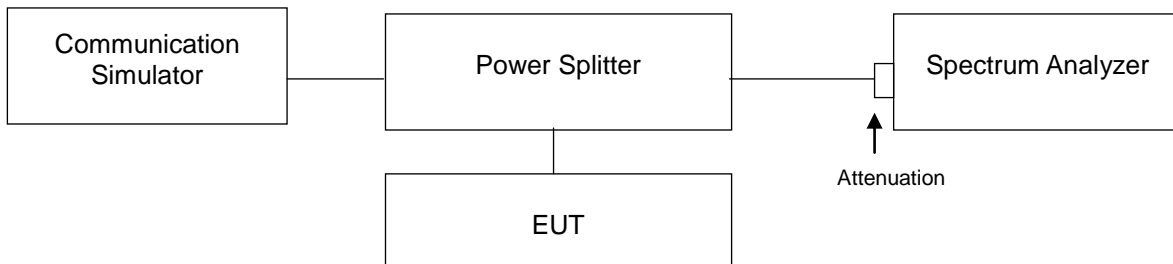

4.7.3 Test Procedure

- a. All measurements were done at 3 channels: low, middle and high operational frequency range.
- b. When the spectrum scanned from 9 kHz to the tenth harmonic of the highest fundamental frequency, it shall be connected to the 20dB pad attenuated the carried frequency.

4.7.4 Test Results



LTE Band 5 Channel Band width: 1.4MHz

Channel 20407

Frequency Range : 9kHz~1GHz

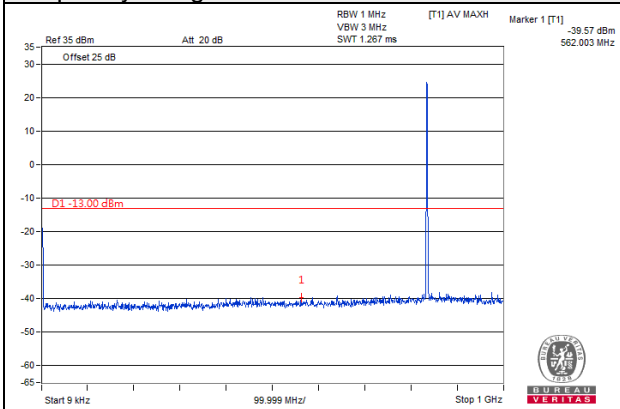

Frequency Range : 1GHz~10GHz

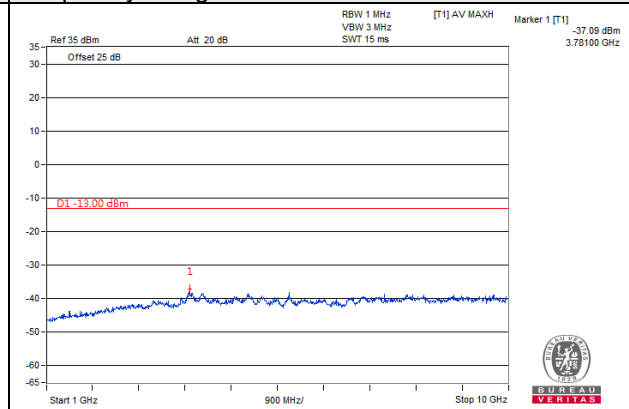

Channel 20525

Frequency Range : 9kHz~1GHz

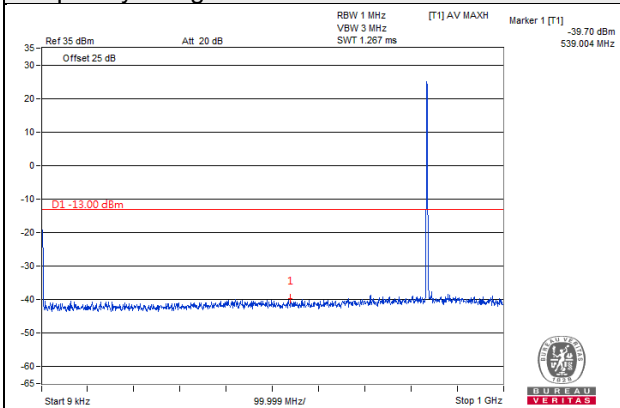

Frequency Range : 1GHz~10GHz

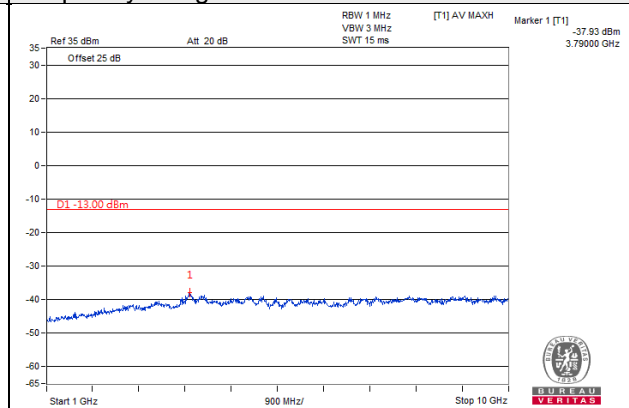

Channel 20643

Frequency Range : 9kHz~1GHz

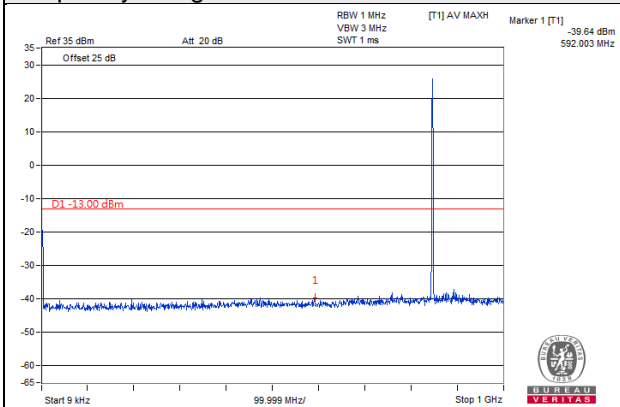

Frequency Range : 1GHz~10GHz

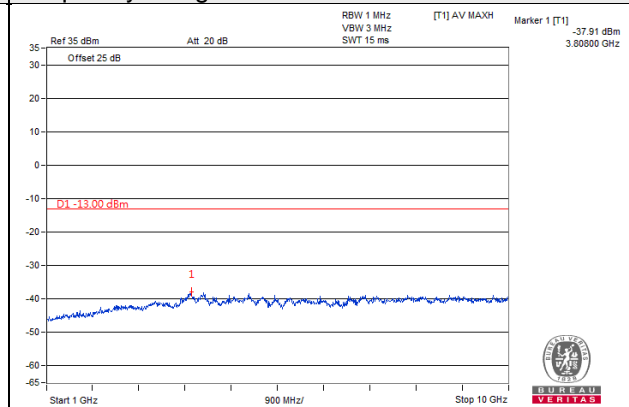

LTE Band 5 Channel Band width: 3MHz

Channel 20415

Frequency Range : 9kHz~1GHz

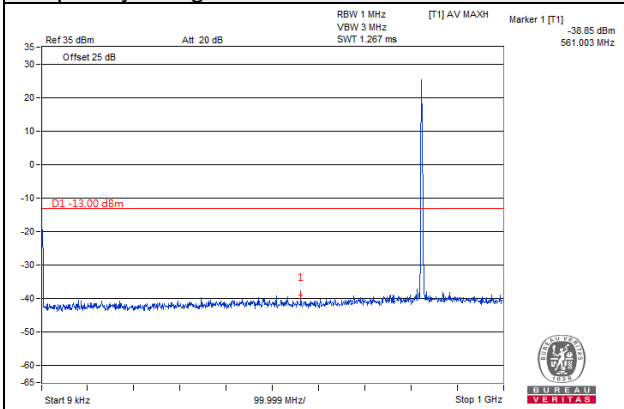

Frequency Range : 1GHz~10GHz

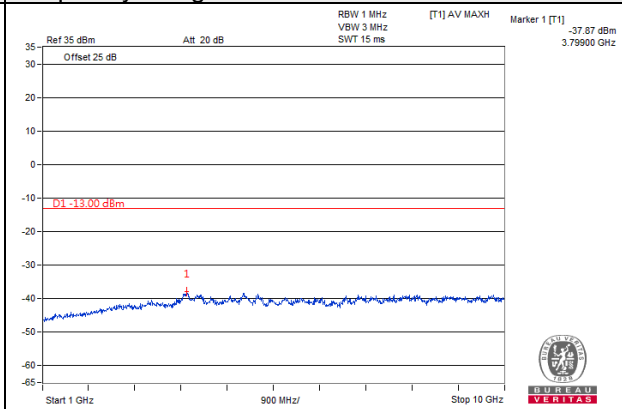

Channel 20525

Frequency Range : 9kHz~1GHz

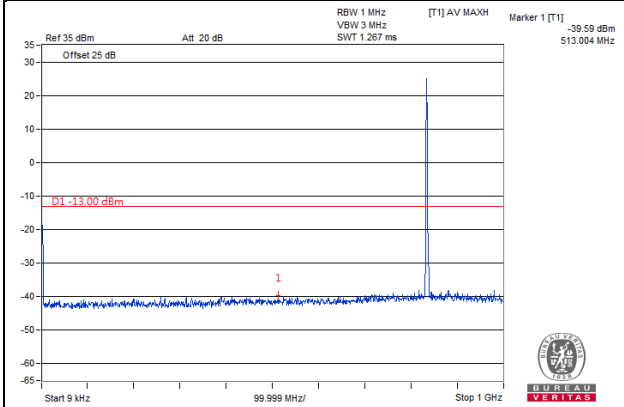

Frequency Range : 1GHz~10GHz

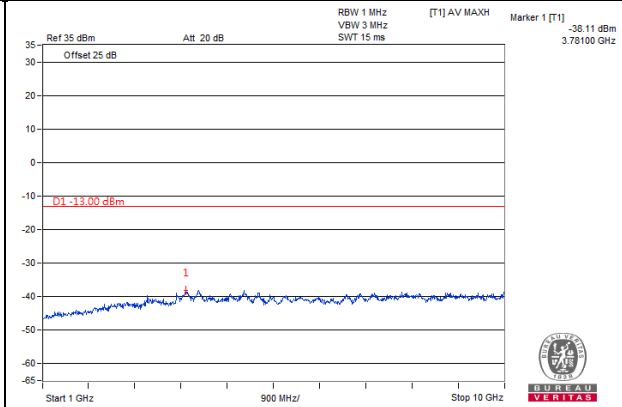

Channel 20635

Frequency Range : 9kHz~1GHz

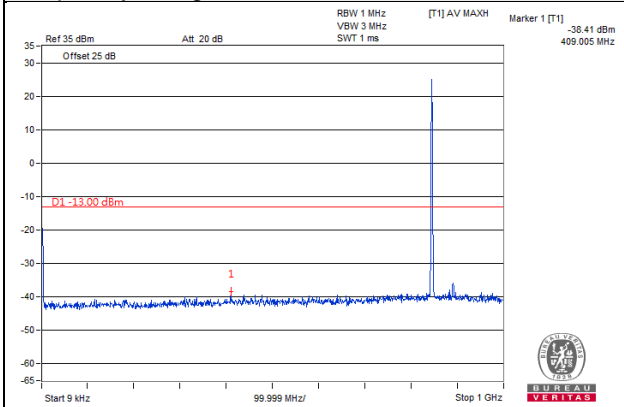

Frequency Range : 1GHz~10GHz

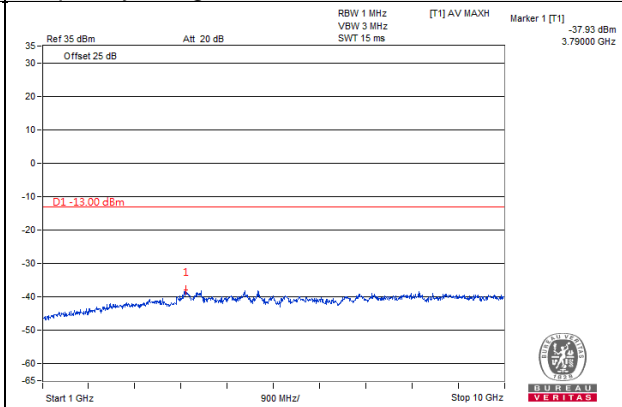

LTE Band 5 Channel Band width: 5MHz

Channel 20425

Frequency Range : 9kHz~1GHz

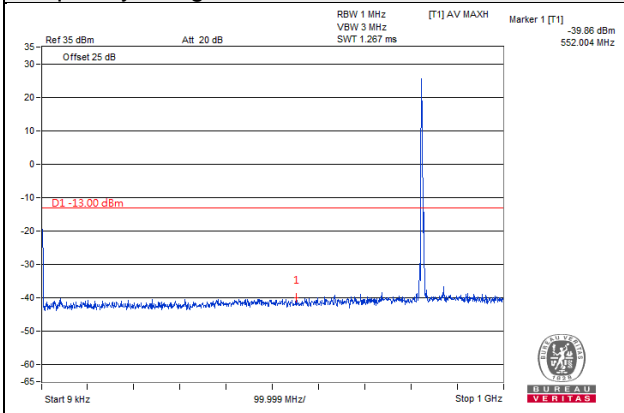

Frequency Range : 1GHz~10GHz

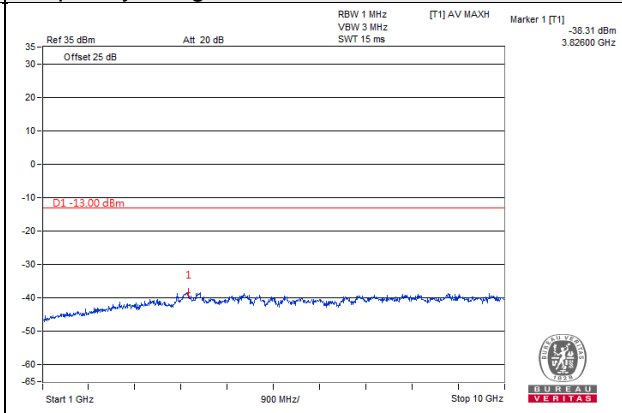

Channel 20525

Frequency Range : 9kHz~1GHz

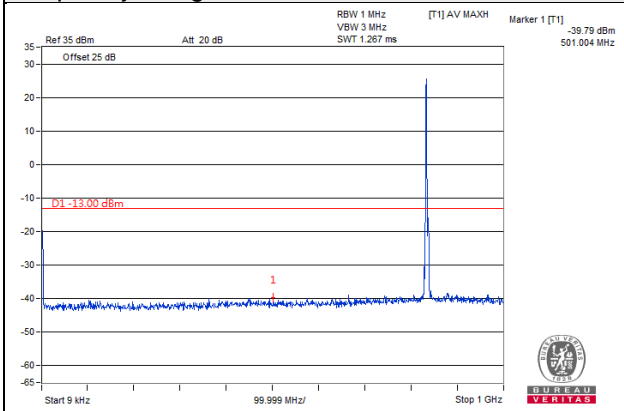

Frequency Range : 1GHz~10GHz

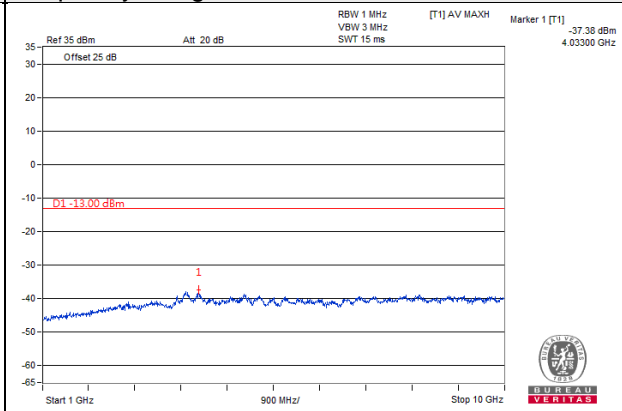

Channel 20625

Frequency Range : 9kHz~1GHz

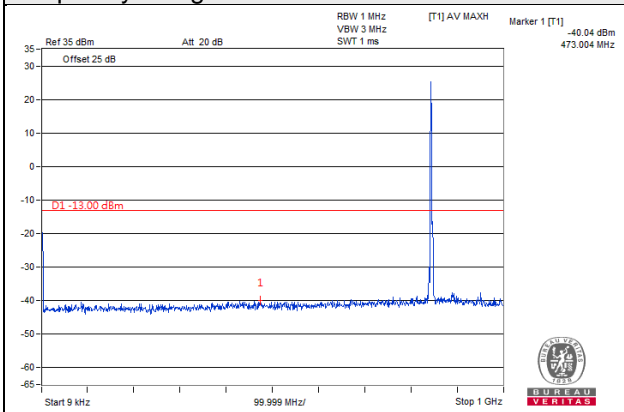

Frequency Range : 1GHz~10GHz

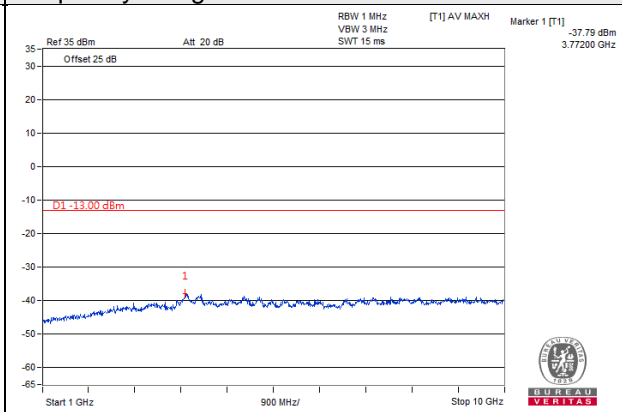

LTE Band 5 Channel Band width: 10MHz

Channel 20450

Frequency Range : 9kHz~1GHz

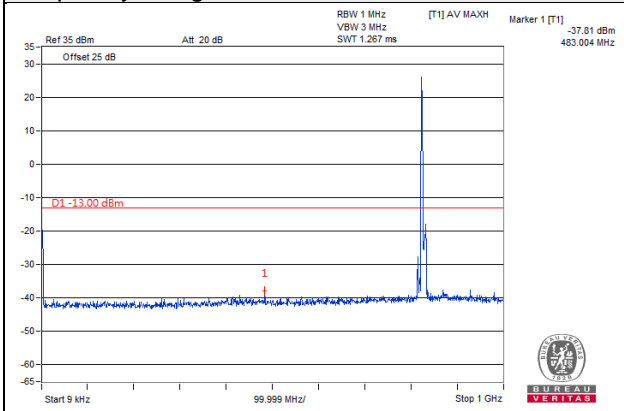

Frequency Range : 1GHz~10GHz

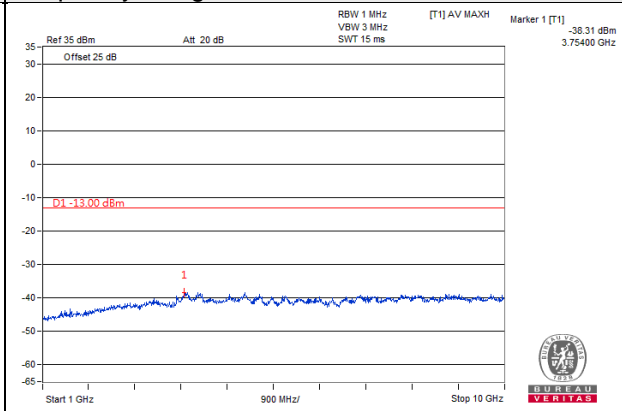

Channel 20525

Frequency Range : 9kHz~1GHz

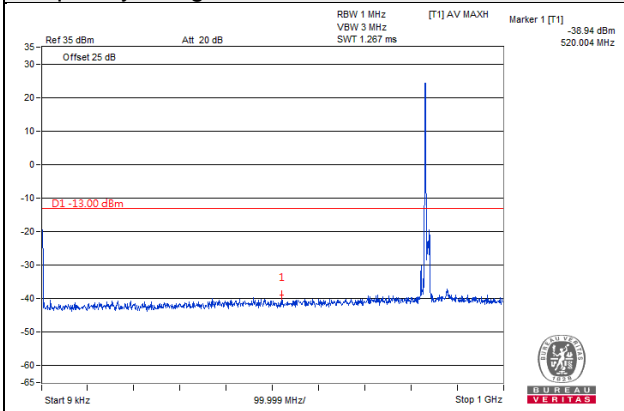

Frequency Range : 1GHz~10GHz

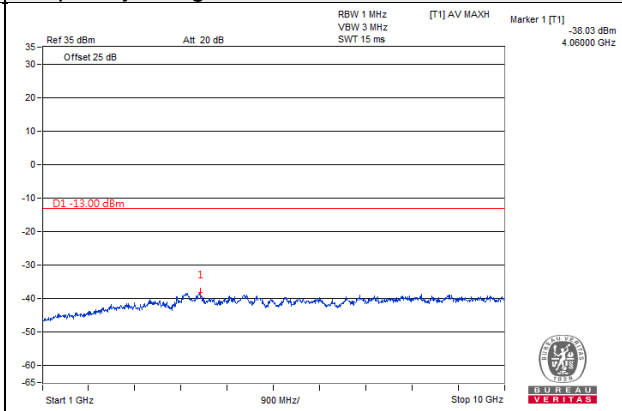

Channel 20600

Frequency Range : 9kHz~1GHz

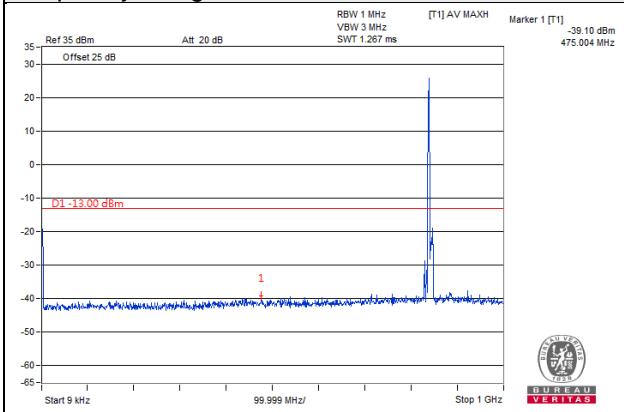

Frequency Range : 1GHz~10GHz

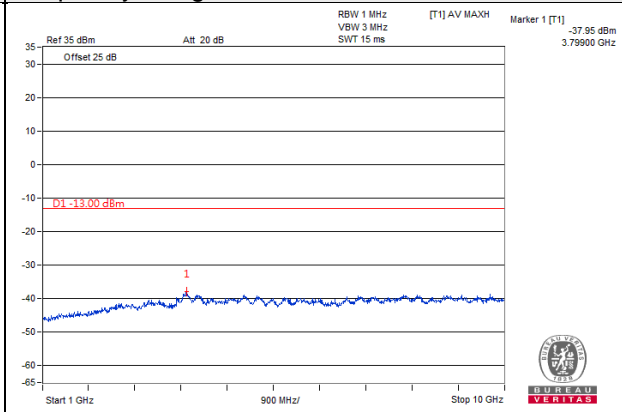

4.8 Radiated Emission Measurement

4.8.1 Limits of Radiated Emission Measurement

The power of any emission outside of the authorized operating frequency ranges must be attenuated below the transmitting power (P) by a factor of at least $43 + 10 \log(P)$ dB. The emission limit equal to -13dBm .

4.8.2 Test Procedure

- a. The power was measured with Spectrum Analyzer.
- b. Substitution method is used for EIRP measurement. In the semi-anechoic chamber, EUT placed on the 0.8m/1.5m height of Turn Table, rotated the table around 360 degrees to search the maximum radiation power and receiver antenna shall be rotated vertical and horizontal polarization and moved height from 1m to 4m to find the maximum polar radiated power. The "Read Value" is the spectrum reading the maximum power value.
- c. Follow ANSI 63.26 section 5.2.7 d), $\text{EIRP Value (dBm)} = \text{Read Value (dB}\mu\text{V/m)} - \text{Correction Factor @ 3m}$
- d. $\text{Correction Factor (dB) @ 3m} = 20\log(D) - 104.8$; where D is the measurement distance @3m $= -95.26\text{dB}$
- e. ERP power can be calculated form EIRP power by subtracting the gain of dipole, $\text{ERP power} = \text{EIRP power} - 2.15\text{dBi}$.

NOTE: The resolution bandwidth and video bandwidth of test receiver/spectrum analyzer is 1MHz/3MHz.

4.8.3 Deviation from Test Standard

No deviation.

**4.8.4 Test Setup
For Below 1GHz**

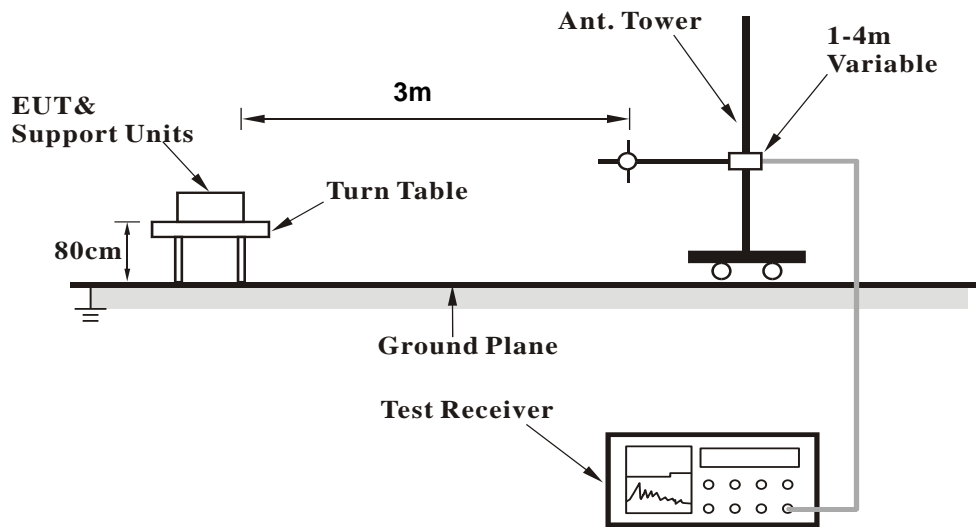

For Above 1GHz:

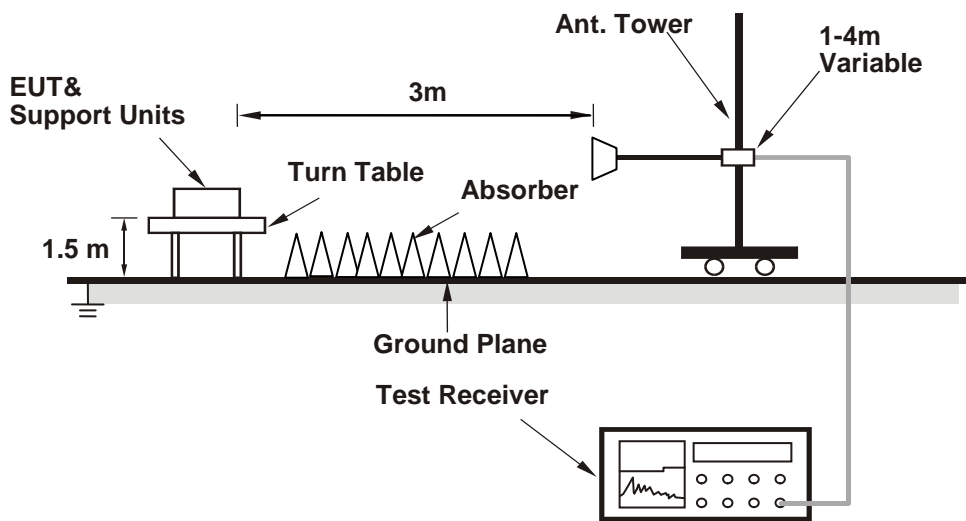

For the actual test configuration, please refer to the attached file (Test Setup Photo).

4.8.5 Test Results

BELOW 1GHz

WCDMA:

Mode	TX channel 4132	Frequency Range	Below 1000 MHz
------	-----------------	-----------------	----------------

Antenna Polarity & Test Distance: Horizontal at 3 M

No.	Freq. (MHz)	Reading (dB μ V/m)	Correction Factor (dB)	EIRP (dBm)	Limit (dBm)	Margin (dB)
1	39.65	34.72	-95.26	-60.54	-13	-47.54
2	124.03	35.6	-95.26	-59.66	-13	-46.66
3	177.41	28.73	-95.26	-66.53	-13	-53.53
4	221.63	35.07	-95.26	-60.19	-13	-47.19
5	344.05	30.93	-95.26	-64.33	-13	-51.33
6	512.29	29.94	-95.26	-65.32	-13	-52.32

Antenna Polarity & Test Distance: Vertical at 3 M

No.	Freq. (MHz)	Reading (dB μ V/m)	Correction Factor (dB)	EIRP (dBm)	Limit (dBm)	Margin (dB)
1	42.26	35.08	-95.26	-60.18	-13	-47.18
2	137.97	35.3	-95.26	-59.96	-13	-46.96
3	212.49	31.23	-95.26	-64.03	-13	-51.03
4	311.16	26.49	-95.26	-68.77	-13	-55.77
5	489.94	33.08	-95.26	-62.18	-13	-49.18
6	615.75	33.04	-95.26	-62.22	-13	-49.22

Remarks:

1. Follow ANSI 63.26 section 5.2.7 d), EIRP Value (dBm) = E (dB μ V/m) - Correction Factor @ 3m.
2. Correction Factor (dB) = 20log(D) - 104.8; where D is the measurement distance @3m.

Mode	TX channel 4182	Frequency Range	Below 1000 MHz
------	-----------------	-----------------	----------------

Antenna Polarity & Test Distance: Horizontal at 3 M

No.	Freq. (MHz)	Reading (dB μ V/m)	Correction Factor (dB)	EIRP (dBm)	Limit (dBm)	Margin (dB)
1	38.91	33.97	-95.26	-61.29	-13	-48.29
2	123.77	35.73	-95.26	-59.53	-13	-46.53
3	177.44	27.69	-95.26	-67.57	-13	-54.57
4	221.12	33.88	-95.26	-61.38	-13	-48.38
5	343.87	32.02	-95.26	-63.24	-13	-50.24
6	513.1	30.78	-95.26	-64.48	-13	-51.48

Antenna Polarity & Test Distance: Vertical at 3 M

No.	Freq. (MHz)	Reading (dB μ V/m)	Correction Factor (dB)	EIRP (dBm)	Limit (dBm)	Margin (dB)
1	43.06	34.28	-95.26	-60.98	-13	-47.98
2	138.5	36.52	-95.26	-58.74	-13	-45.74
3	212.24	31.94	-95.26	-63.32	-13	-50.32
4	310.91	26.27	-95.26	-68.99	-13	-55.99
5	490.62	32.88	-95.26	-62.38	-13	-49.38
6	614.95	33.03	-95.26	-62.23	-13	-49.23

Remarks:

1. Follow ANSI 63.26 section 5.2.7 d), EIRP Value (dBm) = E (dB μ V/m) - Correction Factor @ 3m.
2. Correction Factor (dB) = 20log(D) - 104.8; where D is the measurement distance @3m.

Mode	TX channel 4233	Frequency Range	Below 1000 MHz
------	-----------------	-----------------	----------------

Antenna Polarity & Test Distance: Horizontal at 3 M

No.	Freq. (MHz)	Reading (dB μ V/m)	Correction Factor (dB)	EIRP (dBm)	Limit (dBm)	Margin (dB)
1	39.15	34.77	-95.26	-60.49	-13	-47.49
2	123.51	35.55	-95.26	-59.71	-13	-46.71
3	178.73	27.95	-95.26	-67.31	-13	-54.31
4	221.45	34.81	-95.26	-60.45	-13	-47.45
5	344.37	31.99	-95.26	-63.27	-13	-50.27
6	512.49	30.19	-95.26	-65.07	-13	-52.07

Antenna Polarity & Test Distance: Vertical at 3 M

No.	Freq. (MHz)	Reading (dB μ V/m)	Correction Factor (dB)	EIRP (dBm)	Limit (dBm)	Margin (dB)
1	43.34	34.84	-95.26	-60.42	-13	-47.42
2	138.85	36.47	-95.26	-58.79	-13	-45.79
3	211.51	30.81	-95.26	-64.45	-13	-51.45
4	312.14	24.95	-95.26	-70.31	-13	-57.31
5	490.09	32.84	-95.26	-62.42	-13	-49.42
6	614.41	31.43	-95.26	-63.83	-13	-50.83

Remarks:

1. Follow ANSI 63.26 section 5.2.7 d), EIRP Value (dBm) = E (dB μ V/m) - Correction Factor @ 3m.
2. Correction Factor (dB) = 20log(D) - 104.8; where D is the measurement distance @3m.

LTE Band 5: 1.4MHz

Mode	TX channel 20407	Frequency Range	Below 1000 MHz
------	------------------	-----------------	----------------

Antenna Polarity & Test Distance: Horizontal at 3 M

No.	Freq. (MHz)	Reading (dB μ V/m)	Correction Factor (dB)	EIRP (dBm)	Limit (dBm)	Margin (dB)
1	41.04	32.63	-95.26	-62.63	-13	-49.63
2	102.79	34.77	-95.26	-60.49	-13	-47.49
3	156.96	28	-95.26	-67.26	-13	-54.26
4	183.7	33.37	-95.26	-61.89	-13	-48.89
5	323.84	29.86	-95.26	-65.40	-13	-52.40
6	446.5	27.6	-95.26	-67.66	-13	-54.66

Antenna Polarity & Test Distance: Vertical at 3 M

No.	Freq. (MHz)	Reading (dB μ V/m)	Correction Factor (dB)	EIRP (dBm)	Limit (dBm)	Margin (dB)
1	43.35	34.86	-95.26	-60.40	-13	-47.40
2	87.14	34.9	-95.26	-60.36	-13	-47.36
3	124.41	30.84	-95.26	-64.42	-13	-51.42
4	169.48	26.72	-95.26	-68.54	-13	-55.54
5	317.41	34.75	-95.26	-60.51	-13	-47.51
6	553.58	31.69	-95.26	-63.57	-13	-50.57

Remarks:

1. Follow ANSI 63.26 section 5.2.7 d), EIRP Value (dBm) = E (dB μ V/m) - Correction Factor @ 3m.
2. Correction Factor (dB) = 20log(D) – 104.8; where D is the measurement distance @3m.

Mode	TX channel 20525	Frequency Range	Below 1000 MHz
------	------------------	-----------------	----------------

Antenna Polarity & Test Distance: Horizontal at 3 M

No.	Freq. (MHz)	Reading (dB μ V/m)	Correction Factor (dB)	EIRP (dBm)	Limit (dBm)	Margin (dB)
1	40.33	31.83	-95.26	-63.43	-13	-50.43
2	102.61	33.69	-95.26	-61.57	-13	-48.57
3	157.63	27.63	-95.26	-67.63	-13	-54.63
4	183.63	33.35	-95.26	-61.91	-13	-48.91
5	323.03	30.2	-95.26	-65.06	-13	-52.06
6	447.13	28.84	-95.26	-66.42	-13	-53.42

Antenna Polarity & Test Distance: Vertical at 3 M

No.	Freq. (MHz)	Reading (dB μ V/m)	Correction Factor (dB)	EIRP (dBm)	Limit (dBm)	Margin (dB)
1	44.58	34.88	-95.26	-60.38	-13	-47.38
2	85.94	33.62	-95.26	-61.64	-13	-48.64
3	123.94	31.99	-95.26	-63.27	-13	-50.27
4	169.04	26.32	-95.26	-68.94	-13	-55.94
5	318.28	33.07	-95.26	-62.19	-13	-49.19
6	551.71	31.85	-95.26	-63.41	-13	-50.41

Remarks:

1. Follow ANSI 63.26 section 5.2.7 d), EIRP Value (dBm) = E (dB μ V/m) - Correction Factor @ 3m.
2. Correction Factor (dB) = 20log(D) - 104.8; where D is the measurement distance @3m.

Mode	TX channel 20643	Frequency Range	Below 1000 MHz
------	------------------	-----------------	----------------

Antenna Polarity & Test Distance: Horizontal at 3 M

No.	Freq. (MHz)	Reading (dB μ V/m)	Correction Factor (dB)	EIRP (dBm)	Limit (dBm)	Margin (dB)
1	41.16	32.62	-95.26	-62.64	-13	-49.64
2	102.3	34.25	-95.26	-61.01	-13	-48.01
3	158.06	28.87	-95.26	-66.39	-13	-53.39
4	183.58	34.21	-95.26	-61.05	-13	-48.05
5	323.09	29.89	-95.26	-65.37	-13	-52.37
6	445.91	29.16	-95.26	-66.10	-13	-53.10

Antenna Polarity & Test Distance: Vertical at 3 M

No.	Freq. (MHz)	Reading (dB μ V/m)	Correction Factor (dB)	EIRP (dBm)	Limit (dBm)	Margin (dB)
1	43.77	35.46	-95.26	-59.80	-13	-46.80
2	86.27	34.18	-95.26	-61.08	-13	-48.08
3	123.95	32.42	-95.26	-62.84	-13	-49.84
4	168.89	26.61	-95.26	-68.65	-13	-55.65
5	316.7	34.23	-95.26	-61.03	-13	-48.03
6	551.81	31.8	-95.26	-63.46	-13	-50.46

Remarks:

1. Follow ANSI 63.26 section 5.2.7 d), EIRP Value (dBm) = E (dB μ V/m) - Correction Factor @ 3m.
2. Correction Factor (dB) = 20log(D) - 104.8; where D is the measurement distance @3m.

LTE Band 5: 3MHz

Mode	TX channel 20415	Frequency Range	Below 1000 MHz
------	------------------	-----------------	----------------

Antenna Polarity & Test Distance: Horizontal at 3 M

No.	Freq. (MHz)	Reading (dB μ V/m)	Correction Factor (dB)	EIRP (dBm)	Limit (dBm)	Margin (dB)
1	41.02	32.95	-95.26	-62.31	-13	-49.31
2	102.7	33.96	-95.26	-61.30	-13	-48.30
3	157.66	27.66	-95.26	-67.60	-13	-54.60
4	182.81	33.13	-95.26	-62.13	-13	-49.13
5	323.38	30.86	-95.26	-64.40	-13	-51.40
6	445.94	28.65	-95.26	-66.61	-13	-53.61

Antenna Polarity & Test Distance: Vertical at 3 M

No.	Freq. (MHz)	Reading (dB μ V/m)	Correction Factor (dB)	EIRP (dBm)	Limit (dBm)	Margin (dB)
1	44.13	36.38	-95.26	-58.88	-13	-45.88
2	87.25	35.45	-95.26	-59.81	-13	-46.81
3	125.04	31.01	-95.26	-64.25	-13	-51.25
4	169.6	26.77	-95.26	-68.49	-13	-55.49
5	317.33	34.04	-95.26	-61.22	-13	-48.22
6	553.03	32.26	-95.26	-63.00	-13	-50.00

Remarks:

1. Follow ANSI 63.26 section 5.2.7 d), EIRP Value (dBm) = E (dB μ V/m) - Correction Factor @ 3m.
2. Correction Factor (dB) = 20log(D) – 104.8; where D is the measurement distance @3m.

Mode	TX channel 20525	Frequency Range	Below 1000 MHz
------	------------------	-----------------	----------------

Antenna Polarity & Test Distance: Horizontal at 3 M

No.	Freq. (MHz)	Reading (dB μ V/m)	Correction Factor (dB)	EIRP (dBm)	Limit (dBm)	Margin (dB)
1	41.41	32.76	-95.26	-62.50	-13	-49.50
2	103.02	34.38	-95.26	-60.88	-13	-47.88
3	156.78	27.17	-95.26	-68.09	-13	-55.09
4	183.51	32.95	-95.26	-62.31	-13	-49.31
5	322.9	30.84	-95.26	-64.42	-13	-51.42
6	446.38	28.22	-95.26	-67.04	-13	-54.04

Antenna Polarity & Test Distance: Vertical at 3 M

No.	Freq. (MHz)	Reading (dB μ V/m)	Correction Factor (dB)	EIRP (dBm)	Limit (dBm)	Margin (dB)
1	44.2	35.18	-95.26	-60.08	-13	-47.08
2	86.92	35.04	-95.26	-60.22	-13	-47.22
3	125.24	30.66	-95.26	-64.60	-13	-51.60
4	168.64	26.33	-95.26	-68.93	-13	-55.93
5	317.96	33.65	-95.26	-61.61	-13	-48.61
6	553.1	32.95	-95.26	-62.31	-13	-49.31

Remarks:

1. Follow ANSI 63.26 section 5.2.7 d), EIRP Value (dBm) = E (dB μ V/m) - Correction Factor @ 3m.
2. Correction Factor (dB) = 20log(D) - 104.8; where D is the measurement distance @3m.

Mode	TX channel 20635	Frequency Range	Below 1000 MHz
------	------------------	-----------------	----------------

Antenna Polarity & Test Distance: Horizontal at 3 M

No.	Freq. (MHz)	Reading (dB μ V/m)	Correction Factor (dB)	EIRP (dBm)	Limit (dBm)	Margin (dB)
1	40.79	32.71	-95.26	-62.55	-13	-49.55
2	102.02	35.09	-95.26	-60.17	-13	-47.17
3	158.6	28.19	-95.26	-67.07	-13	-54.07
4	182.55	33.6	-95.26	-61.66	-13	-48.66
5	322.77	31.36	-95.26	-63.90	-13	-50.90
6	446.06	28.32	-95.26	-66.94	-13	-53.94

Antenna Polarity & Test Distance: Vertical at 3 M

No.	Freq. (MHz)	Reading (dB μ V/m)	Correction Factor (dB)	EIRP (dBm)	Limit (dBm)	Margin (dB)
1	43.81	35.21	-95.26	-60.05	-13	-47.05
2	87.52	34.31	-95.26	-60.95	-13	-47.95
3	123.91	30.79	-95.26	-64.47	-13	-51.47
4	169.04	25.59	-95.26	-69.67	-13	-56.67
5	316.61	34.87	-95.26	-60.39	-13	-47.39
6	552.63	31.84	-95.26	-63.42	-13	-50.42

Remarks:

1. Follow ANSI 63.26 section 5.2.7 d), EIRP Value (dBm) = E (dB μ V/m) - Correction Factor @ 3m.
2. Correction Factor (dB) = 20log(D) - 104.8; where D is the measurement distance @3m.

LTE Band 5: 5MHz

Mode	TX channel 20425	Frequency Range	Below 1000 MHz
------	------------------	-----------------	----------------

Antenna Polarity & Test Distance: Horizontal at 3 M

No.	Freq. (MHz)	Reading (dB μ V/m)	Correction Factor (dB)	EIRP (dBm)	Limit (dBm)	Margin (dB)
1	41.05	31.44	-95.26	-63.82	-13	-50.82
2	102.53	34.58	-95.26	-60.68	-13	-47.68
3	158.52	28.71	-95.26	-66.55	-13	-53.55
4	184.14	33.66	-95.26	-61.60	-13	-48.60
5	322.08	30.05	-95.26	-65.21	-13	-52.21
6	446.86	28.25	-95.26	-67.01	-13	-54.01

Antenna Polarity & Test Distance: Vertical at 3 M

No.	Freq. (MHz)	Reading (dB μ V/m)	Correction Factor (dB)	EIRP (dBm)	Limit (dBm)	Margin (dB)
1	42.83	36.02	-95.26	-59.24	-13	-46.24
2	86.26	33.94	-95.26	-61.32	-13	-48.32
3	125.34	31.99	-95.26	-63.27	-13	-50.27
4	170.01	26.14	-95.26	-69.12	-13	-56.12
5	316.54	33.89	-95.26	-61.37	-13	-48.37
6	552.41	31.46	-95.26	-63.80	-13	-50.80

Remarks:

1. Follow ANSI 63.26 section 5.2.7 d), EIRP Value (dBm) = E (dB μ V/m) - Correction Factor @ 3m.
2. Correction Factor (dB) = 20log(D) – 104.8; where D is the measurement distance @3m.

Mode	TX channel 20525	Frequency Range	Below 1000 MHz
------	------------------	-----------------	----------------

Antenna Polarity & Test Distance: Horizontal at 3 M

No.	Freq. (MHz)	Reading (dB μ V/m)	Correction Factor (dB)	EIRP (dBm)	Limit (dBm)	Margin (dB)
1	41.53	33.09	-95.26	-62.17	-13	-49.17
2	102.01	35.28	-95.26	-59.98	-13	-46.98
3	157.33	27.89	-95.26	-67.37	-13	-54.37
4	182.57	33.21	-95.26	-62.05	-13	-49.05
5	322.37	31.36	-95.26	-63.90	-13	-50.90
6	446.38	27.46	-95.26	-67.80	-13	-54.80

Antenna Polarity & Test Distance: Vertical at 3 M

No.	Freq. (MHz)	Reading (dB μ V/m)	Correction Factor (dB)	EIRP (dBm)	Limit (dBm)	Margin (dB)
1	44.07	34.94	-95.26	-60.32	-13	-47.32
2	85.84	33.67	-95.26	-61.59	-13	-48.59
3	123.7	31.22	-95.26	-64.04	-13	-51.04
4	169.46	26.96	-95.26	-68.30	-13	-55.30
5	316.89	33.96	-95.26	-61.30	-13	-48.30
6	551.85	33.03	-95.26	-62.23	-13	-49.23

Remarks:

1. Follow ANSI 63.26 section 5.2.7 d), EIRP Value (dBm) = E (dB μ V/m) - Correction Factor @ 3m.
2. Correction Factor (dB) = 20log(D) - 104.8; where D is the measurement distance @3m.

Mode	TX channel 20625	Frequency Range	Below 1000 MHz
------	------------------	-----------------	----------------

Antenna Polarity & Test Distance: Horizontal at 3 M

No.	Freq. (MHz)	Reading (dB μ V/m)	Correction Factor (dB)	EIRP (dBm)	Limit (dBm)	Margin (dB)
1	41.74	32.89	-95.26	-62.37	-13	-49.37
2	102.68	33.59	-95.26	-61.67	-13	-48.67
3	158.22	27.17	-95.26	-68.09	-13	-55.09
4	184.37	32.81	-95.26	-62.45	-13	-49.45
5	323.11	29.87	-95.26	-65.39	-13	-52.39
6	446.16	28.92	-95.26	-66.34	-13	-53.34

Antenna Polarity & Test Distance: Vertical at 3 M

No.	Freq. (MHz)	Reading (dB μ V/m)	Correction Factor (dB)	EIRP (dBm)	Limit (dBm)	Margin (dB)
1	43.66	36.58	-95.26	-58.68	-13	-45.68
2	85.69	34.39	-95.26	-60.87	-13	-47.87
3	123.95	31.87	-95.26	-63.39	-13	-50.39
4	169.16	25.96	-95.26	-69.30	-13	-56.30
5	316.44	34.14	-95.26	-61.12	-13	-48.12
6	553.24	32.32	-95.26	-62.94	-13	-49.94

Remarks:

1. Follow ANSI 63.26 section 5.2.7 d), EIRP Value (dBm) = E (dB μ V/m) - Correction Factor @ 3m.
2. Correction Factor (dB) = 20log(D) - 104.8; where D is the measurement distance @3m.

LTE Band 5: 10MHz

Mode	TX channel 20450	Frequency Range	Below 1000 MHz
------	------------------	-----------------	----------------

Antenna Polarity & Test Distance: Horizontal at 3 M

No.	Freq. (MHz)	Reading (dB μ V/m)	Correction Factor (dB)	EIRP (dBm)	Limit (dBm)	Margin (dB)
1	40.9	31.25	-95.26	-64.01	-13	-51.01
2	101.83	34.22	-95.26	-61.04	-13	-48.04
3	158.4	27.88	-95.26	-67.38	-13	-54.38
4	184.01	33.54	-95.26	-61.72	-13	-48.72
5	322.24	31.69	-95.26	-63.57	-13	-50.57
6	445.85	28.28	-95.26	-66.98	-13	-53.98

Antenna Polarity & Test Distance: Vertical at 3 M

No.	Freq. (MHz)	Reading (dB μ V/m)	Correction Factor (dB)	EIRP (dBm)	Limit (dBm)	Margin (dB)
1	42.65	34.87	-95.26	-60.39	-13	-47.39
2	86.2	36	-95.26	-59.26	-13	-46.26
3	125.11	31.64	-95.26	-63.62	-13	-50.62
4	168.78	24.45	-95.26	-70.81	-13	-57.81
5	317.86	33.42	-95.26	-61.84	-13	-48.84
6	552.04	31.53	-95.26	-63.73	-13	-50.73

Remarks:

1. Follow ANSI 63.26 section 5.2.7 d), EIRP Value (dBm) = E (dB μ V/m) - Correction Factor @ 3m.
2. Correction Factor (dB) = 20log(D) – 104.8; where D is the measurement distance @3m.

Mode	TX channel 20525	Frequency Range	Below 1000 MHz
------	------------------	-----------------	----------------

Antenna Polarity & Test Distance: Horizontal at 3 M

No.	Freq. (MHz)	Reading (dB μ V/m)	Correction Factor (dB)	EIRP (dBm)	Limit (dBm)	Margin (dB)
1	40.34	31.54	-95.26	-63.72	-13	-50.72
2	102.61	33.67	-95.26	-61.59	-13	-48.59
3	158.1	28.61	-95.26	-66.65	-13	-53.65
4	184.11	34.45	-95.26	-60.81	-13	-47.81
5	322.97	30.39	-95.26	-64.87	-13	-51.87
6	447.15	28.22	-95.26	-67.04	-13	-54.04

Antenna Polarity & Test Distance: Vertical at 3 M

No.	Freq. (MHz)	Reading (dB μ V/m)	Correction Factor (dB)	EIRP (dBm)	Limit (dBm)	Margin (dB)
1	44.19	34.38	-95.26	-60.88	-13	-47.88
2	86.62	35.08	-95.26	-60.18	-13	-47.18
3	124.68	29.8	-95.26	-65.46	-13	-52.46
4	169.77	25.88	-95.26	-69.38	-13	-56.38
5	317.59	33.19	-95.26	-62.07	-13	-49.07
6	553.43	31.97	-95.26	-63.29	-13	-50.29

Remarks:

1. Follow ANSI 63.26 section 5.2.7 d), EIRP Value (dBm) = E (dB μ V/m) - Correction Factor @ 3m.
2. Correction Factor (dB) = 20log(D) - 104.8; where D is the measurement distance @3m.

Mode	TX channel 20600	Frequency Range	Below 1000 MHz
------	------------------	-----------------	----------------

Antenna Polarity & Test Distance: Horizontal at 3 M

No.	Freq. (MHz)	Reading (dB μ V/m)	Correction Factor (dB)	EIRP (dBm)	Limit (dBm)	Margin (dB)
1	41.26	32.77	-95.26	-62.49	-13	-49.49
2	102.78	35	-95.26	-60.26	-13	-47.26
3	157.19	28.46	-95.26	-66.80	-13	-53.80
4	182.41	34.15	-95.26	-61.11	-13	-48.11
5	323.58	29.9	-95.26	-65.36	-13	-52.36
6	446.98	28.39	-95.26	-66.87	-13	-53.87

Antenna Polarity & Test Distance: Vertical at 3 M

No.	Freq. (MHz)	Reading (dB μ V/m)	Correction Factor (dB)	EIRP (dBm)	Limit (dBm)	Margin (dB)
1	43.93	34.42	-95.26	-60.84	-13	-47.84
2	85.71	35.13	-95.26	-60.13	-13	-47.13
3	124.59	29.97	-95.26	-65.29	-13	-52.29
4	169.08	24.63	-95.26	-70.63	-13	-57.63
5	318.02	33.2	-95.26	-62.06	-13	-49.06
6	551.86	31.99	-95.26	-63.27	-13	-50.27

Remarks:

1. Follow ANSI 63.26 section 5.2.7 d), EIRP Value (dBm) = E (dB μ V/m) - Correction Factor @ 3m.
2. Correction Factor (dB) = 20log(D) - 104.8; where D is the measurement distance @3m.

ABOVE 1GHz

WCDMA:

Mode	TX channel 4132	Frequency Range	Above 1000 MHz
------	-----------------	-----------------	----------------

Antenna Polarity & Test Distance: Horizontal at 3 M

No.	Freq. (MHz)	Reading (dB μ V/m)	Correction Factor (dB)	EIRP (dBm)	Limit (dBm)	Margin (dB)
1	1652.8	37.33	-95.26	-57.93	-13	-44.93
2	2479.2	37.1	-95.26	-58.16	-13	-45.16
3	3305.6	45.7	-95.26	-49.56	-13	-36.56

Antenna Polarity & Test Distance: Vertical at 3 M

No.	Freq. (MHz)	Reading (dB μ V/m)	Correction Factor (dB)	EIRP (dBm)	Limit (dBm)	Margin (dB)
1	1652.8	37.76	-95.26	-57.50	-13	-44.50
2	2479.2	40.06	-95.26	-55.20	-13	-42.20
3	3305.6	44.91	-95.26	-50.35	-13	-37.35

Remarks:

1. Follow ANSI 63.26 section 5.2.7 d), EIRP Value (dBm) = E (dB μ V/m) - Correction Factor @ 3m.
2. Correction Factor (dB) = 20log(D) - 104.8; where D is the measurement distance @3m.

Mode	TX channel 4182	Frequency Range	Above 1000 MHz
------	-----------------	-----------------	----------------

Antenna Polarity & Test Distance: Horizontal at 3 M

No.	Freq. (MHz)	Reading (dB μ V/m)	Correction Factor (dB)	EIRP (dBm)	Limit (dBm)	Margin (dB)
1	1672.8	36.3	-95.26	-58.96	-13	-45.96
2	2509.2	36.65	-95.26	-58.61	-13	-45.61
3	3345.6	47.15	-95.26	-48.11	-13	-35.11

Antenna Polarity & Test Distance: Vertical at 3 M

No.	Freq. (MHz)	Reading (dB μ V/m)	Correction Factor (dB)	EIRP (dBm)	Limit (dBm)	Margin (dB)
1	1672.8	36.78	-95.26	-58.48	-13	-45.48
2	2509.2	38.41	-95.26	-56.85	-13	-43.85
3	3345.6	44.95	-95.26	-50.31	-13	-37.31

Remarks:

1. Follow ANSI 63.26 section 5.2.7 d), EIRP Value (dBm) = E (dB μ V/m) - Correction Factor @ 3m.
2. Correction Factor (dB) = 20log(D) - 104.8; where D is the measurement distance @3m.

Mode	TX channel 4233	Frequency Range	Above 1000 MHz
------	-----------------	-----------------	----------------

Antenna Polarity & Test Distance: Horizontal at 3 M

No.	Freq. (MHz)	Reading (dB μ V/m)	Correction Factor (dB)	EIRP (dBm)	Limit (dBm)	Margin (dB)
1	1693.2	36.11	-95.26	-59.15	-13	-46.15
2	2539.8	37.98	-95.26	-57.28	-13	-44.28
3	3386.4	46.19	-95.26	-49.07	-13	-36.07

Antenna Polarity & Test Distance: Vertical at 3 M

No.	Freq. (MHz)	Reading (dB μ V/m)	Correction Factor (dB)	EIRP (dBm)	Limit (dBm)	Margin (dB)
1	1693.2	37.39	-95.26	-57.87	-13	-44.87
2	2539.8	39.85	-95.26	-55.41	-13	-42.41
3	3386.4	46.1	-95.26	-49.16	-13	-36.16

Remarks:

1. Follow ANSI 63.26 section 5.2.7 d), EIRP Value (dBm) = E (dB μ V/m) - Correction Factor @ 3m.
2. Correction Factor (dB) = 20log(D) - 104.8; where D is the measurement distance @3m.

LTE Band 5: 1.4MHz

Mode	TX channel 20407	Frequency Range	Above 1000 MHz
------	------------------	-----------------	----------------

Antenna Polarity & Test Distance: Horizontal at 3 M

No.	Freq. (MHz)	Reading (dB μ V/m)	Correction Factor (dB)	EIRP (dBm)	Limit (dBm)	Margin (dB)
1	1649.4	36.88	-95.26	-58.38	-13	-45.38
2	2474.1	37.49	-95.26	-57.77	-13	-44.77
3	3298.8	46.2	-95.26	-49.06	-13	-36.06

Antenna Polarity & Test Distance: Vertical at 3 M

No.	Freq. (MHz)	Reading (dB μ V/m)	Correction Factor (dB)	EIRP (dBm)	Limit (dBm)	Margin (dB)
1	1649.4	37.37	-95.26	-57.89	-13	-44.89
2	2474.1	39.2	-95.26	-56.06	-13	-43.06
3	3298.8	45.13	-95.26	-50.13	-13	-37.13

Remarks:

1. Follow ANSI 63.26 section 5.2.7 d), EIRP Value (dBm) = E (dB μ V/m) - Correction Factor @ 3m.
2. Correction Factor (dB) = 20log(D) - 104.8; where D is the measurement distance @3m.

Mode	TX channel 20525	Frequency Range	Above 1000 MHz
------	------------------	-----------------	----------------

Antenna Polarity & Test Distance: Horizontal at 3 M

No.	Freq. (MHz)	Reading (dB μ V/m)	Correction Factor (dB)	EIRP (dBm)	Limit (dBm)	Margin (dB)
1	1673	37.3	-95.26	-57.96	-13	-44.96
2	2509.5	37.5	-95.26	-57.76	-13	-44.76
3	3346	45.8	-95.26	-49.46	-13	-36.46

Antenna Polarity & Test Distance: Vertical at 3 M

No.	Freq. (MHz)	Reading (dB μ V/m)	Correction Factor (dB)	EIRP (dBm)	Limit (dBm)	Margin (dB)
1	1673	37.8	-95.26	-57.46	-13	-44.46
2	2509.5	38.3	-95.26	-56.96	-13	-43.96
3	3346	44.5	-95.26	-50.76	-13	-37.76

Remarks:

1. Follow ANSI 63.26 section 5.2.7 d), EIRP Value (dBm) = E (dB μ V/m) - Correction Factor @ 3m.
2. Correction Factor (dB) = 20log(D) - 104.8; where D is the measurement distance @3m.

Mode	TX channel 20643	Frequency Range	Above 1000 MHz
------	------------------	-----------------	----------------

Antenna Polarity & Test Distance: Horizontal at 3 M

No.	Freq. (MHz)	Reading (dB μ V/m)	Correction Factor (dB)	EIRP (dBm)	Limit (dBm)	Margin (dB)
1	1696.6	37.96	-95.26	-57.30	-13	-44.30
2	2544.9	37.19	-95.26	-58.07	-13	-45.07
3	3393.2	45.71	-95.26	-49.55	-13	-36.55

Antenna Polarity & Test Distance: Vertical at 3 M

No.	Freq. (MHz)	Reading (dB μ V/m)	Correction Factor (dB)	EIRP (dBm)	Limit (dBm)	Margin (dB)
1	1696.6	37.51	-95.26	-57.75	-13	-44.75
2	2544.9	39.24	-95.26	-56.02	-13	-43.02
3	3393.2	43.96	-95.26	-51.30	-13	-38.30

Remarks:

1. Follow ANSI 63.26 section 5.2.7 d), EIRP Value (dBm) = E (dB μ V/m) - Correction Factor @ 3m.
2. Correction Factor (dB) = 20log(D) - 104.8; where D is the measurement distance @3m.

LTE Band 5: 3MHz

Mode	TX channel 20415	Frequency Range	Above 1000 MHz
------	------------------	-----------------	----------------

Antenna Polarity & Test Distance: Horizontal at 3 M

No.	Freq. (MHz)	Reading (dB μ V/m)	Correction Factor (dB)	EIRP (dBm)	Limit (dBm)	Margin (dB)
1	1651	37.22	-95.26	-58.04	-13	-45.04
2	2476.5	36.61	-95.26	-58.65	-13	-45.65
3	3302	45.72	-95.26	-49.54	-13	-36.54

Antenna Polarity & Test Distance: Vertical at 3 M

No.	Freq. (MHz)	Reading (dB μ V/m)	Correction Factor (dB)	EIRP (dBm)	Limit (dBm)	Margin (dB)
1	1651	38.19	-95.26	-57.07	-13	-44.07
2	2476.5	37.79	-95.26	-57.47	-13	-44.47
3	3302	43.77	-95.26	-51.49	-13	-38.49

Remarks:

1. Follow ANSI 63.26 section 5.2.7 d), EIRP Value (dBm) = E (dB μ V/m) - Correction Factor @ 3m.
2. Correction Factor (dB) = 20log(D) - 104.8; where D is the measurement distance @3m.

Mode	TX channel 20525	Frequency Range	Above 1000 MHz
------	------------------	-----------------	----------------

Antenna Polarity & Test Distance: Horizontal at 3 M

No.	Freq. (MHz)	Reading (dB μ V/m)	Correction Factor (dB)	EIRP (dBm)	Limit (dBm)	Margin (dB)
1	1673	37	-95.26	-58.26	-13	-45.26
2	2509.5	37.38	-95.26	-57.88	-13	-44.88
3	3346	45.07	-95.26	-50.19	-13	-37.19

Antenna Polarity & Test Distance: Vertical at 3 M

No.	Freq. (MHz)	Reading (dB μ V/m)	Correction Factor (dB)	EIRP (dBm)	Limit (dBm)	Margin (dB)
1	1673	38.12	-95.26	-57.14	-13	-44.14
2	2509.5	38.36	-95.26	-56.90	-13	-43.90
3	3346	44.18	-95.26	-51.08	-13	-38.08

Remarks:

1. Follow ANSI 63.26 section 5.2.7 d), EIRP Value (dBm) = E (dB μ V/m) - Correction Factor @ 3m.
2. Correction Factor (dB) = 20log(D) - 104.8; where D is the measurement distance @3m.

Mode	TX channel 20635	Frequency Range	Above 1000 MHz
------	------------------	-----------------	----------------

Antenna Polarity & Test Distance: Horizontal at 3 M

No.	Freq. (MHz)	Reading (dB μ V/m)	Correction Factor (dB)	EIRP (dBm)	Limit (dBm)	Margin (dB)
1	1695	36.81	-95.26	-58.45	-13	-45.45
2	2542.5	38.32	-95.26	-56.94	-13	-43.94
3	3390	45.78	-95.26	-49.48	-13	-36.48

Antenna Polarity & Test Distance: Vertical at 3 M

No.	Freq. (MHz)	Reading (dB μ V/m)	Correction Factor (dB)	EIRP (dBm)	Limit (dBm)	Margin (dB)
1	1695	37.05	-95.26	-58.21	-13	-45.21
2	2542.5	38.61	-95.26	-56.65	-13	-43.65
3	3390	45.32	-95.26	-49.94	-13	-36.94

Remarks:

1. Follow ANSI 63.26 section 5.2.7 d), EIRP Value (dBm) = E (dB μ V/m) - Correction Factor @ 3m.
2. Correction Factor (dB) = 20log(D) - 104.8; where D is the measurement distance @3m.

LTE Band 5: 5MHz

Mode	TX channel 20425	Frequency Range	Above 1000 MHz
------	------------------	-----------------	----------------

Antenna Polarity & Test Distance: Horizontal at 3 M

No.	Freq. (MHz)	Reading (dB μ V/m)	Correction Factor (dB)	EIRP (dBm)	Limit (dBm)	Margin (dB)
1	1653	37.64	-95.26	-57.62	-13	-44.62
2	2479.5	37.1	-95.26	-58.16	-13	-45.16
3	3306	46.24	-95.26	-49.02	-13	-36.02

Antenna Polarity & Test Distance: Vertical at 3 M

No.	Freq. (MHz)	Reading (dB μ V/m)	Correction Factor (dB)	EIRP (dBm)	Limit (dBm)	Margin (dB)
1	1653	37.13	-95.26	-58.13	-13	-45.13
2	2479.5	39.11	-95.26	-56.15	-13	-43.15
3	3306	43.96	-95.26	-51.30	-13	-38.30

Remarks:

1. Follow ANSI 63.26 section 5.2.7 d), EIRP Value (dBm) = E (dB μ V/m) - Correction Factor @ 3m.
2. Correction Factor (dB) = 20log(D) - 104.8; where D is the measurement distance @3m.

Mode	TX channel 20525	Frequency Range	Above 1000 MHz
------	------------------	-----------------	----------------

Antenna Polarity & Test Distance: Horizontal at 3 M

No.	Freq. (MHz)	Reading (dB μ V/m)	Correction Factor (dB)	EIRP (dBm)	Limit (dBm)	Margin (dB)
1	1673	38	-95.26	-57.26	-13	-44.26
2	2509.5	38.18	-95.26	-57.08	-13	-44.08
3	3346	46.76	-95.26	-48.50	-13	-35.50

Antenna Polarity & Test Distance: Vertical at 3 M

No.	Freq. (MHz)	Reading (dB μ V/m)	Correction Factor (dB)	EIRP (dBm)	Limit (dBm)	Margin (dB)
1	1673	38.76	-95.26	-56.50	-13	-43.50
2	2509.5	38.22	-95.26	-57.04	-13	-44.04
3	3346	44.2	-95.26	-51.06	-13	-38.06

Remarks:

1. Follow ANSI 63.26 section 5.2.7 d), EIRP Value (dBm) = E (dB μ V/m) - Correction Factor @ 3m.
2. Correction Factor (dB) = 20log(D) - 104.8; where D is the measurement distance @3m.

Mode	TX channel 20625	Frequency Range	Above 1000 MHz
------	------------------	-----------------	----------------

Antenna Polarity & Test Distance: Horizontal at 3 M

No.	Freq. (MHz)	Reading (dB μ V/m)	Correction Factor (dB)	EIRP (dBm)	Limit (dBm)	Margin (dB)
1	1693	36.85	-95.26	-58.41	-13	-45.41
2	2539.5	37.2	-95.26	-58.06	-13	-45.06
3	3386	45.65	-95.26	-49.61	-13	-36.61

Antenna Polarity & Test Distance: Vertical at 3 M

No.	Freq. (MHz)	Reading (dB μ V/m)	Correction Factor (dB)	EIRP (dBm)	Limit (dBm)	Margin (dB)
1	1693	38.1	-95.26	-57.16	-13	-44.16
2	2539.5	39.22	-95.26	-56.04	-13	-43.04
3	3386	44.04	-95.26	-51.22	-13	-38.22

Remarks:

1. Follow ANSI 63.26 section 5.2.7 d), EIRP Value (dBm) = E (dB μ V/m) - Correction Factor @ 3m.
2. Correction Factor (dB) = 20log(D) - 104.8; where D is the measurement distance @3m.

LTE Band 5: 10MHz

Mode	TX channel 20450	Frequency Range	Above 1000 MHz
------	------------------	-----------------	----------------

Antenna Polarity & Test Distance: Horizontal at 3 M

No.	Freq. (MHz)	Reading (dB μ V/m)	Correction Factor (dB)	EIRP (dBm)	Limit (dBm)	Margin (dB)
1	1658	36.62	-95.26	-58.64	-13	-45.64
2	2487	36.87	-95.26	-58.39	-13	-45.39
3	3316	45.55	-95.26	-49.71	-13	-36.71

Antenna Polarity & Test Distance: Vertical at 3 M

No.	Freq. (MHz)	Reading (dB μ V/m)	Correction Factor (dB)	EIRP (dBm)	Limit (dBm)	Margin (dB)
1	1658	37.72	-95.26	-57.54	-13	-44.54
2	2487	37.44	-95.26	-57.82	-13	-44.82
3	3316	43.72	-95.26	-51.54	-13	-38.54

Remarks:

1. Follow ANSI 63.26 section 5.2.7 d), EIRP Value (dBm) = E (dB μ V/m) - Correction Factor @ 3m.
2. Correction Factor (dB) = 20log(D) - 104.8; where D is the measurement distance @3m.

Mode	TX channel 20525	Frequency Range	Above 1000 MHz
------	------------------	-----------------	----------------

Antenna Polarity & Test Distance: Horizontal at 3 M

No.	Freq. (MHz)	Reading (dB μ V/m)	Correction Factor (dB)	EIRP (dBm)	Limit (dBm)	Margin (dB)
1	1673	37.05	-95.26	-58.21	-13	-45.21
2	2509.5	36.76	-95.26	-58.50	-13	-45.50
3	3346	46.34	-95.26	-48.92	-13	-35.92

Antenna Polarity & Test Distance: Vertical at 3 M

No.	Freq. (MHz)	Reading (dB μ V/m)	Correction Factor (dB)	EIRP (dBm)	Limit (dBm)	Margin (dB)
1	1673	38.39	-95.26	-56.87	-13	-43.87
2	2509.5	38.3	-95.26	-56.96	-13	-43.96
3	3346	45.09	-95.26	-50.17	-13	-37.17

Remarks:

1. Follow ANSI 63.26 section 5.2.7 d), EIRP Value (dBm) = E (dB μ V/m) - Correction Factor @ 3m.
2. Correction Factor (dB) = 20log(D) - 104.8; where D is the measurement distance @3m.

Mode	TX channel 20600	Frequency Range	Above 1000 MHz
------	------------------	-----------------	----------------

Antenna Polarity & Test Distance: Horizontal at 3 M

No.	Freq. (MHz)	Reading (dB μ V/m)	Correction Factor (dB)	EIRP (dBm)	Limit (dBm)	Margin (dB)
1	1688	37.69	-95.26	-57.57	-13	-44.57
2	2532	37.79	-95.26	-57.47	-13	-44.47
3	3376	45.61	-95.26	-49.65	-13	-36.65

Antenna Polarity & Test Distance: Vertical at 3 M

No.	Freq. (MHz)	Reading (dB μ V/m)	Correction Factor (dB)	EIRP (dBm)	Limit (dBm)	Margin (dB)
1	1688	38.49	-95.26	-56.77	-13	-43.77
2	2532	39.14	-95.26	-56.12	-13	-43.12
3	3376	43.7	-95.26	-51.56	-13	-38.56

Remarks:

1. Follow ANSI 63.26 section 5.2.7 d), EIRP Value (dBm) = E (dB μ V/m) - Correction Factor @ 3m.
2. Correction Factor (dB) = 20log(D) - 104.8; where D is the measurement distance @3m.

Pictures of Test Arrangements

Please refer to the attached file (Test Setup Photo).

Appendix – Information of the Testing Laboratories

We, Bureau Veritas Consumer Products Services (H.K.) Ltd., Taoyuan Branch, were founded in 1988 to provide our best service in EMC, Radio, Telecom and Safety consultation. Our laboratories are accredited and approved according to ISO/IEC 17025.

If you have any comments, please feel free to contact us at the following:

Lin Kou EMC/RF Lab

Tel: 886-2-26052180

Fax: 886-2-26051924

Hsin Chu EMC/RF/Telecom Lab

Tel: 886-3-6668565

Fax: 886-3-6668323

Hwa Ya EMC/RF/Safety Lab

Tel: 886-3-3183232

Fax: 886-3-3270892

Email: service.adt@tw.bureauveritas.com

Web Site: www.bureauveritas-adt.com

The address and road map of all our labs can be found in our web site also.

--- END ---