



FCC ID: APYHRO00273
Report No.: T190322E03-F

Page 1 / 48
Rev. 01

FCC 47 CFR PART 15 SUBPART B TEST REPORT

For

Smart phone

Issued for

Sharp Corporation, Mobile Communication B.U.

2-13-1, Hachihonmatsu-lida, Higashi-hiroshima-shi, Hiroshima, 739-0192, Japan

Issued By:

Compliance Certification Services Inc.

Wugu Laboratory

No.11, Wugong 6th Rd., Wugu Dist.,
New Taipei City 24891, Taiwan. (R.O.C.)

Issued Date: April 12, 2019

Note: *This document may be altered or revised by Compliance Certification Services Inc. personnel only, and shall be noted in the revision section of the document. The client should not use it to claim product endorsement by TAF, A2LA, NIST or any government agencies. The test results in the report only apply to the tested sample.*

Unless otherwise stated the results shown in this test report refer only to the sample(s) tested and such sample(s) are retained for 90 days only.
除非另有說明，此報告結果僅對測試之樣品負責，同時此樣品僅保留90天。本報告未經本公司書面許可，不可部分複製。

This document is issued by the Company subject to its General Conditions of Service printed overleaf, available on request or accessible at www.sgs.com/terms_and_conditions.htm and for electronic format documents, subject to Terms and Conditions for Electronic Documents at www.sgs.com/terms_e-document.htm. Attention is drawn to the limitation of liability, indemnification and jurisdiction issues defined therein. Any holder of this document is advised that information contained hereon reflects the Company's findings at the time of its intervention only and within the limits of Client's instructions, if any. The Company's sole responsibility is to its Client and this document does not exonerate parties to a transaction from exercising all their rights and obligations under the transaction documents. This document cannot be reproduced except in full, without prior written approval of the Company. Any unauthorized alteration, forgery or falsification of the content or appearance of this document is unlawful and offenders may be prosecuted to the fullest extent of the law.

Revision History

Rev.	Issue Date	Revisions	Effect Page	Revised By
00	April 11, 2019	Initial Issue	ALL	May Lin
01	April 12, 2019	1. Revised the pre-test mode and peripherals devices	P.6, P.9	May Lin

TABLE OF CONTENTS

1	TEST RESULT CERTIFICATION	4
2	EUT DESCRIPTION	5
3	TEST METHODOLOGY	6
3.1.	DECISION OF FINAL TEST MODE	6
3.2.	EUT SYSTEM OPERATION	7
4	SETUP OF EQUIPMENT UNDER TEST	8
4.1.	DESCRIPTION OF SUPPORT UNITS	8
4.2.	CONFIGURATION OF SYSTEM UNDER TEST	10
5	FACILITIES AND ACCREDITATIONS	13
5.1.	FACILITIES	13
5.2.	ACCREDITATIONS	13
5.3.	MEASUREMENT UNCERTAINTY	14
6	CONDUCTED EMISSION MEASUREMENT	15
6.1.	LIMITS OF CONDUCTED EMISSION MEASUREMENT	15
6.2.	TEST INSTRUMENTS	15
6.3.	TEST PROCEDURES.....	16
6.4.	TEST SETUP	17
6.5.	DATA SAMPLE:	17
6.6.	TEST RESULTS	18
7	RADIATED EMISSION MEASUREMENT	26
7.1.	LIMITS OF RADIATED EMISSION MEASUREMENT	26
7.2.	TEST INSTRUMENTS	28
7.3.	TEST PROCEDURES.....	29
7.4.	TEST SETUP	31
7.5.	DATA SAMPLE:	32
7.6.	TEST RESULTS	33
8	PHOTOGRAPHS OF THE TEST CONFIGURATION	A-1
APPENDIX 1 - PHOTOGRAPHS OF EUT		

Report No.: T190322E03-F

1 TEST RESULT CERTIFICATION

Product:	Smart phone
Applicant:	Sharp Corporation, Mobile Communication B.U. 2-13-1, Hachihonmatsu-lida, Higashi-hiroshima-shi, Hiroshima, 739-0192, Japan
Manufacturer:	Sharp Corporation 1 Takumi-cho, Sakai-ku, Sakai City, Osaka 590-8522, Japan
Tested:	March 22 ~ April 01, 2019
Test Voltage:	120Vac, 60Hz

EMISSION			
Standard	Item	Result	Remarks
FCC 47 CFR Part 15 Subpart B, ICES-003 Issue 6-2016 ANSI C63.4-2014	Conducted (Power Port)	PASS	Meet Class B limit
	Radiated	PASS	Meet Class B limit

Note: 1. The statements of test result on the above are decided by the request of test standard only; the measurement uncertainties are not factored into this compliance determination.
2. The information of measurement uncertainty is available upon the customer's request.

Deviation from Applicable Standard
None

The above equipment has been tested by Compliance Certification Services Inc., and found compliance with the requirements set forth in the technical standards mentioned above. The results of testing in this report apply only to the product/system, which was tested. Other similar equipment will not necessarily produce the same results due to production tolerance and measurement uncertainties.

Approved by:



Hex Chiang
Supervisor

Tested by:



Wiz Chang
Engineer

Report No.: T190322E03-F

2 EUT DESCRIPTION

Product	Smart phone
Applicant	Sharp Corporation, Mobile Communication B.U.
Housing material	Plastic
Identify Number	T190322E03
Received Date	March 22, 2019
Power Supply	AC 100 ~ 240V, 50 / 60Hz
Battery	3.85V, 3200mAh, 12.4Wh

Note:

1. Client consigns only one sample to test). Therefore, the testing Lab. just guarantees the unit, which has been tested.
2. Worst case:

FCC ID: APYHRO00273	DDR	UFS	PCB	(Select which one is worst case)
1st Source	Vender A	Vender B	Vender A	Worst case
2nd Source	Vender B	Vender B	Vender A	√
3rd Source	Vender C	Vender A	Vender B	√

I/O Port

I/O PORT TYPES	Q'TY	TESTED WITH
1. Type-C Port	1	1
2. Audio Port	1	1
3. SIM Card	1	1
4. Micro SD Card	1	1

Report No.: T190322E03-F

3 TEST METHODOLOGY

3.1. DECISION OF FINAL TEST MODE

1. The following test modes were scanned during the preliminary test:

Pre-Test Mode					
Accessories List: AC Charger: Salom / XN-2QC25 Data Cable: Luxshare-ICT/L6KU2007-CS-H PHF: Sony / MDR-EX15AP	Mode 1	Mode 2	Mode 3	Mode 4	Mode 5
Qi Wireless Charger Set: Charger board: SB / Wireless Charging Base AC Charger: PHIHONG / AA18A-120E					
Applicable standard	FCC 15B				
Accessories	EUT +AC Adaptor +USB Cable +PHF	EUT +USB Cable +PHF	EUT +AC Adaptor +USB Cable +PHF	EUT +Qi Wireless Charger Set	EUT + AC Adaptor +USB Cable +PHF
Main function	Speech	Data Link	Camera	Charger	RX Receiver
Additional function	BT + WIFI + GPS + NFC				
Description					
Radiated emission	GSM 850 / 1900 WCDMA BII / IV / V LTE B 02 / 04 / 05 / 07 / 12 / 13 / 17 / 38	Data R/W	MP3; REC mode (Front / Back); play REC	Charger	GSM 850 WCDMA B V LTE B 05 / 12 / 13 / 17
Conducted emission (DC Power)	N/A	N/A	N/A	N/A	N/A
Conducted emission (AC Power)	GSM 850 / 1900 WCDMA BII / IV / V LTE B 02 / 04 / 05 / 07 / 12 / 13 / 17 / 38	Data R/W	MP3; REC mode (Front / Back); play REC	Charger	GSM 850 WCDMA B V LTE B05 / 12 / 13 / 17

3.2. After the preliminary scan, the following test modes were found to produce the highest emission level.

Final Test Mode		
Emission	Conducted Emission	Mode 1 ~ 4
	Radiated Emission	Mode 1 ~ 4
Test Mode		
Emission	Radiated Emission (30MHz ~ 1GHz)	Mode 5

Then, the above highest emission mode of the configuration of the EUT and cable was chosen for all final test items.

Report No.: T190322E03-F

3.3. EUT SYSTEM OPERATION

Mode 1 & Mode 5:

1. Setup the EUT and simulators as shown on 4.2.
2. Turn on the power of all equipment.
3. The EUT communicates with Notebook PC Bluetooth radio.
4. The EUT communicates with CMW 500 by Link radio.
5. The EUT communicates with CMU 200 by Link radio.
6. The EUT communicates with GPS Simulator by Link radio
7. Setup the condition for test mode, and begin the test.

Note: Test program is self-repeating throughout the test.

Mode 2:

1. Setup the EUT and simulators as shown on 4.2.
2. Turn on the power of all equipment.
3. The EUT communicates with Notebook PC by Bluetooth radio.
4. The EUT communicates with GPS Simulator by Link radio
5. Setup the condition for test mode, and begin the test.

Note: Test program is self-repeating throughout the test.

Mode 3:

1. Setup the EUT and simulators as shown on 4.2.
2. Turn on the power of all equipment.
3. Setup the condition for test mode, and begin the test.

Note: Test program is self-repeating throughout the test.

Mode 4:

1. Setup the EUT and simulators as shown on 4.2.
2. Turn on the power of all equipment.
3. Setup the condition for test mode, and begin the test.

Note: Test program is self-repeating throughout the test.

Report No.: T190322E03-F

4 SETUP OF EQUIPMENT UNDER TEST

4.1. DESCRIPTION OF SUPPORT UNITS

The EUT has been tested as an independent unit together with other necessary accessories or support units. The following support units or accessories were used to form a representative test configuration during the tests.

Peripherals Devices:

Mode 1 & Mode 5:

No.	Equipment	Trade Name	Model No.	Serial No.	FCC ID / BSMI ID
1	SIM Card	N/A	N/A	N/A	N/A
2	Micro SD 2G	CAPSTONE	N/A	N/A	N/A
3	Earphone	Sony	MDR-EX15AP	N/A	N/A
4	Notebook PC (Remote)	HP	Pavilion dv6	CNF9491GLJ	R33022
5	Universal Radio Communication (Remote)	R & S	CMW 500	N/A	N/A
6	Universal Radio Communication (Remote)	R & S	CMU 200	N/A	N/A
7	GPS Simulator (Remote)	IFR	GPS-101	N/A	N/A

No.	Cable Name	Unit	Shielded	Length	With Core
(A)	USB Cable	1	<input checked="" type="checkbox"/> Shielded, <input type="checkbox"/> Non	1.5 m	<input type="checkbox"/> With Corex____, <input checked="" type="checkbox"/> Non
(B)	Earphone Cable	1	<input checked="" type="checkbox"/> Shielded, <input type="checkbox"/> Non	1.8 m	<input type="checkbox"/> With Corex____, <input checked="" type="checkbox"/> Non

Mode 2:

No.	Equipment	Trade Name	Model No.	Serial No.	FCC ID / BSMI ID
1	SIM Card	N/A	N/A	N/A	N/A
2	Micro SD 2G	CAPSTONE	N/A	N/A	N/A
3	Earphone	Sony	MDR-EX15AP	N/A	N/A
4	Notebook PC (Remote)	HP	Pavilion dv6	CNF9491GLJ	R33022
5	GPS Simulator (Remote)	IFR	GPS-101	N/A	N/A
6	Notebook PC	DELL	INSPIRON 640m	CN-0MG532-70166-75G-03AP	R33002
7	Mouse	DELL	MS111-L	CN-0HRG26-44751-21U-05YA	T41126

No.	Cable Name	Unit	Shielded	Length	With Core
(A)	USB Cable	1	<input checked="" type="checkbox"/> Shielded, <input type="checkbox"/> Non	1.5 m	<input type="checkbox"/> With Corex____, <input checked="" type="checkbox"/> Non
(B)	Earphone Cable	1	<input checked="" type="checkbox"/> Shielded, <input type="checkbox"/> Non	1.8 m	<input type="checkbox"/> With Corex____, <input checked="" type="checkbox"/> Non
(C)	USB Mouse Cable	1	<input checked="" type="checkbox"/> Shielded, <input type="checkbox"/> Non	1.8 m	<input type="checkbox"/> With Corex____, <input checked="" type="checkbox"/> Non

Report No.: T190322E03-F

Mode 3:

No.	Equipment	Trade Name	Model No.	Serial No.	FCC ID / BSMI ID
1	SIM Card	N/A	N/A	N/A	N/A
2	Micro SD 2G	CAPSTONE	N/A	N/A	N/A
3	Earphone	Sony	MDR-EX15AP	N/A	N/A

No.	Cable Name	Unit	Shielded	Length	With Core
(A)	USB Cable	1	<input checked="" type="checkbox"/> Shielded, <input type="checkbox"/> Non	1.5 m	<input type="checkbox"/> With Corex____, <input checked="" type="checkbox"/> Non
(B)	Earphone Cable	1	<input checked="" type="checkbox"/> Shielded, <input type="checkbox"/> Non	1.8 m	<input type="checkbox"/> With Corex____, <input checked="" type="checkbox"/> Non

Mode 4:

No.	Equipment	Trade Name	Model No.	Serial No.	FCC ID / BSMI ID
1	SIM Card	N/A	N/A	N/A	N/A
2	Micro SD 2G	CAPSTONE	N/A	N/A	N/A
3	Qi Wireless Charger board	SB	Wireless Charging Base	N/A	N/A
4	Qi Wireless Charger Adapter	PHIHONG	AA18A-120E	N/A	N/A

No.	Cable Name	Unit	Shielded	Length	With Core
(A)	USB Cable	1	<input checked="" type="checkbox"/> Shielded, <input type="checkbox"/> Non	1.8 m	<input type="checkbox"/> With Corex____, <input checked="" type="checkbox"/> Non

Note:

- 1) All the equipment/cables were placed in the worst-case configuration to maximize the emission during the test.
- 2) Grounding was established in accordance with the manufacturer's requirements and conditions for the intended use.

4.2. CONFIGURATION OF SYSTEM UNDER TEST

Mode 1 & Mode 5

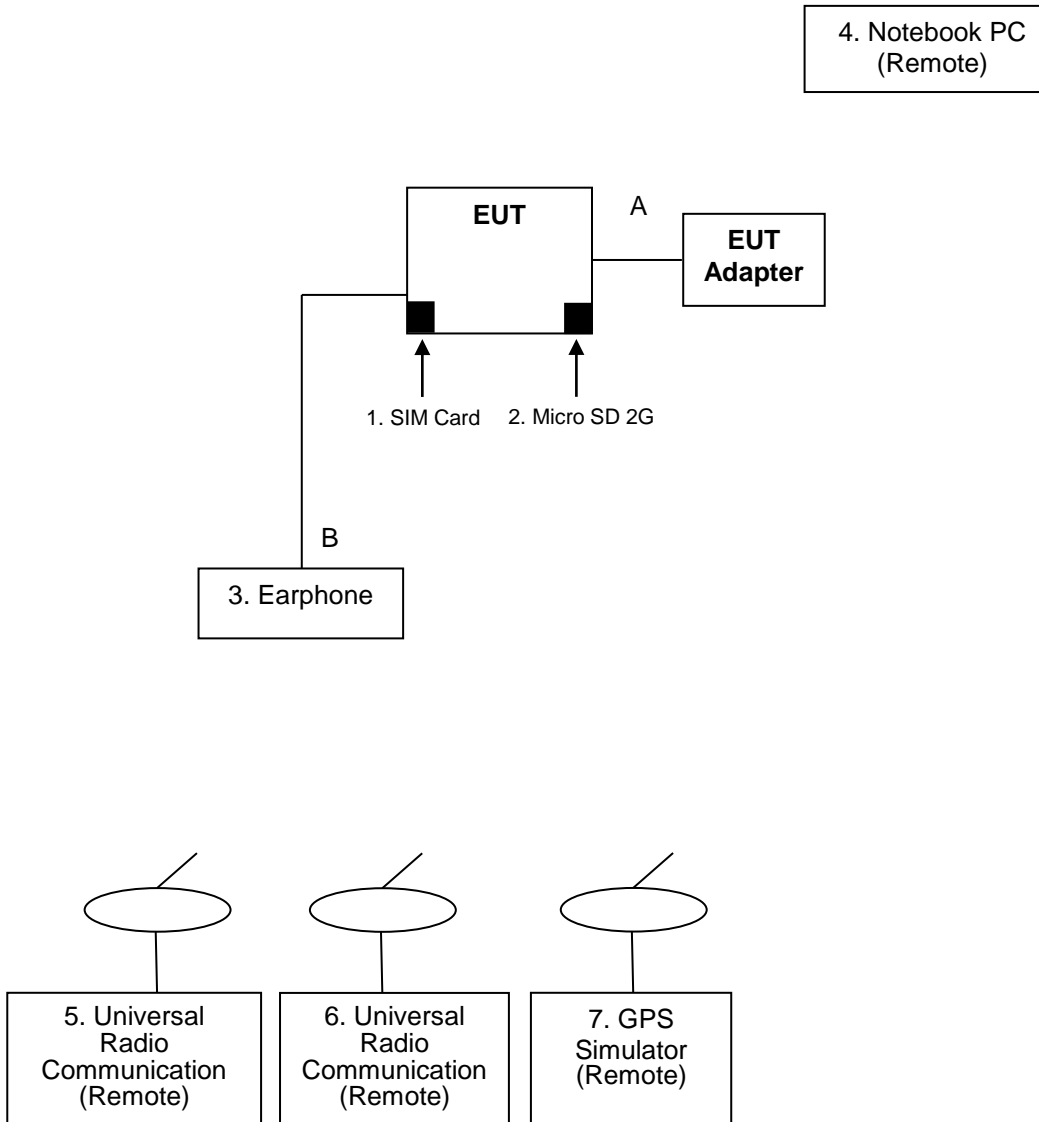

Mode 2

4. Notebook PC
(Remote)

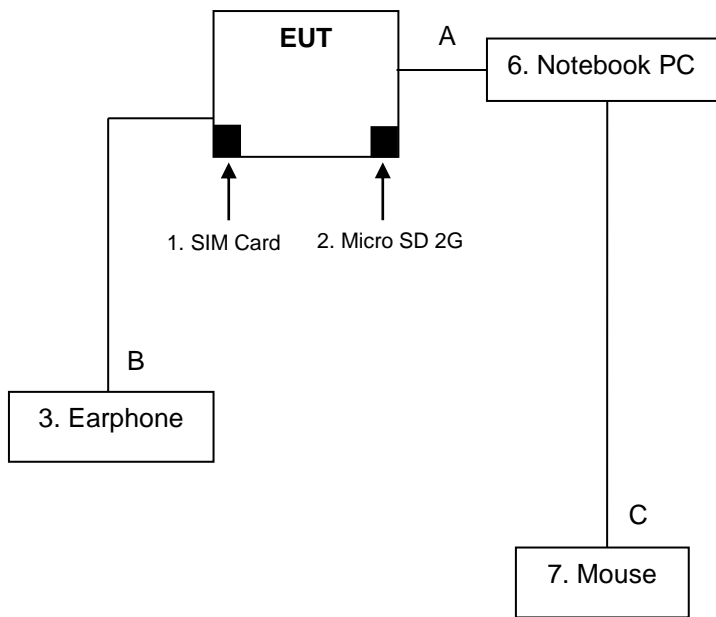

Mode 3

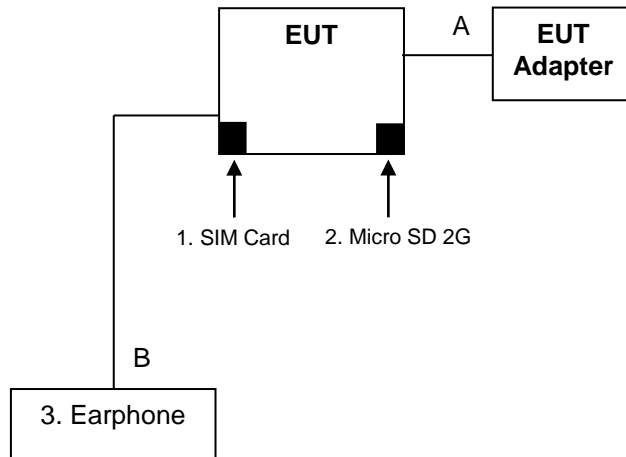

Mode 4

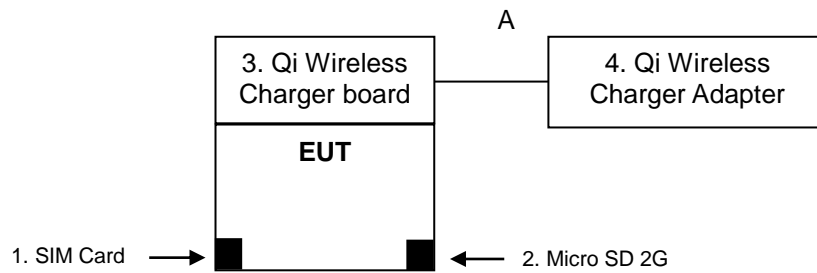

5 FACILITIES AND ACCREDITATIONS

5.1. FACILITIES

All measurement facilities used to collect the measurement data are located at:

- No.11, Wugong 6th Rd., Wugu Dist., New Taipei City 24891, Taiwan (R.O.C.)
- No.139, Wugong Rd., Wugu Dist., New Taipei City 24886, Taiwan (R.O.C.)
- No.163-1, Jhongsheng Rd., Sindian City, Taipei County 23151, Taiwan.

The sites are constructed in conformance with the requirements of ANSI C63.4 and CISPR 22. All receiving equipment conforms to CISPR 16-1-1, CISPR 16-1-2, CISPR 16-1-3, CISPR 16-1-4, CISPR 16-1-5.

5.2. ACCREDITATIONS

Our laboratories are accredited and approved by the following approval agencies according to ISO/IEC 17025.

Taiwan	TAF (TAF 1309)
USA	A2LA (0824.01)

The measuring facility of laboratories has been authorized or registered by the following approval agencies.

Canada	Industry Canada (10M Semi Anechoic Chamber: IC 2324G-1 / IC 2324G-2 / 2324J-1 / 2324J-2 to perform)
Japan	VCCI Radiated emissions: 30 MHz -1000 MHz: R-14343 / Above 1GHz: G-10945 Conducted Emission B: C-3700 / T-1839
USA	FCC (10M Semi Anechoic Chamber (FCC MRA: TW1039) to perform FCC Part 15 measurements)

Copies of granted accreditation certificates are available for downloading from our web site, <http://www.ccsrf.com>

Report No.: T190322E03-F

5.3. MEASUREMENT UNCERTAINTY

Where relevant, the following measurement uncertainty levels have been estimated for tests performed on the EUT as specified in CISPR 16-4-2:

Measurement	Frequency	Uncertainty
Conducted emissions #B	0.15MHz ~ 30MHz	±2.96 dB
Radiated emissions (10M Chamber)	30MHz ~ 200MHz	±4.45 dB
	200MHz ~ 1000MHz	±4.80 dB
	1GHz ~ 6GHz	±4.80 dB
	6GHz ~ 18GHz	±5.25 dB
	18GHz ~ 26GHz	±3.93 dB
	26GHz ~ 40GHz	±3.97 dB

This uncertainty represents an expanded uncertainty expressed at approximately the 95% confidence level using a coverage factor of k=2.

Consistent with industry standard (e.g. CISPR 22:2008, clause 11, Measurement Uncertainty) determining compliance with the limits shall be based on the results of the compliance measurement. Consequently the measured emissions being less than the maximum allowed emission result in this being a compliant test or passing test.

The listed uncertainties of the above table are the worst case values for the entire range of measurement. Please note that the uncertainty values are only provided for informational purposes and aren't used in determining the PASS/FAIL results.

Report No.: T190322E03-F

6 CONDUCTED EMISSION MEASUREMENT

6.1. LIMITS OF CONDUCTED EMISSION MEASUREMENT

FREQUENCY (MHz)	Class A (dBuV)		Class B (dBuV)	
	Quasi-peak	Average	Quasi-peak	Average
0.15 - 0.5	79	66	66 - 56	56 - 46
0.50 - 5.0	73	60	56	46
5.0 - 30.0	73	60	60	50

NOTE:

- (1) The lower limit shall apply at the transition frequencies.
- (2) The limit decreases in line with the logarithm of the frequency in the range 0.15 to 0.50 MHz
- (3) All emanations from a class A/B digital device or system, including any network of conductors and apparatus connected thereto, shall not exceed the level of field strengths specified above.

6.2. TEST INSTRUMENTS

Conducted Emission Room #B					
Name of Equipment	Manufacturer	Model	Serial Number	Calibration Date	Calibration Due
EMI Test Receiver	R&S	ESCI	101073	07/17/2018	07/16/2019
LISN	R&S	ENV216	101054	05/02/2018	05/01/2019
LISN	Schwarzbeck	NSLK8128	5012	04/23/2018	04/22/2019
Software	CCS-3A1-CE				

Note: The calibration interval of the above test instruments is 12 months and the calibrations are traceable to NML/ROC and NIST/USA.

6.3. TEST PROCEDURES (please refer to measurement standard or CCS SOP PA-031)

Procedure of Preliminary Test

- The EUT and support equipment, if needed, were set up as per the test configuration to simulate typical usage per the user's manual. When the EUT is a tabletop system, a wooden table with a height of 0.8 meters is used and is placed on the ground plane as per ANSI C63.4 (see Test Facility for the dimensions of the ground plane used). When the EUT is a floor standing equipment, it is placed on the ground plane, which has a 12 mm non-conductive covering to insulate the EUT from the ground plane.
- All I/O cables were positioned to simulate typical actual usage as per ANSI C63.4.
- The test equipment EUT installed by AC 120VAC/60Hz main power, through a Line Impedance Stabilization Network (LISN), which was supplied power source and was grounded to the ground plane.
- All support equipment power by from a second LISN.
- The test program of the EUT was started. Emissions were measured on each current carrying line of the EUT using an EMI Test Receiver connected to the LISN powering the EUT.
- The Receiver scanned from 150 kHz to 30MHz for emissions in each of the test modes.
- During the above scans, the emissions were maximized by cable manipulation.
- The test mode(s) described in Item 3.1 were scanned during the preliminary test.
- After the preliminary scan, we found the test mode described in Item 3.1 producing the highest emission level.
- The worst configuration of EUT and cable of the above highest emission level were recorded for reference of the final test.

Procedure of Final Test

- EUT and support equipment were set up on the test bench as per the configuration with highest emission level in the preliminary test.
- A scan was taken on both power lines, Line 1 and Line 2, recording at least the six highest emissions. Emission frequency and amplitude were recorded into a computer in which correction factors were used to calculate the emission level and compare reading to the applicable limit.
- The test data of the worst-case condition(s) was recorded.

Report No.: T190322E03-F

6.4. TEST SETUP

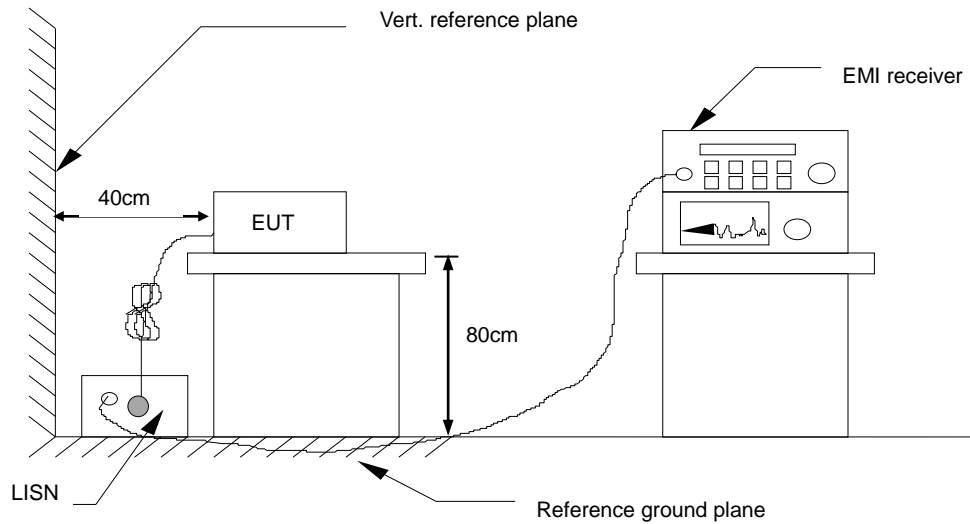

- For the actual test configuration, please refer to the related item – Photographs of the Test Configuration.

6.5. DATA SAMPLE:

Frequency (MHz)	QuasiPeak reading (dBuV)	Average reading (dBuV)	Correcrtion factor (dB)	QuasiPeak result (dBuV)	Average result (dBuV)	QuasiPeak. limit (dBuV)	Average limit (dBuV)	QuasiPeak margin (dB)	Average margin (dB)	Remark
x.xx	43.95	33.00	10.00	53.95	43.00	56.00	46.00	-2.05	-3.00	Pass

Frequency (MHz) = Emission frequency in MHz
 Reading (dBuV) = Uncorrected Analyzer/Receiver reading + Insertion loss of LISN, if it > 0.5 dB
 Correction Factor (dB) = LISN Factor + Cable Loss
 Result (dBuV) = Raw reading converted to dBuV and CF added
 Limit (dBuV) = Limit stated in standard
 Margin (dB) = Result (dBuV) – Limit (dBuV)

Report No.: T190322E03-F

6.6. TEST RESULTS

Test Mode	Mode 1	Line:	L1
Environmental Conditions	24°C, 50% RH	Test Date	2019/03/22
6dB Bandwidth	9 kHz	Tested by	Eason Liu

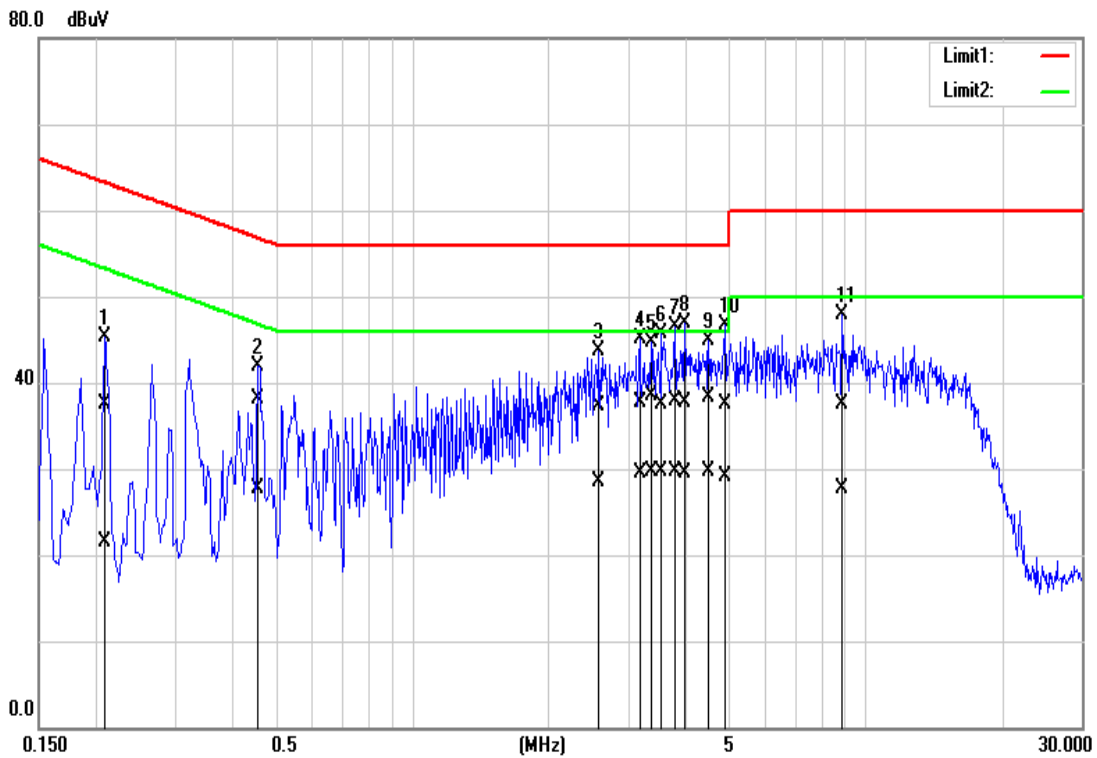

NO.	Frequency (MHz)	Quasi Peak reading (dBuV)	Average reading (dBuV)	Correction factor (dB)	Quasi Peak result (dBuV)	Average result (dBuV)	Quasi Peak limit (dBuV)	Average limit (dBuV)	Quasi Peak margin (dB)	Average margin (dB)	Remark (Pass/Fail)
1	0.2100	27.69	11.78	9.76	37.45	21.54	63.20	53.21	-25.75	-31.67	Pass
2	0.4580	28.44	17.91	9.76	38.20	27.67	56.73	46.73	-18.53	-19.06	Pass
3	2.5860	27.58	18.74	9.80	37.38	28.54	56.00	46.00	-18.62	-17.46	Pass
4	3.1820	27.88	19.64	9.82	37.70	29.46	56.00	46.00	-18.30	-16.54	Pass
5	3.3660	28.63	19.89	9.82	38.45	29.71	56.00	46.00	-17.55	-16.29	Pass
6	3.5500	27.71	19.80	9.82	37.53	29.62	56.00	46.00	-18.47	-16.38	Pass
7*	3.8140	28.02	19.94	9.82	37.84	29.76	56.00	46.00	-18.16	-16.24	Pass
8	3.9980	27.80	19.73	9.82	37.62	29.55	56.00	46.00	-18.38	-16.45	Pass
9	4.5020	28.53	19.81	9.83	38.36	29.64	56.00	46.00	-17.64	-16.36	Pass
10	4.9180	27.60	19.19	9.84	37.44	29.03	56.00	46.00	-18.56	-16.97	Pass
11	8.8700	27.56	17.85	9.93	37.49	27.78	60.00	50.00	-22.51	-22.22	Pass

REMARKS: L1 = Line One (Live Line)

Report No.: T190322E03-F

Test Mode	Mode 1	Line:	L2
Environmental Conditions	24°C, 50% RH	Test Date	2019/03/22
6dB Bandwidth	9 kHz	Tested by	Eason Liu

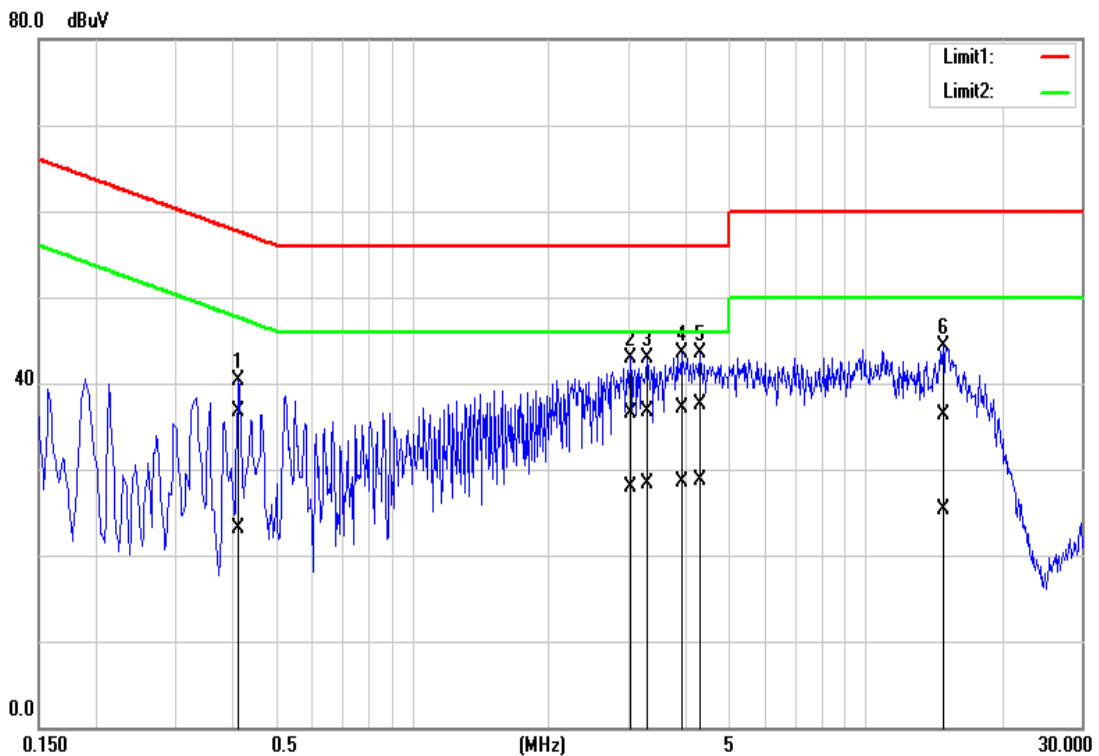

NO.	Frequency (MHz)	Quasi Peak reading (dBuV)	Average reading (dBuV)	Correction factor (dB)	Quasi Peak result (dBuV)	Average result (dBuV)	Quasi Peak limit (dBuV)	Average limit (dBuV)	Quasi Peak margin (dB)	Average margin (dB)	Remark (Pass/Fail)
1	0.4140	26.95	13.29	9.74	36.69	23.03	57.57	47.57	-20.88	-24.54	Pass
2	3.0300	26.68	18.05	9.79	36.47	27.84	56.00	46.00	-19.53	-18.16	Pass
3	3.3060	26.99	18.55	9.79	36.78	28.34	56.00	46.00	-19.22	-17.66	Pass
4	3.9340	27.35	18.67	9.80	37.15	28.47	56.00	46.00	-18.85	-17.53	Pass
5*	4.3260	27.63	18.89	9.80	37.43	28.69	56.00	46.00	-18.57	-17.31	Pass
6	14.9060	26.29	15.36	10.02	36.31	25.38	60.00	50.00	-23.69	-24.62	Pass

REMARKS: L2 = Line Two (Neutral Line)

Report No.: T190322E03-F

Test Mode	Mode 2	Line:	L1
Environmental Conditions	24°C, 50% RH	Test Date	2019/03/22
6dB Bandwidth	9 kHz	Tested by	Eason Liu

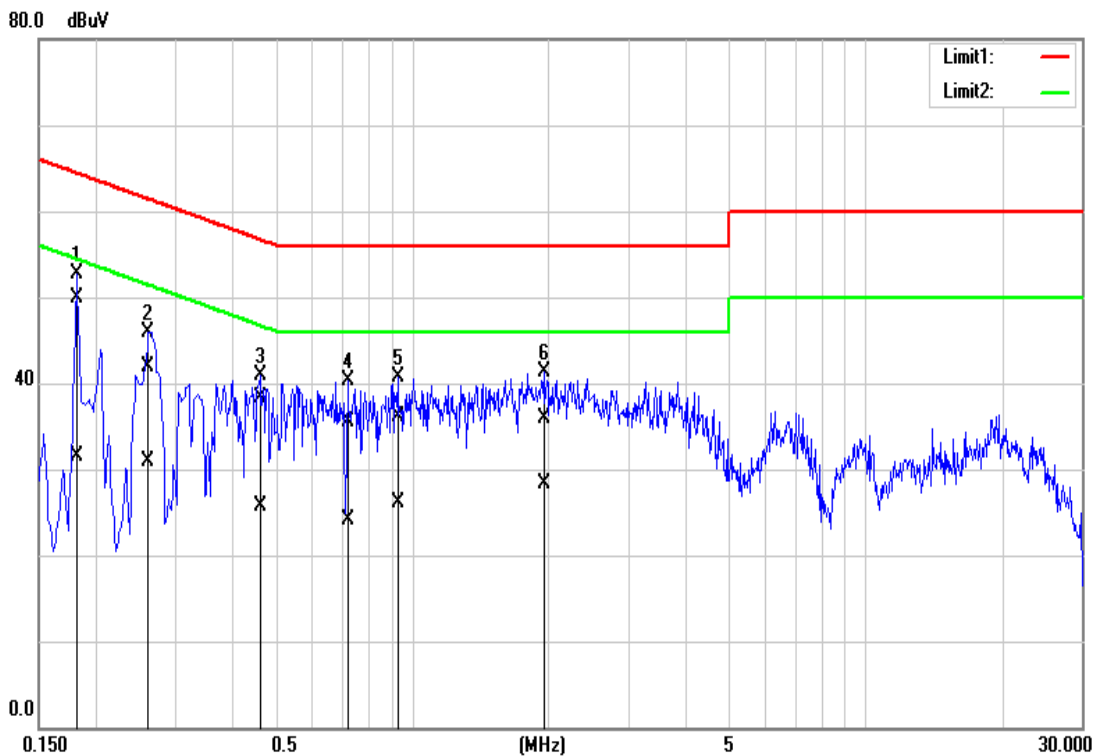

NO.	Frequency (MHz)	Quasi Peak reading (dBuV)	Average reading (dBuV)	Correction factor (dB)	Quasi Peak result (dBuV)	Average result (dBuV)	Quasi Peak limit (dBuV)	Average limit (dBuV)	Quasi Peak margin (dB)	Average margin (dB)	Remark (Pass/Fail)
1*	0.1819	40.15	21.75	9.76	49.91	31.51	64.39	54.40	-14.48	-22.89	Pass
2	0.2620	32.05	21.12	9.76	41.81	30.88	61.36	51.37	-19.55	-20.49	Pass
3	0.4620	28.61	15.98	9.76	38.37	25.74	56.66	46.66	-18.29	-20.92	Pass
4	0.7220	25.81	14.30	9.78	35.59	24.08	56.00	46.00	-20.41	-21.92	Pass
5	0.9300	26.26	16.24	9.78	36.04	26.02	56.00	46.00	-19.96	-19.98	Pass
6	1.9580	26.04	18.59	9.80	35.84	28.39	56.00	46.00	-20.16	-17.61	Pass

REMARKS: L1 = Line One (Live Line)

Report No.: T190322E03-F

Test Mode	Mode 2	Line:	L2
Environmental Conditions	24°C, 50% RH	Test Date	2019/03/22
6dB Bandwidth	9 kHz	Tested by	Eason Liu

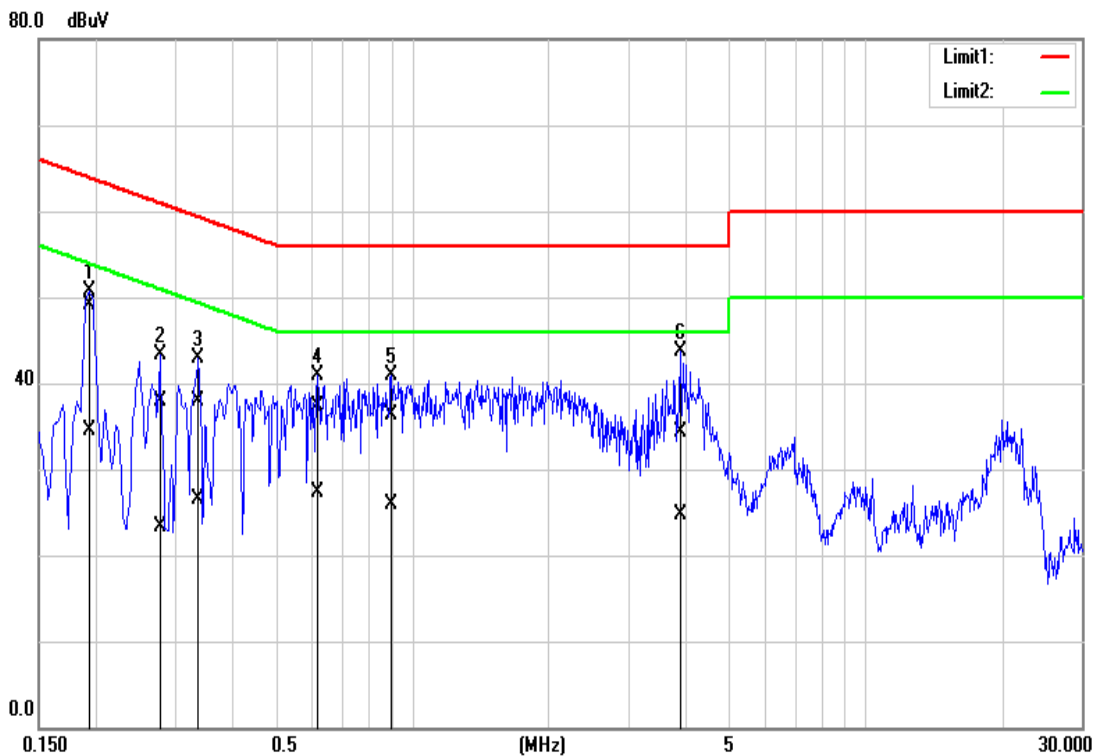

NO.	Frequency (MHz)	Quasi Peak reading (dBuV)	Average reading (dBuV)	Correction factor (dB)	Quasi Peak result (dBuV)	Average result (dBuV)	Quasi Peak limit (dBuV)	Average limit (dBuV)	Quasi Peak margin (dB)	Average margin (dB)	Remark (Pass/Fail)
1*	0.1940	39.39	24.78	9.73	49.12	34.51	63.86	53.86	-14.74	-19.35	Pass
2	0.2779	28.16	13.67	9.73	37.89	23.40	60.88	50.88	-22.99	-27.48	Pass
3	0.3379	28.24	16.85	9.74	37.98	26.59	59.25	49.25	-21.27	-22.66	Pass
4	0.6180	27.60	17.54	9.74	37.34	27.28	56.00	46.00	-18.66	-18.72	Pass
5	0.9020	26.58	16.16	9.75	36.33	25.91	56.00	46.00	-19.67	-20.09	Pass
6	3.9100	24.58	14.92	9.80	34.38	24.72	56.00	46.00	-21.62	-21.28	Pass

REMARKS: L2 = Line Two (Neutral Line)

Test Mode	Mode 3	Line:	L1
Environmental Conditions	24°C, 50% RH	Test Date	2019/03/22
6dB Bandwidth	9 kHz	Tested by	Eason Liu

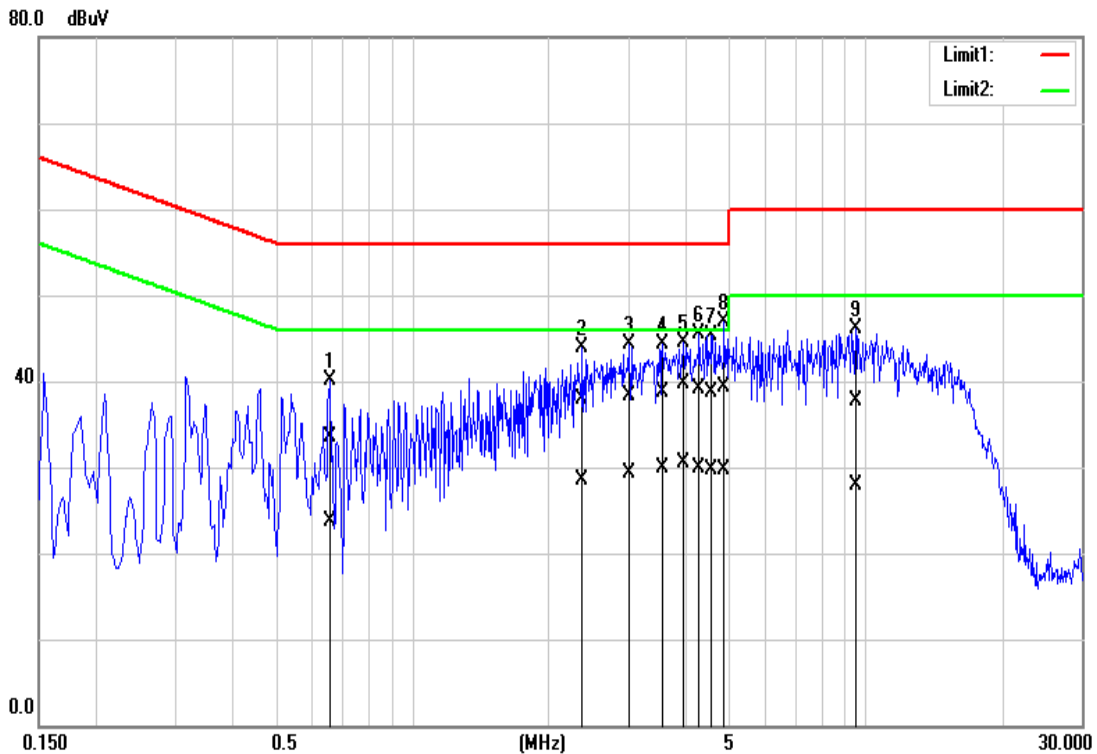

NO.	Frequency (MHz)	Quasi Peak reading (dBuV)	Average reading (dBuV)	Correction factor (dB)	Quasi Peak result (dBuV)	Average result (dBuV)	Quasi Peak limit (dBuV)	Average limit (dBuV)	Quasi Peak margin (dB)	Average margin (dB)	Remark (Pass/Fail)
1	0.6580	23.83	13.99	9.76	33.59	23.75	56.00	46.00	-22.41	-22.25	Pass
2	2.3780	28.17	18.62	9.80	37.97	28.42	56.00	46.00	-18.03	-17.58	Pass
3	3.0220	28.41	19.43	9.81	38.22	29.24	56.00	46.00	-17.78	-16.76	Pass
4	3.5740	28.86	20.18	9.82	38.68	30.00	56.00	46.00	-17.32	-16.00	Pass
5*	3.9740	29.96	20.63	9.82	39.78	30.45	56.00	46.00	-16.22	-15.55	Pass
6	4.2940	29.20	20.16	9.82	39.02	29.98	56.00	46.00	-16.98	-16.02	Pass
7	4.5739	28.82	19.88	9.83	38.65	29.71	56.00	46.00	-17.35	-16.29	Pass
8	4.8940	29.47	19.85	9.84	39.31	29.69	56.00	46.00	-16.69	-16.31	Pass
9	9.5020	27.69	17.93	9.95	37.64	27.88	60.00	50.00	-22.36	-22.12	Pass

REMARKS: L1 = Line One (Live Line)

Report No.: T190322E03-F

Test Mode	Mode 3	Line:	L2
Environmental Conditions	24°C, 50% RH	Test Date	2019/03/22
6dB Bandwidth	9 kHz	Tested by	Eason Liu

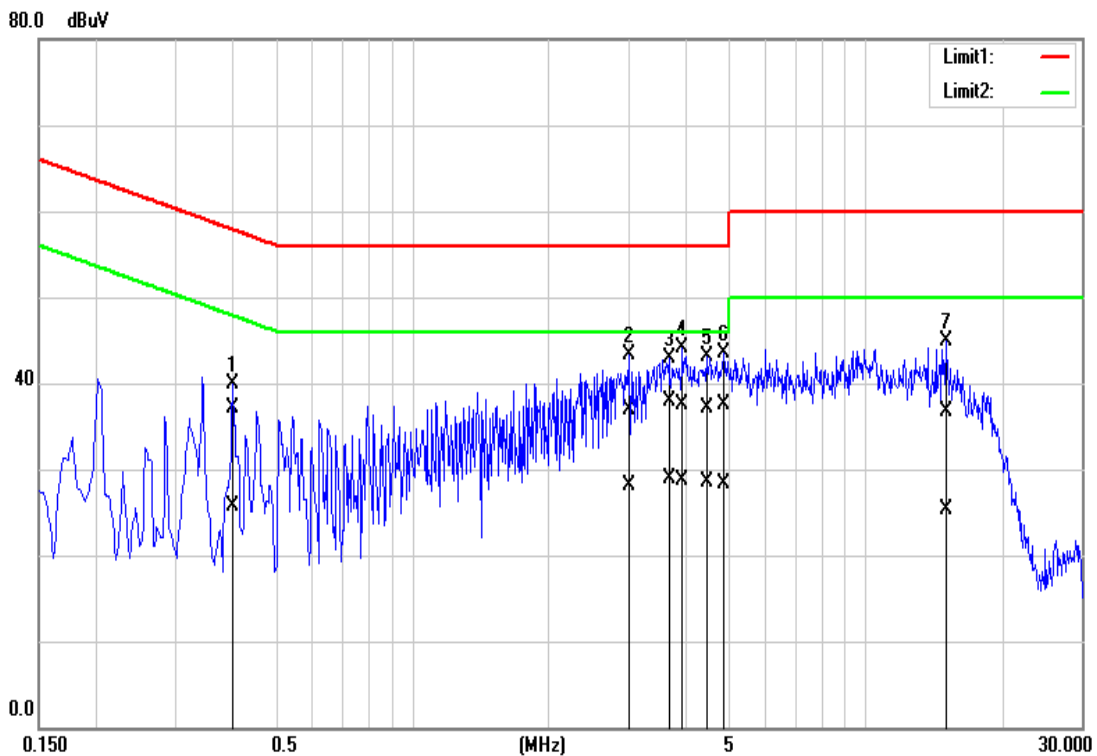

NO.	Frequency (MHz)	Quasi Peak reading (dBuV)	Average reading (dBuV)	Correction factor (dB)	Quasi Peak result (dBuV)	Average result (dBuV)	Quasi Peak limit (dBuV)	Average limit (dBuV)	Quasi Peak margin (dB)	Average margin (dB)	Remark (Pass/Fail)
1	0.4020	27.33	15.94	9.74	37.07	25.68	57.81	47.81	-20.74	-22.13	Pass
2	3.0220	27.04	18.28	9.79	36.83	28.07	56.00	46.00	-19.17	-17.93	Pass
3*	3.6980	28.15	19.20	9.80	37.95	29.00	56.00	46.00	-18.05	-17.00	Pass
4	3.9500	27.69	19.00	9.80	37.49	28.80	56.00	46.00	-18.51	-17.20	Pass
5	4.4580	27.34	18.70	9.82	37.16	28.52	56.00	46.00	-18.84	-17.48	Pass
6	4.8740	27.72	18.50	9.82	37.54	28.32	56.00	46.00	-18.46	-17.68	Pass
7	15.1140	26.62	15.34	10.02	36.64	25.36	60.00	50.00	-23.36	-24.64	Pass

REMARKS: L2 = Line Two (Neutral Line)

Report No.: T190322E03-F

Test Mode	Mode 4	Line:	L1
Environmental Conditions	24°C, 50% RH	Test Date	2019/03/22
6dB Bandwidth	9 kHz	Tested by	Eason Liu

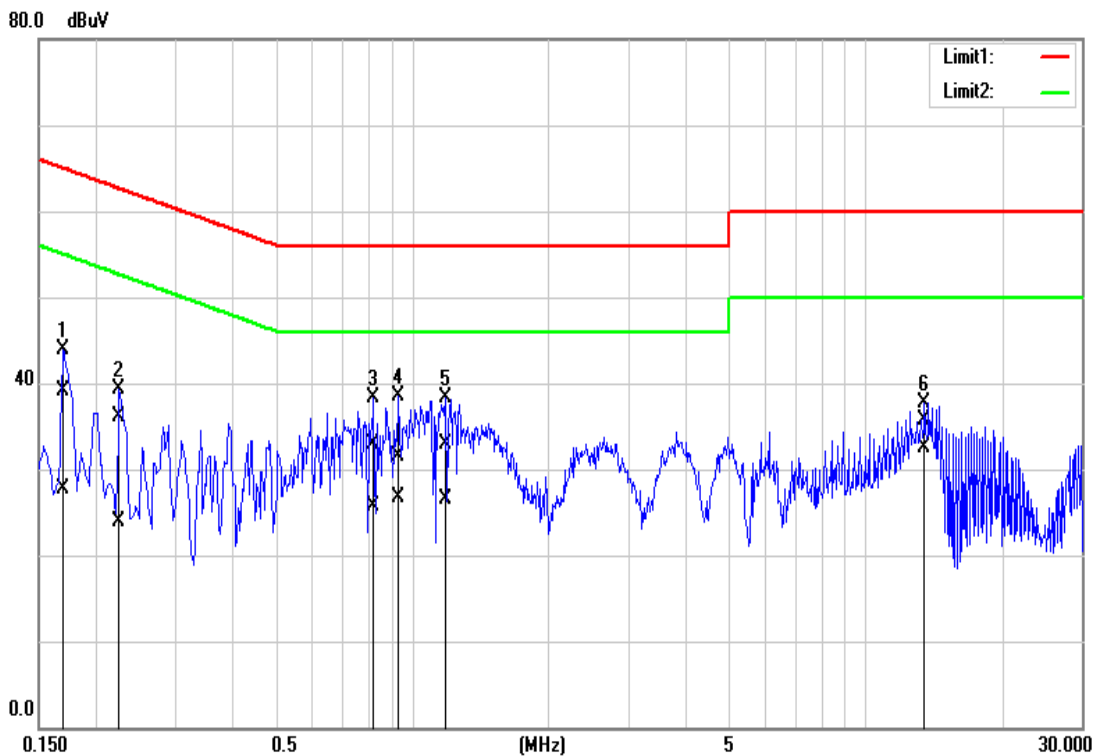

NO.	Frequency (MHz)	Quasi Peak reading (dBuV)	Average reading (dBuV)	Correction factor (dB)	Quasi Peak result (dBuV)	Average result (dBuV)	Quasi Peak limit (dBuV)	Average limit (dBuV)	Quasi Peak margin (dB)	Average margin (dB)	Remark (Pass/Fail)
1	0.1700	29.30	17.85	9.76	39.06	27.61	64.96	54.96	-25.90	-27.35	Pass
2	0.2260	26.33	14.18	9.76	36.09	23.94	62.59	52.60	-26.50	-28.66	Pass
3	0.8220	23.16	15.93	9.78	32.94	25.71	56.00	46.00	-23.06	-20.29	Pass
4	0.9340	21.82	16.93	9.78	31.60	26.71	56.00	46.00	-24.40	-19.29	Pass
5	1.1860	23.18	16.75	9.78	32.96	26.53	56.00	46.00	-23.04	-19.47	Pass
6*	13.5460	25.78	22.45	10.00	35.78	32.45	60.00	50.00	-24.22	-17.55	Pass

REMARKS: L1 = Line One (Live Line)

Report No.: T190322E03-F

Test Mode	Mode 4	Line:	L2
Environmental Conditions	24°C, 50% RH	Test Date	2019/03/22
6dB Bandwidth	9 kHz	Tested by	Eason Liu

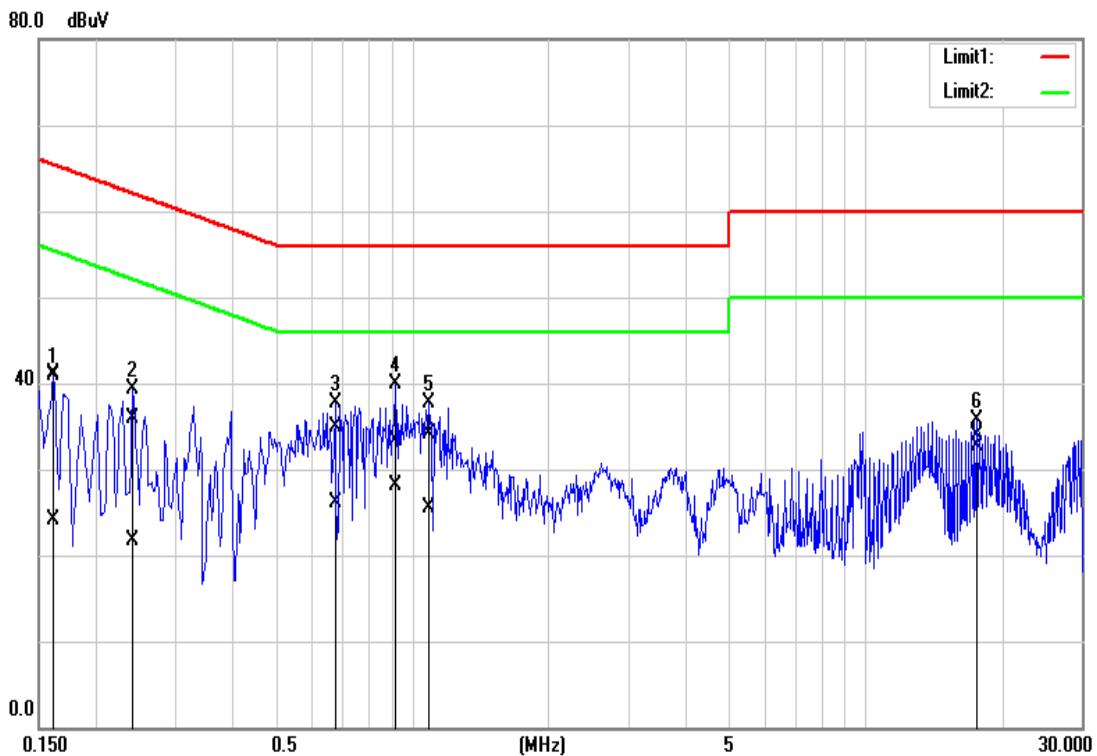

NO.	Frequency (MHz)	Quasi Peak reading (dBuV)	Average reading (dBuV)	Correction factor (dB)	Quasi Peak result (dBuV)	Average result (dBuV)	Quasi Peak limit (dBuV)	Average limit (dBuV)	Quasi Peak margin (dB)	Average margin (dB)	Remark (Pass/Fail)
1	0.1620	31.30	14.43	9.73	41.03	24.16	65.36	55.36	-24.33	-31.20	Pass
2	0.2420	26.25	12.02	9.73	35.98	21.75	62.02	52.03	-26.04	-30.28	Pass
3	0.6780	25.09	16.29	9.74	34.83	26.03	56.00	46.00	-21.17	-19.97	Pass
4	0.9220	23.65	18.35	9.75	33.40	28.10	56.00	46.00	-22.60	-17.90	Pass
5	1.0900	24.43	15.79	9.75	34.18	25.54	56.00	46.00	-21.82	-20.46	Pass
6*	17.6340	23.88	22.71	10.06	33.94	32.77	60.00	50.00	-26.06	-17.23	Pass

REMARKS: L2 = Line Two (Neutral Line)

Report No.: T190322E03-F

7 RADIATED EMISSION MEASUREMENT

7.1. LIMITS OF RADIATED EMISSION MEASUREMENT

According to FCC Part 15.33 (b), for an unintentional radiator, including a digital device, the spectrum shall be investigated from the lowest radio frequency signal generated or used in the device, without going below the lowest frequency for which a radiated emission limit is specified, up to the frequency shown in the following table:

Highest frequency generated or used in the device or on which the device operates or tunes (MHz)	Upper frequency of measurement range (MHz)
Below 1.75	30
1.75-108	1000
108-500	2000
500-1000	5000
Above 1000	5 th harmonic of the highest frequency or 40GHz, whichever is lower

Below 1GHz (for digital device)

FREQUENCY (MHz)	dBuV/m (At 10m)	
	Class A	Class B
30 ~ 230	40	30
230 ~ 1000	47	37

Limit tables for digital device:

Class A Radiated Emission limit at 10m (for others)

Frequency (MHz)	Field Strength Limit (uV/m)Q.P.	Field Strength Limit (dBuV/m)Q.P.
30 - 88	90	39
88 - 216	150	43.5
216 - 960	210	46.4
Above 960	300	49.5

Class B Radiated Emission limit at 3m (for others)

Frequency (MHz)	Field Strength Limit (uV/m)Q.P.	Field Strength Limit (dBuV/m)Q.P.
30 - 88	100	40
88 - 216	150	43.5
216 - 960	200	46
Above 960	500	54

Above 1GHz (for all device)

Frequency (MHz)	Class A (dBuV/m) (At 10m)		Class B (dBuV/m) (At 3m)	
	Average	Peak	Average	Peak
Above 1000	49.5	69.5	54	74

- NOTE:** (1) The lower limit shall apply at the transition frequencies.
 (2) Emission level (dBuV/m) = 20 log Emission level (uV/m).
 (3) The measurement above 1GHz is at close-in distances 3m, and determine the limit **L2** corresponding to the close-in distance **d2** by applying the following relation: $L2 = L1 (d1/d2)$, where **L1** is the specified limit in microvolts per metre (**uV/m**) at the distance **d1 (10m)**, **L2** is the new limit for distance **d2 (3m)**.
 So the new Class A limit above 1GHz at 3m is as following table:

Frequency (MHz)	Class A (dBuV/m) (At 3m)	
	Average	Peak
Above 1000	60	80

Report No.: T190322E03-F

7.2. TEST INSTRUMENTS

Wugu 10M Chamber					
Name of Equipment	Manufacturer	Model	Serial Number	Calibration Date	Calibration Due
Bilog Antenna	TESEQ	CBL 6112D	31674	03/06/2019	03/05/2020
Bilog Antenna	TESEQ	CBL 6112D	31675	03/22/2019	03/21/2020
Coaxial Cable	Huber+Suhner	SUCOFLEX 104PEA	330029	05/02/2018	05/01/2019
Coaxial Cable	Huber+Suhner	SUCOFLEX 104PEA	329383	05/02/2018	05/01/2019
Coaxial Cable	Huber+Suhner	104PEA	33948/4PEA	05/02/2018	05/01/2019
Coaxial Cable	Huber+Suhner	104PEA	33949/4PEA	05/02/2018	05/01/2019
EMI Test Receiver	R&S	ESCI	100961	07/04/2018	07/03/2019
EMI Test Receiver	R&S	ESCI	100962	07/10/2018	07/09/2019
Horn Antenna	ETS LINDGREN	3116	00026370	12/26/2018	12/25/2019
Horn Antenna	EMCO	3117	00055167	12/24/2018	12/23/2019
Pre-Amplifier	HP	8447D	2944A07754	05/02/2018	05/01/2019
Pre-Amplifier	HP	8447D	2944A08150	05/02/2018	05/01/2019
Pre-Amplifier	EMCI	EMC051845	980040	05/02/2018	05/01/2019
Pre-Amplifier	MITEQ	AMF-6F-260400-40-8P	985646	06/21/2018	06/20/2019
Spectrum Analyzer	Agilent	E4446A	MY48250297	08/30/2018	08/29/2019
AC POWER SOURCE	APE	AFC-130	991259	N.C.R	N.C.R
Antenna Tower	CCS	CC-A-1F	N/A	N.C.R	N.C.R
Antenna Tower	Sunol Sciences	TLT2	031010-5	N.C.R	N.C.R
Controller	CCS	CC-C-1F	N/A	N.C.R	N.C.R
Controller	Sunol Sciences	SC104V	031010-1	N.C.R	N.C.R
Turn Table	CCS	CC-T-1F	N/A	N.C.R	N.C.R
Software	EZ-EMC (CCS-3A1RE)				

Note:

1. The calibration interval of the above test instruments is 12 months and the calibrations are traceable to NML/ROC and NIST/USA.
2. N.C.R. = No Calibration Required.

7.3. TEST PROCEDURES (please refer to measurement standard or CCS SOP PA-031)

The basic test procedure was in accordance with ANSI C63.4-2014 and ICES-003-2016.

Frequency range 30MHz ~ 1GHz

1. The EUT was placed on the top of a rotating table 0.8 meters above the ground at a 10 meter semi-anechoic chamber room. The table was rotated 360 degrees to determine the position.
2. The EUT was set 10 meters away from the interference-receiving antenna, which was mounted on the top of a variable-height antenna tower.
3. The height of antenna is varied from one meter to four meter above the ground to determine the maximum value of the field strength. Both horizontal and vertical polarizations of the antenna are set to make the measurement.
4. For each suspected emission, the EUT was arranged to its worst case and then the antenna was turned to heights for 1 meter to 4 meters and the turn table was turned from 0 degrees to 360 degrees to find the maximum reading.
5. The test-receiver system was set to quasi-peak detect function and specified bandwidth with maximum hold mode when the test frequency is below 1GHz.

NOTE: The resolution bandwidth of test receiver/spectrum analyzer is 120 kHz for Quasi-peak detection (QP) at frequency below 1GHz.

Frequency range above 1GHz

1. The EUT was placed on the top of a rotating table 0.8 meters above the ground at a 3 meter semi-anechoic chamber room. The table was rotated 360 degrees to determine the position.
2. The EUT was set 3 meters away from the directional antenna, which was pointed towards the source of the emission within the EUT. This could be done by either pointing the antenna at an angle towards the source of the emission, or by rotating the EUT, in both height and polarization, to maximize the measured emission.
3. The height of antenna can be varied from one meter to four meters, the height of adjustment depends on the EUT height and the antenna 3 dB beam width both, to detect the maximum value of the field strength. Both horizontal and vertical polarizations of the antenna are set to make the measurement.
4. For each suspected emission, the EUT was arranged to its worst case and then the antenna was turned to heights and the rotatable table was turned from 0 degrees to 360 degrees to find the maximum reading.
5. The test-receiver system was set to peak and average detect function and specified bandwidth with maximum hold mode when the test frequency is above 1GHz.

NOTE:

1. The resolution bandwidth is 1MHz and video bandwidth of test spectrum analyzer is 1 MHz for peak detection at above 1GHz. The resolution bandwidth is 1MHz and video bandwidth of test spectrum analyzer is 100Hz for average detection at frequency above 1 GHz.
2. For measurement of frequency above 1GHz, the EUT was set 3 meters away from the directional antenna.

7.4. TEST SETUP

Below 1GHz

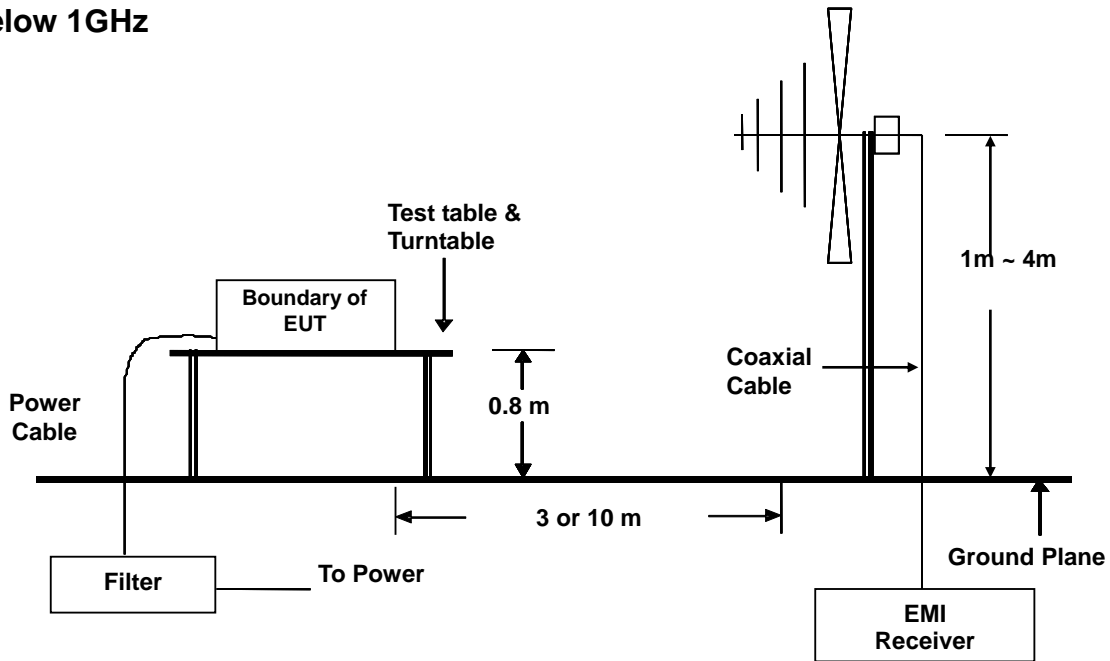

Above 1GHz

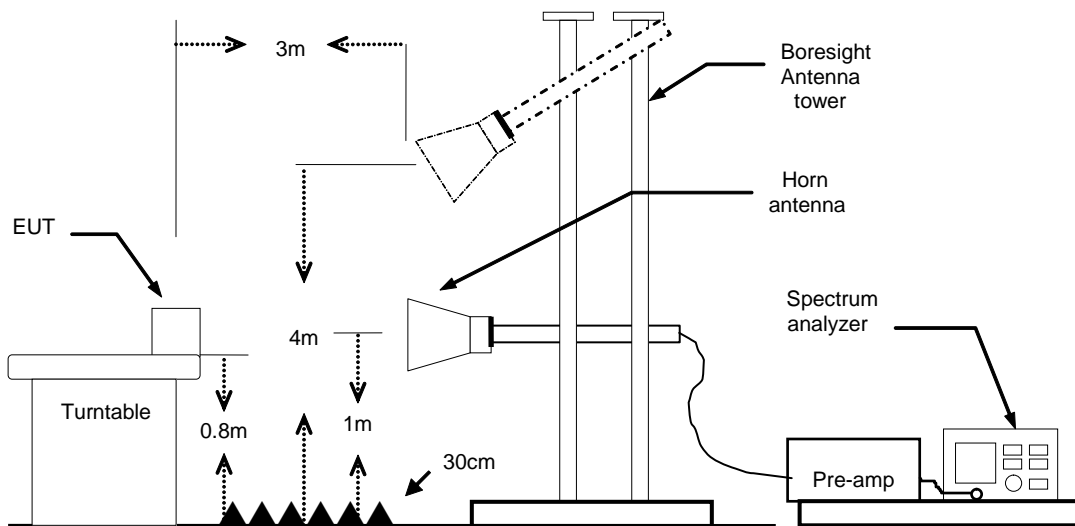

- For the actual test configuration, please refer to the related item – Photographs of the Test Configuration.

Report No.: T190322E03-F

7.5. DATA SAMPLE:

Below 1GHz

Frequency (MHz)	Reading (dBuV)	Correction Factor (dB/m)	Result (dBuV/m)	Limit (dBuV/m)	Margin (dB)	Height (cm)	Degree (°)	Remark
xx.xx	16.49	9.86	26.35	30.00	-3.65	116.00	101.00	QP

Above 1GHz

Frequency (MHz)	Reading (dBuV)	Correction Factor (dB/m)	Result (dBuV/m)	Limit (dBuV/m)	Margin (dB)	Height (cm)	Degree (°)	Remark
xx.xx	60.80	-14.59	46.21	74.00	-27.79	200	351	peak
xx.xx	52.05	-13.17	38.88	54.00	-15.12	200	135	AVG

Frequency (MHz) = Emission frequency in MHz
 Reading (dBuV) = Uncorrected Analyzer / Receiver reading
 Correction Factor (dB/m) = Antenna factor + Cable loss – Amplifier gain
 Result (dBuV/m) = Reading (dBuV) + Corr. Factor (dB/m)
 Limit (dBuV/m) = Limit stated in standard
 Margin (dB) = Result (dBuV/m) – Limit (dBuV/m)
 Q.P. = Quasi-Peak

Report No.: T190322E03-F

7.6. TEST RESULTS

Below 1GHz

Test Mode	Mode 1	6dB Bandwidth	120 kHz
Environmental Conditions	26°C, 60% RH	Test Date	2019/03/23
Antenna Pole	Vertical	Antenna Distance	10m
Detector Function	Quasi-peak.	Tested by	Wiz Chang

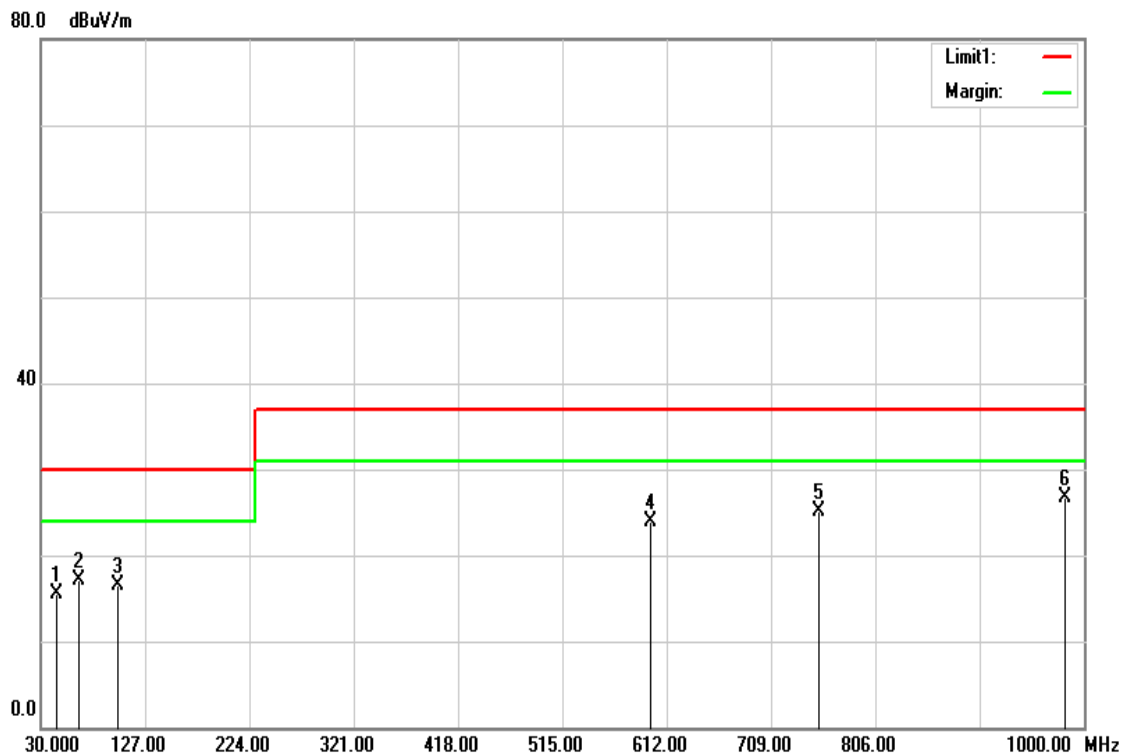

No.	Frequency (MHz)	Reading (dBuV)	Correction Factor(dB/m)	Result (dBuV/m)	Limit (dBuV/m)	Margin (dB)	Height (cm)	Degree (°)	Remark
1	44.5500	25.75	-10.27	15.48	30.00	-14.52	100	217	QP
2	65.8900	31.51	-14.40	17.11	30.00	-12.89	200	359	QP
3	101.7800	25.72	-9.28	16.44	30.00	-13.56	100	360	QP
4	597.4500	22.84	1.13	23.97	37.00	-13.03	299	310	QP
5	753.6200	21.82	3.22	25.04	37.00	-11.96	100	7	QP
6	982.5400	20.27	6.52	26.79	37.00	-10.21	299	3	QP

REMARKS:

1. The other emission levels were very low against the limit.
2. 30MHz to 1000MHz test is Applicable CISPR 22 standard.

Report No.: T190322E03-F

Test Mode	Mode 1	6dB Bandwidth	120 kHz
Environmental Conditions	26°C, 60% RH	Test Date	2019/03/23
Antenna Pole	Horizontal	Antenna Distance	10m
Detector Function	Quasi-peak.	Tested by	Wiz Chang

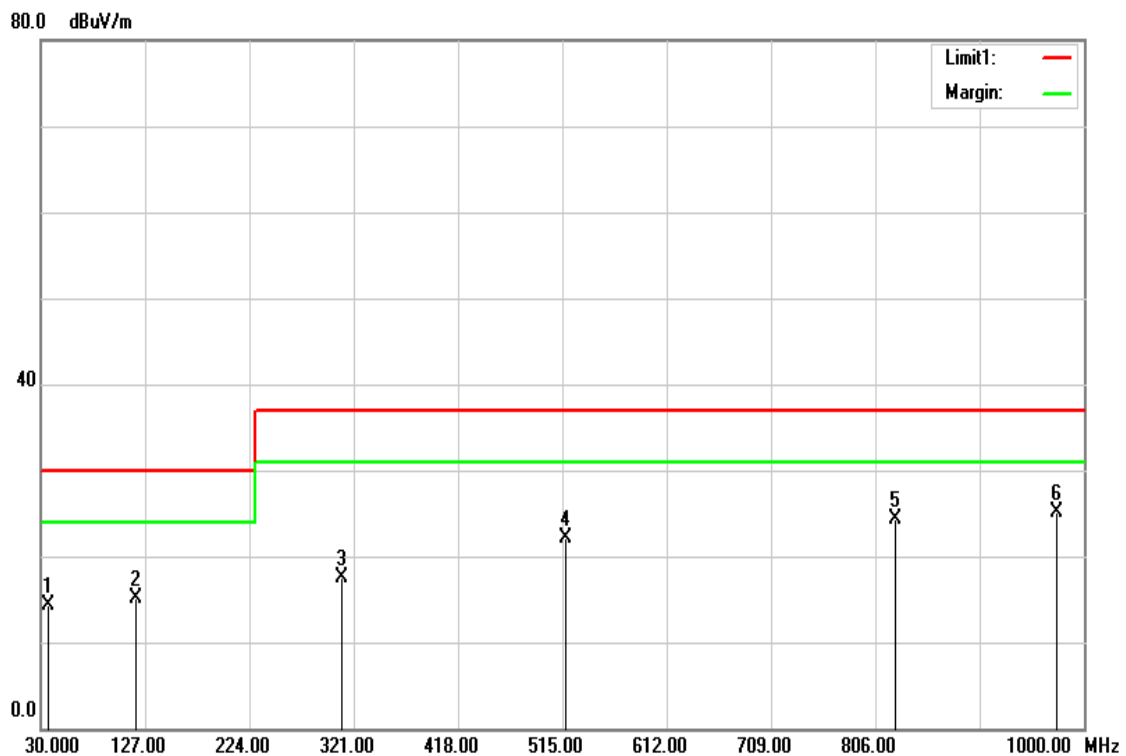

No.	Frequency (MHz)	Reading (dBuV)	Correction Factor(dB/m)	Result (dBuV/m)	Limit (dBuV/m)	Margin (dB)	Height (cm)	Degree (°)	Remark
1	36.7900	21.02	-6.75	14.27	30.00	-15.73	300	63	QP
2	118.2700	23.97	-8.77	15.20	30.00	-14.80	200	72	QP
3	310.3300	23.36	-5.78	17.58	37.00	-19.42	100	172	QP
4	517.9100	23.55	-1.51	22.04	37.00	-14.96	399	317	QP
5	824.4300	22.36	1.95	24.31	37.00	-12.69	234	0	QP
6	974.7800	21.35	3.81	25.16	37.00	-11.84	291	0	QP

REMARKS:

1. The other emission levels were very low against the limit.
2. 30MHz to 1000MHz test is Applicable CISPR 22 standard.

Report No.: T190322E03-F

Test Mode	Mode 2	6dB Bandwidth	120 kHz
Environmental Conditions	26°C, 60% RH	Test Date	2019/03/23
Antenna Pole	Vertical	Antenna Distance	10m
Detector Function	Quasi-peak.	Tested by	Wiz Chang

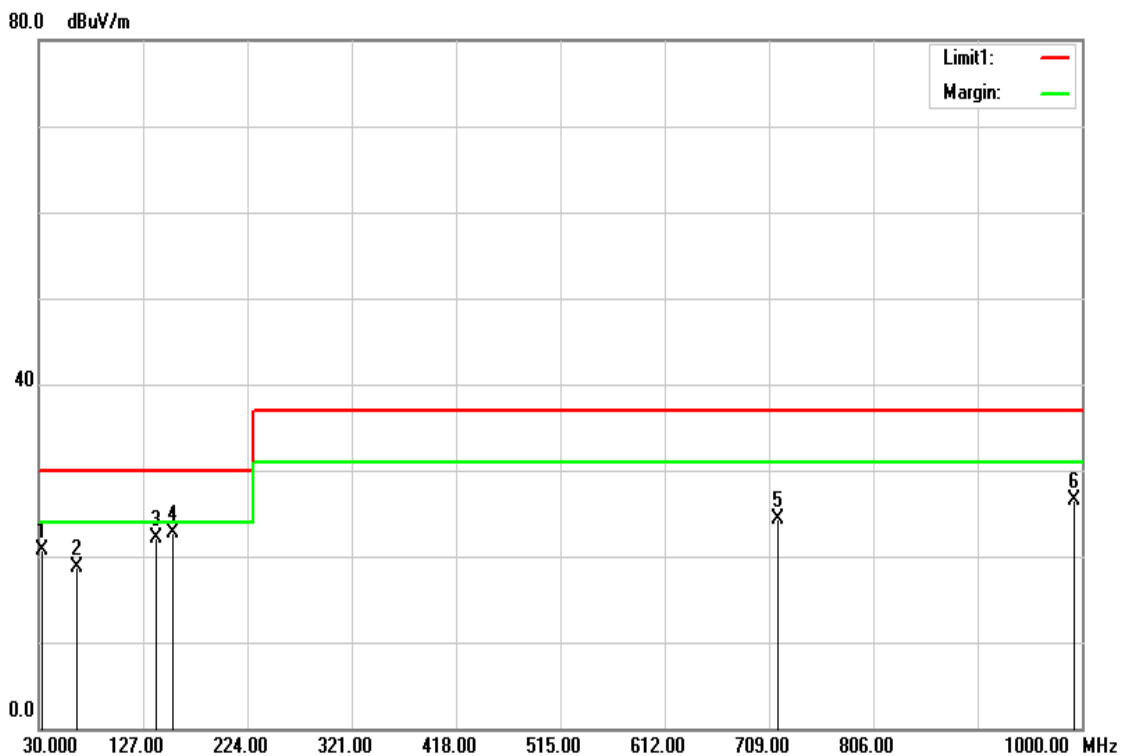

No.	Frequency (MHz)	Reading (dBuV)	Correction Factor(dB/m)	Result (dBuV/m)	Limit (dBuV/m)	Margin (dB)	Height (cm)	Degree (°)	Remark
1	32.9100	24.49	-3.82	20.67	30.00	-9.33	100	3	QP
2	65.8900	33.12	-14.40	18.72	30.00	-11.28	200	22	QP
3	139.6100	30.42	-8.26	22.16	30.00	-7.84	200	323	QP
4	154.1600	31.57	-8.79	22.78	30.00	-7.22	200	258	QP
5	716.7600	21.81	2.46	24.27	37.00	-12.73	200	14	QP
6	992.2400	19.71	6.71	26.42	37.00	-10.58	399	0	QP

REMARKS:

1. The other emission levels were very low against the limit.
2. 30MHz to 1000MHz test is Applicable CISPR 22 standard.

Test Mode	Mode 2	6dB Bandwidth	120 kHz
Environmental Conditions	26°C, 60% RH	Test Date	2019/03/23
Antenna Pole	Horizontal	Antenna Distance	10m
Detector Function	Quasi-peak.	Tested by	Wiz Chang

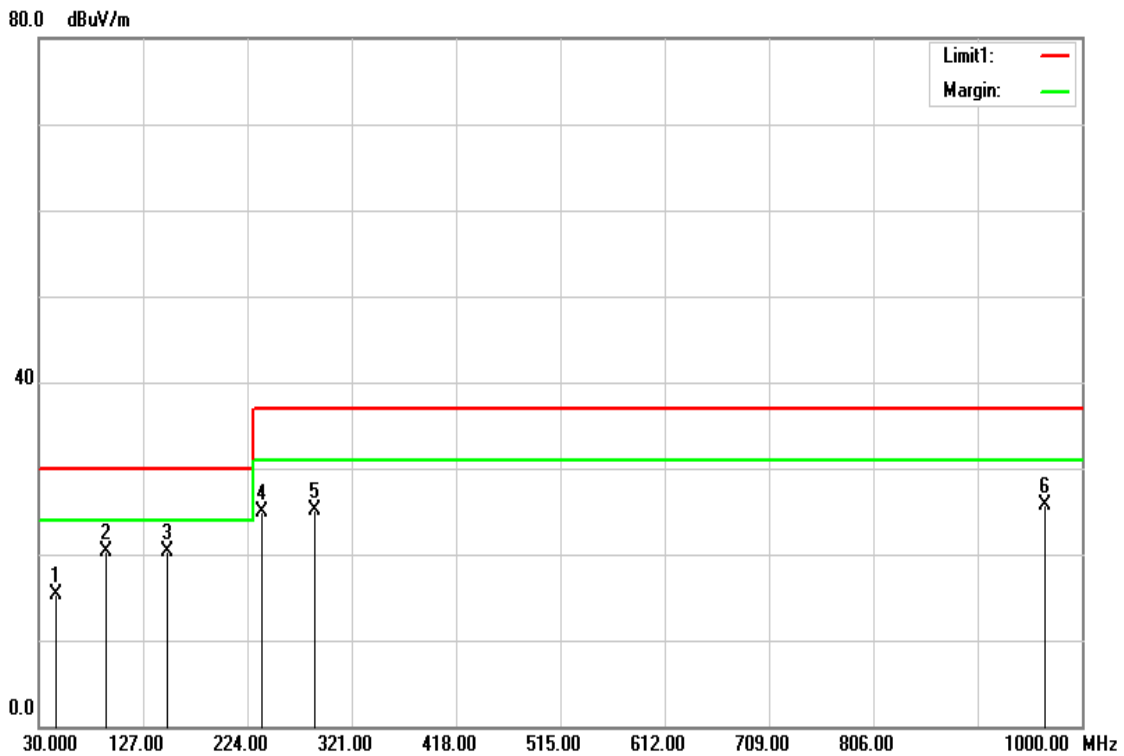

No.	Frequency (MHz)	Reading (dBuV)	Correction Factor(dB/m)	Result (dBuV/m)	Limit (dBuV/m)	Margin (dB)	Height (cm)	Degree (°)	Remark
1	45.5200	26.75	-11.48	15.27	30.00	-14.73	399	187	QP
2	92.0800	32.12	-11.76	20.36	30.00	-9.64	300	100	QP
3	149.3100	30.03	-9.67	20.36	30.00	-9.64	399	230	QP
4	237.5800	33.29	-8.45	24.84	37.00	-12.16	399	36	QP
5	286.0800	31.39	-6.26	25.13	37.00	-11.87	300	0	QP
6	966.0500	21.99	3.67	25.66	37.00	-11.34	399	0	QP

REMARKS:

1. The other emission levels were very low against the limit.
2. 30MHz to 1000MHz test is Applicable CISPR 22 standard.

Report No.: T190322E03-F

Test Mode	Mode 3	6dB Bandwidth	120 kHz
Environmental Conditions	26°C, 60% RH	Test Date	2019/03/23
Antenna Pole	Vertical	Antenna Distance	10m
Detector Function	Quasi-peak.	Tested by	Wiz Chang

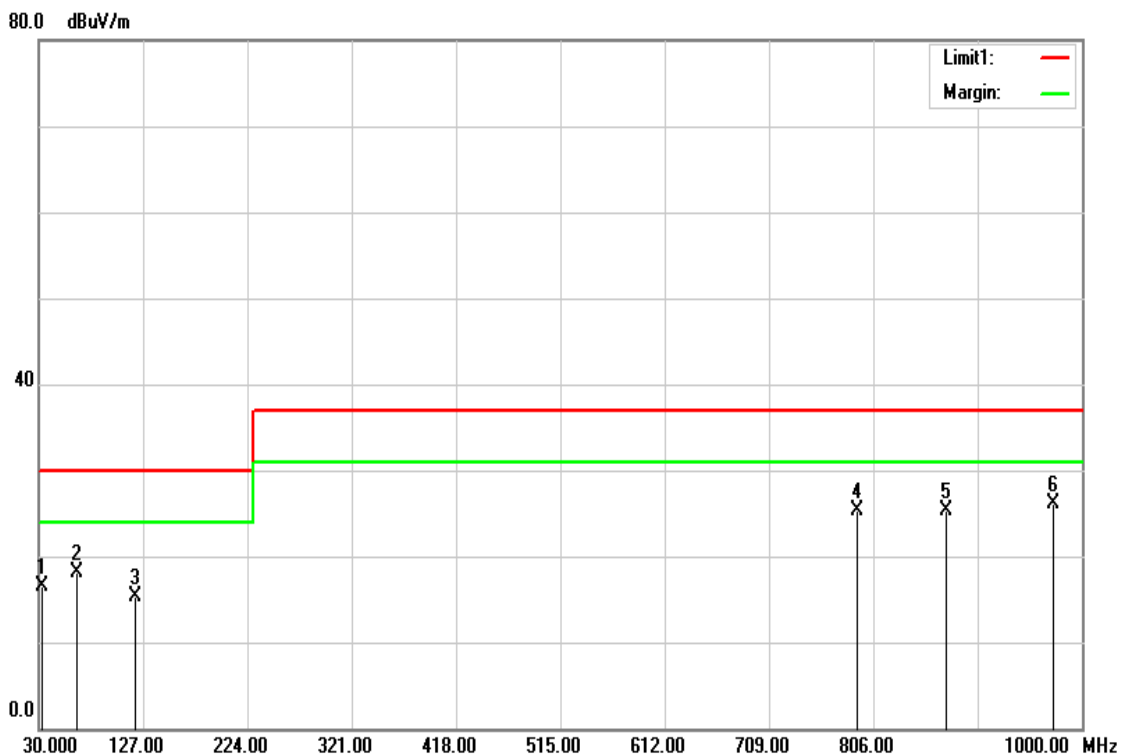

No.	Frequency (MHz)	Reading (dBuV)	Correction Factor(dB/m)	Result (dBuV/m)	Limit (dBuV/m)	Margin (dB)	Height (cm)	Degree (°)	Remark
1	32.9100	20.28	-3.82	16.46	30.00	-13.54	100	359	QP
2	65.8900	32.41	-14.40	18.01	30.00	-11.99	200	0	QP
3	120.2100	23.04	-7.77	15.27	30.00	-14.73	100	208	QP
4	791.4500	21.56	3.71	25.27	37.00	-11.73	162	360	QP
5	873.9000	20.39	4.92	25.31	37.00	-11.69	299	1	QP
6	973.8100	19.83	6.36	26.19	37.00	-10.81	399	315	QP

REMARKS:

1. The other emission levels were very low against the limit.
2. 30MHz to 1000MHz test is Applicable CISPR 22 standard.

Report No.: T190322E03-F

Test Mode	Mode 3	6dB Bandwidth	120 kHz
Environmental Conditions	26°C, 60% RH	Test Date	2019/03/23
Antenna Pole	Horizontal	Antenna Distance	10m
Detector Function	Quasi-peak.	Tested by	Wiz Chang

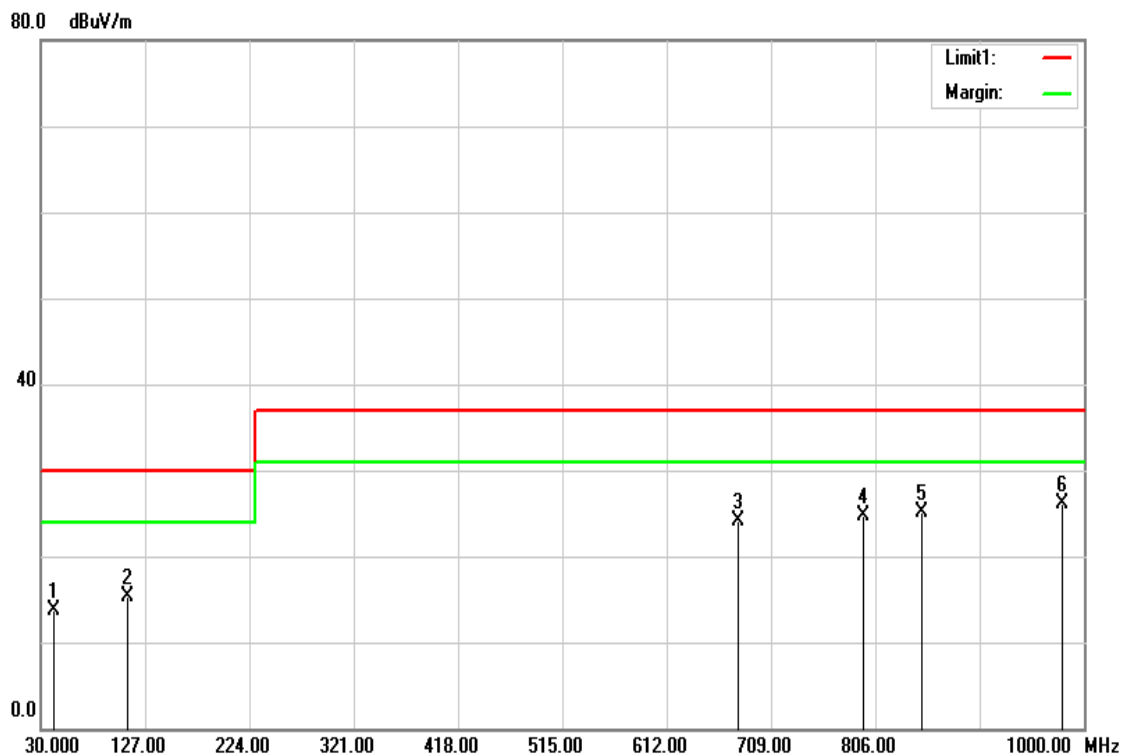

No.	Frequency (MHz)	Reading (dBuV)	Correction Factor(dB/m)	Result (dBuV/m)	Limit (dBuV/m)	Margin (dB)	Height (cm)	Degree (°)	Remark
1	41.6400	23.27	-9.51	13.76	30.00	-16.24	250	360	QP
2	110.5100	24.65	-9.38	15.27	30.00	-14.73	250	356	QP
3	678.9300	24.06	-0.01	24.05	37.00	-12.95	250	267	QP
4	794.3600	23.06	1.62	24.68	37.00	-12.32	250	150	QP
5	848.6800	22.85	2.19	25.04	37.00	-11.96	250	65	QP
6	979.6300	22.21	3.91	26.12	37.00	-10.88	250	0	QP

REMARKS:

1. The other emission levels were very low against the limit.
2. 30MHz to 1000MHz test is Applicable CISPR 22 standard.

Report No.: T190322E03-F

Test Mode	Mode 4	6dB Bandwidth	120 kHz
Environmental Conditions	26°C, 60% RH	Test Date	2019/03/23
Antenna Pole	Vertical	Antenna Distance	10m
Detector Function	Quasi-peak.	Tested by	Wiz Chang

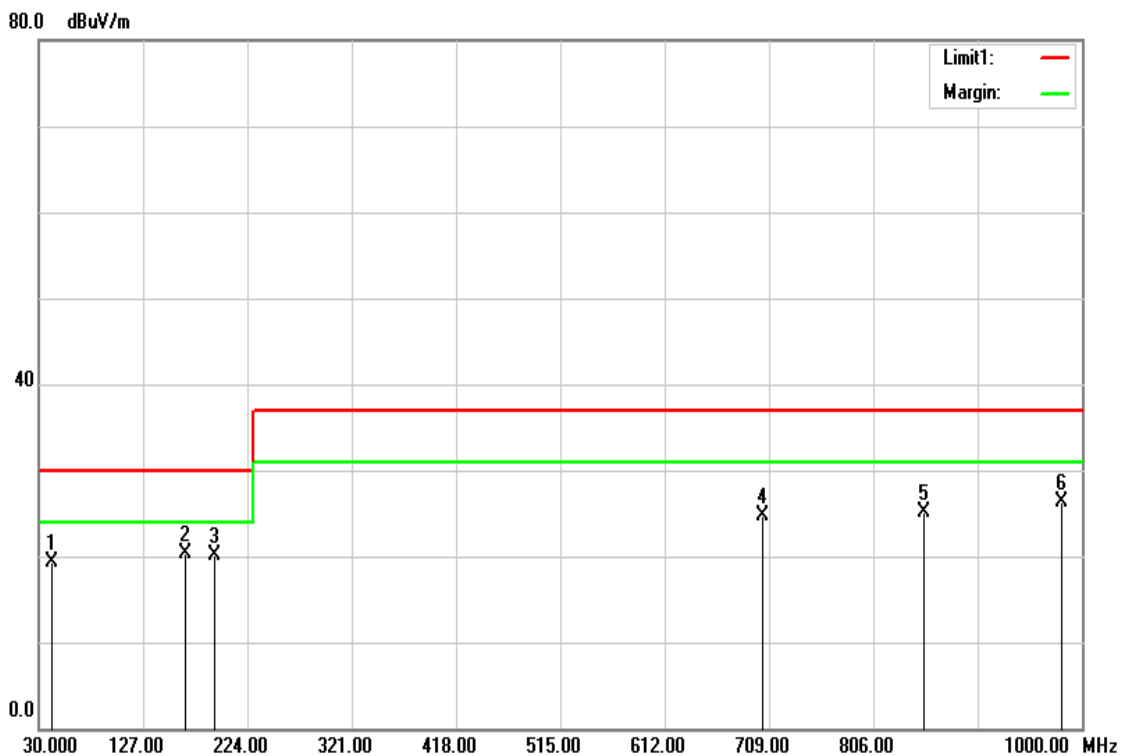

No.	Frequency (MHz)	Reading (dBuV)	Correction Factor(dB/m)	Result (dBuV/m)	Limit (dBuV/m)	Margin (dB)	Height (cm)	Degree (°)	Remark
1	42.6100	28.55	-9.24	19.31	30.00	-10.69	300	238	QP
2	166.7700	29.51	-9.25	20.26	30.00	-9.74	100	101	QP
3	192.9600	29.57	-9.50	20.07	30.00	-9.93	100	1	QP
4	703.1800	22.49	2.15	24.64	37.00	-12.36	278	0	QP
5	852.5600	20.58	4.60	25.18	37.00	-11.82	400	90	QP
6	981.5700	19.83	6.51	26.34	37.00	-10.66	200	356	QP

REMARKS:

1. The other emission levels were very low against the limit.
2. 30MHz to 1000MHz test is Applicable CISPR 22 standard.

Test Mode	Mode 4	6dB Bandwidth	120 kHz
Environmental Conditions	26°C, 60% RH	Test Date	2019/03/23
Antenna Pole	Horizontal	Antenna Distance	10m
Detector Function	Quasi-peak.	Tested by	Wiz Chang

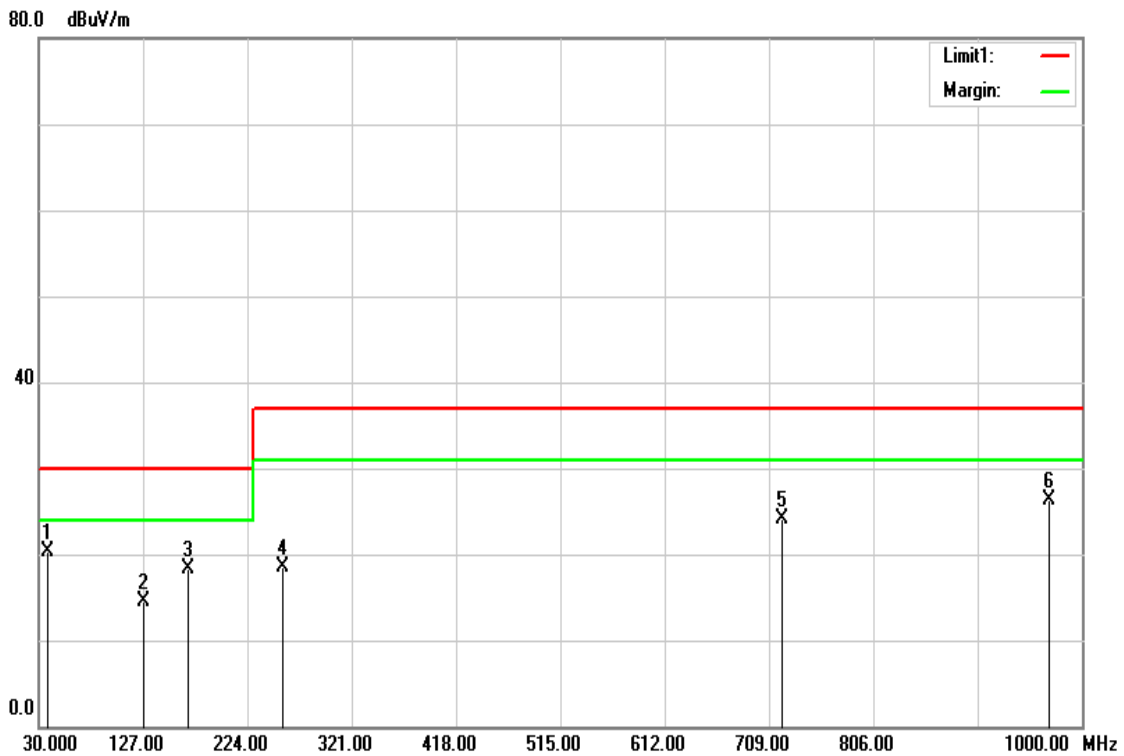

No.	Frequency (MHz)	Reading (dBuV)	Correction Factor(dB/m)	Result (dBuV/m)	Limit (dBuV/m)	Margin (dB)	Height (cm)	Degree (°)	Remark
1	38.7300	28.18	-7.91	20.27	30.00	-9.73	337	360	QP
2	127.9700	23.28	-8.87	14.41	30.00	-15.59	399	360	QP
3	168.7100	28.88	-10.54	18.34	30.00	-11.66	399	360	QP
4	256.9800	24.42	-6.00	18.42	37.00	-18.58	188	360	QP
5	720.6400	23.68	0.47	24.15	37.00	-12.85	399	0	QP
6	968.9600	22.62	3.72	26.34	37.00	-10.66	399	218	QP

REMARKS:

1. The other emission levels were very low against the limit.
2. 30MHz to 1000MHz test is Applicable CISPR 22 standard.

Report No.: T190322E03-F

Test Mode	Mode 5	6dB Bandwidth	120 kHz
Environmental Conditions	26°C, 60% RH	Test Date	2019/04/01
Antenna Pole	Vertical	Antenna Distance	10m
Detector Function	Quasi-peak.	Tested by	Wiz Chang

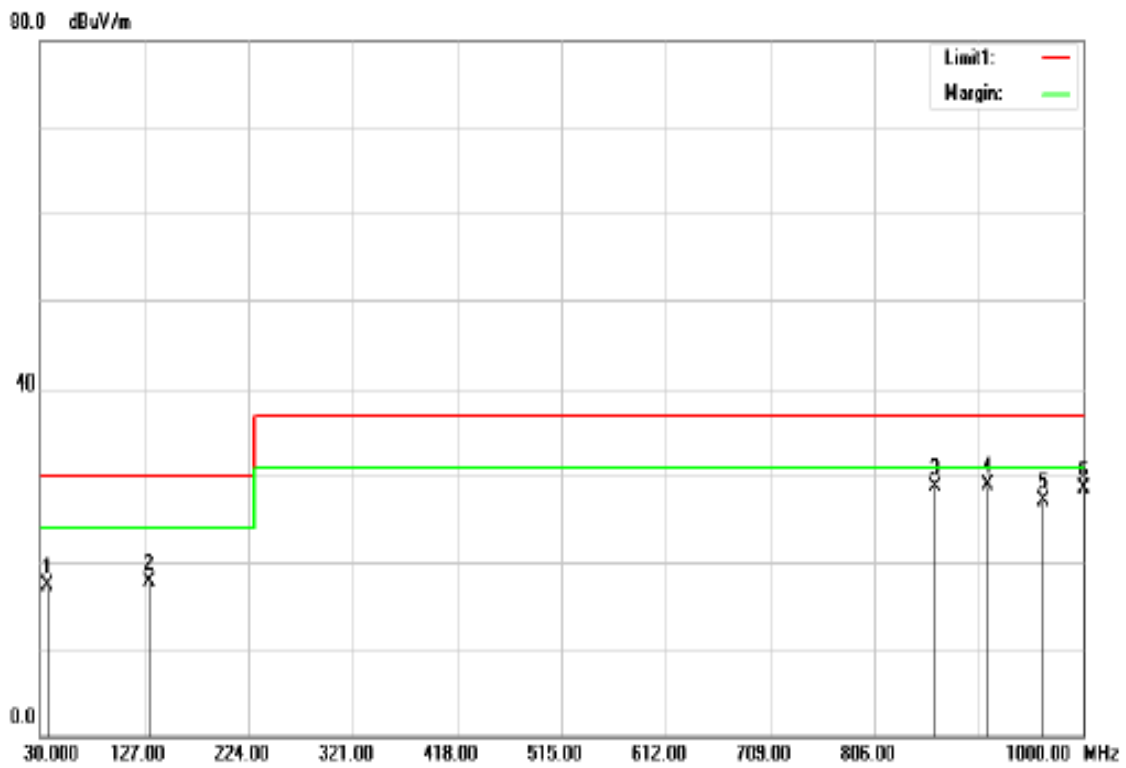

No.	Frequency (MHz)	Reading (dBuV)	Correction Factor (dB/m)	Result (dBuV/m)	Limit (dBuV/m)	Margin (dB)	Height (cm)	Degree (°)	Remark
1	36.7900	23.14	-5.86	17.28	30.00	-12.72	300	52	QP
2	130.8800	25.59	-7.95	17.64	30.00	-12.36	300	229	QP
3	862.2600	23.94	4.67	28.61	37.00	-8.39	200	260	QP
4	911.7300	23.72	5.26	28.98	37.00	-8.02	100	121	QP
5	963.1400	21.19	5.93	27.12	37.00	-9.88	400	282	QP
6	1000.0000	21.89	6.66	28.55	37.00	-8.45	200	159	QP

REMARKS:

1. The other emission levels were very low against the limit.
2. Margin (dB) = Result (dBuV/m) – Limit (dBuV/m)

Report No.: T190322E03-F

Test Mode	Mode 5	6dB Bandwidth	120 kHz
Environmental Conditions	26°C, 60% RH	Test Date	2019/04/01
Antenna Pole	Horizontal	Antenna Distance	10m
Detector Function	Quasi-peak.	Tested by	Wiz Chang

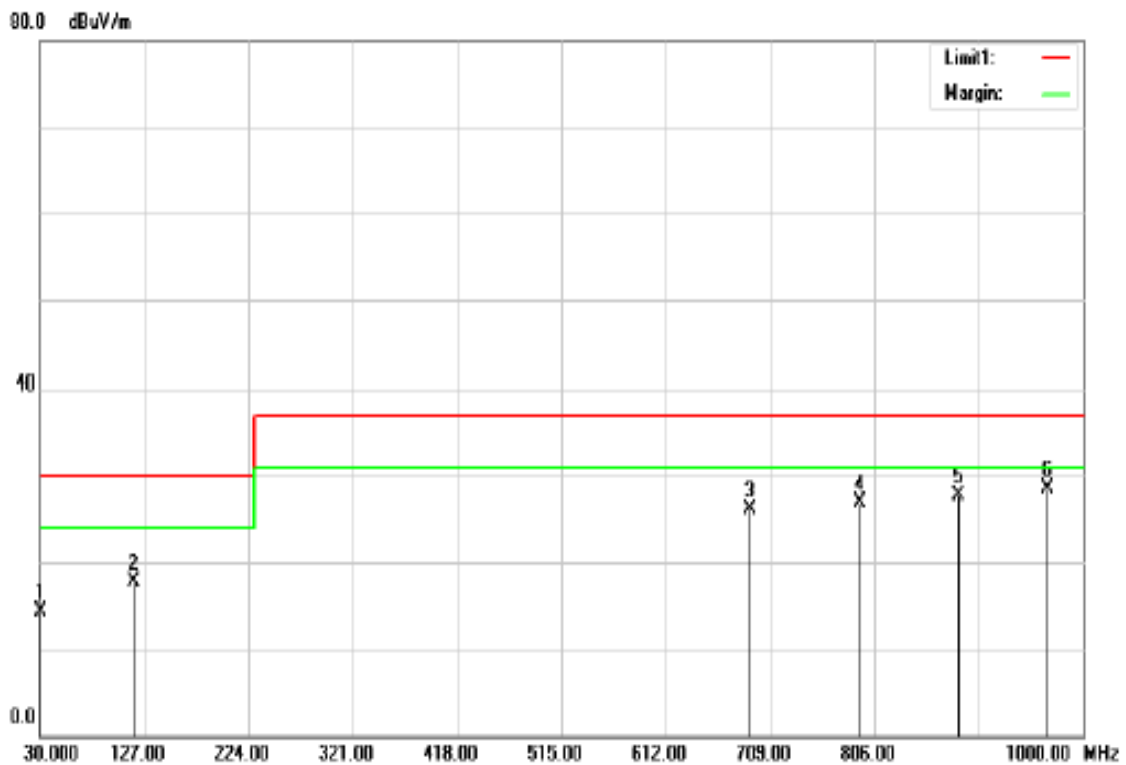

No.	Frequency (MHz)	Reading (dBuV)	Correction Factor (dB/m)	Result (dBuV/m)	Limit (dBuV/m)	Margin (dB)	Height (cm)	Degree (°)	Remark
1	30.9700	17.96	-3.57	14.39	30.00	-15.61	399	360	QP
2	117.3000	26.51	-8.80	17.71	30.00	-12.29	400	250	QP
3	690.5700	25.92	0.13	26.05	37.00	-10.95	300	359	QP
4	792.4200	25.30	1.59	26.89	37.00	-10.11	100	223	QP
5	883.6000	24.96	2.72	27.68	37.00	-9.32	202	0	QP
6	967.0200	24.71	3.75	28.46	37.00	-8.54	200	3	QP

REMARKS:

1. The other emission levels were very low against the limit.
2. Margin (dB) = Result (dBuV/m) – Limit (dBuV/m)

Report No.: T190322E03-F

Above 1GHz

Test Mode	Mode 1	6dB Bandwidth	1 MHz
Environmental Conditions	26°C, 60% RH	Test Date	2019/03/25
Antenna Pole	Vertical	Antenna Distance	3m
Highest frequency generated or used	2.48GHz	Upper frequency	12.4GHz
Detector Function	Peak	Tested by	Wiz Chang

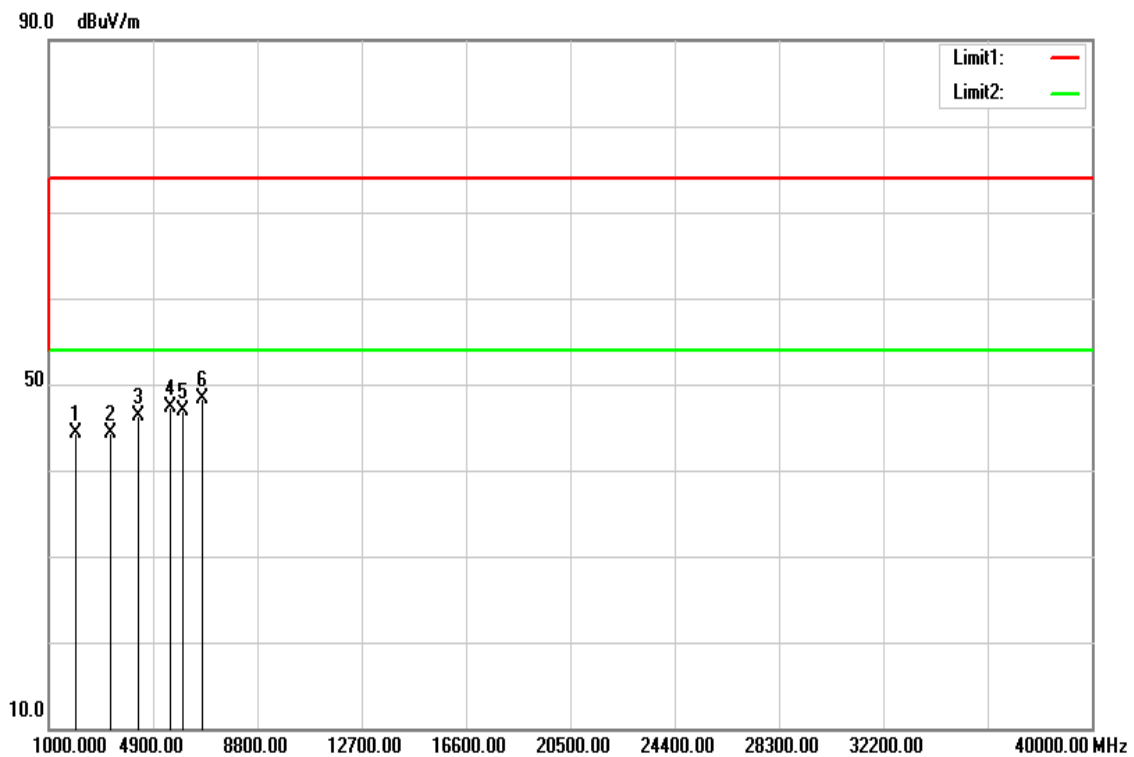

No.	Frequency (MHz)	Reading (dBuV)	Correction Factor (dB/m)	Result (dBuV/m)	Limit (dBuV/m)	Margin (dB)	Height (cm)	Degree (°)	Remark
1	1998.000	58.78	-14.42	44.36	74.00	-29.64	100	57	peak
2	3320.500	56.54	-12.29	44.25	74.00	-29.75	100	304	peak
3	4354.000	55.91	-9.68	46.23	74.00	-27.77	100	155	peak
4	5524.000	54.26	-7.03	47.23	74.00	-26.77	100	81	peak
5	6031.000	52.47	-5.49	46.98	74.00	-27.02	100	62	peak
6	6752.500	52.08	-3.76	48.32	74.00	-25.68	100	104	peak

REMARKS:

1. The other emission levels were very low against the limit.
2. Margin (dB) = Result (dBuV/m) – Limit (dBuV/m)

Report No.: T190322E03-F

Test Mode	Mode 1	6dB Bandwidth	1 MHz
Environmental Conditions	26°C, 60% RH	Test Date	2019/03/25
Antenna Pole	Horizontal	Antenna Distance	3m
Highest frequency generated or used	2.48GHz	Upper frequency	12.4GHz
Detector Function	Peak	Tested by	Wiz Chang

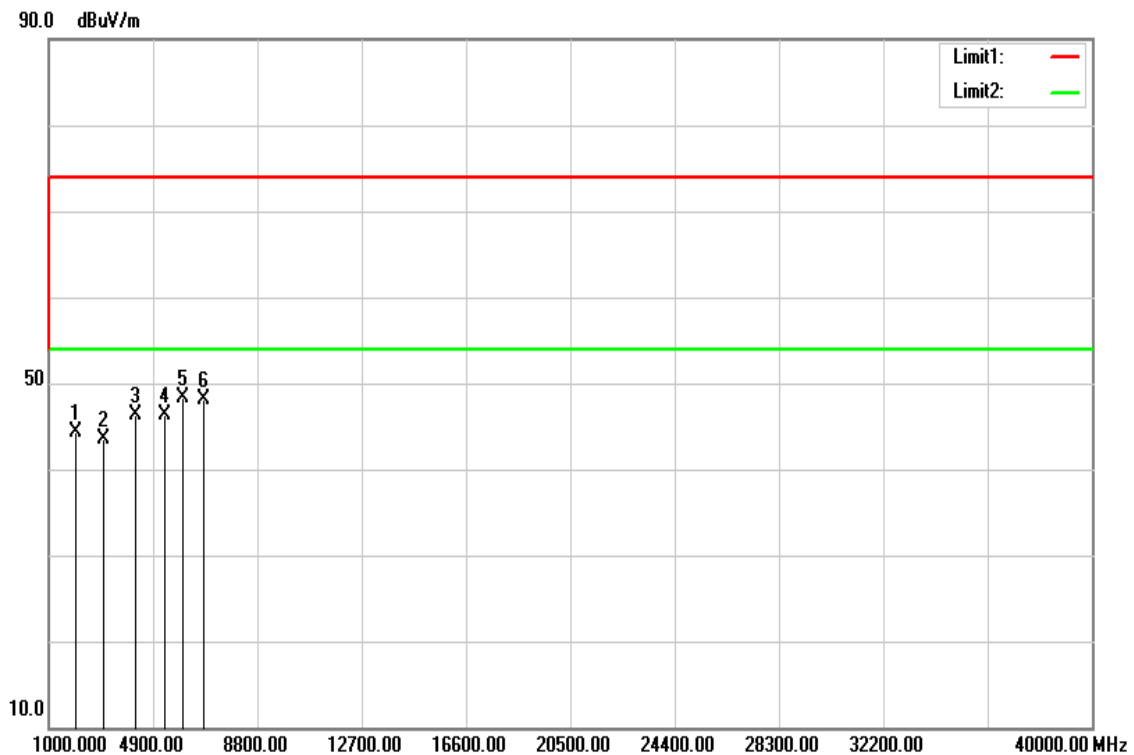

No.	Frequency (MHz)	Reading (dBuV)	Correction Factor (dB/m)	Result (dBuV/m)	Limit (dBuV/m)	Margin (dB)	Height (cm)	Degree (°)	Remark
1	1998.000	58.95	-14.63	44.32	74.00	-29.68	100	56	peak
2	3067.000	56.28	-12.72	43.56	74.00	-30.44	100	241	peak
3	4256.500	56.66	-10.45	46.21	74.00	-27.79	100	351	peak
4	5348.500	54.32	-8.05	46.27	74.00	-27.73	100	280	peak
5	6011.500	54.19	-5.87	48.32	74.00	-25.68	100	284	peak
6	6791.500	52.52	-4.50	48.02	74.00	-25.98	100	4	peak

REMARKS:

1. The other emission levels were very low against the limit.
2. Margin (dB) = Result (dBuV/m) – Limit (dBuV/m)

Report No.: T190322E03-F

Test Mode	Mode 2	6dB Bandwidth	1 MHz
Environmental Conditions	26°C, 60% RH	Test Date	2019/03/25
Antenna Pole	Vertical	Antenna Distance	3m
Highest frequency generated or used	2.48GHz	Upper frequency	12.4GHz
Detector Function	Peak	Tested by	Wiz Chang

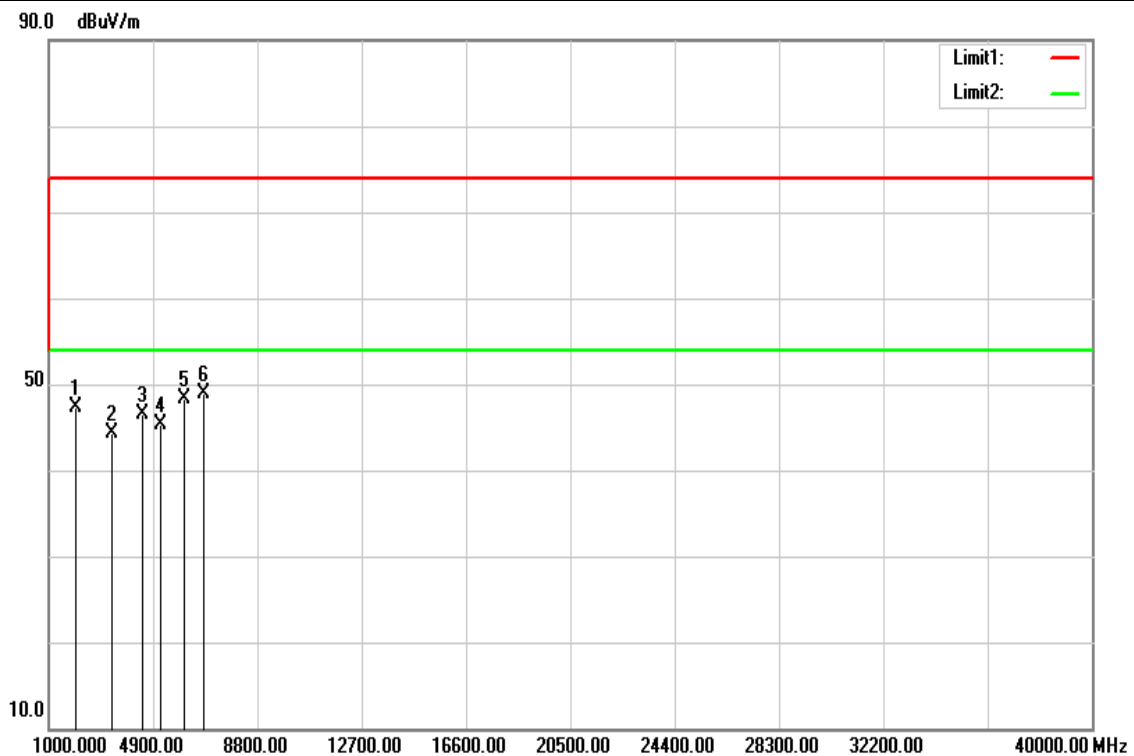

No.	Frequency (MHz)	Reading (dBuV)	Correction Factor (dB/m)	Result (dBuV/m)	Limit (dBuV/m)	Margin (dB)	Height (cm)	Degree (°)	Remark
1	1998.000	61.78	-14.42	47.36	74.00	-26.64	100	71	peak
2	3398.500	56.46	-12.25	44.21	74.00	-29.79	100	250	peak
3	4510.000	55.60	-9.09	46.51	74.00	-27.49	100	42	peak
4	5192.500	53.22	-7.86	45.36	74.00	-28.64	100	216	peak
5	6070.000	53.72	-5.36	48.36	74.00	-25.64	100	180	peak
6	6811.000	52.68	-3.72	48.96	74.00	-25.04	100	56	peak

REMARKS:

1. The other emission levels were very low against the limit.
2. Margin (dB) = Result (dBuV/m) – Limit (dBuV/m)

Report No.: T190322E03-F

Test Mode	Mode 2	6dB Bandwidth	1 MHz
Environmental Conditions	26°C, 60% RH	Test Date	2019/03/25
Antenna Pole	Horizontal	Antenna Distance	3m
Highest frequency generated or used	2.48GHz	Upper frequency	12.4GHz
Detector Function	Peak	Tested by	Wiz Chang

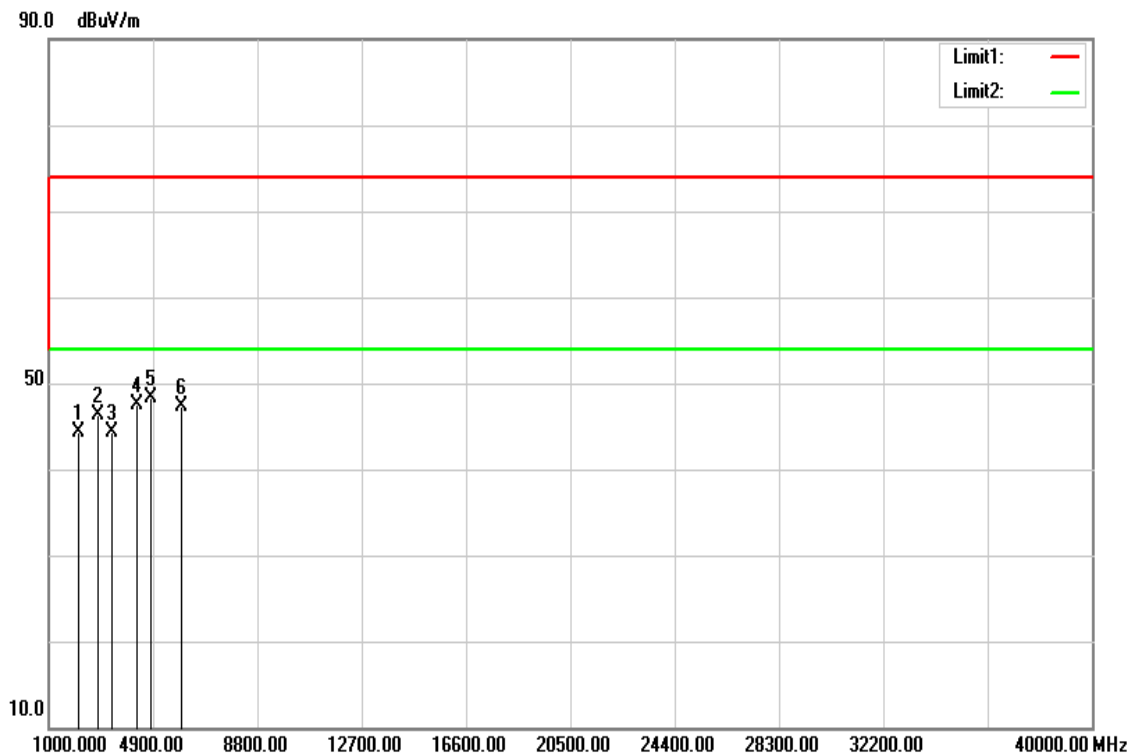

No.	Frequency (MHz)	Reading (dBuV)	Correction Factor (dB/m)	Result (dBuV/m)	Limit (dBuV/m)	Margin (dB)	Height (cm)	Degree (°)	Remark
1	2092.000	58.77	-14.52	44.25	74.00	-29.75	100	106	peak
2	2852.500	59.40	-13.15	46.25	74.00	-27.75	100	344	peak
3	3398.500	56.84	-12.63	44.21	74.00	-29.79	100	321	peak
4	4276.000	57.91	-10.39	47.52	74.00	-26.48	100	256	peak
5	4841.500	57.37	-9.05	48.32	74.00	-25.68	100	324	peak
6	5953.000	53.31	-6.06	47.25	74.00	-26.75	100	117	peak

REMARKS:

1. The other emission levels were very low against the limit.
2. Margin (dB) = Result (dBuV/m) – Limit (dBuV/m)

Report No.: T190322E03-F

Test Mode	Mode 3	6dB Bandwidth	1 MHz
Environmental Conditions	26°C, 60% RH	Test Date	2019/03/25
Antenna Pole	Vertical	Antenna Distance	3m
Highest frequency generated or used	2.48GHz	Upper frequency	12.4GHz
Detector Function	Peak	Tested by	Wiz Chang

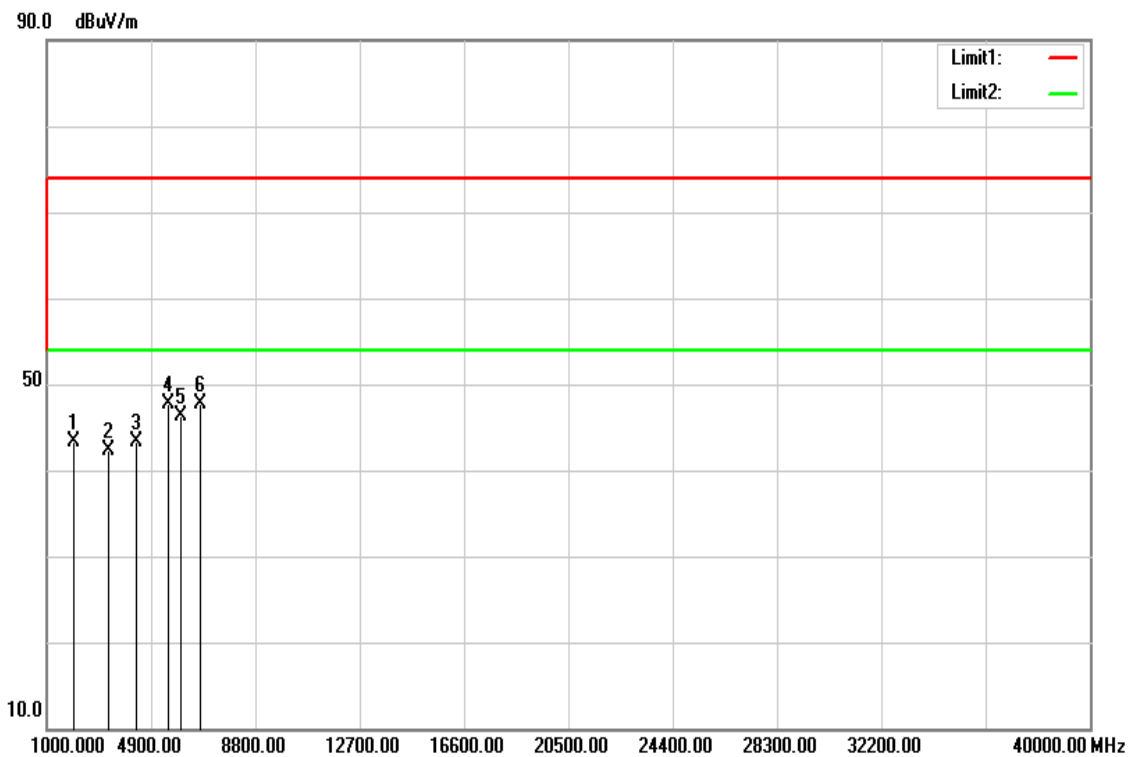

No.	Frequency (MHz)	Reading (dBuV)	Correction Factor (dB/m)	Result (dBuV/m)	Limit (dBuV/m)	Margin (dB)	Height (cm)	Degree (°)	Remark
1	1998.000	57.78	-14.42	43.36	74.00	-30.64	100	113	peak
2	3320.500	54.54	-12.29	42.25	74.00	-31.75	100	260	peak
3	4354.000	52.91	-9.68	43.23	74.00	-30.77	100	61	peak
4	5524.000	54.66	-7.03	47.63	74.00	-26.37	100	345	peak
5	6031.000	51.85	-5.49	46.36	74.00	-27.64	100	289	peak
6	6752.500	51.39	-3.76	47.63	74.00	-26.37	100	90	peak

REMARKS:

1. The other emission levels were very low against the limit.
2. Margin (dB) = Result (dBuV/m) – Limit (dBuV/m)

Report No.: T190322E03-F

Test Mode	Mode 3	6dB Bandwidth	1 MHz
Environmental Conditions	26°C, 60% RH	Test Date	2019/03/25
Antenna Pole	Horizontal	Antenna Distance	3m
Highest frequency generated or used	2.48GHz	Upper frequency	12.4GHz
Detector Function	Peak	Tested by	Wiz Chang

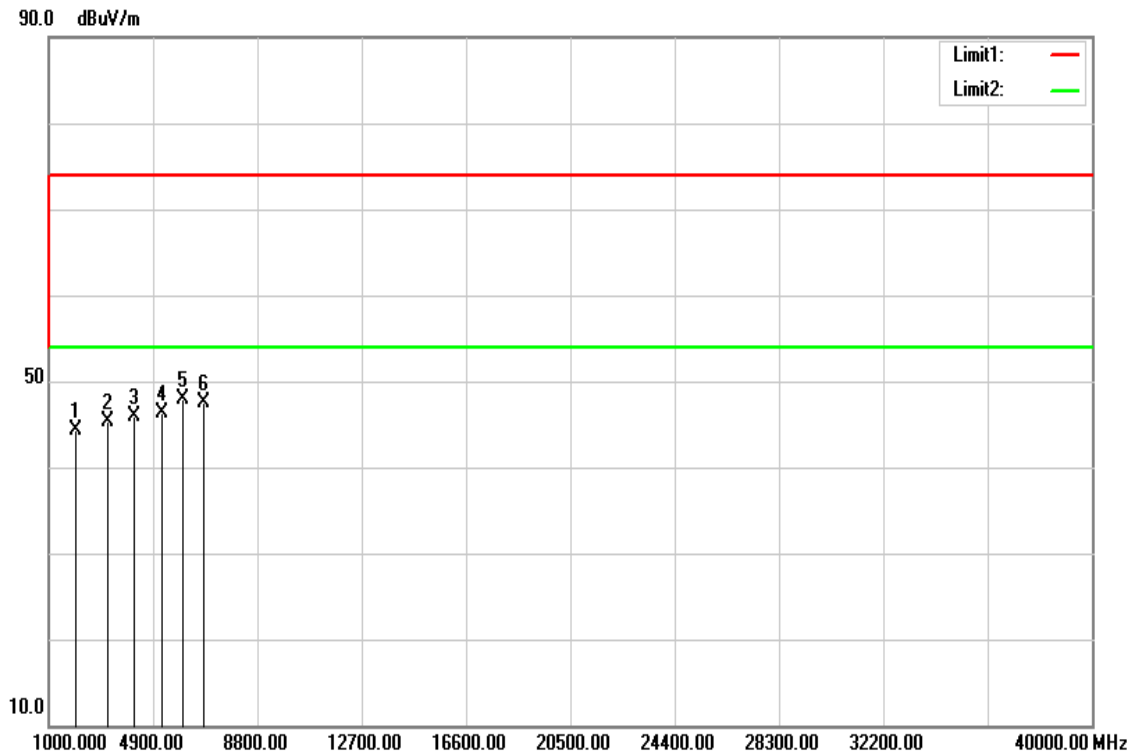

No.	Frequency (MHz)	Reading (dBuV)	Correction Factor (dB/m)	Result (dBuV/m)	Limit (dBuV/m)	Margin (dB)	Height (cm)	Degree (°)	Remark
1	1998.000	58.99	-14.63	44.36	74.00	-29.64	100	144	peak
2	3223.000	58.03	-12.67	45.36	74.00	-28.64	100	88	peak
3	4198.000	56.57	-10.68	45.89	74.00	-28.11	100	85	peak
4	5251.000	54.58	-8.26	46.32	74.00	-27.68	100	160	peak
5	6050.500	53.61	-5.79	47.82	74.00	-26.18	100	86	peak
6	6791.500	52.06	-4.50	47.56	74.00	-26.44	100	166	peak

REMARKS:

1. The other emission levels were very low against the limit.
2. Margin (dB) = Result (dBuV/m) – Limit (dBuV/m)

Report No.: T190322E03-F

Test Mode	Mode 4	6dB Bandwidth	1 MHz
Environmental Conditions	26°C, 60% RH	Test Date	2019/03/25
Antenna Pole	Vertical	Antenna Distance	3m
Highest frequency generated or used	2.48GHz	Upper frequency	12.4GHz
Detector Function	Peak	Tested by	Wiz Chang

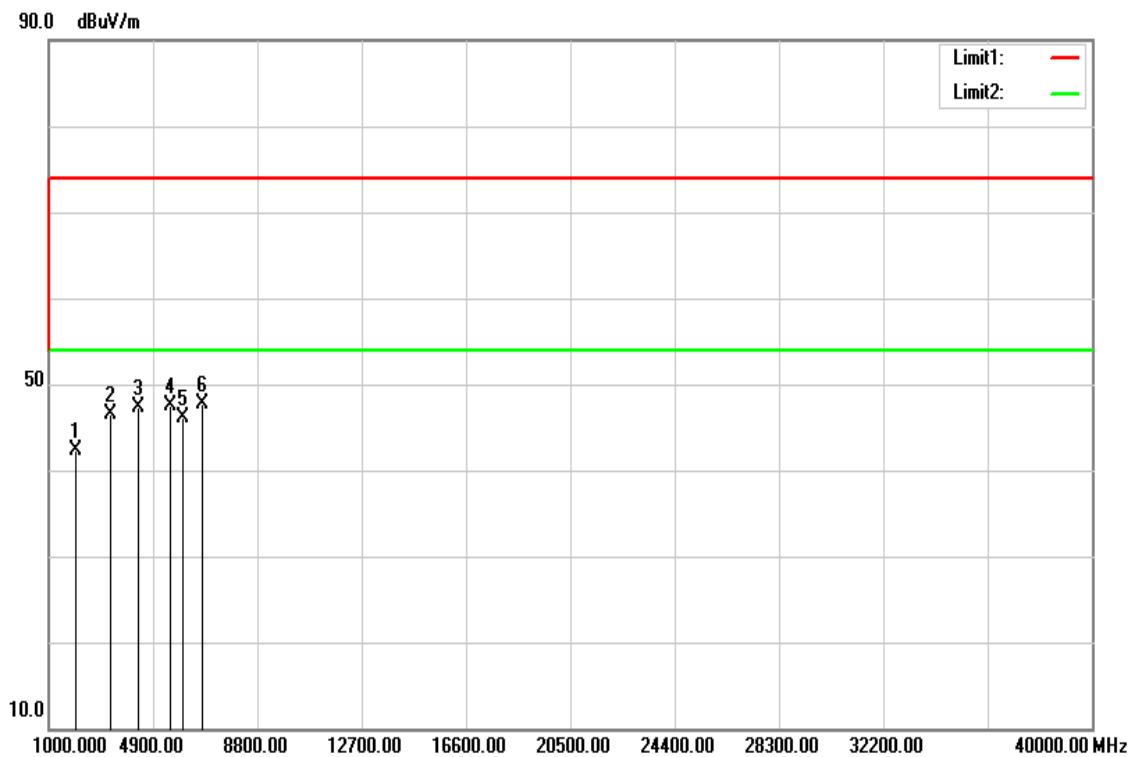

No.	Frequency (MHz)	Reading (dBuV)	Correction Factor (dB/m)	Result (dBuV/m)	Limit (dBuV/m)	Margin (dB)	Height (cm)	Degree (°)	Remark
1	1998.000	56.78	-14.42	42.36	74.00	-31.64	100	134	peak
2	3320.500	58.81	-12.29	46.52	74.00	-27.48	100	108	peak
3	4354.000	57.04	-9.68	47.36	74.00	-26.64	100	170	peak
4	5524.000	54.44	-7.03	47.41	74.00	-26.59	100	97	peak
5	6031.000	51.69	-5.49	46.20	74.00	-27.80	100	173	peak
6	6752.500	51.45	-3.76	47.69	74.00	-26.31	100	3	peak

REMARKS:

1. The other emission levels were very low against the limit.
2. Margin (dB) = Result (dBuV/m) – Limit (dBuV/m)

Report No.: T190322E03-F

Test Mode	Mode 4	6dB Bandwidth	1 MHz
Environmental Conditions	26°C, 60% RH	Test Date	2019/03/25
Antenna Pole	Horizontal	Antenna Distance	3m
Highest frequency generated or used	2.48GHz	Upper frequency	12.4GHz
Detector Function	Peak	Tested by	Wiz Chang

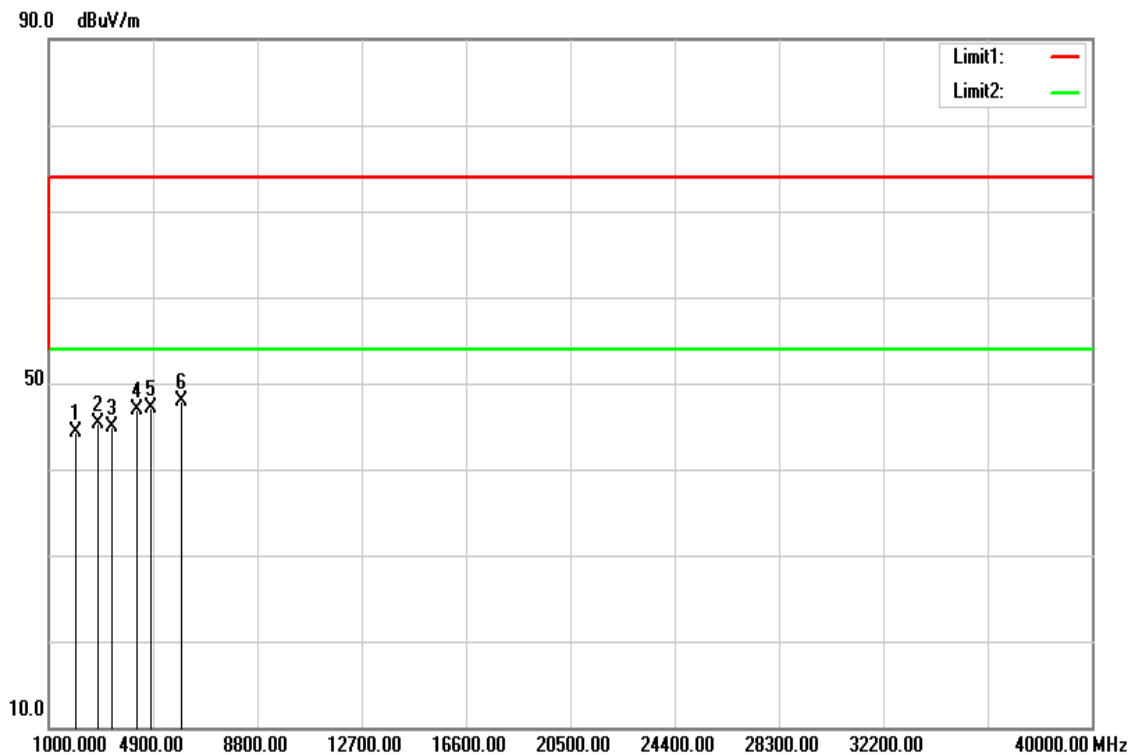

No.	Frequency (MHz)	Reading (dBuV)	Correction Factor (dB/m)	Result (dBuV/m)	Limit (dBuV/m)	Margin (dB)	Height (cm)	Degree (°)	Remark
1	1998.000	58.94	-14.63	44.31	74.00	-29.69	100	330	peak
2	2852.500	58.40	-13.15	45.25	74.00	-28.75	100	186	peak
3	3398.500	57.53	-12.63	44.90	74.00	-29.10	100	353	peak
4	4276.000	57.23	-10.39	46.84	74.00	-27.16	100	297	peak
5	4841.500	56.07	-9.05	47.02	74.00	-26.98	100	237	peak
6	5953.000	54.06	-6.06	48.00	74.00	-26.00	100	315	peak

REMARKS:

1. The other emission levels were very low against the limit.
2. Margin (dB) = Result (dBuV/m) – Limit (dBuV/m)

--End of Report--