

FCC 802.11n 40MHz AUX1 5755MHz

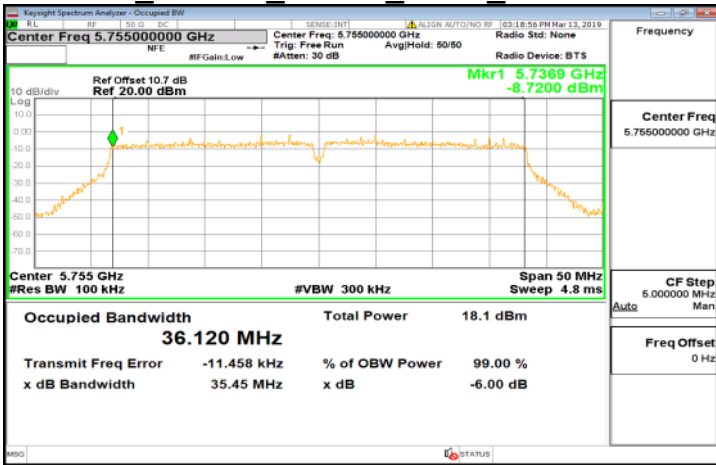

FCC 802.11ac 80MHz Main 5290MHz

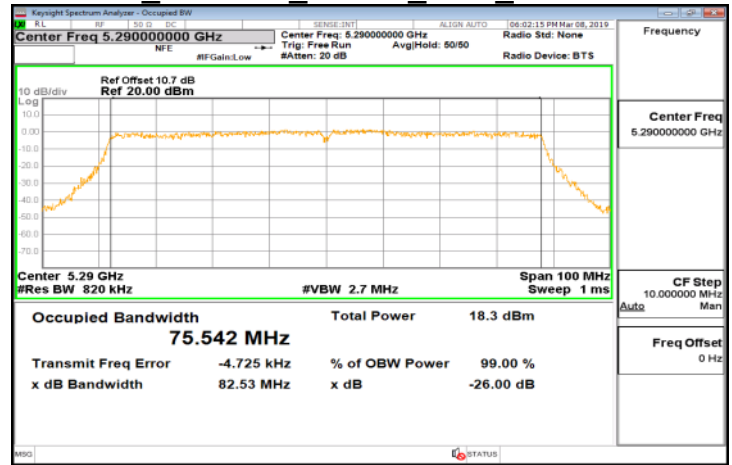

FCC 802.11n 40MHz AUX1 5795MHz

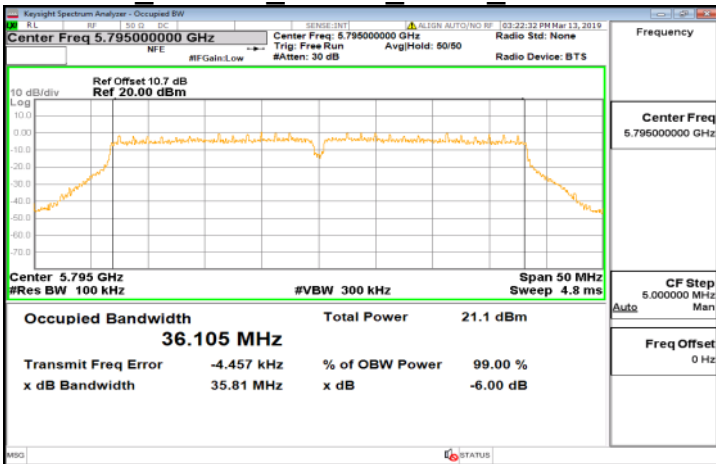

FCC 802.11ac 80MHz Main 5530MHz

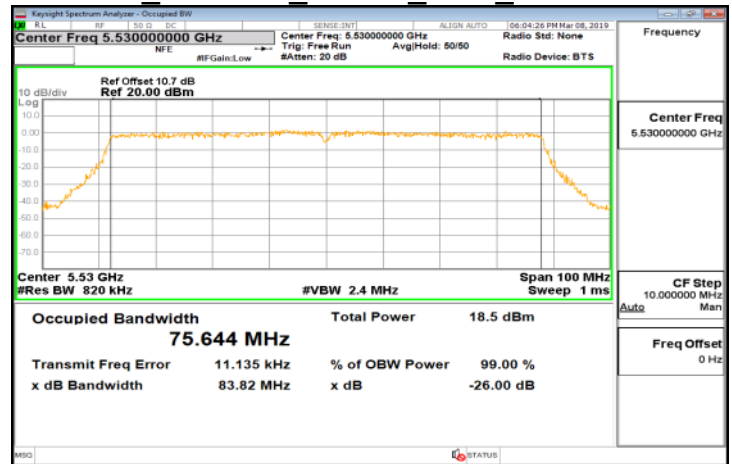

FCC 802.11ac 80MHz Main 5210MHz

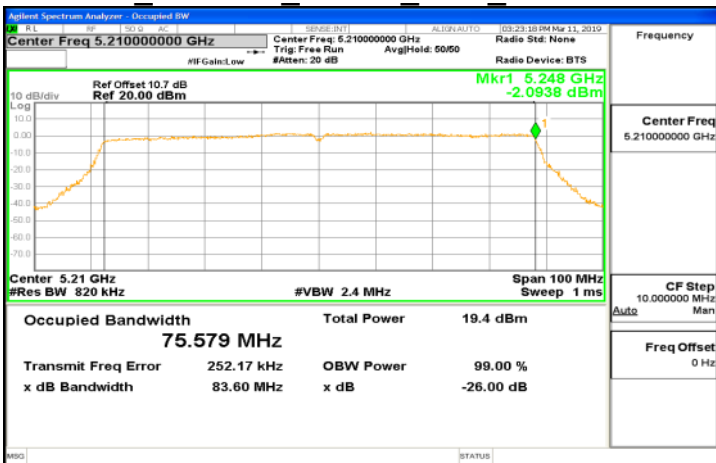

FCC 802.11ac 80MHz Main 5610MHz

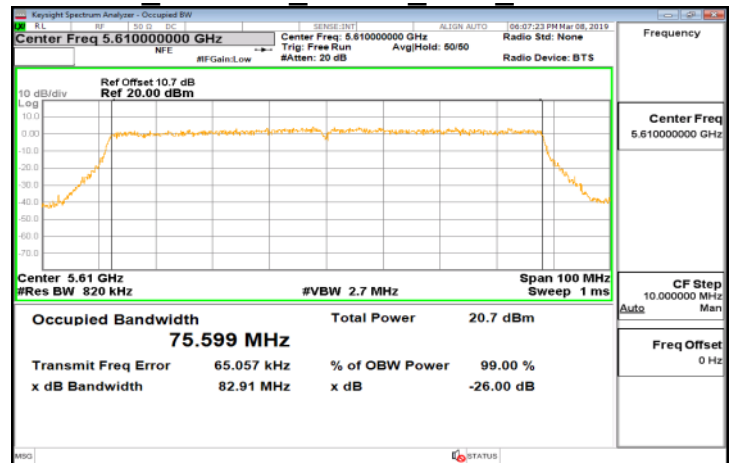

Unless otherwise stated the results shown in this test report refer only to the sample(s) tested and such sample(s) are retained for 90 days only.

除非另有說明，此報告結果僅對測試之樣品負責，同時此樣品僅保留90天。本報告未經本公司書面許可，不可部份複製。

This document is issued by the Company subject to its General Conditions of Service printed overleaf, available on request or accessible at www.sgs.com/terms_and_conditions.htm and for electronic format documents, subject to Terms and Conditions for Electronic Documents at www.sgs.com/terms_e-document.htm. Attention is drawn to the limitation of liability, indemnification and jurisdiction issues defined therein. Any holder of this document is advised that information contained hereon reflects the Company's findings at the time of its intervention only and within the limits of Client's instructions, if any. The Company's sole responsibility is to its Client and this document does not exonerate parties to a transaction from exercising all their rights and obligations under the transaction documents. This document cannot be reproduced except in full, without prior written approval of the Company. Any unauthorized alteration, forgery or falsification of the content or appearance of this document is unlawful and offenders may be prosecuted to the fullest extent of the law.

FCC 802.11ac 80MHz Main 5690MHz

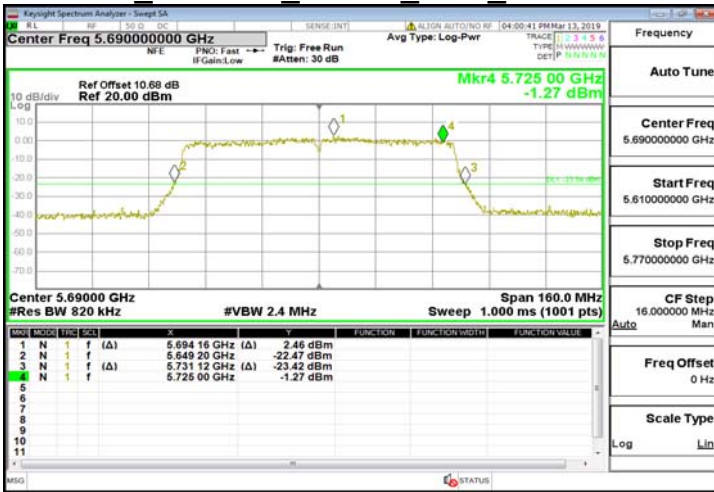

FCC 802.11ac 80MHz AUX1 5210MHz

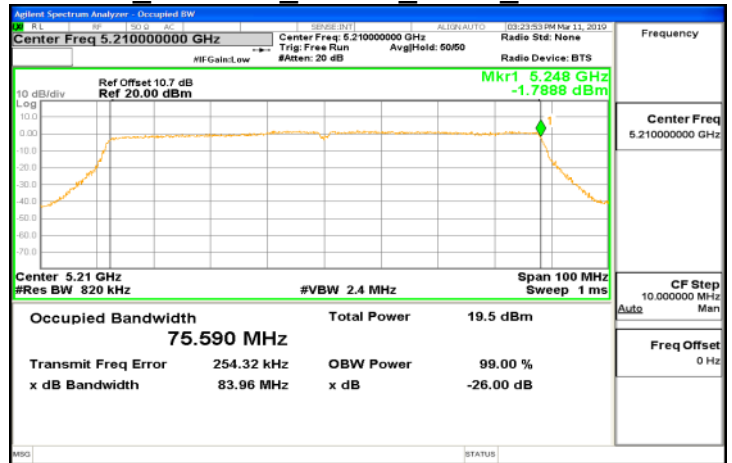

FCC 802.11ac 80MHz Main 5775MHz

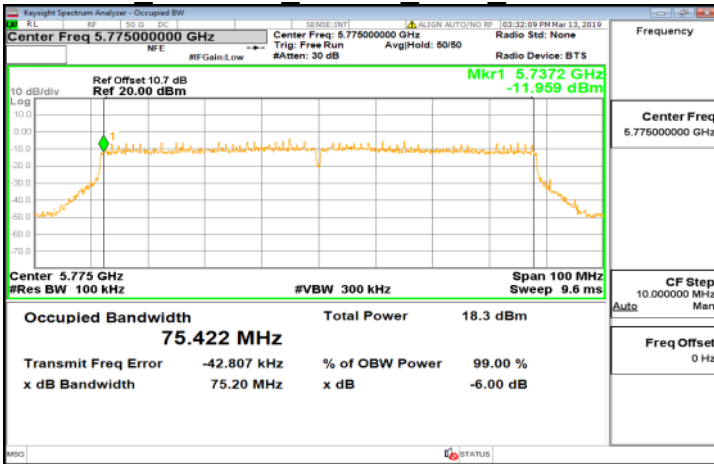

FCC 802.11ac 80MHz AUX1 5290MHz

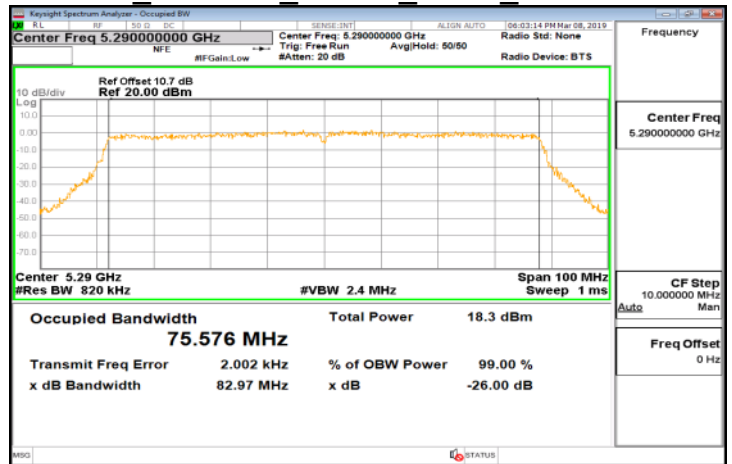

FCC 802.11ac 80MHz AUX1 5530MHz

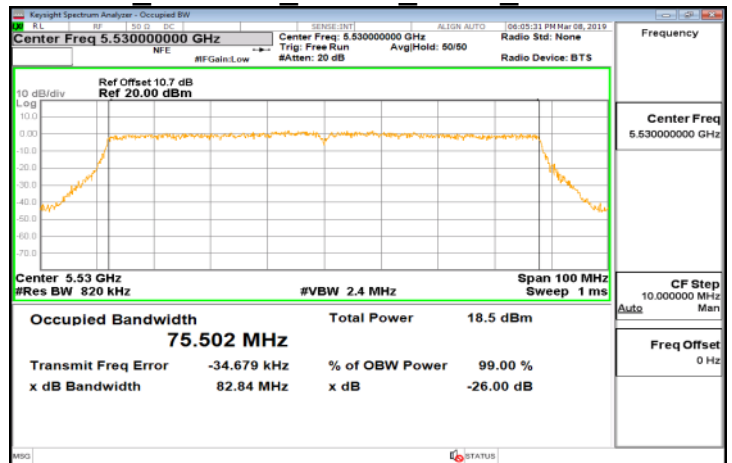

Unless otherwise stated the results shown in this test report refer only to the sample(s) tested and such sample(s) are retained for 90 days only.

除非另有說明，此報告結果僅對測試之樣品負責，同時此樣品僅保留90天。本報告未經本公司書面許可，不可部份複製。

This document is issued by the Company subject to its General Conditions of Service printed overleaf, available on request or accessible at www.sgs.com/terms_and_conditions.htm and for electronic format documents, subject to Terms and Conditions for Electronic Documents at www.sgs.com/terms_e-document.htm. Attention is drawn to the limitation of liability, indemnification and jurisdiction issues defined therein. Any holder of this document is advised that information contained hereon reflects the Company's findings at the time of its intervention only and within the limits of Client's instructions, if any. The Company's sole responsibility is to its Client and this document does not exonerate parties to a transaction from exercising all their rights and obligations under the transaction documents. This document cannot be reproduced except in full, without prior written approval of the Company. Any unauthorized alteration, forgery or falsification of the content or appearance of this document is unlawful and offenders may be prosecuted to the fullest extent of the law.

FCC 802.11ac 80MHz AUX1 5610MHz

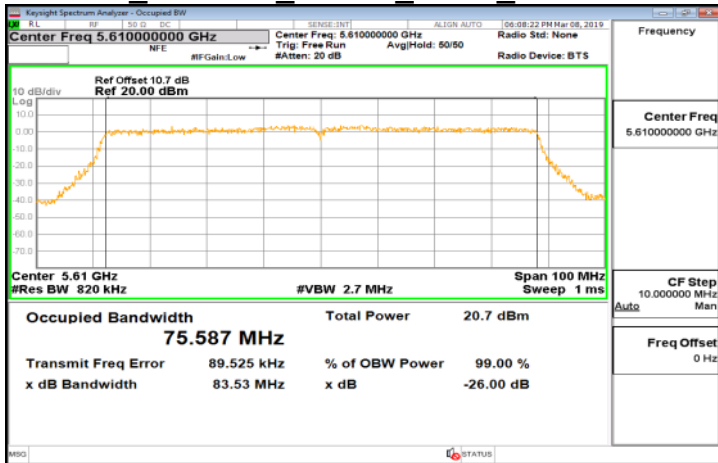

FCC 802.11ac 80MHz AUX1 5690MHz



FCC 802.11ac 80MHz AUX1 5775MHz

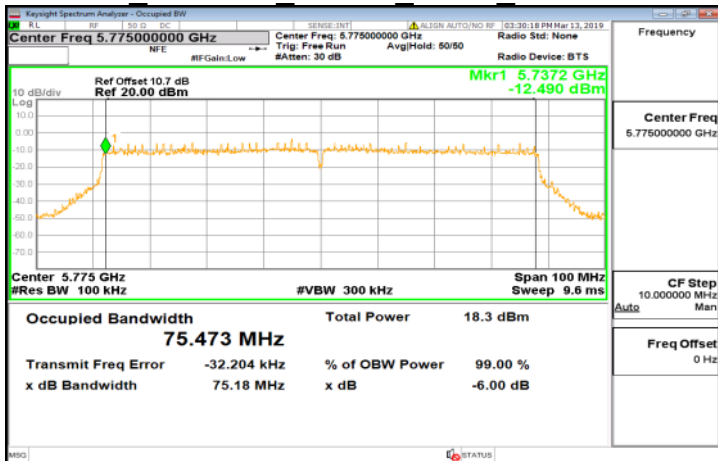

Unless otherwise stated the results shown in this test report refer only to the sample(s) tested and such sample(s) are retained for 90 days only.

除非另有說明，此報告結果僅對測試之樣品負責，同時此樣品僅保留90天。本報告未經本公司書面許可，不可部份複製。

This document is issued by the Company subject to its General Conditions of Service printed overleaf, available on request or accessible at www.sgs.com/terms_and_conditions.htm and for electronic format documents, subject to Terms and Conditions for Electronic Documents at www.sgs.com/terms_e-document.htm. Attention is drawn to the limitation of liability, indemnification and jurisdiction issues defined therein. Any holder of this document is advised that information contained hereon reflects the Company's findings at the time of its intervention only and within the limits of Client's instructions, if any. The Company's sole responsibility is to its Client and this document does not exonerate parties to a transaction from exercising all their rights and obligations under the transaction documents. This document cannot be reproduced except in full, without prior written approval of the Company. Any unauthorized alteration, forgery or falsification of the content or appearance of this document is unlawful and offenders may be prosecuted to the fullest extent of the law.

9. MAXIMUM CONDUCTED OUTPUT POWER MEASUREMENT

9.1 Standard Applicable

OPERZTION Band	EUT CATEGORY		LIMIT
U-NII-1		Access Point (Master device)	1 Watt(30dBm)
		Fixed point-to-point Access Point	1 Watt(30dBm)
	√	Mobile and portable client device	250mW(23.98dBm)
U-NII-2A	√		250mW(23.98dBm) or 11dBm+10 log B
U-NII-2C	√		250mW(23.98dBm) or 11dBm+10 log B
U-NII-3	√		1 Watt(30dBm)
<p>If transmitting antennas of directional gain greater than 6 dBi are used, the Maximum transmit power shall be reduced by the amount in dB that the direction-al gain of the antenna exceeds 6 dBi.</p>			

Note:

As per FCC KDB 662911 D01

Unequal antenna gains, with equal transmit powers. For antenna gains given by G1, G2, ..., GN dBi.

(i) If transmit signals are correlated, then Directional gain
 $= 10 \log[(10^{G1/20} + 10^{G2/20} + \dots + 10^{GN/20})^2 / N_{ANT}] \text{ dBi}$

[Note the “20”s in the denominator of each exponent and the square of the sum of terms; the object is to combine the signal levels coherently.]

The antenna gain is not granter than 6 dBi. Therefore, reduction of power is not required.

Unless otherwise stated the results shown in this test report refer only to the sample(s) tested and such sample(s) are retained for 90 days only.

除非另有說明，此報告結果僅對測試之樣品負責，同時此樣品僅保留90天。本報告未經本公司書面許可，不可部份複製。

This document is issued by the Company subject to its General Conditions of Service printed overleaf, available on request or accessible at www.sgs.com/terms_and_conditions.htm and for electronic format documents, subject to Terms and Conditions for Electronic Documents at www.sgs.com/terms_e-document.htm. Attention is drawn to the limitation of liability, indemnification and jurisdiction issues defined therein. Any holder of this document is advised that information contained hereon reflects the Company's findings at the time of its intervention only and within the limits of Client's instructions, if any. The Company's sole responsibility is to its Client and this document does not exonerate parties to a transaction from exercising all their rights and obligations under the transaction documents. This document cannot be reproduced except in full, without prior written approval of the Company. Any unauthorized alteration, forgery or falsification of the content or appearance of this document is unlawful and offenders may be prosecuted to the fullest extent of the law.

9.2 Measurement Procedure

1. Place the EUT on the table and set it in transmitting mode.
2. The testing follows FCC KDB 789033 D02 General UNII Test Procedures New Rules.
3. Remove the antenna from the EUT and then connect a low loss RF cable from the antenna port to the power meter
4. Power Meter is used as the auxiliary test equipment to conduct the output power measurement.
5. Record the max. reading and add 10 log(1/duty cycle).
6. Repeat above procedures until all frequency (low, middle, and high channel) measured were complete.

9.3 Measurement Equipment Used

Conducted Emission Test Site					
EQUIPMENT TYPE	MFR	MODEL NUMBER	SERIAL NUMBER	LAST CAL.	CAL DUE.
Power Meter	Anritsu	ML2496A	1242004	10/23/2018	10/22/2019
Power Sensor	Anritsu	MA2411B	1207365	10/23/2018	10/22/2019
Power Sensor	Anritsu	MA2411B	1207368	10/24/2018	10/23/2019
DC Power Supply	Agilent	E3640A	KR93300208	08/15/2018	08/14/2019
Attenuator	Mini-Circuit	BW-S10W2+	1	02/26/2019	02/25/2020

9.4 Test Set-up

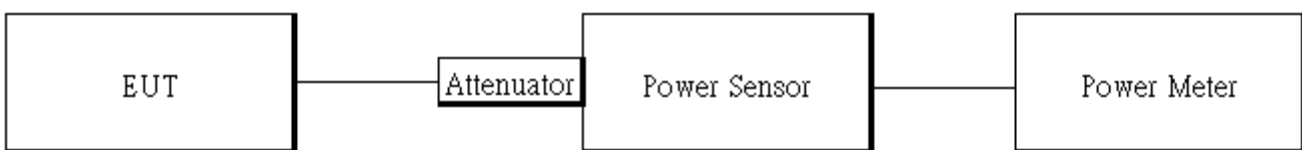

Unless otherwise stated the results shown in this test report refer only to the sample(s) tested and such sample(s) are retained for 90 days only.

除非另有說明，此報告結果僅對測試之樣品負責，同時此樣品僅保留90天。本報告未經本公司書面許可，不可部份複製。

This document is issued by the Company subject to its General Conditions of Service printed overleaf, available on request or accessible at www.sgs.com/terms_and_conditions.htm and for electronic format documents, subject to Terms and Conditions for Electronic Documents at www.sgs.com/terms_e-document.htm. Attention is drawn to the limitation of liability, indemnification and jurisdiction issues defined therein. Any holder of this document is advised that information contained hereon reflects the Company's findings at the time of its intervention only and within the limits of Client's instructions, if any. The Company's sole responsibility is to its Client and this document does not exonerate parties to a transaction from exercising all their rights and obligations under the transaction documents. This document cannot be reproduced except in full, without prior written approval of the Company. Any unauthorized alteration, forgery or falsification of the content or appearance of this document is unlawful and offenders may be prosecuted to the fullest extent of the law.

9.5 Measurement Result

U-NII-1, U-NII-2-A and U-NII-2-C

802.11a_2Tx

CH	Frequency (MHz)	Data Rate	Avg. POWER (dBm)		TOTAL POWER (dBm)	TOTAL POWER (mW)	REQUIRED LIMIT (dBm)	RESULT
			CH 0	CH 1				
36	5180	6	11.96	11.82	14.98	31.485	23.98	PASS
44	5220	6	13.64	13.62	16.72	46.995	23.98	PASS
48	5240	6	13.95	13.54	16.84	48.310	23.98	PASS
52	5260	6	13.72	13.86	16.88	48.765	23.98 or $11+10\log(B) = 24.46$	PASS
60	5300	6	13.52	13.8	16.75	47.345	23.98 or $11+10\log(B) = 24.56$	PASS
64	5320	6	11.3	11.79	14.64	29.123	23.98 or $11+10\log(B) = 24.55$	PASS
100	5500	6	11.87	11.24	14.66	29.221	23.98 or $11+10\log(B) = 24.62$	PASS
116	5580	6	13.55	13.52	16.63	45.978	23.98 or $11+10\log(B) = 24.69$	PASS
140	5700	6	11.72	11.94	14.92	31.059	23.98 or $11+10\log(B) = 24.65$	PASS

802.11n_HT20_MIMO

CH	Frequency (MHz)	Data Rate	Avg. POWER (dBm)		TOTAL POWER (dBm)	TOTAL POWER (mW)	REQUIRED LIMIT (dBm)	RESULT
			CH 0	CH 1				
36	5180	MCS8	11.84	11.62	14.83	30.405	23.98	PASS
44	5220	MCS8	13.76	13.94	16.95	49.533	23.98	PASS
48	5240	MCS8	13.62	14.12	16.98	49.834	23.98	PASS
52	5260	MCS8	13.72	13.94	16.93	49.311	23.98 or $11+10\log(B) = 24.67$	PASS
60	5300	MCS8	13.68	13.88	16.88	48.744	23.98 or $11+10\log(B) = 24.74$	PASS
64	5320	MCS8	11.74	11.95	14.94	31.220	23.98 or $11+10\log(B) = 24.47$	PASS
100	5500	MCS8	12.16	11.57	14.97	31.427	23.98 or $11+10\log(B) = 24.71$	PASS
116	5580	MCS8	13.76	13.86	16.91	49.072	23.98 or $11+10\log(B) = 24.74$	PASS
140	5700	MCS8	11.72	11.68	14.80	30.186	23.98 or $11+10\log(B) = 24.69$	PASS

802.11n_HT40_MIMO

CH	Frequency (MHz)	Data Rate	Avg. POWER (dBm)		TOTAL POWER (dBm)	TOTAL POWER (mW)	REQUIRED LIMIT (dBm)	RESULT
			CH 0	CH 1				
38	5190	MCS8	11.57	11.48	14.71	29.593	23.98	PASS
46	5230	MCS8	13.69	13.87	16.97	49.746	23.98	PASS
54	5270	MCS8	13.61	13.72	16.85	48.440	23.98 or $11+10\log(B) = 27.08$	PASS
62	5310	MCS8	11.73	11.82	14.96	31.347	23.98 or $11+10\log(B) = 27.11$	PASS
102	5510	MCS8	11.89	11.39	14.83	30.436	23.98 or $11+10\log(B) = 27.11$	PASS
110	5550	MCS8	13.73	13.49	16.80	47.845	23.98 or $11+10\log(B) = 27.05$	PASS
134	5670	MCS8	11.96	11.37	14.86	30.632	23.98 or $11+10\log(B) = 27.10$	PASS

802.11ac_VHT80_MIMO

CH	Frequency (MHz)	Data Rate	Avg. POWER (dBm)		TOTAL POWER (dBm)	TOTAL POWER (mW)	REQUIRED LIMIT (dBm)	RESULT
			CH 0	CH 1				
42	5210	MCS0	11.24	11.48	14.37	27.365	23.98	PASS
58	5290	MCS0	11.21	11.61	14.42	27.701	23.98 or $11+10\log(B) = 30.17$	PASS
106	5530	MCS0	11.62	11.58	14.61	28.909	23.98 or $11+10\log(B) = 30.18$	PASS
122	5610	MCS0	13.31	13.37	16.35	43.156	23.98 or $11+10\log(B) = 30.19$	PASS

Unless otherwise stated the results shown in this test report refer only to the sample(s) tested and such sample(s) are retained for 90 days only.

除非另有說明，此報告結果僅對測試之樣品負責，同時此樣品僅保留90天。本報告未經本公司書面許可，不可部份複製。

This document is issued by the Company subject to its General Conditions of Service printed overleaf, available on request or accessible at www.sgs.com/terms_and_conditions.htm and for electronic format documents, subject to Terms and Conditions for Electronic Documents at www.sgs.com/terms_e-document.htm. Attention is drawn to the limitation of liability, indemnification and jurisdiction issues defined therein. Any holder of this document is advised that information contained hereon reflects the Company's findings at the time of its intervention only and within the limits of Client's instructions, if any. The Company's sole responsibility is to its Client and this document does not exonerate parties to a transaction from exercising all their rights and obligations under the transaction documents. This document cannot be reproduced except in full, without prior written approval of the Company. Any unauthorized alteration, forgery or falsification of the content or appearance of this document is unlawful and offenders may be prosecuted to the fullest extent of the law.

U-NII-2-C and U-NII-3

802.11a_2Tx

CH	Frequency (MHz)	Data Rate	Avg. POWER (dBm)		TOTAL POWER (dBm)	TOTAL POWER (mW)	REQUIRED LIMIT (dBm)	RESULT
			CH 0	CH 1				
144	5720(U-NII 2C)	6	8.16	8.41	10.64	11.591	23.98 or $11+10\log(B) = 23.03$	PASS
144	5720 (U-NII 3)	6	3.15	3.57	4.11	2.575	30	PASS
149	5745	6	11.72	11.53	14.72	29.625	30	PASS
157	5785	6	13.84	13.77	16.90	48.929	30	PASS
165	5825	6	11.47	11.97	14.82	30.323	30	PASS

802.11n_HT20_MIMO

CH	Frequency (MHz)	Data Rate	Avg. POWER (dBm)		TOTAL POWER (dBm)	TOTAL POWER (mW)	REQUIRED LIMIT (dBm)	RESULT
			CH 0	CH 1				
144	5720(U-NII 2C)	MCS8	8.37	8.98	10.82	12.077	23.98 or $11+10\log(B) = 23.26$	PASS
144	5720 (U-NII 3)	MCS8	3.20	3.15	4.14	2.593	30	PASS
149	5745	MCS8	11.91	11.85	14.98	31.464	30	PASS
157	5785	MCS8	13.82	13.95	16.98	49.929	30	PASS
165	5825	MCS8	11.57	11.87	14.82	30.343	30	PASS

802.11n_HT40_MIMO

CH	Frequency (MHz)	Data Rate	Avg. POWER (dBm)		TOTAL POWER (dBm)	TOTAL POWER (mW)	REQUIRED LIMIT (dBm)	RESULT
			CH 0	CH 1				
142	5710(U-NII 2C)	MCS8	9.91	10.44	12.97	19.831	23.98 or $11+10\log(B) = 26.47$	PASS
142	5720 (U-NII 3)	MCS8	1.50	1.65	1.97	1.572	30	PASS
151	5755	MCS8	11.95	11.52	14.92	31.018	30	PASS
159	5795	MCS8	13.76	13.83	16.97	49.785	30	PASS

802.11ac_VHT80_MIMO

CH	Frequency (MHz)	Data Rate	Avg. POWER (dBm)		TOTAL POWER (dBm)	TOTAL POWER (mW)	REQUIRED LIMIT (dBm)	RESULT
			CH 0	CH 1				
138	5690(U-NII 2C)	MCS0	10.39	10.74	13.72	23.556	23.98 or $11+10\log(B) = 29.80$	PASS
138	5690 (U-NII 3)	MCS0	0.84	0.98	1.11	1.291	30	PASS
155	5775	MCS0	11.43	11.38	14.75	29.868	30	PASS

Unless otherwise stated the results shown in this test report refer only to the sample(s) tested and such sample(s) are retained for 90 days only.

除非另有說明，此報告結果僅對測試之樣品負責，同時此樣品僅保留90天。本報告未經本公司書面許可，不可部份複製。

This document is issued by the Company subject to its General Conditions of Service printed overleaf, available on request or accessible at www.sgs.com/terms_and_conditions.htm and for electronic format documents, subject to Terms and Conditions for Electronic Documents at www.sgs.com/terms_e-document.htm. Attention is drawn to the limitation of liability, indemnification and jurisdiction issues defined therein. Any holder of this document is advised that information contained hereon reflects the Company's findings at the time of its intervention only and within the limits of Client's instructions, if any. The Company's sole responsibility is to its Client and this document does not exonerate parties to a transaction from exercising all their rights and obligations under the transaction documents. This document cannot be reproduced except in full, without prior written approval of the Company. Any unauthorized alteration, forgery or falsification of the content or appearance of this document is unlawful and offenders may be prosecuted to the fullest extent of the law.

10. POWER SPECTRAL DENSITY

10.1 Standard Applicable

OPERZTION Band	EUT CATEGORY		LIMIT
U-NII-1		Access Point (Master device)	17dBm/ MHz
		Fixed point-to-point Access Point	
	√	Mobile and portable client device	11dBm/ MHz
U-NII-2A	√		11dBm/ MHz
U-NII-2C	√		11dBm/ MHz
U-NII-3	√		30dBm/ 500kHz

If transmitting antennas of directional gain greater than 6 dBi are used, the Maximum power spectral density shall be reduced by the amount in dB that the directional gain of the antenna exceeds 6 dBi.

Note:

As per FCC KDB 662911 D01

Unequal antenna gains, with equal transmit powers. For antenna gains given by G1, G2, ..., GN dBi.

(i) If transmit signals are correlated, then Directional gain

$$= 10 \log[(10^{G1/20} + 10^{G2/20} + \dots + 10^{GN/20})^2 / N_{ANT}] \text{ dBi}$$

[Note the “20”s in the denominator of each exponent and the square of the sum of terms; the object is to combine the signal levels coherently.]

The antenna gain is not greater than 6 dBi. Therefore, reduction of power is not required.

Unless otherwise stated the results shown in this test report refer only to the sample(s) tested and such sample(s) are retained for 90 days only.

除非另有說明，此報告結果僅對測試之樣品負責，同時此樣品僅保留90天。本報告未經本公司書面許可，不可部份複製。

This document is issued by the Company subject to its General Conditions of Service printed overleaf, available on request or accessible at www.sgs.com/terms_and_conditions.htm and for electronic format documents, subject to Terms and Conditions for Electronic Documents at www.sgs.com/terms_e-document.htm. Attention is drawn to the limitation of liability, indemnification and jurisdiction issues defined therein. Any holder of this document is advised that information contained hereon reflects the Company's findings at the time of its intervention only and within the limits of Client's instructions, if any. The Company's sole responsibility is to its Client and this document does not exonerate parties to a transaction from exercising all their rights and obligations under the transaction documents. This document cannot be reproduced except in full, without prior written approval of the Company. Any unauthorized alteration, forgery or falsification of the content or appearance of this document is unlawful and offenders may be prosecuted to the fullest extent of the law.

10.2 Measurement Procedure

1. Place the EUT on the table and set it in transmitting mode.
2. The testing follows FCC KDB 789033 D02 General UNII Test Procedures New Rules.
3. Remove the antenna from the EUT and then connect a low loss RF cable from the antenna port to Spectrum.
4. **For U-NII1, U-NII-2A, U-NII-2C Band:**
Set RBW=1MHz, VBW=3MHz, where span is enough to capture the entire bandwidth, Sweep time = Auto (601 pts), detector = sample, traces 100 sweeps of video averaging. (SA-2 with the omission of procedure x, the integration with 26dB EBW bandwidth)
- For U-NII-3 Band:**
Set RBW=500 kHz, VBW \geq 3RBW, where span is enough to capture the entire bandwidth, Sweep time = Auto (601 pts), detector = sample, traces 100 sweeps of video averaging. (SA-2 with the omission of procedure x, the integration with 26dB EBW bandwidth)
5. User the cursor on spectrum to peak search the highest level of trace
6. Record the max. reading and add 10 log(1/duty cycle).
7. Repeat above procedures until all default test channel (low, middle, and high) was complete.
8. 802.11n MIMO mode: offset is set following “measure and add 10 Log (N)” on spectrum to measure the PSD for MIMO mode. Offset = cable loss + 10 log (N), where N is number of transmitting antenna. N=2 for this given application.

Note: For the test of PSD at MIMO mode, the highest emission of worst case employing Measure and add 10 log (N) technical is reported on this report after the comparison between Main Antenna at single transmitting mode and Aux that yields the higher value. The MIMO transmitting mode produces higher value of outcome

10.3 Measurement Equipment Used

Conducted Emission Test Site					
EQUIPMENT TYPE	MFR	MODEL NUMBER	SERIAL NUMBER	LAST CAL.	CAL DUE.
DC Power Supply	Agilent	E3640A	KR93300208	08/15/2018	08/14/2019
PXA Spectrum Analyzer	Agilent	N9030A	MY53120760	04/09/2018	04/08/2019
Thermostatic/Hrgrosatic Chamber	TAICHY	MHG-150LF	930619	10/08/2018	10/07/2019
DC Block	Mini-Circuits	BLK-18-S+	31129(1)	02/26/2019	02/25/2020
Attenuator	Mini-Circuit	BW-S10W2+	1	02/26/2019	02/25/2020

Unless otherwise stated the results shown in this test report refer only to the sample(s) tested and such sample(s) are retained for 90 days only.

除非另有說明，此報告結果僅對測試之樣品負責，同時此樣品僅保留90天。本報告未經本公司書面許可，不可部份複製。

This document is issued by the Company subject to its General Conditions of Service printed overleaf, available on request or accessible at www.sgs.com/terms_and_conditions.htm and for electronic format documents, subject to Terms and Conditions for Electronic Documents at www.sgs.com/terms_e-document.htm. Attention is drawn to the limitation of liability, indemnification and jurisdiction issues defined therein. Any holder of this document is advised that information contained hereon reflects the Company's findings at the time of its intervention only and within the limits of Client's instructions, if any. The Company's sole responsibility is to its Client and this document does not exonerate parties to a transaction from exercising all their rights and obligations under the transaction documents. This document cannot be reproduced except in full, without prior written approval of the Company. Any unauthorized alteration, forgery or falsification of the content or appearance of this document is unlawful and offenders may be prosecuted to the fullest extent of the law.

10.4 Test Set-up

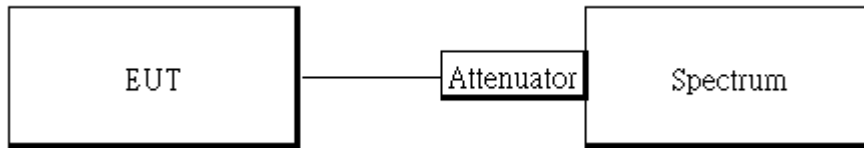

10.5 Measurement Result

U-NII1, U-NII-2 and U-NII-2C

POWER DENSITY 802.11a MODE					
Frequency (MHz)	PSD W/O Duty Factor (dBm)	Duty Factor	PSD With Duty Factor (dBm)	Limit (dBm)	Margin (dB)
5180	1.49	0.08	1.57	11	-9.43
5220	2.42	0.08	2.50	11	-8.50
5240	2.62	0.08	2.70	11	-8.30
5260	2.72	0.08	2.80	11	-8.20
5300	3.11	0.08	3.19	11	-7.81
5320	1.06	0.08	1.14	11	-9.86
5500	1.21	0.08	1.29	11	-9.71
5580	3.32	0.08	3.40	11	-7.60
5700	1.22	0.08	1.30	11	-9.70

POWER DENSITY 802.11n HT20 MODE					
Frequency (MHz)	PSD W/O Duty Factor (dBm)	Duty Factor	PSD With Duty Factor (dBm)	Limit (dBm)	Margin (dB)
5180	2.77	0.09	2.86	11	-8.14
5220	5.18	0.09	5.27	11	-5.73
5240	4.84	0.09	4.93	11	-6.07
5260	4.54	0.09	4.63	11	-6.37
5300	4.78	0.09	4.87	11	-6.13
5320	2.54	0.09	2.63	11	-8.37
5500	1.88	0.09	1.97	11	-9.03
5580	3.62	0.09	3.71	11	-7.29
5700	2.63	0.09	2.72	11	-8.28

Unless otherwise stated the results shown in this test report refer only to the sample(s) tested and such sample(s) are retained for 90 days only.

除非另有說明，此報告結果僅對測試之樣品負責，同時此樣品僅保留90天。本報告未經本公司書面許可，不可部份複製。

This document is issued by the Company subject to its General Conditions of Service printed overleaf, available on request or accessible at www.sgs.com/terms_and_conditions.htm and for electronic format documents, subject to Terms and Conditions for Electronic Documents at www.sgs.com/terms_e-document.htm. Attention is drawn to the limitation of liability, indemnification and jurisdiction issues defined therein. Any holder of this document is advised that information contained hereon reflects the Company's findings at the time of its intervention only and within the limits of Client's instructions, if any. The Company's sole responsibility is to its Client and this document does not exonerate parties to a transaction from exercising all their rights and obligations under the transaction documents. This document cannot be reproduced except in full, without prior written approval of the Company. Any unauthorized alteration, forgery or falsification of the content or appearance of this document is unlawful and offenders may be prosecuted to the fullest extent of the law.

POWER DENSITY 802.11n HT40 MODE					
Frequency (MHz)	PSD W/O Duty Factor (dBm)	Duty Factor	PSD With Duty Factor (dBm)	Limit (dBm)	Margin (dB)
5190	-1.35	0.18	-1.17	11	-12.17
5230	2.1	0.18	2.28	11	-8.72
5270	-2.25	0.18	-2.07	11	-13.07
5310	-1.45	0.18	-1.27	11	-12.27
5510	-0.91	0.18	-0.73	11	-11.73
5550	0.53	0.18	0.71	11	-10.29
5670	-0.22	0.18	-0.04	11	-11.04

POWER DENSITY 802.11ac VHT80 MODE					
Frequency (MHz)	PSD W/O Duty Factor (dBm)	Duty Factor	PSD With Duty Factor (dBm)	Limit (dBm)	Margin (dB)
5210	-5.09	0.00	-5.09	11	-16.09
5290	-3.65	0.00	-3.65	11	-14.65
5530	-5.18	0.00	-5.18	11	-16.18
5610	-4.05	0.00	-4.05	11	-15.05

Note:

Cable Loss=

13.7 dB

Unless otherwise stated the results shown in this test report refer only to the sample(s) tested and such sample(s) are retained for 90 days only.

除非另有說明，此報告結果僅對測試之樣品負責，同時此樣品僅保留90天。本報告未經本公司書面許可，不可部份複製。

This document is issued by the Company subject to its General Conditions of Service printed overleaf, available on request or accessible at www.sgs.com/terms_and_conditions.htm and for electronic format documents, subject to Terms and Conditions for Electronic Documents at www.sgs.com/terms_e-document.htm. Attention is drawn to the limitation of liability, indemnification and jurisdiction issues defined therein. Any holder of this document is advised that information contained hereon reflects the Company's findings at the time of its intervention only and within the limits of Client's instructions, if any. The Company's sole responsibility is to its Client and this document does not exonerate parties to a transaction from exercising all their rights and obligations under the transaction documents. This document cannot be reproduced except in full, without prior written approval of the Company. Any unauthorized alteration, forgery or falsification of the content or appearance of this document is unlawful and offenders may be prosecuted to the fullest extent of the law.

U-NII-2C and U-NII-3

POWER DENSITY 802.11a MODE					
Frequency (MHz)	PSD W/O Duty Factor (dBm)	Duty Factor	PSD With Duty Factor (dBm)	Limit (dBm)	Margin (dB)
5720 (U-NII 2C)	3.21	0.08	3.29	11	-7.71
5720 (U-NII 3)	1.80	0.08	1.88	30	-28.12
5745	8.82	-	8.82	30	-21.18
5785	10.88	-	10.88	30	-19.12
5825	9.04	-	9.04	30	-20.96

POWER DENSITY 802.11n HT20 MODE					
Frequency (MHz)	PSD W/O Duty Factor (dBm)	Duty Factor	PSD With Duty Factor (dBm)	Limit (dBm)	Margin (dB)
5720 (U-NII 2C)	3.36	0.09	3.44	11	-7.56
5720 (U-NII 3)	2.17	0.09	2.25	30	-27.75
5745	9.73	-	9.73	30	-20.27
5785	10.76	-	10.76	30	-19.24
5825	8.26	-	8.26	30	-21.74

POWER DENSITY 802.11n HT40 MODE					
Frequency (MHz)	PSD W/O Duty Factor (dBm)	Duty Factor	PSD With Duty Factor (dBm)	Limit (dBm)	Margin (dB)
5710 (U-NII 2C)	-0.52	0.17	-0.35	11	-11.35
5710 (U-NII 3)	-2.77	0.17	-2.60	30	-32.60
5755	5.95	-	5.95	30	-24.05
5795	7.48	-	7.48	30	-22.52

POWER DENSITY 802.11ac VHT80 MODE					
Frequency (MHz)	PSD W/O Duty Factor (dBm)	Duty Factor	PSD With Duty Factor (dBm)	Limit (dBm)	Margin (dB)
5690 (U-NII 2C)	-4.53	0.34	-4.19	11	-15.19
5690 (U-NII 3)	-6.35	0.34	-6.02	30	-36.02
5775	2.65	-	2.65	30	-27.35

Unless otherwise stated the results shown in this test report refer only to the sample(s) tested and such sample(s) are retained for 90 days only.

除非另有說明，此報告結果僅對測試之樣品負責，同時此樣品僅保留90天。本報告未經本公司書面許可，不可部份複製。

This document is issued by the Company subject to its General Conditions of Service printed overleaf, available on request or accessible at www.sgs.com/terms_and_conditions.htm and for electronic format documents, subject to Terms and Conditions for Electronic Documents at www.sgs.com/terms_e-document.htm. Attention is drawn to the limitation of liability, indemnification and jurisdiction issues defined therein. Any holder of this document is advised that information contained hereon reflects the Company's findings at the time of its intervention only and within the limits of Client's instructions, if any. The Company's sole responsibility is to its Client and this document does not exonerate parties to a transaction from exercising all their rights and obligations under the transaction documents. This document cannot be reproduced except in full, without prior written approval of the Company. Any unauthorized alteration, forgery or falsification of the content or appearance of this document is unlawful and offenders may be prosecuted to the fullest extent of the law.

802.11a 20MHz 5180MHz

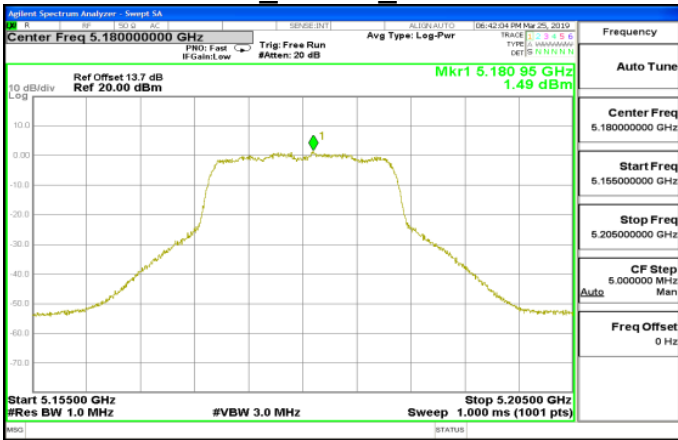

802.11a 20MHz 5260MHz

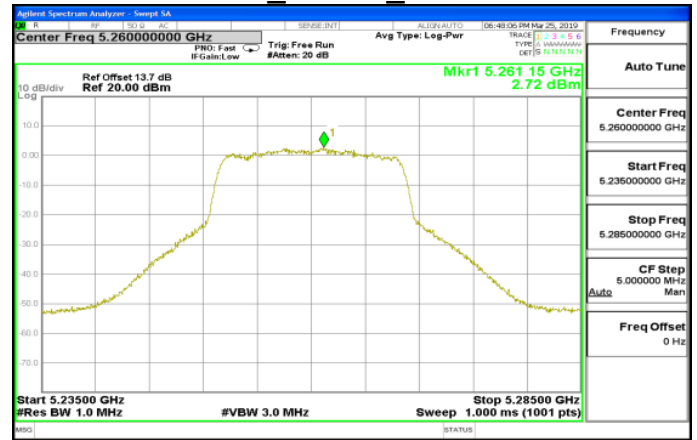

802.11a 20MHz 5220MHz

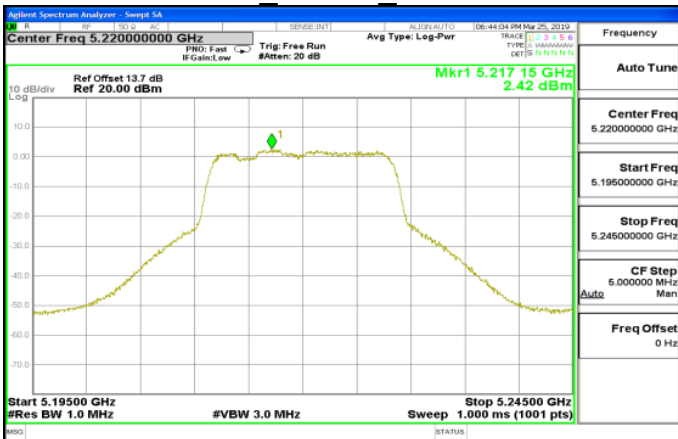

802.11a 20MHz 5300MHz

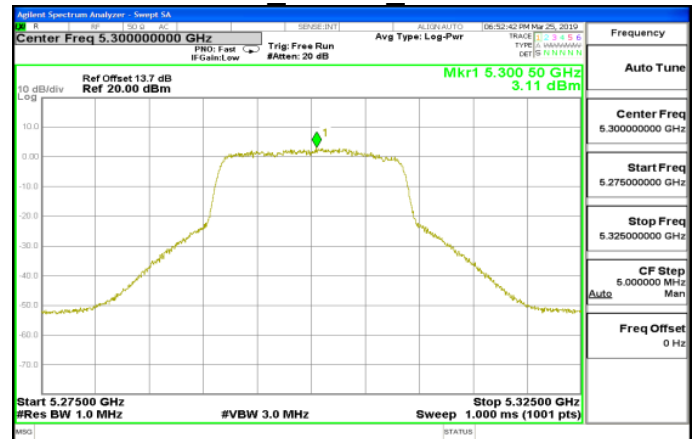

802.11a 20MHz 5240MHz

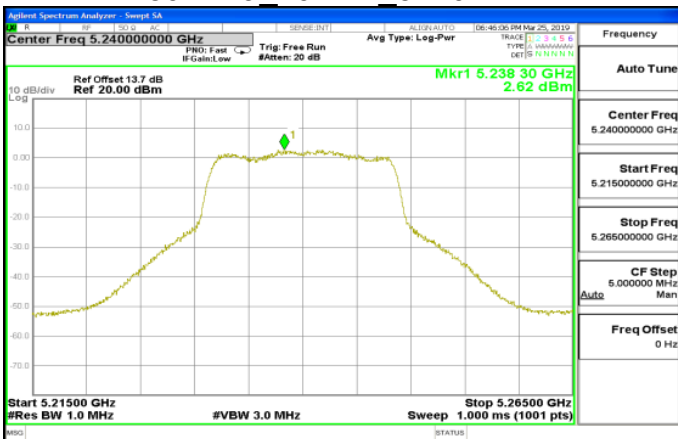

802.11a 20MHz 5320MHz

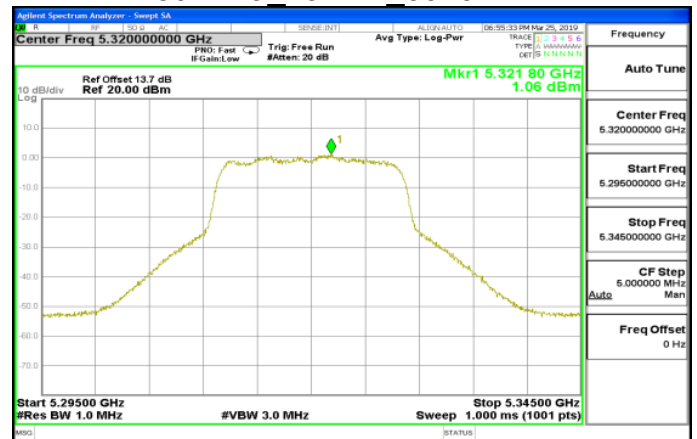

Unless otherwise stated the results shown in this test report refer only to the sample(s) tested and such sample(s) are retained for 90 days only.

除非另有說明，此報告結果僅對測試之樣品負責，同時此樣品僅保留90天。本報告未經本公司書面許可，不可部份複製。

This document is issued by the Company subject to its General Conditions of Service printed overleaf, available on request or accessible at www.sgs.com/terms_and_conditions.htm and for electronic format documents, subject to Terms and Conditions for Electronic Documents at www.sgs.com/terms_e-document.htm. Attention is drawn to the limitation of liability, indemnification and jurisdiction issues defined therein. Any holder of this document is advised that information contained hereon reflects the Company's findings at the time of its intervention only and within the limits of Client's instructions, if any. The Company's sole responsibility is to its Client and this document does not exonerate parties to a transaction from exercising all their rights and obligations under the transaction documents. This document cannot be reproduced except in full, without prior written approval of the Company. Any unauthorized alteration, forgery or falsification of the content or appearance of this document is unlawful and offenders may be prosecuted to the fullest extent of the law.

802.11a 20MHz 5500MHz

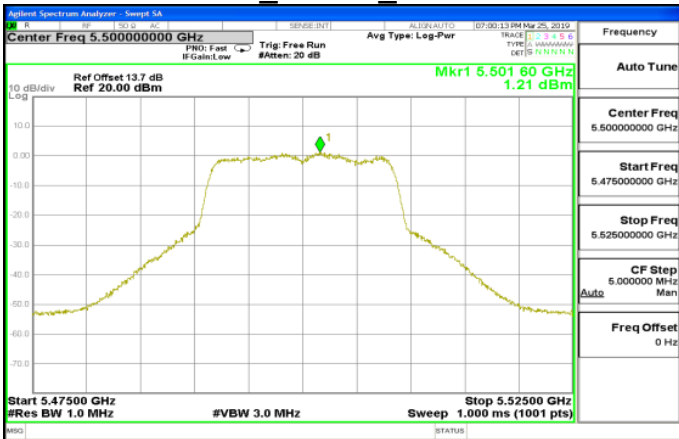

802.11a 20MHz 5720MHz



802.11a 20MHz 5580MHz

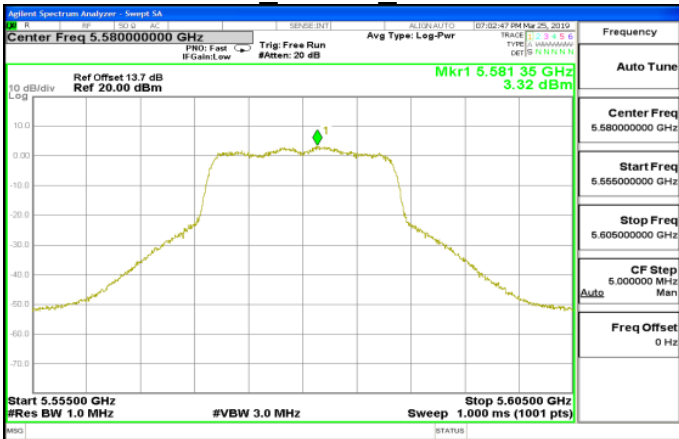

802.11a 20MHz 5745MHz

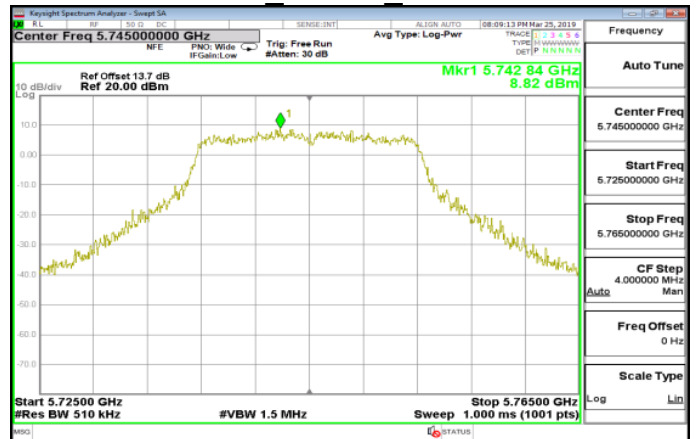

802.11a 20MHz 5700MHz

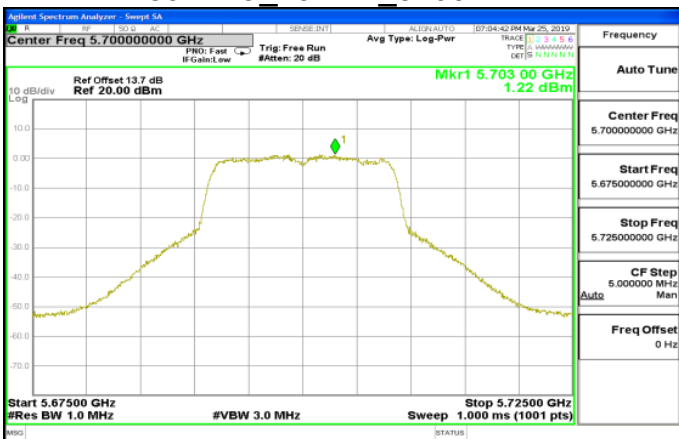

802.11a 20MHz 5785MHz

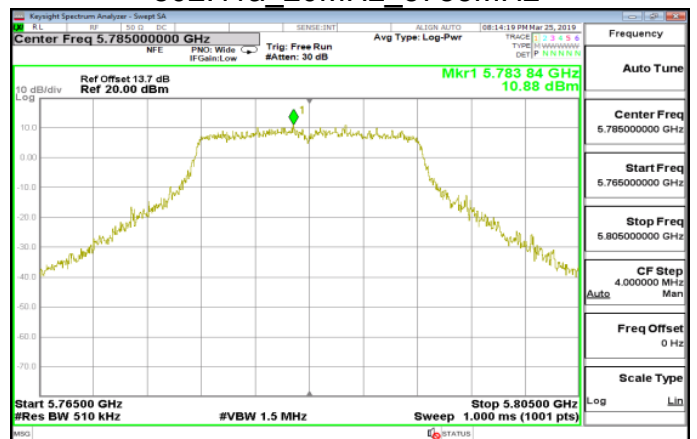

Unless otherwise stated the results shown in this test report refer only to the sample(s) tested and such sample(s) are retained for 90 days only.

除非另有說明，此報告結果僅對測試之樣品負責，同時此樣品僅保留90天。本報告未經本公司書面許可，不可部份複製。

This document is issued by the Company subject to its General Conditions of Service printed overleaf, available on request or accessible at www.sgs.com/terms_and_conditions.htm and for electronic format documents, subject to Terms and Conditions for Electronic Documents at www.sgs.com/terms_e-document.htm. Attention is drawn to the limitation of liability, indemnification and jurisdiction issues defined therein. Any holder of this document is advised that information contained hereon reflects the Company's findings at the time of its intervention only and within the limits of Client's instructions, if any. The Company's sole responsibility is to its Client and this document does not exonerate parties to a transaction from exercising all their rights and obligations under the transaction documents. This document cannot be reproduced except in full, without prior written approval of the Company. Any unauthorized alteration, forgery or falsification of the content or appearance of this document is unlawful and offenders may be prosecuted to the fullest extent of the law.

802.11a 20MHz 5825MHz

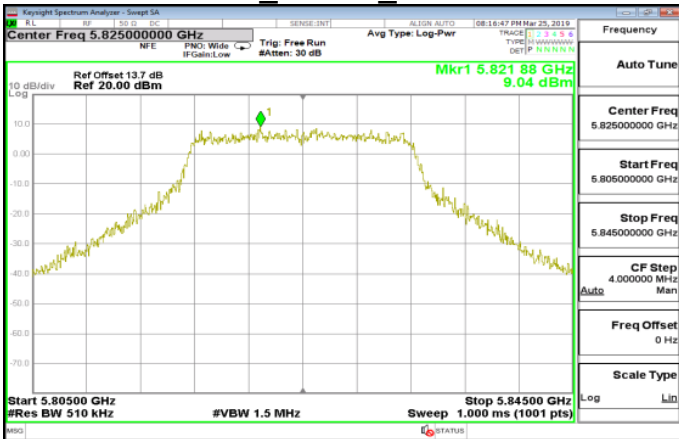

802.11n 20MHz 5180MHz



802.11n 20MHz 5220MHz



802.11n 20MHz 5240MHz

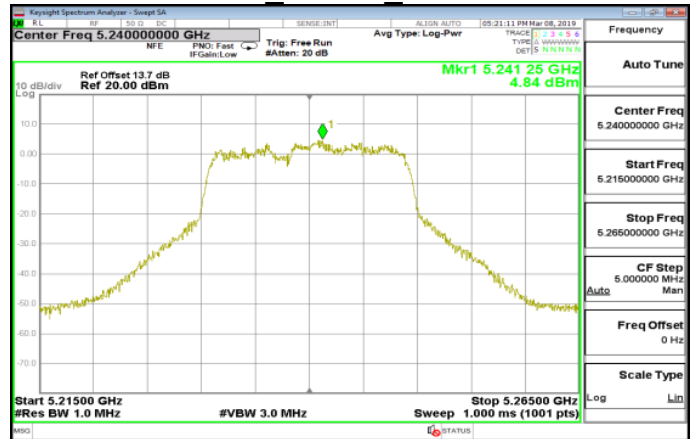

Unless otherwise stated the results shown in this test report refer only to the sample(s) tested and such sample(s) are retained for 90 days only.

除非另有說明，此報告結果僅對測試之樣品負責，同時此樣品僅保留90天。本報告未經本公司書面許可，不可部份複製。

This document is issued by the Company subject to its General Conditions of Service printed overleaf, available on request or accessible at www.sgs.com/terms_and_conditions.htm and for electronic format documents, subject to Terms and Conditions for Electronic Documents at www.sgs.com/terms_e-document.htm. Attention is drawn to the limitation of liability, indemnification and jurisdiction issues defined therein. Any holder of this document is advised that information contained hereon reflects the Company's findings at the time of its intervention only and within the limits of Client's instructions, if any. The Company's sole responsibility is to its Client and this document does not exonerate parties to a transaction from exercising all their rights and obligations under the transaction documents. This document cannot be reproduced except in full, without prior written approval of the Company. Any unauthorized alteration, forgery or falsification of the content or appearance of this document is unlawful and offenders may be prosecuted to the fullest extent of the law.

802.11n 20MHz 5260MHz

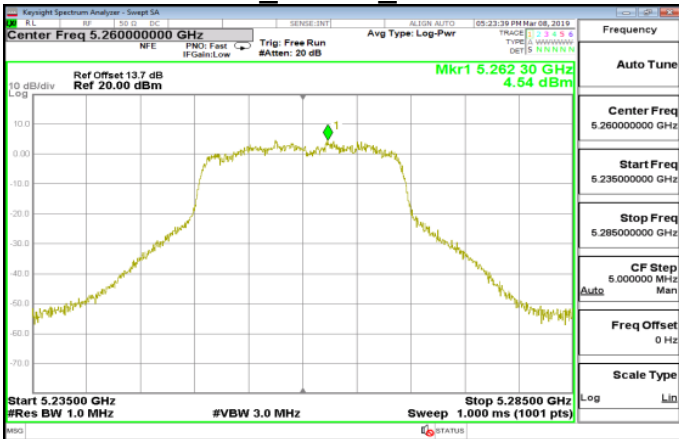

802.11n 20MHz 5500MHz



802.11n 20MHz 5300MHz

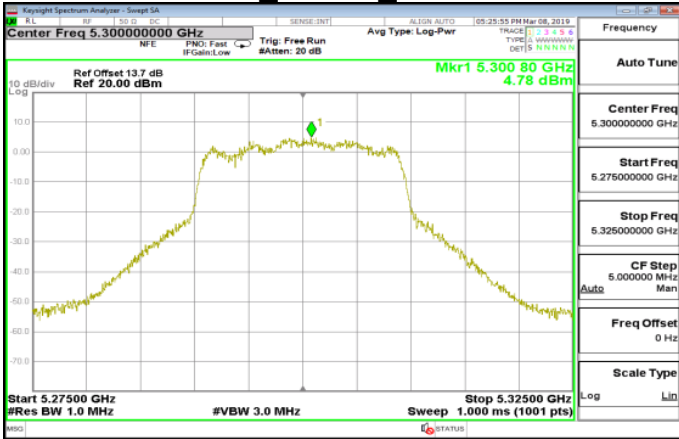

802.11n 20MHz 5580MHz



802.11n 20MHz 5320MHz



802.11n 20MHz 5700MHz



Unless otherwise stated the results shown in this test report refer only to the sample(s) tested and such sample(s) are retained for 90 days only.

除非另有說明，此報告結果僅對測試之樣品負責，同時此樣品僅保留90天。本報告未經本公司書面許可，不可部份複製。

This document is issued by the Company subject to its General Conditions of Service printed overleaf, available on request or accessible at www.sgs.com/terms_and_conditions.htm and for electronic format documents, subject to Terms and Conditions for Electronic Documents at www.sgs.com/terms_e-document.htm. Attention is drawn to the limitation of liability, indemnification and jurisdiction issues defined therein. Any holder of this document is advised that information contained hereon reflects the Company's findings at the time of its intervention only and within the limits of Client's instructions, if any. The Company's sole responsibility is to its Client and this document does not exonerate parties to a transaction from exercising all their rights and obligations under the transaction documents. This document cannot be reproduced except in full, without prior written approval of the Company. Any unauthorized alteration, forgery or falsification of the content or appearance of this document is unlawful and offenders may be prosecuted to the fullest extent of the law.

802.11n 20MHz 5720MHz

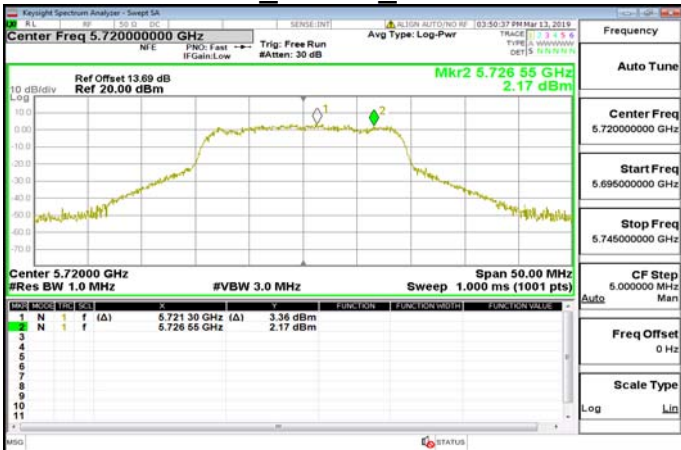

802.11n 20MHz 5825MHz

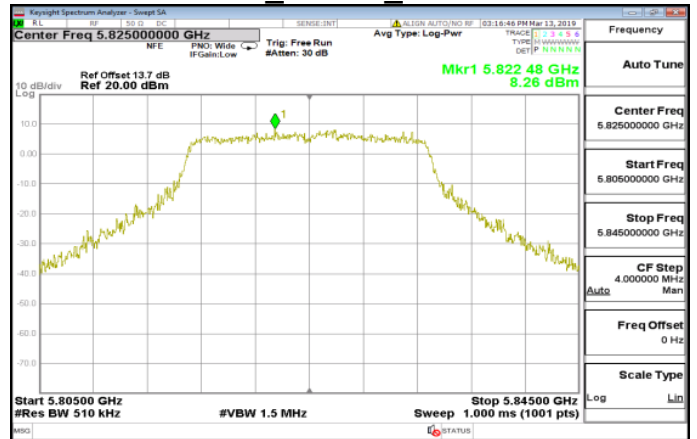

802.11n 20MHz 5745MHz

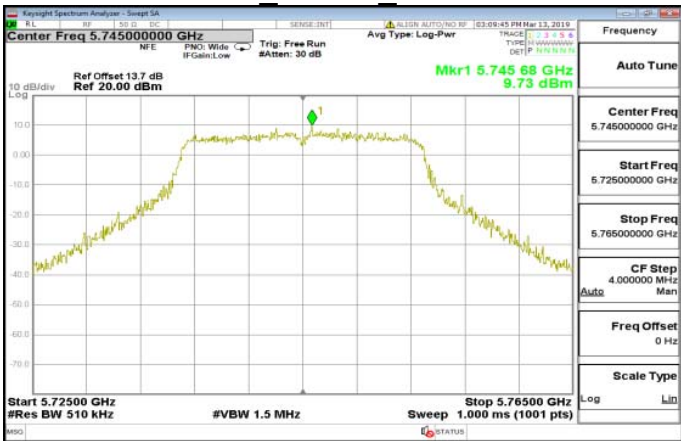

802.11n 20MHz 5785MHz

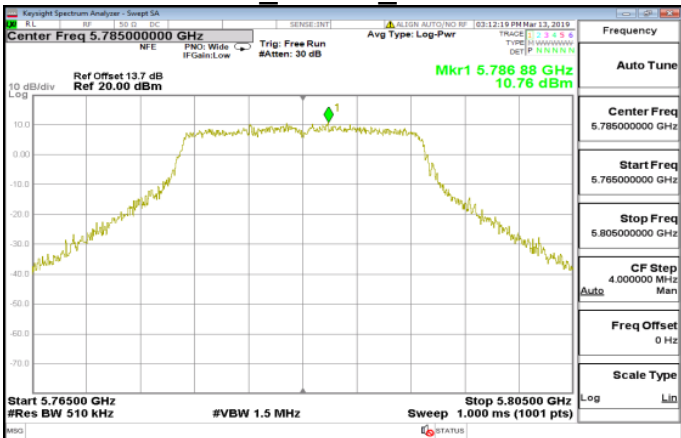

Unless otherwise stated the results shown in this test report refer only to the sample(s) tested and such sample(s) are retained for 90 days only.

除非另有說明，此報告結果僅對測試之樣品負責，同時此樣品僅保留90天。本報告未經本公司書面許可，不可部份複製。

This document is issued by the Company subject to its General Conditions of Service printed overleaf, available on request or accessible at www.sgs.com/terms_and_conditions.htm and for electronic format documents, subject to Terms and Conditions for Electronic Documents at www.sgs.com/terms_e-document.htm. Attention is drawn to the limitation of liability, indemnification and jurisdiction issues defined therein. Any holder of this document is advised that information contained hereon reflects the Company's findings at the time of its intervention only and within the limits of Client's instructions, if any. The Company's sole responsibility is to its Client and this document does not exonerate parties to a transaction from exercising all their rights and obligations under the transaction documents. This document cannot be reproduced except in full, without prior written approval of the Company. Any unauthorized alteration, forgery or falsification of the content or appearance of this document is unlawful and offenders may be prosecuted to the fullest extent of the law.

802.11n_40MHz_5190MHz

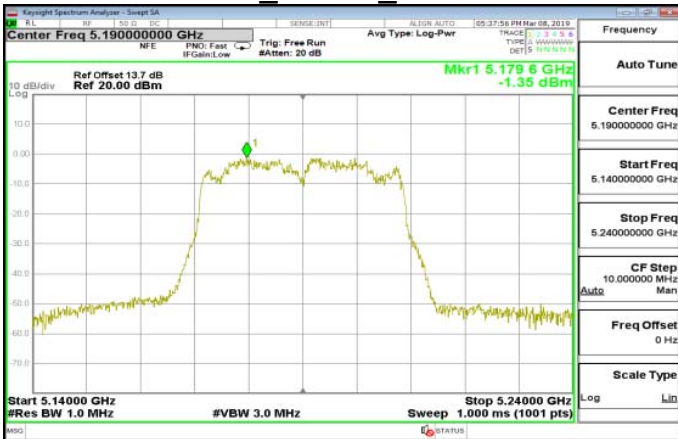

802.11n_40MHz_5310MHz

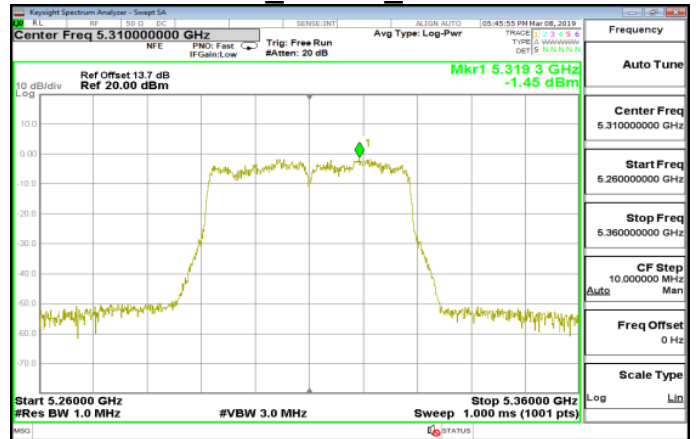

802.11n_40MHz_5230MHz

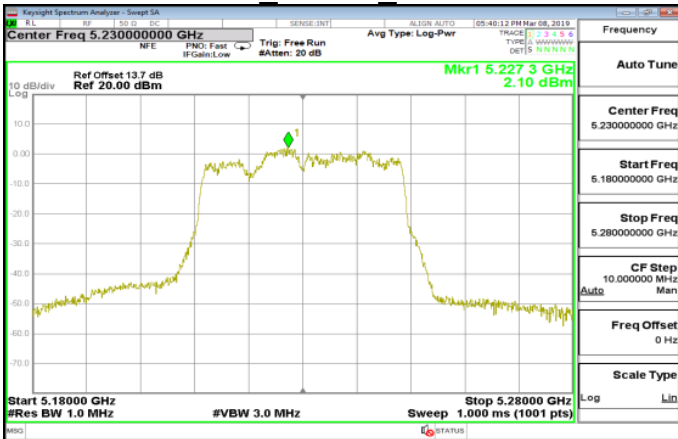

802.11n_40MHz_5510MHz

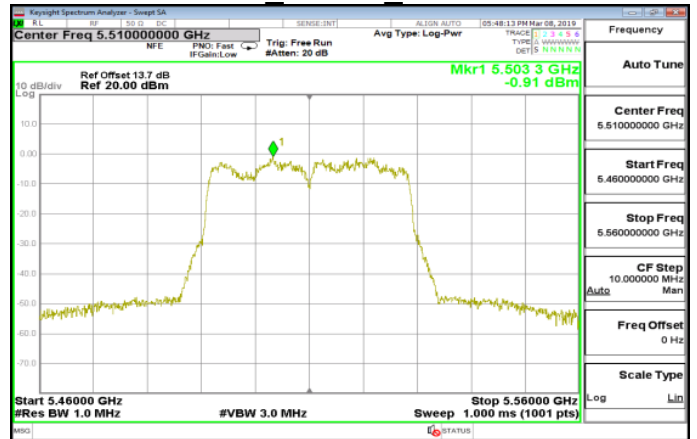

802.11n_40MHz_5270MHz

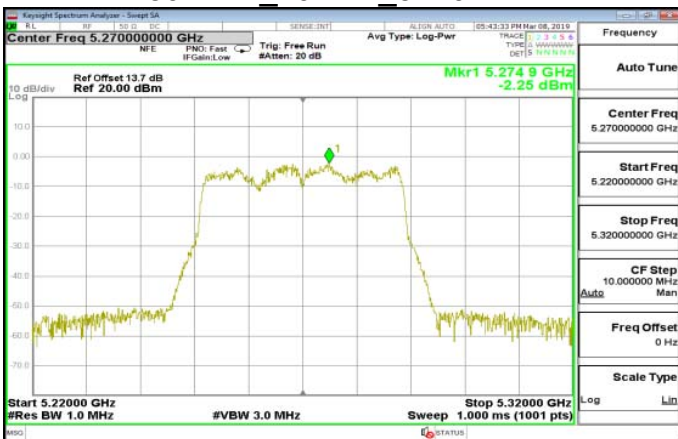

802.11n_40MHz_5550MHz

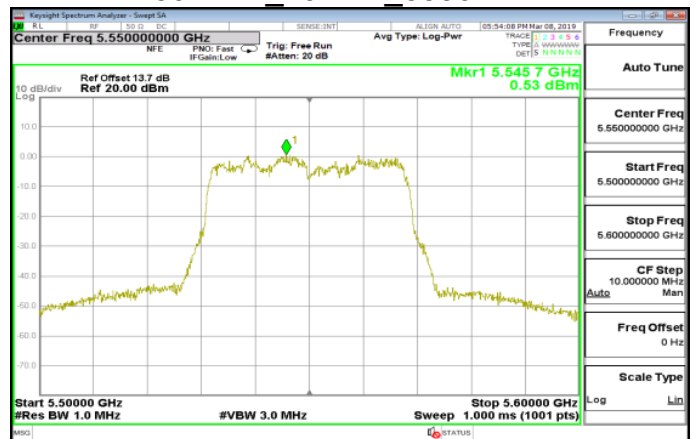

Unless otherwise stated the results shown in this test report refer only to the sample(s) tested and such sample(s) are retained for 90 days only.

除非另有說明，此報告結果僅對測試之樣品負責，同時此樣品僅保留90天。本報告未經本公司書面許可，不可部份複製。

This document is issued by the Company subject to its General Conditions of Service printed overleaf, available on request or accessible at www.sgs.com/terms_and_conditions.htm and for electronic format documents, subject to Terms and Conditions for Electronic Documents at www.sgs.com/terms_e-document.htm. Attention is drawn to the limitation of liability, indemnification and jurisdiction issues defined therein. Any holder of this document is advised that information contained hereon reflects the Company's findings at the time of its intervention only and within the limits of Client's instructions, if any. The Company's sole responsibility is to its Client and this document does not exonerate parties to a transaction from exercising all their rights and obligations under the transaction documents. This document cannot be reproduced except in full, without prior written approval of the Company. Any unauthorized alteration, forgery or falsification of the content or appearance of this document is unlawful and offenders may be prosecuted to the fullest extent of the law.

802.11n 40MHz 5670MHz



802.11n 40MHz 5795MHz



802.11n 40MHz 5710MHz

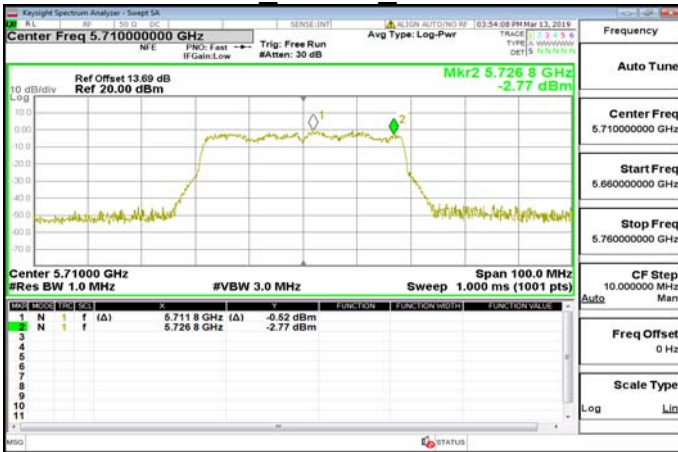

802.11ac 80MHz 5210MHz

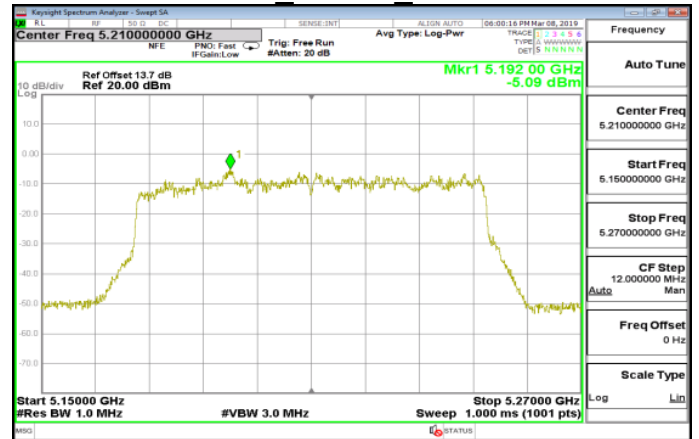

802.11n 40MHz 5755MHz



802.11ac 80MHz 5290MHz



Unless otherwise stated the results shown in this test report refer only to the sample(s) tested and such sample(s) are retained for 90 days only.

除非另有說明，此報告結果僅對測試之樣品負責，同時此樣品僅保留90天。本報告未經本公司書面許可，不可部份複製。

This document is issued by the Company subject to its General Conditions of Service printed overleaf, available on request or accessible at www.sgs.com/terms_and_conditions.htm and for electronic format documents, subject to Terms and Conditions for Electronic Documents at www.sgs.com/terms_e-document.htm. Attention is drawn to the limitation of liability, indemnification and jurisdiction issues defined therein. Any holder of this document is advised that information contained hereon reflects the Company's findings at the time of its intervention only and within the limits of Client's instructions, if any. The Company's sole responsibility is to its Client and this document does not exonerate parties to a transaction from exercising all their rights and obligations under the transaction documents. This document cannot be reproduced except in full, without prior written approval of the Company. Any unauthorized alteration, forgery or falsification of the content or appearance of this document is unlawful and offenders may be prosecuted to the fullest extent of the law.

802.11ac 80MHz 5530MHz



802.11ac 80MHz 5775MHz

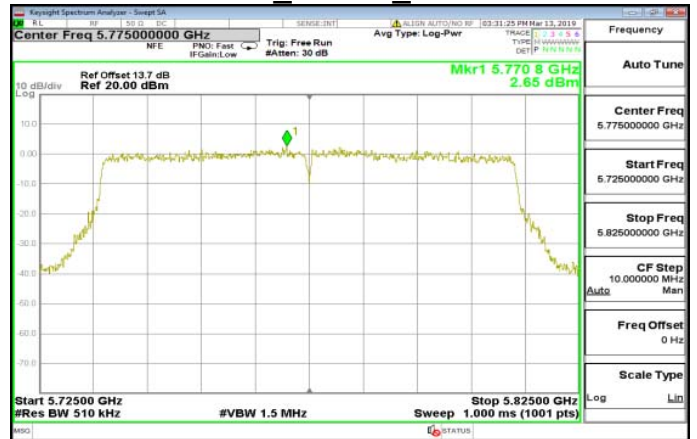

802.11ac 80MHz 5610MHz



802.11ac 80MHz 5690MHz

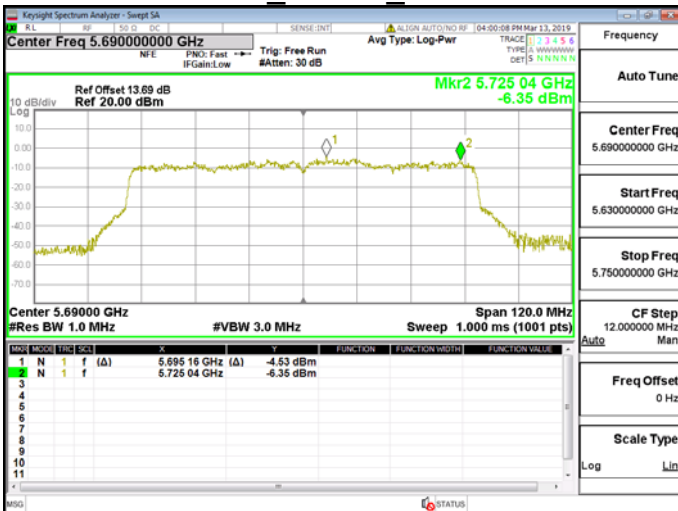

Unless otherwise stated the results shown in this test report refer only to the sample(s) tested and such sample(s) are retained for 90 days only.

除非另有說明，此報告結果僅對測試之樣品負責，同時此樣品僅保留90天。本報告未經本公司書面許可，不可部份複製。

This document is issued by the Company subject to its General Conditions of Service printed overleaf, available on request or accessible at www.sgs.com/terms_and_conditions.htm and for electronic format documents, subject to Terms and Conditions for Electronic Documents at www.sgs.com/terms_e-document.htm. Attention is drawn to the limitation of liability, indemnification and jurisdiction issues defined therein. Any holder of this document is advised that information contained hereon reflects the Company's findings at the time of its intervention only and within the limits of Client's instructions, if any. The Company's sole responsibility is to its Client and this document does not exonerate parties to a transaction from exercising all their rights and obligations under the transaction documents. This document cannot be reproduced except in full, without prior written approval of the Company. Any unauthorized alteration, forgery or falsification of the content or appearance of this document is unlawful and offenders may be prosecuted to the fullest extent of the law.

11. UNDESIRABLE RADIATED EMISSION MEASUREMENT

11.1 Standard Applicable

The maximum emissions outside of the frequency bands of operation shall be attenuated in accordance with the following limits:

1. For transmitters operating in the 5.15-5.25 GHz band: All emissions outside of the 5.15-5.35 GHz band shall not exceed an e.i.r.p. of -27 dBm/MHz.
2. For transmitters operating in the 5.725-5.85 GHz band: All emissions shall be limited to a level of -27 dBm/MHz at 75 MHz or more above or below the band edge increasing linearly to 10 dBm/MHz at 25 MHz above or below the band edge, and from 25 MHz above or below the band edge increasing linearly to a level of 15.6 dBm/MHz at 5 MHz above or below the band edge, and from 5 MHz above or below the band edge increasing linearly to a level of 27 dBm/MHz at the band edge.

APPLICABLE TO	LIMIT	
FCC KDB 789033 D02 General UNII Test Procedures New Rules	FIELD STRENGTH AT 3m	
	PK: 74 (dBµV/m)	AV 54 (dBµV/m)
APPLICABLE TO	EIRP LIMIT	FIELD STRENGTH AT 3m
15.407(b)(1)	PK: -27 (dBm/MHz)	PK: 68.3 (dBµV/m)
15.407(b)(2)		
15.407(b)(3)		
15.407(b)(4)(i)	PK:-27 (dBm/MHz) *1 PK:10 (dBm/MHz) *2 PK:15.6 (dBm/MHz) *3 PK:27 (dBm/MHz) *4	PK: 68.2(dBµV/m) *1 PK:105.2 (dBµV/m) *2 PK: 110.8(dBµV/m) *3 PK:122.2 (dBµV/m) *4
<p>*1 beyond 75 MHz or more above of the bandedge. *2 below the band edge increasing linearly to 10 dBm/MHz at 25 MHz above. *3 below the band edge increasing linearly to a level of 15.6 dBm/MHz at 5 MHz above. *4 from 5 MHz above or below the band edge increasing linearly to a level of 27 dBm/MHz at the band edge.</p>		

$EIRP = (E \cdot d)^2 / 30$, where E is the field in V/m, d is the measurement distance (3m),
EIRP is the equivalent isotropically radiated power in Watts.

Unwanted spurious emissions which fall in the restricted bands must comply with the radiated emission limits specified as below table:

Unless otherwise stated the results shown in this test report refer only to the sample(s) tested and such sample(s) are retained for 90 days only.

除非另有說明，此報告結果僅對測試之樣品負責，同時此樣品僅保留90天。本報告未經本公司書面許可，不可部份複製。

This document is issued by the Company subject to its General Conditions of Service printed overleaf, available on request or accessible at www.sgs.com/terms_and_conditions.htm and for electronic format documents, subject to Terms and Conditions for Electronic Documents at www.sgs.com/terms_e-document.htm. Attention is drawn to the limitation of liability, indemnification and jurisdiction issues defined therein. Any holder of this document is advised that information contained hereon reflects the Company's findings at the time of its intervention only and within the limits of Client's instructions, if any. The Company's sole responsibility is to its Client and this document does not exonerate parties to a transaction from exercising all their rights and obligations under the transaction documents. This document cannot be reproduced except in full, without prior written approval of the Company. Any unauthorized alteration, forgery or falsification of the content or appearance of this document is unlawful and offenders may be prosecuted to the fullest extent of the law.

Frequency (MHz)	Field strength (microvolts/meter)	Distance (meters)
0.009-0.490	2400/F(KHz)	300
0.490-1.705	24000/F(KHz)	30
1.705-30	30	30
30-88	100	3
88-216	150	3
216-960	200	3
Above 960	500	3

Note:

1. The lower limit shall apply at the transition frequencies.
2. Emission level (dB μ V/m) = 20 log Emission level (dB μ V/m)

11.2 Measurement Equipment Used

966A Chamber					
EQUIPMENT TYPE	MFR	MODEL NUMBER	SERIAL NUMBER	LAST CAL.	CAL DUE.
Bilog Antenna	Sunol Sciences	JB3	A030105	07/13/2018	07/12/2019
Cable	HUBER SU-HNER	SUCOFLEX 104PEA	25157	02/26/2019	02/25/2020
Cable	HUBER SU-HNER	SUCOFLEX 104PEA	20995	02/26/2019	02/25/2020
Digital Thermo-Hygro Meter	WISEWIND	1206	D07	01/30/2019	01/29/2020
double Ridged Guide Horn Antenna	ETC	MCTD 1209	DRH13M02003	08/20/2018	08/19/2019
High Pass Filter	WI	WHKX7.0/18G-8SS	45	02/26/2019	02/25/2020
Horn Antenna	ETS LINDGREN	3116	00026370	12/26/2018	12/25/2019
Loop Antenna	ETS.LINDGREN	6502	148045	10/08/2018	10/07/2019
Pre-Amplifier	EMEC	EM330	060609	02/26/2019	02/25/2020
Pre-Amplifier	MITEQ	AMF-6F-26040 0-40-8P	985646	02/26/2019	02/25/2020
Pre-Amplifier	HP	8449B	3008A00965	02/26/2019	02/25/2020
PSA Series Spectrum Analyzer	Agilent	E4446A	MY46180323	05/31/2018	05/30/2019
Antenna Tower	CCS	CC-A-1F	N/A	N.C.R	N.C.R
Controller	CCS	CC-C-1F	N/A	N.C.R	N.C.R
Turn Table	CCS	CC-T-1F	N/A	N.C.R	N.C.R
Software	e3 V6.11-20180413				

NOTE: N.C.R refers to Not Calibrated Required.

Unless otherwise stated the results shown in this test report refer only to the sample(s) tested and such sample(s) are retained for 90 days only.

除非另有說明，此報告結果僅對測試之樣品負責，同時此樣品僅保留90天。本報告未經本公司書面許可，不可部份複製。

This document is issued by the Company subject to its General Conditions of Service printed overleaf, available on request or accessible at www.sgs.com/terms_and_conditions.htm and for electronic format documents, subject to Terms and Conditions for Electronic Documents at www.sgs.com/terms_e-document.htm. Attention is drawn to the limitation of liability, indemnification and jurisdiction issues defined therein. Any holder of this document is advised that information contained hereon reflects the Company's findings at the time of its intervention only and within the limits of Client's instructions, if any. The Company's sole responsibility is to its Client and this document does not exonerate parties to a transaction from exercising all their rights and obligations under the transaction documents. This document cannot be reproduced except in full, without prior written approval of the Company. Any unauthorized alteration, forgery or falsification of the content or appearance of this document is unlawful and offenders may be prosecuted to the fullest extent of the law.

11.3 Test SET-UP

(A) Radiated Emission Test Set-UP Frequency Below 30MHz.

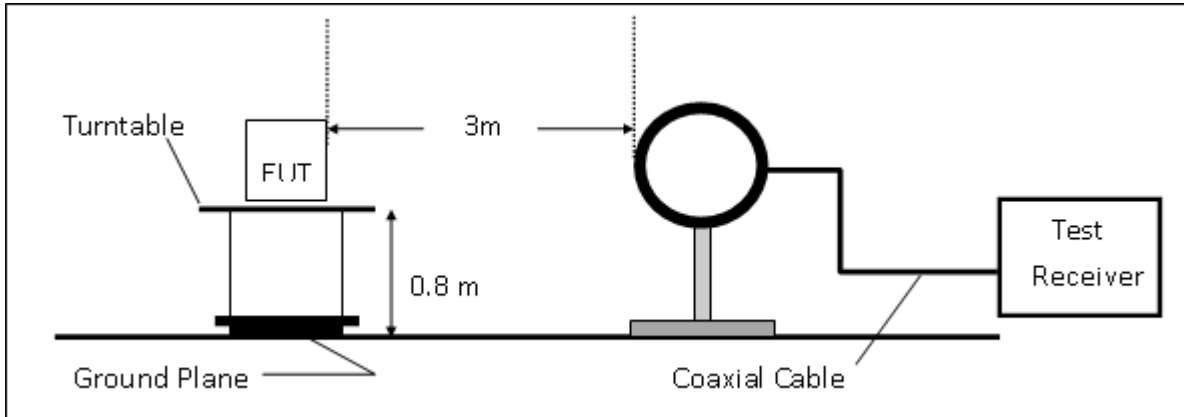

(B) Radiated Emission Test Set-UP, Frequency form 30MHz to 1000MHz

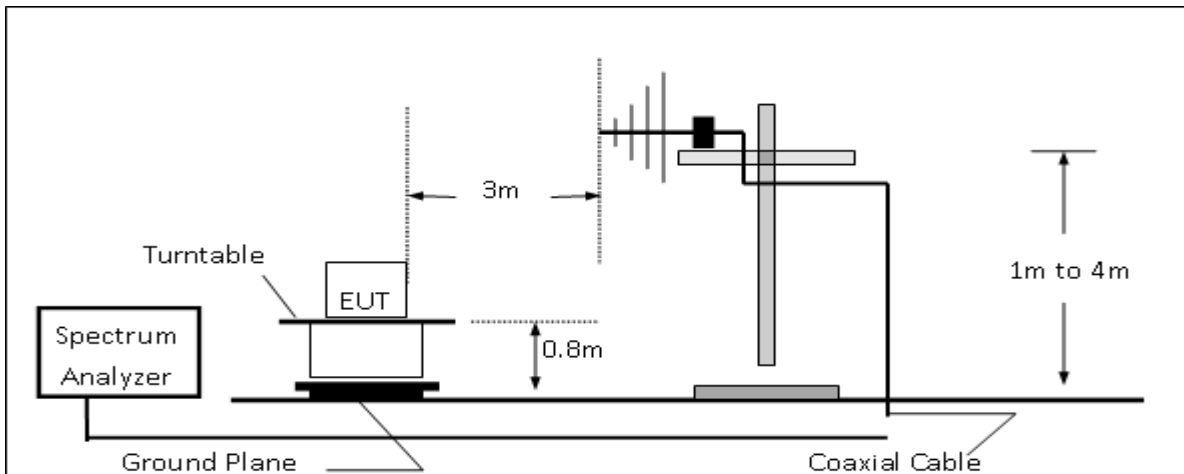

(C) Radiated Emission Test Set-UP Frequency Over 1 GHz

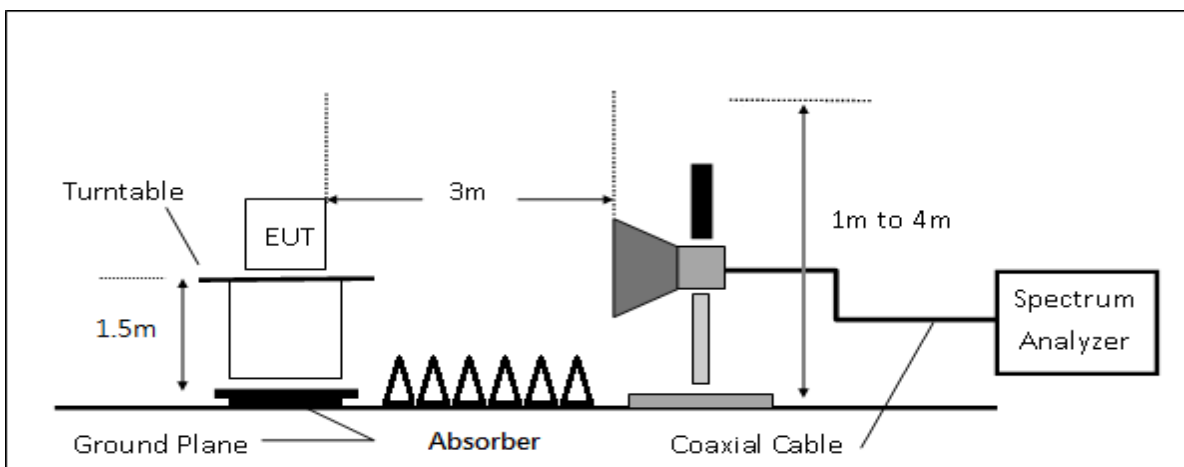

Unless otherwise stated the results shown in this test report refer only to the sample(s) tested and such sample(s) are retained for 90 days only.

除非另有說明，此報告結果僅對測試之樣品負責，同時此樣品僅保留90天。本報告未經本公司書面許可，不可部份複製。

This document is issued by the Company subject to its General Conditions of Service printed overleaf, available on request or accessible at www.sgs.com/terms_and_conditions.htm and for electronic format documents, subject to Terms and Conditions for Electronic Documents at www.sgs.com/terms_e-document.htm. Attention is drawn to the limitation of liability, indemnification and jurisdiction issues defined therein. Any holder of this document is advised that information contained hereon reflects the Company's findings at the time of its intervention only and within the limits of Client's instructions, if any. The Company's sole responsibility is to its Client and this document does not exonerate parties to a transaction from exercising all their rights and obligations under the transaction documents. This document cannot be reproduced except in full, without prior written approval of the Company. Any unauthorized alteration, forgery or falsification of the content or appearance of this document is unlawful and offenders may be prosecuted to the fullest extent of the law.

11.4 Measurement Procedure

1. The EUT was placed on a turn table which is 0.8m above ground plane.
2. The testing follows FCC KDB 789033 D02 General UNII Test Procedures New Rules.
3. The EUT was placed on a turn table with 0.8m for frequency < 1GHz and 1.5m for frequency > 1GHz above ground plane.
4. The turn table shall rotate 360 degrees to determine the position of maximum emission level.
5. EUT is set 3m away from the receiving antenna which varied from 1m to 4m to find out the highest emissions.
6. Set the spectrum analyzer as RBW=120 kHz and VBW=300 kHz for Peak Detector (PK) and Quasi-peak (QP) at frequency below 1 GHz.
7. Set the spectrum analyzer as RBW=1 MHz, VBW=3 MHz for Peak Detector at frequency above 1 GHz.
8. Set the spectrum analyzer as RBW=1 MHz, VBW=10 Hz (Duty cycle > 98%) or VBW ≥ 1/T (Duty cycle < 98%) for Average Detector at frequency above 1 GHz.
9. Maximum procedure was performed on the six highest emissions to ensure EUT compliance.
10. And also, each emission was to be maximized by changing the polarization of receiving antenna both horizontal and vertical.
11. Repeat above procedures until all frequency measured were complete.

11.5 Field Strength Calculation

The field strength is calculated by adding the Antenna Factor and Cable Factor and subtracting the Amplifier Gain and Duty Cycle Correction Factor (if any) from the measured reading. The basic equation with a sample calculation is as follows:

$$FS = RA + AF + CL - AG$$

Where	FS = Field Strength	CL = Cable Attenuation Factor (Cable Loss)
	RA = Reading Amplitude	AG = Amplifier Gain
	AF = Antenna Factor	

Actual FS(dBµV/m) = SPA. Reading level(dBµV) + Factor(dB)

Factor(dB) = Antenna Factor(dBµV/m) + Cable Loss(dB) – Pre_Amplifier Gain(dB)

11.6 Test Results of Radiated Spurious Emissions form 9 kHz to 30 MHz

The low frequency, which started from 9 kHz to 30MHz, was pre-scanned and the result which was 20dB lower than the limit per 15.31(o) was not reported.

Unless otherwise stated the results shown in this test report refer only to the sample(s) tested and such sample(s) are retained for 90 days only.

除非另有說明，此報告結果僅對測試之樣品負責，同時此樣品僅保留90天。本報告未經本公司書面許可，不可部份複製。

This document is issued by the Company subject to its General Conditions of Service printed overleaf, available on request or accessible at www.sgs.com/terms_and_conditions.htm and for electronic format documents, subject to Terms and Conditions for Electronic Documents at www.sgs.com/terms_e-document.htm. Attention is drawn to the limitation of liability, indemnification and jurisdiction issues defined therein. Any holder of this document is advised that information contained hereon reflects the Company's findings at the time of its intervention only and within the limits of Client's instructions, if any. The Company's sole responsibility is to its Client and this document does not exonerate parties to a transaction from exercising all their rights and obligations under the transaction documents. This document cannot be reproduced except in full, without prior written approval of the Company. Any unauthorized alteration, forgery or falsification of the content or appearance of this document is unlawful and offenders may be prosecuted to the fullest extent of the law.

11.7 Measurement Result

Radiated Spurious Emission Measurement Result

Below 1GHz Worst-Case Data:

802.11a 5150~5250 MHz

Operation Band :802.11aB1
Fundamental Frequency :5220 MHz
Operation Mode :Tx CH MID
EUT Pol. :E1 Plan

Test Date :2019-03-09
Temp./Humi. :20 deg_C / 61 RH
Engineer :Wei
Measurement Antenna Pol. :VERTICAL

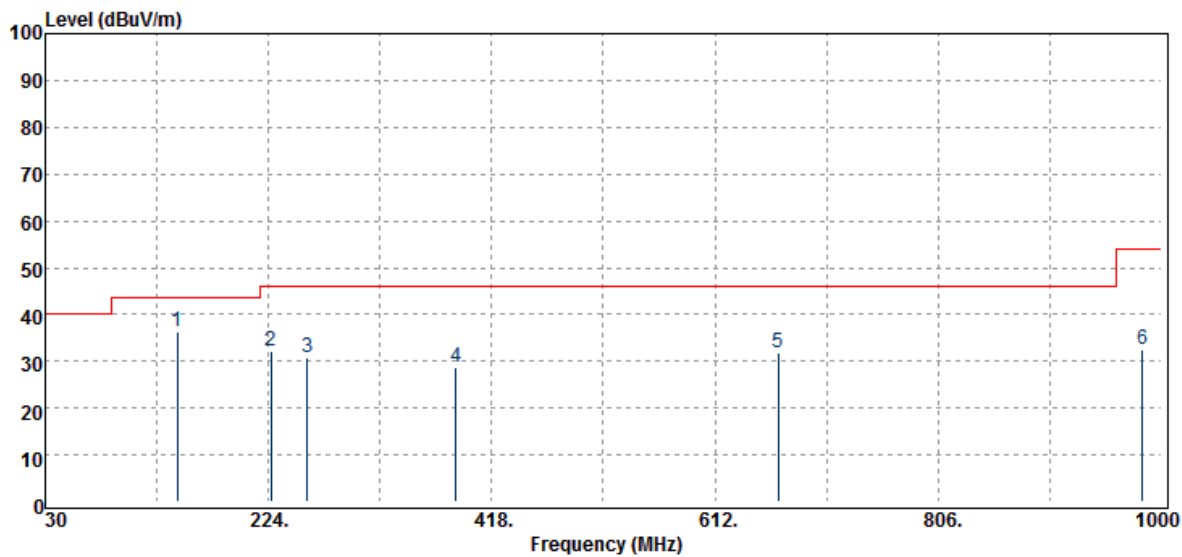

Freq. MHz	Detector Mode PK/QP/AV	Spectrum Reading Level dBuV	Factor dB	Actual FS dBuV/m	Limit @3m dBuV/m	Margin dB
144.46	Peak	45.73	-9.32	36.41	43.50	-7.09
225.94	Peak	42.59	-10.38	32.21	46.00	-13.79
257.95	Peak	40.11	-9.31	30.80	46.00	-15.20
386.96	Peak	34.17	-5.33	28.84	46.00	-17.16
667.29	Peak	30.86	1.04	31.90	46.00	-14.10
983.51	Peak	25.99	6.49	32.48	54.00	-21.52

Unless otherwise stated the results shown in this test report refer only to the sample(s) tested and such sample(s) are retained for 90 days only.

除非另有說明，此報告結果僅對測試之樣品負責，同時此樣品僅保留90天。本報告未經本公司書面許可，不可部份複製。

This document is issued by the Company subject to its General Conditions of Service printed overleaf, available on request or accessible at www.sgs.com/terms_and_conditions.htm and for electronic format documents, subject to Terms and Conditions for Electronic Documents at www.sgs.com/terms_e-document.htm. Attention is drawn to the limitation of liability, indemnification and jurisdiction issues defined therein. Any holder of this document is advised that information contained hereon reflects the Company's findings at the time of its intervention only and within the limits of Client's instructions, if any. The Company's sole responsibility is to its Client and this document does not exonerate parties to a transaction from exercising all their rights and obligations under the transaction documents. This document cannot be reproduced except in full, without prior written approval of the Company. Any unauthorized alteration, forgery or falsification of the content or appearance of this document is unlawful and offenders may be prosecuted to the fullest extent of the law.

Operation Band :802.11aB1
Fundamental Frequency :5220 MHz
Operation Mode :Tx CH MID
EUT Pol. :E1 Plan

Test Date :2019-03-09
Temp./Humi. :20 deg_C / 61 RH
Engineer :Wei
Measurement Antenna Pol. :HORIZONTAL

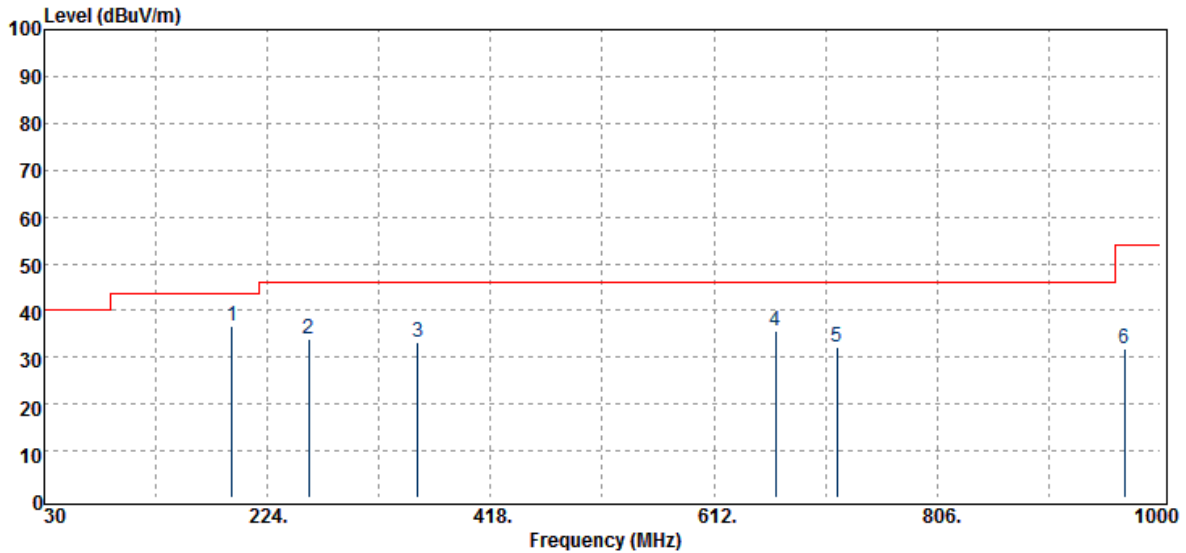

Freq. MHz	Detector Mode PK/QP/AV	Spectrum Reading Level dB μ V	Factor dB	Actual FS dB μ V/m	Limit @3m dB μ V/m	Margin dB
192.96	Peak	46.38	-9.82	36.56	43.50	-6.94
259.89	Peak	42.83	-9.09	33.74	46.00	-12.26
354.95	Peak	39.13	-5.94	33.19	46.00	-12.81
665.35	Peak	34.60	0.94	35.54	46.00	-10.46
718.70	Peak	31.07	1.28	32.35	46.00	-13.65
968.96	Peak	25.27	6.55	31.82	54.00	-22.18

Unless otherwise stated the results shown in this test report refer only to the sample(s) tested and such sample(s) are retained for 90 days only.

除非另有說明，此報告結果僅對測試之樣品負責，同時此樣品僅保留90天。本報告未經本公司書面許可，不可部份複製。

This document is issued by the Company subject to its General Conditions of Service printed overleaf, available on request or accessible at www.sgs.com/terms_and_conditions.htm and for electronic format documents, subject to Terms and Conditions for Electronic Documents at www.sgs.com/terms_e-document.htm. Attention is drawn to the limitation of liability, indemnification and jurisdiction issues defined therein. Any holder of this document is advised that information contained hereon reflects the Company's findings at the time of its intervention only and within the limits of Client's instructions, if any. The Company's sole responsibility is to its Client and this document does not exonerate parties to a transaction from exercising all their rights and obligations under the transaction documents. This document cannot be reproduced except in full, without prior written approval of the Company. Any unauthorized alteration, forgery or falsification of the content or appearance of this document is unlawful and offenders may be prosecuted to the fullest extent of the law.

802.11a 5250~5350 MHz

Operation Band :802.11aB2
Fundamental Frequency :5300 MHz
Operation Mode :Tx CH MID
EUT Pol. :E1 Plan

Test Date :2019-03-09
Temp./Humi. :20 deg_C / 61 RH
Engineer :Wei
Measurement Antenna Pol. :VERTICAL

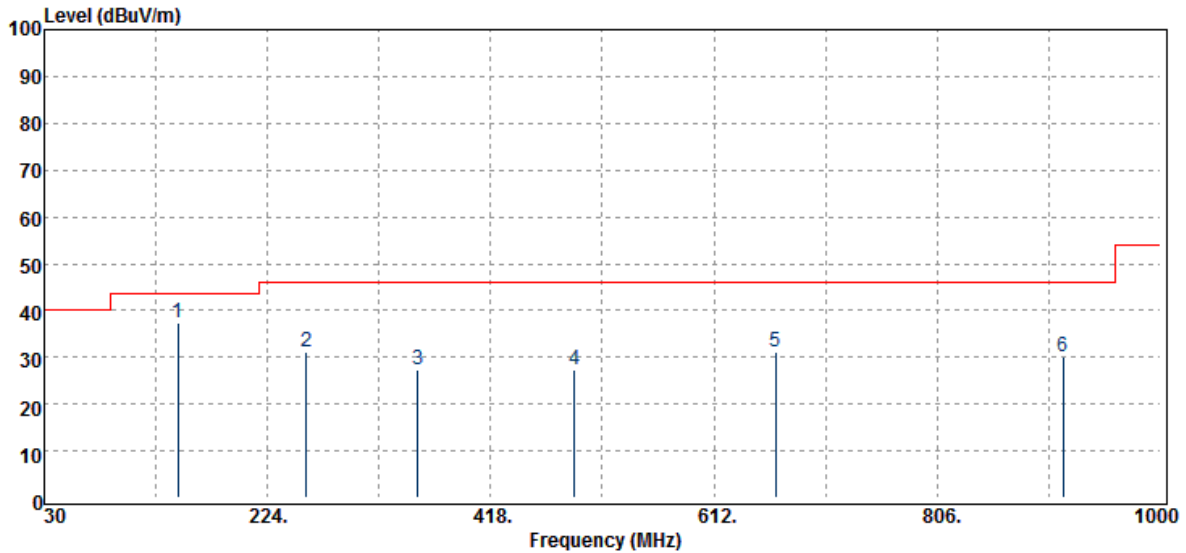

Freq. MHz	Detector Mode PK/QP/AV	Spectrum Reading Level dBuV	Factor dB	Actual FS dBuV/m	Limit @3m dBuV/m	Margin dB
146.40	Peak	46.79	-9.40	37.39	43.50	-6.11
257.95	Peak	40.30	-9.31	30.99	46.00	-15.01
354.95	Peak	33.39	-5.94	27.45	46.00	-18.55
490.75	Peak	29.69	-2.20	27.49	46.00	-18.51
665.35	Peak	30.35	0.94	31.29	46.00	-14.71
915.61	Peak	25.21	4.81	30.02	46.00	-15.98

Unless otherwise stated the results shown in this test report refer only to the sample(s) tested and such sample(s) are retained for 90 days only.

除非另有說明，此報告結果僅對測試之樣品負責，同時此樣品僅保留90天。本報告未經本公司書面許可，不可部份複製。

This document is issued by the Company subject to its General Conditions of Service printed overleaf, available on request or accessible at www.sgs.com/terms_and_conditions.htm and for electronic format documents, subject to Terms and Conditions for Electronic Documents at www.sgs.com/terms_e-document.htm. Attention is drawn to the limitation of liability, indemnification and jurisdiction issues defined therein. Any holder of this document is advised that information contained hereon reflects the Company's findings at the time of its intervention only and within the limits of Client's instructions, if any. The Company's sole responsibility is to its Client and this document does not exonerate parties to a transaction from exercising all their rights and obligations under the transaction documents. This document cannot be reproduced except in full, without prior written approval of the Company. Any unauthorized alteration, forgery or falsification of the content or appearance of this document is unlawful and offenders may be prosecuted to the fullest extent of the law.

Operation Band :802.11aB2
Fundamental Frequency :5300 MHz
Operation Mode :Tx CH MID
EUT Pol. :E1 Plan

Test Date :2019-03-09
Temp./Humi. :20 deg_C / 61 RH
Engineer :Wei
Measurement Antenna Pol. :HORIZONTAL

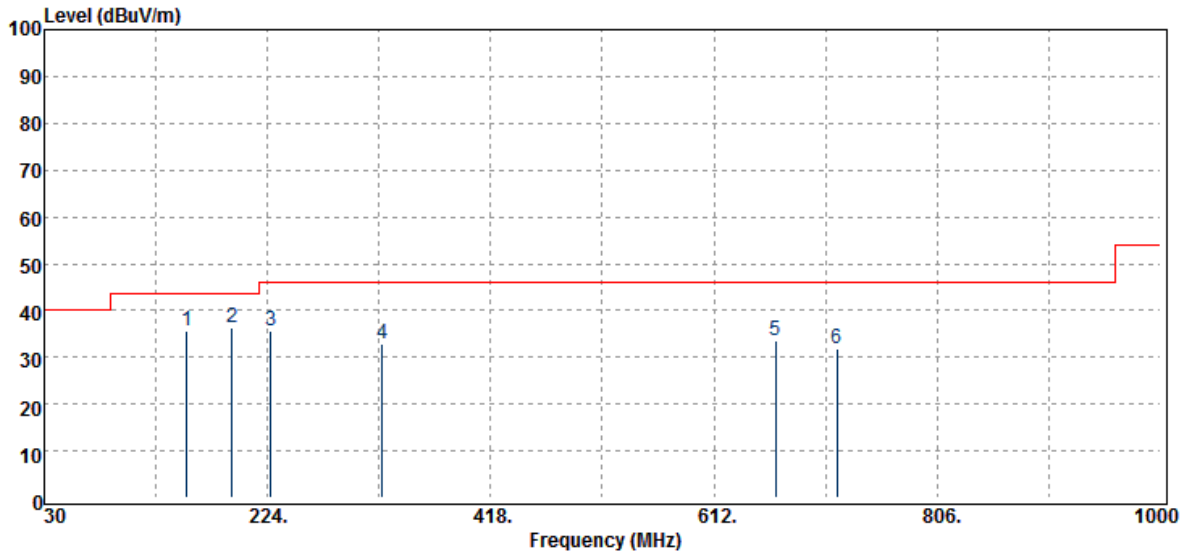

Freq. MHz	Detector Mode PK/QP/AV	Spectrum Reading Level dB μ V	Factor dB	Actual FS dB μ V/m	Limit @3m dB μ V/m	Margin dB
154.16	Peak	45.11	-9.41	35.70	43.50	-7.80
192.96	Peak	46.19	-9.82	36.37	43.50	-7.13
226.91	Peak	46.11	-10.31	35.80	46.00	-10.20
323.91	Peak	39.37	-6.59	32.78	46.00	-13.22
665.35	Peak	32.54	0.94	33.48	46.00	-12.52
718.70	Peak	30.60	1.28	31.88	46.00	-14.12

Unless otherwise stated the results shown in this test report refer only to the sample(s) tested and such sample(s) are retained for 90 days only.

除非另有說明，此報告結果僅對測試之樣品負責，同時此樣品僅保留90天。本報告未經本公司書面許可，不可部份複製。

This document is issued by the Company subject to its General Conditions of Service printed overleaf, available on request or accessible at www.sgs.com/terms_and_conditions.htm and for electronic format documents, subject to Terms and Conditions for Electronic Documents at www.sgs.com/terms_e-document.htm. Attention is drawn to the limitation of liability, indemnification and jurisdiction issues defined therein. Any holder of this document is advised that information contained hereon reflects the Company's findings at the time of its intervention only and within the limits of Client's instructions, if any. The Company's sole responsibility is to its Client and this document does not exonerate parties to a transaction from exercising all their rights and obligations under the transaction documents. This document cannot be reproduced except in full, without prior written approval of the Company. Any unauthorized alteration, forgery or falsification of the content or appearance of this document is unlawful and offenders may be prosecuted to the fullest extent of the law.

802.11a, 5470~5725 MHz

Operation Band :802.11aB3
Fundamental Frequency :5580 MHz
Operation Mode :Tx CH MID
EUT Pol. :E1 Plan

Test Date :2019-03-09
Temp./Humi. :20 deg_C / 61 RH
Engineer :Wei
Measurement Antenna Pol. :VERTICAL

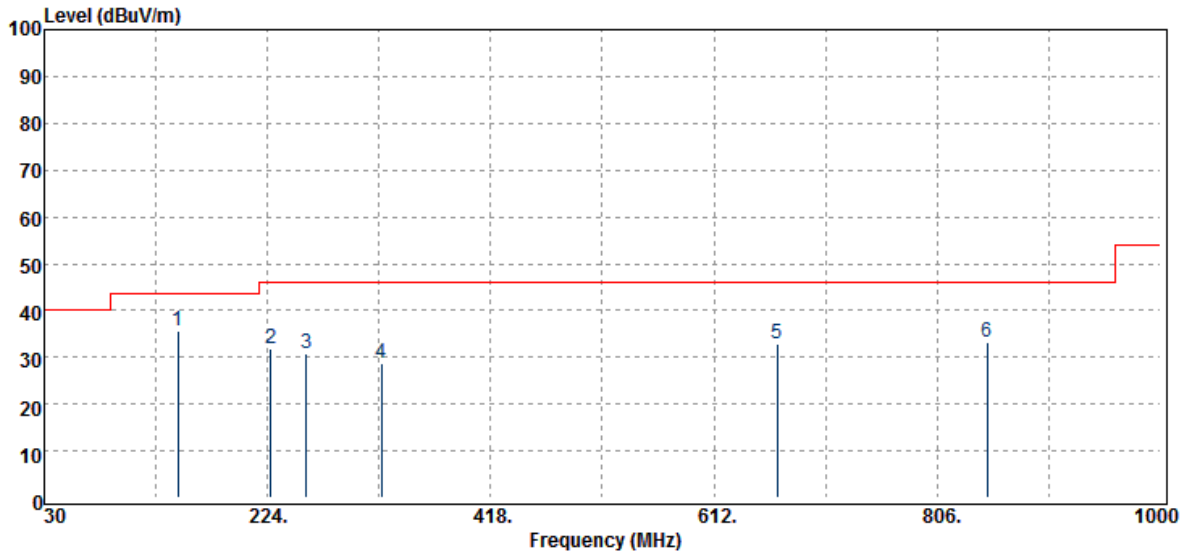

Freq. MHz	Detector Mode PK/QP/AV	Spectrum Reading Level dBuV	Factor dB	Actual FS dBuV/m	Limit @3m dBuV/m	Margin dB
146.40	Peak	45.16	-9.40	35.76	43.50	-7.74
226.91	Peak	42.12	-10.31	31.81	46.00	-14.19
257.95	Peak	39.93	-9.31	30.62	46.00	-15.38
322.94	Peak	35.51	-6.62	28.89	46.00	-17.11
667.29	Peak	31.71	1.04	32.75	46.00	-13.25
849.65	Peak	29.00	4.16	33.16	46.00	-12.84

Unless otherwise stated the results shown in this test report refer only to the sample(s) tested and such sample(s) are retained for 90 days only.

除非另有說明，此報告結果僅對測試之樣品負責，同時此樣品僅保留90天。本報告未經本公司書面許可，不可部份複製。

This document is issued by the Company subject to its General Conditions of Service printed overleaf, available on request or accessible at www.sgs.com/terms_and_conditions.htm and for electronic format documents, subject to Terms and Conditions for Electronic Documents at www.sgs.com/terms_e-document.htm. Attention is drawn to the limitation of liability, indemnification and jurisdiction issues defined therein. Any holder of this document is advised that information contained hereon reflects the Company's findings at the time of its intervention only and within the limits of Client's instructions, if any. The Company's sole responsibility is to its Client and this document does not exonerate parties to a transaction from exercising all their rights and obligations under the transaction documents. This document cannot be reproduced except in full, without prior written approval of the Company. Any unauthorized alteration, forgery or falsification of the content or appearance of this document is unlawful and offenders may be prosecuted to the fullest extent of the law.

Operation Band :802.11aB3
Fundamental Frequency :5580 MHz
Operation Mode :Tx CH MID
EUT Pol. :E1 Plan

Test Date :2019-03-09
Temp./Humi. :20 deg_C / 61 RH
Engineer :Wei
Measurement Antenna Pol. :HORIZONTAL

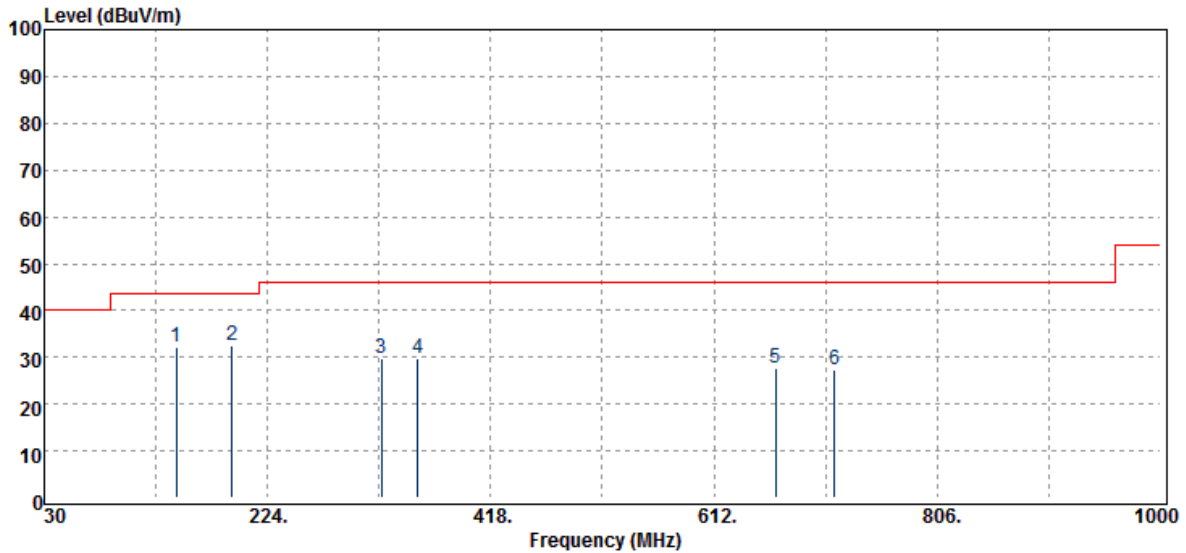

Freq. MHz	Detector Mode PK/QP/AV	Spectrum Reading Level dB μ V	Factor dB	Actual FS dB μ V/m	Limit @3m dB μ V/m	Margin dB
144.46	Peak	43.82	-11.53	32.29	43.50	-11.21
192.96	Peak	44.82	-12.28	32.54	43.50	-10.96
322.94	Peak	39.35	-9.74	29.61	46.00	-16.39
354.95	Peak	38.94	-9.30	29.64	46.00	-16.36
665.35	Peak	31.77	-3.94	27.83	46.00	-18.17
716.76	Peak	30.44	-3.17	27.27	46.00	-18.73

Unless otherwise stated the results shown in this test report refer only to the sample(s) tested and such sample(s) are retained for 90 days only.

除非另有說明，此報告結果僅對測試之樣品負責，同時此樣品僅保留90天。本報告未經本公司書面許可，不可部份複製。

This document is issued by the Company subject to its General Conditions of Service printed overleaf, available on request or accessible at www.sgs.com/terms_and_conditions.htm and for electronic format documents, subject to Terms and Conditions for Electronic Documents at www.sgs.com/terms_e-document.htm. Attention is drawn to the limitation of liability, indemnification and jurisdiction issues defined therein. Any holder of this document is advised that information contained hereon reflects the Company's findings at the time of its intervention only and within the limits of Client's instructions, if any. The Company's sole responsibility is to its Client and this document does not exonerate parties to a transaction from exercising all their rights and obligations under the transaction documents. This document cannot be reproduced except in full, without prior written approval of the Company. Any unauthorized alteration, forgery or falsification of the content or appearance of this document is unlawful and offenders may be prosecuted to the fullest extent of the law.

802.11a, 5725~5850 MHz

Operation Band :802.11aB4
Fundamental Frequency :5785 MHz
Operation Mode :Tx CH MID
EUT Pol. :E1 Plan

Test Date :2019-03-13
Temp./Humi. :23 deg_C / 62 RH
Engineer :Wei
Measurement Antenna Pol. :VERTICAL

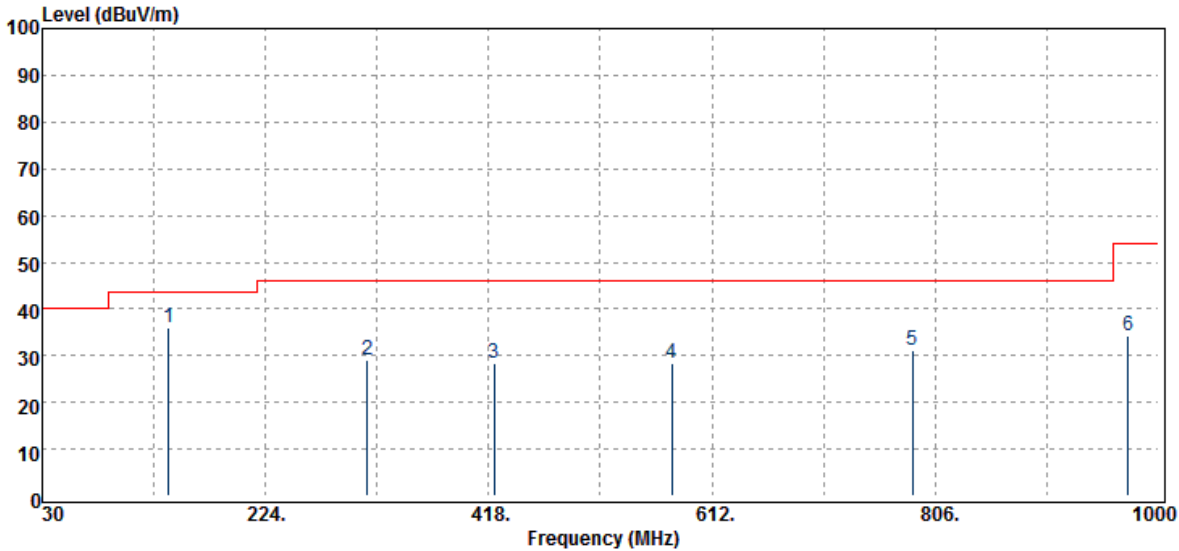

Freq. MHz	Detector Mode PK/QP/AV	Spectrum Reading Level dBuV	Factor dB	Actual FS dBuV/m	Limit @3m dBuV/m	Margin dB
139.61	Peak	45.01	-9.10	35.91	43.50	-7.59
312.27	Peak	36.17	-7.08	29.09	46.00	-16.91
422.85	Peak	32.57	-4.14	28.43	46.00	-17.57
577.08	Peak	29.84	-1.45	28.39	46.00	-17.61
786.60	Peak	28.59	2.48	31.07	46.00	-14.93
973.81	Peak	27.51	6.64	34.15	54.00	-19.85

Unless otherwise stated the results shown in this test report refer only to the sample(s) tested and such sample(s) are retained for 90 days only.

除非另有說明，此報告結果僅對測試之樣品負責，同時此樣品僅保留90天。本報告未經本公司書面許可，不可部份複製。

This document is issued by the Company subject to its General Conditions of Service printed overleaf, available on request or accessible at www.sgs.com/terms_and_conditions.htm and for electronic format documents, subject to Terms and Conditions for Electronic Documents at www.sgs.com/terms_e-document.htm. Attention is drawn to the limitation of liability, indemnification and jurisdiction issues defined therein. Any holder of this document is advised that information contained hereon reflects the Company's findings at the time of its intervention only and within the limits of Client's instructions, if any. The Company's sole responsibility is to its Client and this document does not exonerate parties to a transaction from exercising all their rights and obligations under the transaction documents. This document cannot be reproduced except in full, without prior written approval of the Company. Any unauthorized alteration, forgery or falsification of the content or appearance of this document is unlawful and offenders may be prosecuted to the fullest extent of the law.

Operation Band	:802.11aB4	Test Date	:2019-03-13
Fundamental Frequency	:5785 MHz	Temp./Humi.	:23 deg_C / 62 RH
Operation Mode	:Tx CH MID	Engineer	:Wei
EUT Pol.	:E1 Plan	Measurement Antenna Pol.	:HORIZONTAL

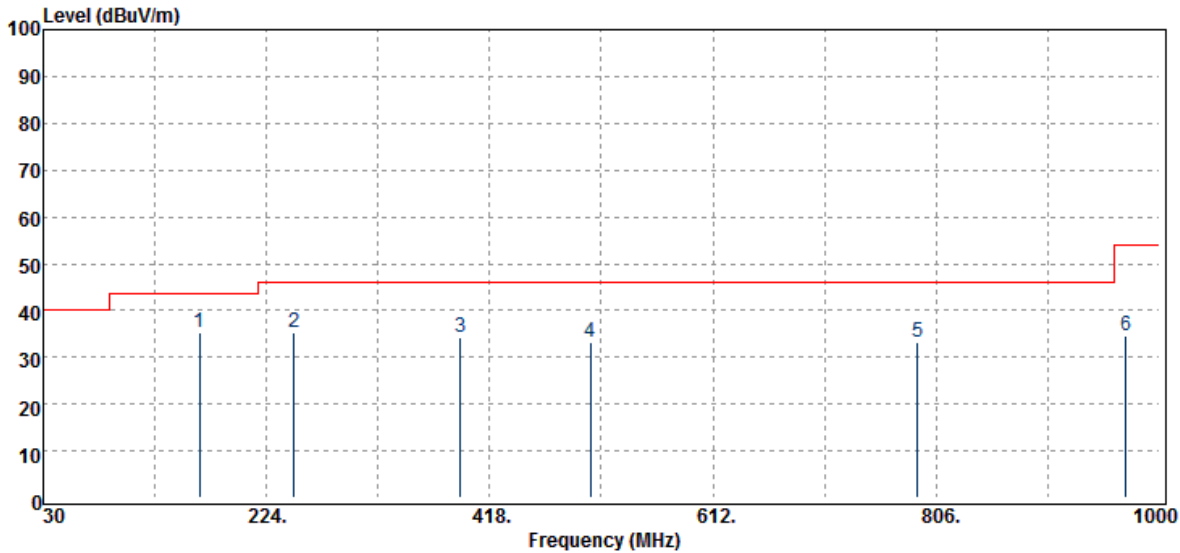

Freq. MHz	Detector Mode PK/QP/AV	Spectrum Reading Level dBuV	Factor dB	Actual FS dBuV/m	Limit @3m dBuV/m	Margin dB
165.80	Peak	45.11	-9.79	35.32	43.50	-8.18
248.25	Peak	45.16	-9.78	35.38	46.00	-10.62
392.78	Peak	39.32	-5.01	34.31	46.00	-11.69
505.30	Peak	35.31	-2.09	33.22	46.00	-12.78
789.51	Peak	30.92	2.40	33.32	46.00	-12.68
970.90	Peak	27.84	6.65	34.49	54.00	-19.51

Unless otherwise stated the results shown in this test report refer only to the sample(s) tested and such sample(s) are retained for 90 days only.

除非另有說明，此報告結果僅對測試之樣品負責，同時此樣品僅保留90天。本報告未經本公司書面許可，不可部份複製。

This document is issued by the Company subject to its General Conditions of Service printed overleaf, available on request or accessible at www.sgs.com/terms_and_conditions.htm and for electronic format documents, subject to Terms and Conditions for Electronic Documents at www.sgs.com/terms_e-document.htm. Attention is drawn to the limitation of liability, indemnification and jurisdiction issues defined therein. Any holder of this document is advised that information contained hereon reflects the Company's findings at the time of its intervention only and within the limits of Client's instructions, if any. The Company's sole responsibility is to its Client and this document does not exonerate parties to a transaction from exercising all their rights and obligations under the transaction documents. This document cannot be reproduced except in full, without prior written approval of the Company. Any unauthorized alteration, forgery or falsification of the content or appearance of this document is unlawful and offenders may be prosecuted to the fullest extent of the law.

Above 1GHz Worst-Case Data:

Radiated Spurious Emission Measurement Result 802.11a, 5150~5250 MHz

Operation Band	:802.11aB1	Test Date	:2019-03-09
Fundamental Frequency	:5180 MHz	Temp./Humi.	:20 deg_C / 61 RH
Operation Mode	:Tx CH LOW	Engineer	:Wei
EUT Pol.	:E1 Plane	Measurement Antenna Pol.	:VERTICAL

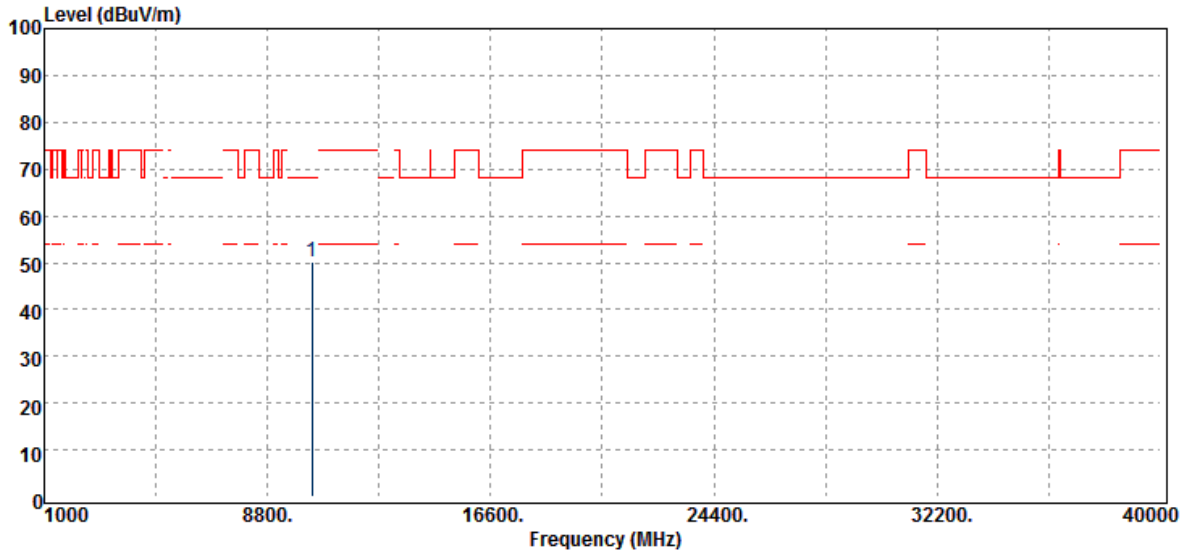

Freq. MHz	Detector Mode PK/QP/AV	Spectrum Reading Level dB μ V	Factor dB	Actual FS dB μ V/m	Limit @3m dB μ V/m	Margin dB
10360.00	Peak	35.77	14.41	50.18	74.00	-23.82

Unless otherwise stated the results shown in this test report refer only to the sample(s) tested and such sample(s) are retained for 90 days only.

除非另有說明，此報告結果僅對測試之樣品負責，同時此樣品僅保留90天。本報告未經本公司書面許可，不可部份複製。

This document is issued by the Company subject to its General Conditions of Service printed overleaf, available on request or accessible at www.sgs.com/terms_and_conditions.htm and for electronic format documents, subject to Terms and Conditions for Electronic Documents at www.sgs.com/terms_e-document.htm. Attention is drawn to the limitation of liability, indemnification and jurisdiction issues defined therein. Any holder of this document is advised that information contained hereon reflects the Company's findings at the time of its intervention only and within the limits of Client's instructions, if any. The Company's sole responsibility is to its Client and this document does not exonerate parties to a transaction from exercising all their rights and obligations under the transaction documents. This document cannot be reproduced except in full, without prior written approval of the Company. Any unauthorized alteration, forgery or falsification of the content or appearance of this document is unlawful and offenders may be prosecuted to the fullest extent of the law.

Operation Band :802.11aB1
Fundamental Frequency :5180 MHz
Operation Mode :Tx CH LOW
EUT Pol. :E1 Plane

Test Date :2019-03-09
Temp./Humi. :20 deg_C / 61 RH
Engineer :Wei
Measurement Antenna Pol. :HORIZONTAL

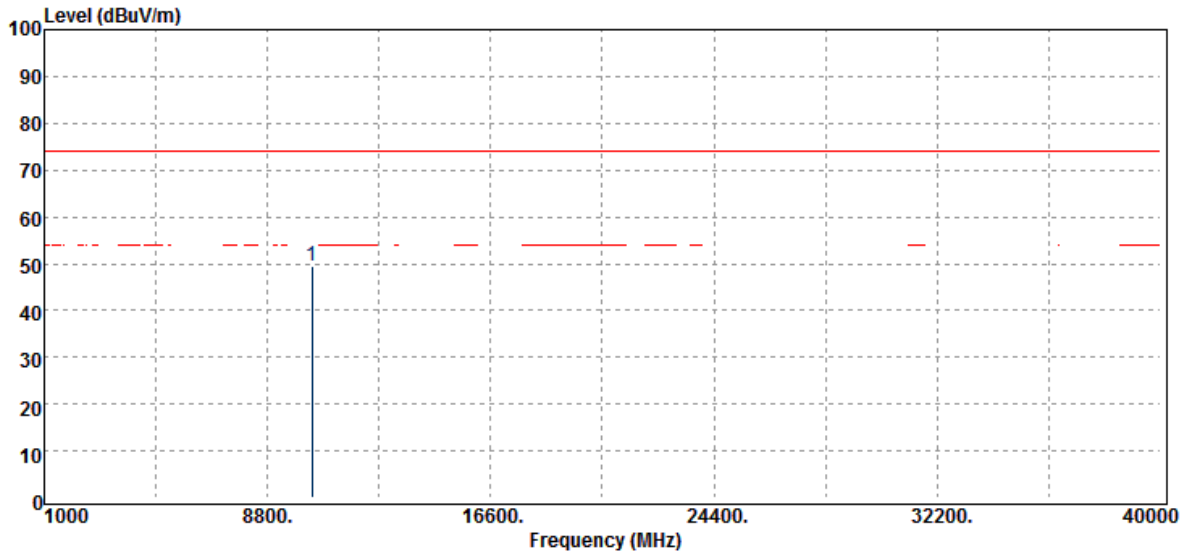

Freq. MHz	Detector Mode PK/QP/AV	Spectrum Reading Level dB μ V	Factor dB	Actual FS dB μ V/m	Limit @3m dB μ V/m	Margin dB
10360.00	Peak	35.03	14.41	49.44	74.00	-24.56

Unless otherwise stated the results shown in this test report refer only to the sample(s) tested and such sample(s) are retained for 90 days only.

除非另有說明，此報告結果僅對測試之樣品負責，同時此樣品僅保留90天。本報告未經本公司書面許可，不可部份複製。

This document is issued by the Company subject to its General Conditions of Service printed overleaf, available on request or accessible at www.sgs.com/terms_and_conditions.htm and for electronic format documents, subject to Terms and Conditions for Electronic Documents at www.sgs.com/terms_e-document.htm. Attention is drawn to the limitation of liability, indemnification and jurisdiction issues defined therein. Any holder of this document is advised that information contained hereon reflects the Company's findings at the time of its intervention only and within the limits of Client's instructions, if any. The Company's sole responsibility is to its Client and this document does not exonerate parties to a transaction from exercising all their rights and obligations under the transaction documents. This document cannot be reproduced except in full, without prior written approval of the Company. Any unauthorized alteration, forgery or falsification of the content or appearance of this document is unlawful and offenders may be prosecuted to the fullest extent of the law.

Operation Band :802.11aB1
Fundamental Frequency :5220 MHz
Operation Mode :Tx CH MID
EUT Pol. :E1 Plane

Test Date :2019-03-09
Temp./Humi. :20 deg_C / 61 RH
Engineer :Wei
Measurement Antenna Pol. :VERTICAL

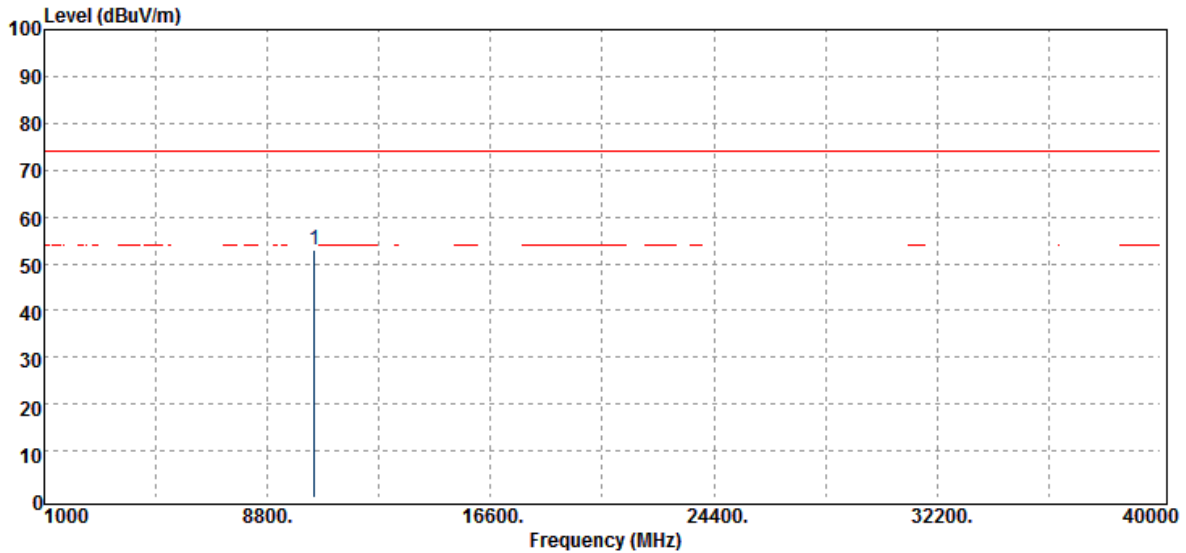

Freq. MHz	Detector Mode PK/QP/AV	Spectrum Reading Level dB μ V	Factor dB	Actual FS dB μ V/m	Limit @3m dB μ V/m	Margin dB
10440.00	Peak	37.48	15.58	53.06	74.00	-20.94

Unless otherwise stated the results shown in this test report refer only to the sample(s) tested and such sample(s) are retained for 90 days only.

除非另有說明，此報告結果僅對測試之樣品負責，同時此樣品僅保留90天。本報告未經本公司書面許可，不可部份複製。

This document is issued by the Company subject to its General Conditions of Service printed overleaf, available on request or accessible at www.sgs.com/terms_and_conditions.htm and for electronic format documents, subject to Terms and Conditions for Electronic Documents at www.sgs.com/terms_e-document.htm. Attention is drawn to the limitation of liability, indemnification and jurisdiction issues defined therein. Any holder of this document is advised that information contained hereon reflects the Company's findings at the time of its intervention only and within the limits of Client's instructions, if any. The Company's sole responsibility is to its Client and this document does not exonerate parties to a transaction from exercising all their rights and obligations under the transaction documents. This document cannot be reproduced except in full, without prior written approval of the Company. Any unauthorized alteration, forgery or falsification of the content or appearance of this document is unlawful and offenders may be prosecuted to the fullest extent of the law.

Operation Band :802.11aB1
Fundamental Frequency :5220 MHz
Operation Mode :Tx CH MID
EUT Pol. :E1 Plane

Test Date :2019-03-09
Temp./Humi. :20 deg_C / 61 RH
Engineer :Wei
Measurement Antenna Pol. :HORIZONTAL

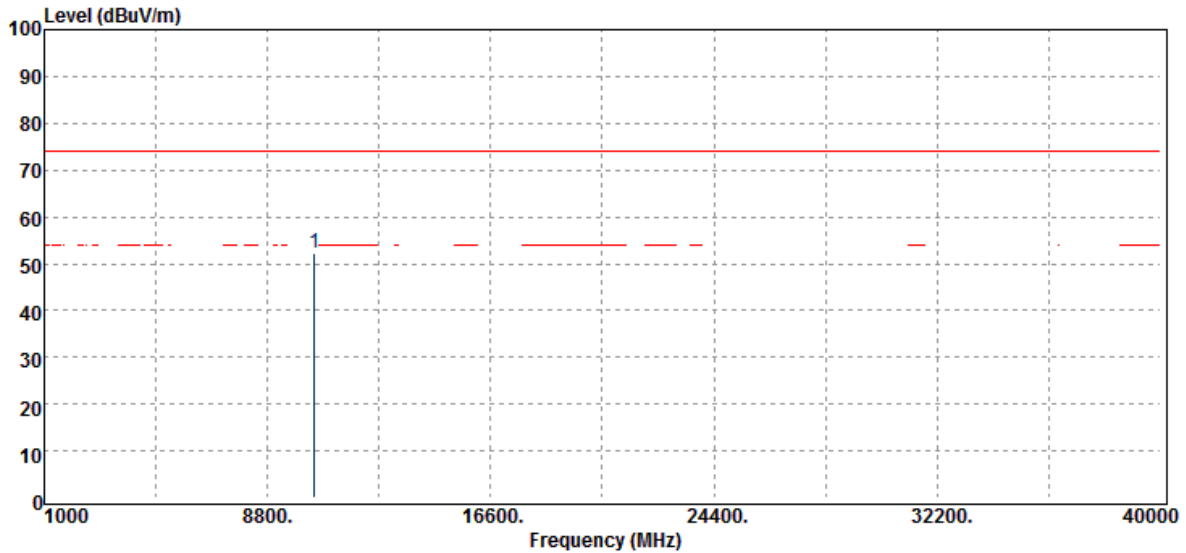

Freq. MHz	Detector Mode PK/QP/AV	Spectrum Reading Level dB μ V	Factor dB	Actual FS dB μ V/m	Limit @3m dB μ V/m	Margin dB
10440.00	Peak	36.80	15.58	52.38	74.00	-21.62

Unless otherwise stated the results shown in this test report refer only to the sample(s) tested and such sample(s) are retained for 90 days only.

除非另有說明，此報告結果僅對測試之樣品負責，同時此樣品僅保留90天。本報告未經本公司書面許可，不可部份複製。

This document is issued by the Company subject to its General Conditions of Service printed overleaf, available on request or accessible at www.sgs.com/terms_and_conditions.htm and for electronic format documents, subject to Terms and Conditions for Electronic Documents at www.sgs.com/terms_e-document.htm. Attention is drawn to the limitation of liability, indemnification and jurisdiction issues defined therein. Any holder of this document is advised that information contained hereon reflects the Company's findings at the time of its intervention only and within the limits of Client's instructions, if any. The Company's sole responsibility is to its Client and this document does not exonerate parties to a transaction from exercising all their rights and obligations under the transaction documents. This document cannot be reproduced except in full, without prior written approval of the Company. Any unauthorized alteration, forgery or falsification of the content or appearance of this document is unlawful and offenders may be prosecuted to the fullest extent of the law.

Operation Band	:802.11aB1	Test Date	:2019-03-09
Fundamental Frequency	:5240 MHz	Temp./Humi.	:20 deg_C / 61 RH
Operation Mode	:Tx CH HIGH	Engineer	:Wei
EUT Pol.	:E1 Plane	Measurement Antenna Pol.	:VERTICAL

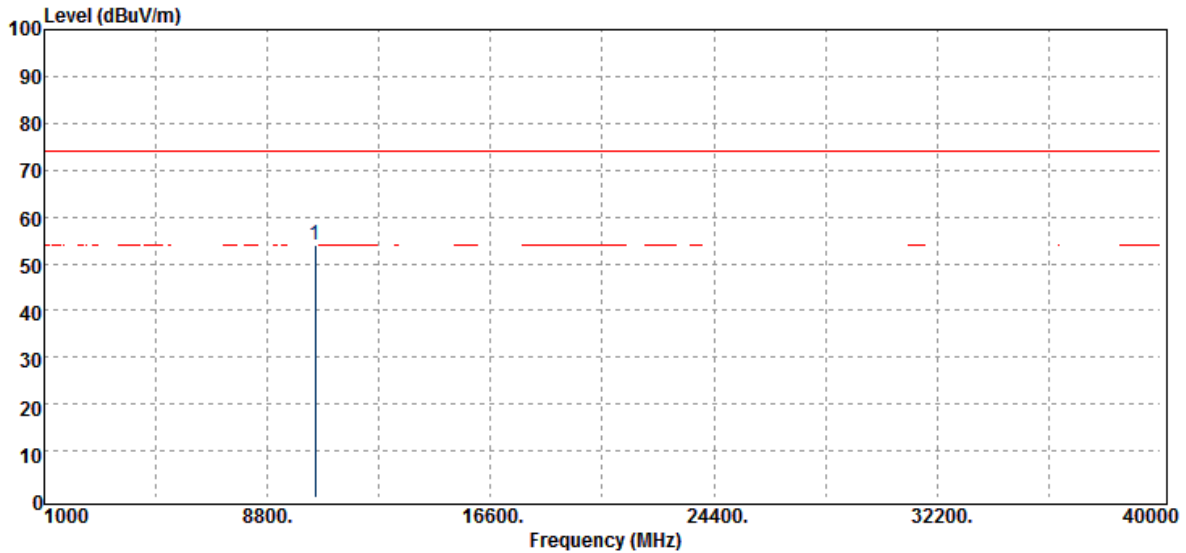

Freq. MHz	Detector Mode PK/QP/AV	Spectrum Reading Level dBuV	Factor dB	Actual FS dBuV/m	Limit @3m dBuV/m	Margin dB
10480.00	Peak	37.50	16.48	53.98	68.20	-14.22

Unless otherwise stated the results shown in this test report refer only to the sample(s) tested and such sample(s) are retained for 90 days only.

除非另有說明，此報告結果僅對測試之樣品負責，同時此樣品僅保留90天。本報告未經本公司書面許可，不可部份複製。

This document is issued by the Company subject to its General Conditions of Service printed overleaf, available on request or accessible at www.sgs.com/terms_and_conditions.htm and for electronic format documents, subject to Terms and Conditions for Electronic Documents at www.sgs.com/terms_e-document.htm. Attention is drawn to the limitation of liability, indemnification and jurisdiction issues defined therein. Any holder of this document is advised that information contained hereon reflects the Company's findings at the time of its intervention only and within the limits of Client's instructions, if any. The Company's sole responsibility is to its Client and this document does not exonerate parties to a transaction from exercising all their rights and obligations under the transaction documents. This document cannot be reproduced except in full, without prior written approval of the Company. Any unauthorized alteration, forgery or falsification of the content or appearance of this document is unlawful and offenders may be prosecuted to the fullest extent of the law.

Operation Band	:802.11aB1	Test Date	:2019-03-09
Fundamental Frequency	:5240 MHz	Temp./Humi.	:20 deg_C / 61 RH
Operation Mode	:Tx CH HIGH	Engineer	:Wei
EUT Pol.	:E1 Plane	Measurement Antenna Pol.	:HORIZONTAL

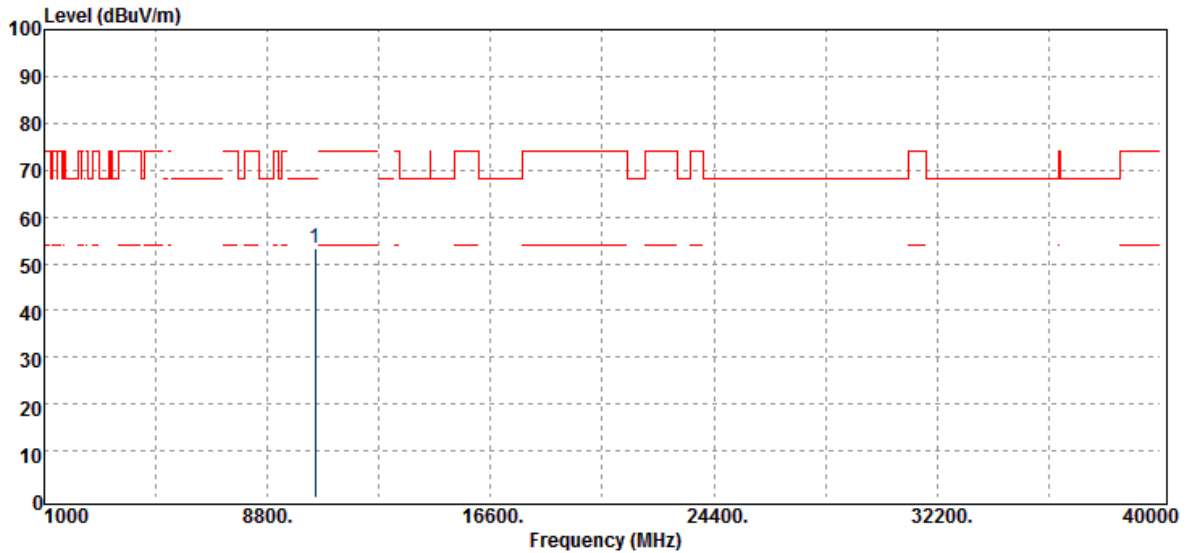

Freq. MHz	Detector Mode PK/QP/AV	Spectrum Reading Level dB μ V	Factor dB	Actual FS dB μ V/m	Limit @3m dB μ V/m	Margin dB
10480.00	Peak	36.73	16.48	53.21	68.20	-14.99

Unless otherwise stated the results shown in this test report refer only to the sample(s) tested and such sample(s) are retained for 90 days only.

除非另有說明，此報告結果僅對測試之樣品負責，同時此樣品僅保留90天。本報告未經本公司書面許可，不可部份複製。

This document is issued by the Company subject to its General Conditions of Service printed overleaf, available on request or accessible at www.sgs.com/terms_and_conditions.htm and for electronic format documents, subject to Terms and Conditions for Electronic Documents at www.sgs.com/terms_e-document.htm. Attention is drawn to the limitation of liability, indemnification and jurisdiction issues defined therein. Any holder of this document is advised that information contained hereon reflects the Company's findings at the time of its intervention only and within the limits of Client's instructions, if any. The Company's sole responsibility is to its Client and this document does not exonerate parties to a transaction from exercising all their rights and obligations under the transaction documents. This document cannot be reproduced except in full, without prior written approval of the Company. Any unauthorized alteration, forgery or falsification of the content or appearance of this document is unlawful and offenders may be prosecuted to the fullest extent of the law.

Radiated Spurious Emission Measurement Result 802.11a, 5250MHz-5350MHz

Operation Band	:802.11aB2	Test Date	:2019-03-09
Fundamental Frequency	:5260 MHz	Temp./Humi.	:20 deg_C / 61 RH
Operation Mode	:Tx CH LOW	Engineer	:Wei
EUT Pol.	:E1 Plane	Measurement Antenna Pol.	:VERTICAL

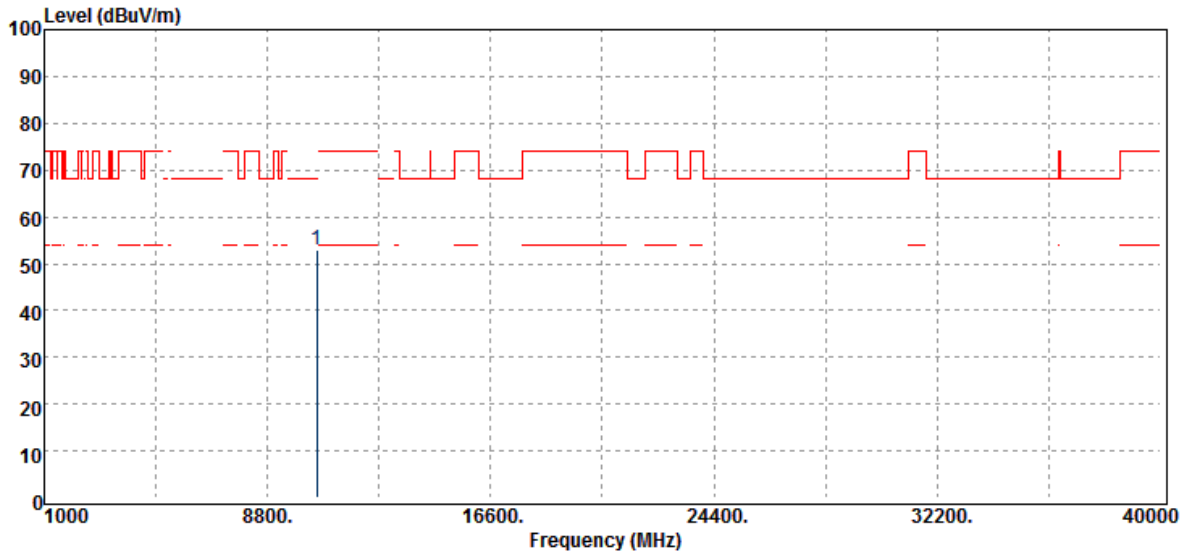

Freq. MHz	Detector Mode PK/QP/AV	Spectrum Reading Level dBuV	Factor dB	Actual FS dBuV/m	Limit @3m dBuV/m	Margin dB
10520.00	Peak	37.36	15.57	52.93	68.20	-15.27

Unless otherwise stated the results shown in this test report refer only to the sample(s) tested and such sample(s) are retained for 90 days only.

除非另有說明，此報告結果僅對測試之樣品負責，同時此樣品僅保留90天。本報告未經本公司書面許可，不可部份複製。

This document is issued by the Company subject to its General Conditions of Service printed overleaf, available on request or accessible at www.sgs.com/terms_and_conditions.htm and for electronic format documents, subject to Terms and Conditions for Electronic Documents at www.sgs.com/terms_e-document.htm. Attention is drawn to the limitation of liability, indemnification and jurisdiction issues defined therein. Any holder of this document is advised that information contained hereon reflects the Company's findings at the time of its intervention only and within the limits of Client's instructions, if any. The Company's sole responsibility is to its Client and this document does not exonerate parties to a transaction from exercising all their rights and obligations under the transaction documents. This document cannot be reproduced except in full, without prior written approval of the Company. Any unauthorized alteration, forgery or falsification of the content or appearance of this document is unlawful and offenders may be prosecuted to the fullest extent of the law.

Operation Band :802.11aB2
Fundamental Frequency :5260 MHz
Operation Mode :Tx CH LOW
EUT Pol. :E1 Plane

Test Date :2019-03-09
Temp./Humi. :20 deg_C / 61 RH
Engineer :Wei
Measurement Antenna Pol. :HORIZONTAL

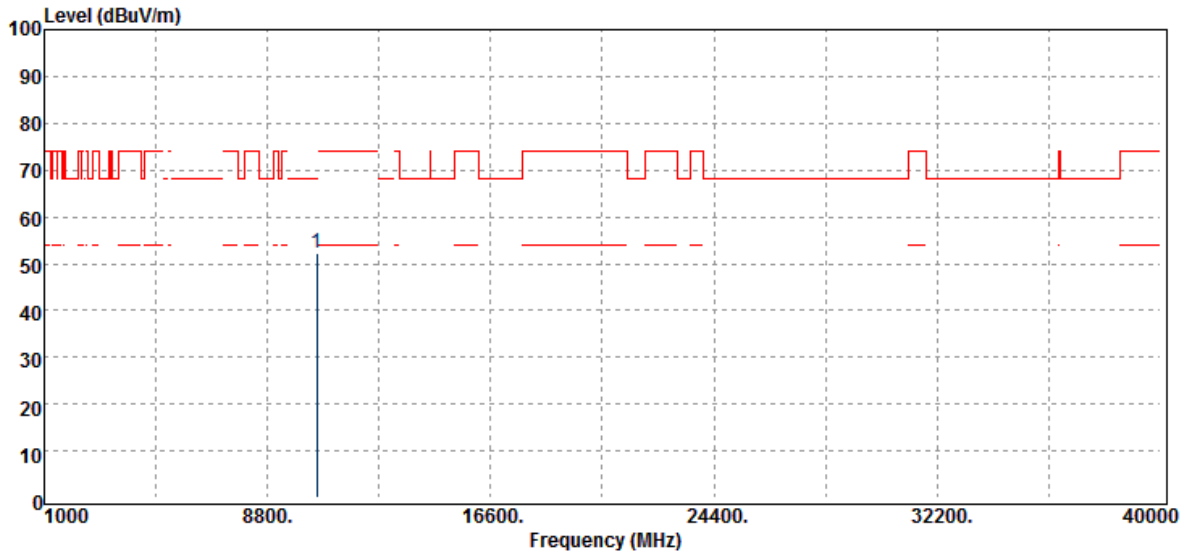

Freq. MHz	Detector Mode PK/QP/AV	Spectrum Reading Level dBuV	Factor dB	Actual FS dBuV/m	Limit @3m dBuV/m	Margin dB
10520.00	Peak	36.54	15.57	52.11	68.20	-16.09

Unless otherwise stated the results shown in this test report refer only to the sample(s) tested and such sample(s) are retained for 90 days only.

除非另有說明，此報告結果僅對測試之樣品負責，同時此樣品僅保留90天。本報告未經本公司書面許可，不可部份複製。

This document is issued by the Company subject to its General Conditions of Service printed overleaf, available on request or accessible at www.sgs.com/terms_and_conditions.htm and for electronic format documents, subject to Terms and Conditions for Electronic Documents at www.sgs.com/terms_e-document.htm. Attention is drawn to the limitation of liability, indemnification and jurisdiction issues defined therein. Any holder of this document is advised that information contained hereon reflects the Company's findings at the time of its intervention only and within the limits of Client's instructions, if any. The Company's sole responsibility is to its Client and this document does not exonerate parties to a transaction from exercising all their rights and obligations under the transaction documents. This document cannot be reproduced except in full, without prior written approval of the Company. Any unauthorized alteration, forgery or falsification of the content or appearance of this document is unlawful and offenders may be prosecuted to the fullest extent of the law.

Operation Band :802.11aB2
Fundamental Frequency :5300 MHz
Operation Mode :Tx CH MID
EUT Pol. :E1 Plane

Test Date :2019-03-09
Temp./Humi. :20 deg_C / 61 RH
Engineer :Wei
Measurement Antenna Pol. :VERTICAL

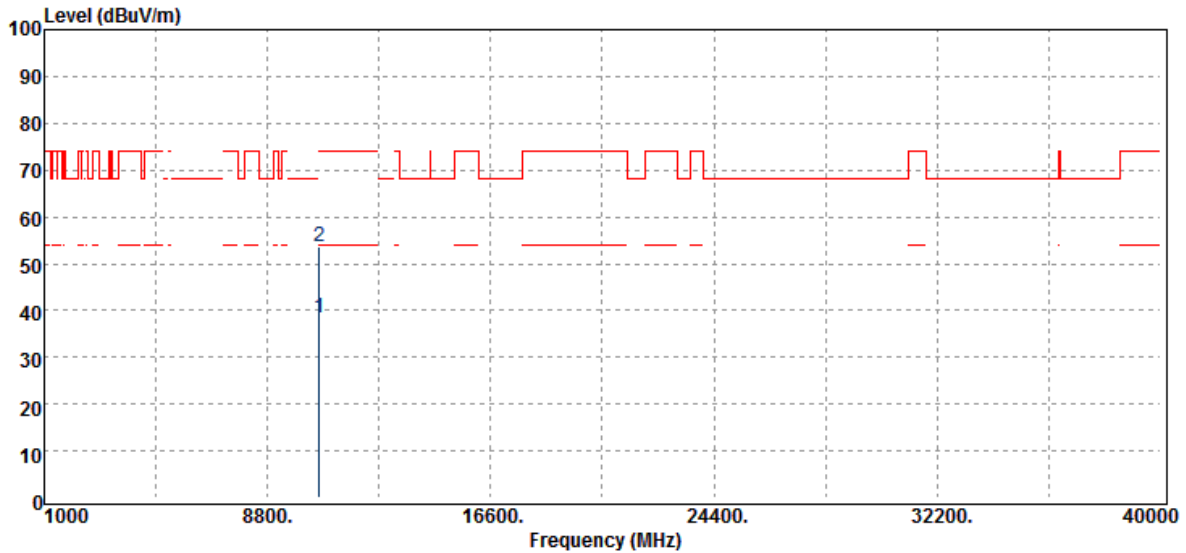

Freq. MHz	Detector Mode PK/QP/AV	Spectrum Reading Level dB μ V	Factor dB	Actual FS dB μ V/m	Limit @3m dB μ V/m	Margin dB
10600.00	Average	22.80	15.47	38.27	54.00	-15.73
10600.00	Peak	38.08	15.47	53.55	74.00	-20.45

Unless otherwise stated the results shown in this test report refer only to the sample(s) tested and such sample(s) are retained for 90 days only.

除非另有說明，此報告結果僅對測試之樣品負責，同時此樣品僅保留90天。本報告未經本公司書面許可，不可部份複製。

This document is issued by the Company subject to its General Conditions of Service printed overleaf, available on request or accessible at www.sgs.com/terms_and_conditions.htm and for electronic format documents, subject to Terms and Conditions for Electronic Documents at www.sgs.com/terms_e-document.htm. Attention is drawn to the limitation of liability, indemnification and jurisdiction issues defined therein. Any holder of this document is advised that information contained hereon reflects the Company's findings at the time of its intervention only and within the limits of Client's instructions, if any. The Company's sole responsibility is to its Client and this document does not exonerate parties to a transaction from exercising all their rights and obligations under the transaction documents. This document cannot be reproduced except in full, without prior written approval of the Company. Any unauthorized alteration, forgery or falsification of the content or appearance of this document is unlawful and offenders may be prosecuted to the fullest extent of the law.

Operation Band :802.11aB2
Fundamental Frequency :5300 MHz
Operation Mode :Tx CH MID
EUT Pol. :E1 Plane

Test Date :2019-03-09
Temp./Humi. :20 deg_C / 61 RH
Engineer :Wei
Measurement Antenna Pol. :HORIZONTAL

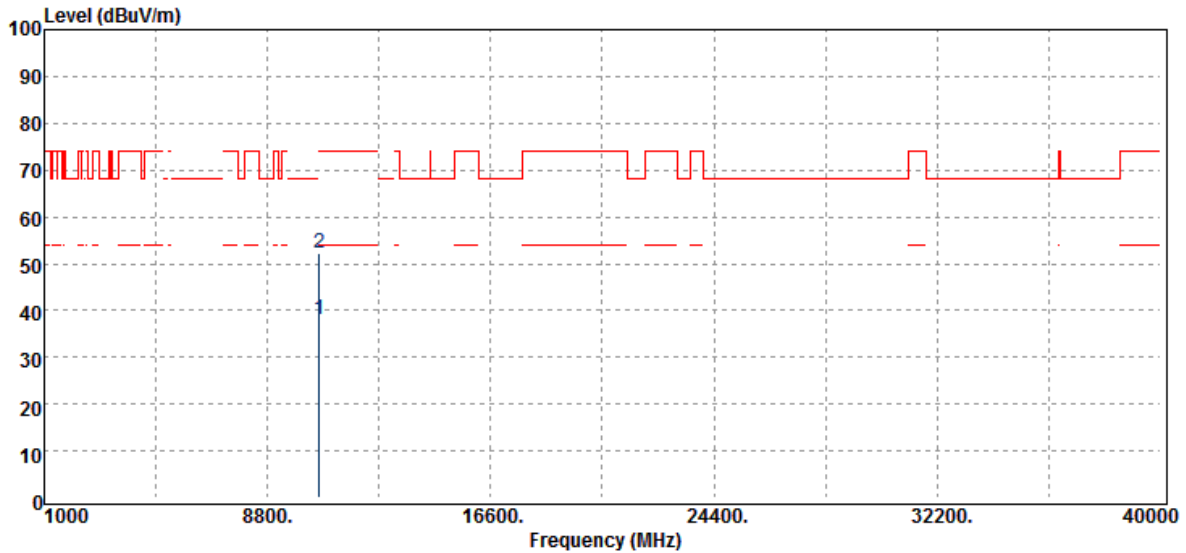

Freq. MHz	Detector Mode PK/QP/AV	Spectrum Reading Level dBuV	Factor dB	Actual FS dBuV/m	Limit @3m dBuV/m	Margin dB
10600.00	Average	22.52	15.47	37.99	54.00	-16.01
10600.00	Peak	36.92	15.47	52.39	74.00	-21.61

Unless otherwise stated the results shown in this test report refer only to the sample(s) tested and such sample(s) are retained for 90 days only.

除非另有說明，此報告結果僅對測試之樣品負責，同時此樣品僅保留90天。本報告未經本公司書面許可，不可部份複製。

This document is issued by the Company subject to its General Conditions of Service printed overleaf, available on request or accessible at www.sgs.com/terms_and_conditions.htm and for electronic format documents, subject to Terms and Conditions for Electronic Documents at www.sgs.com/terms_e-document.htm. Attention is drawn to the limitation of liability, indemnification and jurisdiction issues defined therein. Any holder of this document is advised that information contained hereon reflects the Company's findings at the time of its intervention only and within the limits of Client's instructions, if any. The Company's sole responsibility is to its Client and this document does not exonerate parties to a transaction from exercising all their rights and obligations under the transaction documents. This document cannot be reproduced except in full, without prior written approval of the Company. Any unauthorized alteration, forgery or falsification of the content or appearance of this document is unlawful and offenders may be prosecuted to the fullest extent of the law.

Operation Band	:802.11aB2	Test Date	:2019-03-09
Fundamental Frequency	:5320 MHz	Temp./Humi.	:20 deg_C / 61 RH
Operation Mode	:Tx CH HIGH	Engineer	:Wei
EUT Pol.	:E1 Plane	Measurement Antenna Pol.	:VERTICAL

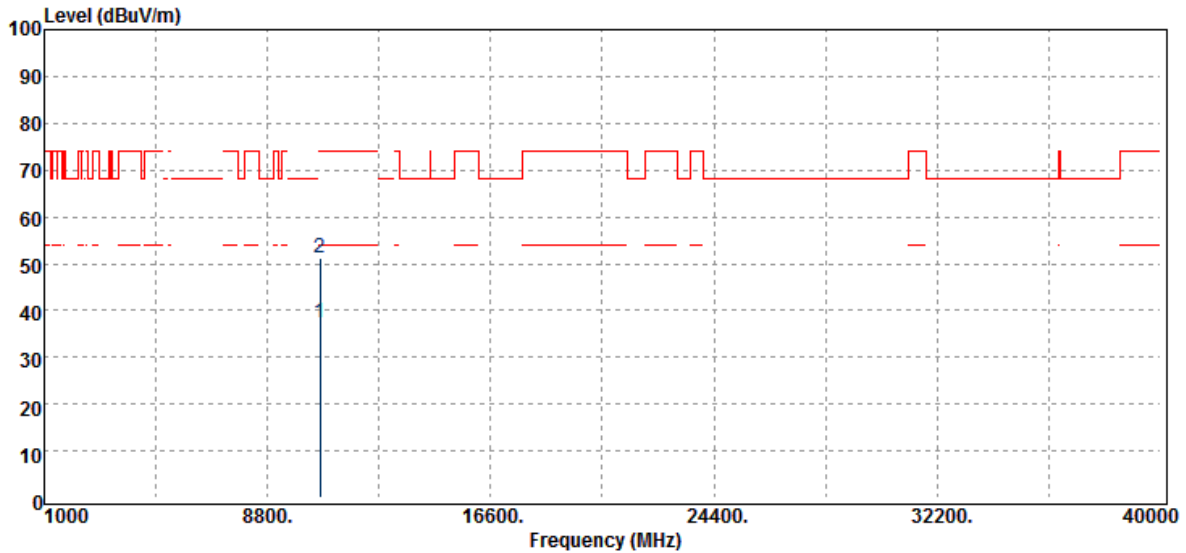

Freq. MHz	Detector Mode PK/QP/AV	Spectrum Reading Level dBuV	Factor dB	Actual FS dBuV/m	Limit @3m dBuV/m	Margin dB
10640.00	Average	21.32	16.12	37.44	54.00	-16.56
10640.00	Peak	35.21	16.12	51.33	74.00	-22.67

Unless otherwise stated the results shown in this test report refer only to the sample(s) tested and such sample(s) are retained for 90 days only.

除非另有說明，此報告結果僅對測試之樣品負責，同時此樣品僅保留90天。本報告未經本公司書面許可，不可部份複製。

This document is issued by the Company subject to its General Conditions of Service printed overleaf, available on request or accessible at www.sgs.com/terms_and_conditions.htm and for electronic format documents, subject to Terms and Conditions for Electronic Documents at www.sgs.com/terms_e-document.htm. Attention is drawn to the limitation of liability, indemnification and jurisdiction issues defined therein. Any holder of this document is advised that information contained hereon reflects the Company's findings at the time of its intervention only and within the limits of Client's instructions, if any. The Company's sole responsibility is to its Client and this document does not exonerate parties to a transaction from exercising all their rights and obligations under the transaction documents. This document cannot be reproduced except in full, without prior written approval of the Company. Any unauthorized alteration, forgery or falsification of the content or appearance of this document is unlawful and offenders may be prosecuted to the fullest extent of the law.

Operation Band	:802.11aB2	Test Date	:2019-03-09
Fundamental Frequency	:5320 MHz	Temp./Humi.	:20 deg_C / 61 RH
Operation Mode	:Tx CH HIGH	Engineer	:Wei
EUT Pol.	:E1 Plane	Measurement Antenna Pol.	:HORIZONTAL

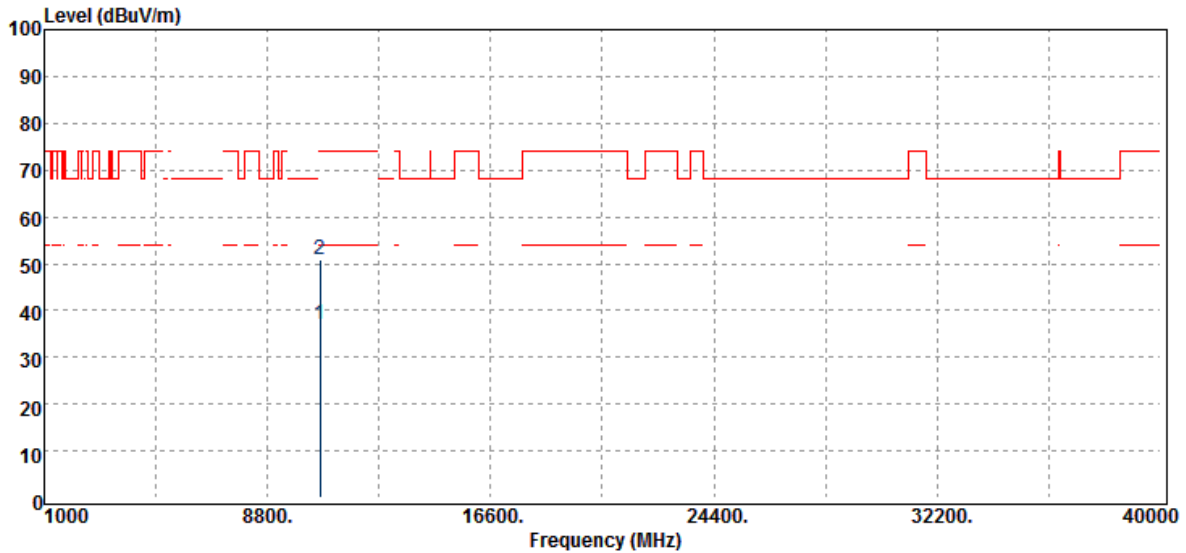

Freq. MHz	Detector Mode PK/QP/AV	Spectrum Reading Level dBuV	Factor dB	Actual FS dBuV/m	Limit @3m dBuV/m	Margin dB
10640.00	Average	20.85	16.12	36.97	54.00	-17.03
10640.00	Peak	34.83	16.12	50.95	74.00	-23.05

Unless otherwise stated the results shown in this test report refer only to the sample(s) tested and such sample(s) are retained for 90 days only.

除非另有說明，此報告結果僅對測試之樣品負責，同時此樣品僅保留90天。本報告未經本公司書面許可，不可部份複製。

This document is issued by the Company subject to its General Conditions of Service printed overleaf, available on request or accessible at www.sgs.com/terms_and_conditions.htm and for electronic format documents, subject to Terms and Conditions for Electronic Documents at www.sgs.com/terms_e-document.htm. Attention is drawn to the limitation of liability, indemnification and jurisdiction issues defined therein. Any holder of this document is advised that information contained hereon reflects the Company's findings at the time of its intervention only and within the limits of Client's instructions, if any. The Company's sole responsibility is to its Client and this document does not exonerate parties to a transaction from exercising all their rights and obligations under the transaction documents. This document cannot be reproduced except in full, without prior written approval of the Company. Any unauthorized alteration, forgery or falsification of the content or appearance of this document is unlawful and offenders may be prosecuted to the fullest extent of the law.

Radiated Spurious Emission Measurement Result 802.11a, 5470~5725 MHz

Operation Band	:802.11aB3	Test Date	:2019-03-09
Fundamental Frequency	:5500 MHz	Temp./Humi.	:20 deg_C / 61 RH
Operation Mode	:Tx CH LOW	Engineer	:Wei
EUT Pol.	:E1 Plane	Measurement Antenna Pol.	:VERTICAL

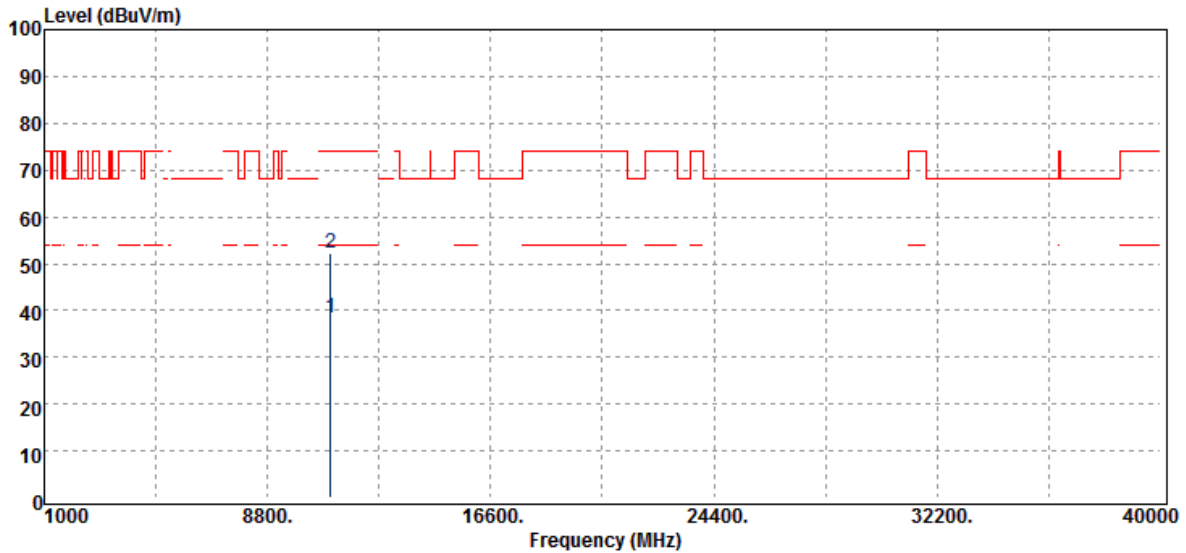

Freq. MHz	Detector Mode PK/QP/AV	Spectrum Reading Level dBuV	Factor dB	Actual FS dBuV/m	Limit @3m dBuV/m	Margin dB
11000.00	Average	20.55	17.75	38.30	54.00	-15.70
11000.00	Peak	34.65	17.75	52.40	74.00	-21.60

Unless otherwise stated the results shown in this test report refer only to the sample(s) tested and such sample(s) are retained for 90 days only.

除非另有說明，此報告結果僅對測試之樣品負責，同時此樣品僅保留90天。本報告未經本公司書面許可，不可部份複製。

This document is issued by the Company subject to its General Conditions of Service printed overleaf, available on request or accessible at www.sgs.com/terms_and_conditions.htm and for electronic format documents, subject to Terms and Conditions for Electronic Documents at www.sgs.com/terms_e-document.htm. Attention is drawn to the limitation of liability, indemnification and jurisdiction issues defined therein. Any holder of this document is advised that information contained hereon reflects the Company's findings at the time of its intervention only and within the limits of Client's instructions, if any. The Company's sole responsibility is to its Client and this document does not exonerate parties to a transaction from exercising all their rights and obligations under the transaction documents. This document cannot be reproduced except in full, without prior written approval of the Company. Any unauthorized alteration, forgery or falsification of the content or appearance of this document is unlawful and offenders may be prosecuted to the fullest extent of the law.

Operation Band :802.11aB3
Fundamental Frequency :5500 MHz
Operation Mode :Tx CH LOW
EUT Pol. :E1 Plane

Test Date :2019-03-09
Temp./Humi. :20 deg_C / 61 RH
Engineer :Wei
Measurement Antenna Pol. :HORIZONTAL

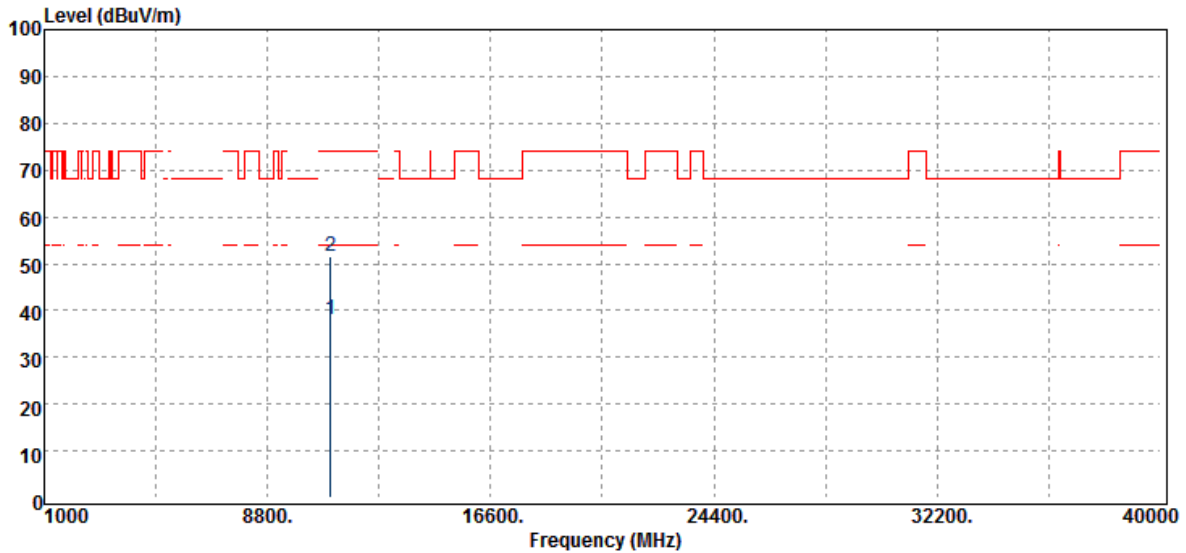

Freq. MHz	Detector Mode PK/QP/AV	Spectrum Reading Level dB μ V	Factor dB	Actual FS dB μ V/m	Limit @3m dB μ V/m	Margin dB
11000.00	Average	20.43	17.75	38.18	54.00	-15.82
11000.00	Peak	33.93	17.75	51.68	74.00	-22.32

Unless otherwise stated the results shown in this test report refer only to the sample(s) tested and such sample(s) are retained for 90 days only.

除非另有說明，此報告結果僅對測試之樣品負責，同時此樣品僅保留90天。本報告未經本公司書面許可，不可部份複製。

This document is issued by the Company subject to its General Conditions of Service printed overleaf, available on request or accessible at www.sgs.com/terms_and_conditions.htm and for electronic format documents, subject to Terms and Conditions for Electronic Documents at www.sgs.com/terms_e-document.htm. Attention is drawn to the limitation of liability, indemnification and jurisdiction issues defined therein. Any holder of this document is advised that information contained hereon reflects the Company's findings at the time of its intervention only and within the limits of Client's instructions, if any. The Company's sole responsibility is to its Client and this document does not exonerate parties to a transaction from exercising all their rights and obligations under the transaction documents. This document cannot be reproduced except in full, without prior written approval of the Company. Any unauthorized alteration, forgery or falsification of the content or appearance of this document is unlawful and offenders may be prosecuted to the fullest extent of the law.

Operation Band :802.11aB3
Fundamental Frequency :5580 MHz
Operation Mode :Tx CH MID
EUT Pol. :E1 Plane

Test Date :2019-03-09
Temp./Humi. :20 deg_C / 61 RH
Engineer :Wei
Measurement Antenna Pol. :VERTICAL

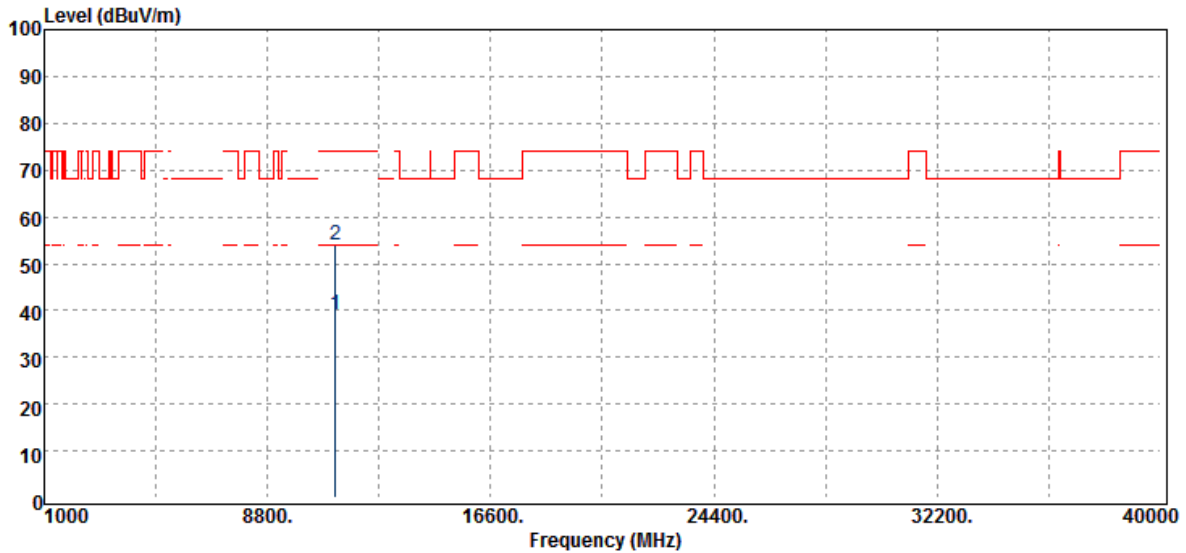

Freq. MHz	Detector Mode PK/QP/AV	Spectrum Reading Level dBuV	Factor dB	Actual FS dBuV/m	Limit @3m dBuV/m	Margin dB
11160.00	Average	22.62	16.53	39.15	54.00	-14.85
11160.00	Peak	37.58	16.53	54.11	74.00	-19.89

Unless otherwise stated the results shown in this test report refer only to the sample(s) tested and such sample(s) are retained for 90 days only.

除非另有說明，此報告結果僅對測試之樣品負責，同時此樣品僅保留90天。本報告未經本公司書面許可，不可部份複製。

This document is issued by the Company subject to its General Conditions of Service printed overleaf, available on request or accessible at www.sgs.com/terms_and_conditions.htm and for electronic format documents, subject to Terms and Conditions for Electronic Documents at www.sgs.com/terms_e-document.htm. Attention is drawn to the limitation of liability, indemnification and jurisdiction issues defined therein. Any holder of this document is advised that information contained hereon reflects the Company's findings at the time of its intervention only and within the limits of Client's instructions, if any. The Company's sole responsibility is to its Client and this document does not exonerate parties to a transaction from exercising all their rights and obligations under the transaction documents. This document cannot be reproduced except in full, without prior written approval of the Company. Any unauthorized alteration, forgery or falsification of the content or appearance of this document is unlawful and offenders may be prosecuted to the fullest extent of the law.

Operation Band :802.11aB3
Fundamental Frequency :5580 MHz
Operation Mode :Tx CH MID
EUT Pol. :E1 Plane

Test Date :2019-03-09
Temp./Humi. :20 deg_C / 61 RH
Engineer :Wei
Measurement Antenna Pol. :HORIZONTAL

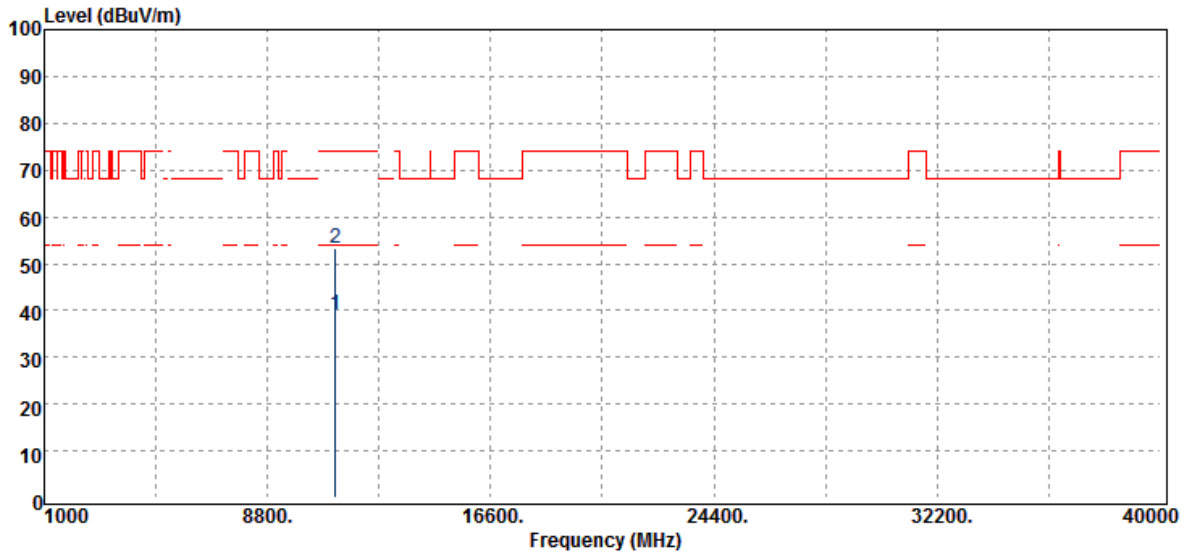

Freq. MHz	Detector Mode PK/QP/AV	Spectrum Reading Level dB μ V	Factor dB	Actual FS dB μ V/m	Limit @3m dB μ V/m	Margin dB
11160.00	Average	22.44	16.53	38.97	54.00	-15.03
11160.00	Peak	36.68	16.53	53.21	74.00	-20.79

Unless otherwise stated the results shown in this test report refer only to the sample(s) tested and such sample(s) are retained for 90 days only.

除非另有說明，此報告結果僅對測試之樣品負責，同時此樣品僅保留90天。本報告未經本公司書面許可，不可部份複製。

This document is issued by the Company subject to its General Conditions of Service printed overleaf, available on request or accessible at www.sgs.com/terms_and_conditions.htm and for electronic format documents, subject to Terms and Conditions for Electronic Documents at www.sgs.com/terms_e-document.htm. Attention is drawn to the limitation of liability, indemnification and jurisdiction issues defined therein. Any holder of this document is advised that information contained hereon reflects the Company's findings at the time of its intervention only and within the limits of Client's instructions, if any. The Company's sole responsibility is to its Client and this document does not exonerate parties to a transaction from exercising all their rights and obligations under the transaction documents. This document cannot be reproduced except in full, without prior written approval of the Company. Any unauthorized alteration, forgery or falsification of the content or appearance of this document is unlawful and offenders may be prosecuted to the fullest extent of the law.

Operation Band	:802.11aB3	Test Date	:2019-03-09
Fundamental Frequency	:5700 MHz	Temp./Humi.	:20 deg_C / 61 RH
Operation Mode	:Tx CH HIGH	Engineer	:Wei
EUT Pol.	:E1 Plane	Measurement Antenna Pol.	:VERTICAL

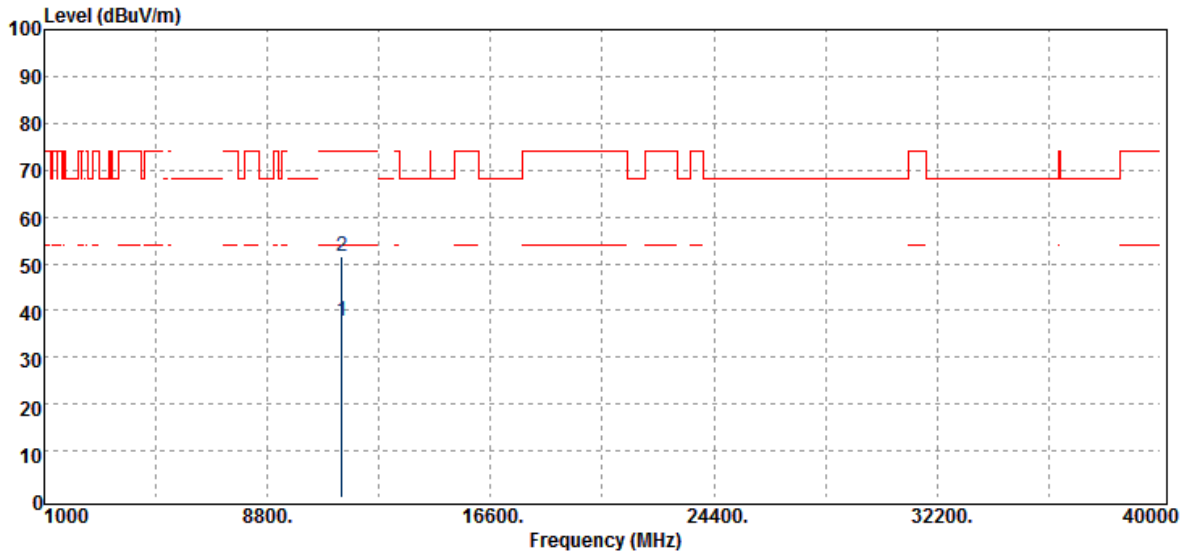

Freq. MHz	Detector Mode PK/QP/AV	Spectrum Reading Level dB μ V	Factor dB	Actual FS dB μ V/m	Limit @3m dB μ V/m	Margin dB
11400.00	Average	21.22	16.48	37.70	54.00	-16.30
11400.00	Peak	35.17	16.48	51.65	74.00	-22.35

Unless otherwise stated the results shown in this test report refer only to the sample(s) tested and such sample(s) are retained for 90 days only.

除非另有說明，此報告結果僅對測試之樣品負責，同時此樣品僅保留90天。本報告未經本公司書面許可，不可部份複製。

This document is issued by the Company subject to its General Conditions of Service printed overleaf, available on request or accessible at www.sgs.com/terms_and_conditions.htm and for electronic format documents, subject to Terms and Conditions for Electronic Documents at www.sgs.com/terms_e-document.htm. Attention is drawn to the limitation of liability, indemnification and jurisdiction issues defined therein. Any holder of this document is advised that information contained hereon reflects the Company's findings at the time of its intervention only and within the limits of Client's instructions, if any. The Company's sole responsibility is to its Client and this document does not exonerate parties to a transaction from exercising all their rights and obligations under the transaction documents. This document cannot be reproduced except in full, without prior written approval of the Company. Any unauthorized alteration, forgery or falsification of the content or appearance of this document is unlawful and offenders may be prosecuted to the fullest extent of the law.

Operation Band	:802.11aB3	Test Date	:2019-03-09
Fundamental Frequency	:5700 MHz	Temp./Humi.	:20 deg_C / 61 RH
Operation Mode	:Tx CH HIGH	Engineer	:Wei
EUT Pol.	:E1 Plane	Measurement Antenna Pol.	:HORIZONTAL

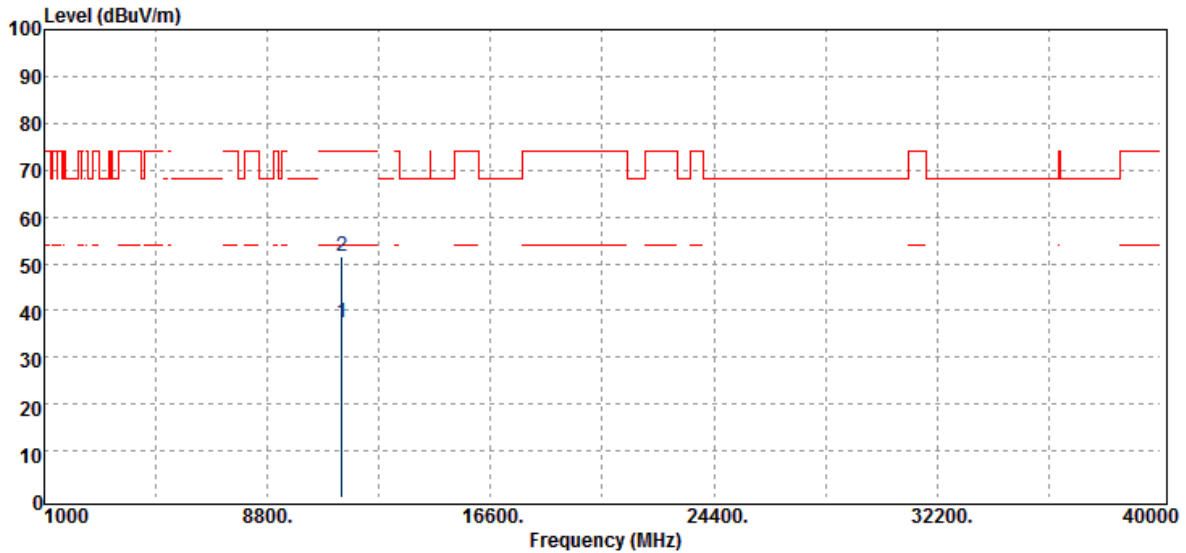

Freq. MHz	Detector Mode PK/QP/AV	Spectrum Reading Level dBuV	Factor dB	Actual FS dBuV/m	Limit @3m dBuV/m	Margin dB
11400.00	Average	21.03	16.48	37.51	54.00	-16.49
11400.00	Peak	35.00	16.48	51.48	74.00	-22.52

Unless otherwise stated the results shown in this test report refer only to the sample(s) tested and such sample(s) are retained for 90 days only.

除非另有說明，此報告結果僅對測試之樣品負責，同時此樣品僅保留90天。本報告未經本公司書面許可，不可部份複製。

This document is issued by the Company subject to its General Conditions of Service printed overleaf, available on request or accessible at www.sgs.com/terms_and_conditions.htm and for electronic format documents, subject to Terms and Conditions for Electronic Documents at www.sgs.com/terms_e-document.htm. Attention is drawn to the limitation of liability, indemnification and jurisdiction issues defined therein. Any holder of this document is advised that information contained hereon reflects the Company's findings at the time of its intervention only and within the limits of Client's instructions, if any. The Company's sole responsibility is to its Client and this document does not exonerate parties to a transaction from exercising all their rights and obligations under the transaction documents. This document cannot be reproduced except in full, without prior written approval of the Company. Any unauthorized alteration, forgery or falsification of the content or appearance of this document is unlawful and offenders may be prosecuted to the fullest extent of the law.

Operation Band :802.11a
Fundamental Frequency :5720 MHz
Operation Mode :Tx CH CH144
EUT Pol. :E1 Plane

Test Date :2019-03-13
Temp./Humi. :23 deg_C / 62 RH
Engineer :Wei
Measurement Antenna Pol. :VERTICAL

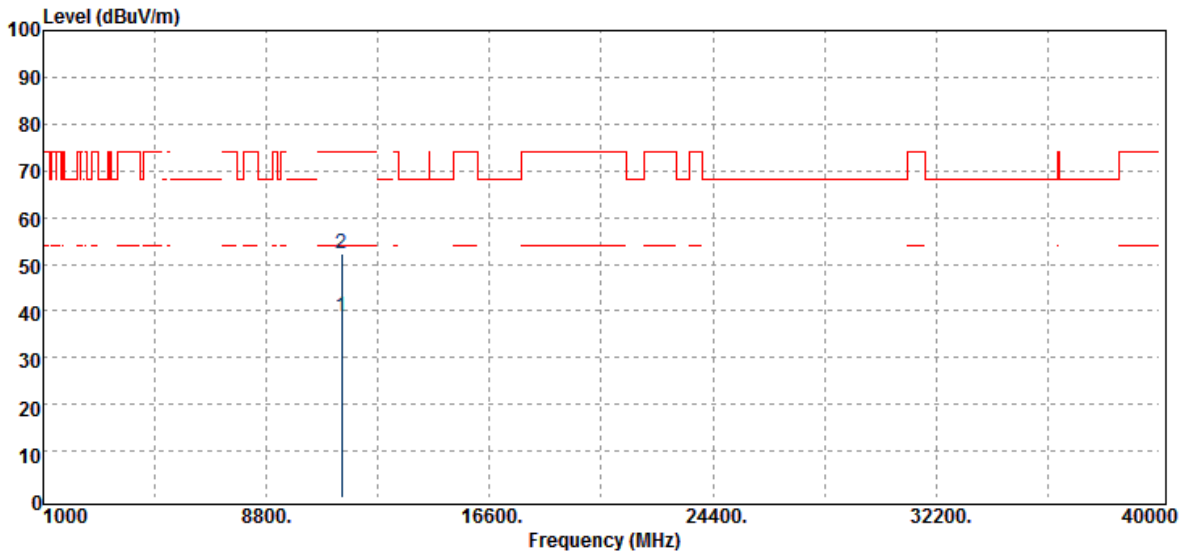

Freq. MHz	Detector Mode PK/QP/AV	Spectrum Reading Level dB μ V	Factor dB	Actual FS dB μ V/m	Limit @3m dB μ V/m	Margin dB
11440.00	Average	21.52	17.09	38.61	54.00	-15.39
11440.00	Peak	35.23	17.09	52.32	74.00	-21.68

Unless otherwise stated the results shown in this test report refer only to the sample(s) tested and such sample(s) are retained for 90 days only.

除非另有說明，此報告結果僅對測試之樣品負責，同時此樣品僅保留90天。本報告未經本公司書面許可，不可部份複製。

This document is issued by the Company subject to its General Conditions of Service printed overleaf, available on request or accessible at www.sgs.com/terms_and_conditions.htm and for electronic format documents, subject to Terms and Conditions for Electronic Documents at www.sgs.com/terms_e-document.htm. Attention is drawn to the limitation of liability, indemnification and jurisdiction issues defined therein. Any holder of this document is advised that information contained hereon reflects the Company's findings at the time of its intervention only and within the limits of Client's instructions, if any. The Company's sole responsibility is to its Client and this document does not exonerate parties to a transaction from exercising all their rights and obligations under the transaction documents. This document cannot be reproduced except in full, without prior written approval of the Company. Any unauthorized alteration, forgery or falsification of the content or appearance of this document is unlawful and offenders may be prosecuted to the fullest extent of the law.

Operation Band	:802.11a	Test Date	:2019-03-13
Fundamental Frequency	:5720 MHz	Temp./Humi.	:23 deg_C / 62 RH
Operation Mode	:Tx CH CH144	Engineer	:Wei
EUT Pol.	:E1 Plane	Measurement Antenna Pol.	:HORIZONTAL

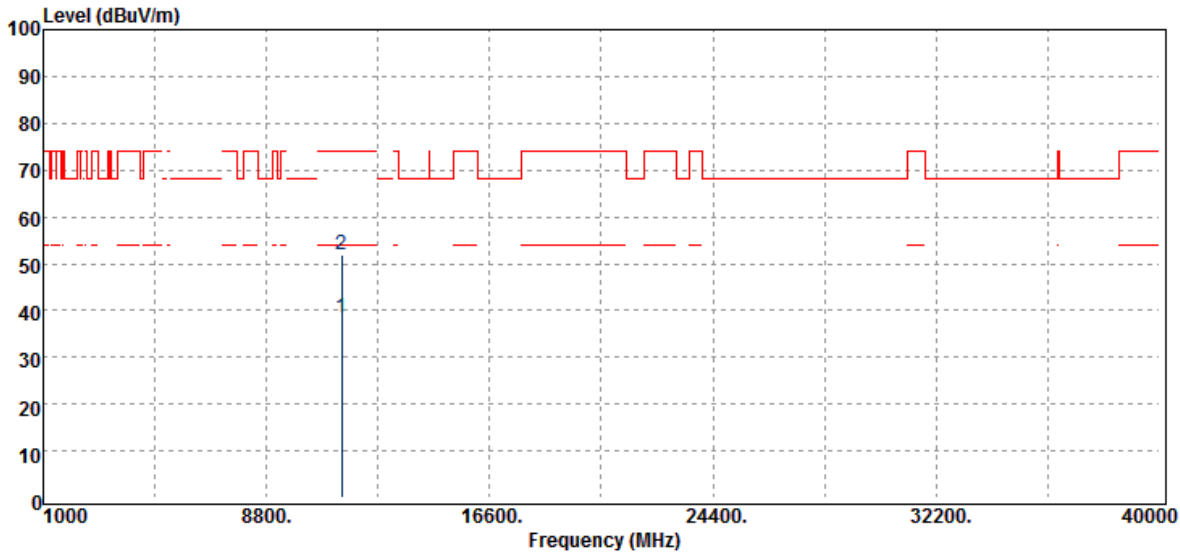

Freq. MHz	Detector Mode PK/QP/AV	Spectrum Reading Level dBuV	Factor dB	Actual FS dBuV/m	Limit @3m dBuV/m	Margin dB
11440.00	Average	21.31	17.09	38.40	54.00	-15.60
11440.00	Peak	34.74	17.09	51.83	74.00	-22.17

Unless otherwise stated the results shown in this test report refer only to the sample(s) tested and such sample(s) are retained for 90 days only.

除非另有說明，此報告結果僅對測試之樣品負責，同時此樣品僅保留90天。本報告未經本公司書面許可，不可部份複製。

This document is issued by the Company subject to its General Conditions of Service printed overleaf, available on request or accessible at www.sgs.com/terms_and_conditions.htm and for electronic format documents, subject to Terms and Conditions for Electronic Documents at www.sgs.com/terms_e-document.htm. Attention is drawn to the limitation of liability, indemnification and jurisdiction issues defined therein. Any holder of this document is advised that information contained hereon reflects the Company's findings at the time of its intervention only and within the limits of Client's instructions, if any. The Company's sole responsibility is to its Client and this document does not exonerate parties to a transaction from exercising all their rights and obligations under the transaction documents. This document cannot be reproduced except in full, without prior written approval of the Company. Any unauthorized alteration, forgery or falsification of the content or appearance of this document is unlawful and offenders may be prosecuted to the fullest extent of the law.

Radiated Spurious Emission Measurement Result 802.11a, 5745~5825 MHz

Operation Band	:802.11aB4	Test Date	:2019-03-13
Fundamental Frequency	:5745 MHz	Temp./Humi.	:23 deg_C / 62 RH
Operation Mode	:Tx CH LOW	Engineer	:Wei
EUT Pol.	:E1 Plane	Measurement Antenna Pol.	:VERTICAL

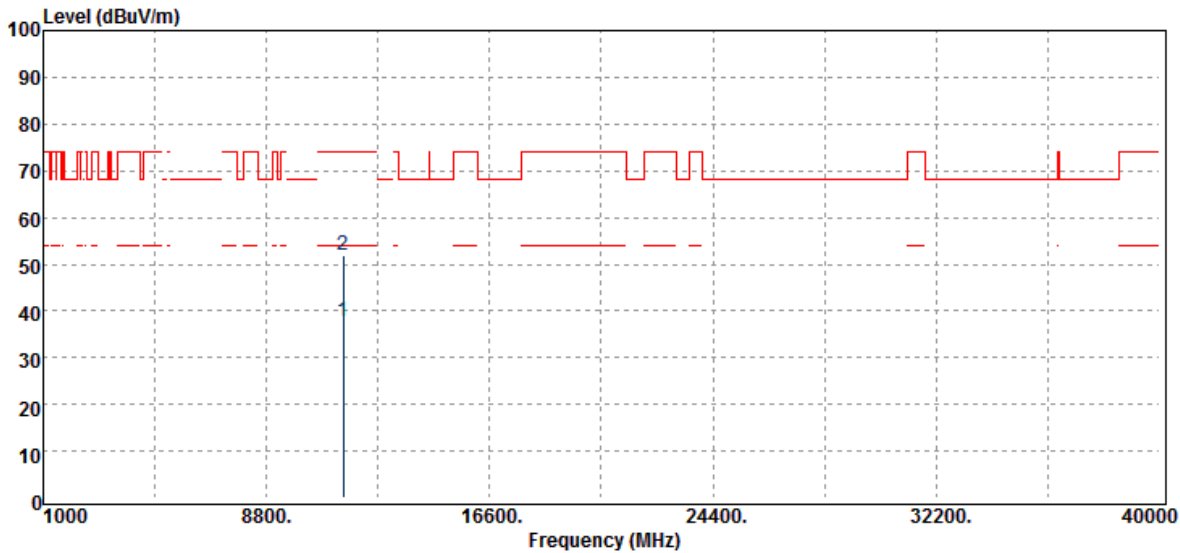

Freq. MHz	Detector Mode PK/QP/AV	Spectrum Reading Level dB μ V	Factor dB	Actual FS dB μ V/m	Limit @3m dB μ V/m	Margin dB
11490.00	Average	22.01	15.85	37.86	54.00	-16.14
11490.00	Peak	36.15	15.85	52.00	74.00	-22.00

Unless otherwise stated the results shown in this test report refer only to the sample(s) tested and such sample(s) are retained for 90 days only.

除非另有說明，此報告結果僅對測試之樣品負責，同時此樣品僅保留90天。本報告未經本公司書面許可，不可部份複製。

This document is issued by the Company subject to its General Conditions of Service printed overleaf, available on request or accessible at www.sgs.com/terms_and_conditions.htm and for electronic format documents, subject to Terms and Conditions for Electronic Documents at www.sgs.com/terms_e-document.htm. Attention is drawn to the limitation of liability, indemnification and jurisdiction issues defined therein. Any holder of this document is advised that information contained hereon reflects the Company's findings at the time of its intervention only and within the limits of Client's instructions, if any. The Company's sole responsibility is to its Client and this document does not exonerate parties to a transaction from exercising all their rights and obligations under the transaction documents. This document cannot be reproduced except in full, without prior written approval of the Company. Any unauthorized alteration, forgery or falsification of the content or appearance of this document is unlawful and offenders may be prosecuted to the fullest extent of the law.

Operation Band :802.11aB4
Fundamental Frequency :5745 MHz
Operation Mode :Tx CH LOW
EUT Pol. :E1 Plane

Test Date :2019-03-13
Temp./Humi. :23 deg_C / 62 RH
Engineer :Wei
Measurement Antenna Pol. :HORIZONTAL

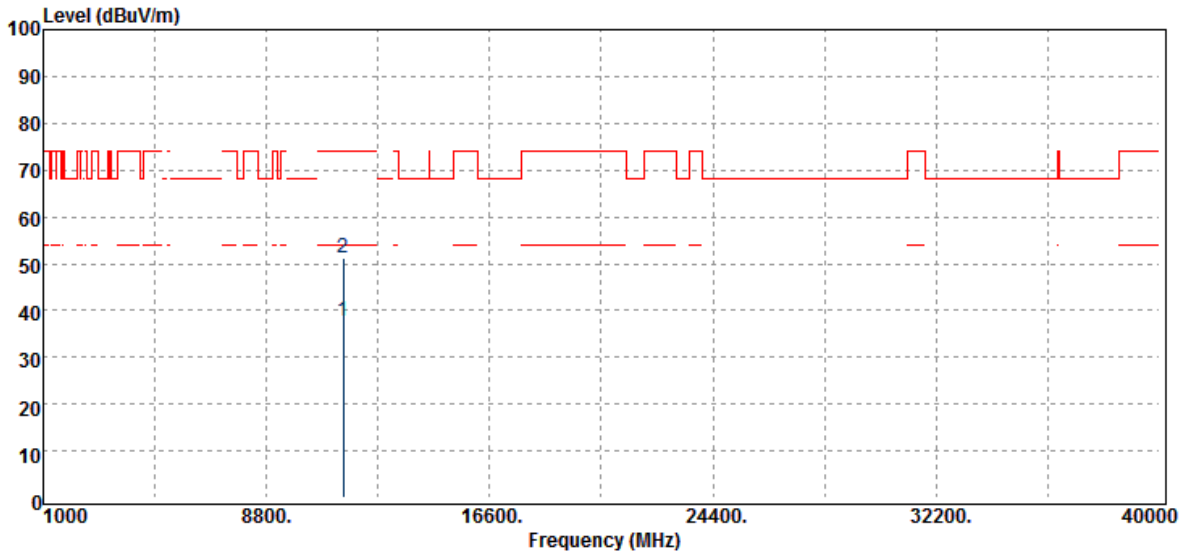

Freq. MHz	Detector Mode PK/QP/AV	Spectrum Reading Level dBuV	Factor dB	Actual FS dBuV/m	Limit @3m dBuV/m	Margin dB
11490.00	Average	21.78	15.85	37.63	54.00	-16.37
11490.00	Peak	35.38	15.85	51.23	74.00	-22.77

Unless otherwise stated the results shown in this test report refer only to the sample(s) tested and such sample(s) are retained for 90 days only.

除非另有說明，此報告結果僅對測試之樣品負責，同時此樣品僅保留90天。本報告未經本公司書面許可，不可部份複製。

This document is issued by the Company subject to its General Conditions of Service printed overleaf, available on request or accessible at www.sgs.com/terms_and_conditions.htm and for electronic format documents, subject to Terms and Conditions for Electronic Documents at www.sgs.com/terms_e-document.htm. Attention is drawn to the limitation of liability, indemnification and jurisdiction issues defined therein. Any holder of this document is advised that information contained hereon reflects the Company's findings at the time of its intervention only and within the limits of Client's instructions, if any. The Company's sole responsibility is to its Client and this document does not exonerate parties to a transaction from exercising all their rights and obligations under the transaction documents. This document cannot be reproduced except in full, without prior written approval of the Company. Any unauthorized alteration, forgery or falsification of the content or appearance of this document is unlawful and offenders may be prosecuted to the fullest extent of the law.

Operation Band :802.11aB4
Fundamental Frequency :5785 MHz
Operation Mode :Tx CH MID
EUT Pol. :E1 Plane

Test Date :2019-03-13
Temp./Humi. :23 deg_C / 62 RH
Engineer :Wei
Measurement Antenna Pol. :VERTICAL

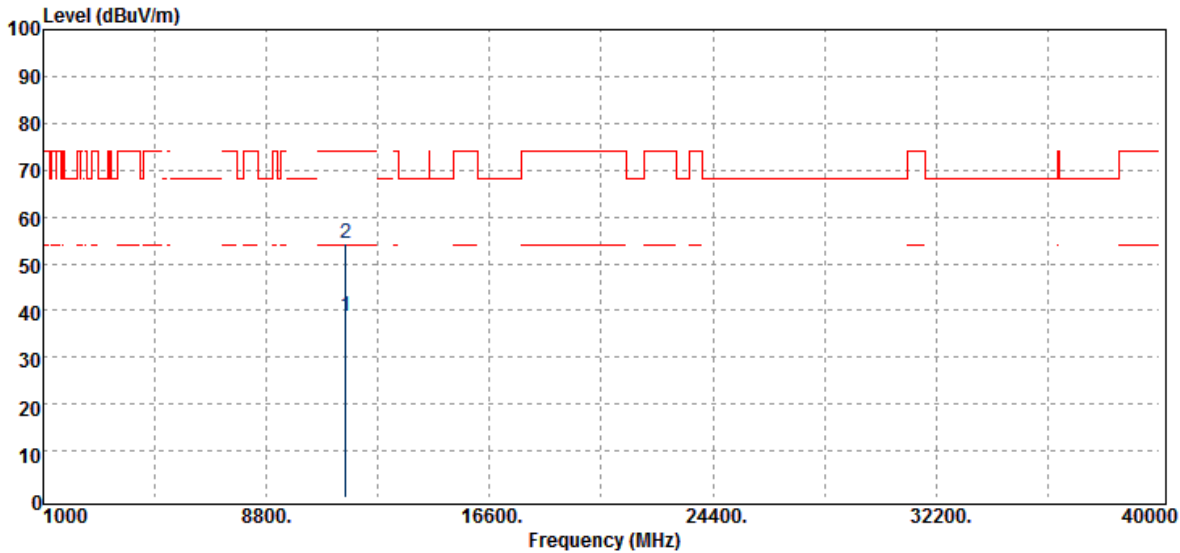

Freq. MHz	Detector Mode PK/QP/AV	Spectrum Reading Level dBuV	Factor dB	Actual FS dBuV/m	Limit @3m dBuV/m	Margin dB
11570.00	Average	22.45	16.29	38.74	54.00	-15.26
11570.00	Peak	37.96	16.29	54.25	74.00	-19.75

Unless otherwise stated the results shown in this test report refer only to the sample(s) tested and such sample(s) are retained for 90 days only.

除非另有說明，此報告結果僅對測試之樣品負責，同時此樣品僅保留90天。本報告未經本公司書面許可，不可部份複製。

This document is issued by the Company subject to its General Conditions of Service printed overleaf, available on request or accessible at www.sgs.com/terms_and_conditions.htm and for electronic format documents, subject to Terms and Conditions for Electronic Documents at www.sgs.com/terms_e-document.htm. Attention is drawn to the limitation of liability, indemnification and jurisdiction issues defined therein. Any holder of this document is advised that information contained hereon reflects the Company's findings at the time of its intervention only and within the limits of Client's instructions, if any. The Company's sole responsibility is to its Client and this document does not exonerate parties to a transaction from exercising all their rights and obligations under the transaction documents. This document cannot be reproduced except in full, without prior written approval of the Company. Any unauthorized alteration, forgery or falsification of the content or appearance of this document is unlawful and offenders may be prosecuted to the fullest extent of the law.

Operation Band :802.11aB4
Fundamental Frequency :5785 MHz
Operation Mode :Tx CH MID
EUT Pol. :E1 Plane

Test Date :2019-03-13
Temp./Humi. :23 deg_C / 62 RH
Engineer :Wei
Measurement Antenna Pol. :HORIZONTAL

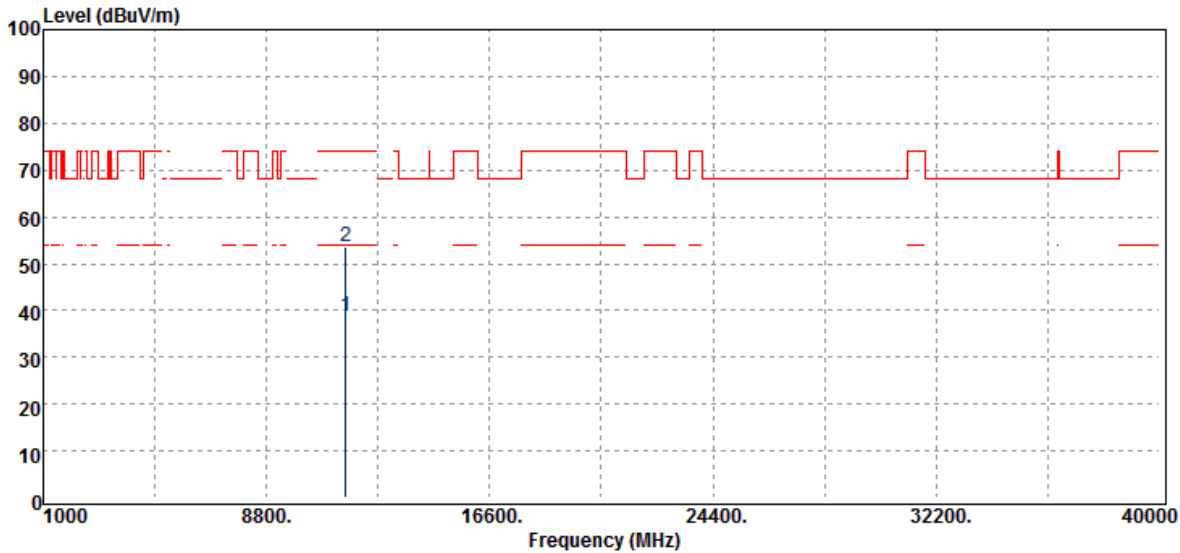

Freq. MHz	Detector Mode PK/QP/AV	Spectrum Reading Level dBuV	Factor dB	Actual FS dBuV/m	Limit @3m dBuV/m	Margin dB
11570.00	Average	22.31	16.29	38.60	54.00	-15.40
11570.00	Peak	37.46	16.29	53.75	74.00	-20.25

Unless otherwise stated the results shown in this test report refer only to the sample(s) tested and such sample(s) are retained for 90 days only.

除非另有說明，此報告結果僅對測試之樣品負責，同時此樣品僅保留90天。本報告未經本公司書面許可，不可部份複製。

This document is issued by the Company subject to its General Conditions of Service printed overleaf, available on request or accessible at www.sgs.com/terms_and_conditions.htm and for electronic format documents, subject to Terms and Conditions for Electronic Documents at www.sgs.com/terms_e-document.htm. Attention is drawn to the limitation of liability, indemnification and jurisdiction issues defined therein. Any holder of this document is advised that information contained hereon reflects the Company's findings at the time of its intervention only and within the limits of Client's instructions, if any. The Company's sole responsibility is to its Client and this document does not exonerate parties to a transaction from exercising all their rights and obligations under the transaction documents. This document cannot be reproduced except in full, without prior written approval of the Company. Any unauthorized alteration, forgery or falsification of the content or appearance of this document is unlawful and offenders may be prosecuted to the fullest extent of the law.

Operation Band	:802.11aB4	Test Date	:2019-03-13
Fundamental Frequency	:5825 MHz	Temp./Humi.	:23 deg_C / 62 RH
Operation Mode	:Tx CH HIGH	Engineer	:Wei
EUT Pol.	:E1 Plane	Measurement Antenna Pol.	:VERTICAL

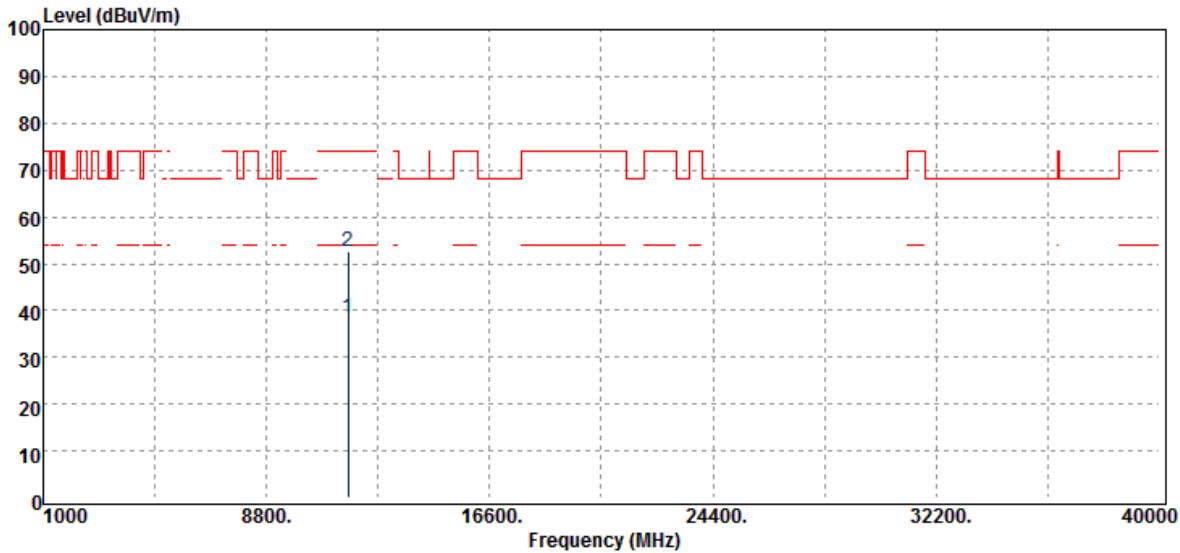

Freq. MHz	Detector Mode PK/QP/AV	Spectrum Reading Level dB μ V	Factor dB	Actual FS dB μ V/m	Limit @3m dB μ V/m	Margin dB
11650.00	Average	21.88	16.61	38.49	54.00	-15.51
11650.00	Peak	35.89	16.61	52.50	74.00	-21.50

Unless otherwise stated the results shown in this test report refer only to the sample(s) tested and such sample(s) are retained for 90 days only.

除非另有說明，此報告結果僅對測試之樣品負責，同時此樣品僅保留90天。本報告未經本公司書面許可，不可部份複製。

This document is issued by the Company subject to its General Conditions of Service printed overleaf, available on request or accessible at www.sgs.com/terms_and_conditions.htm and for electronic format documents, subject to Terms and Conditions for Electronic Documents at www.sgs.com/terms_e-document.htm. Attention is drawn to the limitation of liability, indemnification and jurisdiction issues defined therein. Any holder of this document is advised that information contained hereon reflects the Company's findings at the time of its intervention only and within the limits of Client's instructions, if any. The Company's sole responsibility is to its Client and this document does not exonerate parties to a transaction from exercising all their rights and obligations under the transaction documents. This document cannot be reproduced except in full, without prior written approval of the Company. Any unauthorized alteration, forgery or falsification of the content or appearance of this document is unlawful and offenders may be prosecuted to the fullest extent of the law.

Operation Band	:802.11aB4	Test Date	:2019-03-13
Fundamental Frequency	:5825 MHz	Temp./Humi.	:23 deg_C / 62 RH
Operation Mode	:Tx CH HIGH	Engineer	:Wei
EUT Pol.	:E1 Plane	Measurement Antenna Pol.	:HORIZONTAL

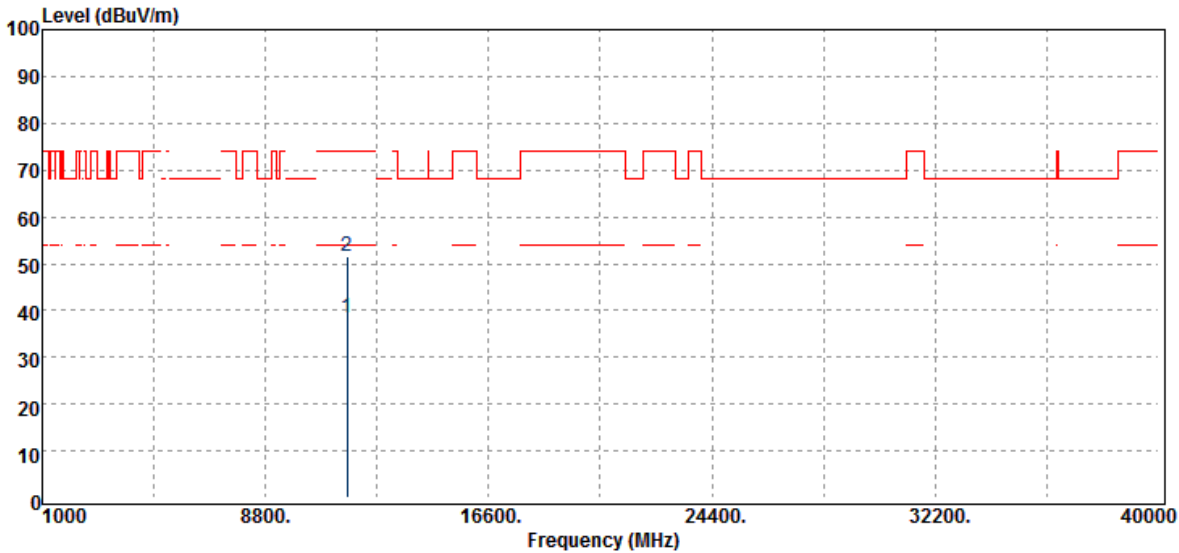

Freq. MHz	Detector Mode PK/QP/AV	Spectrum Reading Level dBuV	Factor dB	Actual FS dBuV/m	Limit @3m dBuV/m	Margin dB
11650.00	Average	21.70	16.61	38.31	54.00	-15.69
11650.00	Peak	35.04	16.61	51.65	74.00	-22.35

Unless otherwise stated the results shown in this test report refer only to the sample(s) tested and such sample(s) are retained for 90 days only.

除非另有說明，此報告結果僅對測試之樣品負責，同時此樣品僅保留90天。本報告未經本公司書面許可，不可部份複製。

This document is issued by the Company subject to its General Conditions of Service printed overleaf, available on request or accessible at www.sgs.com/terms_and_conditions.htm and for electronic format documents, subject to Terms and Conditions for Electronic Documents at www.sgs.com/terms_e-document.htm. Attention is drawn to the limitation of liability, indemnification and jurisdiction issues defined therein. Any holder of this document is advised that information contained hereon reflects the Company's findings at the time of its intervention only and within the limits of Client's instructions, if any. The Company's sole responsibility is to its Client and this document does not exonerate parties to a transaction from exercising all their rights and obligations under the transaction documents. This document cannot be reproduced except in full, without prior written approval of the Company. Any unauthorized alteration, forgery or falsification of the content or appearance of this document is unlawful and offenders may be prosecuted to the fullest extent of the law.

Radiated Spurious Emission Measurement Result 802.11n HT20, 5150~5250 MHz

Operation Band	:802.11n20B1	Test Date	:2019-03-09
Fundamental Frequency	:5180 MHz	Temp./Humi.	:20 deg_C / 61 RH
Operation Mode	:Tx CH LOW	Engineer	:Wei
EUT Pol.	:E1 Plane	Measurement Antenna Pol.	:VERTICAL

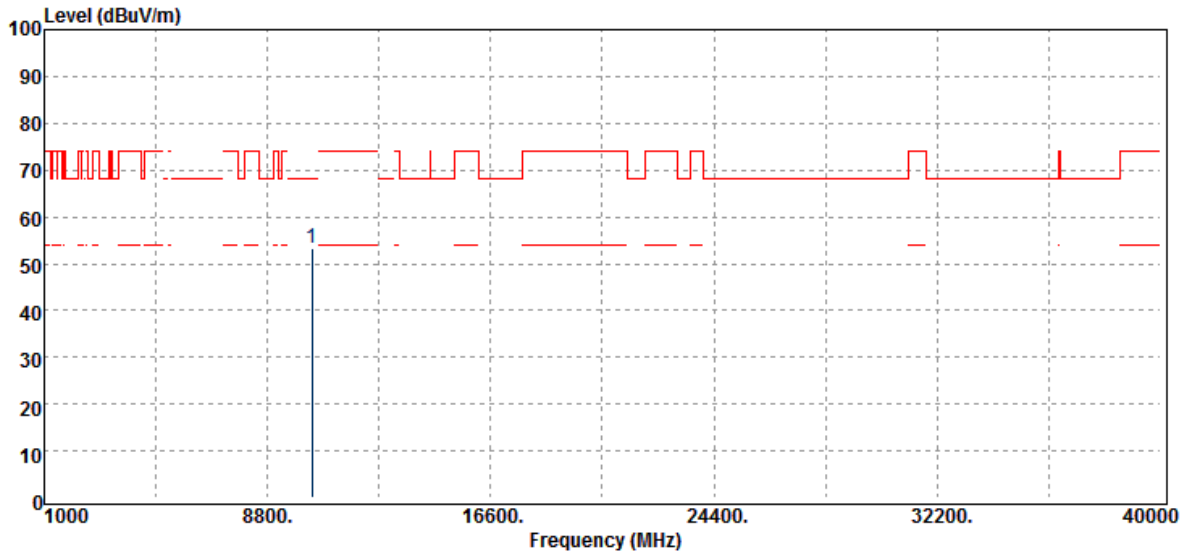

Freq. MHz	Detector Mode PK/QP/AV	Spectrum Reading Level dBuV	Factor dB	Actual FS dBuV/m	Limit @3m dBuV/m	Margin dB
10360.00	Peak	39.04	14.41	53.45	68.20	-14.75

Unless otherwise stated the results shown in this test report refer only to the sample(s) tested and such sample(s) are retained for 90 days only.

除非另有說明，此報告結果僅對測試之樣品負責，同時此樣品僅保留90天。本報告未經本公司書面許可，不可部份複製。

This document is issued by the Company subject to its General Conditions of Service printed overleaf, available on request or accessible at www.sgs.com/terms_and_conditions.htm and for electronic format documents, subject to Terms and Conditions for Electronic Documents at www.sgs.com/terms_e-document.htm. Attention is drawn to the limitation of liability, indemnification and jurisdiction issues defined therein. Any holder of this document is advised that information contained hereon reflects the Company's findings at the time of its intervention only and within the limits of Client's instructions, if any. The Company's sole responsibility is to its Client and this document does not exonerate parties to a transaction from exercising all their rights and obligations under the transaction documents. This document cannot be reproduced except in full, without prior written approval of the Company. Any unauthorized alteration, forgery or falsification of the content or appearance of this document is unlawful and offenders may be prosecuted to the fullest extent of the law.

Operation Band	:802.11n20B1	Test Date	:2019-03-09
Fundamental Frequency	:5180 MHz	Temp./Humi.	:20 deg_C / 61 RH
Operation Mode	:Tx CH LOW	Engineer	:Wei
EUT Pol.	:E1 Plane	Measurement Antenna Pol.	:HORIZONTAL

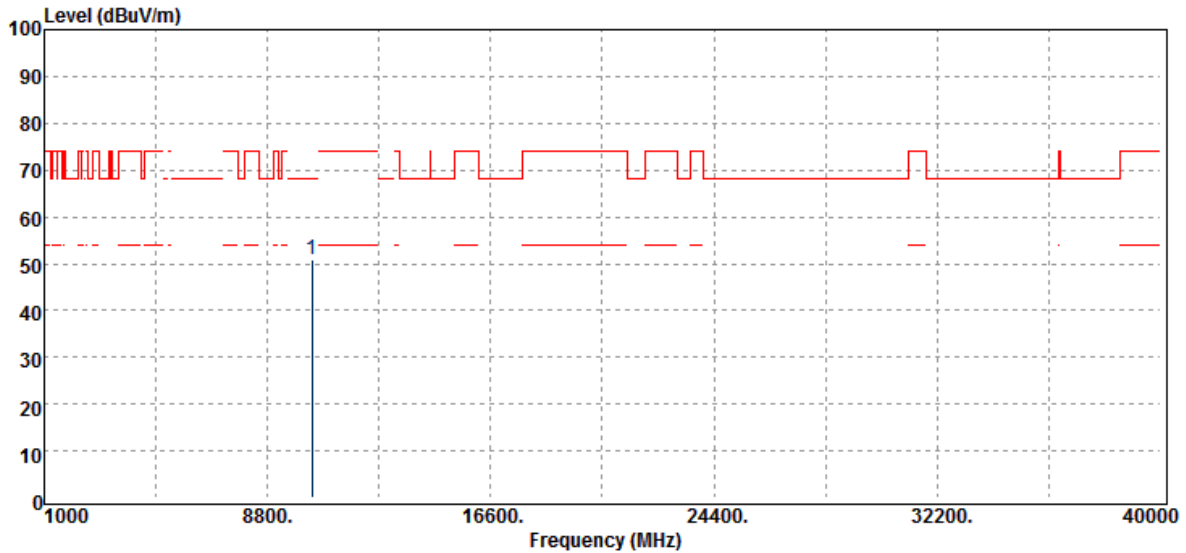

Freq. MHz	Detector Mode PK/QP/AV	Spectrum Reading Level dBuV	Factor dB	Actual FS dBuV/m	Limit @3m dBuV/m	Margin dB
10360.00	Peak	36.60	14.41	51.01	68.20	-17.19

Unless otherwise stated the results shown in this test report refer only to the sample(s) tested and such sample(s) are retained for 90 days only.

除非另有說明，此報告結果僅對測試之樣品負責，同時此樣品僅保留90天。本報告未經本公司書面許可，不可部份複製。

This document is issued by the Company subject to its General Conditions of Service printed overleaf, available on request or accessible at www.sgs.com/terms_and_conditions.htm and for electronic format documents, subject to Terms and Conditions for Electronic Documents at www.sgs.com/terms_e-document.htm. Attention is drawn to the limitation of liability, indemnification and jurisdiction issues defined therein. Any holder of this document is advised that information contained hereon reflects the Company's findings at the time of its intervention only and within the limits of Client's instructions, if any. The Company's sole responsibility is to its Client and this document does not exonerate parties to a transaction from exercising all their rights and obligations under the transaction documents. This document cannot be reproduced except in full, without prior written approval of the Company. Any unauthorized alteration, forgery or falsification of the content or appearance of this document is unlawful and offenders may be prosecuted to the fullest extent of the law.

Operation Band	:802.11n20B1	Test Date	:2019-03-09
Fundamental Frequency	:5220 MHz	Temp./Humi.	:20 deg_C / 61 RH
Operation Mode	:Tx CH MID	Engineer	:Wei
EUT Pol.	:E1 Plane	Measurement Antenna Pol.	:VERTICAL

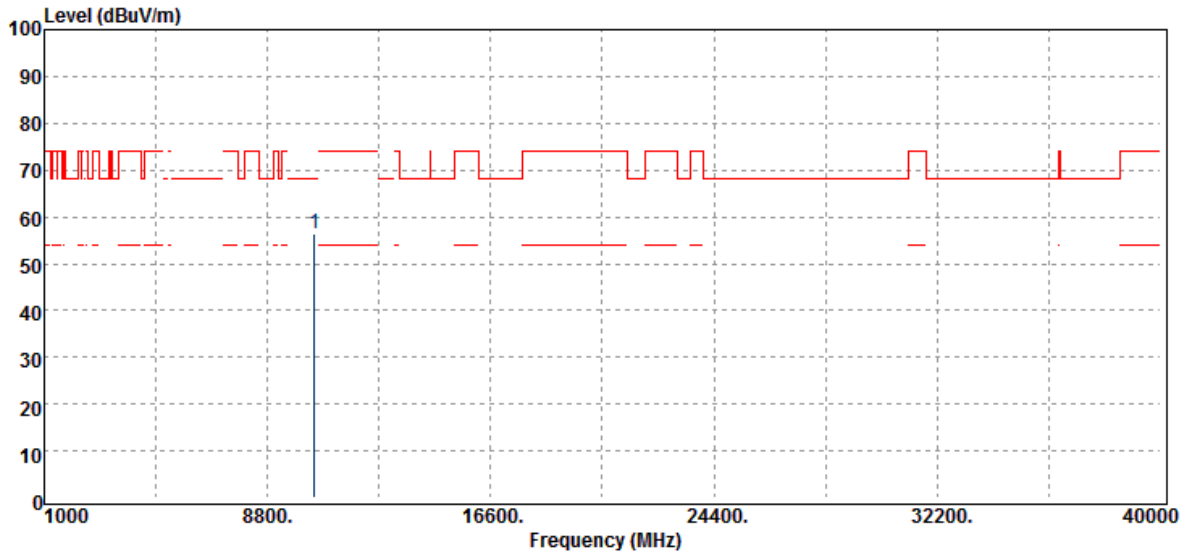

Freq. MHz	Detector Mode PK/QP/AV	Spectrum Reading Level dB μ V	Factor dB	Actual FS dB μ V/m	Limit @3m dB μ V/m	Margin dB
10440.00	Peak	40.88	15.58	56.46	68.20	-11.74

Unless otherwise stated the results shown in this test report refer only to the sample(s) tested and such sample(s) are retained for 90 days only.

除非另有說明，此報告結果僅對測試之樣品負責，同時此樣品僅保留90天。本報告未經本公司書面許可，不可部份複製。

This document is issued by the Company subject to its General Conditions of Service printed overleaf, available on request or accessible at www.sgs.com/terms_and_conditions.htm and for electronic format documents, subject to Terms and Conditions for Electronic Documents at www.sgs.com/terms_e-document.htm. Attention is drawn to the limitation of liability, indemnification and jurisdiction issues defined therein. Any holder of this document is advised that information contained hereon reflects the Company's findings at the time of its intervention only and within the limits of Client's instructions, if any. The Company's sole responsibility is to its Client and this document does not exonerate parties to a transaction from exercising all their rights and obligations under the transaction documents. This document cannot be reproduced except in full, without prior written approval of the Company. Any unauthorized alteration, forgery or falsification of the content or appearance of this document is unlawful and offenders may be prosecuted to the fullest extent of the law.

Operation Band	:802.11n20B1	Test Date	:2019-03-09
Fundamental Frequency	:5220 MHz	Temp./Humi.	:20 deg_C / 61 RH
Operation Mode	:Tx CH MID	Engineer	:Wei
EUT Pol.	:E1 Plane	Measurement Antenna Pol.	:HORIZONTAL

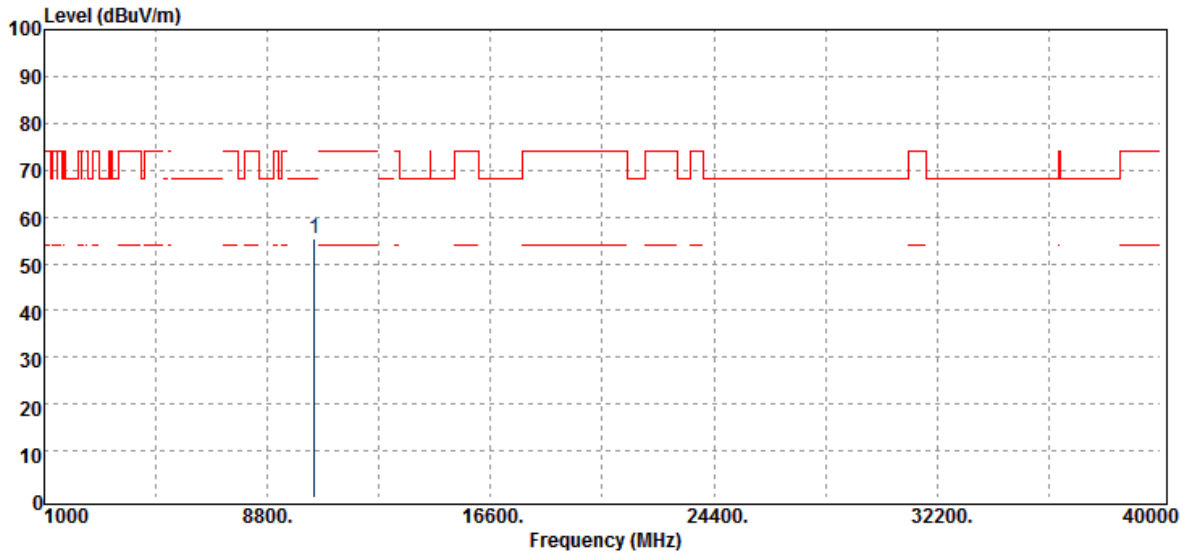

Freq. MHz	Detector Mode PK/QP/AV	Spectrum Reading Level dB μ V	Factor dB	Actual FS dB μ V/m	Limit @3m dB μ V/m	Margin dB
10440.00	Peak	39.70	15.58	55.28	68.20	-12.92

Unless otherwise stated the results shown in this test report refer only to the sample(s) tested and such sample(s) are retained for 90 days only.

除非另有說明，此報告結果僅對測試之樣品負責，同時此樣品僅保留90天。本報告未經本公司書面許可，不可部份複製。

This document is issued by the Company subject to its General Conditions of Service printed overleaf, available on request or accessible at www.sgs.com/terms_and_conditions.htm and for electronic format documents, subject to Terms and Conditions for Electronic Documents at www.sgs.com/terms_e-document.htm. Attention is drawn to the limitation of liability, indemnification and jurisdiction issues defined therein. Any holder of this document is advised that information contained hereon reflects the Company's findings at the time of its intervention only and within the limits of Client's instructions, if any. The Company's sole responsibility is to its Client and this document does not exonerate parties to a transaction from exercising all their rights and obligations under the transaction documents. This document cannot be reproduced except in full, without prior written approval of the Company. Any unauthorized alteration, forgery or falsification of the content or appearance of this document is unlawful and offenders may be prosecuted to the fullest extent of the law.

Operation Band	:802.11n20B1	Test Date	:2019-03-09
Fundamental Frequency	:5240 MHz	Temp./Humi.	:20 deg_C / 61 RH
Operation Mode	:Tx CH HIGH	Engineer	:Wei
EUT Pol.	:E1 Plane	Measurement Antenna Pol.	:VERTICAL

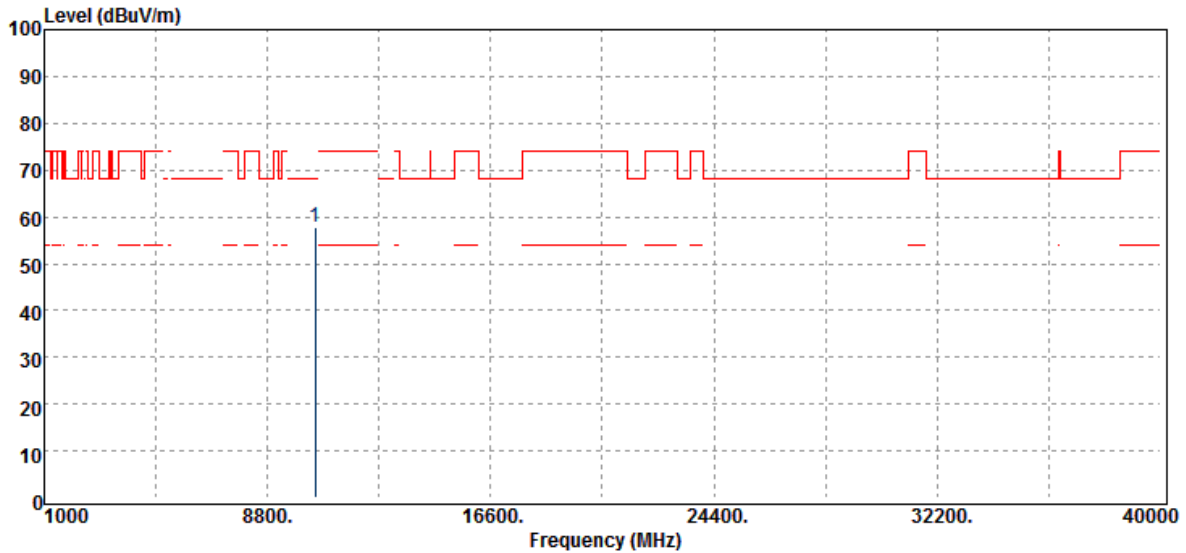

Freq. MHz	Detector Mode PK/QP/AV	Spectrum Reading Level dB μ V	Factor dB	Actual FS dB μ V/m	Limit @3m dB μ V/m	Margin dB
10480.00	Peak	41.30	16.48	57.78	68.20	-10.42

Unless otherwise stated the results shown in this test report refer only to the sample(s) tested and such sample(s) are retained for 90 days only.

除非另有說明，此報告結果僅對測試之樣品負責，同時此樣品僅保留90天。本報告未經本公司書面許可，不可部份複製。

This document is issued by the Company subject to its General Conditions of Service printed overleaf, available on request or accessible at www.sgs.com/terms_and_conditions.htm and for electronic format documents, subject to Terms and Conditions for Electronic Documents at www.sgs.com/terms_e-document.htm. Attention is drawn to the limitation of liability, indemnification and jurisdiction issues defined therein. Any holder of this document is advised that information contained hereon reflects the Company's findings at the time of its intervention only and within the limits of Client's instructions, if any. The Company's sole responsibility is to its Client and this document does not exonerate parties to a transaction from exercising all their rights and obligations under the transaction documents. This document cannot be reproduced except in full, without prior written approval of the Company. Any unauthorized alteration, forgery or falsification of the content or appearance of this document is unlawful and offenders may be prosecuted to the fullest extent of the law.

Operation Band	:802.11n20B1	Test Date	:2019-03-09
Fundamental Frequency	:5240 MHz	Temp./Humi.	:20 deg_C / 61 RH
Operation Mode	:Tx CH HIGH	Engineer	:Wei
EUT Pol.	:E1 Plane	Measurement Antenna Pol.	:HORIZONTAL

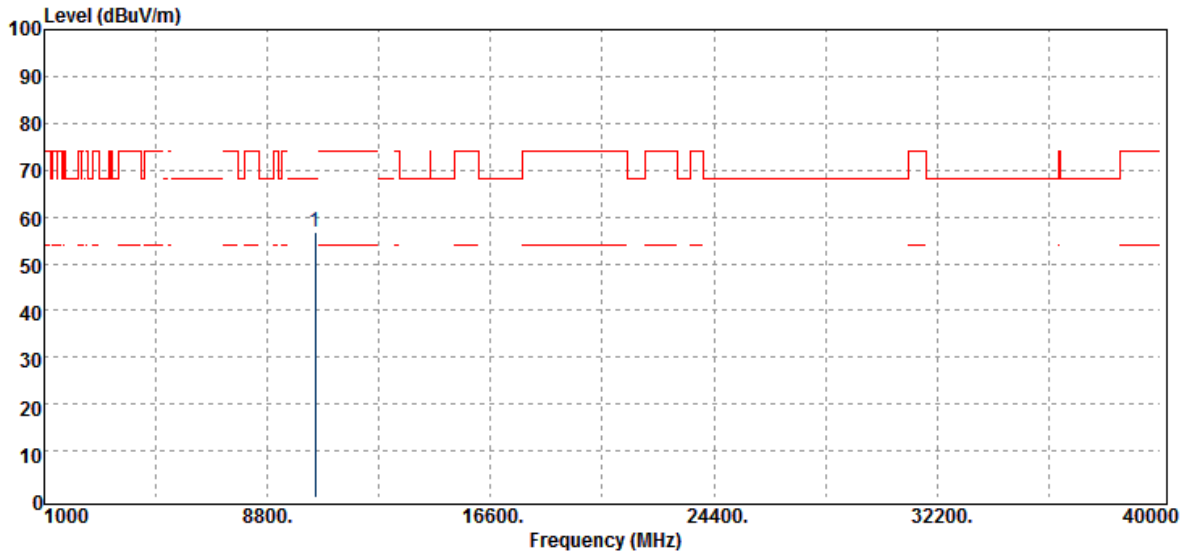

Freq. MHz	Detector Mode PK/QP/AV	Spectrum Reading Level dB μ V	Factor dB	Actual FS dB μ V/m	Limit @3m dB μ V/m	Margin dB
10480.00	Peak	40.42	16.48	56.90	68.20	-11.30

Unless otherwise stated the results shown in this test report refer only to the sample(s) tested and such sample(s) are retained for 90 days only.

除非另有說明，此報告結果僅對測試之樣品負責，同時此樣品僅保留90天。本報告未經本公司書面許可，不可部份複製。

This document is issued by the Company subject to its General Conditions of Service printed overleaf, available on request or accessible at www.sgs.com/terms_and_conditions.htm and for electronic format documents, subject to Terms and Conditions for Electronic Documents at www.sgs.com/terms_e-document.htm. Attention is drawn to the limitation of liability, indemnification and jurisdiction issues defined therein. Any holder of this document is advised that information contained hereon reflects the Company's findings at the time of its intervention only and within the limits of Client's instructions, if any. The Company's sole responsibility is to its Client and this document does not exonerate parties to a transaction from exercising all their rights and obligations under the transaction documents. This document cannot be reproduced except in full, without prior written approval of the Company. Any unauthorized alteration, forgery or falsification of the content or appearance of this document is unlawful and offenders may be prosecuted to the fullest extent of the law.

Radiated Spurious Emission Measurement Result 802.11n HT20, 5250~5350 MHz

Operation Band	:802.11n20B2	Test Date	:2019-03-09
Fundamental Frequency	:5260 MHz	Temp./Humi.	:20 deg_C / 61 RH
Operation Mode	:Tx CH LOW	Engineer	:Wei
EUT Pol.	:E1 Plane	Measurement Antenna Pol.	:VERTICAL

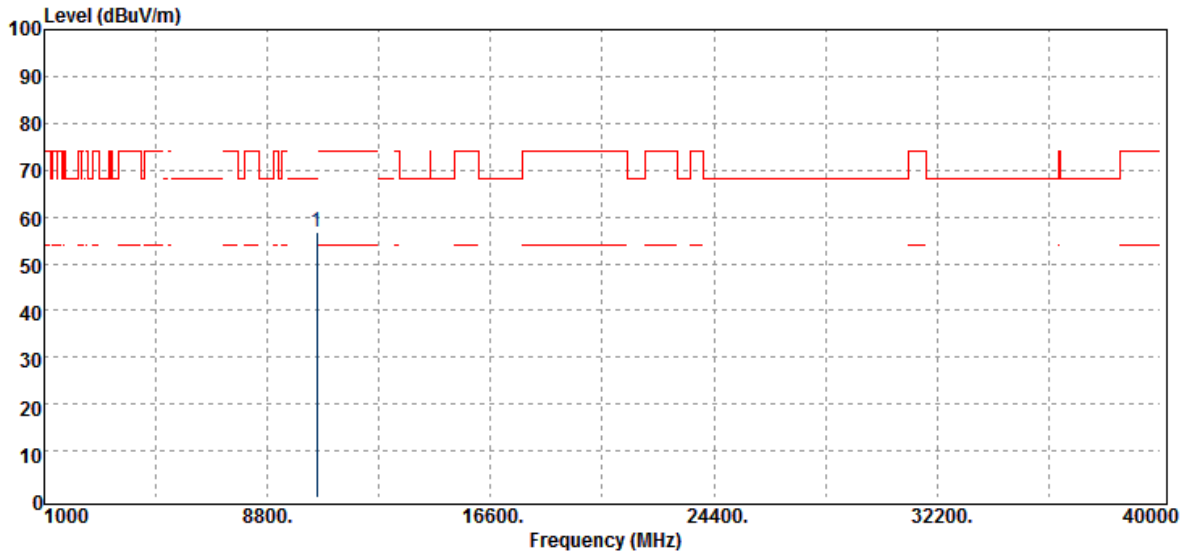

Freq. MHz	Detector Mode PK/QP/AV	Spectrum Reading Level dBuV	Factor dB	Actual FS dBuV/m	Limit @3m dBuV/m	Margin dB
10520.00	Peak	41.16	15.57	56.73	68.20	-11.47

Unless otherwise stated the results shown in this test report refer only to the sample(s) tested and such sample(s) are retained for 90 days only.

除非另有說明，此報告結果僅對測試之樣品負責，同時此樣品僅保留90天。本報告未經本公司書面許可，不可部份複製。

This document is issued by the Company subject to its General Conditions of Service printed overleaf, available on request or accessible at www.sgs.com/terms_and_conditions.htm and for electronic format documents, subject to Terms and Conditions for Electronic Documents at www.sgs.com/terms_e-document.htm. Attention is drawn to the limitation of liability, indemnification and jurisdiction issues defined therein. Any holder of this document is advised that information contained hereon reflects the Company's findings at the time of its intervention only and within the limits of Client's instructions, if any. The Company's sole responsibility is to its Client and this document does not exonerate parties to a transaction from exercising all their rights and obligations under the transaction documents. This document cannot be reproduced except in full, without prior written approval of the Company. Any unauthorized alteration, forgery or falsification of the content or appearance of this document is unlawful and offenders may be prosecuted to the fullest extent of the law.

Operation Band	:802.11n20B2	Test Date	:2019-03-09
Fundamental Frequency	:5260 MHz	Temp./Humi.	:20 deg_C / 61 RH
Operation Mode	:Tx CH LOW	Engineer	:Wei
EUT Pol.	:E1 Plane	Measurement Antenna Pol.	:HORIZONTAL

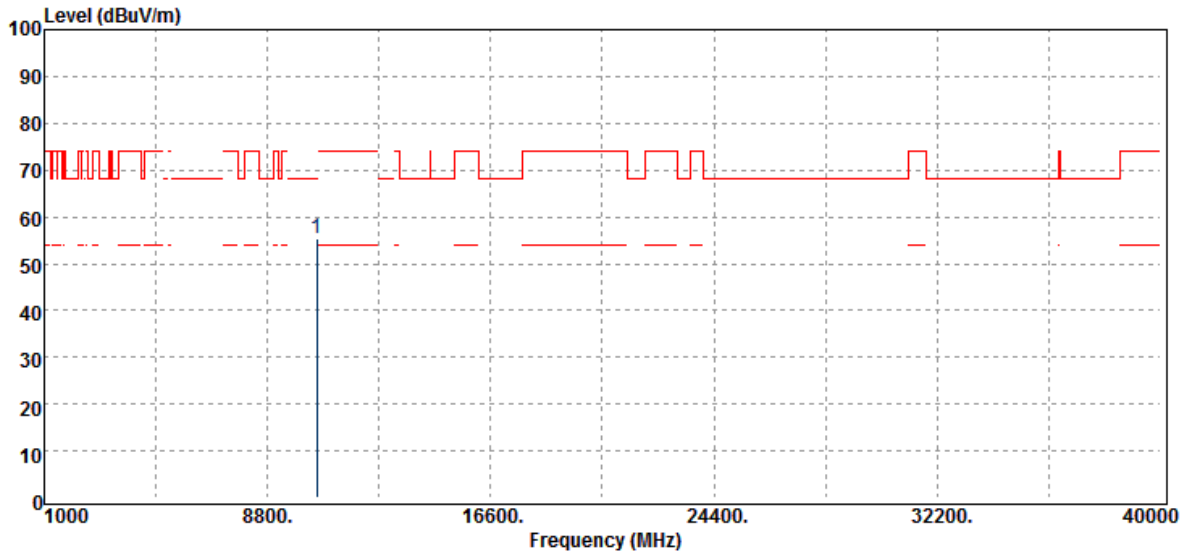

Freq. MHz	Detector Mode PK/QP/AV	Spectrum Reading Level dBuV	Factor dB	Actual FS dBuV/m	Limit @3m dBuV/m	Margin dB
10520.00	Peak	39.92	15.57	55.49	68.20	-12.71

Unless otherwise stated the results shown in this test report refer only to the sample(s) tested and such sample(s) are retained for 90 days only.

除非另有說明，此報告結果僅對測試之樣品負責，同時此樣品僅保留90天。本報告未經本公司書面許可，不可部份複製。

This document is issued by the Company subject to its General Conditions of Service printed overleaf, available on request or accessible at www.sgs.com/terms_and_conditions.htm and for electronic format documents, subject to Terms and Conditions for Electronic Documents at www.sgs.com/terms_e-document.htm. Attention is drawn to the limitation of liability, indemnification and jurisdiction issues defined therein. Any holder of this document is advised that information contained hereon reflects the Company's findings at the time of its intervention only and within the limits of Client's instructions, if any. The Company's sole responsibility is to its Client and this document does not exonerate parties to a transaction from exercising all their rights and obligations under the transaction documents. This document cannot be reproduced except in full, without prior written approval of the Company. Any unauthorized alteration, forgery or falsification of the content or appearance of this document is unlawful and offenders may be prosecuted to the fullest extent of the law.

Operation Band	:802.11n20B2	Test Date	:2019-03-09
Fundamental Frequency	:5300 MHz	Temp./Humi.	:20 deg_C / 61 RH
Operation Mode	:Tx CH MID	Engineer	:Wei
EUT Pol.	:E1 Plane	Measurement Antenna Pol.	:VERTICAL

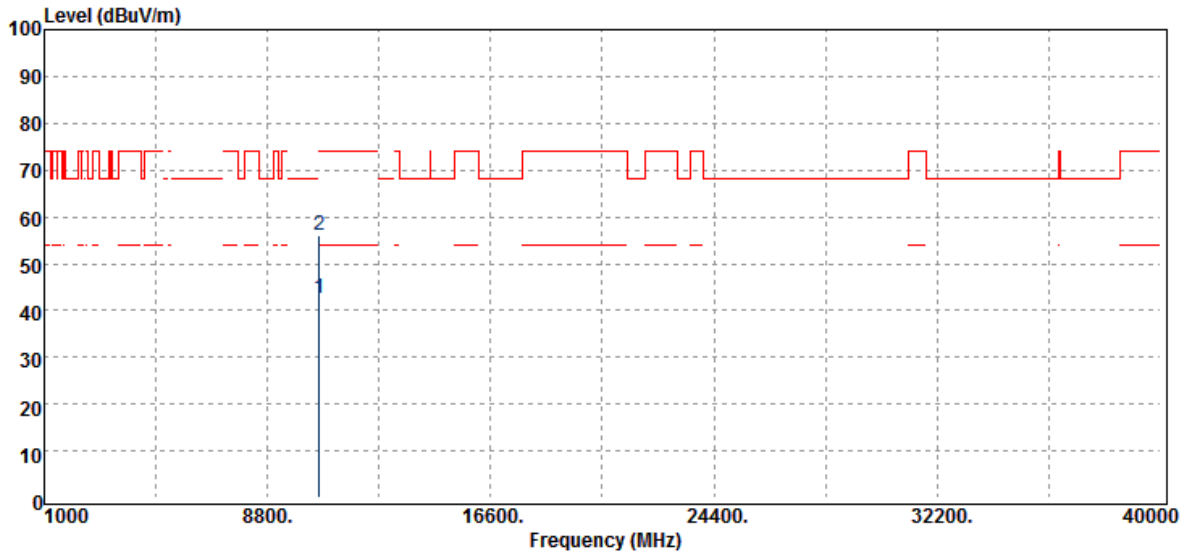

Freq. MHz	Detector Mode PK/QP/AV	Spectrum Reading Level dB μ V	Factor dB	Actual FS dB μ V/m	Limit @3m dB μ V/m	Margin dB
10600.00	Average	27.25	15.47	42.72	54.00	-11.28
10600.00	Peak	40.66	15.47	56.13	74.00	-17.87

Unless otherwise stated the results shown in this test report refer only to the sample(s) tested and such sample(s) are retained for 90 days only.

除非另有說明，此報告結果僅對測試之樣品負責，同時此樣品僅保留90天。本報告未經本公司書面許可，不可部份複製。

This document is issued by the Company subject to its General Conditions of Service printed overleaf, available on request or accessible at www.sgs.com/terms_and_conditions.htm and for electronic format documents, subject to Terms and Conditions for Electronic Documents at www.sgs.com/terms_e-document.htm. Attention is drawn to the limitation of liability, indemnification and jurisdiction issues defined therein. Any holder of this document is advised that information contained hereon reflects the Company's findings at the time of its intervention only and within the limits of Client's instructions, if any. The Company's sole responsibility is to its Client and this document does not exonerate parties to a transaction from exercising all their rights and obligations under the transaction documents. This document cannot be reproduced except in full, without prior written approval of the Company. Any unauthorized alteration, forgery or falsification of the content or appearance of this document is unlawful and offenders may be prosecuted to the fullest extent of the law.

Operation Band	:802.11n20B2	Test Date	:2019-03-09
Fundamental Frequency	:5300 MHz	Temp./Humi.	:20 deg_C / 61 RH
Operation Mode	:Tx CH MID	Engineer	:Wei
EUT Pol.	:E1 Plane	Measurement Antenna Pol.	:HORIZONTAL

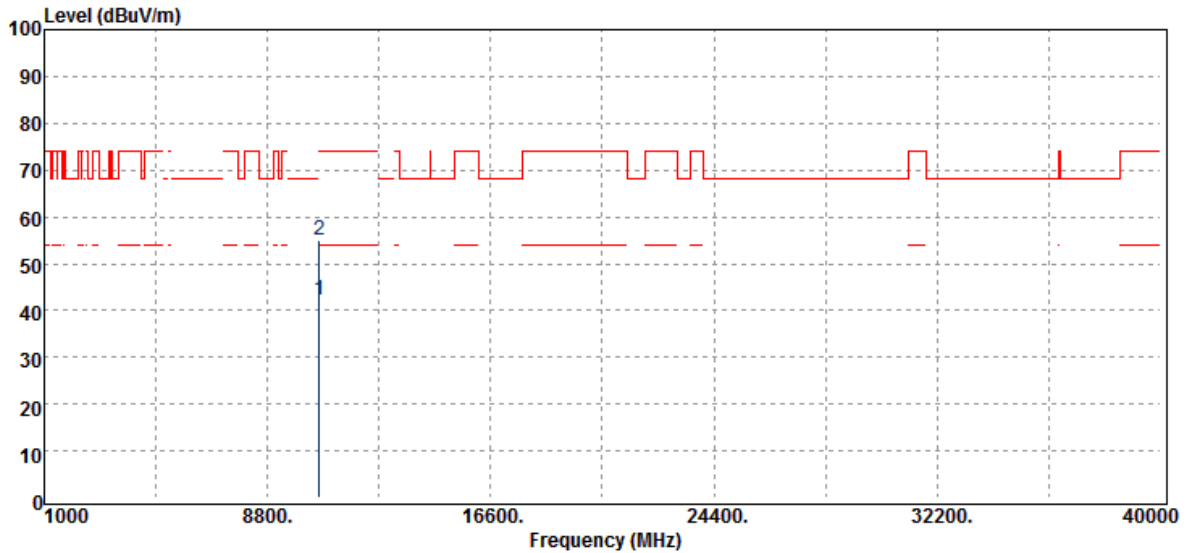

Freq. MHz	Detector Mode PK/QP/AV	Spectrum Reading Level dB μ V	Factor dB	Actual FS dB μ V/m	Limit @3m dB μ V/m	Margin dB
10600.00	Average	26.80	15.47	42.27	54.00	-11.73
10600.00	Peak	39.51	15.47	54.98	74.00	-19.02

Unless otherwise stated the results shown in this test report refer only to the sample(s) tested and such sample(s) are retained for 90 days only.

除非另有說明，此報告結果僅對測試之樣品負責，同時此樣品僅保留90天。本報告未經本公司書面許可，不可部份複製。

This document is issued by the Company subject to its General Conditions of Service printed overleaf, available on request or accessible at www.sgs.com/terms_and_conditions.htm and for electronic format documents, subject to Terms and Conditions for Electronic Documents at www.sgs.com/terms_e-document.htm. Attention is drawn to the limitation of liability, indemnification and jurisdiction issues defined therein. Any holder of this document is advised that information contained hereon reflects the Company's findings at the time of its intervention only and within the limits of Client's instructions, if any. The Company's sole responsibility is to its Client and this document does not exonerate parties to a transaction from exercising all their rights and obligations under the transaction documents. This document cannot be reproduced except in full, without prior written approval of the Company. Any unauthorized alteration, forgery or falsification of the content or appearance of this document is unlawful and offenders may be prosecuted to the fullest extent of the law.

Operation Band	:802.11n20B2	Test Date	:2019-03-09
Fundamental Frequency	:5320 MHz	Temp./Humi.	:20 deg_C / 61 RH
Operation Mode	:Tx CH HIGH	Engineer	:Wei
EUT Pol.	:E1 Plane	Measurement Antenna Pol.	:VERTICAL

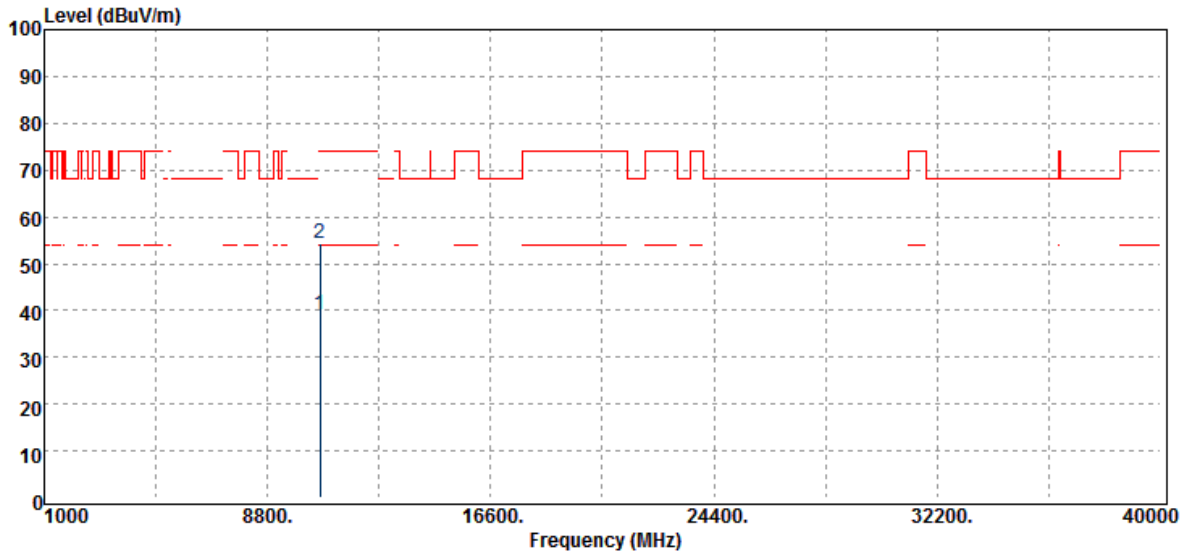

Freq. MHz	Detector Mode PK/QP/AV	Spectrum Reading Level dBuV	Factor dB	Actual FS dBuV/m	Limit @3m dBuV/m	Margin dB
10640.00	Average	22.92	16.12	39.04	54.00	-14.96
10640.00	Peak	38.17	16.12	54.29	74.00	-19.71

Unless otherwise stated the results shown in this test report refer only to the sample(s) tested and such sample(s) are retained for 90 days only.

除非另有說明，此報告結果僅對測試之樣品負責，同時此樣品僅保留90天。本報告未經本公司書面許可，不可部份複製。

This document is issued by the Company subject to its General Conditions of Service printed overleaf, available on request or accessible at www.sgs.com/terms_and_conditions.htm and for electronic format documents, subject to Terms and Conditions for Electronic Documents at www.sgs.com/terms_e-document.htm. Attention is drawn to the limitation of liability, indemnification and jurisdiction issues defined therein. Any holder of this document is advised that information contained hereon reflects the Company's findings at the time of its intervention only and within the limits of Client's instructions, if any. The Company's sole responsibility is to its Client and this document does not exonerate parties to a transaction from exercising all their rights and obligations under the transaction documents. This document cannot be reproduced except in full, without prior written approval of the Company. Any unauthorized alteration, forgery or falsification of the content or appearance of this document is unlawful and offenders may be prosecuted to the fullest extent of the law.

Operation Band	:802.11n20B2	Test Date	:2019-03-09
Fundamental Frequency	:5320 MHz	Temp./Humi.	:20 deg_C / 61 RH
Operation Mode	:Tx CH HIGH	Engineer	:Wei
EUT Pol.	:E1 Plane	Measurement Antenna Pol.	:HORIZONTAL

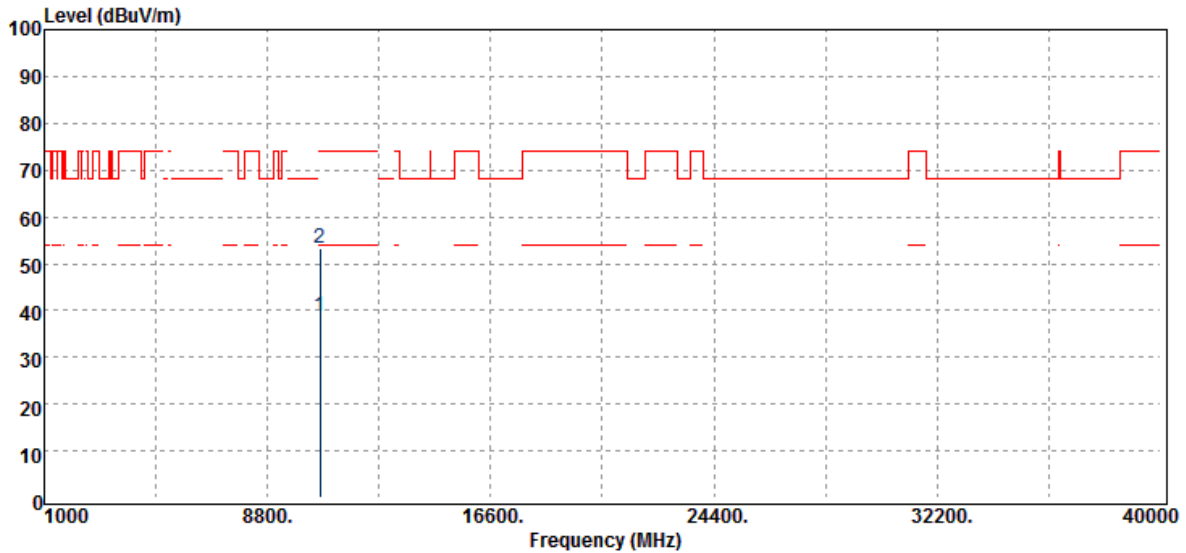

Freq. MHz	Detector Mode PK/QP/AV	Spectrum Reading Level dB μ V	Factor dB	Actual FS dB μ V/m	Limit @3m dB μ V/m	Margin dB
10640.00	Average	22.58	16.12	38.70	54.00	-15.30
10640.00	Peak	37.26	16.12	53.38	74.00	-20.62

Unless otherwise stated the results shown in this test report refer only to the sample(s) tested and such sample(s) are retained for 90 days only.

除非另有說明，此報告結果僅對測試之樣品負責，同時此樣品僅保留90天。本報告未經本公司書面許可，不可部份複製。

This document is issued by the Company subject to its General Conditions of Service printed overleaf, available on request or accessible at www.sgs.com/terms_and_conditions.htm and for electronic format documents, subject to Terms and Conditions for Electronic Documents at www.sgs.com/terms_e-document.htm. Attention is drawn to the limitation of liability, indemnification and jurisdiction issues defined therein. Any holder of this document is advised that information contained hereon reflects the Company's findings at the time of its intervention only and within the limits of Client's instructions, if any. The Company's sole responsibility is to its Client and this document does not exonerate parties to a transaction from exercising all their rights and obligations under the transaction documents. This document cannot be reproduced except in full, without prior written approval of the Company. Any unauthorized alteration, forgery or falsification of the content or appearance of this document is unlawful and offenders may be prosecuted to the fullest extent of the law.

Radiated Spurious Emission Measurement Result 802.11n HT20, 5470~5725 MHz

Operation Band	:802.11n20B3	Test Date	:2019-03-09
Fundamental Frequency	:5500 MHz	Temp./Humi.	:20 deg_C / 61 RH
Operation Mode	:Tx CH LOW	Engineer	:Wei
EUT Pol.	:E1 Plane	Measurement Antenna Pol.	:VERTICAL

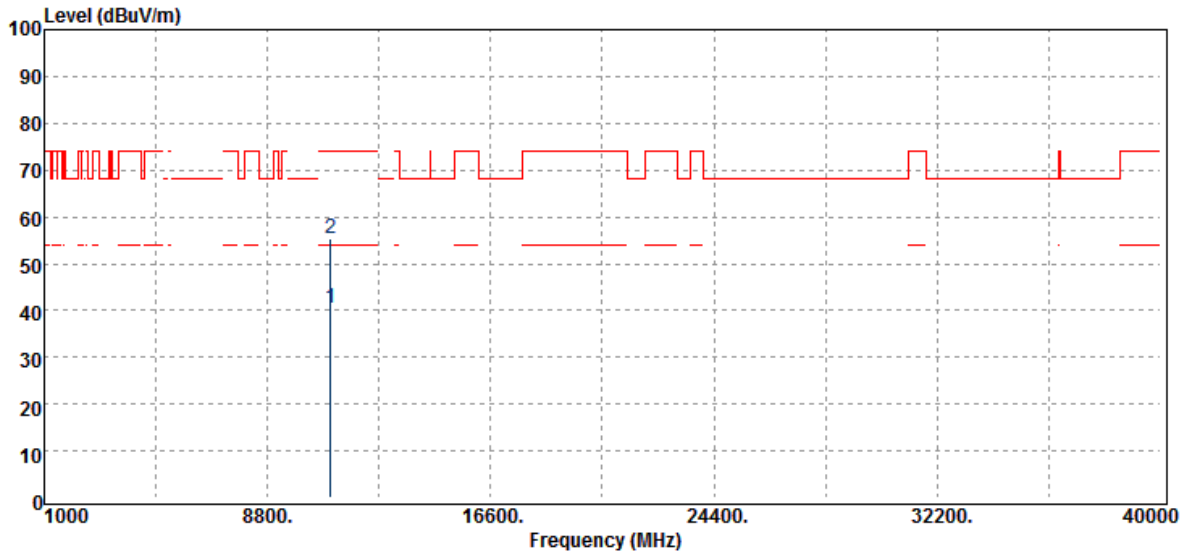

Freq. MHz	Detector Mode PK/QP/AV	Spectrum Reading Level dBuV	Factor dB	Actual FS dBuV/m	Limit @3m dBuV/m	Margin dB
11000.00	Average	22.71	17.75	40.46	54.00	-13.54
11000.00	Peak	37.75	17.75	55.50	74.00	-18.50

Unless otherwise stated the results shown in this test report refer only to the sample(s) tested and such sample(s) are retained for 90 days only.

除非另有說明，此報告結果僅對測試之樣品負責，同時此樣品僅保留90天。本報告未經本公司書面許可，不可部份複製。

This document is issued by the Company subject to its General Conditions of Service printed overleaf, available on request or accessible at www.sgs.com/terms_and_conditions.htm and for electronic format documents, subject to Terms and Conditions for Electronic Documents at www.sgs.com/terms_e-document.htm. Attention is drawn to the limitation of liability, indemnification and jurisdiction issues defined therein. Any holder of this document is advised that information contained hereon reflects the Company's findings at the time of its intervention only and within the limits of Client's instructions, if any. The Company's sole responsibility is to its Client and this document does not exonerate parties to a transaction from exercising all their rights and obligations under the transaction documents. This document cannot be reproduced except in full, without prior written approval of the Company. Any unauthorized alteration, forgery or falsification of the content or appearance of this document is unlawful and offenders may be prosecuted to the fullest extent of the law.

Operation Band	:802.11n20B3	Test Date	:2019-03-09
Fundamental Frequency	:5500 MHz	Temp./Humi.	:20 deg_C / 61 RH
Operation Mode	:Tx CH LOW	Engineer	:Wei
EUT Pol.	:E1 Plane	Measurement Antenna Pol.	:HORIZONTAL

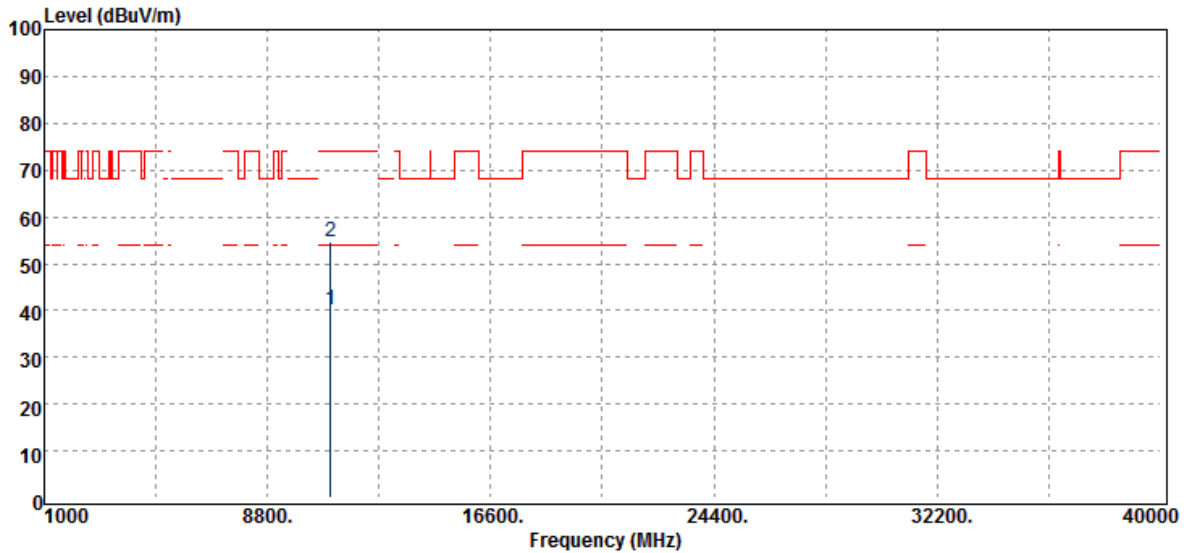

Freq. MHz	Detector Mode PK/QP/AV	Spectrum Reading Level dB μ V	Factor dB	Actual FS dB μ V/m	Limit @3m dB μ V/m	Margin dB
11000.00	Average	22.24	17.75	39.99	54.00	-14.01
11000.00	Peak	37.08	17.75	54.83	74.00	-19.17

Unless otherwise stated the results shown in this test report refer only to the sample(s) tested and such sample(s) are retained for 90 days only.

除非另有說明，此報告結果僅對測試之樣品負責，同時此樣品僅保留90天。本報告未經本公司書面許可，不可部份複製。

This document is issued by the Company subject to its General Conditions of Service printed overleaf, available on request or accessible at www.sgs.com/terms_and_conditions.htm and for electronic format documents, subject to Terms and Conditions for Electronic Documents at www.sgs.com/terms_e-document.htm. Attention is drawn to the limitation of liability, indemnification and jurisdiction issues defined therein. Any holder of this document is advised that information contained hereon reflects the Company's findings at the time of its intervention only and within the limits of Client's instructions, if any. The Company's sole responsibility is to its Client and this document does not exonerate parties to a transaction from exercising all their rights and obligations under the transaction documents. This document cannot be reproduced except in full, without prior written approval of the Company. Any unauthorized alteration, forgery or falsification of the content or appearance of this document is unlawful and offenders may be prosecuted to the fullest extent of the law.

Operation Band	:802.11n20B3	Test Date	:2019-03-09
Fundamental Frequency	:5580 MHz	Temp./Humi.	:20 deg_C / 61 RH
Operation Mode	:Tx CH MID	Engineer	:Wei
EUT Pol.	:E1 Plane	Measurement Antenna Pol.	:VERTICAL

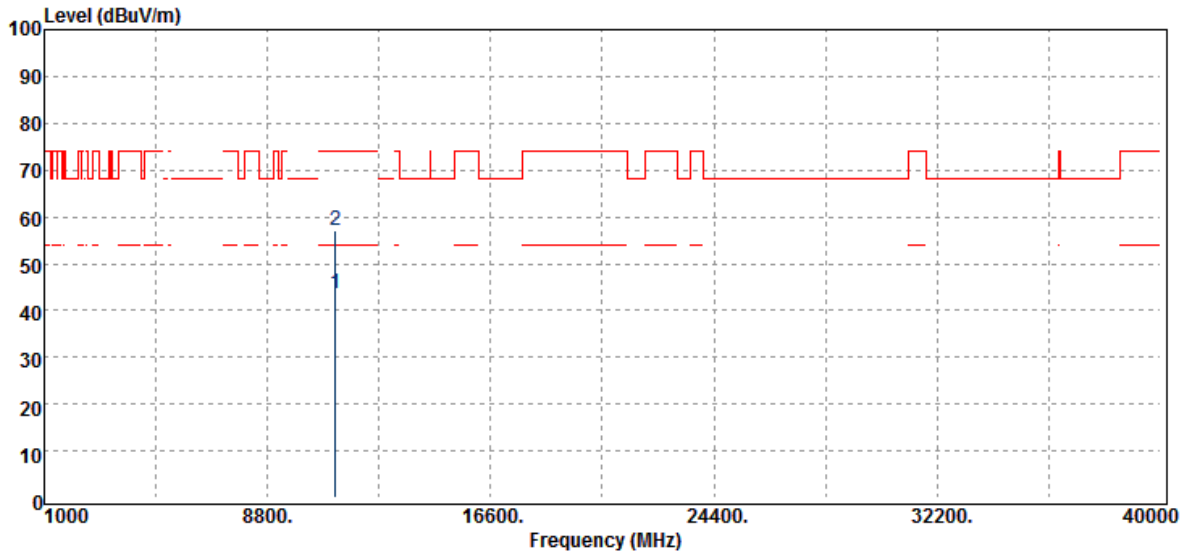

Freq. MHz	Detector Mode PK/QP/AV	Spectrum Reading Level dB μ V	Factor dB	Actual FS dB μ V/m	Limit @3m dB μ V/m	Margin dB
11160.00	Average	27.22	16.53	43.75	54.00	-10.25
11160.00	Peak	40.46	16.53	56.99	74.00	-17.01

Unless otherwise stated the results shown in this test report refer only to the sample(s) tested and such sample(s) are retained for 90 days only.

除非另有說明，此報告結果僅對測試之樣品負責，同時此樣品僅保留90天。本報告未經本公司書面許可，不可部份複製。

This document is issued by the Company subject to its General Conditions of Service printed overleaf, available on request or accessible at www.sgs.com/terms_and_conditions.htm and for electronic format documents, subject to Terms and Conditions for Electronic Documents at www.sgs.com/terms_e-document.htm. Attention is drawn to the limitation of liability, indemnification and jurisdiction issues defined therein. Any holder of this document is advised that information contained hereon reflects the Company's findings at the time of its intervention only and within the limits of Client's instructions, if any. The Company's sole responsibility is to its Client and this document does not exonerate parties to a transaction from exercising all their rights and obligations under the transaction documents. This document cannot be reproduced except in full, without prior written approval of the Company. Any unauthorized alteration, forgery or falsification of the content or appearance of this document is unlawful and offenders may be prosecuted to the fullest extent of the law.

Operation Band	:802.11n20B3	Test Date	:2019-03-09
Fundamental Frequency	:5580 MHz	Temp./Humi.	:20 deg_C / 61 RH
Operation Mode	:Tx CH MID	Engineer	:Wei
EUT Pol.	:E1 Plane	Measurement Antenna Pol.	:HORIZONTAL

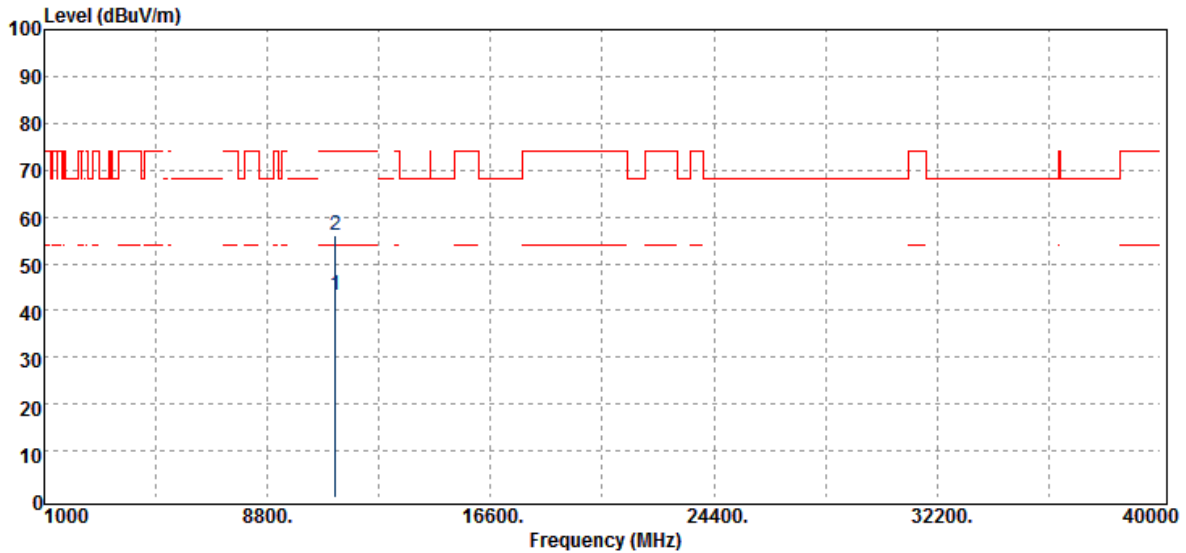

Freq. MHz	Detector Mode PK/QP/AV	Spectrum Reading Level dB μ V	Factor dB	Actual FS dB μ V/m	Limit @3m dB μ V/m	Margin dB
11160.00	Average	26.88	16.53	43.41	54.00	-10.59
11160.00	Peak	39.69	16.53	56.22	74.00	-17.78

Unless otherwise stated the results shown in this test report refer only to the sample(s) tested and such sample(s) are retained for 90 days only.

除非另有說明，此報告結果僅對測試之樣品負責，同時此樣品僅保留90天。本報告未經本公司書面許可，不可部份複製。

This document is issued by the Company subject to its General Conditions of Service printed overleaf, available on request or accessible at www.sgs.com/terms_and_conditions.htm and for electronic format documents, subject to Terms and Conditions for Electronic Documents at www.sgs.com/terms_e-document.htm. Attention is drawn to the limitation of liability, indemnification and jurisdiction issues defined therein. Any holder of this document is advised that information contained hereon reflects the Company's findings at the time of its intervention only and within the limits of Client's instructions, if any. The Company's sole responsibility is to its Client and this document does not exonerate parties to a transaction from exercising all their rights and obligations under the transaction documents. This document cannot be reproduced except in full, without prior written approval of the Company. Any unauthorized alteration, forgery or falsification of the content or appearance of this document is unlawful and offenders may be prosecuted to the fullest extent of the law.

Operation Band	:802.11n20B3	Test Date	:2019-03-09
Fundamental Frequency	:5700 MHz	Temp./Humi.	:20 deg_C / 61 RH
Operation Mode	:Tx CH HIGH	Engineer	:Wei
EUT Pol.	:E1 Plane	Measurement Antenna Pol.	:VERTICAL

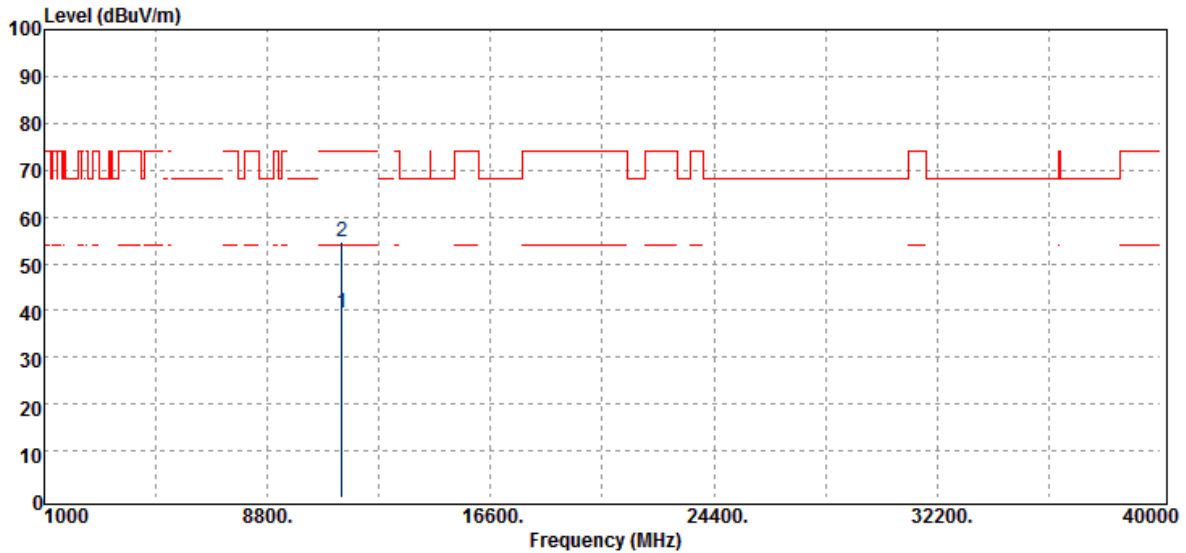

Freq. MHz	Detector Mode PK/QP/AV	Spectrum Reading Level dB μ V	Factor dB	Actual FS dB μ V/m	Limit @3m dB μ V/m	Margin dB
11400.00	Average	23.10	16.48	39.58	54.00	-14.42
11400.00	Peak	38.31	16.48	54.79	74.00	-19.21

Unless otherwise stated the results shown in this test report refer only to the sample(s) tested and such sample(s) are retained for 90 days only.

除非另有說明，此報告結果僅對測試之樣品負責，同時此樣品僅保留90天。本報告未經本公司書面許可，不可部份複製。

This document is issued by the Company subject to its General Conditions of Service printed overleaf, available on request or accessible at www.sgs.com/terms_and_conditions.htm and for electronic format documents, subject to Terms and Conditions for Electronic Documents at www.sgs.com/terms_e-document.htm. Attention is drawn to the limitation of liability, indemnification and jurisdiction issues defined therein. Any holder of this document is advised that information contained hereon reflects the Company's findings at the time of its intervention only and within the limits of Client's instructions, if any. The Company's sole responsibility is to its Client and this document does not exonerate parties to a transaction from exercising all their rights and obligations under the transaction documents. This document cannot be reproduced except in full, without prior written approval of the Company. Any unauthorized alteration, forgery or falsification of the content or appearance of this document is unlawful and offenders may be prosecuted to the fullest extent of the law.

Operation Band	:802.11n20B3	Test Date	:2019-03-09
Fundamental Frequency	:5700 MHz	Temp./Humi.	:20 deg_C / 61 RH
Operation Mode	:Tx CH HIGH	Engineer	:Wei
EUT Pol.	:E1 Plane	Measurement Antenna Pol.	:HORIZONTAL

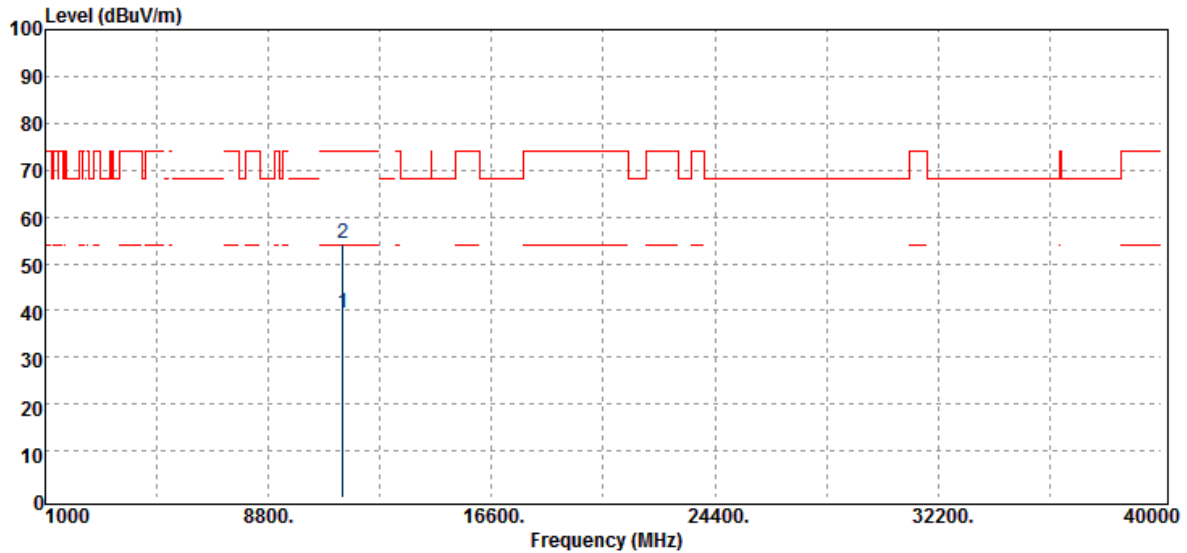

Freq. MHz	Detector Mode PK/QP/AV	Spectrum Reading Level dB μ V	Factor dB	Actual FS dB μ V/m	Limit @3m dB μ V/m	Margin dB
11400.00	Average	22.90	16.48	39.38	54.00	-14.62
11400.00	Peak	37.82	16.48	54.30	74.00	-19.70

Unless otherwise stated the results shown in this test report refer only to the sample(s) tested and such sample(s) are retained for 90 days only.

除非另有說明，此報告結果僅對測試之樣品負責，同時此樣品僅保留90天。本報告未經本公司書面許可，不可部份複製。

This document is issued by the Company subject to its General Conditions of Service printed overleaf, available on request or accessible at www.sgs.com/terms_and_conditions.htm and for electronic format documents, subject to Terms and Conditions for Electronic Documents at www.sgs.com/terms_e-document.htm. Attention is drawn to the limitation of liability, indemnification and jurisdiction issues defined therein. Any holder of this document is advised that information contained hereon reflects the Company's findings at the time of its intervention only and within the limits of Client's instructions, if any. The Company's sole responsibility is to its Client and this document does not exonerate parties to a transaction from exercising all their rights and obligations under the transaction documents. This document cannot be reproduced except in full, without prior written approval of the Company. Any unauthorized alteration, forgery or falsification of the content or appearance of this document is unlawful and offenders may be prosecuted to the fullest extent of the law.

Operation Band :802.11n20
Fundamental Frequency :5720 MHz
Operation Mode :Tx CH CH144
EUT Pol. :E1 Plane

Test Date :2019-03-13
Temp./Humi. :23 deg_C / 62 RH
Engineer :Wei
Measurement Antenna Pol. :VERTICAL

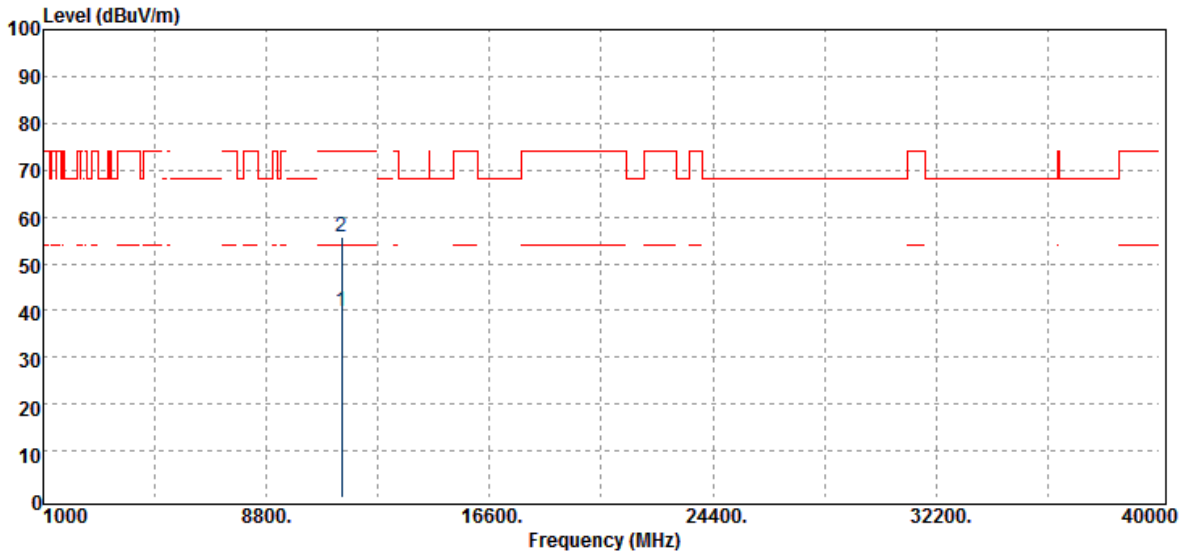

Freq. MHz	Detector Mode PK/QP/AV	Spectrum Reading Level dB μ V	Factor dB	Actual FS dB μ V/m	Limit @3m dB μ V/m	Margin dB
11440.00	Average	22.76	17.09	39.85	54.00	-14.15
11440.00	Peak	38.61	17.09	55.70	74.00	-18.30

Unless otherwise stated the results shown in this test report refer only to the sample(s) tested and such sample(s) are retained for 90 days only.

除非另有說明，此報告結果僅對測試之樣品負責，同時此樣品僅保留90天。本報告未經本公司書面許可，不可部份複製。

This document is issued by the Company subject to its General Conditions of Service printed overleaf, available on request or accessible at www.sgs.com/terms_and_conditions.htm and for electronic format documents, subject to Terms and Conditions for Electronic Documents at www.sgs.com/terms_e-document.htm. Attention is drawn to the limitation of liability, indemnification and jurisdiction issues defined therein. Any holder of this document is advised that information contained hereon reflects the Company's findings at the time of its intervention only and within the limits of Client's instructions, if any. The Company's sole responsibility is to its Client and this document does not exonerate parties to a transaction from exercising all their rights and obligations under the transaction documents. This document cannot be reproduced except in full, without prior written approval of the Company. Any unauthorized alteration, forgery or falsification of the content or appearance of this document is unlawful and offenders may be prosecuted to the fullest extent of the law.

Operation Band :802.11n20
Fundamental Frequency :5720 MHz
Operation Mode :Tx CH CH144
EUT Pol. :E1 Plane

Test Date :2019-03-13
Temp./Humi. :23 deg_C / 62 RH
Engineer :Wei
Measurement Antenna Pol. :HORIZONTAL

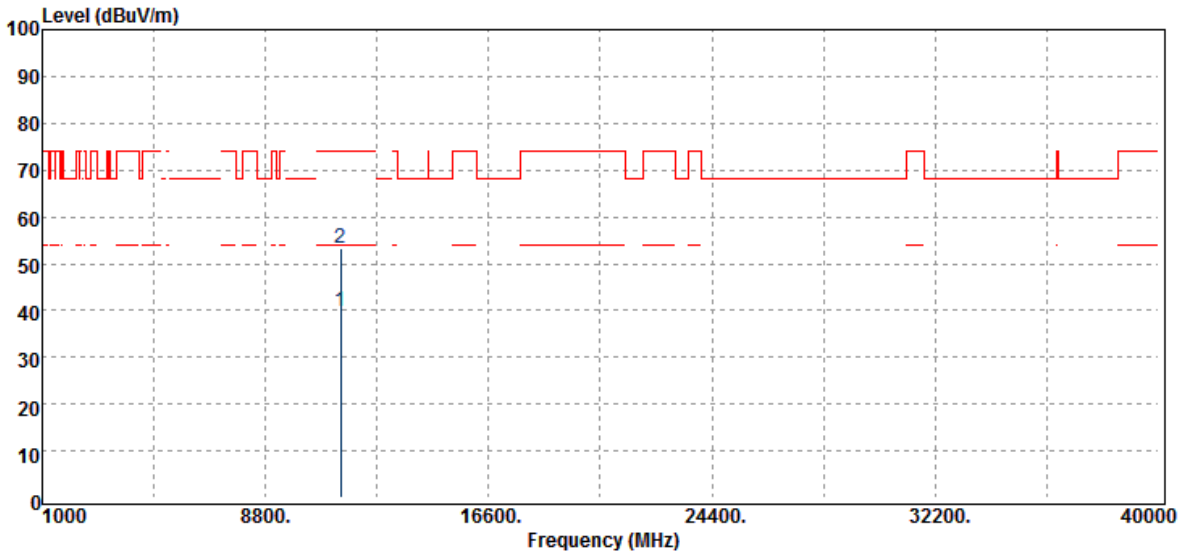

Freq. MHz	Detector Mode PK/QP/AV	Spectrum Reading Level dBuV	Factor dB	Actual FS dBuV/m	Limit @3m dBuV/m	Margin dB
11440.00	Average	22.54	17.09	39.63	54.00	-14.37
11440.00	Peak	36.08	17.09	53.17	74.00	-20.83

Unless otherwise stated the results shown in this test report refer only to the sample(s) tested and such sample(s) are retained for 90 days only.

除非另有說明，此報告結果僅對測試之樣品負責，同時此樣品僅保留90天。本報告未經本公司書面許可，不可部份複製。

This document is issued by the Company subject to its General Conditions of Service printed overleaf, available on request or accessible at www.sgs.com/terms_and_conditions.htm and for electronic format documents, subject to Terms and Conditions for Electronic Documents at www.sgs.com/terms_e-document.htm. Attention is drawn to the limitation of liability, indemnification and jurisdiction issues defined therein. Any holder of this document is advised that information contained hereon reflects the Company's findings at the time of its intervention only and within the limits of Client's instructions, if any. The Company's sole responsibility is to its Client and this document does not exonerate parties to a transaction from exercising all their rights and obligations under the transaction documents. This document cannot be reproduced except in full, without prior written approval of the Company. Any unauthorized alteration, forgery or falsification of the content or appearance of this document is unlawful and offenders may be prosecuted to the fullest extent of the law.

Radiated Spurious Emission Measurement Result 802.11n HT20, 5745~5825 MHz

Operation Band	:802.11n20B4	Test Date	:2019-03-13
Fundamental Frequency	:5745 MHz	Temp./Humi.	:23 deg_C / 62 RH
Operation Mode	:Tx CH LOW	Engineer	:Wei
EUT Pol.	:E1 Plane	Measurement Antenna Pol.	:VERTICAL

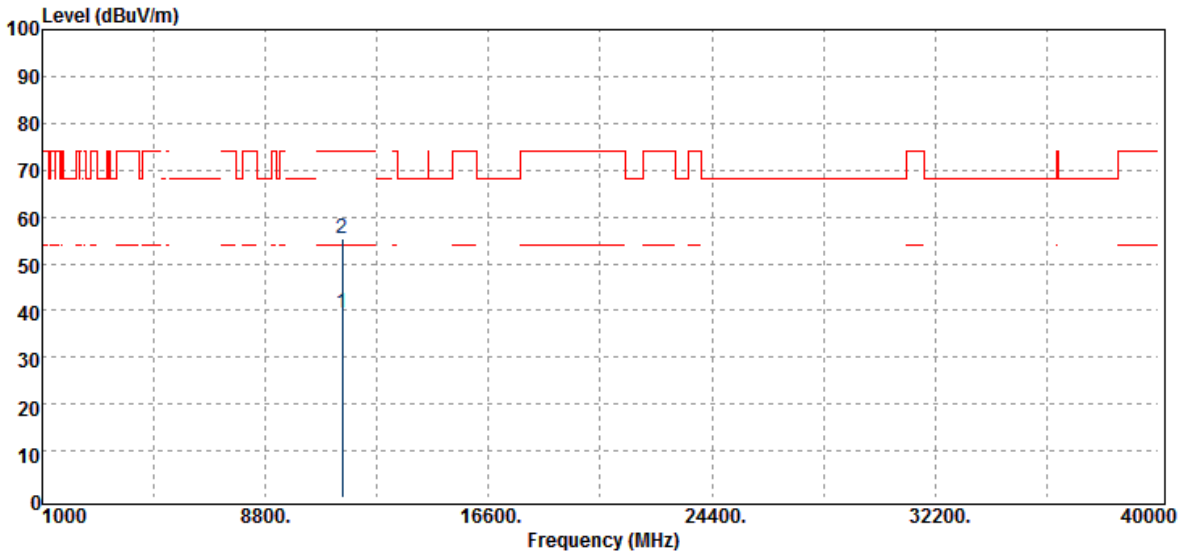

Freq. MHz	Detector Mode PK/QP/AV	Spectrum Reading Level dB μ V	Factor dB	Actual FS dB μ V/m	Limit @3m dB μ V/m	Margin dB
11490.00	Average	23.62	15.85	39.47	54.00	-14.53
11490.00	Peak	39.45	15.85	55.30	74.00	-18.70

Unless otherwise stated the results shown in this test report refer only to the sample(s) tested and such sample(s) are retained for 90 days only.

除非另有說明，此報告結果僅對測試之樣品負責，同時此樣品僅保留90天。本報告未經本公司書面許可，不可部份複製。

This document is issued by the Company subject to its General Conditions of Service printed overleaf, available on request or accessible at www.sgs.com/terms_and_conditions.htm and for electronic format documents, subject to Terms and Conditions for Electronic Documents at www.sgs.com/terms_e-document.htm. Attention is drawn to the limitation of liability, indemnification and jurisdiction issues defined therein. Any holder of this document is advised that information contained hereon reflects the Company's findings at the time of its intervention only and within the limits of Client's instructions, if any. The Company's sole responsibility is to its Client and this document does not exonerate parties to a transaction from exercising all their rights and obligations under the transaction documents. This document cannot be reproduced except in full, without prior written approval of the Company. Any unauthorized alteration, forgery or falsification of the content or appearance of this document is unlawful and offenders may be prosecuted to the fullest extent of the law.

Operation Band	:802.11n20B4	Test Date	:2019-03-13
Fundamental Frequency	:5745 MHz	Temp./Humi.	:23 deg_C / 62 RH
Operation Mode	:Tx CH LOW	Engineer	:Wei
EUT Pol.	:E1 Plane	Measurement Antenna Pol.	:HORIZONTAL

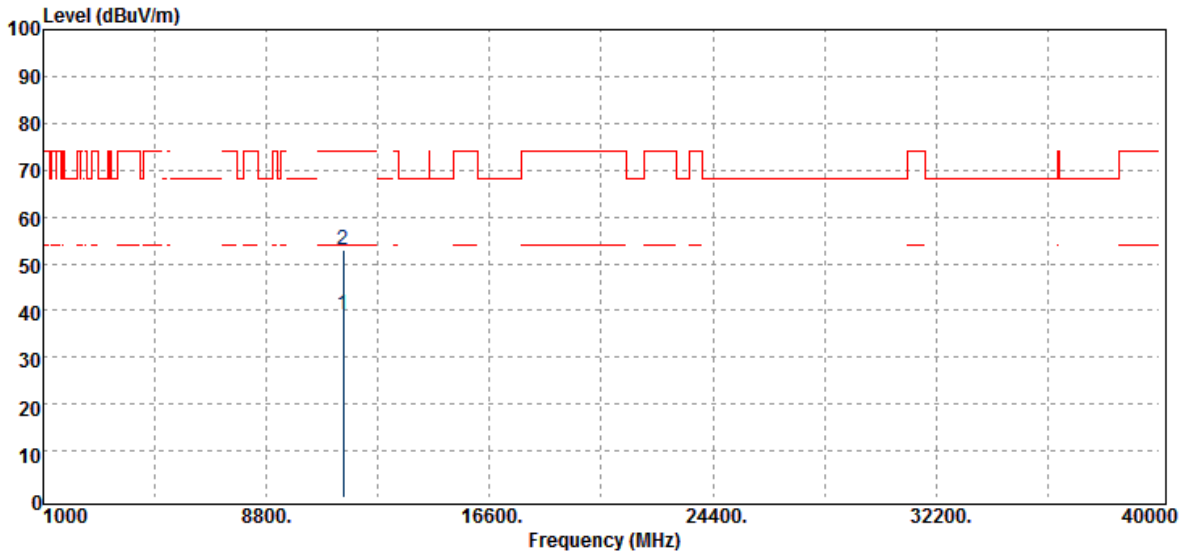

Freq. MHz	Detector Mode PK/QP/AV	Spectrum Reading Level dBuV	Factor dB	Actual FS dBuV/m	Limit @3m dBuV/m	Margin dB
11490.00	Average	23.39	15.85	39.24	54.00	-14.76
11490.00	Peak	37.16	15.85	53.01	74.00	-20.99

Unless otherwise stated the results shown in this test report refer only to the sample(s) tested and such sample(s) are retained for 90 days only.

除非另有說明，此報告結果僅對測試之樣品負責，同時此樣品僅保留90天。本報告未經本公司書面許可，不可部份複製。

This document is issued by the Company subject to its General Conditions of Service printed overleaf, available on request or accessible at www.sgs.com/terms_and_conditions.htm and for electronic format documents, subject to Terms and Conditions for Electronic Documents at www.sgs.com/terms_e-document.htm. Attention is drawn to the limitation of liability, indemnification and jurisdiction issues defined therein. Any holder of this document is advised that information contained hereon reflects the Company's findings at the time of its intervention only and within the limits of Client's instructions, if any. The Company's sole responsibility is to its Client and this document does not exonerate parties to a transaction from exercising all their rights and obligations under the transaction documents. This document cannot be reproduced except in full, without prior written approval of the Company. Any unauthorized alteration, forgery or falsification of the content or appearance of this document is unlawful and offenders may be prosecuted to the fullest extent of the law.

Operation Band	:802.11n20B4	Test Date	:2019-03-13
Fundamental Frequency	:5785 MHz	Temp./Humi.	:23 deg_C / 62 RH
Operation Mode	:Tx CH MID	Engineer	:Wei
EUT Pol.	:E1 Plane	Measurement Antenna Pol.	:VERTICAL

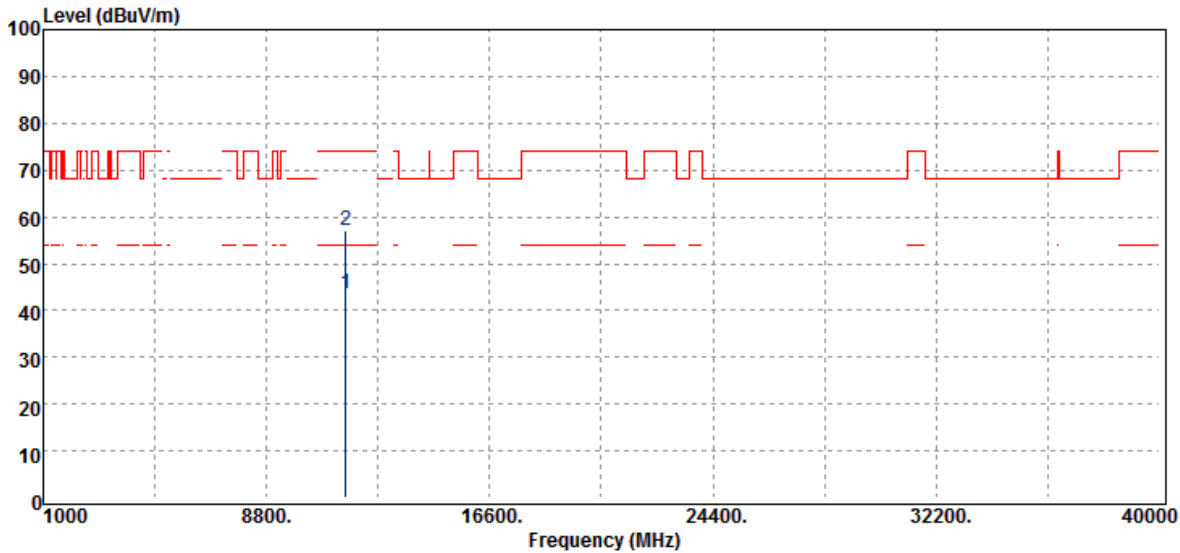

Freq. MHz	Detector Mode PK/QP/AV	Spectrum Reading Level dBuV	Factor dB	Actual FS dBuV/m	Limit @3m dBuV/m	Margin dB
11570.00	Average	27.17	16.29	43.46	54.00	-10.54
11570.00	Peak	40.76	16.29	57.05	74.00	-16.95

Unless otherwise stated the results shown in this test report refer only to the sample(s) tested and such sample(s) are retained for 90 days only.

除非另有說明，此報告結果僅對測試之樣品負責，同時此樣品僅保留90天。本報告未經本公司書面許可，不可部份複製。

This document is issued by the Company subject to its General Conditions of Service printed overleaf, available on request or accessible at www.sgs.com/terms_and_conditions.htm and for electronic format documents, subject to Terms and Conditions for Electronic Documents at www.sgs.com/terms_e-document.htm. Attention is drawn to the limitation of liability, indemnification and jurisdiction issues defined therein. Any holder of this document is advised that information contained hereon reflects the Company's findings at the time of its intervention only and within the limits of Client's instructions, if any. The Company's sole responsibility is to its Client and this document does not exonerate parties to a transaction from exercising all their rights and obligations under the transaction documents. This document cannot be reproduced except in full, without prior written approval of the Company. Any unauthorized alteration, forgery or falsification of the content or appearance of this document is unlawful and offenders may be prosecuted to the fullest extent of the law.

Operation Band	:802.11n20B4	Test Date	:2019-03-13
Fundamental Frequency	:5785 MHz	Temp./Humi.	:23 deg_C / 62 RH
Operation Mode	:Tx CH MID	Engineer	:Wei
EUT Pol.	:E1 Plane	Measurement Antenna Pol.	:HORIZONTAL

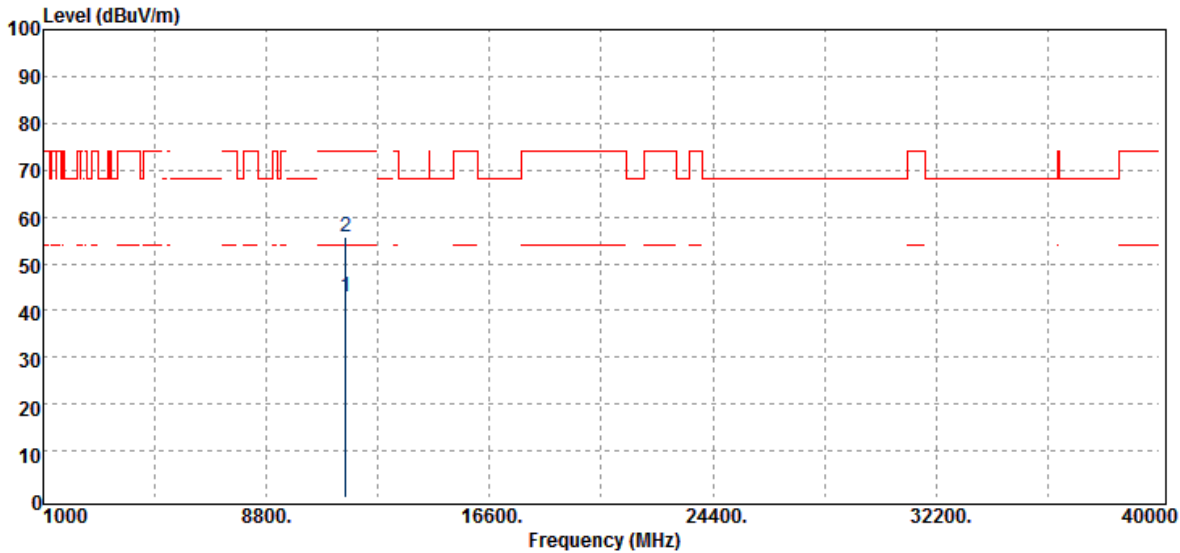

Freq. MHz	Detector Mode PK/QP/AV	Spectrum Reading Level dBuV	Factor dB	Actual FS dBuV/m	Limit @3m dBuV/m	Margin dB
11570.00	Average	26.63	16.29	42.92	54.00	-11.08
11570.00	Peak	39.46	16.29	55.75	74.00	-18.25

Unless otherwise stated the results shown in this test report refer only to the sample(s) tested and such sample(s) are retained for 90 days only.

除非另有說明，此報告結果僅對測試之樣品負責，同時此樣品僅保留90天。本報告未經本公司書面許可，不可部份複製。

This document is issued by the Company subject to its General Conditions of Service printed overleaf, available on request or accessible at www.sgs.com/terms_and_conditions.htm and for electronic format documents, subject to Terms and Conditions for Electronic Documents at www.sgs.com/terms_e-document.htm. Attention is drawn to the limitation of liability, indemnification and jurisdiction issues defined therein. Any holder of this document is advised that information contained hereon reflects the Company's findings at the time of its intervention only and within the limits of Client's instructions, if any. The Company's sole responsibility is to its Client and this document does not exonerate parties to a transaction from exercising all their rights and obligations under the transaction documents. This document cannot be reproduced except in full, without prior written approval of the Company. Any unauthorized alteration, forgery or falsification of the content or appearance of this document is unlawful and offenders may be prosecuted to the fullest extent of the law.

Operation Band	:802.11n20B4	Test Date	:2019-03-13
Fundamental Frequency	:5825 MHz	Temp./Humi.	:23 deg_C / 62 RH
Operation Mode	:Tx CH HIGH	Engineer	:Wei
EUT Pol.	:E1 Plane	Measurement Antenna Pol.	:VERTICAL

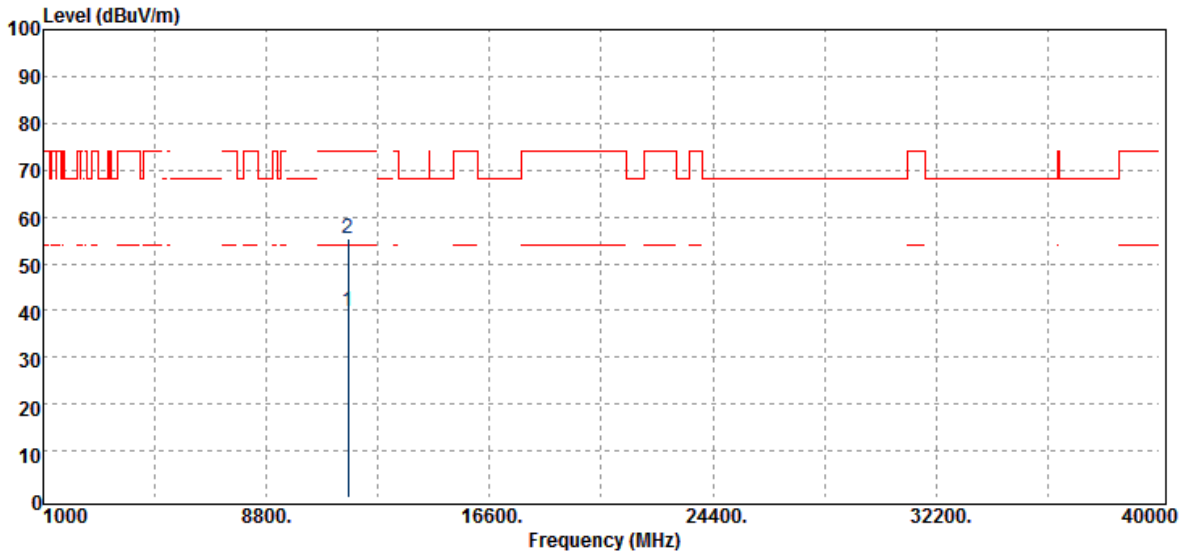

Freq. MHz	Detector Mode PK/QP/AV	Spectrum Reading Level dBuV	Factor dB	Actual FS dBuV/m	Limit @3m dBuV/m	Margin dB
11650.00	Average	23.21	16.61	39.82	54.00	-14.18
11650.00	Peak	38.69	16.61	55.30	74.00	-18.70

Unless otherwise stated the results shown in this test report refer only to the sample(s) tested and such sample(s) are retained for 90 days only.

除非另有說明，此報告結果僅對測試之樣品負責，同時此樣品僅保留90天。本報告未經本公司書面許可，不可部份複製。

This document is issued by the Company subject to its General Conditions of Service printed overleaf, available on request or accessible at www.sgs.com/terms_and_conditions.htm and for electronic format documents, subject to Terms and Conditions for Electronic Documents at www.sgs.com/terms_e-document.htm. Attention is drawn to the limitation of liability, indemnification and jurisdiction issues defined therein. Any holder of this document is advised that information contained hereon reflects the Company's findings at the time of its intervention only and within the limits of Client's instructions, if any. The Company's sole responsibility is to its Client and this document does not exonerate parties to a transaction from exercising all their rights and obligations under the transaction documents. This document cannot be reproduced except in full, without prior written approval of the Company. Any unauthorized alteration, forgery or falsification of the content or appearance of this document is unlawful and offenders may be prosecuted to the fullest extent of the law.

Operation Band	:802.11n20B4	Test Date	:2019-03-13
Fundamental Frequency	:5825 MHz	Temp./Humi.	:23 deg_C / 62 RH
Operation Mode	:Tx CH HIGH	Engineer	:Wei
EUT Pol.	:E1 Plane	Measurement Antenna Pol.	:HORIZONTAL

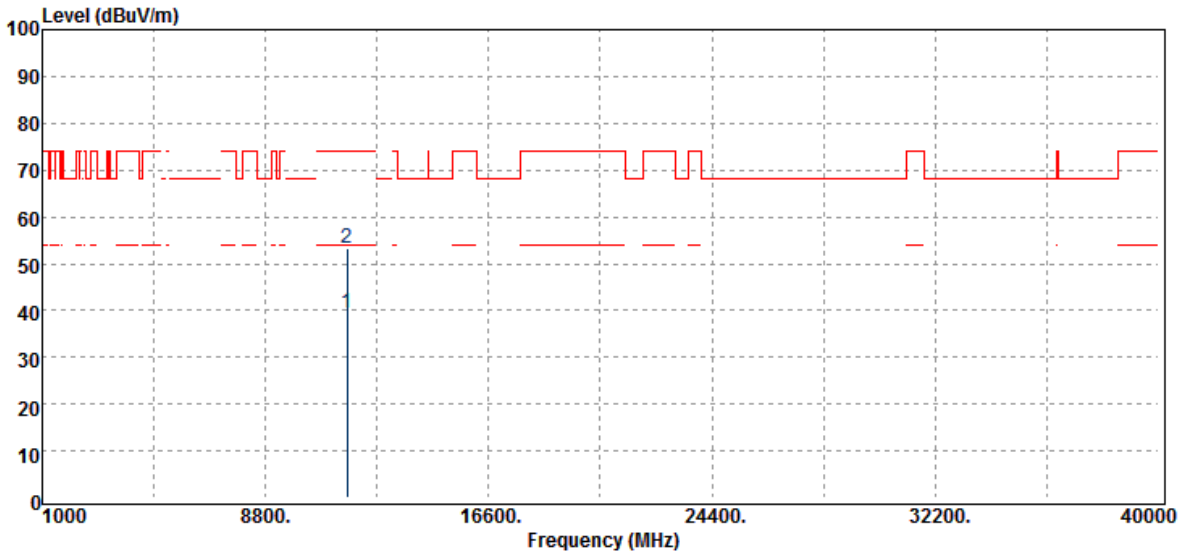

Freq. MHz	Detector Mode PK/QP/AV	Spectrum Reading Level dB μ V	Factor dB	Actual FS dB μ V/m	Limit @3m dB μ V/m	Margin dB
11650.00	Average	22.94	16.61	39.55	54.00	-14.45
11650.00	Peak	36.63	16.61	53.24	74.00	-20.76

Unless otherwise stated the results shown in this test report refer only to the sample(s) tested and such sample(s) are retained for 90 days only.

除非另有說明，此報告結果僅對測試之樣品負責，同時此樣品僅保留90天。本報告未經本公司書面許可，不可部份複製。

This document is issued by the Company subject to its General Conditions of Service printed overleaf, available on request or accessible at www.sgs.com/terms_and_conditions.htm and for electronic format documents, subject to Terms and Conditions for Electronic Documents at www.sgs.com/terms_e-document.htm. Attention is drawn to the limitation of liability, indemnification and jurisdiction issues defined therein. Any holder of this document is advised that information contained hereon reflects the Company's findings at the time of its intervention only and within the limits of Client's instructions, if any. The Company's sole responsibility is to its Client and this document does not exonerate parties to a transaction from exercising all their rights and obligations under the transaction documents. This document cannot be reproduced except in full, without prior written approval of the Company. Any unauthorized alteration, forgery or falsification of the content or appearance of this document is unlawful and offenders may be prosecuted to the fullest extent of the law.

Radiated Spurious Emission Measurement Result 802.11n HT40, 5150~5250 MHz

Operation Band	:802.11n40B1	Test Date	:2019-03-09
Fundamental Frequency	:5190 MHz	Temp./Humi.	:20 deg_C / 61 RH
Operation Mode	:Tx CH LOW	Engineer	:Wei
EUT Pol.	:E1 Plane	Measurement Antenna Pol.	:VERTICAL

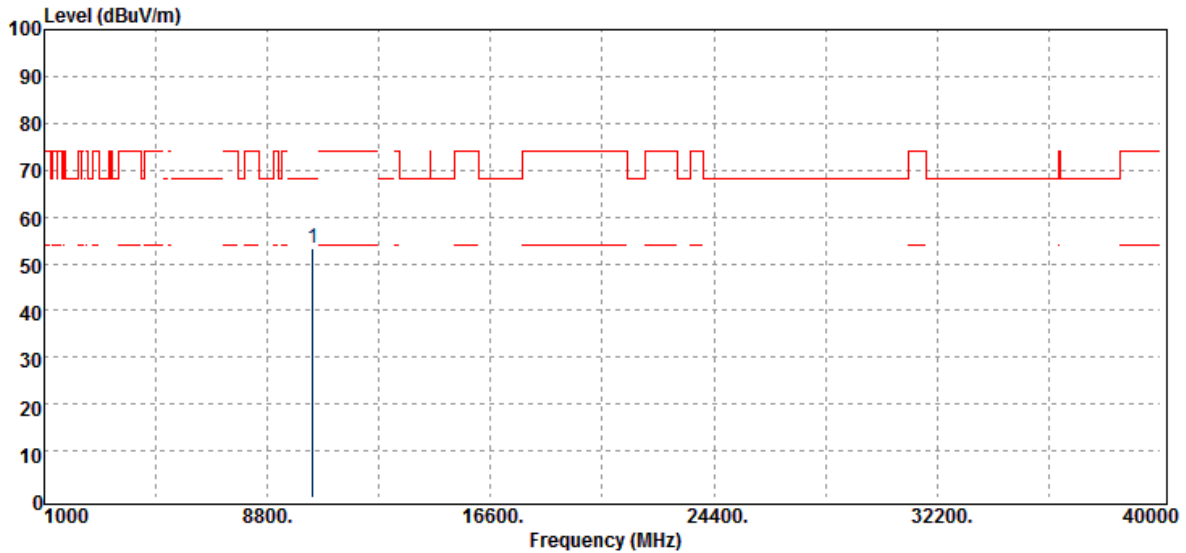

Freq. MHz	Detector Mode PK/QP/AV	Spectrum Reading Level dBuV	Factor dB	Actual FS dBuV/m	Limit @3m dBuV/m	Margin dB
10380.00	Peak	38.63	14.58	53.21	68.20	-14.99

Unless otherwise stated the results shown in this test report refer only to the sample(s) tested and such sample(s) are retained for 90 days only.

除非另有說明，此報告結果僅對測試之樣品負責，同時此樣品僅保留90天。本報告未經本公司書面許可，不可部份複製。

This document is issued by the Company subject to its General Conditions of Service printed overleaf, available on request or accessible at www.sgs.com/terms_and_conditions.htm and for electronic format documents, subject to Terms and Conditions for Electronic Documents at www.sgs.com/terms_e-document.htm. Attention is drawn to the limitation of liability, indemnification and jurisdiction issues defined therein. Any holder of this document is advised that information contained hereon reflects the Company's findings at the time of its intervention only and within the limits of Client's instructions, if any. The Company's sole responsibility is to its Client and this document does not exonerate parties to a transaction from exercising all their rights and obligations under the transaction documents. This document cannot be reproduced except in full, without prior written approval of the Company. Any unauthorized alteration, forgery or falsification of the content or appearance of this document is unlawful and offenders may be prosecuted to the fullest extent of the law.

Operation Band	:802.11n40B1	Test Date	:2019-03-09
Fundamental Frequency	:5190 MHz	Temp./Humi.	:20 deg_C / 61 RH
Operation Mode	:Tx CH LOW	Engineer	:Wei
EUT Pol.	:E1 Plane	Measurement Antenna Pol.	:HORIZONTAL

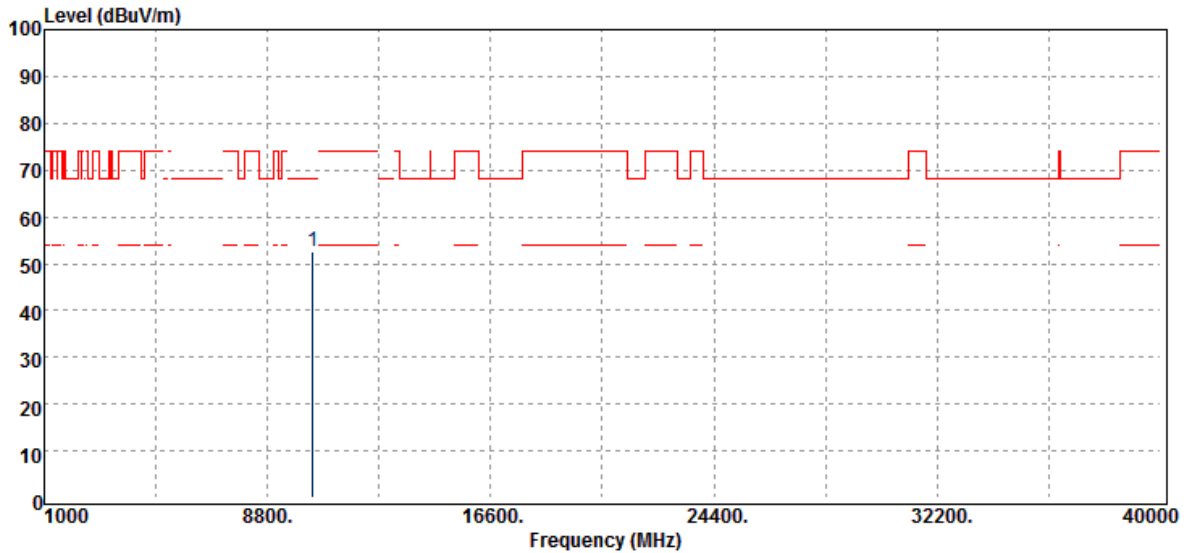

Freq. MHz	Detector Mode PK/QP/AV	Spectrum Reading Level dBuV	Factor dB	Actual FS dBuV/m	Limit @3m dBuV/m	Margin dB
10380.00	Peak	38.03	14.58	52.61	68.20	-15.59

Unless otherwise stated the results shown in this test report refer only to the sample(s) tested and such sample(s) are retained for 90 days only.

除非另有說明，此報告結果僅對測試之樣品負責，同時此樣品僅保留90天。本報告未經本公司書面許可，不可部份複製。

This document is issued by the Company subject to its General Conditions of Service printed overleaf, available on request or accessible at www.sgs.com/terms_and_conditions.htm and for electronic format documents, subject to Terms and Conditions for Electronic Documents at www.sgs.com/terms_e-document.htm. Attention is drawn to the limitation of liability, indemnification and jurisdiction issues defined therein. Any holder of this document is advised that information contained hereon reflects the Company's findings at the time of its intervention only and within the limits of Client's instructions, if any. The Company's sole responsibility is to its Client and this document does not exonerate parties to a transaction from exercising all their rights and obligations under the transaction documents. This document cannot be reproduced except in full, without prior written approval of the Company. Any unauthorized alteration, forgery or falsification of the content or appearance of this document is unlawful and offenders may be prosecuted to the fullest extent of the law.

Operation Band	:802.11n40B1	Test Date	:2019-03-09
Fundamental Frequency	:5230 MHz	Temp./Humi.	:20 deg_C / 61 RH
Operation Mode	:Tx CH HIGH	Engineer	:Wei
EUT Pol.	:E1 Plane	Measurement Antenna Pol.	:VERTICAL

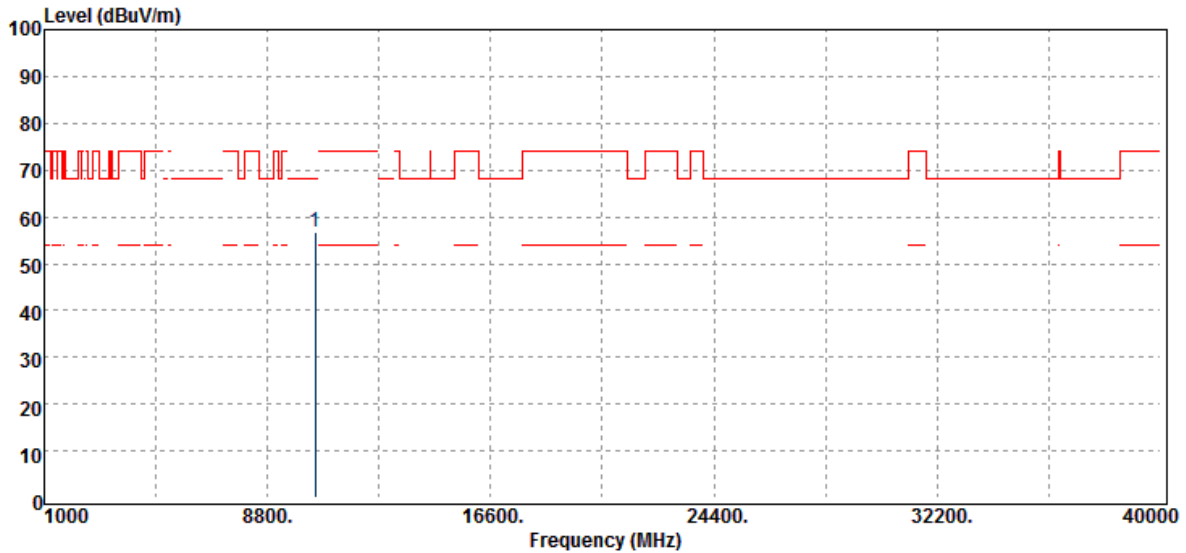

Freq. MHz	Detector Mode PK/QP/AV	Spectrum Reading Level dB μ V	Factor dB	Actual FS dB μ V/m	Limit @3m dB μ V/m	Margin dB
10460.00	Peak	40.83	15.97	56.80	68.20	-11.40

Unless otherwise stated the results shown in this test report refer only to the sample(s) tested and such sample(s) are retained for 90 days only.

除非另有說明，此報告結果僅對測試之樣品負責，同時此樣品僅保留90天。本報告未經本公司書面許可，不可部份複製。

This document is issued by the Company subject to its General Conditions of Service printed overleaf, available on request or accessible at www.sgs.com/terms_and_conditions.htm and for electronic format documents, subject to Terms and Conditions for Electronic Documents at www.sgs.com/terms_e-document.htm. Attention is drawn to the limitation of liability, indemnification and jurisdiction issues defined therein. Any holder of this document is advised that information contained hereon reflects the Company's findings at the time of its intervention only and within the limits of Client's instructions, if any. The Company's sole responsibility is to its Client and this document does not exonerate parties to a transaction from exercising all their rights and obligations under the transaction documents. This document cannot be reproduced except in full, without prior written approval of the Company. Any unauthorized alteration, forgery or falsification of the content or appearance of this document is unlawful and offenders may be prosecuted to the fullest extent of the law.

Operation Band	:802.11n40B1	Test Date	:2019-03-09
Fundamental Frequency	:5230 MHz	Temp./Humi.	:20 deg_C / 61 RH
Operation Mode	:Tx CH HIGH	Engineer	:Wei
EUT Pol.	:E1 Plane	Measurement Antenna Pol.	:HORIZONTAL

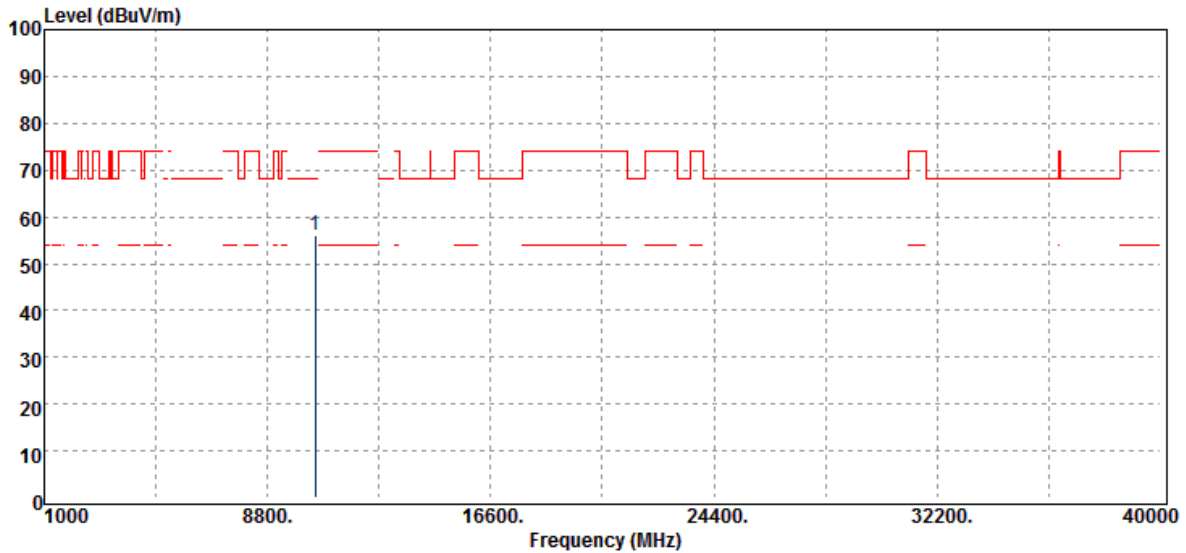

Freq. MHz	Detector Mode PK/QP/AV	Spectrum Reading Level dB μ V	Factor dB	Actual FS dB μ V/m	Limit @3m dB μ V/m	Margin dB
10460.00	Peak	40.02	15.97	55.99	68.20	-12.21

Unless otherwise stated the results shown in this test report refer only to the sample(s) tested and such sample(s) are retained for 90 days only.

除非另有說明，此報告結果僅對測試之樣品負責，同時此樣品僅保留90天。本報告未經本公司書面許可，不可部份複製。

This document is issued by the Company subject to its General Conditions of Service printed overleaf, available on request or accessible at www.sgs.com/terms_and_conditions.htm and for electronic format documents, subject to Terms and Conditions for Electronic Documents at www.sgs.com/terms_e-document.htm. Attention is drawn to the limitation of liability, indemnification and jurisdiction issues defined therein. Any holder of this document is advised that information contained hereon reflects the Company's findings at the time of its intervention only and within the limits of Client's instructions, if any. The Company's sole responsibility is to its Client and this document does not exonerate parties to a transaction from exercising all their rights and obligations under the transaction documents. This document cannot be reproduced except in full, without prior written approval of the Company. Any unauthorized alteration, forgery or falsification of the content or appearance of this document is unlawful and offenders may be prosecuted to the fullest extent of the law.

Radiated Spurious Emission Measurement Result 802.11n HT40, 5250~5350 MHz

Operation Band	:802.11n40B2	Test Date	:2019-03-09
Fundamental Frequency	:5270 MHz	Temp./Humi.	:20 deg_C / 61 RH
Operation Mode	:Tx CH LOW	Engineer	:Wei
EUT Pol.	:E1 Plane	Measurement Antenna Pol.	:VERTICAL

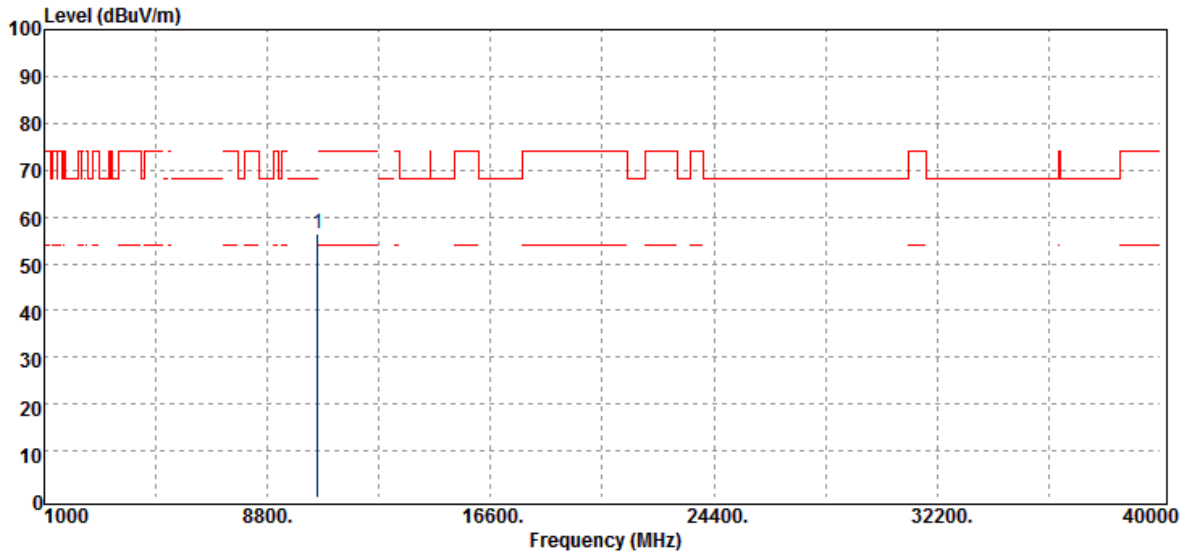

Freq. MHz	Detector Mode PK/QP/AV	Spectrum Reading Level dBuV	Factor dB	Actual FS dBuV/m	Limit @3m dBuV/m	Margin dB
10540.00	Peak	40.80	15.67	56.47	68.20	-11.73

Unless otherwise stated the results shown in this test report refer only to the sample(s) tested and such sample(s) are retained for 90 days only.

除非另有說明，此報告結果僅對測試之樣品負責，同時此樣品僅保留90天。本報告未經本公司書面許可，不可部份複製。

This document is issued by the Company subject to its General Conditions of Service printed overleaf, available on request or accessible at www.sgs.com/terms_and_conditions.htm and for electronic format documents, subject to Terms and Conditions for Electronic Documents at www.sgs.com/terms_e-document.htm. Attention is drawn to the limitation of liability, indemnification and jurisdiction issues defined therein. Any holder of this document is advised that information contained hereon reflects the Company's findings at the time of its intervention only and within the limits of Client's instructions, if any. The Company's sole responsibility is to its Client and this document does not exonerate parties to a transaction from exercising all their rights and obligations under the transaction documents. This document cannot be reproduced except in full, without prior written approval of the Company. Any unauthorized alteration, forgery or falsification of the content or appearance of this document is unlawful and offenders may be prosecuted to the fullest extent of the law.

Operation Band	:802.11n40B2	Test Date	:2019-03-09
Fundamental Frequency	:5270 MHz	Temp./Humi.	:20 deg_C / 61 RH
Operation Mode	:Tx CH LOW	Engineer	:Wei
EUT Pol.	:E1 Plane	Measurement Antenna Pol.	:HORIZONTAL

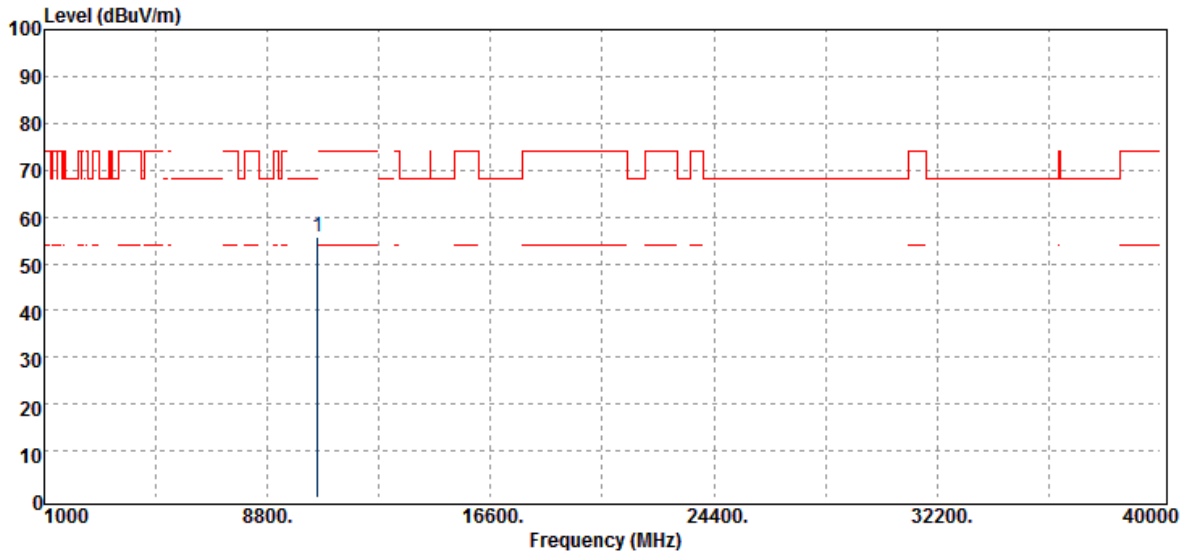

Freq. MHz	Detector Mode PK/QP/AV	Spectrum Reading Level dB μ V	Factor dB	Actual FS dB μ V/m	Limit @3m dB μ V/m	Margin dB
10540.00	Peak	40.01	15.67	55.68	68.20	-12.52

Unless otherwise stated the results shown in this test report refer only to the sample(s) tested and such sample(s) are retained for 90 days only.

除非另有說明，此報告結果僅對測試之樣品負責，同時此樣品僅保留90天。本報告未經本公司書面許可，不可部份複製。

This document is issued by the Company subject to its General Conditions of Service printed overleaf, available on request or accessible at www.sgs.com/terms_and_conditions.htm and for electronic format documents, subject to Terms and Conditions for Electronic Documents at www.sgs.com/terms_e-document.htm. Attention is drawn to the limitation of liability, indemnification and jurisdiction issues defined therein. Any holder of this document is advised that information contained hereon reflects the Company's findings at the time of its intervention only and within the limits of Client's instructions, if any. The Company's sole responsibility is to its Client and this document does not exonerate parties to a transaction from exercising all their rights and obligations under the transaction documents. This document cannot be reproduced except in full, without prior written approval of the Company. Any unauthorized alteration, forgery or falsification of the content or appearance of this document is unlawful and offenders may be prosecuted to the fullest extent of the law.

Operation Band	:802.11n40B2	Test Date	:2019-03-09
Fundamental Frequency	:5310 MHz	Temp./Humi.	:20 deg_C / 61 RH
Operation Mode	:Tx CH HIGH	Engineer	:Wei
EUT Pol.	:E1 Plane	Measurement Antenna Pol.	:VERTICAL

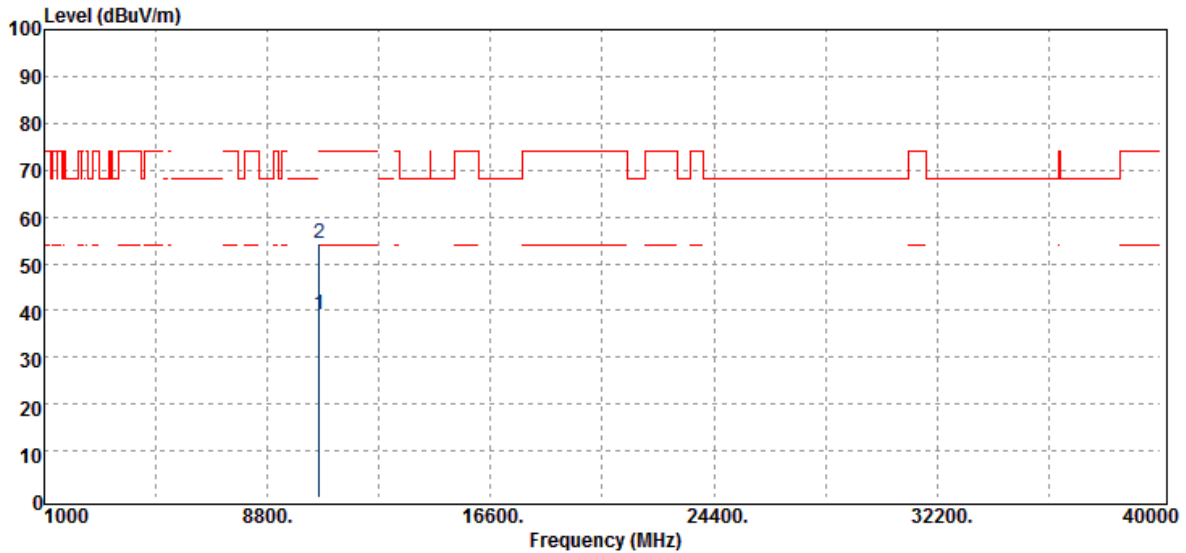

Freq. MHz	Detector Mode PK/QP/AV	Spectrum Reading Level dB μ V	Factor dB	Actual FS dB μ V/m	Limit @3m dB μ V/m	Margin dB
10620.00	Average	23.33	15.78	39.11	54.00	-14.89
10620.00	Peak	38.38	15.78	54.16	74.00	-19.84

Unless otherwise stated the results shown in this test report refer only to the sample(s) tested and such sample(s) are retained for 90 days only.

除非另有說明，此報告結果僅對測試之樣品負責，同時此樣品僅保留90天。本報告未經本公司書面許可，不可部份複製。

This document is issued by the Company subject to its General Conditions of Service printed overleaf, available on request or accessible at www.sgs.com/terms_and_conditions.htm and for electronic format documents, subject to Terms and Conditions for Electronic Documents at www.sgs.com/terms_e-document.htm. Attention is drawn to the limitation of liability, indemnification and jurisdiction issues defined therein. Any holder of this document is advised that information contained hereon reflects the Company's findings at the time of its intervention only and within the limits of Client's instructions, if any. The Company's sole responsibility is to its Client and this document does not exonerate parties to a transaction from exercising all their rights and obligations under the transaction documents. This document cannot be reproduced except in full, without prior written approval of the Company. Any unauthorized alteration, forgery or falsification of the content or appearance of this document is unlawful and offenders may be prosecuted to the fullest extent of the law.

Operation Band	:802.11n40B2	Test Date	:2019-03-09
Fundamental Frequency	:5310 MHz	Temp./Humi.	:20 deg_C / 61 RH
Operation Mode	:Tx CH HIGH	Engineer	:Wei
EUT Pol.	:E1 Plane	Measurement Antenna Pol.	:HORIZONTAL

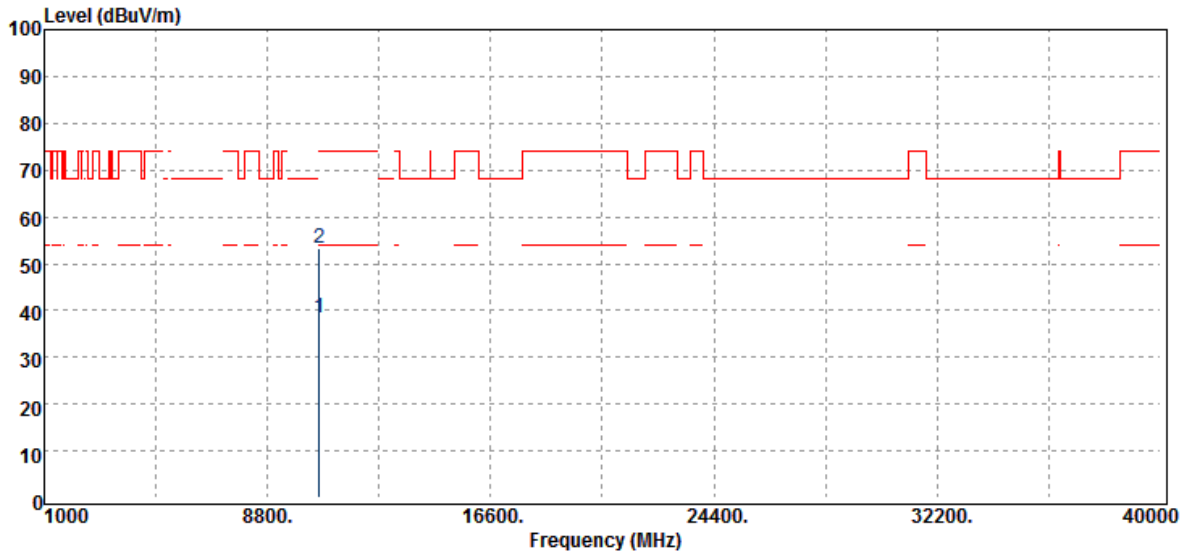

Freq. MHz	Detector Mode PK/QP/AV	Spectrum Reading Level dB μ V	Factor dB	Actual FS dB μ V/m	Limit @3m dB μ V/m	Margin dB
10620.00	Average	22.78	15.78	38.56	54.00	-15.44
10620.00	Peak	37.67	15.78	53.45	74.00	-20.55

Unless otherwise stated the results shown in this test report refer only to the sample(s) tested and such sample(s) are retained for 90 days only.

除非另有說明，此報告結果僅對測試之樣品負責，同時此樣品僅保留90天。本報告未經本公司書面許可，不可部份複製。

This document is issued by the Company subject to its General Conditions of Service printed overleaf, available on request or accessible at www.sgs.com/terms_and_conditions.htm and for electronic format documents, subject to Terms and Conditions for Electronic Documents at www.sgs.com/terms_e-document.htm. Attention is drawn to the limitation of liability, indemnification and jurisdiction issues defined therein. Any holder of this document is advised that information contained hereon reflects the Company's findings at the time of its intervention only and within the limits of Client's instructions, if any. The Company's sole responsibility is to its Client and this document does not exonerate parties to a transaction from exercising all their rights and obligations under the transaction documents. This document cannot be reproduced except in full, without prior written approval of the Company. Any unauthorized alteration, forgery or falsification of the content or appearance of this document is unlawful and offenders may be prosecuted to the fullest extent of the law.

Radiated Spurious Emission Measurement Result 802.11n HT40, 5470~5725 MHz

Operation Band	:802.11n40B3	Test Date	:2019-03-09
Fundamental Frequency	:5510 MHz	Temp./Humi.	:20 deg_C / 61 RH
Operation Mode	:Tx CH LOW	Engineer	:Wei
EUT Pol.	:E1 Plane	Measurement Antenna Pol.	:VERTICAL

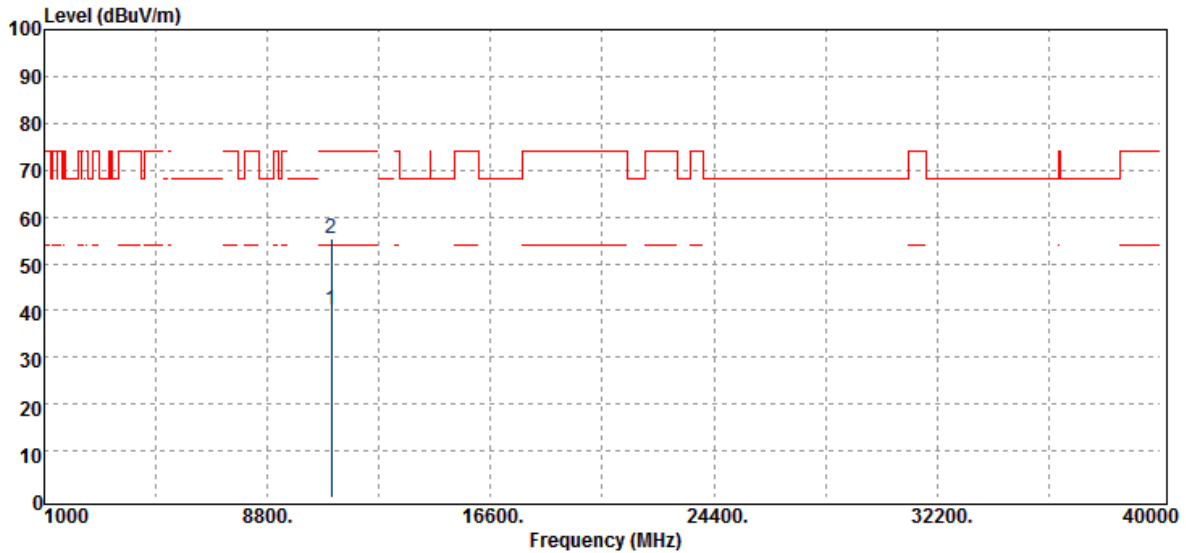

Freq. MHz	Detector Mode PK/QP/AV	Spectrum Reading Level dBuV	Factor dB	Actual FS dBuV/m	Limit @3m dBuV/m	Margin dB
11020.00	Average	22.30	17.87	40.17	54.00	-13.83
11020.00	Peak	37.48	17.87	55.35	74.00	-18.65

Unless otherwise stated the results shown in this test report refer only to the sample(s) tested and such sample(s) are retained for 90 days only.

除非另有說明，此報告結果僅對測試之樣品負責，同時此樣品僅保留90天。本報告未經本公司書面許可，不可部份複製。

This document is issued by the Company subject to its General Conditions of Service printed overleaf, available on request or accessible at www.sgs.com/terms_and_conditions.htm and for electronic format documents, subject to Terms and Conditions for Electronic Documents at www.sgs.com/terms_e-document.htm. Attention is drawn to the limitation of liability, indemnification and jurisdiction issues defined therein. Any holder of this document is advised that information contained hereon reflects the Company's findings at the time of its intervention only and within the limits of Client's instructions, if any. The Company's sole responsibility is to its Client and this document does not exonerate parties to a transaction from exercising all their rights and obligations under the transaction documents. This document cannot be reproduced except in full, without prior written approval of the Company. Any unauthorized alteration, forgery or falsification of the content or appearance of this document is unlawful and offenders may be prosecuted to the fullest extent of the law.

Operation Band	:802.11n40B3	Test Date	:2019-03-09
Fundamental Frequency	:5510 MHz	Temp./Humi.	:20 deg_C / 61 RH
Operation Mode	:Tx CH LOW	Engineer	:Wei
EUT Pol.	:E1 Plane	Measurement Antenna Pol.	:HORIZONTAL

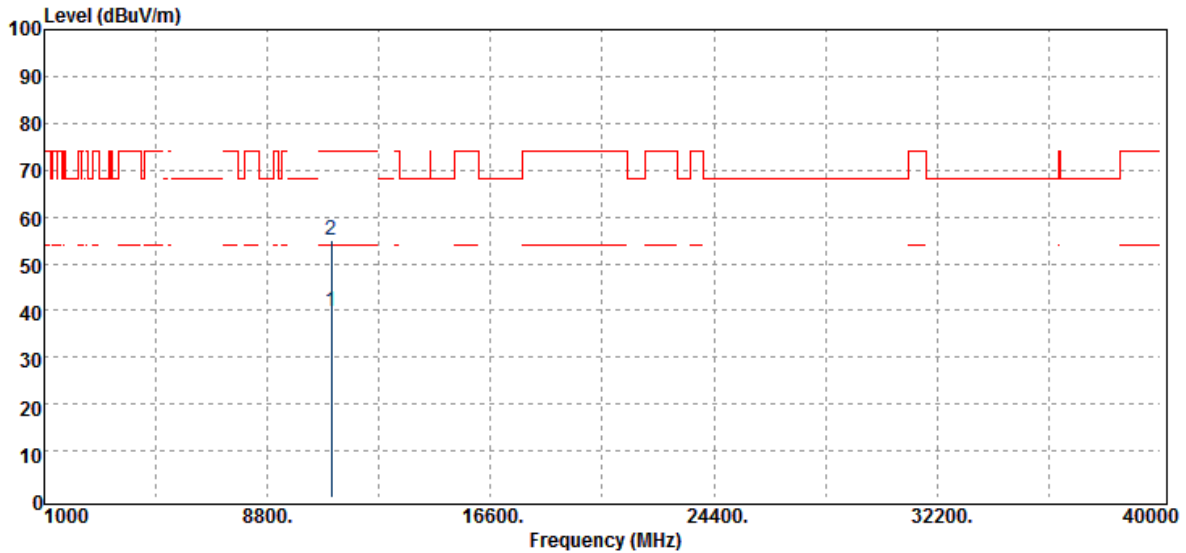

Freq. MHz	Detector Mode PK/QP/AV	Spectrum Reading Level dBuV	Factor dB	Actual FS dBuV/m	Limit @3m dBuV/m	Margin dB
11020.00	Average	21.94	17.87	39.81	54.00	-14.19
11020.00	Peak	36.97	17.87	54.84	74.00	-19.16

Unless otherwise stated the results shown in this test report refer only to the sample(s) tested and such sample(s) are retained for 90 days only.

除非另有說明，此報告結果僅對測試之樣品負責，同時此樣品僅保留90天。本報告未經本公司書面許可，不可部份複製。

This document is issued by the Company subject to its General Conditions of Service printed overleaf, available on request or accessible at www.sgs.com/terms_and_conditions.htm and for electronic format documents, subject to Terms and Conditions for Electronic Documents at www.sgs.com/terms_e-document.htm. Attention is drawn to the limitation of liability, indemnification and jurisdiction issues defined therein. Any holder of this document is advised that information contained hereon reflects the Company's findings at the time of its intervention only and within the limits of Client's instructions, if any. The Company's sole responsibility is to its Client and this document does not exonerate parties to a transaction from exercising all their rights and obligations under the transaction documents. This document cannot be reproduced except in full, without prior written approval of the Company. Any unauthorized alteration, forgery or falsification of the content or appearance of this document is unlawful and offenders may be prosecuted to the fullest extent of the law.

Operation Band	:802.11n40B3	Test Date	:2019-03-09
Fundamental Frequency	:5550 MHz	Temp./Humi.	:20 deg_C / 61 RH
Operation Mode	:Tx CH MID	Engineer	:Wei
EUT Pol.	:E1 Plane	Measurement Antenna Pol.	:VERTICAL

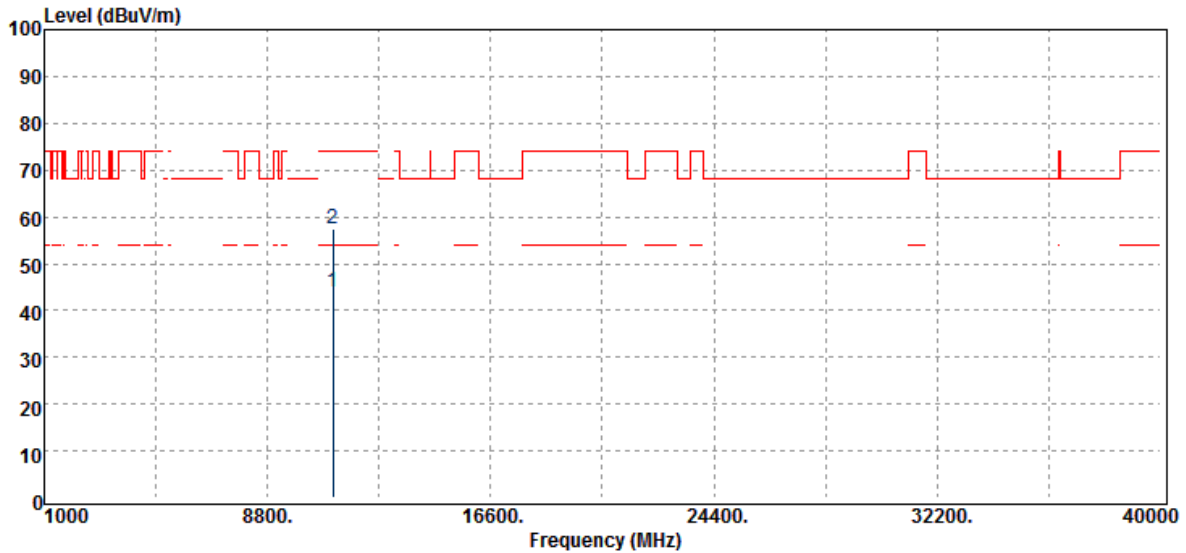

Freq. MHz	Detector Mode PK/QP/AV	Spectrum Reading Level dBuV	Factor dB	Actual FS dBuV/m	Limit @3m dBuV/m	Margin dB
11100.00	Average	26.85	17.25	44.10	54.00	-9.90
11100.00	Peak	40.24	17.25	57.49	74.00	-16.51

Unless otherwise stated the results shown in this test report refer only to the sample(s) tested and such sample(s) are retained for 90 days only.

除非另有說明，此報告結果僅對測試之樣品負責，同時此樣品僅保留90天。本報告未經本公司書面許可，不可部份複製。

This document is issued by the Company subject to its General Conditions of Service printed overleaf, available on request or accessible at www.sgs.com/terms_and_conditions.htm and for electronic format documents, subject to Terms and Conditions for Electronic Documents at www.sgs.com/terms_e-document.htm. Attention is drawn to the limitation of liability, indemnification and jurisdiction issues defined therein. Any holder of this document is advised that information contained hereon reflects the Company's findings at the time of its intervention only and within the limits of Client's instructions, if any. The Company's sole responsibility is to its Client and this document does not exonerate parties to a transaction from exercising all their rights and obligations under the transaction documents. This document cannot be reproduced except in full, without prior written approval of the Company. Any unauthorized alteration, forgery or falsification of the content or appearance of this document is unlawful and offenders may be prosecuted to the fullest extent of the law.

Operation Band	:802.11n40B3	Test Date	:2019-03-09
Fundamental Frequency	:5550 MHz	Temp./Humi.	:20 deg_C / 61 RH
Operation Mode	:Tx CH MID	Engineer	:Wei
EUT Pol.	:E1 Plane	Measurement Antenna Pol.	:HORIZONTAL

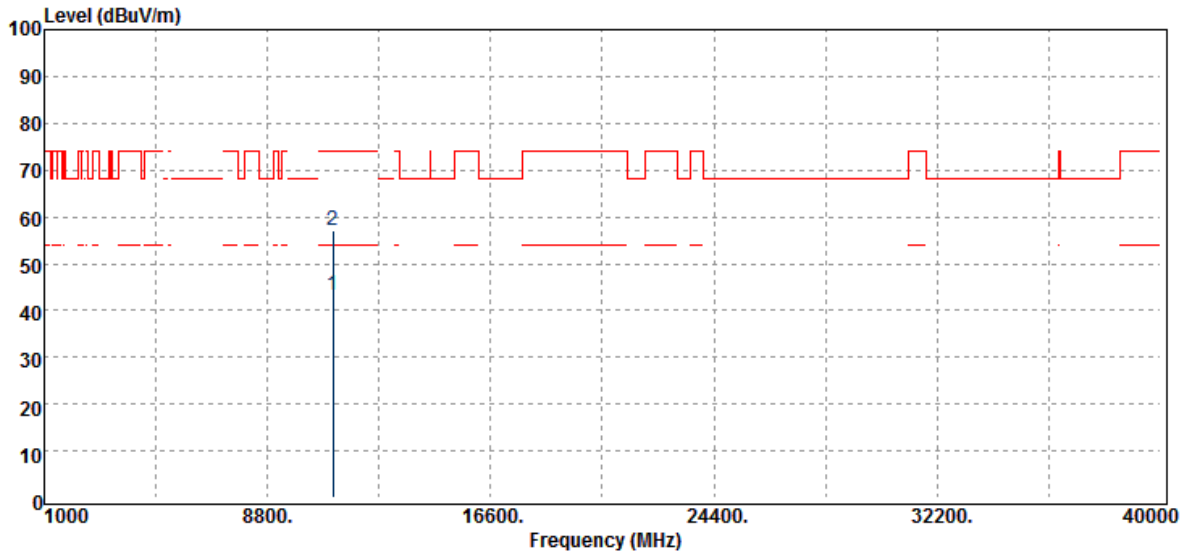

Freq. MHz	Detector Mode PK/QP/AV	Spectrum Reading Level dBuV	Factor dB	Actual FS dBuV/m	Limit @3m dBuV/m	Margin dB
11100.00	Average	25.95	17.25	43.20	54.00	-10.80
11100.00	Peak	39.72	17.25	56.97	74.00	-17.03

Unless otherwise stated the results shown in this test report refer only to the sample(s) tested and such sample(s) are retained for 90 days only.

除非另有說明，此報告結果僅對測試之樣品負責，同時此樣品僅保留90天。本報告未經本公司書面許可，不可部份複製。

This document is issued by the Company subject to its General Conditions of Service printed overleaf, available on request or accessible at www.sgs.com/terms_and_conditions.htm and for electronic format documents, subject to Terms and Conditions for Electronic Documents at www.sgs.com/terms_e-document.htm. Attention is drawn to the limitation of liability, indemnification and jurisdiction issues defined therein. Any holder of this document is advised that information contained hereon reflects the Company's findings at the time of its intervention only and within the limits of Client's instructions, if any. The Company's sole responsibility is to its Client and this document does not exonerate parties to a transaction from exercising all their rights and obligations under the transaction documents. This document cannot be reproduced except in full, without prior written approval of the Company. Any unauthorized alteration, forgery or falsification of the content or appearance of this document is unlawful and offenders may be prosecuted to the fullest extent of the law.

Operation Band	:802.11n40B3	Test Date	:2019-03-09
Fundamental Frequency	:5670 MHz	Temp./Humi.	:20 deg_C / 61 RH
Operation Mode	:Tx CH HIGH	Engineer	:Wei
EUT Pol.	:E1 Plane	Measurement Antenna Pol.	:VERTICAL

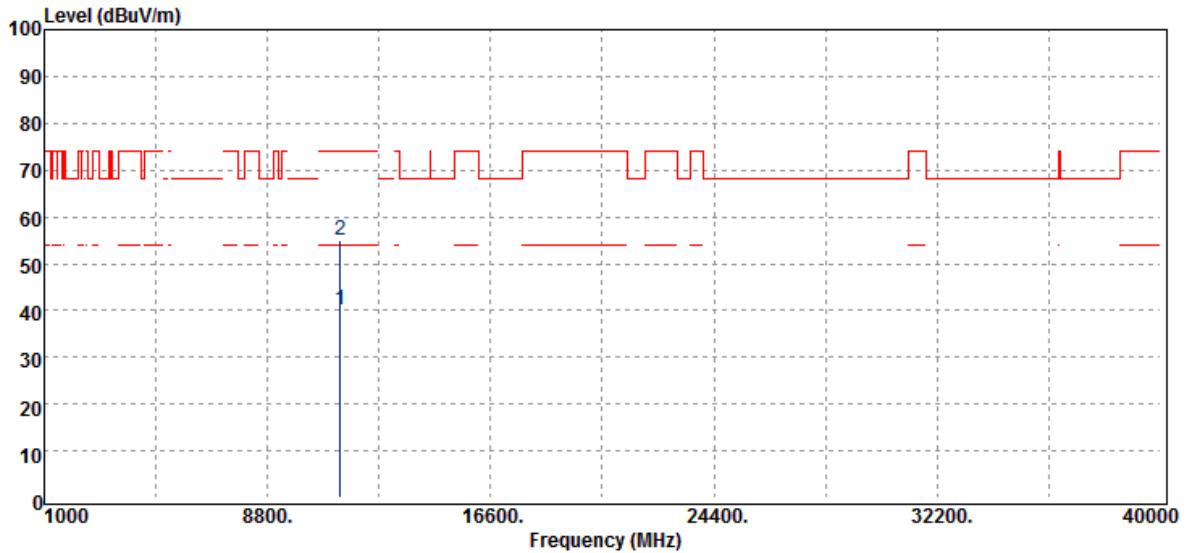

Freq. MHz	Detector Mode PK/QP/AV	Spectrum Reading Level dBuV	Factor dB	Actual FS dBuV/m	Limit @3m dBuV/m	Margin dB
11340.00	Average	23.66	16.36	40.02	54.00	-13.98
11340.00	Peak	38.72	16.36	55.08	74.00	-18.92

Unless otherwise stated the results shown in this test report refer only to the sample(s) tested and such sample(s) are retained for 90 days only.

除非另有說明，此報告結果僅對測試之樣品負責，同時此樣品僅保留90天。本報告未經本公司書面許可，不可部份複製。

This document is issued by the Company subject to its General Conditions of Service printed overleaf, available on request or accessible at www.sgs.com/terms_and_conditions.htm and for electronic format documents, subject to Terms and Conditions for Electronic Documents at www.sgs.com/terms_e-document.htm. Attention is drawn to the limitation of liability, indemnification and jurisdiction issues defined therein. Any holder of this document is advised that information contained hereon reflects the Company's findings at the time of its intervention only and within the limits of Client's instructions, if any. The Company's sole responsibility is to its Client and this document does not exonerate parties to a transaction from exercising all their rights and obligations under the transaction documents. This document cannot be reproduced except in full, without prior written approval of the Company. Any unauthorized alteration, forgery or falsification of the content or appearance of this document is unlawful and offenders may be prosecuted to the fullest extent of the law.

Operation Band	:802.11n40B3	Test Date	:2019-03-09
Fundamental Frequency	:5670 MHz	Temp./Humi.	:20 deg_C / 61 RH
Operation Mode	:Tx CH HIGH	Engineer	:Wei
EUT Pol.	:E1 Plane	Measurement Antenna Pol.	:HORIZONTAL

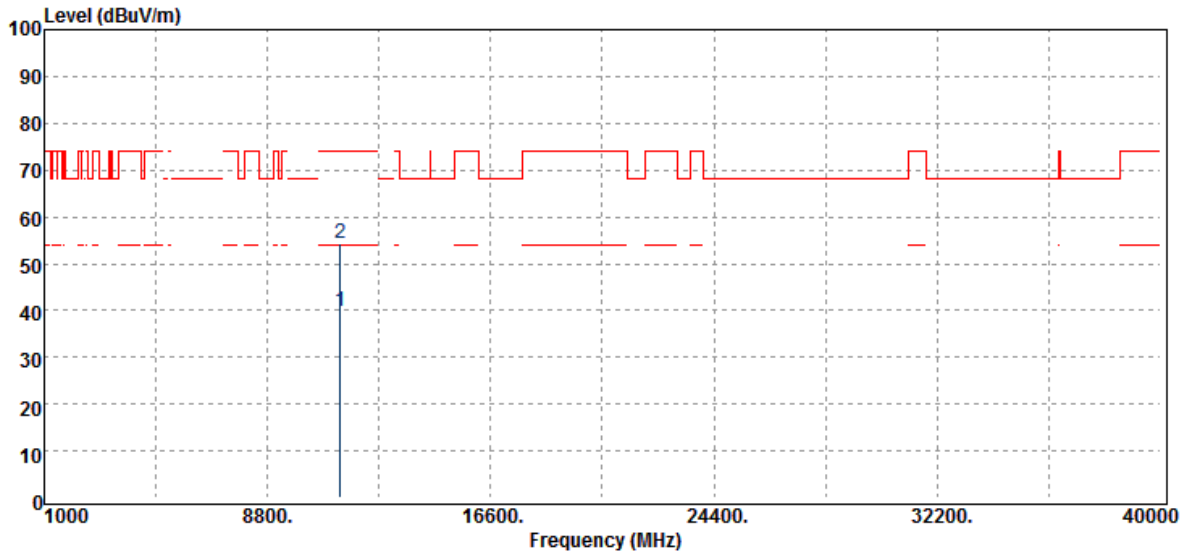

Freq. MHz	Detector Mode PK/QP/AV	Spectrum Reading Level dB μ V	Factor dB	Actual FS dB μ V/m	Limit @3m dB μ V/m	Margin dB
11340.00	Average	23.29	16.36	39.65	54.00	-14.35
11340.00	Peak	38.06	16.36	54.42	74.00	-19.58

Unless otherwise stated the results shown in this test report refer only to the sample(s) tested and such sample(s) are retained for 90 days only.

除非另有說明，此報告結果僅對測試之樣品負責，同時此樣品僅保留90天。本報告未經本公司書面許可，不可部份複製。

This document is issued by the Company subject to its General Conditions of Service printed overleaf, available on request or accessible at www.sgs.com/terms_and_conditions.htm and for electronic format documents, subject to Terms and Conditions for Electronic Documents at www.sgs.com/terms_e-document.htm. Attention is drawn to the limitation of liability, indemnification and jurisdiction issues defined therein. Any holder of this document is advised that information contained hereon reflects the Company's findings at the time of its intervention only and within the limits of Client's instructions, if any. The Company's sole responsibility is to its Client and this document does not exonerate parties to a transaction from exercising all their rights and obligations under the transaction documents. This document cannot be reproduced except in full, without prior written approval of the Company. Any unauthorized alteration, forgery or falsification of the content or appearance of this document is unlawful and offenders may be prosecuted to the fullest extent of the law.

Operation Band :802.11n40
Fundamental Frequency :5710 MHz
Operation Mode :Tx CH CH142
EUT Pol. :E1 Plane

Test Date :2019-03-13
Temp./Humi. :23 deg_C / 62 RH
Engineer :Wei
Measurement Antenna Pol. :VERTICAL

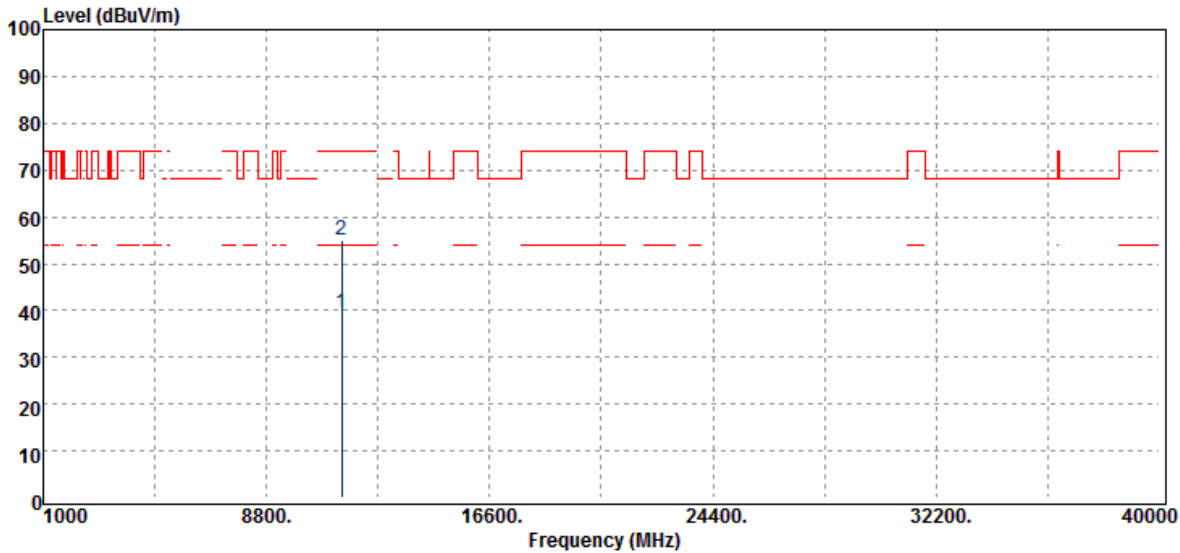

Freq. MHz	Detector Mode PK/QP/AV	Spectrum Reading Level dB μ V	Factor dB	Actual FS dB μ V/m	Limit @3m dB μ V/m	Margin dB
11420.00	Average	22.68	16.87	39.55	54.00	-14.45
11420.00	Peak	38.26	16.87	55.13	74.00	-18.87

Unless otherwise stated the results shown in this test report refer only to the sample(s) tested and such sample(s) are retained for 90 days only.

除非另有說明，此報告結果僅對測試之樣品負責，同時此樣品僅保留90天。本報告未經本公司書面許可，不可部份複製。

This document is issued by the Company subject to its General Conditions of Service printed overleaf, available on request or accessible at www.sgs.com/terms_and_conditions.htm and for electronic format documents, subject to Terms and Conditions for Electronic Documents at www.sgs.com/terms_e-document.htm. Attention is drawn to the limitation of liability, indemnification and jurisdiction issues defined therein. Any holder of this document is advised that information contained hereon reflects the Company's findings at the time of its intervention only and within the limits of Client's instructions, if any. The Company's sole responsibility is to its Client and this document does not exonerate parties to a transaction from exercising all their rights and obligations under the transaction documents. This document cannot be reproduced except in full, without prior written approval of the Company. Any unauthorized alteration, forgery or falsification of the content or appearance of this document is unlawful and offenders may be prosecuted to the fullest extent of the law.

Operation Band :802.11n40
Fundamental Frequency :5710 MHz
Operation Mode :Tx CH CH142
EUT Pol. :E1 Plane

Test Date :2019-03-13
Temp./Humi. :23 deg_C / 62 RH
Engineer :Wei
Measurement Antenna Pol. :HORIZONTAL

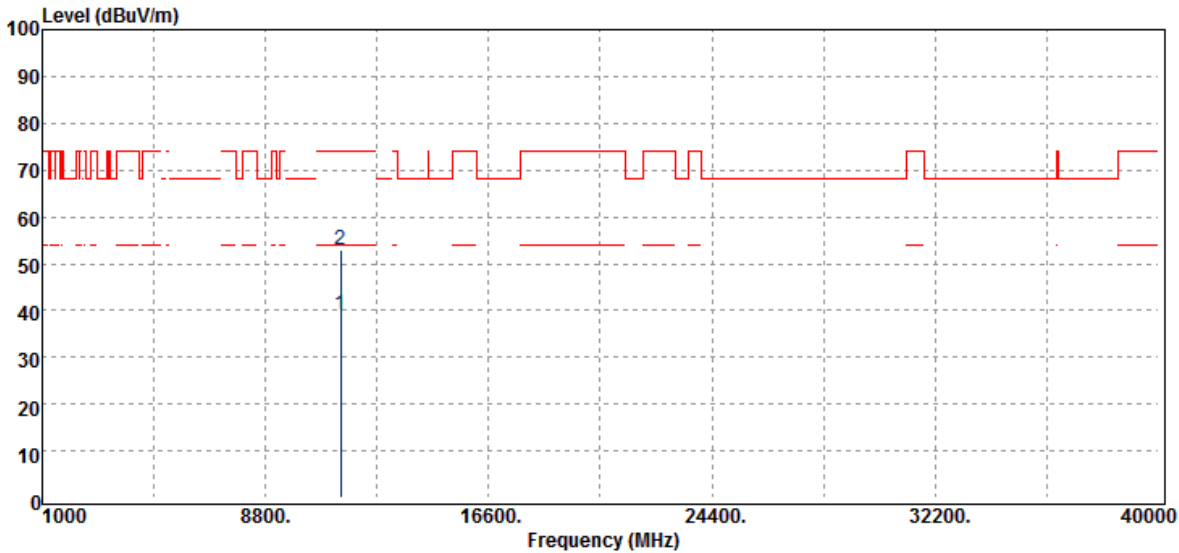

Freq. MHz	Detector Mode PK/QP/AV	Spectrum Reading Level dB μ V	Factor dB	Actual FS dB μ V/m	Limit @3m dB μ V/m	Margin dB
11420.00	Average	22.33	16.87	39.20	54.00	-14.80
11420.00	Peak	36.04	16.87	52.91	74.00	-21.09

Unless otherwise stated the results shown in this test report refer only to the sample(s) tested and such sample(s) are retained for 90 days only.

除非另有說明，此報告結果僅對測試之樣品負責，同時此樣品僅保留90天。本報告未經本公司書面許可，不可部份複製。

This document is issued by the Company subject to its General Conditions of Service printed overleaf, available on request or accessible at www.sgs.com/terms_and_conditions.htm and for electronic format documents, subject to Terms and Conditions for Electronic Documents at www.sgs.com/terms_e-document.htm. Attention is drawn to the limitation of liability, indemnification and jurisdiction issues defined therein. Any holder of this document is advised that information contained hereon reflects the Company's findings at the time of its intervention only and within the limits of Client's instructions, if any. The Company's sole responsibility is to its Client and this document does not exonerate parties to a transaction from exercising all their rights and obligations under the transaction documents. This document cannot be reproduced except in full, without prior written approval of the Company. Any unauthorized alteration, forgery or falsification of the content or appearance of this document is unlawful and offenders may be prosecuted to the fullest extent of the law.

Radiated Spurious Emission Measurement Result 802.11n HT40, 5745~5825 MHz

Operation Band	:802.11n40B4	Test Date	:2019-03-13
Fundamental Frequency	:5755 MHz	Temp./Humi.	:23 deg_C / 62 RH
Operation Mode	:Tx CH LOW	Engineer	:Wei
EUT Pol.	:E1 Plane	Measurement Antenna Pol.	:VERTICAL

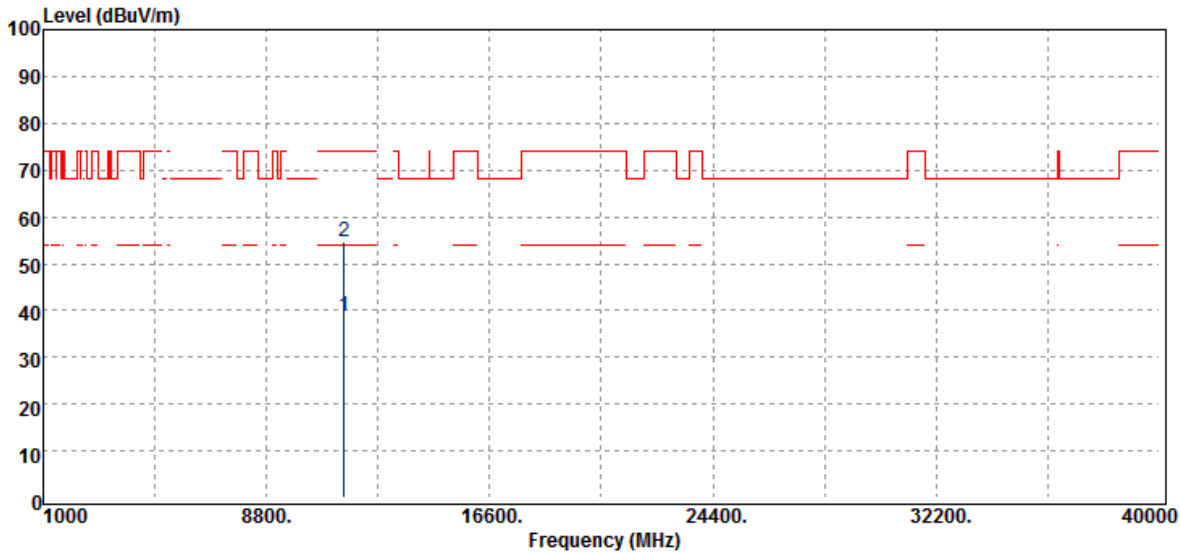

Freq. MHz	Detector Mode PK/QP/AV	Spectrum Reading Level dB μ V	Factor dB	Actual FS dB μ V/m	Limit @3m dB μ V/m	Margin dB
11510.00	Average	23.48	15.41	38.89	54.00	-15.11
11510.00	Peak	39.25	15.41	54.66	74.00	-19.34

Unless otherwise stated the results shown in this test report refer only to the sample(s) tested and such sample(s) are retained for 90 days only.

除非另有說明，此報告結果僅對測試之樣品負責，同時此樣品僅保留90天。本報告未經本公司書面許可，不可部份複製。

This document is issued by the Company subject to its General Conditions of Service printed overleaf, available on request or accessible at www.sgs.com/terms_and_conditions.htm and for electronic format documents, subject to Terms and Conditions for Electronic Documents at www.sgs.com/terms_e-document.htm. Attention is drawn to the limitation of liability, indemnification and jurisdiction issues defined therein. Any holder of this document is advised that information contained hereon reflects the Company's findings at the time of its intervention only and within the limits of Client's instructions, if any. The Company's sole responsibility is to its Client and this document does not exonerate parties to a transaction from exercising all their rights and obligations under the transaction documents. This document cannot be reproduced except in full, without prior written approval of the Company. Any unauthorized alteration, forgery or falsification of the content or appearance of this document is unlawful and offenders may be prosecuted to the fullest extent of the law.

Operation Band	:802.11n40B4	Test Date	:2019-03-13
Fundamental Frequency	:5755 MHz	Temp./Humi.	:23 deg_C / 62 RH
Operation Mode	:Tx CH LOW	Engineer	:Wei
EUT Pol.	:E1 Plane	Measurement Antenna Pol.	:HORIZONTAL

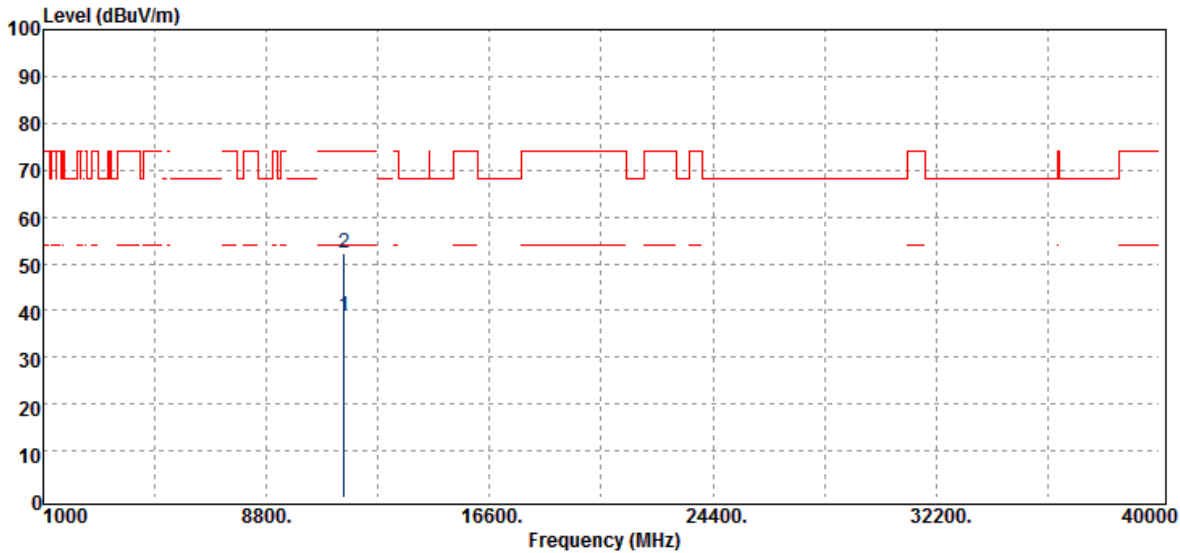

Freq. MHz	Detector Mode PK/QP/AV	Spectrum Reading Level dBuV	Factor dB	Actual FS dBuV/m	Limit @3m dBuV/m	Margin dB
11510.00	Average	23.24	15.41	38.65	54.00	-15.35
11510.00	Peak	36.83	15.41	52.24	74.00	-21.76

Unless otherwise stated the results shown in this test report refer only to the sample(s) tested and such sample(s) are retained for 90 days only.

除非另有說明，此報告結果僅對測試之樣品負責，同時此樣品僅保留90天。本報告未經本公司書面許可，不可部份複製。

This document is issued by the Company subject to its General Conditions of Service printed overleaf, available on request or accessible at www.sgs.com/terms_and_conditions.htm and for electronic format documents, subject to Terms and Conditions for Electronic Documents at www.sgs.com/terms_e-document.htm. Attention is drawn to the limitation of liability, indemnification and jurisdiction issues defined therein. Any holder of this document is advised that information contained hereon reflects the Company's findings at the time of its intervention only and within the limits of Client's instructions, if any. The Company's sole responsibility is to its Client and this document does not exonerate parties to a transaction from exercising all their rights and obligations under the transaction documents. This document cannot be reproduced except in full, without prior written approval of the Company. Any unauthorized alteration, forgery or falsification of the content or appearance of this document is unlawful and offenders may be prosecuted to the fullest extent of the law.

Operation Band	:802.11n40B4	Test Date	:2019-03-13
Fundamental Frequency	:5795 MHz	Temp./Humi.	:23 deg_C / 62 RH
Operation Mode	:Tx CH HIGH	Engineer	:Wei
EUT Pol.	:E1 Plane	Measurement Antenna Pol.	:VERTICAL

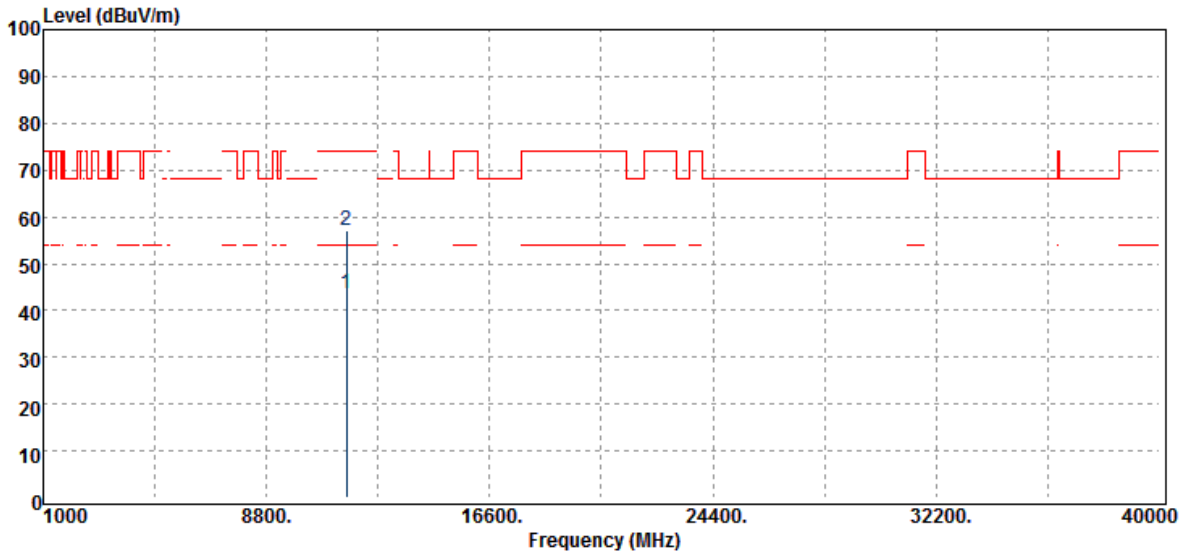

Freq. MHz	Detector Mode PK/QP/AV	Spectrum Reading Level dBuV	Factor dB	Actual FS dBuV/m	Limit @3m dBuV/m	Margin dB
11590.00	Average	26.79	16.81	43.60	54.00	-10.40
11590.00	Peak	40.19	16.81	57.00	74.00	-17.00

Unless otherwise stated the results shown in this test report refer only to the sample(s) tested and such sample(s) are retained for 90 days only.

除非另有說明，此報告結果僅對測試之樣品負責，同時此樣品僅保留90天。本報告未經本公司書面許可，不可部份複製。

This document is issued by the Company subject to its General Conditions of Service printed overleaf, available on request or accessible at www.sgs.com/terms_and_conditions.htm and for electronic format documents, subject to Terms and Conditions for Electronic Documents at www.sgs.com/terms_e-document.htm. Attention is drawn to the limitation of liability, indemnification and jurisdiction issues defined therein. Any holder of this document is advised that information contained hereon reflects the Company's findings at the time of its intervention only and within the limits of Client's instructions, if any. The Company's sole responsibility is to its Client and this document does not exonerate parties to a transaction from exercising all their rights and obligations under the transaction documents. This document cannot be reproduced except in full, without prior written approval of the Company. Any unauthorized alteration, forgery or falsification of the content or appearance of this document is unlawful and offenders may be prosecuted to the fullest extent of the law.

Operation Band	:802.11n40B4	Test Date	:2019-03-13
Fundamental Frequency	:5795 MHz	Temp./Humi.	:23 deg_C / 62 RH
Operation Mode	:Tx CH HIGH	Engineer	:Wei
EUT Pol.	:E1 Plane	Measurement Antenna Pol.	:HORIZONTAL

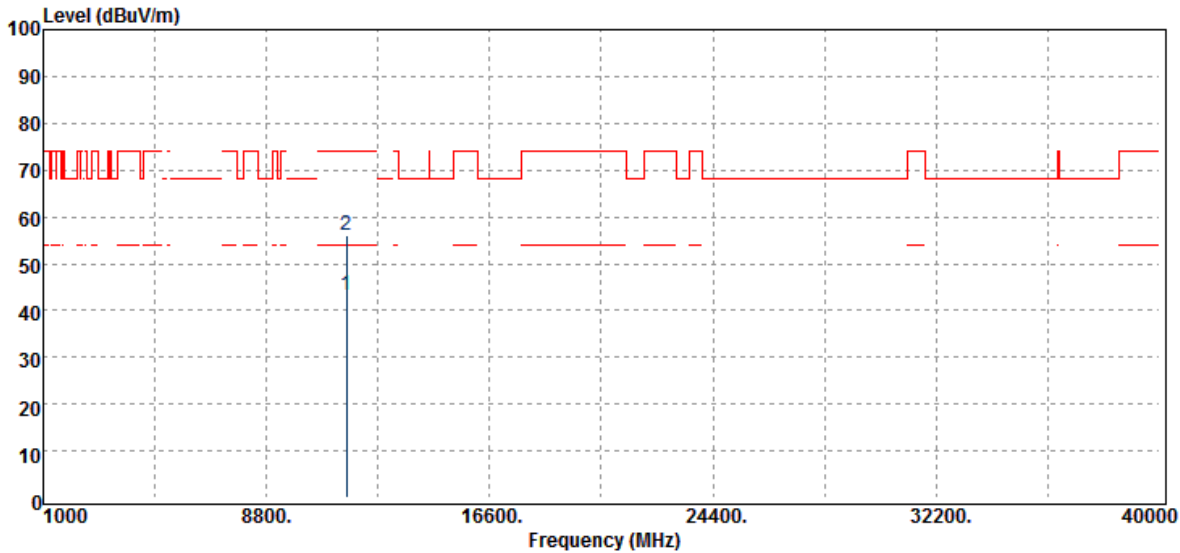

Freq. MHz	Detector Mode PK/QP/AV	Spectrum Reading Level dBuV	Factor dB	Actual FS dBuV/m	Limit @3m dBuV/m	Margin dB
11590.00	Average	26.51	16.81	43.32	54.00	-10.68
11590.00	Peak	39.40	16.81	56.21	74.00	-17.79

Unless otherwise stated the results shown in this test report refer only to the sample(s) tested and such sample(s) are retained for 90 days only.

除非另有說明，此報告結果僅對測試之樣品負責，同時此樣品僅保留90天。本報告未經本公司書面許可，不可部份複製。

This document is issued by the Company subject to its General Conditions of Service printed overleaf, available on request or accessible at www.sgs.com/terms_and_conditions.htm and for electronic format documents, subject to Terms and Conditions for Electronic Documents at www.sgs.com/terms_e-document.htm. Attention is drawn to the limitation of liability, indemnification and jurisdiction issues defined therein. Any holder of this document is advised that information contained hereon reflects the Company's findings at the time of its intervention only and within the limits of Client's instructions, if any. The Company's sole responsibility is to its Client and this document does not exonerate parties to a transaction from exercising all their rights and obligations under the transaction documents. This document cannot be reproduced except in full, without prior written approval of the Company. Any unauthorized alteration, forgery or falsification of the content or appearance of this document is unlawful and offenders may be prosecuted to the fullest extent of the law.

Radiated Spurious Emission Measurement Result 802.11ac VHT80, 5150~5250 MHz

Operation Band	:802.11ac80B1	Test Date	:2019-03-09
Fundamental Frequency	:5210 MHz	Temp./Humi.	:20 deg_C / 61 RH
Operation Mode	:Tx CH LOW	Engineer	:Wei
EUT Pol.	:E1 Plane	Measurement Antenna Pol.	:VERTICAL

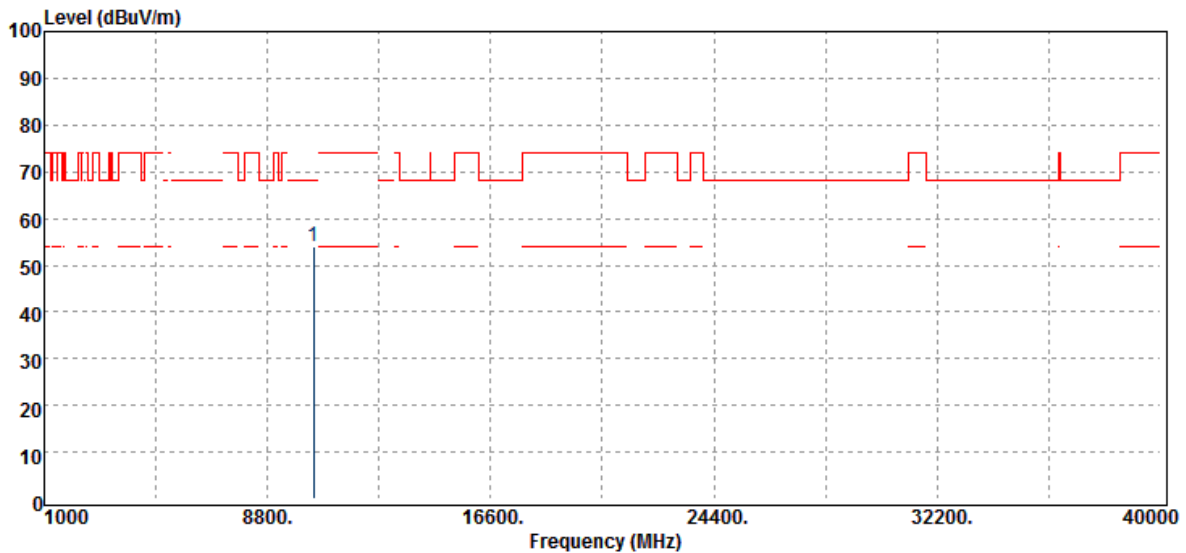

Freq. MHz	Detector Mode PK/QP/AV	Spectrum Reading Level dBuV	Factor dB	Actual FS dBuV/m	Limit @3m dBuV/m	Margin dB
10420.00	Peak	38.85	15.12	53.97	68.20	-14.23

Unless otherwise stated the results shown in this test report refer only to the sample(s) tested and such sample(s) are retained for 90 days only.

除非另有說明，此報告結果僅對測試之樣品負責，同時此樣品僅保留90天。本報告未經本公司書面許可，不可部份複製。

This document is issued by the Company subject to its General Conditions of Service printed overleaf, available on request or accessible at www.sgs.com/terms_and_conditions.htm and for electronic format documents, subject to Terms and Conditions for Electronic Documents at www.sgs.com/terms_e-document.htm. Attention is drawn to the limitation of liability, indemnification and jurisdiction issues defined therein. Any holder of this document is advised that information contained hereon reflects the Company's findings at the time of its intervention only and within the limits of Client's instructions, if any. The Company's sole responsibility is to its Client and this document does not exonerate parties to a transaction from exercising all their rights and obligations under the transaction documents. This document cannot be reproduced except in full, without prior written approval of the Company. Any unauthorized alteration, forgery or falsification of the content or appearance of this document is unlawful and offenders may be prosecuted to the fullest extent of the law.

Operation Band	:802.11ac80B1	Test Date	:2019-03-09
Fundamental Frequency	:5210 MHz	Temp./Humi.	:20 deg_C / 61 RH
Operation Mode	:Tx CH LOW	Engineer	:Wei
EUT Pol.	:E1 Plane	Measurement Antenna Pol.	:HORIZONTAL

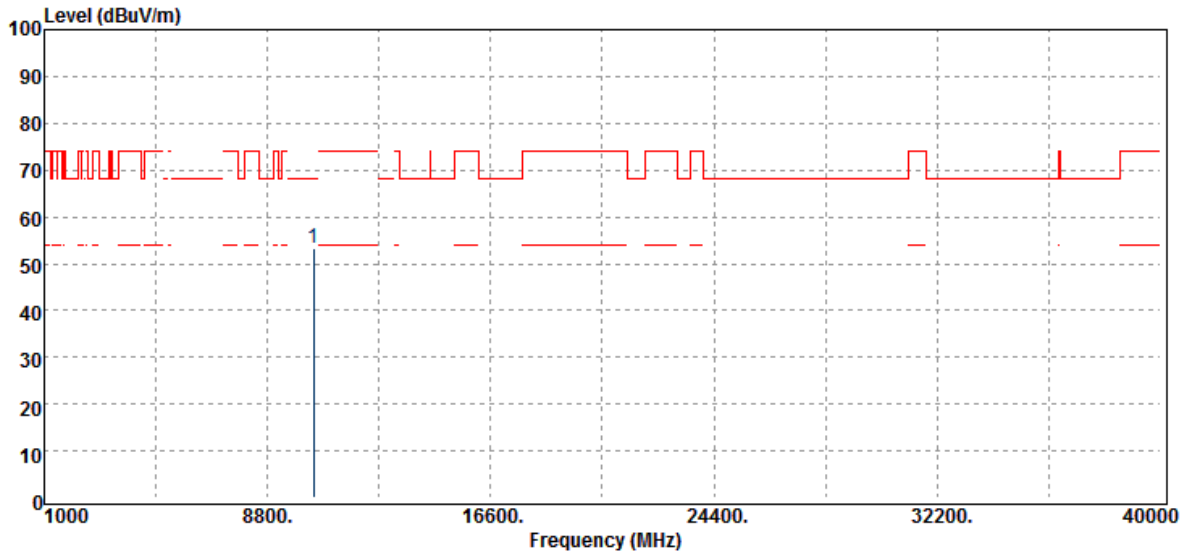

Freq. MHz	Detector Mode PK/QP/AV	Spectrum Reading Level dBuV	Factor dB	Actual FS dBuV/m	Limit @3m dBuV/m	Margin dB
10420.00	Peak	38.20	15.12	53.32	68.20	-14.88

Unless otherwise stated the results shown in this test report refer only to the sample(s) tested and such sample(s) are retained for 90 days only.

除非另有說明，此報告結果僅對測試之樣品負責，同時此樣品僅保留90天。本報告未經本公司書面許可，不可部份複製。

This document is issued by the Company subject to its General Conditions of Service printed overleaf, available on request or accessible at www.sgs.com/terms_and_conditions.htm and for electronic format documents, subject to Terms and Conditions for Electronic Documents at www.sgs.com/terms_e-document.htm. Attention is drawn to the limitation of liability, indemnification and jurisdiction issues defined therein. Any holder of this document is advised that information contained hereon reflects the Company's findings at the time of its intervention only and within the limits of Client's instructions, if any. The Company's sole responsibility is to its Client and this document does not exonerate parties to a transaction from exercising all their rights and obligations under the transaction documents. This document cannot be reproduced except in full, without prior written approval of the Company. Any unauthorized alteration, forgery or falsification of the content or appearance of this document is unlawful and offenders may be prosecuted to the fullest extent of the law.

Radiated Spurious Emission Measurement Result 802.11ac VHT80, 5250~5350 MHz

Operation Band	:802.11ac80B2	Test Date	:2019-03-09
Fundamental Frequency	:5290 MHz	Temp./Humi.	:20 deg_C / 61 RH
Operation Mode	:Tx CH HIGH	Engineer	:Wei
EUT Pol.	:E1 Plane	Measurement Antenna Pol.	:VERTICAL

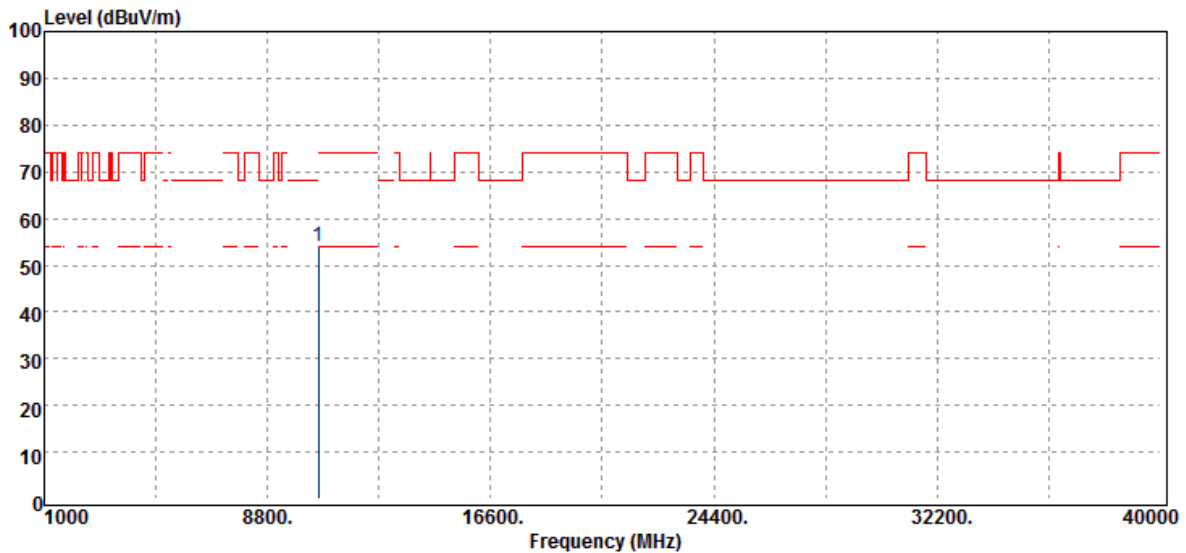

Freq. MHz	Detector Mode PK/QP/AV	Spectrum Reading Level dBuV	Factor dB	Actual FS dBuV/m	Limit @3m dBuV/m	Margin dB
10580.00	Peak	38.56	15.43	53.99	68.20	-14.21

Unless otherwise stated the results shown in this test report refer only to the sample(s) tested and such sample(s) are retained for 90 days only.

除非另有說明，此報告結果僅對測試之樣品負責，同時此樣品僅保留90天。本報告未經本公司書面許可，不可部份複製。

This document is issued by the Company subject to its General Conditions of Service printed overleaf, available on request or accessible at www.sgs.com/terms_and_conditions.htm and for electronic format documents, subject to Terms and Conditions for Electronic Documents at www.sgs.com/terms_e-document.htm. Attention is drawn to the limitation of liability, indemnification and jurisdiction issues defined therein. Any holder of this document is advised that information contained hereon reflects the Company's findings at the time of its intervention only and within the limits of Client's instructions, if any. The Company's sole responsibility is to its Client and this document does not exonerate parties to a transaction from exercising all their rights and obligations under the transaction documents. This document cannot be reproduced except in full, without prior written approval of the Company. Any unauthorized alteration, forgery or falsification of the content or appearance of this document is unlawful and offenders may be prosecuted to the fullest extent of the law.

Operation Band :802.11ac80B2
Fundamental Frequency :5290 MHz
Operation Mode :Tx CH HIGH
EUT Pol. :E1 Plane

Test Date :2019-03-09
Temp./Humi. :20 deg_C / 61 RH
Engineer :Wei
Measurement Antenna Pol. :HORIZONTAL

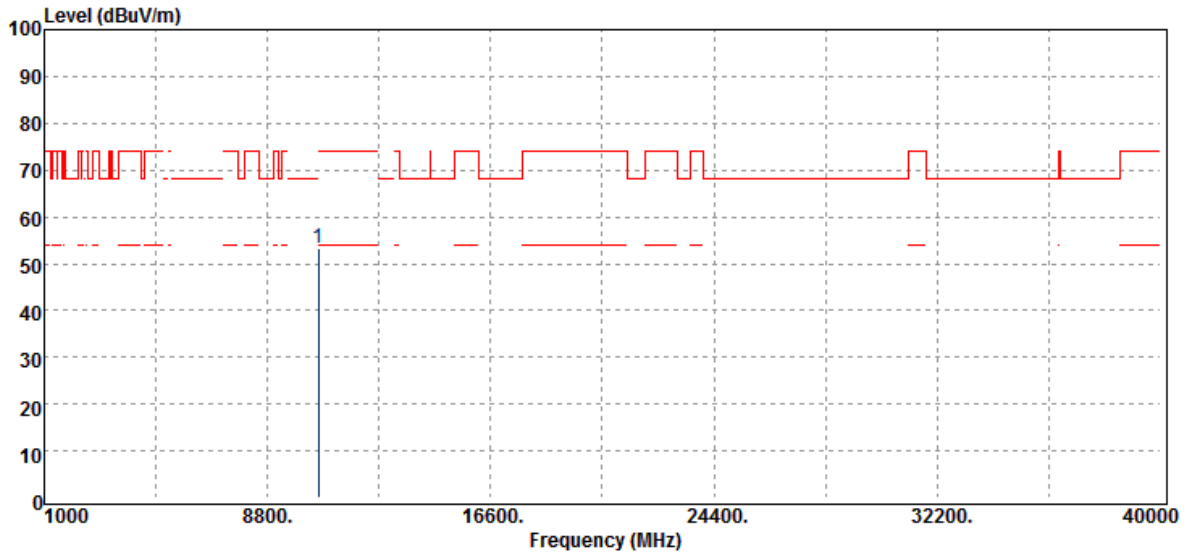

Freq. MHz	Detector Mode PK/QP/AV	Spectrum Reading Level dB μ V	Factor dB	Actual FS dB μ V/m	Limit @3m dB μ V/m	Margin dB
10580.00	Peak	37.91	15.43	53.34	68.20	-14.86

Unless otherwise stated the results shown in this test report refer only to the sample(s) tested and such sample(s) are retained for 90 days only.

除非另有說明，此報告結果僅對測試之樣品負責，同時此樣品僅保留90天。本報告未經本公司書面許可，不可部份複製。

This document is issued by the Company subject to its General Conditions of Service printed overleaf, available on request or accessible at www.sgs.com/terms_and_conditions.htm and for electronic format documents, subject to Terms and Conditions for Electronic Documents at www.sgs.com/terms_e-document.htm. Attention is drawn to the limitation of liability, indemnification and jurisdiction issues defined therein. Any holder of this document is advised that information contained hereon reflects the Company's findings at the time of its intervention only and within the limits of Client's instructions, if any. The Company's sole responsibility is to its Client and this document does not exonerate parties to a transaction from exercising all their rights and obligations under the transaction documents. This document cannot be reproduced except in full, without prior written approval of the Company. Any unauthorized alteration, forgery or falsification of the content or appearance of this document is unlawful and offenders may be prosecuted to the fullest extent of the law.

Radiated Spurious Emission Measurement Result 802.11ac VHT80, 5470~5725 MHz

Operation Band	:802.11ac80B3	Test Date	:2019-03-09
Fundamental Frequency	:5530 MHz	Temp./Humi.	:20 deg_C / 61 RH
Operation Mode	:Tx CH LOW	Engineer	:Wei
EUT Pol.	:E1 Plane	Measurement Antenna Pol.	:VERTICAL

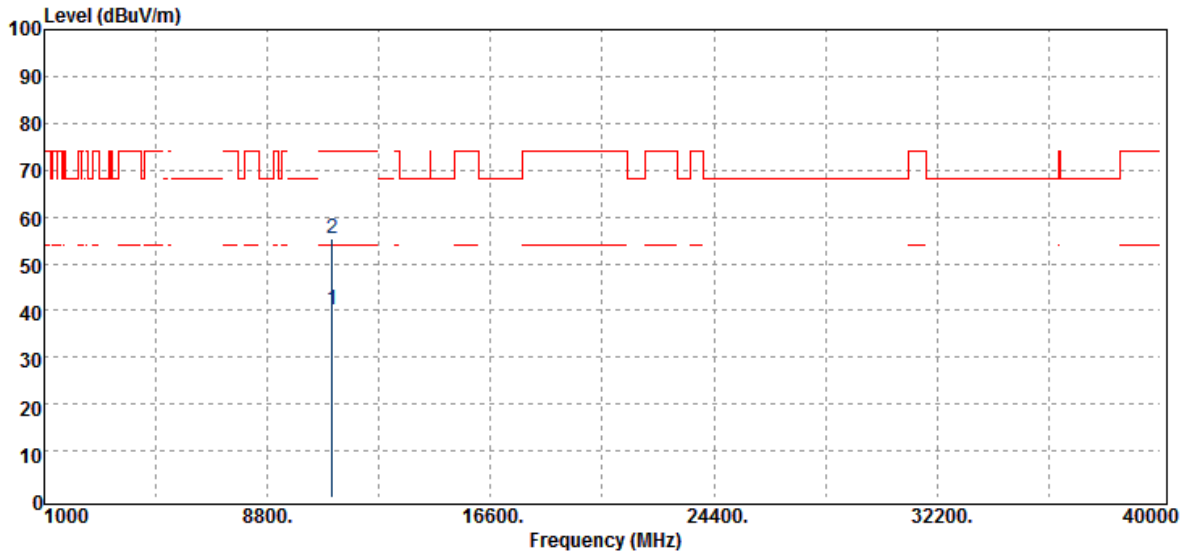

Freq. MHz	Detector Mode PK/QP/AV	Spectrum Reading Level dB μ V	Factor dB	Actual FS dB μ V/m	Limit @3m dB μ V/m	Margin dB
11060.00	Average	22.68	17.50	40.18	54.00	-13.82
11060.00	Peak	37.91	17.50	55.41	74.00	-18.59

Unless otherwise stated the results shown in this test report refer only to the sample(s) tested and such sample(s) are retained for 90 days only.

除非另有說明，此報告結果僅對測試之樣品負責，同時此樣品僅保留90天。本報告未經本公司書面許可，不可部份複製。

This document is issued by the Company subject to its General Conditions of Service printed overleaf, available on request or accessible at www.sgs.com/terms_and_conditions.htm and for electronic format documents, subject to Terms and Conditions for Electronic Documents at www.sgs.com/terms_e-document.htm. Attention is drawn to the limitation of liability, indemnification and jurisdiction issues defined therein. Any holder of this document is advised that information contained hereon reflects the Company's findings at the time of its intervention only and within the limits of Client's instructions, if any. The Company's sole responsibility is to its Client and this document does not exonerate parties to a transaction from exercising all their rights and obligations under the transaction documents. This document cannot be reproduced except in full, without prior written approval of the Company. Any unauthorized alteration, forgery or falsification of the content or appearance of this document is unlawful and offenders may be prosecuted to the fullest extent of the law.

Operation Band :802.11ac80B3
Fundamental Frequency :5530 MHz
Operation Mode :Tx CH LOW
EUT Pol. :E1 Plane

Test Date :2019-03-09
Temp./Humi. :20 deg_C / 61 RH
Engineer :Wei
Measurement Antenna Pol. :HORIZONTAL

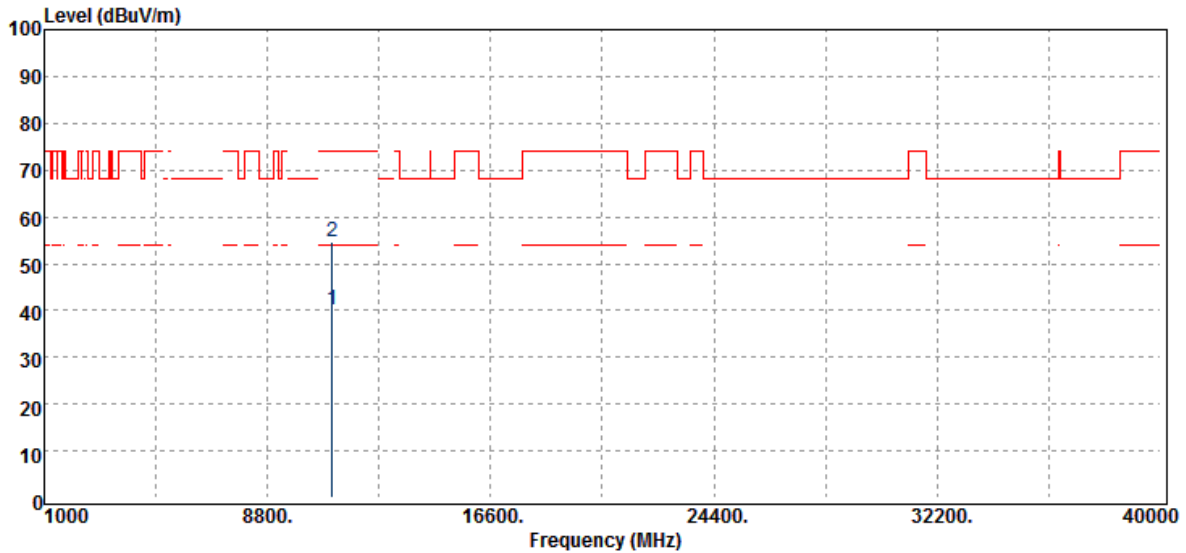

Freq. MHz	Detector Mode PK/QP/AV	Spectrum Reading Level dB μ V	Factor dB	Actual FS dB μ V/m	Limit @3m dB μ V/m	Margin dB
11060.00	Average	22.47	17.50	39.97	54.00	-14.03
11060.00	Peak	37.33	17.50	54.83	74.00	-19.17

Unless otherwise stated the results shown in this test report refer only to the sample(s) tested and such sample(s) are retained for 90 days only.

除非另有說明，此報告結果僅對測試之樣品負責，同時此樣品僅保留90天。本報告未經本公司書面許可，不可部份複製。

This document is issued by the Company subject to its General Conditions of Service printed overleaf, available on request or accessible at www.sgs.com/terms_and_conditions.htm and for electronic format documents, subject to Terms and Conditions for Electronic Documents at www.sgs.com/terms_e-document.htm. Attention is drawn to the limitation of liability, indemnification and jurisdiction issues defined therein. Any holder of this document is advised that information contained hereon reflects the Company's findings at the time of its intervention only and within the limits of Client's instructions, if any. The Company's sole responsibility is to its Client and this document does not exonerate parties to a transaction from exercising all their rights and obligations under the transaction documents. This document cannot be reproduced except in full, without prior written approval of the Company. Any unauthorized alteration, forgery or falsification of the content or appearance of this document is unlawful and offenders may be prosecuted to the fullest extent of the law.

Operation Band	:802.11ac80B3	Test Date	:2019-03-09
Fundamental Frequency	:5610 MHz	Temp./Humi.	:20 deg_C / 61 RH
Operation Mode	:Tx CH MID	Engineer	:Wei
EUT Pol.	:E1 Plane	Measurement Antenna Pol.	:VERTICAL

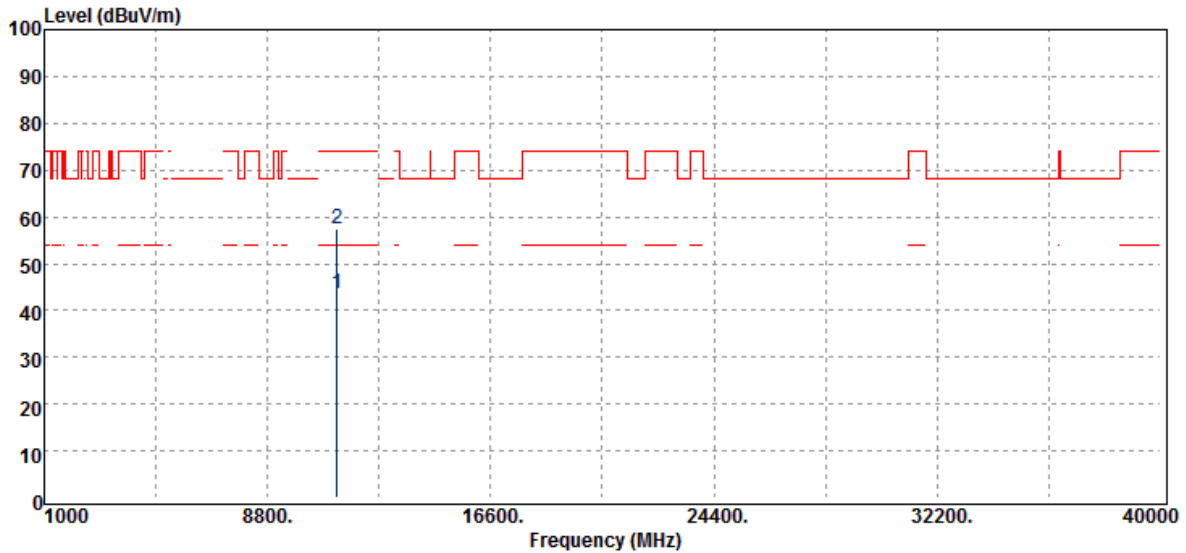

Freq. MHz	Detector Mode PK/QP/AV	Spectrum Reading Level dBuV	Factor dB	Actual FS dBuV/m	Limit @3m dBuV/m	Margin dB
11220.00	Average	26.93	16.53	43.46	54.00	-10.54
11220.00	Peak	40.88	16.53	57.41	74.00	-16.59

Unless otherwise stated the results shown in this test report refer only to the sample(s) tested and such sample(s) are retained for 90 days only.

除非另有說明，此報告結果僅對測試之樣品負責，同時此樣品僅保留90天。本報告未經本公司書面許可，不可部份複製。

This document is issued by the Company subject to its General Conditions of Service printed overleaf, available on request or accessible at www.sgs.com/terms_and_conditions.htm and for electronic format documents, subject to Terms and Conditions for Electronic Documents at www.sgs.com/terms_e-document.htm. Attention is drawn to the limitation of liability, indemnification and jurisdiction issues defined therein. Any holder of this document is advised that information contained hereon reflects the Company's findings at the time of its intervention only and within the limits of Client's instructions, if any. The Company's sole responsibility is to its Client and this document does not exonerate parties to a transaction from exercising all their rights and obligations under the transaction documents. This document cannot be reproduced except in full, without prior written approval of the Company. Any unauthorized alteration, forgery or falsification of the content or appearance of this document is unlawful and offenders may be prosecuted to the fullest extent of the law.

Operation Band	:802.11ac80B3	Test Date	:2019-03-09
Fundamental Frequency	:5610 MHz	Temp./Humi.	:20 deg_C / 61 RH
Operation Mode	:Tx CH MID	Engineer	:Wei
EUT Pol.	:E1 Plane	Measurement Antenna Pol.	:HORIZONTAL

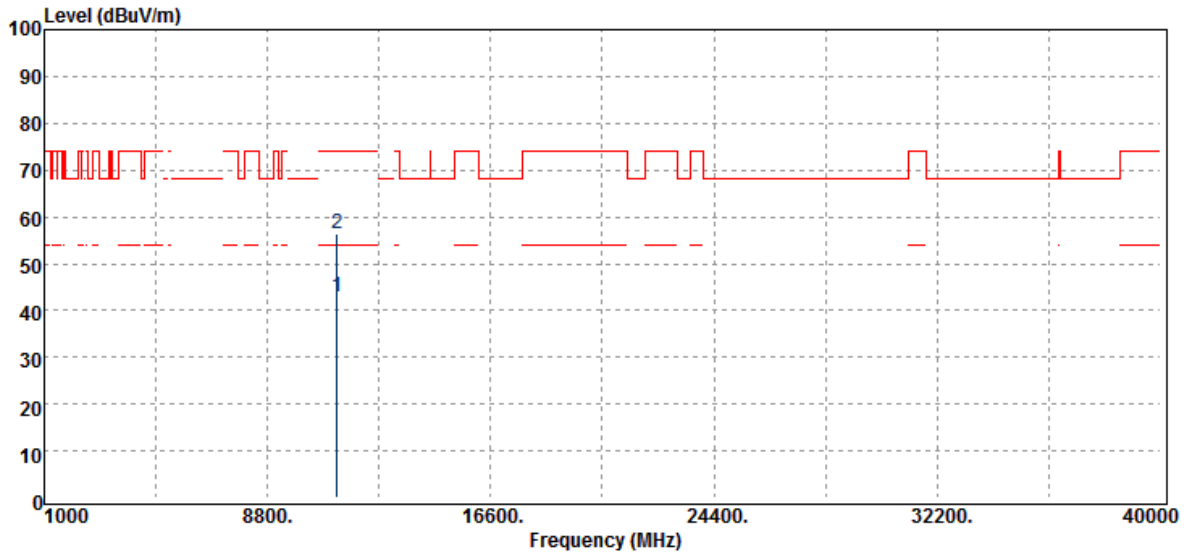

Freq. MHz	Detector Mode PK/QP/AV	Spectrum Reading Level dB μ V	Factor dB	Actual FS dB μ V/m	Limit @3m dB μ V/m	Margin dB
11220.00	Average	26.34	16.53	42.87	54.00	-11.13
11220.00	Peak	40.02	16.53	56.55	74.00	-17.45

Unless otherwise stated the results shown in this test report refer only to the sample(s) tested and such sample(s) are retained for 90 days only.

除非另有說明，此報告結果僅對測試之樣品負責，同時此樣品僅保留90天。本報告未經本公司書面許可，不可部份複製。

This document is issued by the Company subject to its General Conditions of Service printed overleaf, available on request or accessible at www.sgs.com/terms_and_conditions.htm and for electronic format documents, subject to Terms and Conditions for Electronic Documents at www.sgs.com/terms_e-document.htm. Attention is drawn to the limitation of liability, indemnification and jurisdiction issues defined therein. Any holder of this document is advised that information contained hereon reflects the Company's findings at the time of its intervention only and within the limits of Client's instructions, if any. The Company's sole responsibility is to its Client and this document does not exonerate parties to a transaction from exercising all their rights and obligations under the transaction documents. This document cannot be reproduced except in full, without prior written approval of the Company. Any unauthorized alteration, forgery or falsification of the content or appearance of this document is unlawful and offenders may be prosecuted to the fullest extent of the law.

Radiated Spurious Emission Measurement Result 802.11ac VHT80, 5745~5825 MHz

Operation Band	:802.11ac80B4	Test Date	:2019-03-13
Fundamental Frequency	:5775 MHz	Temp./Humi.	:23 deg_C / 62 RH
Operation Mode	:Tx CH LOW	Engineer	:Wei
EUT Pol.	:E1 Plane	Measurement Antenna Pol.	:VERTICAL

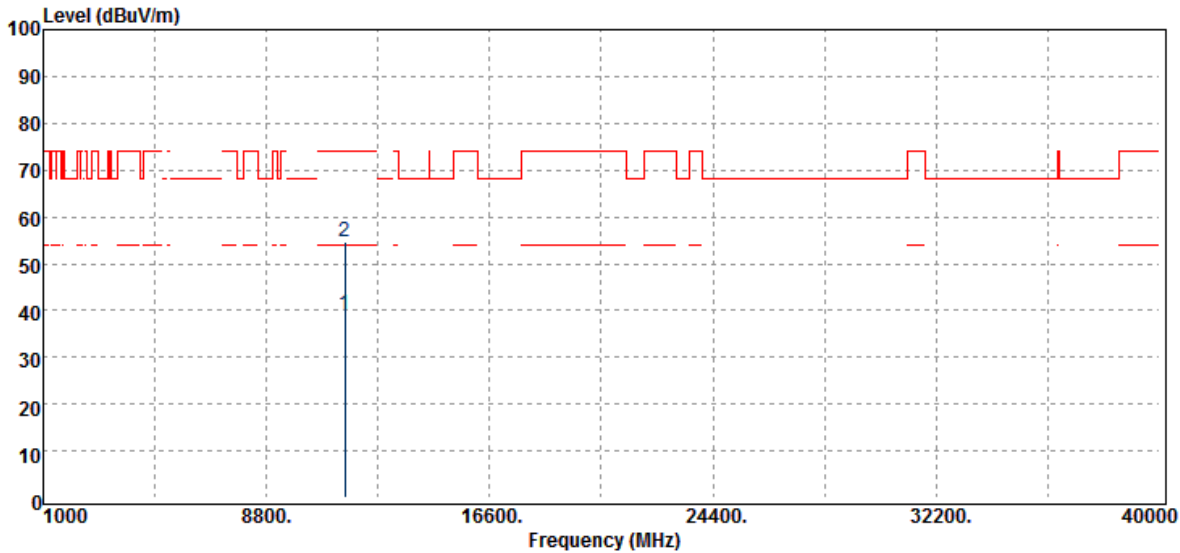

Freq. MHz	Detector Mode PK/QP/AV	Spectrum Reading Level dB μ V	Factor dB	Actual FS dB μ V/m	Limit @3m dB μ V/m	Margin dB
11550.00	Average	23.18	15.82	39.00	54.00	-15.00
11550.00	Peak	38.83	15.82	54.65	74.00	-19.35

Unless otherwise stated the results shown in this test report refer only to the sample(s) tested and such sample(s) are retained for 90 days only.

除非另有說明，此報告結果僅對測試之樣品負責，同時此樣品僅保留90天。本報告未經本公司書面許可，不可部份複製。

This document is issued by the Company subject to its General Conditions of Service printed overleaf, available on request or accessible at www.sgs.com/terms_and_conditions.htm and for electronic format documents, subject to Terms and Conditions for Electronic Documents at www.sgs.com/terms_e-document.htm. Attention is drawn to the limitation of liability, indemnification and jurisdiction issues defined therein. Any holder of this document is advised that information contained hereon reflects the Company's findings at the time of its intervention only and within the limits of Client's instructions, if any. The Company's sole responsibility is to its Client and this document does not exonerate parties to a transaction from exercising all their rights and obligations under the transaction documents. This document cannot be reproduced except in full, without prior written approval of the Company. Any unauthorized alteration, forgery or falsification of the content or appearance of this document is unlawful and offenders may be prosecuted to the fullest extent of the law.

Operation Band :802.11ac80B4
Fundamental Frequency :5775 MHz
Operation Mode :Tx CH LOW
EUT Pol. :E1 Plane

Test Date :2019-03-13
Temp./Humi. :23 deg_C / 62 RH
Engineer :Wei
Measurement Antenna Pol. :HORIZONTAL

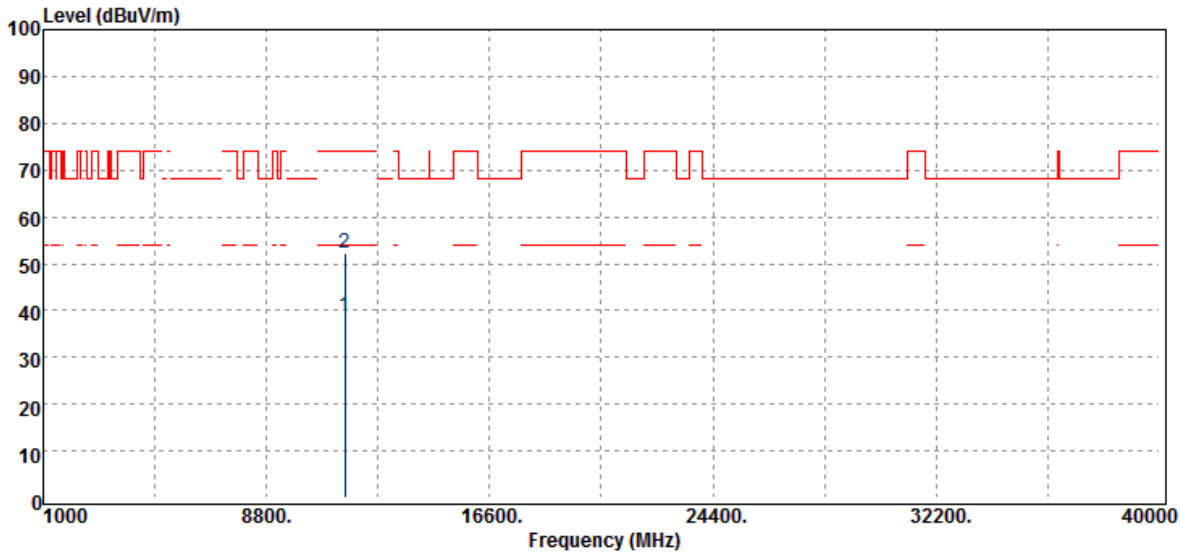

Freq. MHz	Detector Mode PK/QP/AV	Spectrum Reading Level dBuV	Factor dB	Actual FS dBuV/m	Limit @3m dBuV/m	Margin dB
11550.00	Average	22.91	15.82	38.73	54.00	-15.27
11550.00	Peak	36.59	15.82	52.41	74.00	-21.59

Unless otherwise stated the results shown in this test report refer only to the sample(s) tested and such sample(s) are retained for 90 days only.

除非另有說明，此報告結果僅對測試之樣品負責，同時此樣品僅保留90天。本報告未經本公司書面許可，不可部份複製。

This document is issued by the Company subject to its General Conditions of Service printed overleaf, available on request or accessible at www.sgs.com/terms_and_conditions.htm and for electronic format documents, subject to Terms and Conditions for Electronic Documents at www.sgs.com/terms_e-document.htm. Attention is drawn to the limitation of liability, indemnification and jurisdiction issues defined therein. Any holder of this document is advised that information contained hereon reflects the Company's findings at the time of its intervention only and within the limits of Client's instructions, if any. The Company's sole responsibility is to its Client and this document does not exonerate parties to a transaction from exercising all their rights and obligations under the transaction documents. This document cannot be reproduced except in full, without prior written approval of the Company. Any unauthorized alteration, forgery or falsification of the content or appearance of this document is unlawful and offenders may be prosecuted to the fullest extent of the law.

Band Edge falling to restricted band

802.11a mode

Operation Band :802.11aB1
Fundamental Frequency :5180 MHz
Operation Mode :Bandedge CH LOW
EUT Pol. :E1 Plane

Test Date :2019-03-26
Temp./Humi. :23 deg_C / 62 RH
Engineer :Wei
Measurement Antenna Pol. :VERTICAL

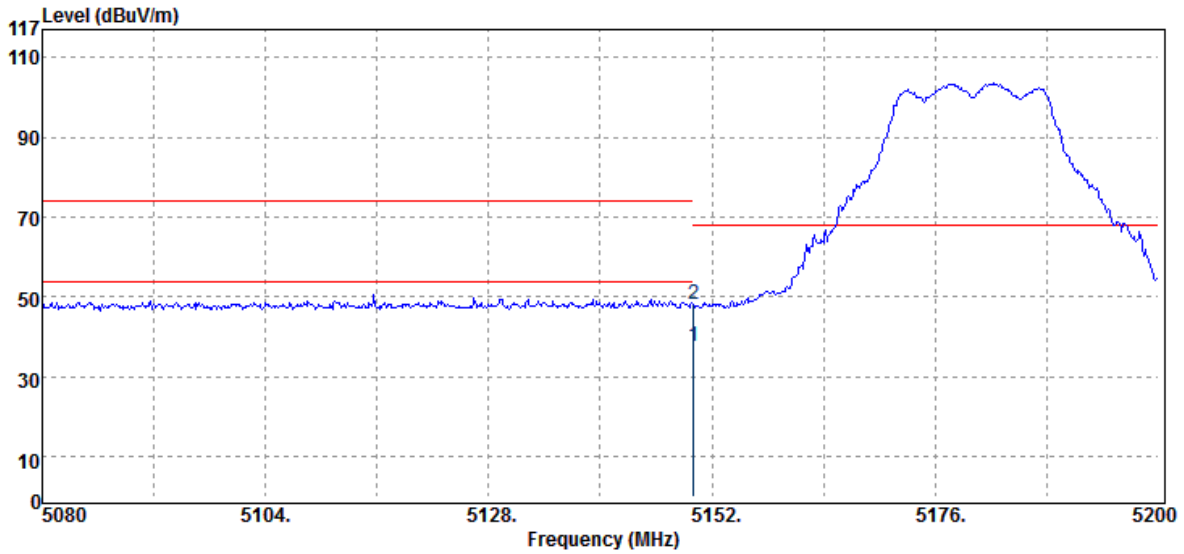

Freq. MHz	Detector Mode PK/QP/AV	Spectrum Reading Level dB μ V	Factor dB	Actual FS dB μ V/m	Limit @3m dB μ V/m	Margin dB
5150.00	Average	32.92	4.54	37.46	54.00	-16.54
5150.00	Peak	43.45	4.54	47.99	74.00	-26.01

Unless otherwise stated the results shown in this test report refer only to the sample(s) tested and such sample(s) are retained for 90 days only.

除非另有說明，此報告結果僅對測試之樣品負責，同時此樣品僅保留90天。本報告未經本公司書面許可，不可部份複製。

This document is issued by the Company subject to its General Conditions of Service printed overleaf, available on request or accessible at www.sgs.com/terms_and_conditions.htm and for electronic format documents, subject to Terms and Conditions for Electronic Documents at www.sgs.com/terms_e-document.htm. Attention is drawn to the limitation of liability, indemnification and jurisdiction issues defined therein. Any holder of this document is advised that information contained hereon reflects the Company's findings at the time of its intervention only and within the limits of Client's instructions, if any. The Company's sole responsibility is to its Client and this document does not exonerate parties to a transaction from exercising all their rights and obligations under the transaction documents. This document cannot be reproduced except in full, without prior written approval of the Company. Any unauthorized alteration, forgery or falsification of the content or appearance of this document is unlawful and offenders may be prosecuted to the fullest extent of the law.

Operation Band :802.11aB1
Fundamental Frequency :5180 MHz
Operation Mode :Bandedge CH LOW
EUT Pol. :E1 Plane

Test Date :2019-03-26
Temp./Humi. :23 deg_C / 62 RH
Engineer :Wei
Measurement Antenna Pol. :HORIZONTAL

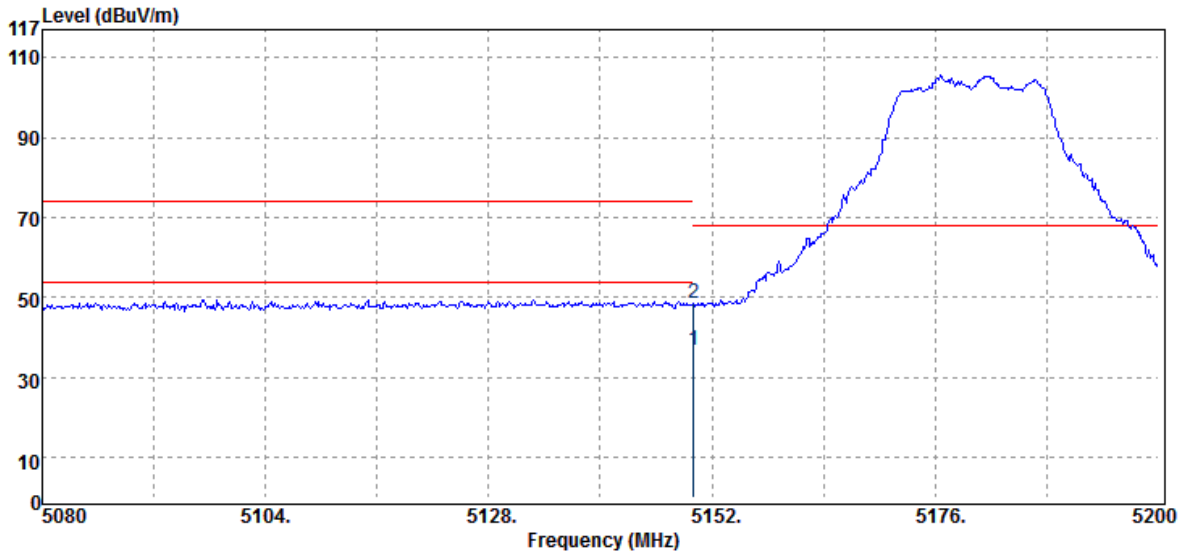

Freq. MHz	Detector Mode PK/QP/AV	Spectrum Reading Level dB μ V	Factor dB	Actual FS dB μ V/m	Limit @3m dB μ V/m	Margin dB
5150.00	Average	32.41	4.54	36.95	54.00	-17.05
5150.00	Peak	43.93	4.54	48.47	74.00	-25.53

Unless otherwise stated the results shown in this test report refer only to the sample(s) tested and such sample(s) are retained for 90 days only.

除非另有說明，此報告結果僅對測試之樣品負責，同時此樣品僅保留90天。本報告未經本公司書面許可，不可部份複製。

This document is issued by the Company subject to its General Conditions of Service printed overleaf, available on request or accessible at www.sgs.com/terms_and_conditions.htm and for electronic format documents, subject to Terms and Conditions for Electronic Documents at www.sgs.com/terms_e-document.htm. Attention is drawn to the limitation of liability, indemnification and jurisdiction issues defined therein. Any holder of this document is advised that information contained hereon reflects the Company's findings at the time of its intervention only and within the limits of Client's instructions, if any. The Company's sole responsibility is to its Client and this document does not exonerate parties to a transaction from exercising all their rights and obligations under the transaction documents. This document cannot be reproduced except in full, without prior written approval of the Company. Any unauthorized alteration, forgery or falsification of the content or appearance of this document is unlawful and offenders may be prosecuted to the fullest extent of the law.

Operation Band :802.11aB2
Fundamental Frequency :5320 MHz
Operation Mode :Bandedge CH HIGH
EUT Pol. :E1 Plane

Test Date :2019-03-26
Temp./Humi. :23 deg_C / 62 RH
Engineer :Wei
Measurement Antenna Pol. :VERTICAL

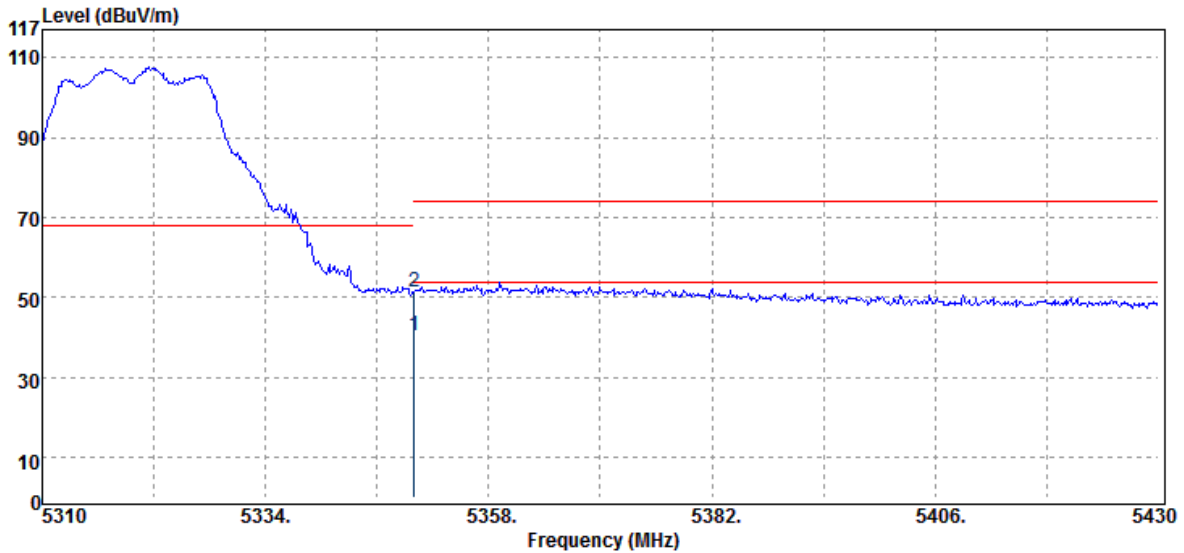

Freq. MHz	Detector Mode PK/QP/AV	Spectrum Reading Level dB μ V	Factor dB	Actual FS dB μ V/m	Limit @3m dB μ V/m	Margin dB
5350.00	Average	35.17	5.19	40.36	54.00	-13.64
5350.00	Peak	46.39	5.19	51.58	74.00	-22.42

Unless otherwise stated the results shown in this test report refer only to the sample(s) tested and such sample(s) are retained for 90 days only.

除非另有說明，此報告結果僅對測試之樣品負責，同時此樣品僅保留90天。本報告未經本公司書面許可，不可部份複製。

This document is issued by the Company subject to its General Conditions of Service printed overleaf, available on request or accessible at www.sgs.com/terms_and_conditions.htm and for electronic format documents, subject to Terms and Conditions for Electronic Documents at www.sgs.com/terms_e-document.htm. Attention is drawn to the limitation of liability, indemnification and jurisdiction issues defined therein. Any holder of this document is advised that information contained hereon reflects the Company's findings at the time of its intervention only and within the limits of Client's instructions, if any. The Company's sole responsibility is to its Client and this document does not exonerate parties to a transaction from exercising all their rights and obligations under the transaction documents. This document cannot be reproduced except in full, without prior written approval of the Company. Any unauthorized alteration, forgery or falsification of the content or appearance of this document is unlawful and offenders may be prosecuted to the fullest extent of the law.

Operation Band	:802.11aB2	Test Date	:2019-03-26
Fundamental Frequency	:5320 MHz	Temp./Humi.	:23 deg_C / 62 RH
Operation Mode	:Bandedge CH HIGH	Engineer	:Wei
EUT Pol.	:E1 Plane	Measurement Antenna Pol.	:HORIZONTAL

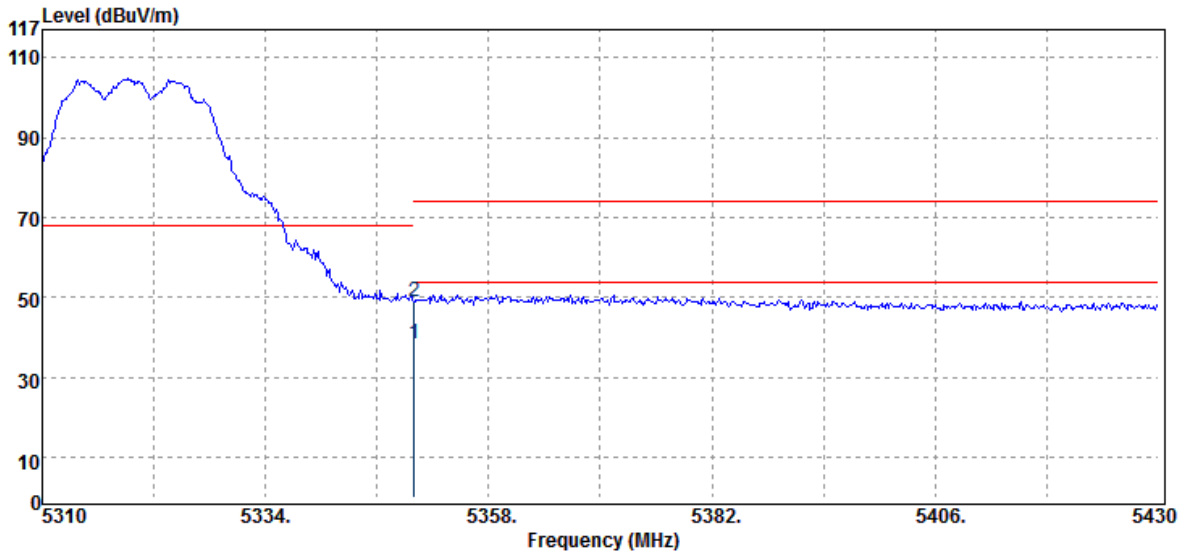

Freq. MHz	Detector Mode PK/QP/AV	Spectrum Reading Level dB μ V	Factor dB	Actual FS dB μ V/m	Limit @3m dB μ V/m	Margin dB
5350.00	Average	33.31	5.19	38.50	54.00	-15.50
5350.00	Peak	43.84	5.19	49.03	74.00	-24.97

Unless otherwise stated the results shown in this test report refer only to the sample(s) tested and such sample(s) are retained for 90 days only.

除非另有說明，此報告結果僅對測試之樣品負責，同時此樣品僅保留90天。本報告未經本公司書面許可，不可部份複製。

This document is issued by the Company subject to its General Conditions of Service printed overleaf, available on request or accessible at www.sgs.com/terms_and_conditions.htm and for electronic format documents, subject to Terms and Conditions for Electronic Documents at www.sgs.com/terms_e-document.htm. Attention is drawn to the limitation of liability, indemnification and jurisdiction issues defined therein. Any holder of this document is advised that information contained hereon reflects the Company's findings at the time of its intervention only and within the limits of Client's instructions, if any. The Company's sole responsibility is to its Client and this document does not exonerate parties to a transaction from exercising all their rights and obligations under the transaction documents. This document cannot be reproduced except in full, without prior written approval of the Company. Any unauthorized alteration, forgery or falsification of the content or appearance of this document is unlawful and offenders may be prosecuted to the fullest extent of the law.

Operation Band :802.11aB3
Fundamental Frequency :5500 MHz
Operation Mode :Bandedge CH LOW
EUT Pol. :E1 Plane

Test Date :2019-03-26
Temp./Humi. :23 deg_C / 62 RH
Engineer :Wei
Measurement Antenna Pol. :VERTICAL

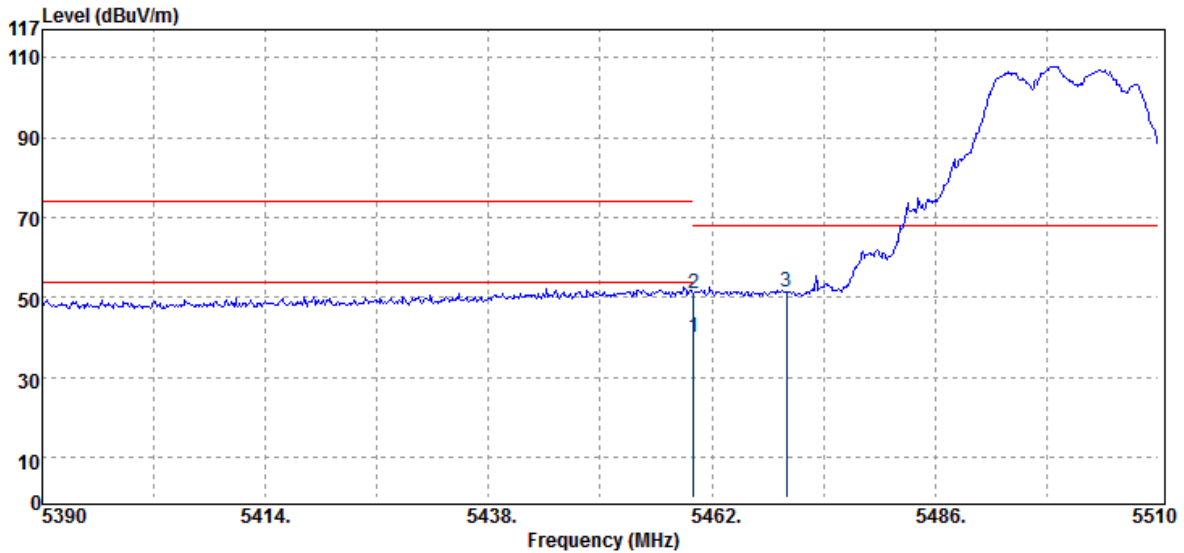

Freq. MHz	Detector Mode PK/QP/AV	Spectrum Reading Level dB μ V	Factor dB	Actual FS dB μ V/m	Limit @3m dB μ V/m	Margin dB
5460.00	Average	34.69	5.54	40.23	54.00	-13.77
5460.00	Peak	45.58	5.54	51.12	74.00	-22.88
5470.00	Peak	45.81	5.52	51.33	68.20	-16.87

Unless otherwise stated the results shown in this test report refer only to the sample(s) tested and such sample(s) are retained for 90 days only.

除非另有說明，此報告結果僅對測試之樣品負責，同時此樣品僅保留90天。本報告未經本公司書面許可，不可部份複製。

This document is issued by the Company subject to its General Conditions of Service printed overleaf, available on request or accessible at www.sgs.com/terms_and_conditions.htm and for electronic format documents, subject to Terms and Conditions for Electronic Documents at www.sgs.com/terms_e-document.htm. Attention is drawn to the limitation of liability, indemnification and jurisdiction issues defined therein. Any holder of this document is advised that information contained hereon reflects the Company's findings at the time of its intervention only and within the limits of Client's instructions, if any. The Company's sole responsibility is to its Client and this document does not exonerate parties to a transaction from exercising all their rights and obligations under the transaction documents. This document cannot be reproduced except in full, without prior written approval of the Company. Any unauthorized alteration, forgery or falsification of the content or appearance of this document is unlawful and offenders may be prosecuted to the fullest extent of the law.

Operation Band :802.11aB3
Fundamental Frequency :5500 MHz
Operation Mode :Bandedge CH LOW
EUT Pol. :E1 Plane

Test Date :2019-03-26
Temp./Humi. :23 deg_C / 62 RH
Engineer :Wei
Measurement Antenna Pol. :HORIZONTAL

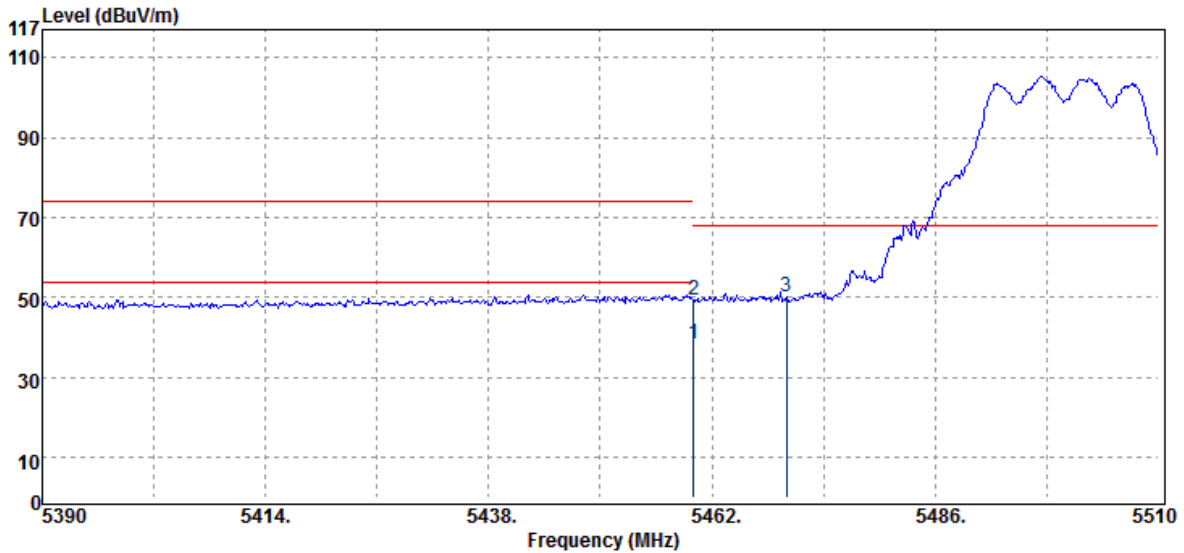

Freq. MHz	Detector Mode PK/QP/AV	Spectrum Reading Level dBuV	Factor dB	Actual FS dBuV/m	Limit @3m dBuV/m	Margin dB
5460.00	Average	33.07	5.54	38.61	54.00	-15.39
5460.00	Peak	43.91	5.54	49.45	74.00	-24.55
5470.00	Peak	44.54	5.52	50.06	68.20	-18.14

Unless otherwise stated the results shown in this test report refer only to the sample(s) tested and such sample(s) are retained for 90 days only.

除非另有說明，此報告結果僅對測試之樣品負責，同時此樣品僅保留90天。本報告未經本公司書面許可，不可部份複製。

This document is issued by the Company subject to its General Conditions of Service printed overleaf, available on request or accessible at www.sgs.com/terms_and_conditions.htm and for electronic format documents, subject to Terms and Conditions for Electronic Documents at www.sgs.com/terms_e-document.htm. Attention is drawn to the limitation of liability, indemnification and jurisdiction issues defined therein. Any holder of this document is advised that information contained hereon reflects the Company's findings at the time of its intervention only and within the limits of Client's instructions, if any. The Company's sole responsibility is to its Client and this document does not exonerate parties to a transaction from exercising all their rights and obligations under the transaction documents. This document cannot be reproduced except in full, without prior written approval of the Company. Any unauthorized alteration, forgery or falsification of the content or appearance of this document is unlawful and offenders may be prosecuted to the fullest extent of the law.

Operation Band :802.11aB3
Fundamental Frequency :5700 MHz
Operation Mode :Bandedge CH HIGH
EUT Pol. :E1 Plane

Test Date :2019-03-26
Temp./Humi. :23 deg_C / 62 RH
Engineer :Wei
Measurement Antenna Pol. :VERTICAL

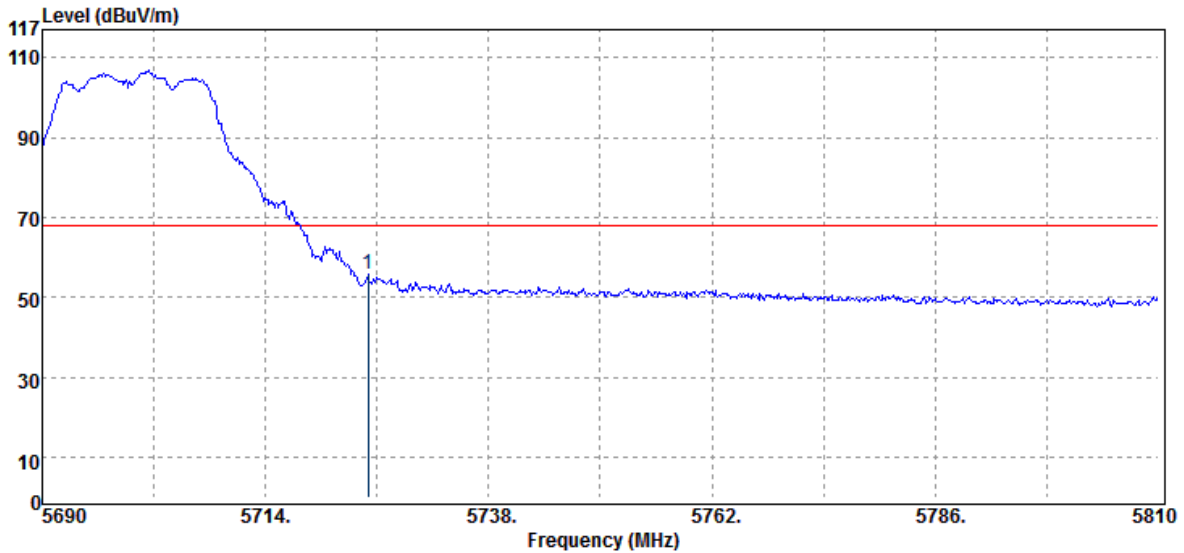

Freq. MHz	Detector Mode PK/QP/AV	Spectrum Reading Level dB μ V	Factor dB	Actual FS dB μ V/m	Limit @3m dB μ V/m	Margin dB
5725.00	Peak	49.37	6.54	55.91	68.20	-12.29

Unless otherwise stated the results shown in this test report refer only to the sample(s) tested and such sample(s) are retained for 90 days only.

除非另有說明，此報告結果僅對測試之樣品負責，同時此樣品僅保留90天。本報告未經本公司書面許可，不可部份複製。

This document is issued by the Company subject to its General Conditions of Service printed overleaf, available on request or accessible at www.sgs.com/terms_and_conditions.htm and for electronic format documents, subject to Terms and Conditions for Electronic Documents at www.sgs.com/terms_e-document.htm. Attention is drawn to the limitation of liability, indemnification and jurisdiction issues defined therein. Any holder of this document is advised that information contained hereon reflects the Company's findings at the time of its intervention only and within the limits of Client's instructions, if any. The Company's sole responsibility is to its Client and this document does not exonerate parties to a transaction from exercising all their rights and obligations under the transaction documents. This document cannot be reproduced except in full, without prior written approval of the Company. Any unauthorized alteration, forgery or falsification of the content or appearance of this document is unlawful and offenders may be prosecuted to the fullest extent of the law.

Operation Band	:802.11aB3	Test Date	:2019-03-26
Fundamental Frequency	:5700 MHz	Temp./Humi.	:23 deg_C / 62 RH
Operation Mode	:Bandedge CH HIGH	Engineer	:Wei
EUT Pol.	:E1 Plane	Measurement Antenna Pol.	:HORIZONTAL

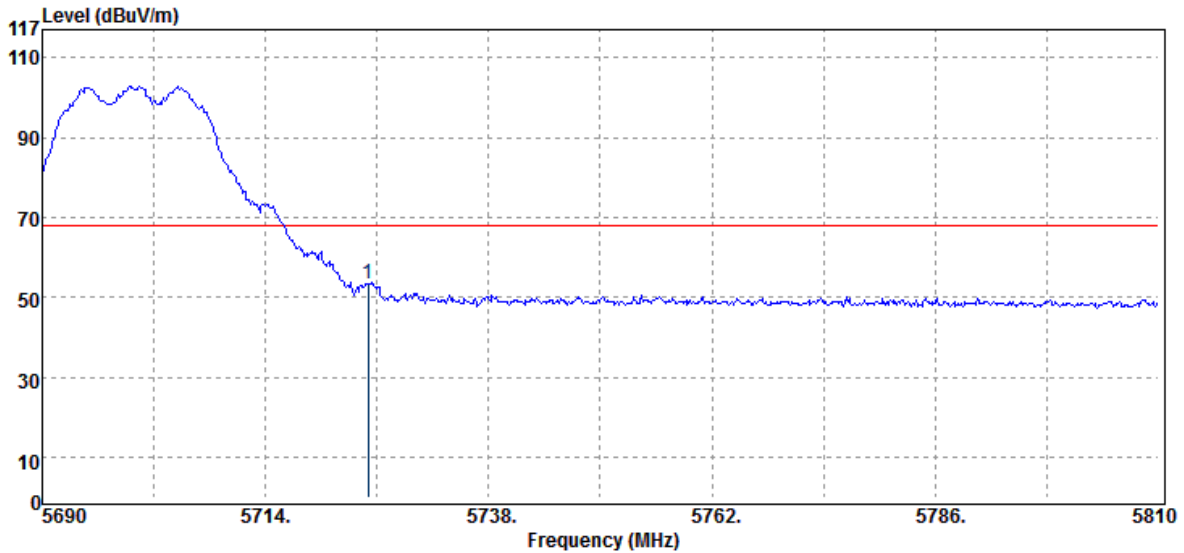

Freq. MHz	Detector Mode PK/QP/AV	Spectrum Reading Level dB μ V	Factor dB	Actual FS dB μ V/m	Limit @3m dB μ V/m	Margin dB
5725.00	Peak	47.06	6.54	53.60	68.20	-14.60

Unless otherwise stated the results shown in this test report refer only to the sample(s) tested and such sample(s) are retained for 90 days only.

除非另有說明，此報告結果僅對測試之樣品負責，同時此樣品僅保留90天。本報告未經本公司書面許可，不可部份複製。

This document is issued by the Company subject to its General Conditions of Service printed overleaf, available on request or accessible at www.sgs.com/terms_and_conditions.htm and for electronic format documents, subject to Terms and Conditions for Electronic Documents at www.sgs.com/terms_e-document.htm. Attention is drawn to the limitation of liability, indemnification and jurisdiction issues defined therein. Any holder of this document is advised that information contained hereon reflects the Company's findings at the time of its intervention only and within the limits of Client's instructions, if any. The Company's sole responsibility is to its Client and this document does not exonerate parties to a transaction from exercising all their rights and obligations under the transaction documents. This document cannot be reproduced except in full, without prior written approval of the Company. Any unauthorized alteration, forgery or falsification of the content or appearance of this document is unlawful and offenders may be prosecuted to the fullest extent of the law.

Operation Band :802.11aB4
Fundamental Frequency :5745 MHz
Operation Mode :Bandedge CH LOW
EUT Pol. :E1 Plane

Test Date :2019-03-25
Temp./Humi. :23 deg_C / 62 RH
Engineer :Wei
Measurement Antenna Pol. :VERTICAL

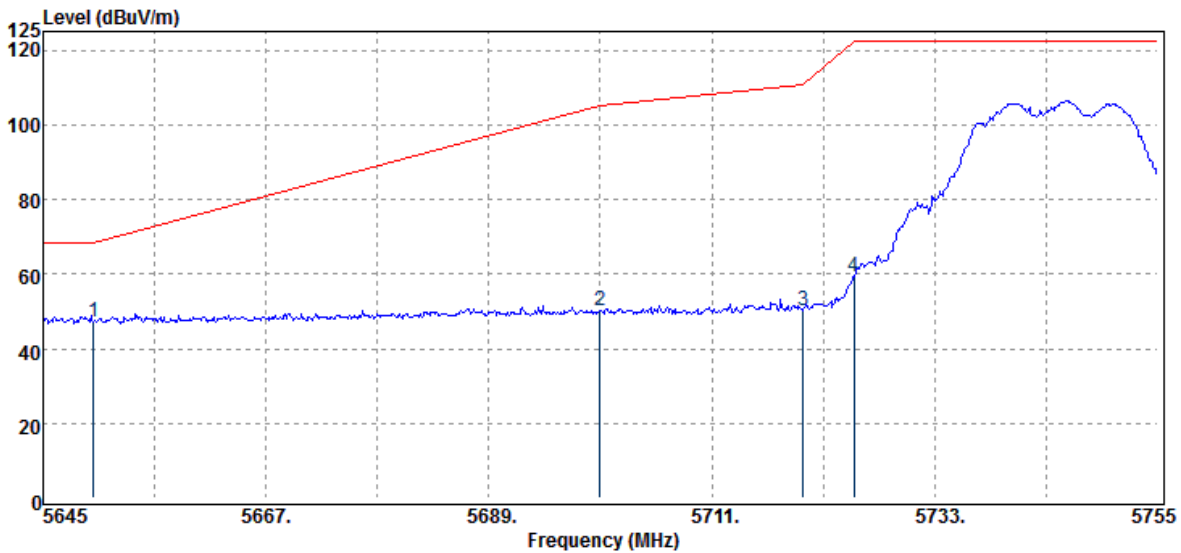

Freq. MHz	Detector Mode PK/QP/AV	Spectrum Reading Level dB μ V	Factor dB	Actual FS dB μ V/m	Limit @3m dB μ V/m	Margin dB
5650.00	Peak	41.18	5.90	47.08	68.23	-21.15
5700.00	Peak	43.76	6.42	50.18	105.23	-55.05
5720.00	Peak	43.55	6.55	50.10	110.83	-60.73
5725.00	Peak	52.86	6.54	59.40	122.23	-62.83

Unless otherwise stated the results shown in this test report refer only to the sample(s) tested and such sample(s) are retained for 90 days only.

除非另有說明，此報告結果僅對測試之樣品負責，同時此樣品僅保留90天。本報告未經本公司書面許可，不可部份複製。

This document is issued by the Company subject to its General Conditions of Service printed overleaf, available on request or accessible at www.sgs.com/terms_and_conditions.htm and for electronic format documents, subject to Terms and Conditions for Electronic Documents at www.sgs.com/terms_e-document.htm. Attention is drawn to the limitation of liability, indemnification and jurisdiction issues defined therein. Any holder of this document is advised that information contained hereon reflects the Company's findings at the time of its intervention only and within the limits of Client's instructions, if any. The Company's sole responsibility is to its Client and this document does not exonerate parties to a transaction from exercising all their rights and obligations under the transaction documents. This document cannot be reproduced except in full, without prior written approval of the Company. Any unauthorized alteration, forgery or falsification of the content or appearance of this document is unlawful and offenders may be prosecuted to the fullest extent of the law.

Operation Band :802.11aB4
Fundamental Frequency :5745 MHz
Operation Mode :Bandedge CH LOW
EUT Pol. :E1 Plane

Test Date :2019-03-25
Temp./Humi. :23 deg_C / 62 RH
Engineer :Wei
Measurement Antenna Pol. :HORIZONTAL

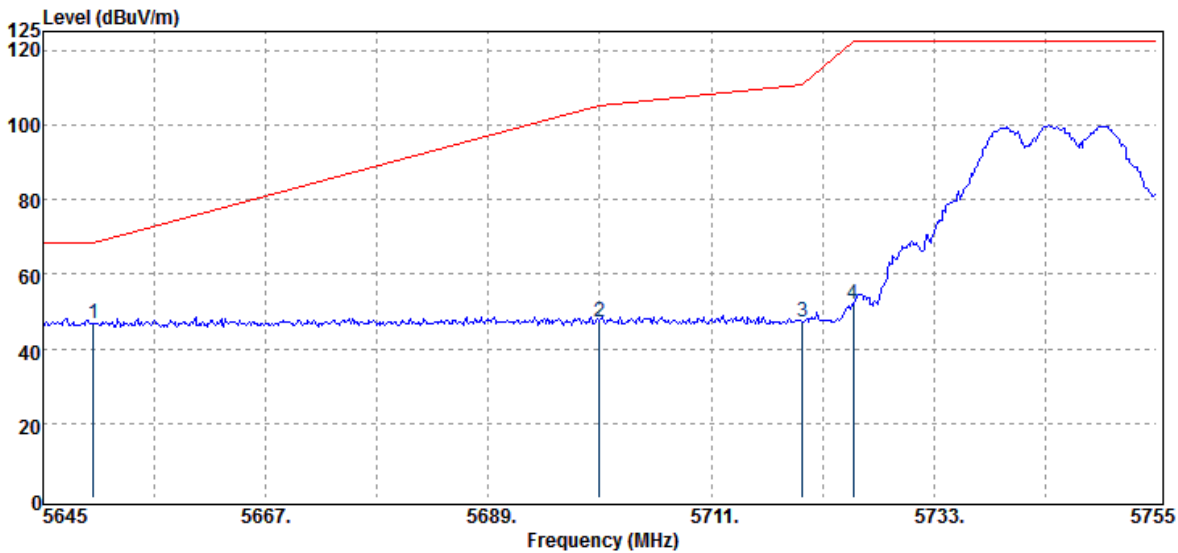

Freq. MHz	Detector Mode PK/QP/AV	Spectrum Reading Level dB μ V	Factor dB	Actual FS dB μ V/m	Limit @3m dB μ V/m	Margin dB
5650.00	Peak	40.74	5.90	46.64	68.23	-21.59
5700.00	Peak	40.73	6.42	47.15	105.23	-58.08
5720.00	Peak	40.50	6.55	47.05	110.83	-63.78
5725.00	Peak	45.30	6.54	51.84	122.23	-70.39

Unless otherwise stated the results shown in this test report refer only to the sample(s) tested and such sample(s) are retained for 90 days only.

除非另有說明，此報告結果僅對測試之樣品負責，同時此樣品僅保留90天。本報告未經本公司書面許可，不可部份複製。

This document is issued by the Company subject to its General Conditions of Service printed overleaf, available on request or accessible at www.sgs.com/terms_and_conditions.htm and for electronic format documents, subject to Terms and Conditions for Electronic Documents at www.sgs.com/terms_e-document.htm. Attention is drawn to the limitation of liability, indemnification and jurisdiction issues defined therein. Any holder of this document is advised that information contained hereon reflects the Company's findings at the time of its intervention only and within the limits of Client's instructions, if any. The Company's sole responsibility is to its Client and this document does not exonerate parties to a transaction from exercising all their rights and obligations under the transaction documents. This document cannot be reproduced except in full, without prior written approval of the Company. Any unauthorized alteration, forgery or falsification of the content or appearance of this document is unlawful and offenders may be prosecuted to the fullest extent of the law.

Operation Band :802.11aB4
Fundamental Frequency :5825 MHz
Operation Mode :Bandedge CH HIGH
EUT Pol. :E1 Plane

Test Date :2019-03-25
Temp./Humi. :23 deg_C / 62 RH
Engineer :Wei
Measurement Antenna Pol. :VERTICAL

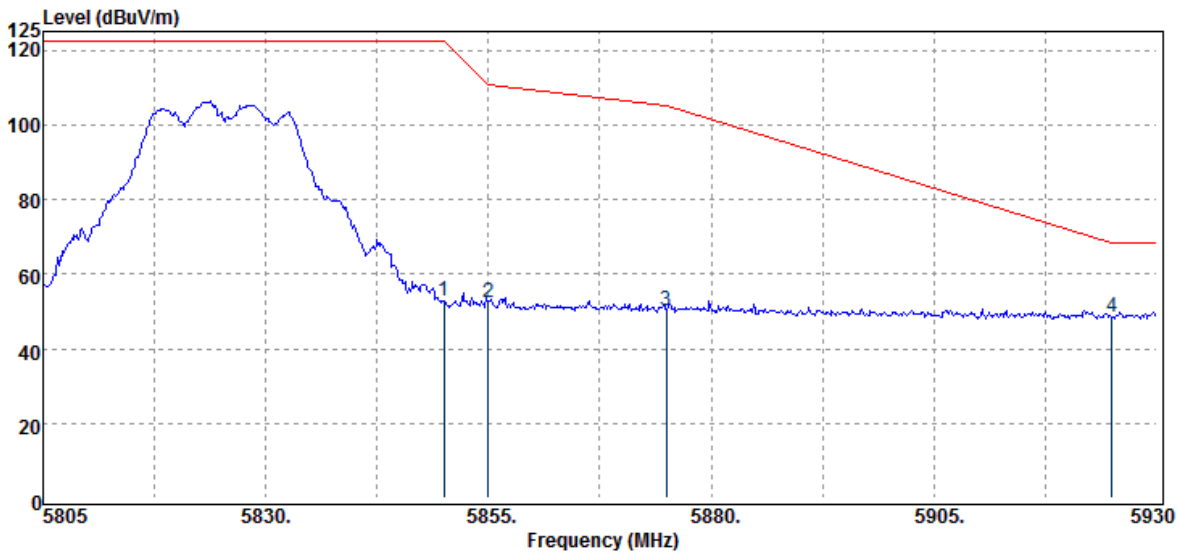

Freq. MHz	Detector Mode PK/QP/AV	Spectrum Reading Level dB μ V	Factor dB	Actual FS dB μ V/m	Limit @3m dB μ V/m	Margin dB
5850.00	Peak	46.28	6.42	52.70	122.23	-69.53
5855.00	Peak	45.77	6.43	52.20	110.83	-58.63
5875.00	Peak	43.87	6.50	50.37	105.23	-54.86
5925.00	Peak	42.00	6.44	48.44	68.23	-19.79

Unless otherwise stated the results shown in this test report refer only to the sample(s) tested and such sample(s) are retained for 90 days only.

除非另有說明，此報告結果僅對測試之樣品負責，同時此樣品僅保留90天。本報告未經本公司書面許可，不可部份複製。

This document is issued by the Company subject to its General Conditions of Service printed overleaf, available on request or accessible at www.sgs.com/terms_and_conditions.htm and for electronic format documents, subject to Terms and Conditions for Electronic Documents at www.sgs.com/terms_e-document.htm. Attention is drawn to the limitation of liability, indemnification and jurisdiction issues defined therein. Any holder of this document is advised that information contained hereon reflects the Company's findings at the time of its intervention only and within the limits of Client's instructions, if any. The Company's sole responsibility is to its Client and this document does not exonerate parties to a transaction from exercising all their rights and obligations under the transaction documents. This document cannot be reproduced except in full, without prior written approval of the Company. Any unauthorized alteration, forgery or falsification of the content or appearance of this document is unlawful and offenders may be prosecuted to the fullest extent of the law.

Operation Band :802.11aB4
Fundamental Frequency :5825 MHz
Operation Mode :Bandedge CH HIGH
EUT Pol. :E1 Plane

Test Date :2019-03-25
Temp./Humi. :23 deg_C / 62 RH
Engineer :Wei
Measurement Antenna Pol. :HORIZONTAL

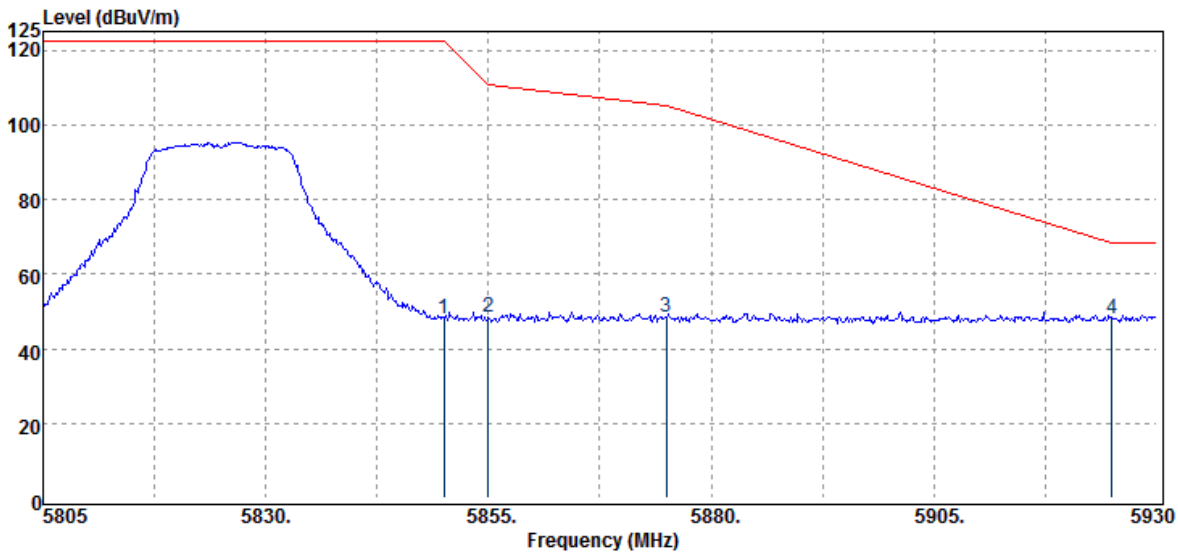

Freq. MHz	Detector Mode PK/QP/AV	Spectrum Reading Level dB μ V	Factor dB	Actual FS dB μ V/m	Limit @3m dB μ V/m	Margin dB
5850.00	Peak	41.65	6.42	48.07	122.23	-74.16
5855.00	Peak	42.17	6.43	48.60	110.83	-62.23
5875.00	Peak	41.83	6.50	48.33	105.23	-56.90
5925.00	Peak	41.57	6.44	48.01	68.23	-20.22

Unless otherwise stated the results shown in this test report refer only to the sample(s) tested and such sample(s) are retained for 90 days only.

除非另有說明，此報告結果僅對測試之樣品負責，同時此樣品僅保留90天。本報告未經本公司書面許可，不可部份複製。

This document is issued by the Company subject to its General Conditions of Service printed overleaf, available on request or accessible at www.sgs.com/terms_and_conditions.htm and for electronic format documents, subject to Terms and Conditions for Electronic Documents at www.sgs.com/terms_e-document.htm. Attention is drawn to the limitation of liability, indemnification and jurisdiction issues defined therein. Any holder of this document is advised that information contained hereon reflects the Company's findings at the time of its intervention only and within the limits of Client's instructions, if any. The Company's sole responsibility is to its Client and this document does not exonerate parties to a transaction from exercising all their rights and obligations under the transaction documents. This document cannot be reproduced except in full, without prior written approval of the Company. Any unauthorized alteration, forgery or falsification of the content or appearance of this document is unlawful and offenders may be prosecuted to the fullest extent of the law.

802.11n20 HT mode

Operation Band	:802.11n20B1	Test Date	:2019-03-07
Fundamental Frequency	:5180 MHz	Temp./Humi.	:20 deg_C / 61 RH
Operation Mode	:Bandedge CH LOW	Engineer	:Wei
EUT Pol.	:E1 Plane	Measurement Antenna Pol.	:VERTICAL

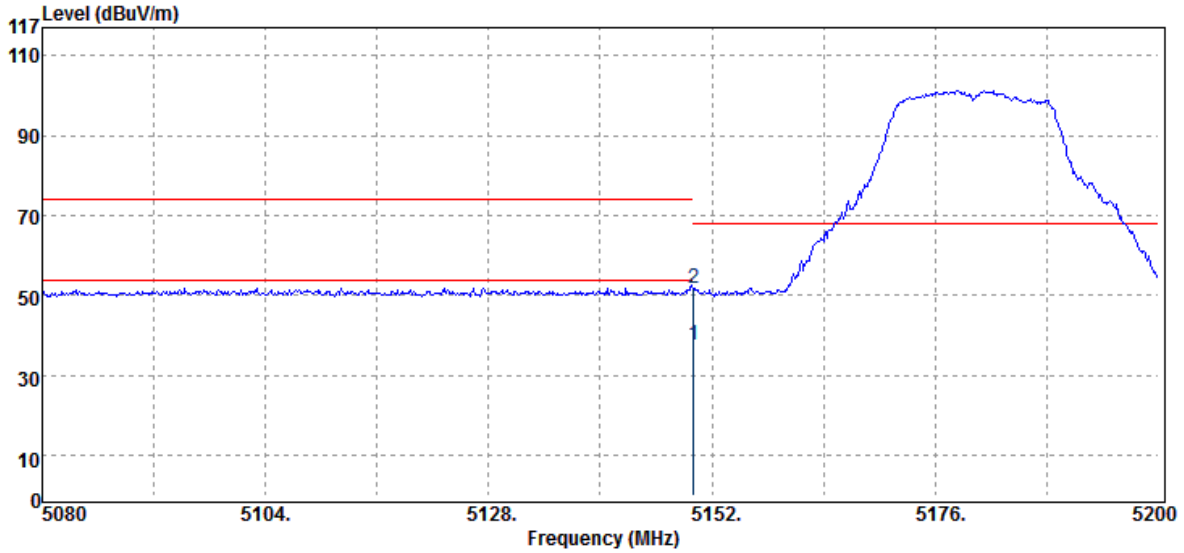

Freq. MHz	Detector Mode PK/QP/AV	Spectrum Reading Level dBuV	Factor dB	Actual FS dBuV/m	Limit @3m dBuV/m	Margin dB
5150.00	Average	33.22	4.55	37.77	54.00	-16.23
5150.00	Peak	47.33	4.55	51.88	74.00	-22.12

Unless otherwise stated the results shown in this test report refer only to the sample(s) tested and such sample(s) are retained for 90 days only.

除非另有說明，此報告結果僅對測試之樣品負責，同時此樣品僅保留90天。本報告未經本公司書面許可，不可部份複製。

This document is issued by the Company subject to its General Conditions of Service printed overleaf, available on request or accessible at www.sgs.com/terms_and_conditions.htm and for electronic format documents, subject to Terms and Conditions for Electronic Documents at www.sgs.com/terms_e-document.htm. Attention is drawn to the limitation of liability, indemnification and jurisdiction issues defined therein. Any holder of this document is advised that information contained hereon reflects the Company's findings at the time of its intervention only and within the limits of Client's instructions, if any. The Company's sole responsibility is to its Client and this document does not exonerate parties to a transaction from exercising all their rights and obligations under the transaction documents. This document cannot be reproduced except in full, without prior written approval of the Company. Any unauthorized alteration, forgery or falsification of the content or appearance of this document is unlawful and offenders may be prosecuted to the fullest extent of the law.

Operation Band	:802.11n20B1	Test Date	:2019-03-07
Fundamental Frequency	:5180 MHz	Temp./Humi.	:20 deg_C / 61 RH
Operation Mode	:Bandedge CH LOW	Engineer	:Wei
EUT Pol.	:E1 Plane	Measurement Antenna Pol.	:HORIZONTAL

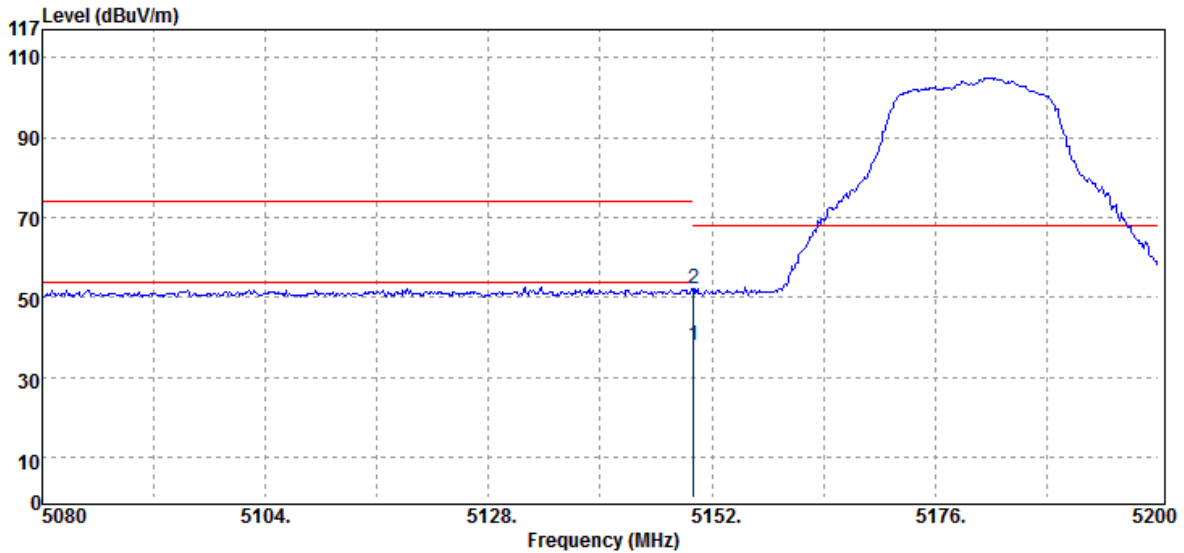

Freq. MHz	Detector Mode PK/QP/AV	Spectrum Reading Level dB μ V	Factor dB	Actual FS dB μ V/m	Limit @3m dB μ V/m	Margin dB
5150.00	Average	33.57	4.55	38.12	54.00	-15.88
5150.00	Peak	47.85	4.55	52.40	74.00	-21.60

Unless otherwise stated the results shown in this test report refer only to the sample(s) tested and such sample(s) are retained for 90 days only.

除非另有說明，此報告結果僅對測試之樣品負責，同時此樣品僅保留90天。本報告未經本公司書面許可，不可部份複製。

This document is issued by the Company subject to its General Conditions of Service printed overleaf, available on request or accessible at www.sgs.com/terms_and_conditions.htm and for electronic format documents, subject to Terms and Conditions for Electronic Documents at www.sgs.com/terms_e-document.htm. Attention is drawn to the limitation of liability, indemnification and jurisdiction issues defined therein. Any holder of this document is advised that information contained hereon reflects the Company's findings at the time of its intervention only and within the limits of Client's instructions, if any. The Company's sole responsibility is to its Client and this document does not exonerate parties to a transaction from exercising all their rights and obligations under the transaction documents. This document cannot be reproduced except in full, without prior written approval of the Company. Any unauthorized alteration, forgery or falsification of the content or appearance of this document is unlawful and offenders may be prosecuted to the fullest extent of the law.

Operation Band	:802.11n20B2	Test Date	:2019-03-07
Fundamental Frequency	:5320 MHz	Temp./Humi.	:20 deg_C / 61 RH
Operation Mode	:Bandedge CH HIGH	Engineer	:Wei
EUT Pol.	:E1 Plane	Measurement Antenna Pol.	:VERTICAL

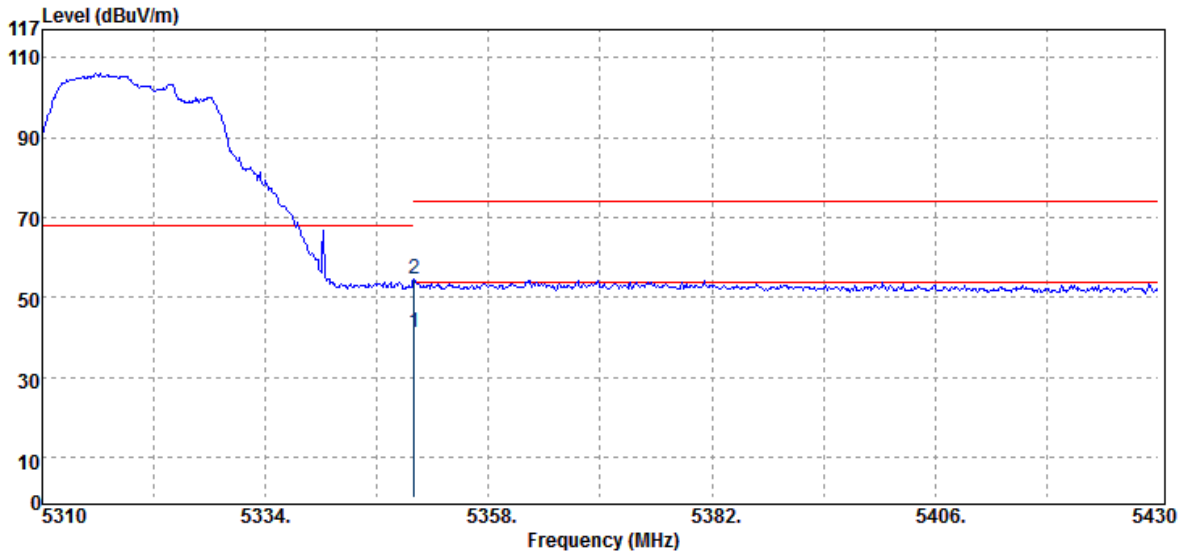

Freq. MHz	Detector Mode PK/QP/AV	Spectrum Reading Level dB μ V	Factor dB	Actual FS dB μ V/m	Limit @3m dB μ V/m	Margin dB
5350.00	Average	36.12	5.19	41.31	54.00	-12.69
5350.00	Peak	49.61	5.19	54.80	74.00	-19.20

Unless otherwise stated the results shown in this test report refer only to the sample(s) tested and such sample(s) are retained for 90 days only.

除非另有說明，此報告結果僅對測試之樣品負責，同時此樣品僅保留90天。本報告未經本公司書面許可，不可部份複製。

This document is issued by the Company subject to its General Conditions of Service printed overleaf, available on request or accessible at www.sgs.com/terms_and_conditions.htm and for electronic format documents, subject to Terms and Conditions for Electronic Documents at www.sgs.com/terms_e-document.htm. Attention is drawn to the limitation of liability, indemnification and jurisdiction issues defined therein. Any holder of this document is advised that information contained hereon reflects the Company's findings at the time of its intervention only and within the limits of Client's instructions, if any. The Company's sole responsibility is to its Client and this document does not exonerate parties to a transaction from exercising all their rights and obligations under the transaction documents. This document cannot be reproduced except in full, without prior written approval of the Company. Any unauthorized alteration, forgery or falsification of the content or appearance of this document is unlawful and offenders may be prosecuted to the fullest extent of the law.

Operation Band	:802.11n20B2	Test Date	:2019-03-07
Fundamental Frequency	:5320 MHz	Temp./Humi.	:20 deg_C / 61 RH
Operation Mode	:Bandedge CH HIGH	Engineer	:Wei
EUT Pol.	:E1 Plane	Measurement Antenna Pol.	:HORIZONTAL

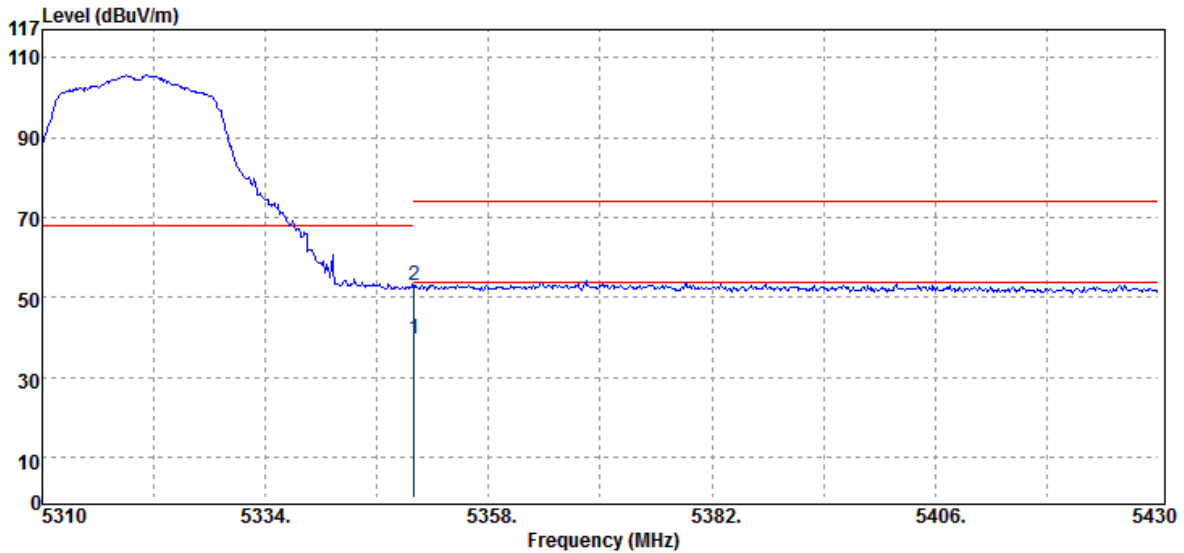

Freq. MHz	Detector Mode PK/QP/AV	Spectrum Reading Level dB μ V	Factor dB	Actual FS dB μ V/m	Limit @3m dB μ V/m	Margin dB
5350.00	Average	34.33	5.19	39.52	54.00	-14.48
5350.00	Peak	47.68	5.19	52.87	74.00	-21.13

Unless otherwise stated the results shown in this test report refer only to the sample(s) tested and such sample(s) are retained for 90 days only.

除非另有說明，此報告結果僅對測試之樣品負責，同時此樣品僅保留90天。本報告未經本公司書面許可，不可部份複製。

This document is issued by the Company subject to its General Conditions of Service printed overleaf, available on request or accessible at www.sgs.com/terms_and_conditions.htm and for electronic format documents, subject to Terms and Conditions for Electronic Documents at www.sgs.com/terms_e-document.htm. Attention is drawn to the limitation of liability, indemnification and jurisdiction issues defined therein. Any holder of this document is advised that information contained hereon reflects the Company's findings at the time of its intervention only and within the limits of Client's instructions, if any. The Company's sole responsibility is to its Client and this document does not exonerate parties to a transaction from exercising all their rights and obligations under the transaction documents. This document cannot be reproduced except in full, without prior written approval of the Company. Any unauthorized alteration, forgery or falsification of the content or appearance of this document is unlawful and offenders may be prosecuted to the fullest extent of the law.

Operation Band :802.11n20B3
Fundamental Frequency :5500 MHz
Operation Mode :Bandedge CH LOW
EUT Pol. :E1 Plane

Test Date :2019-03-07
Temp./Humi. :20 deg_C / 61 RH
Engineer :Wei
Measurement Antenna Pol. :VERTICAL

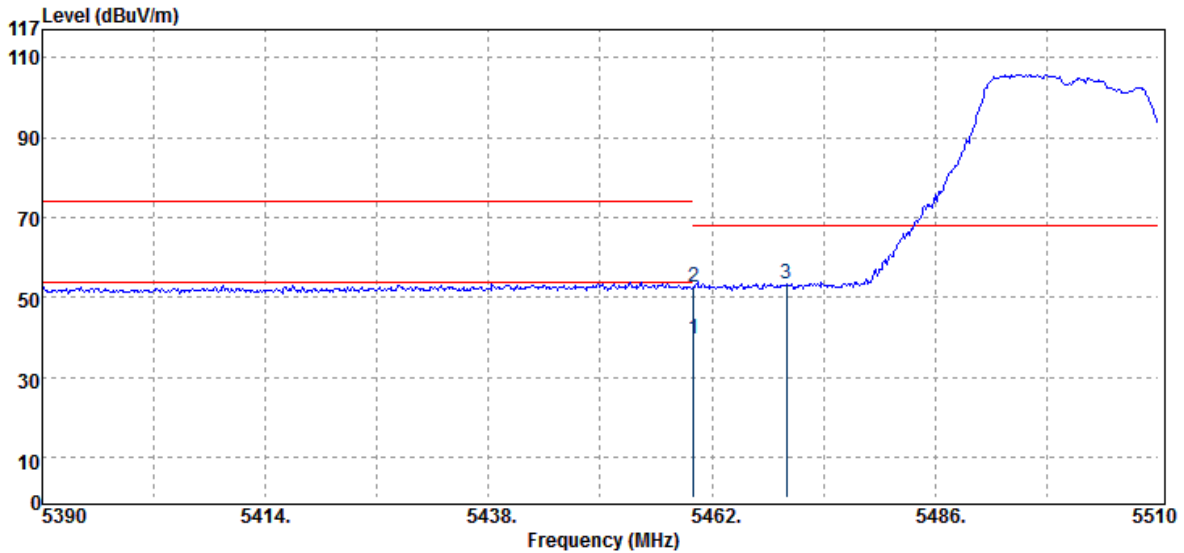

Freq. MHz	Detector Mode PK/QP/AV	Spectrum Reading Level dB μ V	Factor dB	Actual FS dB μ V/m	Limit @3m dB μ V/m	Margin dB
5460.00	Average	34.25	5.54	39.79	54.00	-14.21
5460.00	Peak	47.19	5.54	52.73	74.00	-21.27
5470.00	Peak	47.73	5.52	53.25	68.20	-14.95

Unless otherwise stated the results shown in this test report refer only to the sample(s) tested and such sample(s) are retained for 90 days only.

除非另有說明，此報告結果僅對測試之樣品負責，同時此樣品僅保留90天。本報告未經本公司書面許可，不可部份複製。

This document is issued by the Company subject to its General Conditions of Service printed overleaf, available on request or accessible at www.sgs.com/terms_and_conditions.htm and for electronic format documents, subject to Terms and Conditions for Electronic Documents at www.sgs.com/terms_e-document.htm. Attention is drawn to the limitation of liability, indemnification and jurisdiction issues defined therein. Any holder of this document is advised that information contained hereon reflects the Company's findings at the time of its intervention only and within the limits of Client's instructions, if any. The Company's sole responsibility is to its Client and this document does not exonerate parties to a transaction from exercising all their rights and obligations under the transaction documents. This document cannot be reproduced except in full, without prior written approval of the Company. Any unauthorized alteration, forgery or falsification of the content or appearance of this document is unlawful and offenders may be prosecuted to the fullest extent of the law.

Operation Band	:802.11n20B3	Test Date	:2019-03-07
Fundamental Frequency	:5500 MHz	Temp./Humi.	:20 deg_C / 61 RH
Operation Mode	:Bandedge CH LOW	Engineer	:Wei
EUT Pol.	:E1 Plane	Measurement Antenna Pol.	:HORIZONTAL

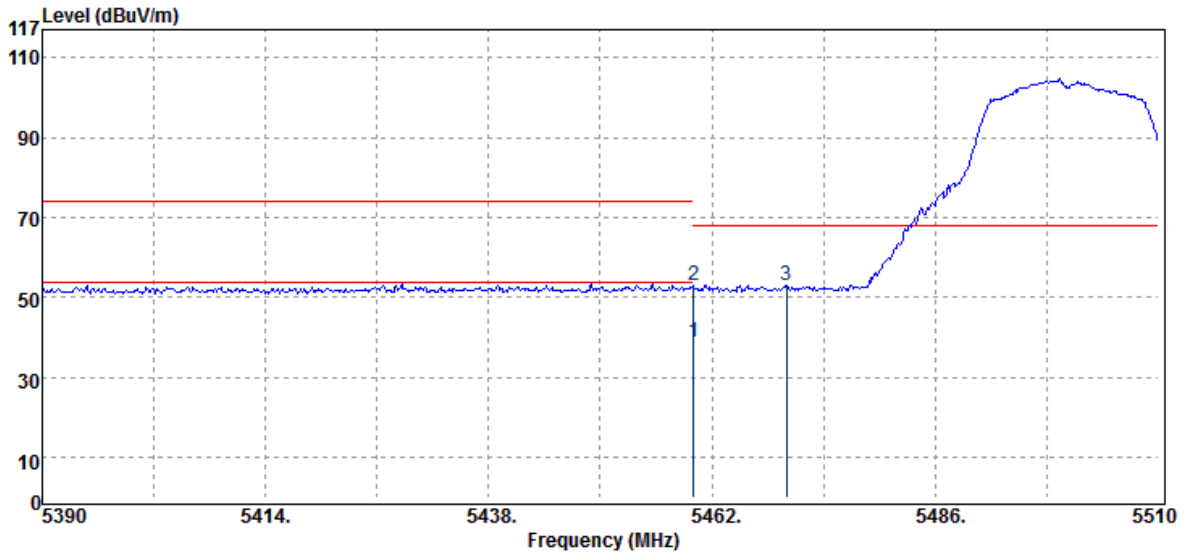

Freq. MHz	Detector Mode PK/QP/AV	Spectrum Reading Level dBuV	Factor dB	Actual FS dBuV/m	Limit @3m dBuV/m	Margin dB
5460.00	Average	33.51	5.54	39.05	54.00	-14.95
5460.00	Peak	47.49	5.54	53.03	74.00	-20.97
5470.00	Peak	47.46	5.52	52.98	68.20	-15.22

Unless otherwise stated the results shown in this test report refer only to the sample(s) tested and such sample(s) are retained for 90 days only.

除非另有說明，此報告結果僅對測試之樣品負責，同時此樣品僅保留90天。本報告未經本公司書面許可，不可部份複製。

This document is issued by the Company subject to its General Conditions of Service printed overleaf, available on request or accessible at www.sgs.com/terms_and_conditions.htm and for electronic format documents, subject to Terms and Conditions for Electronic Documents at www.sgs.com/terms_e-document.htm. Attention is drawn to the limitation of liability, indemnification and jurisdiction issues defined therein. Any holder of this document is advised that information contained hereon reflects the Company's findings at the time of its intervention only and within the limits of Client's instructions, if any. The Company's sole responsibility is to its Client and this document does not exonerate parties to a transaction from exercising all their rights and obligations under the transaction documents. This document cannot be reproduced except in full, without prior written approval of the Company. Any unauthorized alteration, forgery or falsification of the content or appearance of this document is unlawful and offenders may be prosecuted to the fullest extent of the law.

Operation Band	:802.11n20B3	Test Date	:2019-03-07
Fundamental Frequency	:5700 MHz	Temp./Humi.	:20 deg_C / 61 RH
Operation Mode	:Bandedge CH HIGH	Engineer	:Wei
EUT Pol.	:E1 Plane	Measurement Antenna Pol.	:VERTICAL

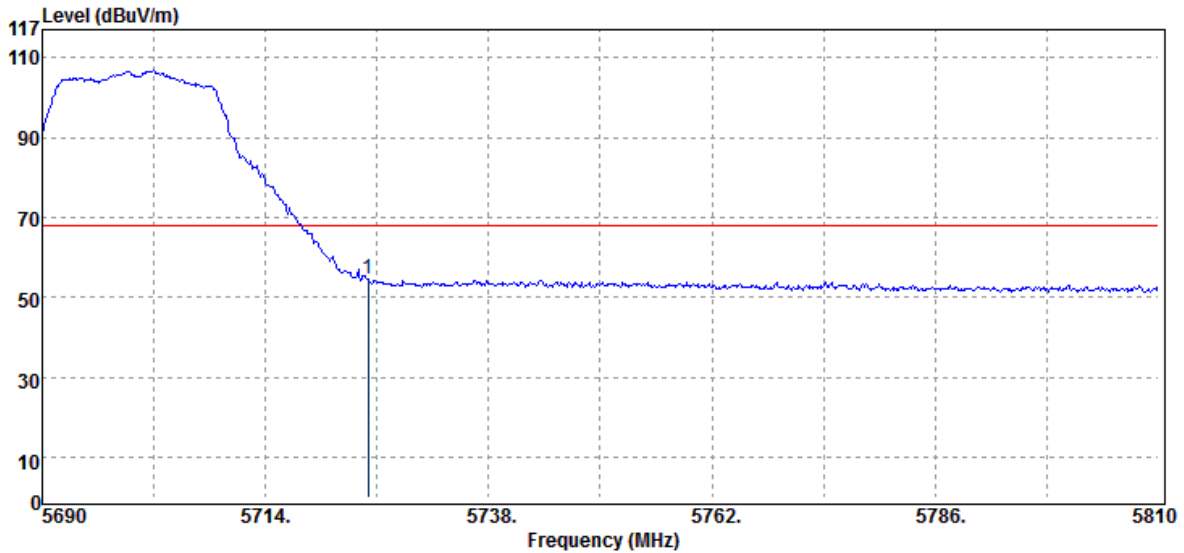

Freq. MHz	Detector Mode PK/QP/AV	Spectrum Reading Level dB μ V	Factor dB	Actual FS dB μ V/m	Limit @3m dB μ V/m	Margin dB
5725.00	Peak	48.20	6.55	54.75	68.20	-13.45

Unless otherwise stated the results shown in this test report refer only to the sample(s) tested and such sample(s) are retained for 90 days only.

除非另有說明，此報告結果僅對測試之樣品負責，同時此樣品僅保留90天。本報告未經本公司書面許可，不可部份複製。

This document is issued by the Company subject to its General Conditions of Service printed overleaf, available on request or accessible at www.sgs.com/terms_and_conditions.htm and for electronic format documents, subject to Terms and Conditions for Electronic Documents at www.sgs.com/terms_e-document.htm. Attention is drawn to the limitation of liability, indemnification and jurisdiction issues defined therein. Any holder of this document is advised that information contained hereon reflects the Company's findings at the time of its intervention only and within the limits of Client's instructions, if any. The Company's sole responsibility is to its Client and this document does not exonerate parties to a transaction from exercising all their rights and obligations under the transaction documents. This document cannot be reproduced except in full, without prior written approval of the Company. Any unauthorized alteration, forgery or falsification of the content or appearance of this document is unlawful and offenders may be prosecuted to the fullest extent of the law.

Operation Band	:802.11n20B3	Test Date	:2019-03-07
Fundamental Frequency	:5700 MHz	Temp./Humi.	:20 deg_C / 61 RH
Operation Mode	:Bandedge CH HIGH	Engineer	:Wei
EUT Pol.	:E1 Plane	Measurement Antenna Pol.	:HORIZONTAL

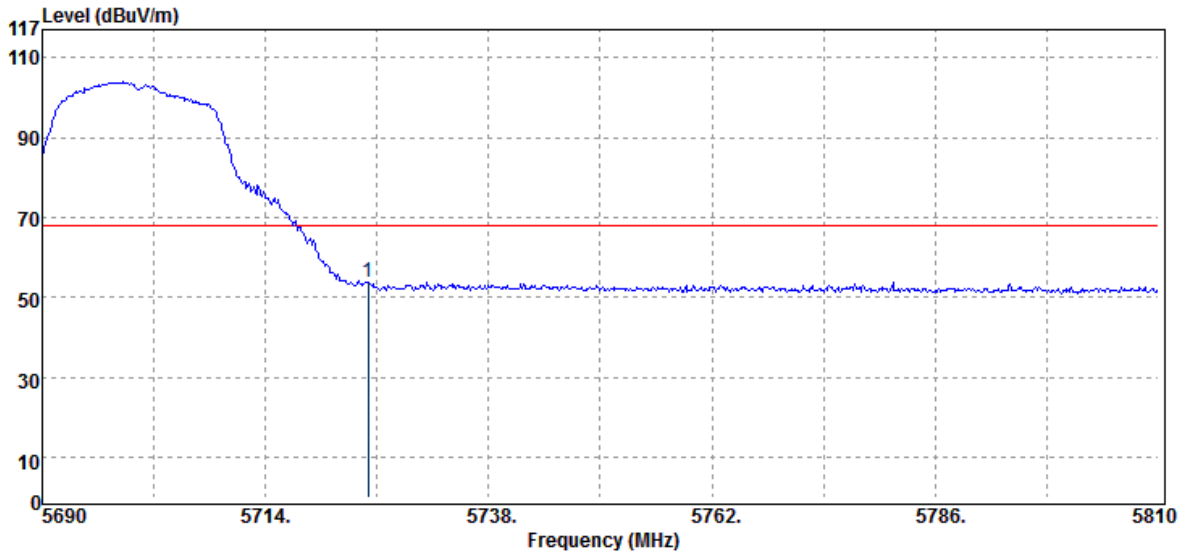

Freq. MHz	Detector Mode PK/QP/AV	Spectrum Reading Level dB μ V	Factor dB	Actual FS dB μ V/m	Limit @3m dB μ V/m	Margin dB
5725.00	Peak	47.23	6.55	53.78	68.20	-14.42

Unless otherwise stated the results shown in this test report refer only to the sample(s) tested and such sample(s) are retained for 90 days only.

除非另有說明，此報告結果僅對測試之樣品負責，同時此樣品僅保留90天。本報告未經本公司書面許可，不可部份複製。

This document is issued by the Company subject to its General Conditions of Service printed overleaf, available on request or accessible at www.sgs.com/terms_and_conditions.htm and for electronic format documents, subject to Terms and Conditions for Electronic Documents at www.sgs.com/terms_e-document.htm. Attention is drawn to the limitation of liability, indemnification and jurisdiction issues defined therein. Any holder of this document is advised that information contained hereon reflects the Company's findings at the time of its intervention only and within the limits of Client's instructions, if any. The Company's sole responsibility is to its Client and this document does not exonerate parties to a transaction from exercising all their rights and obligations under the transaction documents. This document cannot be reproduced except in full, without prior written approval of the Company. Any unauthorized alteration, forgery or falsification of the content or appearance of this document is unlawful and offenders may be prosecuted to the fullest extent of the law.

Operation Band	:802.11n20B4	Test Date	:2019-03-22
Fundamental Frequency	:5745 MHz	Temp./Humi.	:23 deg_C / 62 RH
Operation Mode	:Bandedge CH LOW	Engineer	:Wei
EUT Pol.	:E1 Plane	Measurement Antenna Pol.	:VERTICAL

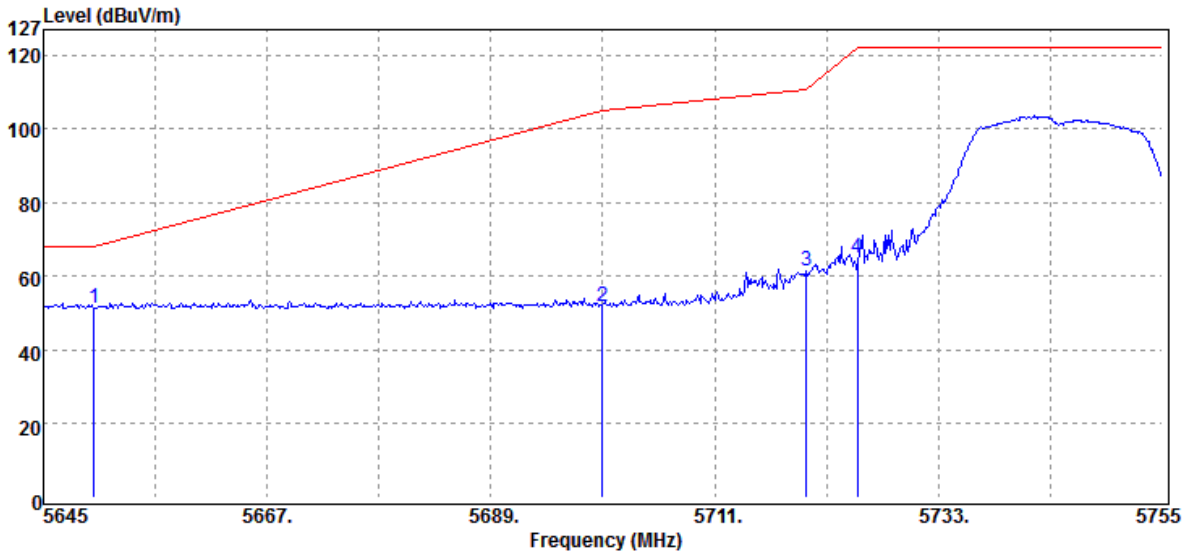

Freq. MHz	Detector Mode PK/QP/AV	Spectrum Reading Level dB μ V	Factor dB	Actual FS dB μ V/m	Limit @3m dB μ V/m	Margin dB
5650.00	Peak	45.63	5.91	51.54	68.23	-16.69
5700.00	Peak	45.61	6.43	52.04	105.23	-53.19
5720.00	Peak	55.14	6.55	61.69	110.83	-49.14
5725.00	Peak	58.42	6.55	64.97	122.23	-57.26

Unless otherwise stated the results shown in this test report refer only to the sample(s) tested and such sample(s) are retained for 90 days only.

除非另有說明，此報告結果僅對測試之樣品負責，同時此樣品僅保留90天。本報告未經本公司書面許可，不可部份複製。

This document is issued by the Company subject to its General Conditions of Service printed overleaf, available on request or accessible at www.sgs.com/terms_and_conditions.htm and for electronic format documents, subject to Terms and Conditions for Electronic Documents at www.sgs.com/terms_e-document.htm. Attention is drawn to the limitation of liability, indemnification and jurisdiction issues defined therein. Any holder of this document is advised that information contained hereon reflects the Company's findings at the time of its intervention only and within the limits of Client's instructions, if any. The Company's sole responsibility is to its Client and this document does not exonerate parties to a transaction from exercising all their rights and obligations under the transaction documents. This document cannot be reproduced except in full, without prior written approval of the Company. Any unauthorized alteration, forgery or falsification of the content or appearance of this document is unlawful and offenders may be prosecuted to the fullest extent of the law.

Operation Band	:802.11n20B4	Test Date	:2019-03-22
Fundamental Frequency	:5745 MHz	Temp./Humi.	:23 deg_C / 62 RH
Operation Mode	:Bandedge CH LOW	Engineer	:Wei
EUT Pol.	:E1 Plane	Measurement Antenna Pol.	:HORIZONTAL

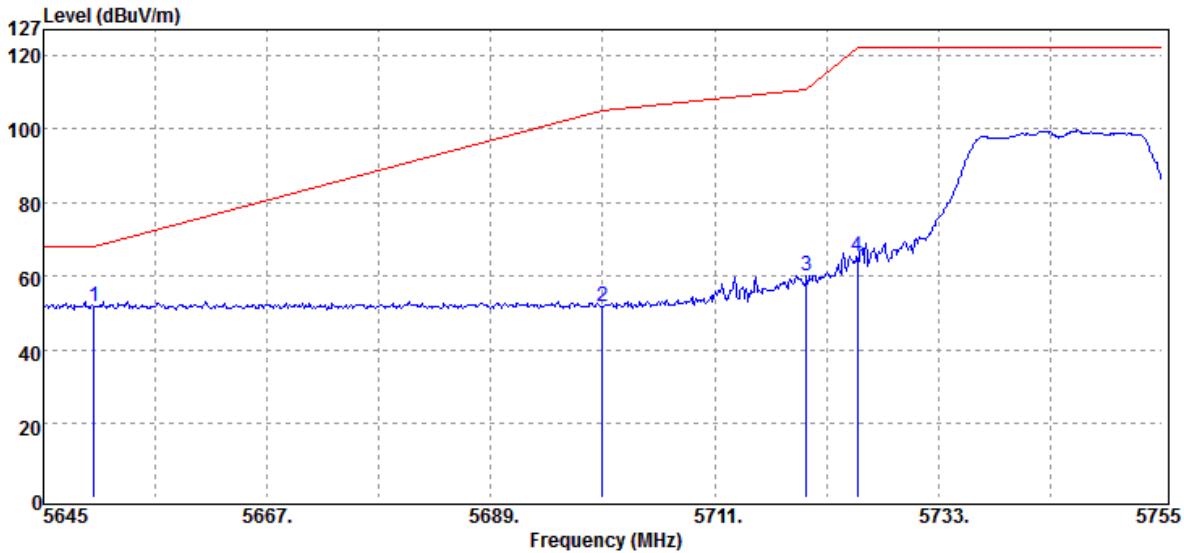

Freq. MHz	Detector Mode PK/QP/AV	Spectrum Reading Level dB μ V	Factor dB	Actual FS dB μ V/m	Limit @3m dB μ V/m	Margin dB
5650.00	Peak	45.83	5.91	51.74	68.23	-16.49
5700.00	Peak	45.47	6.43	51.90	105.23	-53.33
5720.00	Peak	53.49	6.55	60.04	110.83	-50.79
5725.00	Peak	58.97	6.55	65.52	122.23	-56.71

Unless otherwise stated the results shown in this test report refer only to the sample(s) tested and such sample(s) are retained for 90 days only.

除非另有說明，此報告結果僅對測試之樣品負責，同時此樣品僅保留90天。本報告未經本公司書面許可，不可部份複製。

This document is issued by the Company subject to its General Conditions of Service printed overleaf, available on request or accessible at www.sgs.com/terms_and_conditions.htm and for electronic format documents, subject to Terms and Conditions for Electronic Documents at www.sgs.com/terms_e-document.htm. Attention is drawn to the limitation of liability, indemnification and jurisdiction issues defined therein. Any holder of this document is advised that information contained hereon reflects the Company's findings at the time of its intervention only and within the limits of Client's instructions, if any. The Company's sole responsibility is to its Client and this document does not exonerate parties to a transaction from exercising all their rights and obligations under the transaction documents. This document cannot be reproduced except in full, without prior written approval of the Company. Any unauthorized alteration, forgery or falsification of the content or appearance of this document is unlawful and offenders may be prosecuted to the fullest extent of the law.

Operation Band	:802.11n20B4	Test Date	:2019-03-22
Fundamental Frequency	:5825 MHz	Temp./Humi.	:23 deg_C / 62 RH
Operation Mode	:Bandedge CH HIGH	Engineer	:Wei
EUT Pol.	:E1 Plane	Measurement Antenna Pol.	:VERTICAL

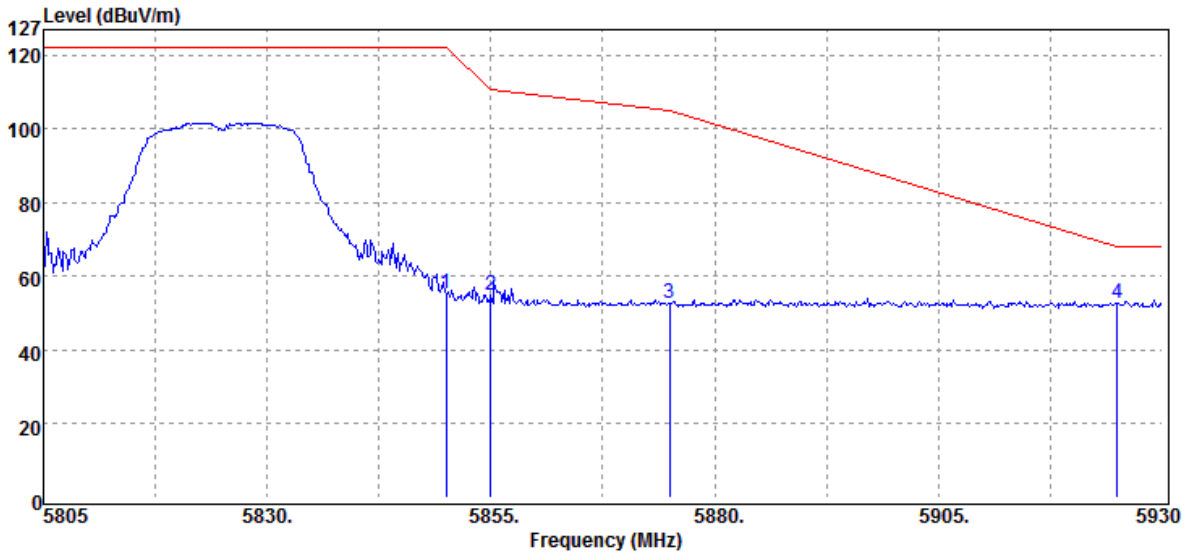

Freq. MHz	Detector Mode PK/QP/AV	Spectrum Reading Level dB μ V	Factor dB	Actual FS dB μ V/m	Limit @3m dB μ V/m	Margin dB
5850.00	Peak	48.91	6.41	55.32	122.23	-66.91
5855.00	Peak	48.29	6.43	54.72	110.83	-56.11
5875.00	Peak	46.41	6.49	52.90	105.23	-52.33
5925.00	Peak	46.47	6.44	52.91	68.23	-15.32

Unless otherwise stated the results shown in this test report refer only to the sample(s) tested and such sample(s) are retained for 90 days only.

除非另有說明，此報告結果僅對測試之樣品負責，同時此樣品僅保留90天。本報告未經本公司書面許可，不可部份複製。

This document is issued by the Company subject to its General Conditions of Service printed overleaf, available on request or accessible at www.sgs.com/terms_and_conditions.htm and for electronic format documents, subject to Terms and Conditions for Electronic Documents at www.sgs.com/terms_e-document.htm. Attention is drawn to the limitation of liability, indemnification and jurisdiction issues defined therein. Any holder of this document is advised that information contained hereon reflects the Company's findings at the time of its intervention only and within the limits of Client's instructions, if any. The Company's sole responsibility is to its Client and this document does not exonerate parties to a transaction from exercising all their rights and obligations under the transaction documents. This document cannot be reproduced except in full, without prior written approval of the Company. Any unauthorized alteration, forgery or falsification of the content or appearance of this document is unlawful and offenders may be prosecuted to the fullest extent of the law.

Operation Band	:802.11n20B4	Test Date	:2019-03-22
Fundamental Frequency	:5825 MHz	Temp./Humi.	:23 deg_C / 62 RH
Operation Mode	:Bandedge CH HIGH	Engineer	:Wei
EUT Pol.	:E1 Plane	Measurement Antenna Pol.	:HORIZONTAL

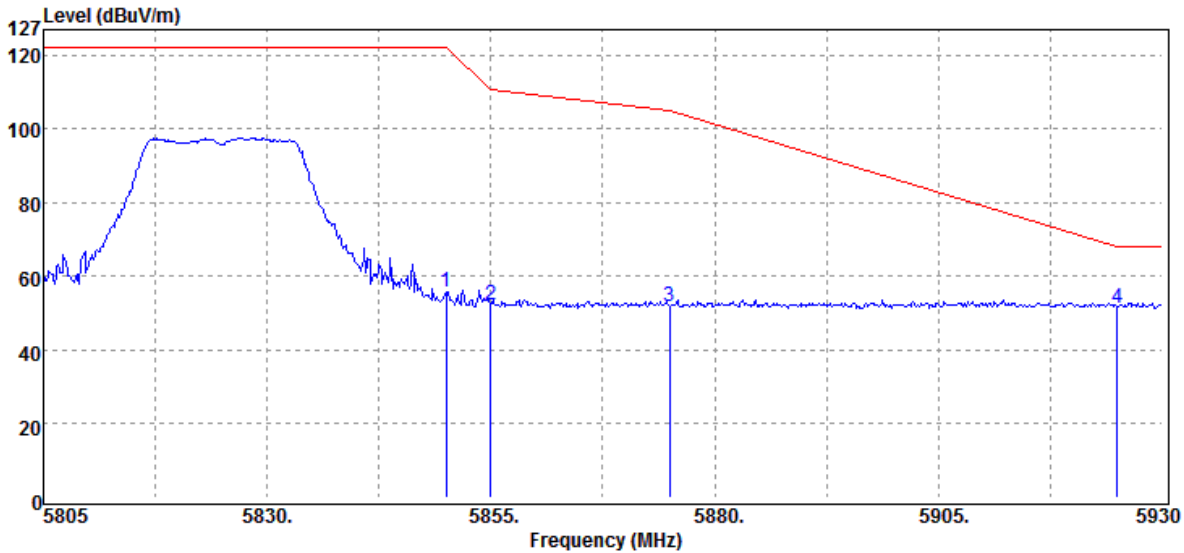

Freq. MHz	Detector Mode PK/QP/AV	Spectrum Reading Level dB μ V	Factor dB	Actual FS dB μ V/m	Limit @3m dB μ V/m	Margin dB
5850.00	Peak	49.41	6.41	55.82	122.23	-66.41
5855.00	Peak	45.66	6.43	52.09	110.83	-58.74
5875.00	Peak	45.57	6.49	52.06	105.23	-53.17
5925.00	Peak	45.13	6.44	51.57	68.23	-16.66

Unless otherwise stated the results shown in this test report refer only to the sample(s) tested and such sample(s) are retained for 90 days only.

除非另有說明，此報告結果僅對測試之樣品負責，同時此樣品僅保留90天。本報告未經本公司書面許可，不可部份複製。

This document is issued by the Company subject to its General Conditions of Service printed overleaf, available on request or accessible at www.sgs.com/terms_and_conditions.htm and for electronic format documents, subject to Terms and Conditions for Electronic Documents at www.sgs.com/terms_e-document.htm. Attention is drawn to the limitation of liability, indemnification and jurisdiction issues defined therein. Any holder of this document is advised that information contained hereon reflects the Company's findings at the time of its intervention only and within the limits of Client's instructions, if any. The Company's sole responsibility is to its Client and this document does not exonerate parties to a transaction from exercising all their rights and obligations under the transaction documents. This document cannot be reproduced except in full, without prior written approval of the Company. Any unauthorized alteration, forgery or falsification of the content or appearance of this document is unlawful and offenders may be prosecuted to the fullest extent of the law.

802.11n40 HT mode

Operation Band	:802.11n40B1	Test Date	:2019-03-07
Fundamental Frequency	:5190 MHz	Temp./Humi.	:20 deg_C / 61 RH
Operation Mode	:Bandedge CH LOW	Engineer	:Wei
EUT Pol.	:E1 Plane	Measurement Antenna Pol.	:VERTICAL

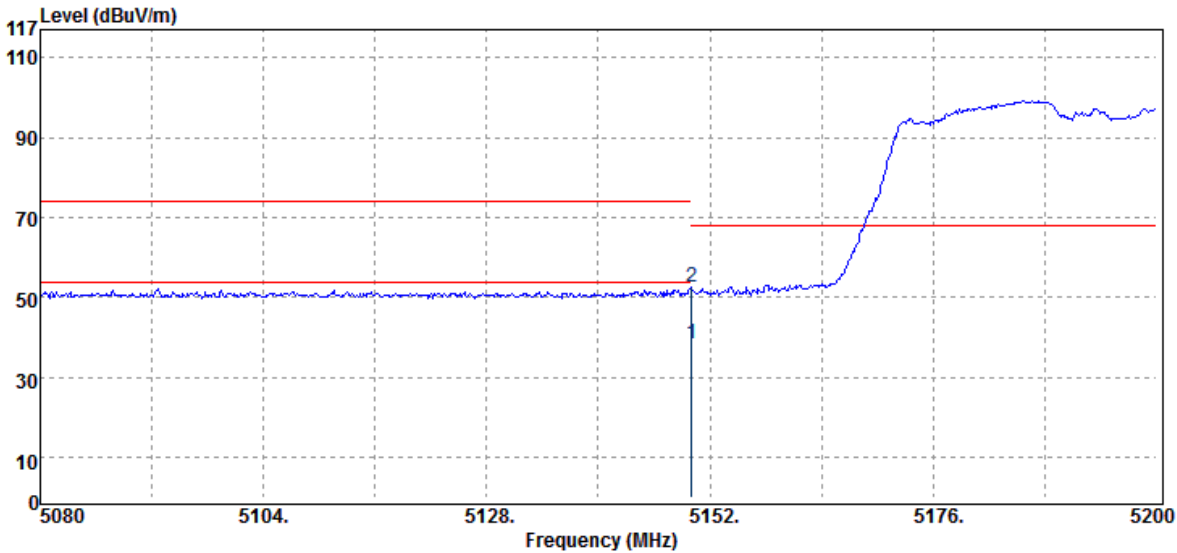

Freq. MHz	Detector Mode PK/QP/AV	Spectrum Reading Level dB μ V	Factor dB	Actual FS dB μ V/m	Limit @3m dB μ V/m	Margin dB
5150.00	Average	33.94	4.55	38.49	54.00	-15.51
5150.00	Peak	47.95	4.55	52.50	74.00	-21.50

Unless otherwise stated the results shown in this test report refer only to the sample(s) tested and such sample(s) are retained for 90 days only.

除非另有說明，此報告結果僅對測試之樣品負責，同時此樣品僅保留90天。本報告未經本公司書面許可，不可部份複製。

This document is issued by the Company subject to its General Conditions of Service printed overleaf, available on request or accessible at www.sgs.com/terms_and_conditions.htm and for electronic format documents, subject to Terms and Conditions for Electronic Documents at www.sgs.com/terms_e-document.htm. Attention is drawn to the limitation of liability, indemnification and jurisdiction issues defined therein. Any holder of this document is advised that information contained hereon reflects the Company's findings at the time of its intervention only and within the limits of Client's instructions, if any. The Company's sole responsibility is to its Client and this document does not exonerate parties to a transaction from exercising all their rights and obligations under the transaction documents. This document cannot be reproduced except in full, without prior written approval of the Company. Any unauthorized alteration, forgery or falsification of the content or appearance of this document is unlawful and offenders may be prosecuted to the fullest extent of the law.

Operation Band	:802.11n40B1	Test Date	:2019-03-07
Fundamental Frequency	:5190 MHz	Temp./Humi.	:20 deg_C / 61 RH
Operation Mode	:Bandedge CH LOW	Engineer	:Wei
EUT Pol.	:E1 Plane	Measurement Antenna Pol.	:HORIZONTAL

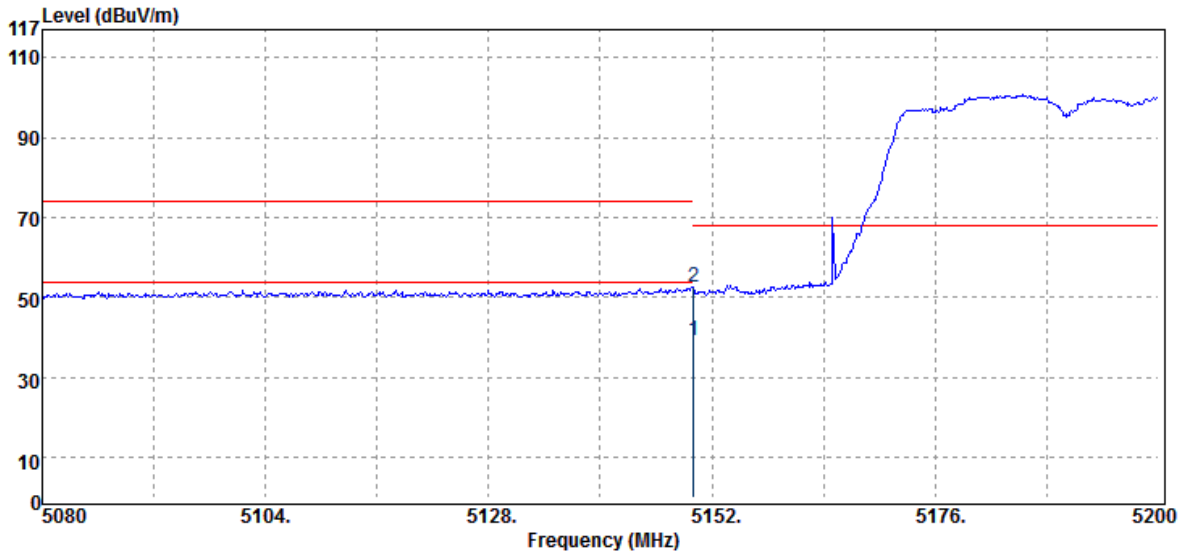

Freq. MHz	Detector Mode PK/QP/AV	Spectrum Reading Level dB μ V	Factor dB	Actual FS dB μ V/m	Limit @3m dB μ V/m	Margin dB
5150.00	Average	34.65	4.55	39.20	54.00	-14.80
5150.00	Peak	48.04	4.55	52.59	74.00	-21.41

Unless otherwise stated the results shown in this test report refer only to the sample(s) tested and such sample(s) are retained for 90 days only.

除非另有說明，此報告結果僅對測試之樣品負責，同時此樣品僅保留90天。本報告未經本公司書面許可，不可部份複製。

This document is issued by the Company subject to its General Conditions of Service printed overleaf, available on request or accessible at www.sgs.com/terms_and_conditions.htm and for electronic format documents, subject to Terms and Conditions for Electronic Documents at www.sgs.com/terms_e-document.htm. Attention is drawn to the limitation of liability, indemnification and jurisdiction issues defined therein. Any holder of this document is advised that information contained hereon reflects the Company's findings at the time of its intervention only and within the limits of Client's instructions, if any. The Company's sole responsibility is to its Client and this document does not exonerate parties to a transaction from exercising all their rights and obligations under the transaction documents. This document cannot be reproduced except in full, without prior written approval of the Company. Any unauthorized alteration, forgery or falsification of the content or appearance of this document is unlawful and offenders may be prosecuted to the fullest extent of the law.

Operation Band	:802.11n40B2	Test Date	:2019-03-07
Fundamental Frequency	:5310 MHz	Temp./Humi.	:20 deg_C / 61 RH
Operation Mode	:Bandedge CH HIGH	Engineer	:Wei
EUT Pol.	:E1 Plane	Measurement Antenna Pol.	:VERTICAL

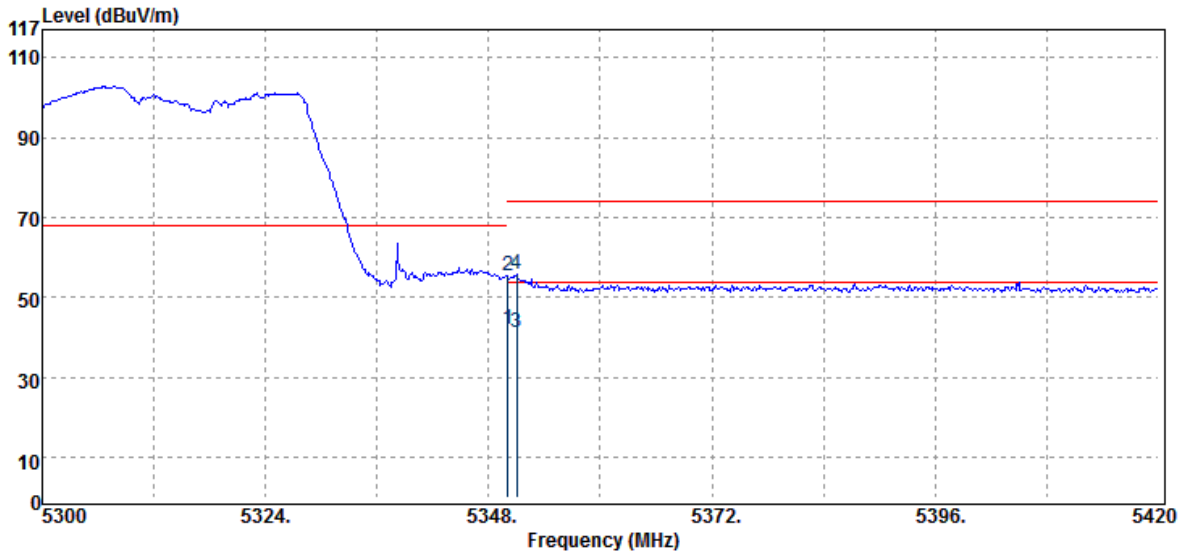

Freq. MHz	Detector Mode PK/QP/AV	Spectrum Reading Level dB μ V	Factor dB	Actual FS dB μ V/m	Limit @3m dB μ V/m	Margin dB
5350.04	Average	36.87	5.19	42.06	54.00	-11.94
5350.04	Peak	50.13	5.19	55.32	74.00	-18.68
5351.00	Average	36.02	5.20	41.22	54.00	-12.78
5351.00	Peak	50.57	5.20	55.77	74.00	-18.23

Unless otherwise stated the results shown in this test report refer only to the sample(s) tested and such sample(s) are retained for 90 days only.

除非另有說明，此報告結果僅對測試之樣品負責，同時此樣品僅保留90天。本報告未經本公司書面許可，不可部份複製。

This document is issued by the Company subject to its General Conditions of Service printed overleaf, available on request or accessible at www.sgs.com/terms_and_conditions.htm and for electronic format documents, subject to Terms and Conditions for Electronic Documents at www.sgs.com/terms_e-document.htm. Attention is drawn to the limitation of liability, indemnification and jurisdiction issues defined therein. Any holder of this document is advised that information contained hereon reflects the Company's findings at the time of its intervention only and within the limits of Client's instructions, if any. The Company's sole responsibility is to its Client and this document does not exonerate parties to a transaction from exercising all their rights and obligations under the transaction documents. This document cannot be reproduced except in full, without prior written approval of the Company. Any unauthorized alteration, forgery or falsification of the content or appearance of this document is unlawful and offenders may be prosecuted to the fullest extent of the law.

Operation Band	:802.11n40B2	Test Date	:2019-03-07
Fundamental Frequency	:5310 MHz	Temp./Humi.	:20 deg_C / 61 RH
Operation Mode	:Bandedge CH HIGH	Engineer	:Wei
EUT Pol.	:E1 Plane	Measurement Antenna Pol.	:HORIZONTAL

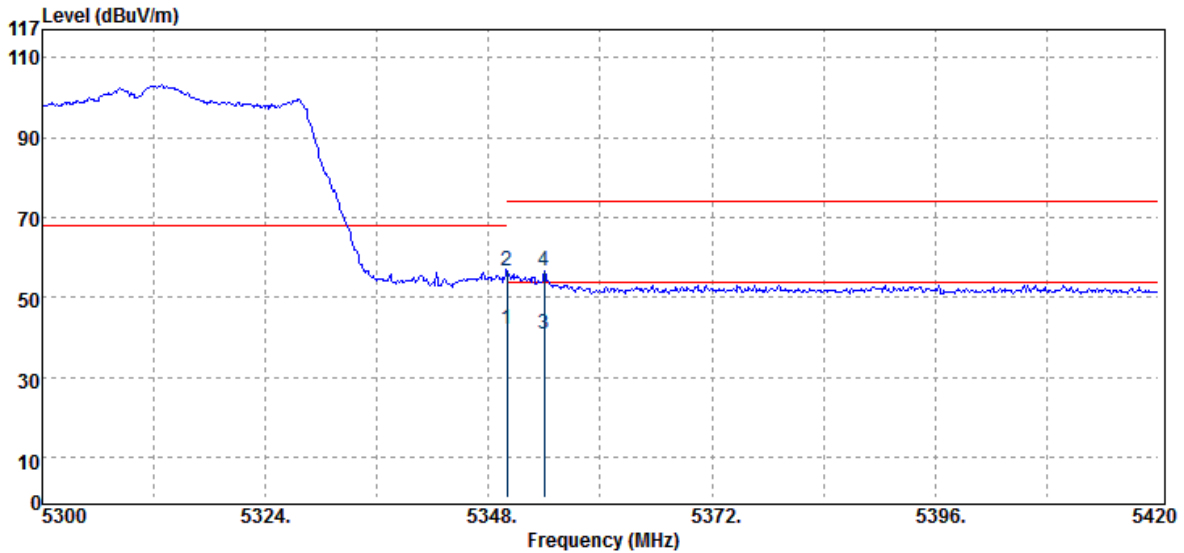

Freq. MHz	Detector Mode PK/QP/AV	Spectrum Reading Level dB μ V	Factor dB	Actual FS dB μ V/m	Limit @3m dB μ V/m	Margin dB
5350.00	Average	37.11	5.19	42.30	54.00	-11.70
5350.00	Peak	51.48	5.19	56.67	74.00	-17.33
5354.00	Average	35.72	5.20	40.92	54.00	-13.08
5354.00	Peak	51.34	5.20	56.54	74.00	-17.46

Unless otherwise stated the results shown in this test report refer only to the sample(s) tested and such sample(s) are retained for 90 days only.

除非另有說明，此報告結果僅對測試之樣品負責，同時此樣品僅保留90天。本報告未經本公司書面許可，不可部份複製。

This document is issued by the Company subject to its General Conditions of Service printed overleaf, available on request or accessible at www.sgs.com/terms_and_conditions.htm and for electronic format documents, subject to Terms and Conditions for Electronic Documents at www.sgs.com/terms_e-document.htm. Attention is drawn to the limitation of liability, indemnification and jurisdiction issues defined therein. Any holder of this document is advised that information contained hereon reflects the Company's findings at the time of its intervention only and within the limits of Client's instructions, if any. The Company's sole responsibility is to its Client and this document does not exonerate parties to a transaction from exercising all their rights and obligations under the transaction documents. This document cannot be reproduced except in full, without prior written approval of the Company. Any unauthorized alteration, forgery or falsification of the content or appearance of this document is unlawful and offenders may be prosecuted to the fullest extent of the law.

Operation Band	:802.11n40B3	Test Date	:2019-03-07
Fundamental Frequency	:5510 MHz	Temp./Humi.	:20 deg_C / 61 RH
Operation Mode	:Bandedge CH LOW	Engineer	:Wei
EUT Pol.	:E1 Plane	Measurement Antenna Pol.	:VERTICAL

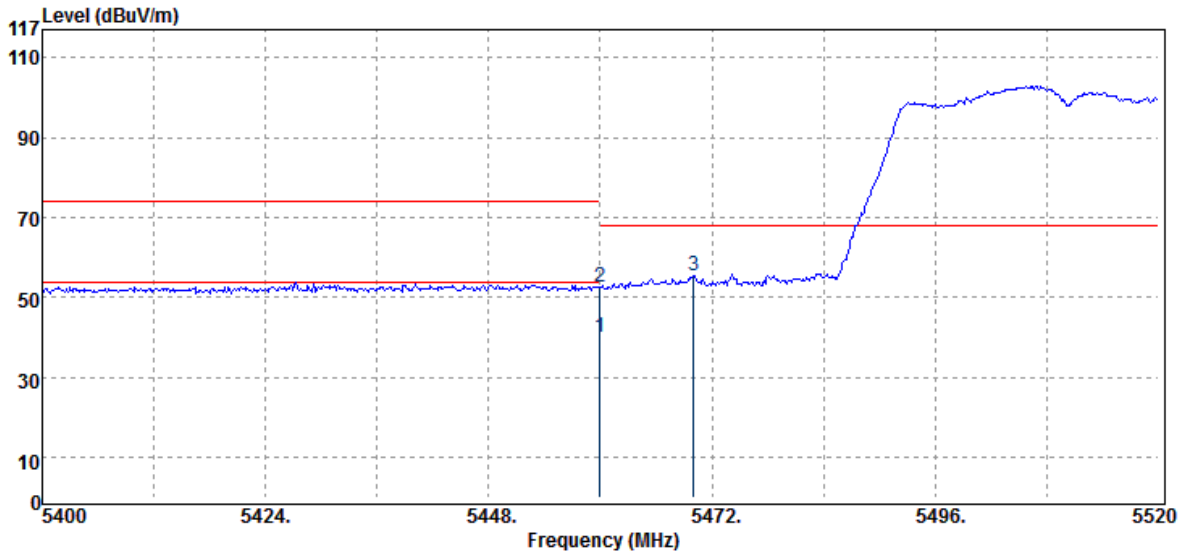

Freq. MHz	Detector Mode PK/QP/AV	Spectrum Reading Level dB μ V	Factor dB	Actual FS dB μ V/m	Limit @3m dB μ V/m	Margin dB
5460.00	Average	34.66	5.54	40.20	54.00	-13.80
5460.00	Peak	46.92	5.54	52.46	74.00	-21.54
5470.00	Peak	49.80	5.52	55.32	68.20	-12.88

Unless otherwise stated the results shown in this test report refer only to the sample(s) tested and such sample(s) are retained for 90 days only.

除非另有說明，此報告結果僅對測試之樣品負責，同時此樣品僅保留90天。本報告未經本公司書面許可，不可部份複製。

This document is issued by the Company subject to its General Conditions of Service printed overleaf, available on request or accessible at www.sgs.com/terms_and_conditions.htm and for electronic format documents, subject to Terms and Conditions for Electronic Documents at www.sgs.com/terms_e-document.htm. Attention is drawn to the limitation of liability, indemnification and jurisdiction issues defined therein. Any holder of this document is advised that information contained hereon reflects the Company's findings at the time of its intervention only and within the limits of Client's instructions, if any. The Company's sole responsibility is to its Client and this document does not exonerate parties to a transaction from exercising all their rights and obligations under the transaction documents. This document cannot be reproduced except in full, without prior written approval of the Company. Any unauthorized alteration, forgery or falsification of the content or appearance of this document is unlawful and offenders may be prosecuted to the fullest extent of the law.

Operation Band	:802.11n40B3	Test Date	:2019-03-07
Fundamental Frequency	:5510 MHz	Temp./Humi.	:20 deg_C / 61 RH
Operation Mode	:Bandedge CH LOW	Engineer	:Wei
EUT Pol.	:E1 Plane	Measurement Antenna Pol.	:HORIZONTAL

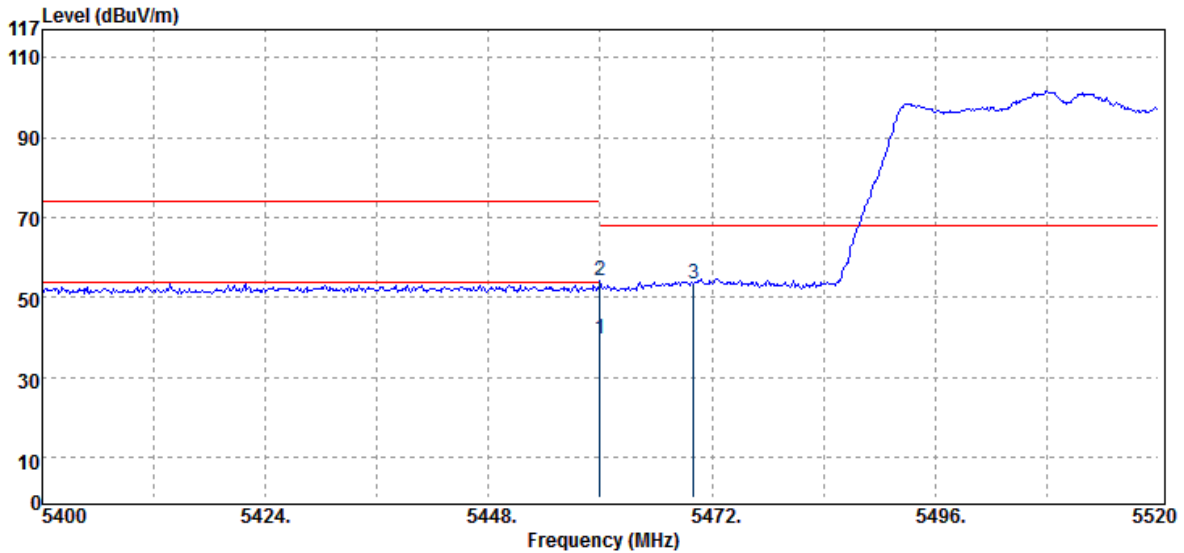

Freq. MHz	Detector Mode PK/QP/AV	Spectrum Reading Level dB μ V	Factor dB	Actual FS dB μ V/m	Limit @3m dB μ V/m	Margin dB
5460.00	Average	34.22	5.54	39.76	54.00	-14.24
5460.00	Peak	48.55	5.54	54.09	74.00	-19.91
5470.00	Peak	47.82	5.52	53.34	68.20	-14.86

Unless otherwise stated the results shown in this test report refer only to the sample(s) tested and such sample(s) are retained for 90 days only.

除非另有說明，此報告結果僅對測試之樣品負責，同時此樣品僅保留90天。本報告未經本公司書面許可，不可部份複製。

This document is issued by the Company subject to its General Conditions of Service printed overleaf, available on request or accessible at www.sgs.com/terms_and_conditions.htm and for electronic format documents, subject to Terms and Conditions for Electronic Documents at www.sgs.com/terms_e-document.htm. Attention is drawn to the limitation of liability, indemnification and jurisdiction issues defined therein. Any holder of this document is advised that information contained hereon reflects the Company's findings at the time of its intervention only and within the limits of Client's instructions, if any. The Company's sole responsibility is to its Client and this document does not exonerate parties to a transaction from exercising all their rights and obligations under the transaction documents. This document cannot be reproduced except in full, without prior written approval of the Company. Any unauthorized alteration, forgery or falsification of the content or appearance of this document is unlawful and offenders may be prosecuted to the fullest extent of the law.

Operation Band	:802.11n40B3	Test Date	:2019-03-07
Fundamental Frequency	:5670 MHz	Temp./Humi.	:20 deg_C / 61 RH
Operation Mode	:Bandedge CH HIGH	Engineer	:Wei
EUT Pol.	:E1 Plane	Measurement Antenna Pol.	:VERTICAL

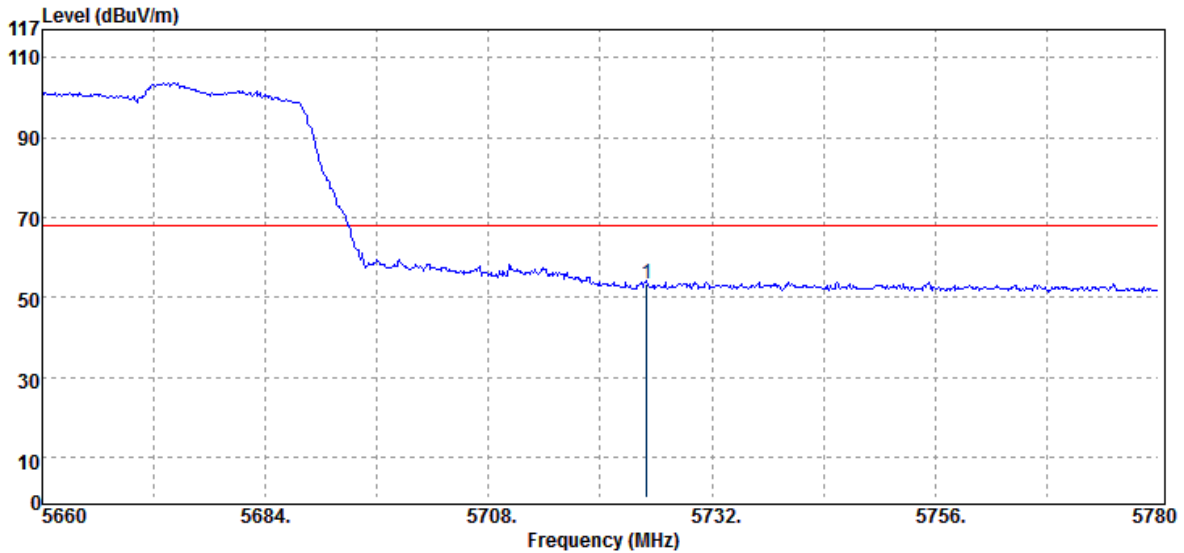

Freq. MHz	Detector Mode PK/QP/AV	Spectrum Reading Level dBuV	Factor dB	Actual FS dBuV/m	Limit @3m dBuV/m	Margin dB
5725.00	Peak	47.03	6.55	53.58	68.20	-14.62

Unless otherwise stated the results shown in this test report refer only to the sample(s) tested and such sample(s) are retained for 90 days only.

除非另有說明，此報告結果僅對測試之樣品負責，同時此樣品僅保留90天。本報告未經本公司書面許可，不可部份複製。

This document is issued by the Company subject to its General Conditions of Service printed overleaf, available on request or accessible at www.sgs.com/terms_and_conditions.htm and for electronic format documents, subject to Terms and Conditions for Electronic Documents at www.sgs.com/terms_e-document.htm. Attention is drawn to the limitation of liability, indemnification and jurisdiction issues defined therein. Any holder of this document is advised that information contained hereon reflects the Company's findings at the time of its intervention only and within the limits of Client's instructions, if any. The Company's sole responsibility is to its Client and this document does not exonerate parties to a transaction from exercising all their rights and obligations under the transaction documents. This document cannot be reproduced except in full, without prior written approval of the Company. Any unauthorized alteration, forgery or falsification of the content or appearance of this document is unlawful and offenders may be prosecuted to the fullest extent of the law.

Operation Band	:802.11n40B3	Test Date	:2019-03-07
Fundamental Frequency	:5670 MHz	Temp./Humi.	:20 deg_C / 61 RH
Operation Mode	:Bandedge CH HIGH	Engineer	:Wei
EUT Pol.	:E1 Plane	Measurement Antenna Pol.	:HORIZONTAL

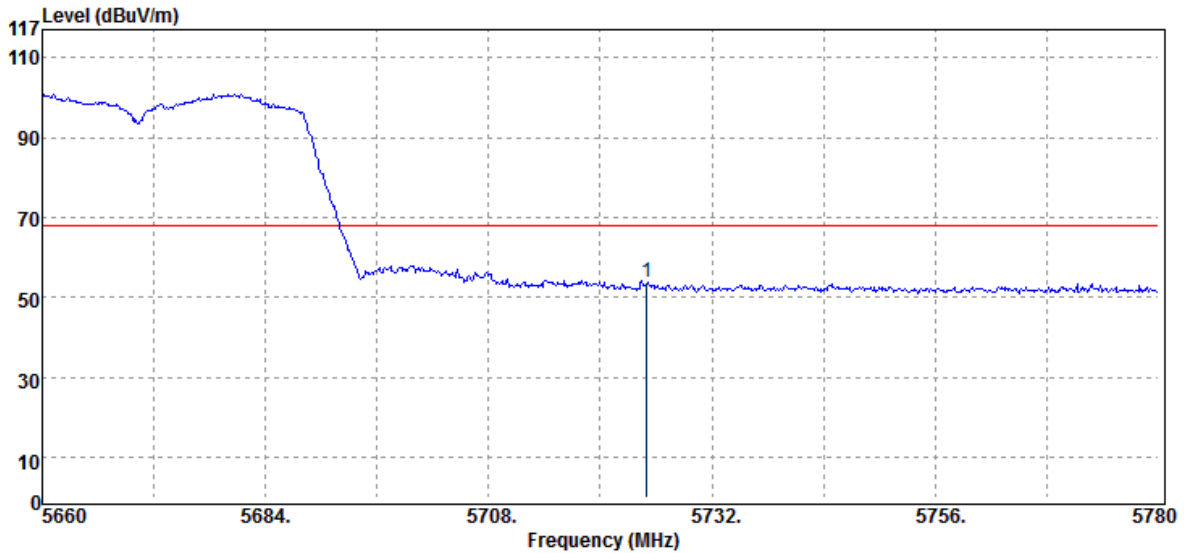

Freq. MHz	Detector Mode PK/QP/AV	Spectrum Reading Level dB μ V	Factor dB	Actual FS dB μ V/m	Limit @3m dB μ V/m	Margin dB
5725.00	Peak	47.18	6.55	53.73	68.20	-14.47

Unless otherwise stated the results shown in this test report refer only to the sample(s) tested and such sample(s) are retained for 90 days only.

除非另有說明，此報告結果僅對測試之樣品負責，同時此樣品僅保留90天。本報告未經本公司書面許可，不可部份複製。

This document is issued by the Company subject to its General Conditions of Service printed overleaf, available on request or accessible at www.sgs.com/terms_and_conditions.htm and for electronic format documents, subject to Terms and Conditions for Electronic Documents at www.sgs.com/terms_e-document.htm. Attention is drawn to the limitation of liability, indemnification and jurisdiction issues defined therein. Any holder of this document is advised that information contained hereon reflects the Company's findings at the time of its intervention only and within the limits of Client's instructions, if any. The Company's sole responsibility is to its Client and this document does not exonerate parties to a transaction from exercising all their rights and obligations under the transaction documents. This document cannot be reproduced except in full, without prior written approval of the Company. Any unauthorized alteration, forgery or falsification of the content or appearance of this document is unlawful and offenders may be prosecuted to the fullest extent of the law.

Operation Band :802.11n40B4
Fundamental Frequency :5755 MHz
Operation Mode :Bandedge CH LOW
EUT Pol. :E1 Plane

Test Date :2019-03-22
Temp./Humi. :23 deg_C / 62 RH
Engineer :Wei
Measurement Antenna Pol. :VERTICAL

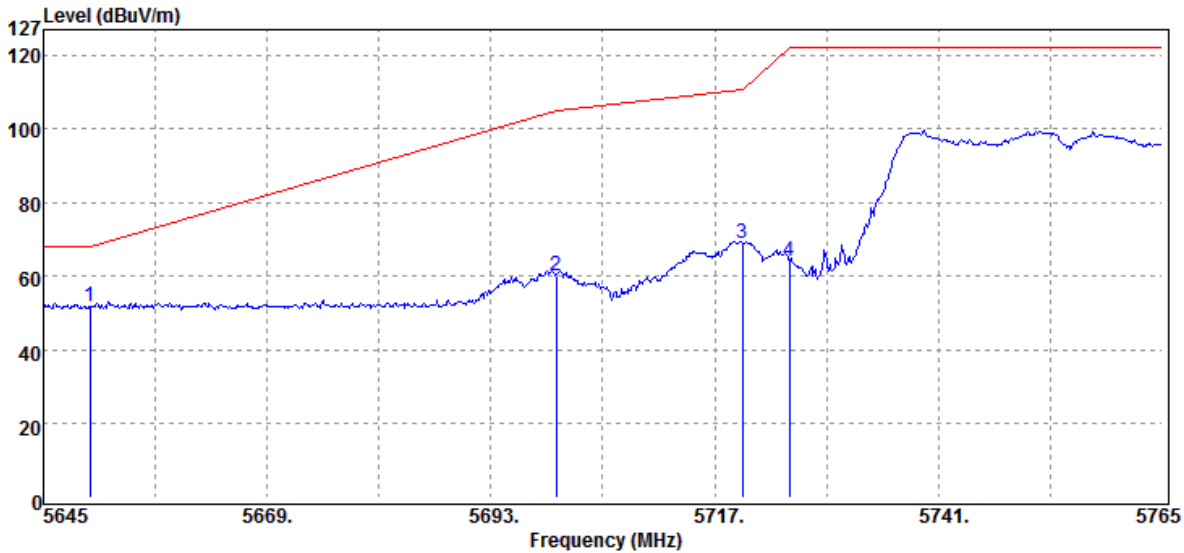

Freq. MHz	Detector Mode PK/QP/AV	Spectrum Reading Level dB μ V	Factor dB	Actual FS dB μ V/m	Limit @3m dB μ V/m	Margin dB
5650.00	Peak	46.00	5.91	51.91	68.23	-16.32
5700.00	Peak	53.88	6.43	60.31	105.23	-44.92
5720.00	Peak	62.64	6.55	69.19	110.83	-41.64
5725.00	Peak	57.70	6.55	64.25	122.23	-57.98

Unless otherwise stated the results shown in this test report refer only to the sample(s) tested and such sample(s) are retained for 90 days only.

除非另有說明，此報告結果僅對測試之樣品負責，同時此樣品僅保留90天。本報告未經本公司書面許可，不可部份複製。

This document is issued by the Company subject to its General Conditions of Service printed overleaf, available on request or accessible at www.sgs.com/terms_and_conditions.htm and for electronic format documents, subject to Terms and Conditions for Electronic Documents at www.sgs.com/terms_e-document.htm. Attention is drawn to the limitation of liability, indemnification and jurisdiction issues defined therein. Any holder of this document is advised that information contained hereon reflects the Company's findings at the time of its intervention only and within the limits of Client's instructions, if any. The Company's sole responsibility is to its Client and this document does not exonerate parties to a transaction from exercising all their rights and obligations under the transaction documents. This document cannot be reproduced except in full, without prior written approval of the Company. Any unauthorized alteration, forgery or falsification of the content or appearance of this document is unlawful and offenders may be prosecuted to the fullest extent of the law.

Operation Band	:802.11n40B4	Test Date	:2019-03-22
Fundamental Frequency	:5755 MHz	Temp./Humi.	:23 deg_C / 62 RH
Operation Mode	:Bandedge CH LOW	Engineer	:Wei
EUT Pol.	:E1 Plane	Measurement Antenna Pol.	:HORIZONTAL

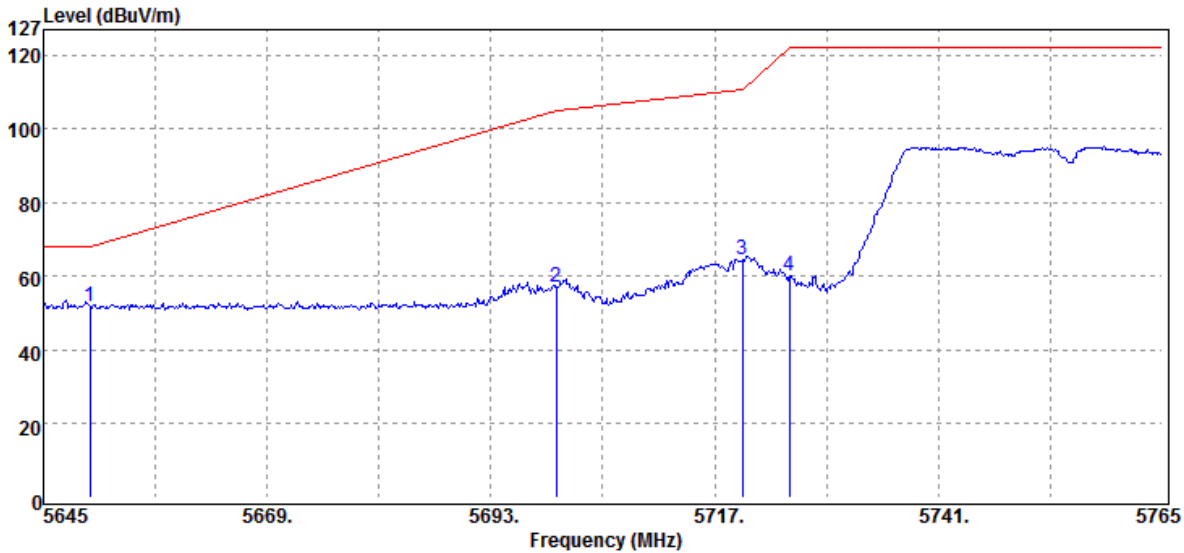

Freq. MHz	Detector Mode PK/QP/AV	Spectrum Reading Level dB μ V	Factor dB	Actual FS dB μ V/m	Limit @3m dB μ V/m	Margin dB
5650.00	Peak	46.16	5.91	52.07	68.23	-16.16
5700.00	Peak	50.67	6.43	57.10	105.23	-48.13
5720.00	Peak	58.02	6.55	64.57	110.83	-46.26
5725.00	Peak	53.50	6.55	60.05	122.23	-62.18

Unless otherwise stated the results shown in this test report refer only to the sample(s) tested and such sample(s) are retained for 90 days only.

除非另有說明，此報告結果僅對測試之樣品負責，同時此樣品僅保留90天。本報告未經本公司書面許可，不可部份複製。

This document is issued by the Company subject to its General Conditions of Service printed overleaf, available on request or accessible at www.sgs.com/terms_and_conditions.htm and for electronic format documents, subject to Terms and Conditions for Electronic Documents at www.sgs.com/terms_e-document.htm. Attention is drawn to the limitation of liability, indemnification and jurisdiction issues defined therein. Any holder of this document is advised that information contained hereon reflects the Company's findings at the time of its intervention only and within the limits of Client's instructions, if any. The Company's sole responsibility is to its Client and this document does not exonerate parties to a transaction from exercising all their rights and obligations under the transaction documents. This document cannot be reproduced except in full, without prior written approval of the Company. Any unauthorized alteration, forgery or falsification of the content or appearance of this document is unlawful and offenders may be prosecuted to the fullest extent of the law.

Operation Band	:802.11n40B4	Test Date	:2019-03-22
Fundamental Frequency	:5795 MHz	Temp./Humi.	:23 deg_C / 62 RH
Operation Mode	:Bandedge CH HIGH	Engineer	:Wei
EUT Pol.	:E1 Plane	Measurement Antenna Pol.	:VERTICAL

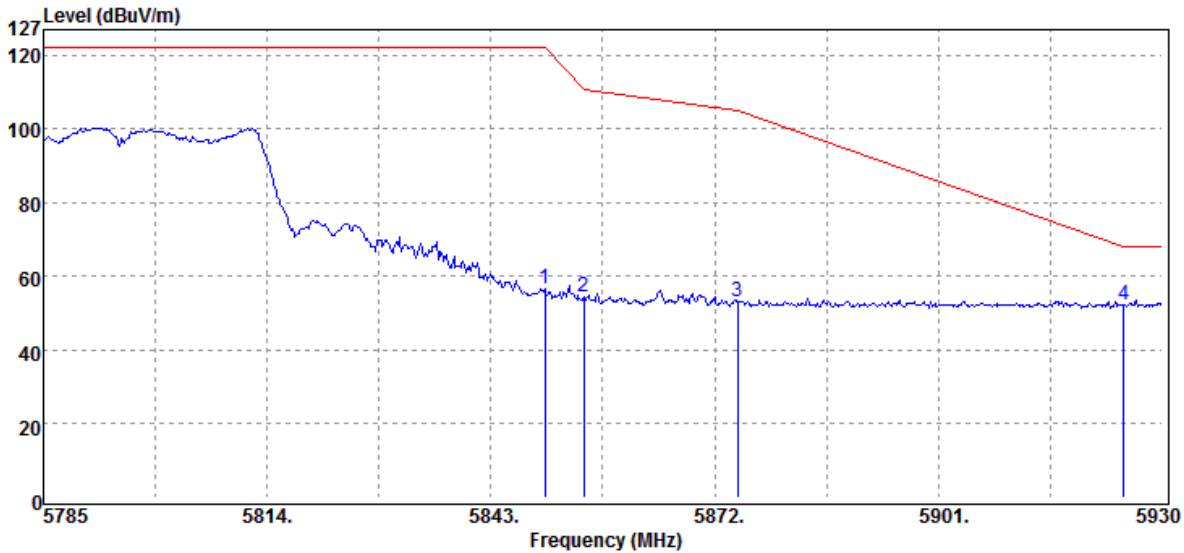

Freq. MHz	Detector Mode PK/QP/AV	Spectrum Reading Level dB μ V	Factor dB	Actual FS dB μ V/m	Limit @3m dB μ V/m	Margin dB
5850.00	Peak	50.33	6.41	56.74	122.23	-65.49
5855.00	Peak	48.19	6.43	54.62	110.83	-56.21
5875.00	Peak	46.65	6.49	53.14	105.23	-52.09
5925.00	Peak	45.90	6.44	52.34	68.23	-15.89

Unless otherwise stated the results shown in this test report refer only to the sample(s) tested and such sample(s) are retained for 90 days only.

除非另有說明，此報告結果僅對測試之樣品負責，同時此樣品僅保留90天。本報告未經本公司書面許可，不可部份複製。

This document is issued by the Company subject to its General Conditions of Service printed overleaf, available on request or accessible at www.sgs.com/terms_and_conditions.htm and for electronic format documents, subject to Terms and Conditions for Electronic Documents at www.sgs.com/terms_e-document.htm. Attention is drawn to the limitation of liability, indemnification and jurisdiction issues defined therein. Any holder of this document is advised that information contained hereon reflects the Company's findings at the time of its intervention only and within the limits of Client's instructions, if any. The Company's sole responsibility is to its Client and this document does not exonerate parties to a transaction from exercising all their rights and obligations under the transaction documents. This document cannot be reproduced except in full, without prior written approval of the Company. Any unauthorized alteration, forgery or falsification of the content or appearance of this document is unlawful and offenders may be prosecuted to the fullest extent of the law.

Operation Band	:802.11n40B4	Test Date	:2019-03-22
Fundamental Frequency	:5795 MHz	Temp./Humi.	:23 deg_C / 62 RH
Operation Mode	:Bandedge CH HIGH	Engineer	:Wei
EUT Pol.	:E1 Plane	Measurement Antenna Pol.	:HORIZONTAL

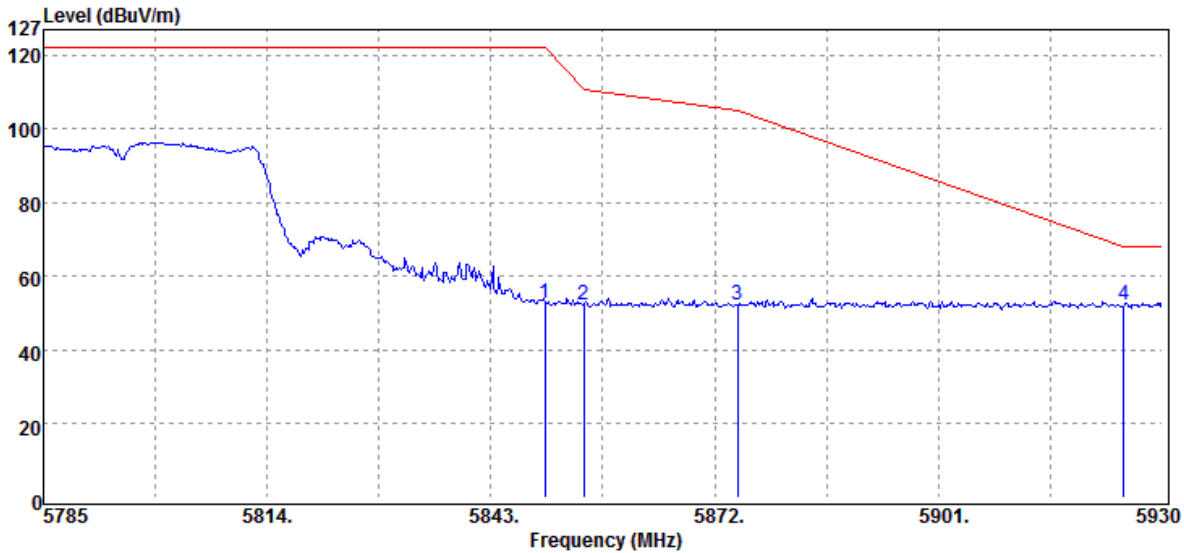

Freq. MHz	Detector Mode PK/QP/AV	Spectrum Reading Level dB μ V	Factor dB	Actual FS dB μ V/m	Limit @3m dB μ V/m	Margin dB
5850.00	Peak	46.40	6.41	52.81	122.23	-69.42
5855.00	Peak	45.73	6.43	52.16	110.83	-58.67
5875.00	Peak	45.70	6.49	52.19	105.23	-53.04
5925.00	Peak	45.94	6.44	52.38	68.23	-15.85

Unless otherwise stated the results shown in this test report refer only to the sample(s) tested and such sample(s) are retained for 90 days only.

除非另有說明，此報告結果僅對測試之樣品負責，同時此樣品僅保留90天。本報告未經本公司書面許可，不可部份複製。

This document is issued by the Company subject to its General Conditions of Service printed overleaf, available on request or accessible at www.sgs.com/terms_and_conditions.htm and for electronic format documents, subject to Terms and Conditions for Electronic Documents at www.sgs.com/terms_e-document.htm. Attention is drawn to the limitation of liability, indemnification and jurisdiction issues defined therein. Any holder of this document is advised that information contained hereon reflects the Company's findings at the time of its intervention only and within the limits of Client's instructions, if any. The Company's sole responsibility is to its Client and this document does not exonerate parties to a transaction from exercising all their rights and obligations under the transaction documents. This document cannot be reproduced except in full, without prior written approval of the Company. Any unauthorized alteration, forgery or falsification of the content or appearance of this document is unlawful and offenders may be prosecuted to the fullest extent of the law.

802.11ac VHT80 mode

Operation Band :802.11ac80B1
Fundamental Frequency :5210 MHz
Operation Mode :Bandedge CH LOW
EUT Pol. :E1 Plane

Test Date :2019-03-07
Temp./Humi. :20 deg_C / 61 RH
Engineer :Wei
Measurement Antenna Pol. :VERTICAL

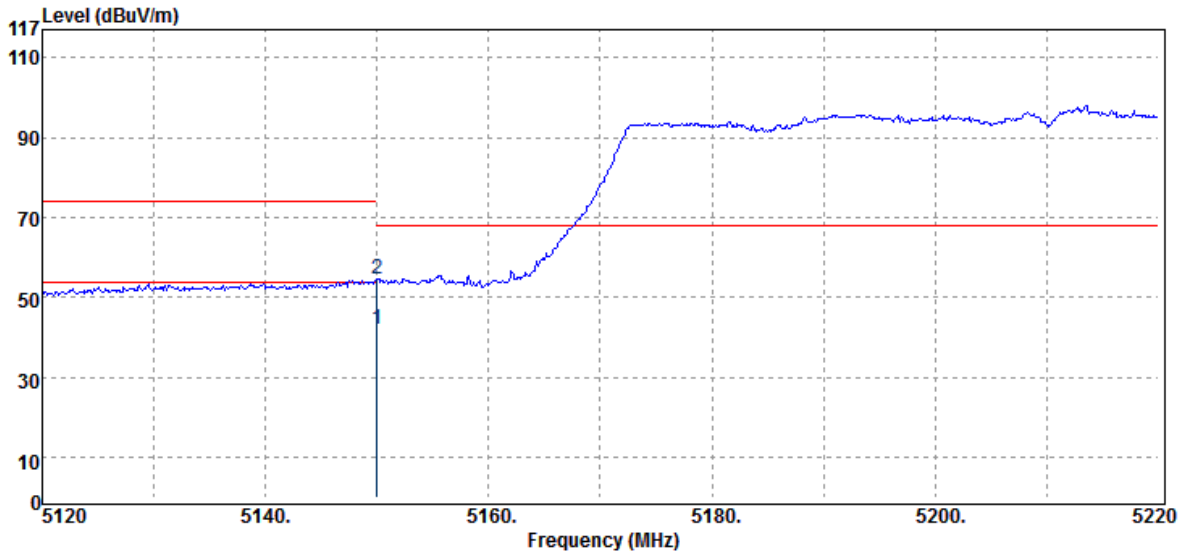

Freq. MHz	Detector Mode PK/QP/AV	Spectrum Reading Level dBuV	Factor dB	Actual FS dBuV/m	Limit @3m dBuV/m	Margin dB
5150.00	Average	37.63	4.55	42.18	54.00	-11.82
5150.00	Peak	50.09	4.55	54.64	74.00	-19.36

Unless otherwise stated the results shown in this test report refer only to the sample(s) tested and such sample(s) are retained for 90 days only.

除非另有說明，此報告結果僅對測試之樣品負責，同時此樣品僅保留90天。本報告未經本公司書面許可，不可部份複製。

This document is issued by the Company subject to its General Conditions of Service printed overleaf, available on request or accessible at www.sgs.com/terms_and_conditions.htm and for electronic format documents, subject to Terms and Conditions for Electronic Documents at www.sgs.com/terms_e-document.htm. Attention is drawn to the limitation of liability, indemnification and jurisdiction issues defined therein. Any holder of this document is advised that information contained hereon reflects the Company's findings at the time of its intervention only and within the limits of Client's instructions, if any. The Company's sole responsibility is to its Client and this document does not exonerate parties to a transaction from exercising all their rights and obligations under the transaction documents. This document cannot be reproduced except in full, without prior written approval of the Company. Any unauthorized alteration, forgery or falsification of the content or appearance of this document is unlawful and offenders may be prosecuted to the fullest extent of the law.

Operation Band	:802.11ac80B1	Test Date	:2019-03-07
Fundamental Frequency	:5210 MHz	Temp./Humi.	:20 deg_C / 61 RH
Operation Mode	:Bandedge CH LOW	Engineer	:Wei
EUT Pol.	:E1 Plane	Measurement Antenna Pol.	:HORIZONTAL

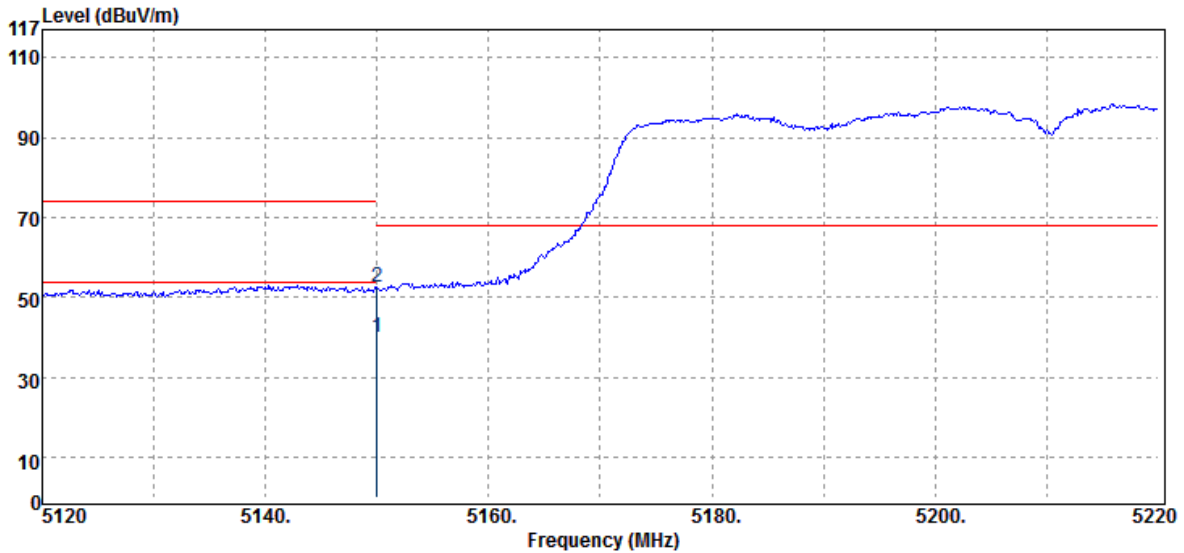

Freq. MHz	Detector Mode PK/QP/AV	Spectrum Reading Level dB μ V	Factor dB	Actual FS dB μ V/m	Limit @3m dB μ V/m	Margin dB
5150.00	Average	35.54	4.55	40.09	54.00	-13.91
5150.00	Peak	48.14	4.55	52.69	74.00	-21.31

Unless otherwise stated the results shown in this test report refer only to the sample(s) tested and such sample(s) are retained for 90 days only.

除非另有說明，此報告結果僅對測試之樣品負責，同時此樣品僅保留90天。本報告未經本公司書面許可，不可部份複製。

This document is issued by the Company subject to its General Conditions of Service printed overleaf, available on request or accessible at www.sgs.com/terms_and_conditions.htm and for electronic format documents, subject to Terms and Conditions for Electronic Documents at www.sgs.com/terms_e-document.htm. Attention is drawn to the limitation of liability, indemnification and jurisdiction issues defined therein. Any holder of this document is advised that information contained hereon reflects the Company's findings at the time of its intervention only and within the limits of Client's instructions, if any. The Company's sole responsibility is to its Client and this document does not exonerate parties to a transaction from exercising all their rights and obligations under the transaction documents. This document cannot be reproduced except in full, without prior written approval of the Company. Any unauthorized alteration, forgery or falsification of the content or appearance of this document is unlawful and offenders may be prosecuted to the fullest extent of the law.

Operation Band	:802.11ac80B2	Test Date	:2019-03-07
Fundamental Frequency	:5290 MHz	Temp./Humi.	:20 deg_C / 61 RH
Operation Mode	:Bandedge CH HIGH	Engineer	:Wei
EUT Pol.	:E1 Plane	Measurement Antenna Pol.	:VERTICAL

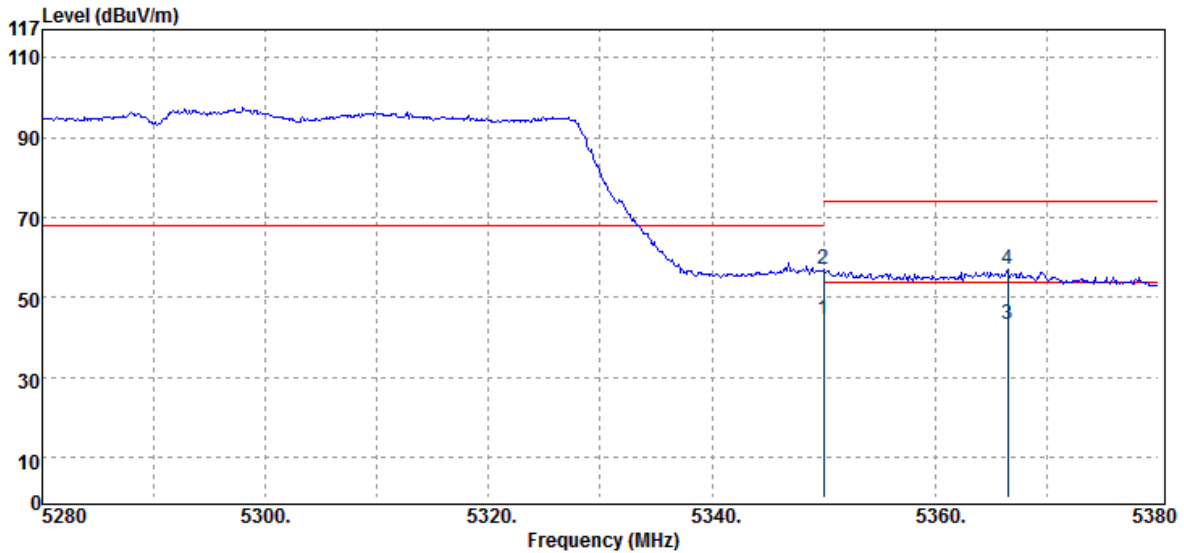

Freq. MHz	Detector Mode PK/QP/AV	Spectrum Reading Level dB μ V	Factor dB	Actual FS dB μ V/m	Limit @3m dB μ V/m	Margin dB
5350.00	Average	39.39	5.19	44.58	54.00	-9.42
5350.00	Peak	51.93	5.19	57.12	74.00	-16.88
5366.50	Average	38.09	5.27	43.36	54.00	-10.64
5366.50	Peak	51.71	5.27	56.98	74.00	-17.02

Unless otherwise stated the results shown in this test report refer only to the sample(s) tested and such sample(s) are retained for 90 days only.

除非另有說明，此報告結果僅對測試之樣品負責，同時此樣品僅保留90天。本報告未經本公司書面許可，不可部份複製。

This document is issued by the Company subject to its General Conditions of Service printed overleaf, available on request or accessible at www.sgs.com/terms_and_conditions.htm and for electronic format documents, subject to Terms and Conditions for Electronic Documents at www.sgs.com/terms_e-document.htm. Attention is drawn to the limitation of liability, indemnification and jurisdiction issues defined therein. Any holder of this document is advised that information contained hereon reflects the Company's findings at the time of its intervention only and within the limits of Client's instructions, if any. The Company's sole responsibility is to its Client and this document does not exonerate parties to a transaction from exercising all their rights and obligations under the transaction documents. This document cannot be reproduced except in full, without prior written approval of the Company. Any unauthorized alteration, forgery or falsification of the content or appearance of this document is unlawful and offenders may be prosecuted to the fullest extent of the law.

Operation Band	:802.11ac80B2	Test Date	:2019-03-07
Fundamental Frequency	:5290 MHz	Temp./Humi.	:20 deg_C / 61 RH
Operation Mode	:Bandedge CH HIGH	Engineer	:Wei
EUT Pol.	:E1 Plane	Measurement Antenna Pol.	:HORIZONTAL

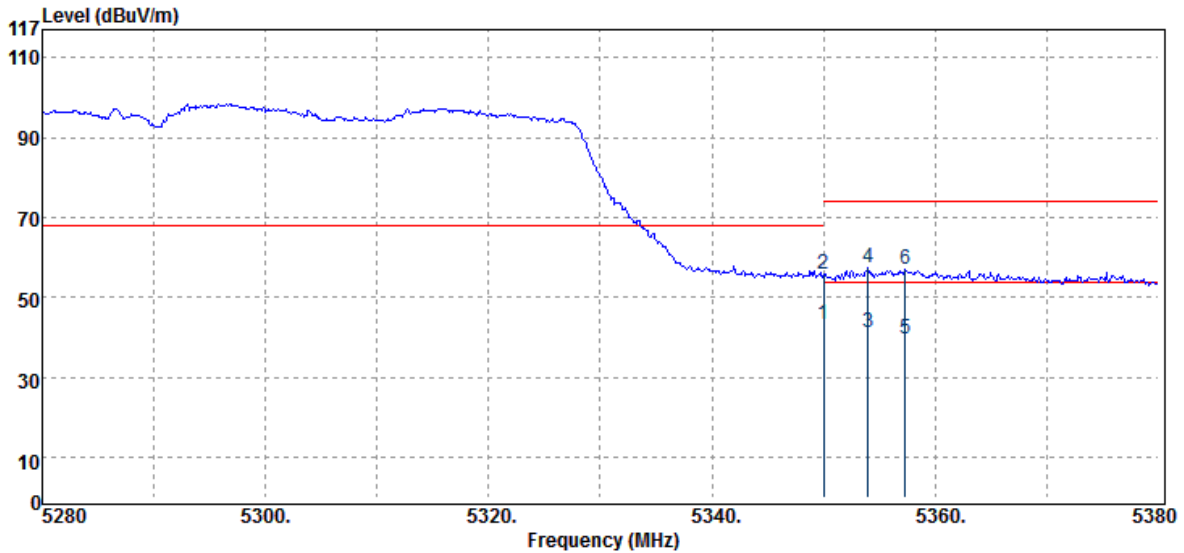

Freq. MHz	Detector Mode PK/QP/AV	Spectrum Reading Level dBuV	Factor dB	Actual FS dBuV/m	Limit @3m dBuV/m	Margin dB
5350.00	Average	38.22	5.19	43.41	54.00	-10.59
5350.00	Peak	50.74	5.19	55.93	74.00	-18.07
5354.00	Average	36.02	5.20	41.22	54.00	-12.78
5354.00	Peak	52.20	5.20	57.40	74.00	-16.60
5357.30	Average	34.66	5.21	39.87	54.00	-14.13
5357.30	Peak	51.79	5.21	57.00	74.00	-17.00

Unless otherwise stated the results shown in this test report refer only to the sample(s) tested and such sample(s) are retained for 90 days only.

除非另有說明，此報告結果僅對測試之樣品負責，同時此樣品僅保留90天。本報告未經本公司書面許可，不可部份複製。

This document is issued by the Company subject to its General Conditions of Service printed overleaf, available on request or accessible at www.sgs.com/terms_and_conditions.htm and for electronic format documents, subject to Terms and Conditions for Electronic Documents at www.sgs.com/terms_e-document.htm. Attention is drawn to the limitation of liability, indemnification and jurisdiction issues defined therein. Any holder of this document is advised that information contained hereon reflects the Company's findings at the time of its intervention only and within the limits of Client's instructions, if any. The Company's sole responsibility is to its Client and this document does not exonerate parties to a transaction from exercising all their rights and obligations under the transaction documents. This document cannot be reproduced except in full, without prior written approval of the Company. Any unauthorized alteration, forgery or falsification of the content or appearance of this document is unlawful and offenders may be prosecuted to the fullest extent of the law.

Operation Band :802.11ac80B3
Fundamental Frequency :5530 MHz
Operation Mode :Bandedge CH LOW
EUT Pol. :E1 Plane

Test Date :2019-03-07
Temp./Humi. :20 deg_C / 61 RH
Engineer :Wei
Measurement Antenna Pol. :VERTICAL

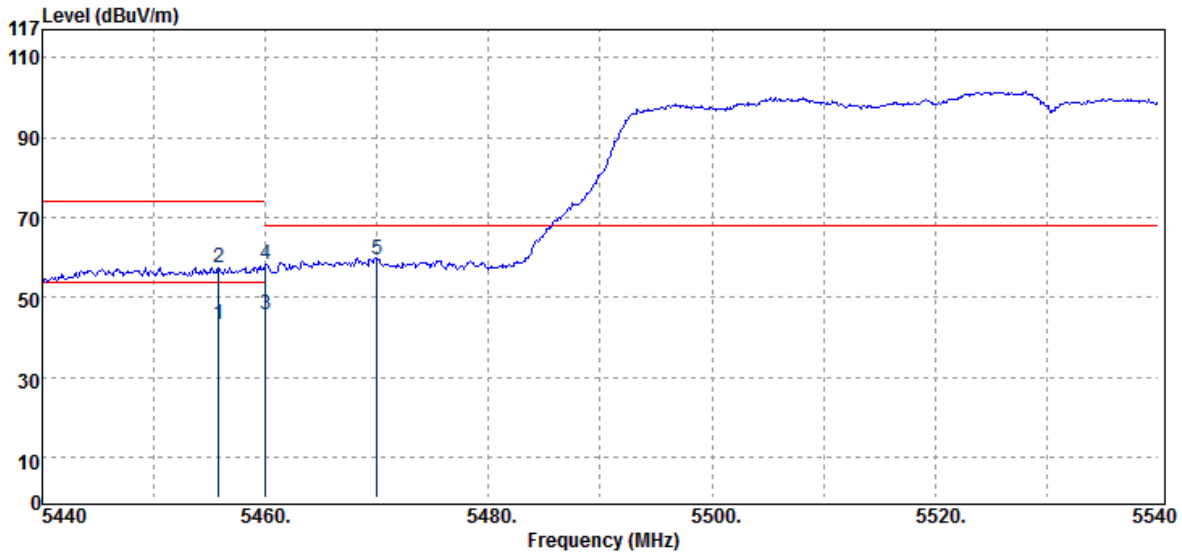

Freq. MHz	Detector Mode PK/QP/AV	Spectrum Reading Level dB μ V	Factor dB	Actual FS dB μ V/m	Limit @3m dB μ V/m	Margin dB
5455.80	Average	37.74	5.54	43.28	54.00	-10.72
5455.80	Peak	51.95	5.54	57.49	74.00	-16.51
5460.00	Average	40.05	5.54	45.59	54.00	-8.41
5460.00	Peak	52.69	5.54	58.23	74.00	-15.77
5470.00	Peak	54.16	5.52	59.68	68.20	-8.52

Unless otherwise stated the results shown in this test report refer only to the sample(s) tested and such sample(s) are retained for 90 days only.

除非另有說明，此報告結果僅對測試之樣品負責，同時此樣品僅保留90天。本報告未經本公司書面許可，不可部份複製。

This document is issued by the Company subject to its General Conditions of Service printed overleaf, available on request or accessible at www.sgs.com/terms_and_conditions.htm and for electronic format documents, subject to Terms and Conditions for Electronic Documents at www.sgs.com/terms_e-document.htm. Attention is drawn to the limitation of liability, indemnification and jurisdiction issues defined therein. Any holder of this document is advised that information contained hereon reflects the Company's findings at the time of its intervention only and within the limits of Client's instructions, if any. The Company's sole responsibility is to its Client and this document does not exonerate parties to a transaction from exercising all their rights and obligations under the transaction documents. This document cannot be reproduced except in full, without prior written approval of the Company. Any unauthorized alteration, forgery or falsification of the content or appearance of this document is unlawful and offenders may be prosecuted to the fullest extent of the law.

Operation Band	:802.11ac80B3	Test Date	:2019-03-07
Fundamental Frequency	:5530 MHz	Temp./Humi.	:20 deg_C / 61 RH
Operation Mode	:Bandedge CH LOW	Engineer	:Wei
EUT Pol.	:E1 Plane	Measurement Antenna Pol.	:HORIZONTAL

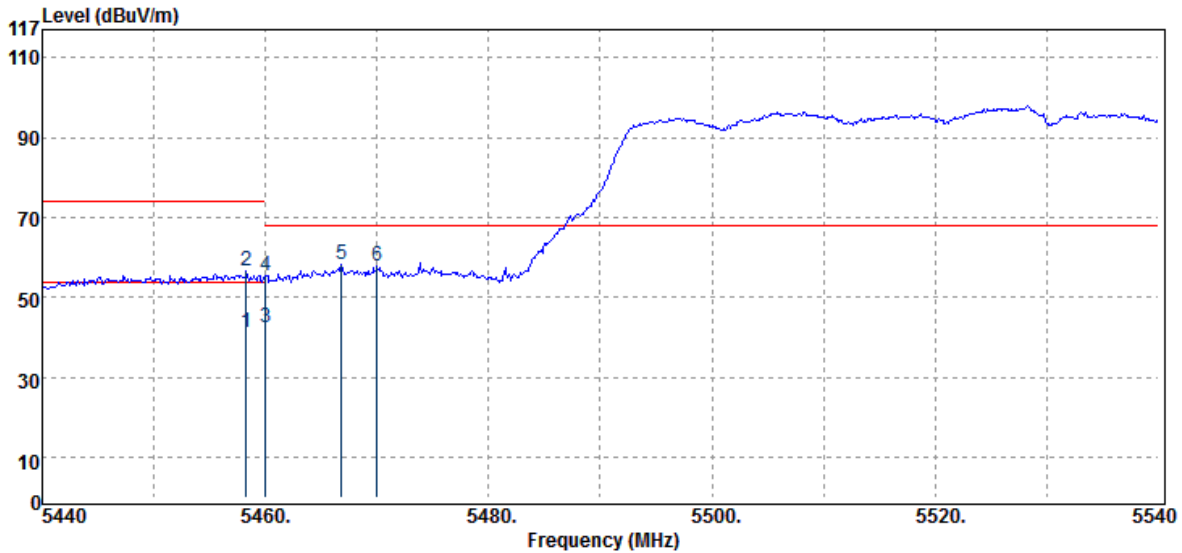

Freq. MHz	Detector Mode PK/QP/AV	Spectrum Reading Level dBuV	Factor dB	Actual FS dBuV/m	Limit @3m dBuV/m	Margin dB
5458.30	Average	35.91	5.53	41.44	54.00	-12.56
5458.30	Peak	51.19	5.53	56.72	74.00	-17.28
5460.00	Average	36.90	5.54	42.44	54.00	-11.56
5460.00	Peak	49.99	5.54	55.53	74.00	-18.47
5466.80	Peak	52.57	5.53	58.10	68.20	-10.10
5470.00	Peak	52.22	5.52	57.74	68.20	-10.46

Unless otherwise stated the results shown in this test report refer only to the sample(s) tested and such sample(s) are retained for 90 days only.

除非另有說明，此報告結果僅對測試之樣品負責，同時此樣品僅保留90天。本報告未經本公司書面許可，不可部份複製。

This document is issued by the Company subject to its General Conditions of Service printed overleaf, available on request or accessible at www.sgs.com/terms_and_conditions.htm and for electronic format documents, subject to Terms and Conditions for Electronic Documents at www.sgs.com/terms_e-document.htm. Attention is drawn to the limitation of liability, indemnification and jurisdiction issues defined therein. Any holder of this document is advised that information contained hereon reflects the Company's findings at the time of its intervention only and within the limits of Client's instructions, if any. The Company's sole responsibility is to its Client and this document does not exonerate parties to a transaction from exercising all their rights and obligations under the transaction documents. This document cannot be reproduced except in full, without prior written approval of the Company. Any unauthorized alteration, forgery or falsification of the content or appearance of this document is unlawful and offenders may be prosecuted to the fullest extent of the law.

Operation Band :802.11ac80B3
Fundamental Frequency :5610 MHz
Operation Mode :Bandedge CH MID
EUT Pol. :E1 Plane

Test Date :2019-03-07
Temp./Humi. :20 deg_C / 61 RH
Engineer :Wei
Measurement Antenna Pol. :VERTICAL

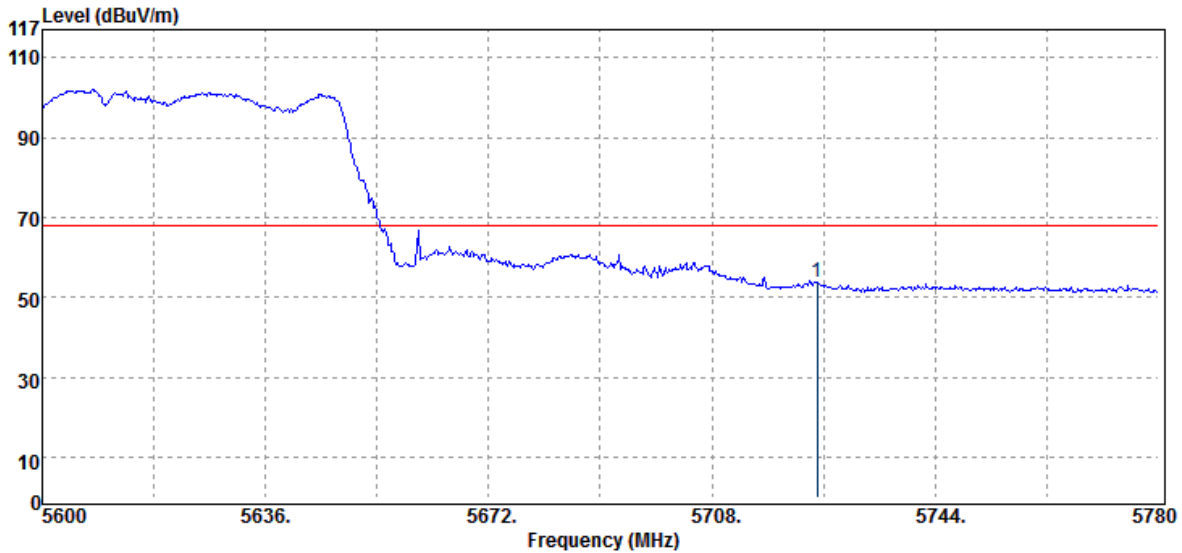

Freq. MHz	Detector Mode PK/QP/AV	Spectrum Reading Level dB μ V	Factor dB	Actual FS dB μ V/m	Limit @3m dB μ V/m	Margin dB
5725.00	Peak	47.15	6.55	53.70	68.20	-14.50

Unless otherwise stated the results shown in this test report refer only to the sample(s) tested and such sample(s) are retained for 90 days only.

除非另有說明，此報告結果僅對測試之樣品負責，同時此樣品僅保留90天。本報告未經本公司書面許可，不可部份複製。

This document is issued by the Company subject to its General Conditions of Service printed overleaf, available on request or accessible at www.sgs.com/terms_and_conditions.htm and for electronic format documents, subject to Terms and Conditions for Electronic Documents at www.sgs.com/terms_e-document.htm. Attention is drawn to the limitation of liability, indemnification and jurisdiction issues defined therein. Any holder of this document is advised that information contained hereon reflects the Company's findings at the time of its intervention only and within the limits of Client's instructions, if any. The Company's sole responsibility is to its Client and this document does not exonerate parties to a transaction from exercising all their rights and obligations under the transaction documents. This document cannot be reproduced except in full, without prior written approval of the Company. Any unauthorized alteration, forgery or falsification of the content or appearance of this document is unlawful and offenders may be prosecuted to the fullest extent of the law.

Operation Band	:802.11ac80B3	Test Date	:2019-03-07
Fundamental Frequency	:5610 MHz	Temp./Humi.	:20 deg_C / 61 RH
Operation Mode	:Bandedge CH MID	Engineer	:Wei
EUT Pol.	:E1 Plane	Measurement Antenna Pol.	:HORIZONTAL

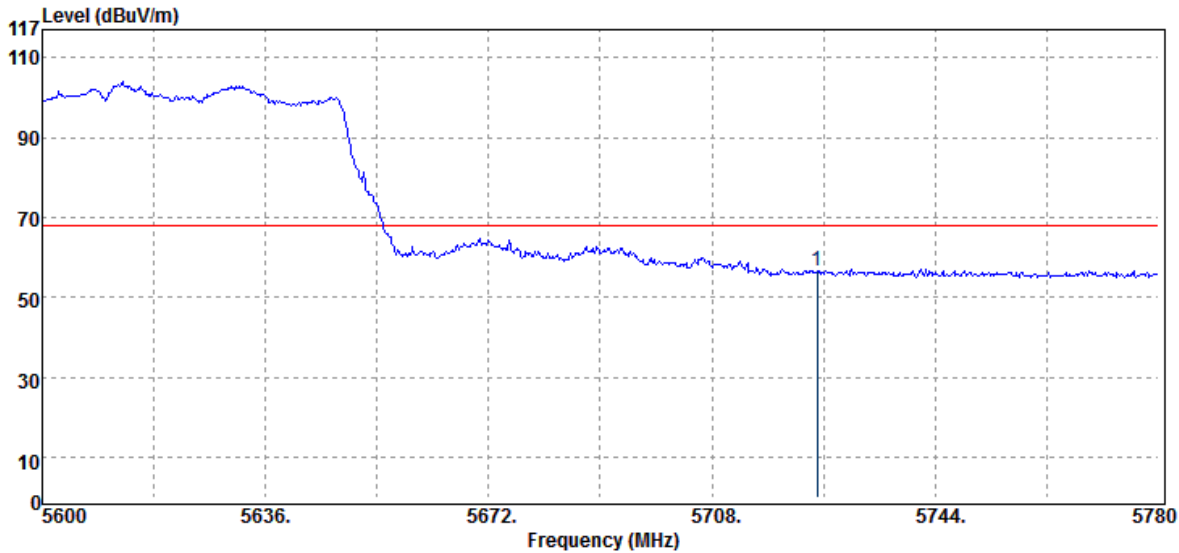

Freq. MHz	Detector Mode PK/QP/AV	Spectrum Reading Level dB μ V	Factor dB	Actual FS dB μ V/m	Limit @3m dB μ V/m	Margin dB
5725.00	Peak	50.25	6.55	56.80	68.20	-11.40

Unless otherwise stated the results shown in this test report refer only to the sample(s) tested and such sample(s) are retained for 90 days only.

除非另有說明，此報告結果僅對測試之樣品負責，同時此樣品僅保留90天。本報告未經本公司書面許可，不可部份複製。

This document is issued by the Company subject to its General Conditions of Service printed overleaf, available on request or accessible at www.sgs.com/terms_and_conditions.htm and for electronic format documents, subject to Terms and Conditions for Electronic Documents at www.sgs.com/terms_e-document.htm. Attention is drawn to the limitation of liability, indemnification and jurisdiction issues defined therein. Any holder of this document is advised that information contained hereon reflects the Company's findings at the time of its intervention only and within the limits of Client's instructions, if any. The Company's sole responsibility is to its Client and this document does not exonerate parties to a transaction from exercising all their rights and obligations under the transaction documents. This document cannot be reproduced except in full, without prior written approval of the Company. Any unauthorized alteration, forgery or falsification of the content or appearance of this document is unlawful and offenders may be prosecuted to the fullest extent of the law.

Operation Band :802.11ac80B4
Fundamental Frequency :5775 MHz
Operation Mode :Bandedge CH LOW
EUT Pol. :E1 Plane

Test Date :2019-03-22
Temp./Humi. :23 deg_C / 62 RH
Engineer :Wei
Measurement Antenna Pol. :VERTICAL

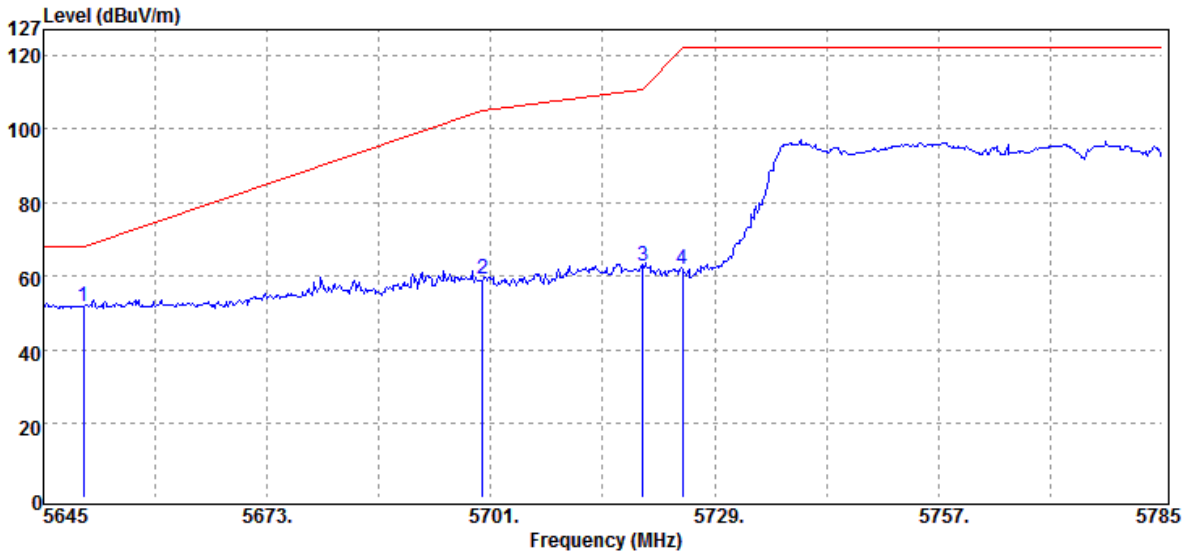

Freq. MHz	Detector Mode PK/QP/AV	Spectrum Reading Level dB μ V	Factor dB	Actual FS dB μ V/m	Limit @3m dB μ V/m	Margin dB
5650.00	Peak	46.09	5.91	52.00	68.23	-16.23
5700.00	Peak	52.99	6.43	59.42	105.23	-45.81
5720.00	Peak	56.24	6.55	62.79	110.83	-48.04
5725.00	Peak	55.24	6.55	61.79	122.23	-60.44

Unless otherwise stated the results shown in this test report refer only to the sample(s) tested and such sample(s) are retained for 90 days only.

除非另有說明，此報告結果僅對測試之樣品負責，同時此樣品僅保留90天。本報告未經本公司書面許可，不可部份複製。

This document is issued by the Company subject to its General Conditions of Service printed overleaf, available on request or accessible at www.sgs.com/terms_and_conditions.htm and for electronic format documents, subject to Terms and Conditions for Electronic Documents at www.sgs.com/terms_e-document.htm. Attention is drawn to the limitation of liability, indemnification and jurisdiction issues defined therein. Any holder of this document is advised that information contained hereon reflects the Company's findings at the time of its intervention only and within the limits of Client's instructions, if any. The Company's sole responsibility is to its Client and this document does not exonerate parties to a transaction from exercising all their rights and obligations under the transaction documents. This document cannot be reproduced except in full, without prior written approval of the Company. Any unauthorized alteration, forgery or falsification of the content or appearance of this document is unlawful and offenders may be prosecuted to the fullest extent of the law.

Operation Band	:802.11ac80B4	Test Date	:2019-03-22
Fundamental Frequency	:5775 MHz	Temp./Humi.	:23 deg_C / 62 RH
Operation Mode	:Bandedge CH HIGH	Engineer	:Wei
EUT Pol.	:E1 Plane	Measurement Antenna Pol.	:VERTICAL

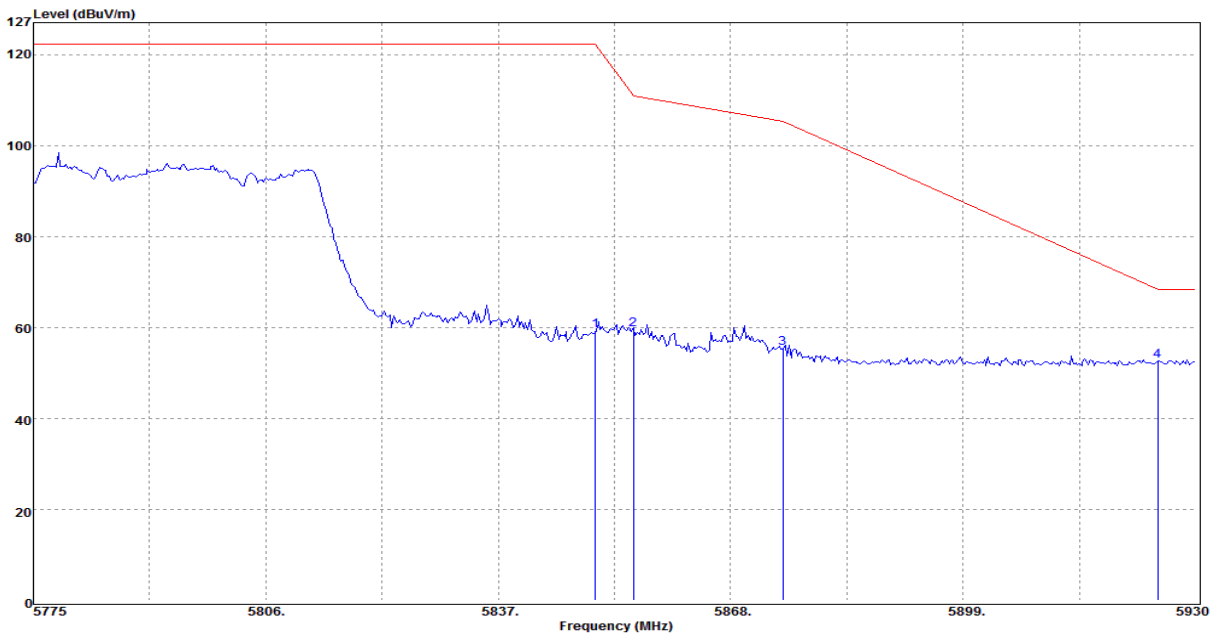

Freq. MHz	Detector Mode PK/QP/AV	Spectrum Reading Level dB μ V	Factor dB	Actual FS dB μ V/m	Limit @3m dB μ V/m	Margin dB
5850.00	Peak	52.98	6.41	59.39	122.23	-62.84
5855.00	Peak	53.05	6.43	59.48	110.83	-51.35
5875.00	Peak	48.85	6.49	55.34	105.23	-49.89
5925.00	Peak	46.15	6.44	52.59	68.23	-15.64

Unless otherwise stated the results shown in this test report refer only to the sample(s) tested and such sample(s) are retained for 90 days only.

除非另有說明，此報告結果僅對測試之樣品負責，同時此樣品僅保留90天。本報告未經本公司書面許可，不可部份複製。

This document is issued by the Company subject to its General Conditions of Service printed overleaf, available on request or accessible at www.sgs.com/terms_and_conditions.htm and for electronic format documents, subject to Terms and Conditions for Electronic Documents at www.sgs.com/terms_e-document.htm. Attention is drawn to the limitation of liability, indemnification and jurisdiction issues defined therein. Any holder of this document is advised that information contained hereon reflects the Company's findings at the time of its intervention only and within the limits of Client's instructions, if any. The Company's sole responsibility is to its Client and this document does not exonerate parties to a transaction from exercising all their rights and obligations under the transaction documents. This document cannot be reproduced except in full, without prior written approval of the Company. Any unauthorized alteration, forgery or falsification of the content or appearance of this document is unlawful and offenders may be prosecuted to the fullest extent of the law.

Operation Band	:802.11ac80B4	Test Date	:2019-03-22
Fundamental Frequency	:5775 MHz	Temp./Humi.	:23 deg_C / 62 RH
Operation Mode	:Bandedge CH LOW	Engineer	:Wei
EUT Pol.	:E1 Plane	Measurement Antenna Pol.	:HORIZONTAL

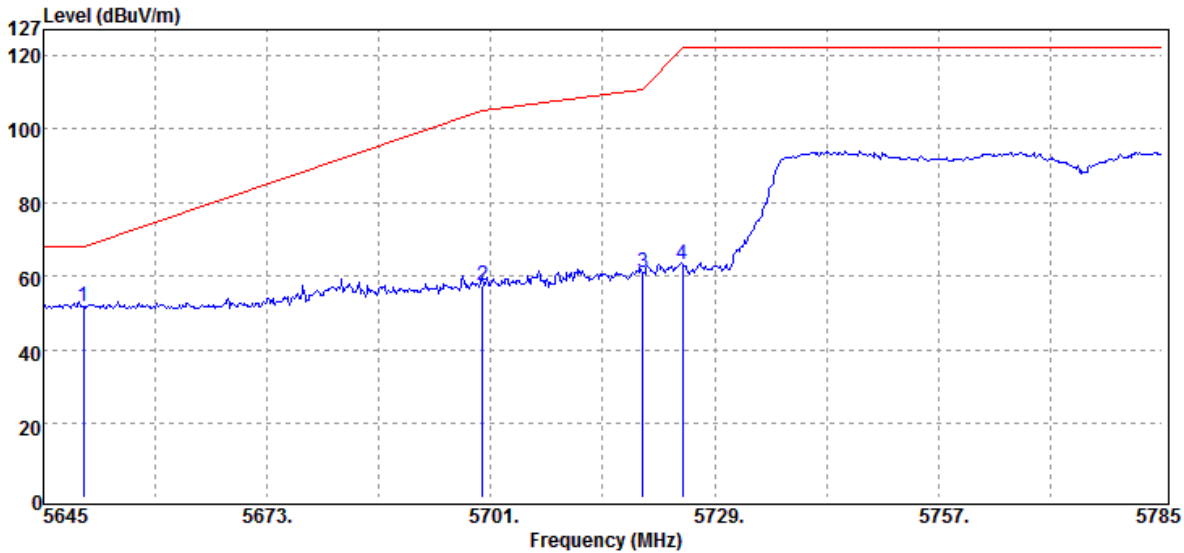

Freq. MHz	Detector Mode PK/QP/AV	Spectrum Reading Level dB μ V	Factor dB	Actual FS dB μ V/m	Limit @3m dB μ V/m	Margin dB
5650.00	Peak	45.88	5.91	51.79	68.23	-16.44
5700.00	Peak	51.22	6.43	57.65	105.23	-47.58
5720.00	Peak	54.47	6.55	61.02	110.83	-49.81
5725.00	Peak	56.77	6.55	63.32	122.23	-58.91

Unless otherwise stated the results shown in this test report refer only to the sample(s) tested and such sample(s) are retained for 90 days only.

除非另有說明，此報告結果僅對測試之樣品負責，同時此樣品僅保留90天。本報告未經本公司書面許可，不可部份複製。

This document is issued by the Company subject to its General Conditions of Service printed overleaf, available on request or accessible at www.sgs.com/terms_and_conditions.htm and for electronic format documents, subject to Terms and Conditions for Electronic Documents at www.sgs.com/terms_e-document.htm. Attention is drawn to the limitation of liability, indemnification and jurisdiction issues defined therein. Any holder of this document is advised that information contained hereon reflects the Company's findings at the time of its intervention only and within the limits of Client's instructions, if any. The Company's sole responsibility is to its Client and this document does not exonerate parties to a transaction from exercising all their rights and obligations under the transaction documents. This document cannot be reproduced except in full, without prior written approval of the Company. Any unauthorized alteration, forgery or falsification of the content or appearance of this document is unlawful and offenders may be prosecuted to the fullest extent of the law.

Operation Band	:802.11ac80B4	Test Date	:2019-03-22
Fundamental Frequency	:5775 MHz	Temp./Humi.	:23 deg_C / 62 RH
Operation Mode	:Bandedge CH HIGH	Engineer	:Wei
EUT Pol.	:E1 Plane	Measurement Antenna Pol.	:HORIZONTAL

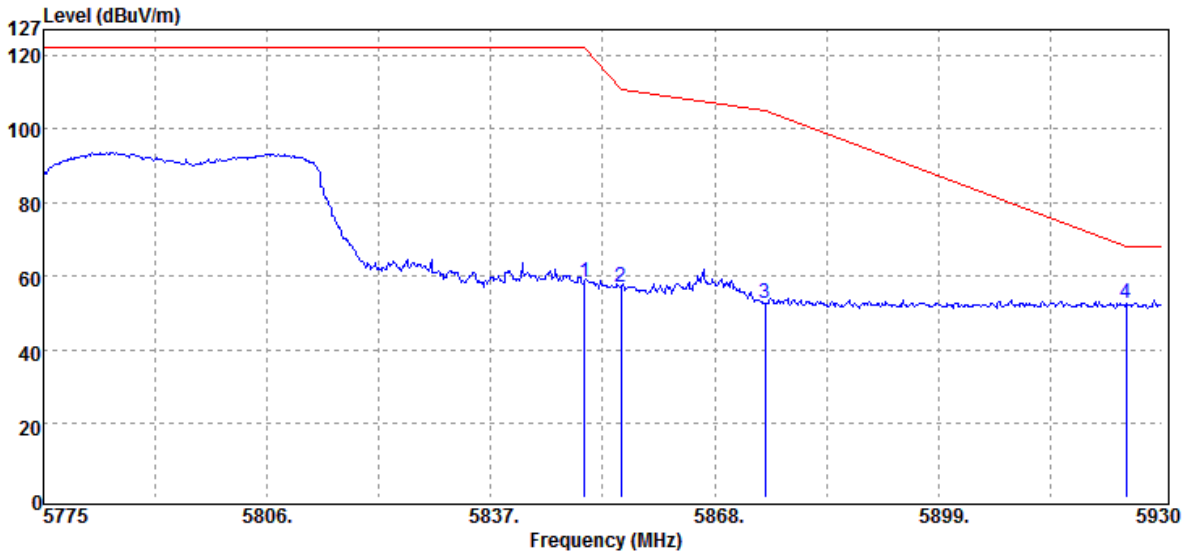

Freq. MHz	Detector Mode PK/QP/AV	Spectrum Reading Level dB μ V	Factor dB	Actual FS dB μ V/m	Limit @3m dB μ V/m	Margin dB
5850.00	Peak	52.24	6.41	58.65	122.23	-63.58
5855.00	Peak	50.73	6.43	57.16	110.83	-53.67
5875.00	Peak	46.35	6.49	52.84	105.23	-52.39
5925.00	Peak	46.10	6.44	52.54	68.23	-15.69

Unless otherwise stated the results shown in this test report refer only to the sample(s) tested and such sample(s) are retained for 90 days only.

除非另有說明，此報告結果僅對測試之樣品負責，同時此樣品僅保留90天。本報告未經本公司書面許可，不可部份複製。

This document is issued by the Company subject to its General Conditions of Service printed overleaf, available on request or accessible at www.sgs.com/terms_and_conditions.htm and for electronic format documents, subject to Terms and Conditions for Electronic Documents at www.sgs.com/terms_e-document.htm. Attention is drawn to the limitation of liability, indemnification and jurisdiction issues defined therein. Any holder of this document is advised that information contained hereon reflects the Company's findings at the time of its intervention only and within the limits of Client's instructions, if any. The Company's sole responsibility is to its Client and this document does not exonerate parties to a transaction from exercising all their rights and obligations under the transaction documents. This document cannot be reproduced except in full, without prior written approval of the Company. Any unauthorized alteration, forgery or falsification of the content or appearance of this document is unlawful and offenders may be prosecuted to the fullest extent of the law.

12. TRANSMISSION IN THE ABSENCE OF DATA

12.1 Standard Applicable

According to §15.407(c)

The device shall automatically discontinue transmission in case of either absence of information to transmit or operational failure. These provisions are not intended to preclude the transmission of control or signaling information or the use of repetitive codes used by certain digital technologies to complete frame or burst intervals. Applicants shall include in their application for equipment authorization a description of how this requirement is met.

12.2 Result

While the EUT is not transmitting any information, the EUT can automatically discontinue transmission and become standby mode for power saving. The EUT can detect the controlling signal of ASK message transmitting from remote device and verify whether it shall resend or discontinue transmission.

Unless otherwise stated the results shown in this test report refer only to the sample(s) tested and such sample(s) are retained for 90 days only.

除非另有說明，此報告結果僅對測試之樣品負責，同時此樣品僅保留90天。本報告未經本公司書面許可，不可部份複製。

This document is issued by the Company subject to its General Conditions of Service printed overleaf, available on request or accessible at www.sgs.com/terms_and_conditions.htm and for electronic format documents, subject to Terms and Conditions for Electronic Documents at www.sgs.com/terms_e-document.htm. Attention is drawn to the limitation of liability, indemnification and jurisdiction issues defined therein. Any holder of this document is advised that information contained hereon reflects the Company's findings at the time of its intervention only and within the limits of Client's instructions, if any. The Company's sole responsibility is to its Client and this document does not exonerate parties to a transaction from exercising all their rights and obligations under the transaction documents. This document cannot be reproduced except in full, without prior written approval of the Company. Any unauthorized alteration, forgery or falsification of the content or appearance of this document is unlawful and offenders may be prosecuted to the fullest extent of the law.

13. FREQUENCY STABILITY

13.1 Standard Applicable

Manufacturers of U-NII devices are responsible for ensuring frequency stability such that an emission is maintained within the band of operation under all conditions of normal operation as specified in the user’s manual.

13.2 Measurement Procedure

1. The EUT was placed inside temperature chamber and powered and powered by nominal DC voltage.
2. Set EUT as normal operation.
3. Turn the EUT on and couple its output to spectrum.
4. Turn the EUT off and set the chamber to the highest temperature specified.
5. Allow sufficient time (approximately 30 min) for the temperature of the chamber to stabilize, turn the EUT and measure the operating frequency.
6. Repeat step with the temperature chamber set to the lowest temperature.

13.3 Test SET-UP

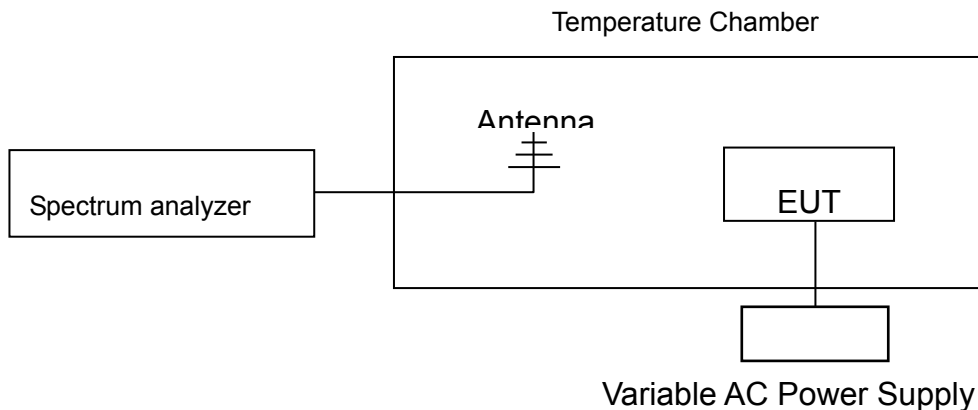

13.4 Measurement Equipment Used:

Conducted Emission Test Site					
EQUIPMENT TYPE	MFR	MODEL NUMBER	SERIAL NUMBER	LAST CAL.	CAL DUE.
DC Power Supply	Agilent	E3640A	KR93300208	08/15/2018	08/14/2019
PXA Spectrum Analyzer	Agilent	N9030A	MY53120760	04/09/2018	04/08/2019
Thermostat-ic/Hrgrosatic Chamber	TAICHY	MHG-150LF	930619	10/08/2018	10/07/2019
DC Block	Mini-Circuits	BLK-18-S+	31129(1)	02/26/2019	02/25/2020
Attenuator	Mini-Circuit	BW-S10W2+	1	02/26/2019	02/25/2020

Unless otherwise stated the results shown in this test report refer only to the sample(s) tested and such sample(s) are retained for 90 days only.

除非另有說明，此報告結果僅對測試之樣品負責，同時此樣品僅保留90天。本報告未經本公司書面許可，不可部份複製。

This document is issued by the Company subject to its General Conditions of Service printed overleaf, available on request or accessible at www.sgs.com/terms_and_conditions.htm and for electronic format documents, subject to Terms and Conditions for Electronic Documents at www.sgs.com/terms_e-document.htm. Attention is drawn to the limitation of liability, indemnification and jurisdiction issues defined therein. Any holder of this document is advised that information contained hereon reflects the Company’s findings at the time of its intervention only and within the limits of Client’s instructions, if any. The Company’s sole responsibility is to its Client and this document does not exonerate parties to a transaction from exercising all their rights and obligations under the transaction documents. This document cannot be reproduced except in full, without prior written approval of the Company. Any unauthorized alteration, forgery or falsification of the content or appearance of this document is unlawful and offenders may be prosecuted to the fullest extent of the law.

13.5 Measurement Result

U-NII-1, U-NII-2-A and U-NII-2-C

Startup:

Operation Mode	802.11 a	Test Date	2019.03.08
Temperature	:22.6 °C	Test By	Peter
Humidity	: 55%		

Test Temp.(°C)	Test Voltage(V)	Channel	Measured Frequency (MHz)	Spectrum Frequency (MHz)	ΔFrequency (MHz)
-10	4	36	5180	5,179.98439	0.00000301
	3.7	36	5180	5,179.98176	0.00000352
25	3.85	36	5180	5,179.99402	0.00000115
55	4	36	5180	5,179.98472	0.00000295
	3.7	36	5180	5,179.98962	0.00000200

2 Minutes:

Operation Mode	802.11 a	Test Date	2019.03.08
Temperature	:22.6 °C	Test By	Peter
Humidity	: 55%		

Test Temp.(°C)	Test Voltage(V)	Channel	Measured Frequency (MHz)	Spectrum Frequency (MHz)	ΔFrequency (MHz)
-10	4	36	5180	5,179.99698	0.00000058
	3.7	36	5180	5,179.99920	0.00000015
25	3.85	36	5180	5,179.99740	0.00000050
55	4	36	5180	5,179.99455	0.00000105
	3.7	36	5180	5,179.99884	0.00000022

Unless otherwise stated the results shown in this test report refer only to the sample(s) tested and such sample(s) are retained for 90 days only.

除非另有說明，此報告結果僅對測試之樣品負責，同時此樣品僅保留90天。本報告未經本公司書面許可，不可部份複製。

This document is issued by the Company subject to its General Conditions of Service printed overleaf, available on request or accessible at www.sgs.com/terms_and_conditions.htm and for electronic format documents, subject to Terms and Conditions for Electronic Documents at www.sgs.com/terms_e-document.htm. Attention is drawn to the limitation of liability, indemnification and jurisdiction issues defined therein. Any holder of this document is advised that information contained hereon reflects the Company's findings at the time of its intervention only and within the limits of Client's instructions, if any. The Company's sole responsibility is to its Client and this document does not exonerate parties to a transaction from exercising all their rights and obligations under the transaction documents. This document cannot be reproduced except in full, without prior written approval of the Company. Any unauthorized alteration, forgery or falsification of the content or appearance of this document is unlawful and offenders may be prosecuted to the fullest extent of the law.

5 Minutes:

Operation Mode	802.11 a	Test Date	2019.03.08
Temperature	:22.6 °C	Test By	Peter
Humidity	: 55%		

Test Temp.(°C)	Test Voltage(V)	Channel	Measured Frequency (MHz)	Spectrum Frequency (MHz)	ΔFrequency (MHz)
-10	4	36	5180	5,179.98280	0.00000332
	3.7	36	5180	5,179.99377	0.00000120
25	3.85	36	5180	5,179.98223	0.00000343
55	4	36	5180	5,179.99197	0.00000155
	3.7	36	5180	5,179.98822	0.00000227

10 Minutes:

Operation Mode	802.11 a	Test Date	2019.03.08
Temperature	:22.6 °C	Test By	Peter
Humidity	: 55%		

Test Temp.(°C)	Test Voltage(V)	Channel	Measured Frequency (MHz)	Spectrum Frequency (MHz)	ΔFrequency (MHz)
-10	4	36	5180	5,179.99796	0.00000039
	3.7	36	5180	5,179.98679	0.00000255
25	3.85	36	5180	5,179.99186	0.00000157
55	4	36	5180	5,179.98398	0.00000309
	3.7	36	5180	5,179.98771	0.00000237

Unless otherwise stated the results shown in this test report refer only to the sample(s) tested and such sample(s) are retained for 90 days only.

除非另有說明，此報告結果僅對測試之樣品負責，同時此樣品僅保留90天。本報告未經本公司書面許可，不可部份複製。

This document is issued by the Company subject to its General Conditions of Service printed overleaf, available on request or accessible at www.sgs.com/terms_and_conditions.htm and for electronic format documents, subject to Terms and Conditions for Electronic Documents at www.sgs.com/terms_e-document.htm. Attention is drawn to the limitation of liability, indemnification and jurisdiction issues defined therein. Any holder of this document is advised that information contained hereon reflects the Company's findings at the time of its intervention only and within the limits of Client's instructions, if any. The Company's sole responsibility is to its Client and this document does not exonerate parties to a transaction from exercising all their rights and obligations under the transaction documents. This document cannot be reproduced except in full, without prior written approval of the Company. Any unauthorized alteration, forgery or falsification of the content or appearance of this document is unlawful and offenders may be prosecuted to the fullest extent of the law.

**U-NII-3
Startup:**

Operation Mode	802.11 a	Test Date	2019.03.13
Temperature	: 24.3°C	Test By	Peter
Humidity	: 57%		

Test Temp.(°C)	Test Voltage(V)	Channel	Measured Frequency (MHz)	Spectrum Frequency (MHz)	ΔFrequency (MHz)
-10	4	149	5745	5,745.82900	-0.00014430
	3.7	149	5745	5,745.81150	-0.00014125
25	3.85	149	5745	5,745.11040	-0.00001922
55	4	149	5745	5,744.34530	0.00011396
	3.7	149	5745	5,744.60280	0.00006914

2 Minutes:

Operation Mode	802.11 a	Test Date	2019.03.13
Temperature	: 24.3°C	Test By	Peter
Humidity	: 57%		

Test Temp.(°C)	Test Voltage(V)	Channel	Measured Frequency (MHz)	Spectrum Frequency (MHz)	ΔFrequency (MHz)
-10	4	149	5745	5,745.87280	-0.00015192
	3.7	149	5745	5,745.48450	-0.00008433
25	3.85	149	5745	5,745.98080	-0.00017072
55	4	149	5745	5,744.12930	0.00015156
	3.7	149	5745	5,744.22850	0.00013429

Unless otherwise stated the results shown in this test report refer only to the sample(s) tested and such sample(s) are retained for 90 days only.

除非另有說明，此報告結果僅對測試之樣品負責，同時此樣品僅保留90天。本報告未經本公司書面許可，不可部份複製。

This document is issued by the Company subject to its General Conditions of Service printed overleaf, available on request or accessible at www.sgs.com/terms_and_conditions.htm and for electronic format documents, subject to Terms and Conditions for Electronic Documents at www.sgs.com/terms_e-document.htm. Attention is drawn to the limitation of liability, indemnification and jurisdiction issues defined therein. Any holder of this document is advised that information contained hereon reflects the Company's findings at the time of its intervention only and within the limits of Client's instructions, if any. The Company's sole responsibility is to its Client and this document does not exonerate parties to a transaction from exercising all their rights and obligations under the transaction documents. This document cannot be reproduced except in full, without prior written approval of the Company. Any unauthorized alteration, forgery or falsification of the content or appearance of this document is unlawful and offenders may be prosecuted to the fullest extent of the law.

5 Minutes:

Operation Mode	802.11 a	Test Date	2019.03.13
Temperature	: 24.3°C	Test By	Peter
Humidity	: 57%		

Test Temp.(°C)	Test Voltage(V)	Channel	Measured Frequency (MHz)	Spectrum Frequency (MHz)	ΔFrequency (MHz)
-10	4	149	5745	5,745.75340	-0.00013114
	3.7	149	5745	5,745.46140	-0.00008031
25	3.85	149	5745	5,745.32870	-0.00005721
55	4	149	5745	5,744.23660	0.00013288
	3.7	149	5745	5,744.56260	0.00007614

10 Minutes:

Operation Mode	802.11 a	Test Date	2019.03.13
Temperature	: 24.3°C	Test By	Peter
Humidity	: 57%		

Test Temp.(°C)	Test Voltage(V)	Channel	Measured Frequency (MHz)	Spectrum Frequency (MHz)	ΔFrequency (MHz)
-10	4	149	5745	5,745.67390	-0.00011730
	3.7	149	5745	5,745.89260	-0.00015537
25	3.85	149	5745	5,745.14110	-0.00002456
55	4	149	5745	5,744.89820	0.00001772
	3.7	149	5745	5,744.78520	0.00003739

Unless otherwise stated the results shown in this test report refer only to the sample(s) tested and such sample(s) are retained for 90 days only.

除非另有說明，此報告結果僅對測試之樣品負責，同時此樣品僅保留90天。本報告未經本公司書面許可，不可部份複製。

This document is issued by the Company subject to its General Conditions of Service printed overleaf, available on request or accessible at www.sgs.com/terms_and_conditions.htm and for electronic format documents, subject to Terms and Conditions for Electronic Documents at www.sgs.com/terms_e-document.htm. Attention is drawn to the limitation of liability, indemnification and jurisdiction issues defined therein. Any holder of this document is advised that information contained hereon reflects the Company's findings at the time of its intervention only and within the limits of Client's instructions, if any. The Company's sole responsibility is to its Client and this document does not exonerate parties to a transaction from exercising all their rights and obligations under the transaction documents. This document cannot be reproduced except in full, without prior written approval of the Company. Any unauthorized alteration, forgery or falsification of the content or appearance of this document is unlawful and offenders may be prosecuted to the fullest extent of the law.

14. ANTENNA REQUIREMENT

14.1 Standard Applicable

According to §15.203, an intentional radiator shall be designed to ensure that no antenna other than furnished by the responsible party shall be used with the device.

According to §15.407, If transmitting antennas of directional gain greater than 6 dBi are used, both the maximum conducted output power and the maximum power spectral density shall be reduced by the amount in dB that the directional gain of the antenna exceeds 6 dBi.

14.2 Antenna Connected Construction

The antenna is designed as permanently attached and no consideration of replacement. Please see EUT photo for details.

~ End of Report ~

Unless otherwise stated the results shown in this test report refer only to the sample(s) tested and such sample(s) are retained for 90 days only.

除非另有說明，此報告結果僅對測試之樣品負責，同時此樣品僅保留90天。本報告未經本公司書面許可，不可部份複製。

This document is issued by the Company subject to its General Conditions of Service printed overleaf, available on request or accessible at www.sgs.com/terms_and_conditions.htm and for electronic format documents, subject to Terms and Conditions for Electronic Documents at www.sgs.com/terms_e-document.htm. Attention is drawn to the limitation of liability, indemnification and jurisdiction issues defined therein. Any holder of this document is advised that information contained hereon reflects the Company's findings at the time of its intervention only and within the limits of Client's instructions, if any. The Company's sole responsibility is to its Client and this document does not exonerate parties to a transaction from exercising all their rights and obligations under the transaction documents. This document cannot be reproduced except in full, without prior written approval of the Company. Any unauthorized alteration, forgery or falsification of the content or appearance of this document is unlawful and offenders may be prosecuted to the fullest extent of the law.