

ELECTROMAGNETIC EMISSIONS COMPLIANCE REPORT
INTENTIONAL RADIATOR CERTIFICATION TO
FCC PART 22 SUBPART H, PART 24 SUBPART E and
PART 27 SUBPART F, H, L & M REQUIREMENT

OF

Applicant: Sharp Corporation, Mobile Communication B.U.
2-13-1, Hachihonmatsu-lida, Higashi-hiroshima-shi,
Hiroshima 739-0192, Japan

Manufacturer: Sharp Corporation
1 Takumi-cho, Sakai-ku, Sakai City, Osaka 590-8522, Japan

Product Name: Smart Phone

Report Number: T190308W01-RP1

FCC ID: APYHRO00273

FCC Rule Part: 2 , 22H & 24E & 27F, H, L & M

Issue Date: Apr. 12, 2019

Date of Test: Mar. 12, 2019 ~ Mar. 28, 2019

Date of EUT Received: Mar. 12, 2019

Issued by: Compliance Certification Services Inc. Wugu Lab.
No.11, Wugong 6th Rd., Wugu Dist., New Taipei City 24891,
Taiwan. (R.O.C.)
service@ccsrf.com

The test Result was tested by Compliance Certification Services Inc. The test data, data evaluation, test procedures, and equipment configurations shown in this report were given in ANSI C63.10: 2013 and compliance standards.

The test results of this report relate only to the tested sample (EUT) identified in this report
The test Report of full or partial shall not copy. Without written approval of Compliance Certification Services Inc. (Wugu Laboratory).

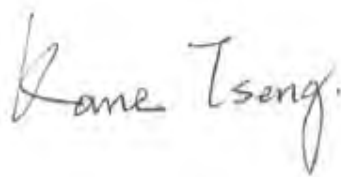

Tested By: _____

Kane Tseng / Engineer



Approved By: _____

Kevin Tsai / Deputy Manager



Unless otherwise stated the results shown in this test report refer only to the sample(s) tested and such sample(s) are retained for 90 days only.

除非另有說明，此報告結果僅對測試之樣品負責，同時此樣品僅保留90天。本報告未經本公司書面許可，不可部份複製。

This document is issued by the Company subject to its General Conditions of Service printed overleaf, available on request or accessible at www.sgs.com/terms_and_conditions.htm and for electronic format documents, subject to Terms and Conditions for Electronic Documents at www.sgs.com/terms_e-document.htm. Attention is drawn to the limitation of liability, indemnification and jurisdiction issues defined therein. Any holder of this document is advised that information contained hereon reflects the Company's findings at the time of its intervention only and within the limits of Client's instructions, if any. The Company's sole responsibility is to its Client and this document does not exonerate parties to a transaction from exercising all their rights and obligations under the transaction documents. This document cannot be reproduced except in full, without prior written approval of the Company. Any unauthorized alteration, forgery or falsification of the content or appearance of this document is unlawful and offenders may be prosecuted to the fullest extent of the law.

Revision History

Report Number	Revision	Description	Effected Page	Issue Date	Revised By
T190308W01-RP1	Rev.00	Initial creation of document	All	Apr. 08, 2019	Violetta Tang
T190308W01-RP1	Rev.01	Update description of test mode	14	Apr. 12, 2019	Violetta Tang

Unless otherwise stated the results shown in this test report refer only to the sample(s) tested and such sample(s) are retained for 90 days only.

除非另有說明，此報告結果僅對測試之樣品負責，同時此樣品僅保留90天。本報告未經本公司書面許可，不可部份複製。

This document is issued by the Company subject to its General Conditions of Service printed overleaf, available on request or accessible at www.sgs.com/terms_and_conditions.htm and for electronic format documents, subject to Terms and Conditions for Electronic Documents at www.sgs.com/terms_e-document.htm. Attention is drawn to the limitation of liability, indemnification and jurisdiction issues defined therein. Any holder of this document is advised that information contained hereon reflects the Company's findings at the time of its intervention only and within the limits of Client's instructions, if any. The Company's sole responsibility is to its Client and this document does not exonerate parties to a transaction from exercising all their rights and obligations under the transaction documents. This document cannot be reproduced except in full, without prior written approval of the Company. Any unauthorized alteration, forgery or falsification of the content or appearance of this document is unlawful and offenders may be prosecuted to the fullest extent of the law.

Contents

1. GENERAL PRODUCT INFORMATION	4
2. SYSTEM TEST CONFIGURATION	9
3. SUMMARY OF TEST RESULTS	12
4. DESCRIPTION OF TEST MODES	13
5. MEASUREMENT UNCERTAINTY	22
6. MAXMUM OUTPUT POWER	23
7. OCCUPIED BANDWIDTH MEASUREMENT	65
8. OUT OF BAND EMISSION AT ANTENNA TERMINALS	126
9. FIELD STRENGTH OF SPURIOUS RADIATION MEASUREMENT	238
10. FREQUENCY STABILITY MEASUREMENT	424
11. PEAK TO AVERAGE RATIO	433

Unless otherwise stated the results shown in this test report refer only to the sample(s) tested and such sample(s) are retained for 90 days only.

除非另有說明，此報告結果僅對測試之樣品負責，同時此樣品僅保留90天。本報告未經本公司書面許可，不可部份複製。

This document is issued by the Company subject to its General Conditions of Service printed overleaf, available on request or accessible at www.sgs.com/terms_and_conditions.htm and for electronic format documents, subject to Terms and Conditions for Electronic Documents at www.sgs.com/terms_e-document.htm. Attention is drawn to the limitation of liability, indemnification and jurisdiction issues defined therein. Any holder of this document is advised that information contained hereon reflects the Company's findings at the time of its intervention only and within the limits of Client's instructions, if any. The Company's sole responsibility is to its Client and this document does not exonerate parties to a transaction from exercising all their rights and obligations under the transaction documents. This document cannot be reproduced except in full, without prior written approval of the Company. Any unauthorized alteration, forgery or falsification of the content or appearance of this document is unlawful and offenders may be prosecuted to the fullest extent of the law.

1. GENERAL PRODUCT INFORMATION

1.1. Product Description

General:

Product Name:	Smart Phone
Hardware Version:	DVT
Software Version:	N/A
Power Supply:	3.85V from Rechargeable Li-ion Battery
Antenna Designation:	Inverted-F Antenna, Gain: -5.4dBi (GSM/GPRS 850, WCDMA B5, LTE B5), -2.0dBi (GSM/GPRS 1900, WCDMA B2, LTE B2), -3.7dBi (WCDMA B4, LTE B4), 0.5dBi (LTE B7, LTE B38), -7.8dBi (LTE B12, LTE B17), -6.6dBi (LTE B13)
IMEI:	004401116699923 / 004401116697935 / 004401116698016 004401116699873 / 004401116699766 / 004401116699485

Unless otherwise stated the results shown in this test report refer only to the sample(s) tested and such sample(s) are retained for 90 days only.

除非另有說明，此報告結果僅對測試之樣品負責，同時此樣品僅保留90天。本報告未經本公司書面許可，不可部份複製。

This document is issued by the Company subject to its General Conditions of Service printed overleaf, available on request or accessible at www.sgs.com/terms_and_conditions.htm and for electronic format documents, subject to Terms and Conditions for Electronic Documents at www.sgs.com/terms_e-document.htm. Attention is drawn to the limitation of liability, indemnification and jurisdiction issues defined therein. Any holder of this document is advised that information contained hereon reflects the Company's findings at the time of its intervention only and within the limits of Client's instructions, if any. The Company's sole responsibility is to its Client and this document does not exonerate parties to a transaction from exercising all their rights and obligations under the transaction documents. This document cannot be reproduced except in full, without prior written approval of the Company. Any unauthorized alteration, forgery or falsification of the content or appearance of this document is unlawful and offenders may be prosecuted to the fullest extent of the law.

1.2. GSM / WCDMA / LTE: Cellular Phone Standards Frequency Range

Operating Frequency (MHz)	
GSM/GPRS 850	824.2 - 848.8
GSM/GPRS 1900	1850.2 - 1909.8

Operating Frequency (MHz)	
WCDMA / HSPA+ Band II	1852.4 - 1907.6
WCDMA / HSPA+ Band IV	1712.4 - 1752.6
WCDMA / HSPA+ Band V	826.4 - 846.6

LTE Band	BW (MHz)	Operation Frequency (MHz)	LTE Band	BW (MHz)	Operation Frequency (MHz)
2	1.4	1850.7 - 1909.3	17	5	706.5 - 713.5
	3	1851.5 - 1908.5		10	709.0 - 711.0
	5	1852.5 - 1907.5	38	5	2572.5 - 2617.5
	10	1855.0 - 1905.0		10	2575.0 - 2615.0
	15	1857.5 - 1902.5		15	2577.5 - 2612.5
	20	1860.0 - 1900.0		20	2580.0 - 2610.0
4	1.4	1710.7 - 1754.3			
	3	1711.5 - 1753.5			
	5	1712.5 - 1752.5			
	10	1715.0 - 1780.0			
	15	1717.5 - 1747.5			
	20	1720.0 - 1745.0			
5	1.4	824.7 - 848.3			
	3	825.5 - 847.5			
	5	826.5 - 846.5			
	10	829.0 - 844.0			
7	5	2502.5 - 2567.5			
	10	2505.0 - 2565.0			
	15	2507.5 - 2562.5			
	20	2510.0 - 2560.0			
12	1.4	699.7 - 715.3			
	3	700.5 - 714.5			
	5	701.5 - 713.5			
	10	704.0 - 711.0			
13	5	779.5 - 784.5			
	10	782			

Unless otherwise stated the results shown in this test report refer only to the sample(s) tested and such sample(s) are retained for 90 days only.

除非另有說明，此報告結果僅對測試之樣品負責，同時此樣品僅保留90天。本報告未經本公司書面許可，不可部份複製。

This document is issued by the Company subject to its General Conditions of Service printed overleaf, available on request or accessible at www.sgs.com/terms_and_conditions.htm and for electronic format documents, subject to Terms and Conditions for Electronic Documents at www.sgs.com/terms_e-document.htm. Attention is drawn to the limitation of liability, indemnification and jurisdiction issues defined therein. Any holder of this document is advised that information contained hereon reflects the Company's findings at the time of its intervention only and within the limits of Client's instructions, if any. The Company's sole responsibility is to its Client and this document does not exonerate parties to a transaction from exercising all their rights and obligations under the transaction documents. This document cannot be reproduced except in full, without prior written approval of the Company. Any unauthorized alteration, forgery or falsification of the content or appearance of this document is unlawful and offenders may be prosecuted to the fullest extent of the law.

1.3. Type of Emission & Max ERP/EIRP Power Measurement Result:

	ERP / EIRP (dBm)		(W)	Type of Emission
GSM 850	24.52	ERP	0.283	249KGXW
GPRS 850	24.49	ERP	0.281	248KGXW
GSM 1900	27.03	EIRP	0.505	251KGXW
GPRS 1900	27.01	EIRP	0.502	246KGXW

	ERP / EIRP (dBm)		(W)	Type of Emission
WCDMA Band II	20.66	EIRP	0.116	4M16F9W
HSDPA Band II	19.64	EIRP	0.092	4M15F9W
HSUPA Band II	19.56	EIRP	0.090	4M16F9W
WCDMA Band IV	18.86	EIRP	0.077	4M72F9W
HSDPA Band IV	17.89	EIRP	0.062	4M71F9W
HSUPA Band IV	17.89	EIRP	0.062	4M71F9W
WCDMA Band V	15.42	ERP	0.035	4M15F9W
HSDPA Band V	14.39	ERP	0.027	4M14F9W
HSUPA Band V	14.35	ERP	0.027	4M13F9W

LTE Band	BW (MHz)	Modulation	ERP / EIRP (dBm)		(W)	Type of Emission
2	1.4	QPSK	20.30	EIRP	0.107	1M10G7D
	1.4	16QAM	19.29	EIRP	0.085	1M10D7W
	1.4	64QAM	18.52	EIRP	0.071	1M10D7W
	3	QPSK	20.40	EIRP	0.110	2M70G7D
	3	16QAM	19.70	EIRP	0.093	2M70D7W
	3	64QAM	19.10	EIRP	0.081	2M70D7W
	5	QPSK	20.38	EIRP	0.109	4M50G7D
	5	16QAM	19.70	EIRP	0.093	4M51D7W
	5	64QAM	19.19	EIRP	0.083	4M50D7W
	10	QPSK	20.37	EIRP	0.109	9M01G7D
	10	16QAM	19.77	EIRP	0.095	8M97D7W
	10	64QAM	19.30	EIRP	0.085	8M98D7W
	15	QPSK	20.39	EIRP	0.109	13M5G7D
	15	16QAM	19.72	EIRP	0.094	13M5D7W
	15	64QAM	19.21	EIRP	0.083	13M5D7W
	20	QPSK	20.53	EIRP	0.113	17M9G7D
20	16QAM	19.84	EIRP	0.096	18M0D7W	
20	64QAM	19.30	EIRP	0.085	18M0D7W	

LTE Band	BW (MHz)	Modulation	ERP / EIRP (dBm)		(W)	Type of Emission
4	1.4	QPSK	18.33	EIRP	0.068	1M09G7D
	1.4	16QAM	17.34	EIRP	0.054	1M10D7W
	1.4	64QAM	16.74	EIRP	0.047	1M10D7W
	3	QPSK	18.09	EIRP	0.064	2M70G7D
	3	16QAM	17.32	EIRP	0.054	2M70D7W
	3	64QAM	16.90	EIRP	0.049	2M70D7W
	5	QPSK	18.16	EIRP	0.065	4M51G7D
	5	16QAM	17.41	EIRP	0.055	4M51D7W
	5	64QAM	16.77	EIRP	0.048	4M51D7W
	10	QPSK	18.02	EIRP	0.063	8M97G7D
	10	16QAM	17.25	EIRP	0.053	8M97D7W
	10	64QAM	16.80	EIRP	0.048	8M97D7W
	15	QPSK	18.08	EIRP	0.064	13M5G7D
	15	16QAM	17.31	EIRP	0.054	13M5D7W
	15	64QAM	16.77	EIRP	0.048	13M5D7W
	20	QPSK	18.16	EIRP	0.065	18M0G7D
20	16QAM	17.42	EIRP	0.055	18M0D7W	
20	64QAM	16.90	EIRP	0.049	18M0D7W	

Unless otherwise stated the results shown in this test report refer only to the sample(s) tested and such sample(s) are retained for 90 days only.

除非另有說明，此報告結果僅對測試之樣品負責，同時此樣品僅保留90天。本報告未經本公司書面許可，不可部份複製。

This document is issued by the Company subject to its General Conditions of Service printed overleaf, available on request or accessible at www.sgs.com/terms_and_conditions.htm and for electronic format documents, subject to Terms and Conditions for Electronic Documents at www.sgs.com/terms_e-document.htm. Attention is drawn to the limitation of liability, indemnification and jurisdiction issues defined therein. Any holder of this document is advised that information contained hereon reflects the Company's findings at the time of its intervention only and within the limits of Client's instructions, if any. The Company's sole responsibility is to its Client and this document does not exonerate parties to a transaction from exercising all their rights and obligations under the transaction documents. This document cannot be reproduced except in full, without prior written approval of the Company. Any unauthorized alteration, forgery or falsification of the content or appearance of this document is unlawful and offenders may be prosecuted to the fullest extent of the law.

LTE Band	BW (MHz)	Modulation	ERP / EIRP (dBm)		(W)	Type of Emission
5	1.4	QPSK	14.99	ERP	0.032	1M09G7D
	1.4	16QAM	14.00	ERP	0.025	1M10D7W
	1.4	64QAM	13.27	ERP	0.021	1M10D7W
	3	QPSK	14.94	ERP	0.031	2M70G7D
	3	16QAM	14.60	ERP	0.029	2M70D7W
	3	64QAM	13.85	ERP	0.024	2M71D7W
	5	QPSK	14.97	ERP	0.031	4M51G7D
	5	16QAM	14.51	ERP	0.028	4M51D7W
	5	64QAM	13.86	ERP	0.024	4M51D7W
	10	QPSK	15.03	ERP	0.032	9M00G7D
	10	16QAM	14.65	ERP	0.029	9M00D7W
	10	64QAM	14.01	ERP	0.025	9M01D7W
7	5	QPSK	23.05	EIRP	0.202	4M50G7D
	5	16QAM	22.47	EIRP	0.177	4M50D7W
	5	64QAM	21.95	EIRP	0.157	4M51D7W
	10	QPSK	23.08	EIRP	0.203	9M00G7D
	10	16QAM	22.46	EIRP	0.176	8M98D7W
	10	64QAM	21.97	EIRP	0.157	8M98D7W
	15	QPSK	23.11	EIRP	0.205	13M5G7D
	15	16QAM	22.55	EIRP	0.180	13M5D7W
	15	64QAM	21.96	EIRP	0.157	13M5D7W
	20	QPSK	23.16	EIRP	0.207	17M9G7D
	20	16QAM	22.61	EIRP	0.182	18M0D7W
	20	64QAM	22.00	EIRP	0.158	17M9D7W
12	1.4	QPSK	12.67	ERP	0.018	1M10G7D
	1.4	16QAM	11.66	ERP	0.015	1M10D7W
	1.4	64QAM	11.10	ERP	0.013	1M10D7W
	3	QPSK	13.01	ERP	0.020	2M70G7D
	3	16QAM	12.33	ERP	0.017	2M71D7W
	3	64QAM	11.89	ERP	0.015	2M70D7W
	5	QPSK	13.00	ERP	0.020	4M50G7D
	5	16QAM	12.42	ERP	0.017	4M51D7W
	5	64QAM	11.89	ERP	0.015	4M51D7W
	10	QPSK	13.03	ERP	0.020	9M01G7D
	10	16QAM	12.44	ERP	0.018	8M98D7W
	10	64QAM	11.97	ERP	0.016	8M97D7W

LTE Band	BW (MHz)	Modulation	ERP / EIRP (dBm)		(W)	Type of Emission
13	5	QPSK	13.83	ERP	0.024	4M51G7D
	5	16QAM	13.14	ERP	0.021	4M51D7W
	5	64QAM	12.63	ERP	0.018	4M52D7W
	10	QPSK	13.74	ERP	0.024	9M01G7D
	10	16QAM	12.77	ERP	0.019	8M97D7W
	10	64QAM	12.23	ERP	0.017	8M96D7W
17	5	QPSK	12.63	ERP	0.018	4M50G7D
	5	16QAM	12.22	ERP	0.017	4M51D7W
	5	64QAM	11.41	ERP	0.014	4M51D7W
	10	QPSK	12.84	ERP	0.019	9M00G7D
	10	16QAM	12.09	ERP	0.016	8M98D7W
	10	64QAM	11.52	ERP	0.014	8M97D7W
38	5	QPSK	23.01	EIRP	0.200	4M51G7D
	5	16QAM	22.19	EIRP	0.166	4M51D7W
	5	64QAM	22.15	EIRP	0.164	4M51D7W
	10	QPSK	23.02	EIRP	0.200	8M97G7D
	10	16QAM	22.10	EIRP	0.162	8M99D7W
	10	64QAM	22.08	EIRP	0.161	8M99D7W
	15	QPSK	23.03	EIRP	0.201	13M5G7D
	15	16QAM	22.17	EIRP	0.165	13M5D7W
	15	64QAM	22.05	EIRP	0.160	13M5D7W
	20	QPSK	23.06	EIRP	0.202	18M0G7D
	20	16QAM	22.22	EIRP	0.167	17M9D7W
	20	64QAM	22.17	EIRP	0.165	17M9D7W

Unless otherwise stated the results shown in this test report refer only to the sample(s) tested and such sample(s) are retained for 90 days only.

除非另有說明，此報告結果僅對測試之樣品負責，同時此樣品僅保留90天。本報告未經本公司書面許可，不可部份複製。

This document is issued by the Company subject to its General Conditions of Service printed overleaf, available on request or accessible at www.sgs.com/terms_and_conditions.htm and for electronic format documents, subject to Terms and Conditions for Electronic Documents at www.sgs.com/terms_e-document.htm. Attention is drawn to the limitation of liability, indemnification and jurisdiction issues defined therein. Any holder of this document is advised that information contained hereon reflects the Company's findings at the time of its intervention only and within the limits of Client's instructions, if any. The Company's sole responsibility is to its Client and this document does not exonerate parties to a transaction from exercising all their rights and obligations under the transaction documents. This document cannot be reproduced except in full, without prior written approval of the Company. Any unauthorized alteration, forgery or falsification of the content or appearance of this document is unlawful and offenders may be prosecuted to the fullest extent of the law.

1.4. Test Methodology of Applied Standards

FCC 47 CFR Part 2, 22, 24, 27.

ANSI C63.26-2015

KDB971168 D01 Power Meas license Digital System v03

KDB941225 D01 SAR test for 3G devices v03r01 (SAR Measurement Procedures for 3G Devices, WCDMA / HSPA) was used for EUT and Base station setting.

KDB648474 D03 Wireless Chargers Battery Cover

TS 151 010-1 is used to set, and measure the output power.

Note: All test items have been performed and record as per the above standards.

1.5. Test Facility

Compliance Certification Services Inc. Wugu Lab. No.11, Wugong 6th Rd.,

Wugu Dist., New Taipei City 24891, Taiwan. (R.O.C.) (TAF code 1309)

FCC Designation number: TW1309

1.6. Special Accessories

No special accessories were used during testing.

1.7. Equipment Modifications

There were no modifications incorporated into the EUT.

Unless otherwise stated the results shown in this test report refer only to the sample(s) tested and such sample(s) are retained for 90 days only.

除非另有說明，此報告結果僅對測試之樣品負責，同時此樣品僅保留90天。本報告未經本公司書面許可，不可部份複製。

This document is issued by the Company subject to its General Conditions of Service printed overleaf, available on request or accessible at www.sgs.com/terms_and_conditions.htm and for electronic format documents, subject to Terms and Conditions for Electronic Documents at www.sgs.com/terms_e-document.htm. Attention is drawn to the limitation of liability, indemnification and jurisdiction issues defined therein. Any holder of this document is advised that information contained hereon reflects the Company's findings at the time of its intervention only and within the limits of Client's instructions, if any. The Company's sole responsibility is to its Client and this document does not exonerate parties to a transaction from exercising all their rights and obligations under the transaction documents. This document cannot be reproduced except in full, without prior written approval of the Company. Any unauthorized alteration, forgery or falsification of the content or appearance of this document is unlawful and offenders may be prosecuted to the fullest extent of the law.

2. SYSTEM TEST CONFIGURATION

2.1. EUT Configuration

The EUT configuration for testing is installed on RF field strength measurement to meet the Commissions requirement and operating in a manner which intends to maximize its emission characteristics in a continuous normal application.

2.2. EUT Exercise

The EUT (Transmitter) was operated in the continuous transmission mode employed with the simulator of the Base Station that fixates at test default channels to fix the Tx frequency which was for the purpose of the measurements.

2.3. Test Procedure

2.3.1 Conducted Measurement at Antenna Port

According to measurement procured ANSI C63.26-2015, the EUT is placed on a turn table which is 0.8 m above ground plane. A low loss of RF cable was used to connect the antenna port of EUT to measurement equipment.

2.3.2 Radiated Emissions (ERP/EIRP)

According to measurement procured ANSI C63.26-2015, The EUT is a placed on as turn table, for emission measurements below 1 GHz is 0.8 m above ground plane, for emission measurements above 1 GHz, the table height shall be 1.5 m. The turn table shall rotate 360 degrees to determine the position of maximum emission level. EUT is set 3m away from the receiving antenna which varied from 1m to 4m to find out the highest emission. And also, each emission was to be maximized by changing the polarization of receiving antenna both Horizontal and Vertical. In order to find out the max. emission, the relative positions of this hand-held transmitter (EUT) was rotated through three orthogonal axes and measurement procedures for electric field radiated emissions above 1 GHz the EUT measurement is to be made “while keeping the antenna in the ‘cone of radiation’ from that area and pointed at the area both in azimuth and elevation, with polarization oriented for maximum response.” is still within the 3dB illumination BW of the measurement antenna according to the requirements in Section 8 and 13.

2.4. Measurement Results Explanation Example

For all conducted test items:

The offset level is set in the spectrum analyzer to compensate the RF cable loss and attenuation factor between EUT conducted port and spectrum analyzer. With the offset compensation, the spectrum analyzer reading level is exactly EUT RF output level.

Unless otherwise stated the results shown in this test report refer only to the sample(s) tested and such sample(s) are retained for 90 days only.

除非另有說明，此報告結果僅對測試之樣品負責，同時此樣品僅保留90天。本報告未經本公司書面許可，不可部份複製。

This document is issued by the Company subject to its General Conditions of Service printed overleaf, available on request or accessible at www.sgs.com/terms_and_conditions.htm and for electronic format documents, subject to Terms and Conditions for Electronic Documents at www.sgs.com/terms_e-document.htm. Attention is drawn to the limitation of liability, indemnification and jurisdiction issues defined therein. Any holder of this document is advised that information contained hereon reflects the Company's findings at the time of its intervention only and within the limits of Client's instructions, if any. The Company's sole responsibility is to its Client and this document does not exonerate parties to a transaction from exercising all their rights and obligations under the transaction documents. This document cannot be reproduced except in full, without prior written approval of the Company. Any unauthorized alteration, forgery or falsification of the content or appearance of this document is unlawful and offenders may be prosecuted to the fullest extent of the law.

Note:

The spectrum analyzer offset is derived from RF cable loss and attenuator factor.

Following shows an offset computation in physical test.

	RF cable loss (dB)	Attenuation factor(dB)	offset(dB)
Low Band (Below 1GHz)	0.2	14.8	15
High Band (Above 1 GHz)	0.5	14.5	15

2.5. Final Amplifier Voltage and Current Information:

Test Mode	DC voltage (V)	DC current (mA)
GSM 850	3.85	620
GSM 1900		688
HSUPA B2		695
HSDPA B4		646
HSDPA B5		675
LTE Band 2		695
LTE Band 4		693
LTE Band 5		685
LTE Band 7		699
LTE Band 12		690
LTE Band 13		697
LTE Band 17		688
LTE Band 38		690

Unless otherwise stated the results shown in this test report refer only to the sample(s) tested and such sample(s) are retained for 90 days only.

除非另有說明，此報告結果僅對測試之樣品負責，同時此樣品僅保留90天。本報告未經本公司書面許可，不可部份複製。

This document is issued by the Company subject to its General Conditions of Service printed overleaf, available on request or accessible at www.sgs.com/terms_and_conditions.htm and for electronic format documents, subject to Terms and Conditions for Electronic Documents at www.sgs.com/terms_e-document.htm. Attention is drawn to the limitation of liability, indemnification and jurisdiction issues defined therein. Any holder of this document is advised that information contained hereon reflects the Company's findings at the time of its intervention only and within the limits of Client's instructions, if any. The Company's sole responsibility is to its Client and this document does not exonerate parties to a transaction from exercising all their rights and obligations under the transaction documents. This document cannot be reproduced except in full, without prior written approval of the Company. Any unauthorized alteration, forgery or falsification of the content or appearance of this document is unlawful and offenders may be prosecuted to the fullest extent of the law.

2.6. Configuration of Tested System

Fig. 2-1 Configuration of Tested System (Fixed Channel-Conducted)

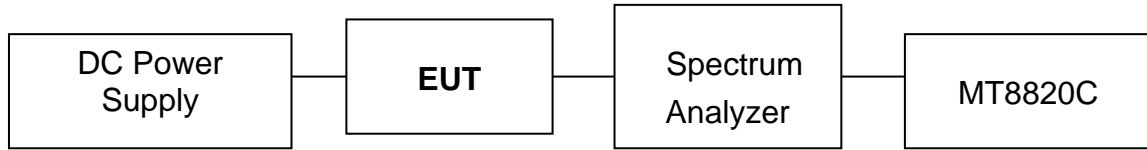

Fig. 2-2 Configuration of Tested System (Fixed Channel-Radiated)

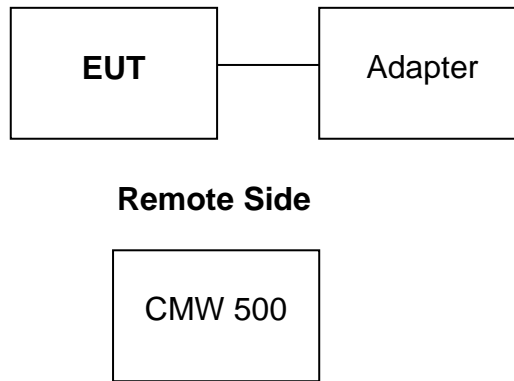

Fig. 2-3 Configuration of Tested System (Fixed Channel-Radiated, Wireless Charging Mode)

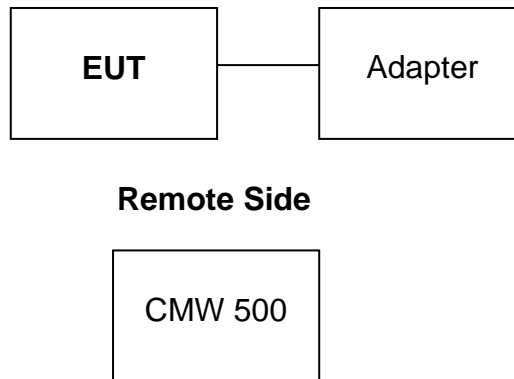

Table 2-1 Equipment Used in

Item	Equipment	Mfr/Brand	Model/ Type No.	Series No.	Data Cable	Power Cord
1.	Wideband Radio Communication Tester	R&S	CMW 500	116875	shielded	Un-shielded
2.	DC Power Supply	Anritsu	E3640A	KR93300208	N/A	Unshielded

Unless otherwise stated the results shown in this test report refer only to the sample(s) tested and such sample(s) are retained for 90 days only.

除非另有說明，此報告結果僅對測試之樣品負責，同時此樣品僅保留90天。本報告未經本公司書面許可，不可部份複製。

This document is issued by the Company subject to its General Conditions of Service printed overleaf, available on request or accessible at www.sgs.com/terms_and_conditions.htm and for electronic format documents, subject to Terms and Conditions for Electronic Documents at www.sgs.com/terms_e-document.htm. Attention is drawn to the limitation of liability, indemnification and jurisdiction issues defined therein. Any holder of this document is advised that information contained hereon reflects the Company's findings at the time of its intervention only and within the limits of Client's instructions, if any. The Company's sole responsibility is to its Client and this document does not exonerate parties to a transaction from exercising all their rights and obligations under the transaction documents. This document cannot be reproduced except in full, without prior written approval of the Company. Any unauthorized alteration, forgery or falsification of the content or appearance of this document is unlawful and offenders may be prosecuted to the fullest extent of the law.

3. SUMMARY OF TEST RESULTS

FCC Rules	Description Of Test	Result
§2.1046(a)	RF Power Output	Compliant
§2.1046(a) §22.913(a)(5) §24.232(c) §27.50(a)(3) §27.50(c)(10) §27.50(d)(4)	ERP/ EIRP measurement	Compliant
§2.1049(h)	99% & 26dB Occupied Bandwidth	Compliant
§2.1051 §22.917(a) §24.238(a) §27.53(g) §27.50(c)(5) §27.53(h) §27.53(m)(4)(6)	Out of Band Emissions at Antenna Terminals and Band Edge / Emission mask requirements	Compliant
§2.1053 §22.917(a) §24.238(a) §27.53(c)(2),(4) §27.50(c)(5) §27.53(f) §27.53(g) §27.53(h) §27.53(m)(4)	Field Strength of Spurious Radiation	Compliant
§24.232(d) §27.50((B)	Peak to Average Ratio	Compliant
§2.1055(a)(1) §22.355 §24.235 §27.54	Frequency Stability	Compliant

Unless otherwise stated the results shown in this test report refer only to the sample(s) tested and such sample(s) are retained for 90 days only.

除非另有說明，此報告結果僅對測試之樣品負責，同時此樣品僅保留90天。本報告未經本公司書面許可，不可部份複製。

This document is issued by the Company subject to its General Conditions of Service printed overleaf, available on request or accessible at www.sgs.com/terms_and_conditions.htm and for electronic format documents, subject to Terms and Conditions for Electronic Documents at www.sgs.com/terms_e-document.htm. Attention is drawn to the limitation of liability, indemnification and jurisdiction issues defined therein. Any holder of this document is advised that information contained hereon reflects the Company's findings at the time of its intervention only and within the limits of Client's instructions, if any. The Company's sole responsibility is to its Client and this document does not exonerate parties to a transaction from exercising all their rights and obligations under the transaction documents. This document cannot be reproduced except in full, without prior written approval of the Company. Any unauthorized alteration, forgery or falsification of the content or appearance of this document is unlawful and offenders may be prosecuted to the fullest extent of the law.

4. DESCRIPTION OF TEST MODES

4.1. The Worst Test Modes and Channel Details

1. The EUT has been tested under operating condition.
2. Pre-Scan has been conducted to determine the worst-case mode from all possible combinations between available modulations, data rates, X(E1)Y(E2)Z(H) axis and antenna ports. The worst case was found as listed below. Following channel(s) was (were) selected for the final test as listed below:

BAND	RADIATED EMISSION	RADIATED EMISSION (Wireless Charging Mode)
GSM/GPRS 850	E1-plan	E2-plan
GSM/GPRS 1900	E1-plan	E2-plan
WCDMA/HSPA Band II	E1-plan	E2-plan
WCDMA/HSPA Band IV	E1-plan	E2-plan
WCDMA/HSPA Band V	E1-plan	E2-plan
LTE Band 2	E1-plan	E2-plan
LTE Band 4	E1-plan	E2-plan
LTE Band 5	E1-plan	E2-plan
LTE Band 7	E1-plan	E2-plan
LTE Band 12	E1-plan	E2-plan
LTE Band 13	E1-plan	E2-plan
LTE Band 17	E1-plan	E2-plan
LTE Bnad 38	E1-plan	E2-plan

Note: Additional emissions testing were performed per KDB 648474 D03 and reported herein and identified as WPC. Per KDB 648474 D03, spurious emissions measurement data was also investigated with the wireless charging battery cover.

Unless otherwise stated the results shown in this test report refer only to the sample(s) tested and such sample(s) are retained for 90 days only.

除非另有說明，此報告結果僅對測試之樣品負責，同時此樣品僅保留90天。本報告未經本公司書面許可，不可部份複製。

This document is issued by the Company subject to its General Conditions of Service printed overleaf, available on request or accessible at www.sgs.com/terms_and_conditions.htm and for electronic format documents, subject to Terms and Conditions for Electronic Documents at www.sgs.com/terms_e-document.htm. Attention is drawn to the limitation of liability, indemnification and jurisdiction issues defined therein. Any holder of this document is advised that information contained hereon reflects the Company's findings at the time of its intervention only and within the limits of Client's instructions, if any. The Company's sole responsibility is to its Client and this document does not exonerate parties to a transaction from exercising all their rights and obligations under the transaction documents. This document cannot be reproduced except in full, without prior written approval of the Company. Any unauthorized alteration, forgery or falsification of the content or appearance of this document is unlawful and offenders may be prosecuted to the fullest extent of the law.

GSM/GPRS MODE

TEST ITEM	AVAILABLE CHANNEL	TESTED CHANNEL	MODE
ERP	128 to 251	128, 190, 251	GSM/GPRS 850
EIRP	512 to 810	512, 661, 810	GSM/GPRS 1900
FREQUENCY STABILITY	128 to 251 512 to 810	190 661	GPRS 850 GPRS 1900
OCCUPIED BANDWIDTH	128 to 251 512 to 810	190 661	GSM/GPRS 850 GSM/GPRS 1900
PEAK TO AVERAGE RATIO	512 to 810	512, 661, 810	GSM/GPRS 1900
BAND EDGE	128 to 251 512 to 810	128, 251 512, 810	GSM/GPRS 850 GSM/GPRS 1900
CONDCUDED EMISSION	128 to 251 512 to 810	128, 190, 251 512, 661, 810	GSM/GPRS 850 GSM/GPRS 1900
RADIATED EMISSION	128 to 251 512 to 810	128, 190, 251 512, 661, 810	GSM 850 GSM 1900

WCDMA/HSPA MODE

TEST ITEM	AVAILABLE CHANNEL	TESTED CHANNEL	MODE
ERP	4132 to 4233	4132, 4183, 4233	WCDMA/HSPA Band V
EIRP	9262 to 9538 1312 to 1513	1312, 1413, 1513 9262, 9400, 9538	WCDMA/HSPA Band II WCDMA/HSPA Band IV
FREQUENCY STABILITY	4132 to 4233 1312 to 1513 9262 to 9538	4183 1413 9400	WCDMA Band II WCDMA Band IV WCDMA Band V
OCCUPIED BANDWIDTH	4132 to 4233 1312 to 1513 9262 to 9538	4132, 4183, 4233 1312, 1413, 1513 9262, 9400, 9538	WCDMA/HSPA Band II WCDMA/HSPA Band IV WCDMA/HSPA Band V
PEAK TO AVERAGE RATIO	4132 to 4233 1312 to 1513	4132, 4183, 4233 1312, 1413, 1513	WCDMA/HSPA Band II WCDMA/HSPA Band IV
BAND EDGE	4132 to 4233 1312 to 1513 9262 to 9538	4132, 4233 1312, 1513 9262, 9538	WCDMA Band II WCDMA Band IV WCDMA Band V
CONDCUDED EMISSION	4132 to 4233 1312 to 1513 9262 to 9538	4132, 4183, 4233 1312, 1413, 1513 9262, 9400, 9538	WCDMA Band II WCDMA Band IV WCDMA Band V
RADIATED EMISSION	4132 to 4233 1312 to 1513 9262 to 9538	4132, 4183, 4233 1312, 1413, 1513 9262, 9400, 9538	WCDMA Band II WCDMA Band IV WCDMA Band V

Unless otherwise stated the results shown in this test report refer only to the sample(s) tested and such sample(s) are retained for 90 days only.

除非另有說明，此報告結果僅對測試之樣品負責，同時此樣品僅保留90天。本報告未經本公司書面許可，不可部份複製。

This document is issued by the Company subject to its General Conditions of Service printed overleaf, available on request or accessible at www.sgs.com/terms_and_conditions.htm and for electronic format documents, subject to Terms and Conditions for Electronic Documents at www.sgs.com/terms_e-document.htm. Attention is drawn to the limitation of liability, indemnification and jurisdiction issues defined therein. Any holder of this document is advised that information contained hereon reflects the Company's findings at the time of its intervention only and within the limits of Client's instructions, if any. The Company's sole responsibility is to its Client and this document does not exonerate parties to a transaction from exercising all their rights and obligations under the transaction documents. This document cannot be reproduced except in full, without prior written approval of the Company. Any unauthorized alteration, forgery or falsification of the content or appearance of this document is unlawful and offenders may be prosecuted to the fullest extent of the law.

LTE Band 2 MODE

TEST ITEM	AVAILABLE CHANNEL	TESTED CHANNEL	CHANNEL BANDWIDTH	MODULATION	MODE
EIRP	18607 to 19193	18607, 18900, 19193	1.4MHz	QPSK, 16QAM, 64QAM	1 RB/ 0,5 RB Offest
	18615 to 19185	18615, 18900, 19185	3MHz	QPSK, 16QAM, 64QAM	1 RB/ 0,14 RB Offest
	18625 to 19175	18625, 18900, 19175	5MHz	QPSK, 16QAM, 64QAM	1 RB/ 0,24 RB Offest
	18650 to 19150	18650, 18900, 19150	10MHz	QPSK, 16QAM, 64QAM	1 RB/ 0,49 RB Offest
	18675 to 19125	18675, 18900, 19125	15MHz	QPSK, 16QAM, 64QAM	1 RB/ 0,74 RB Offest
	18700 to 19100	18700, 18900, 19100	20MHz	QPSK, 16QAM, 64QAM	1 RB/ 0,99 RB Offest
FREQUENCY STABILITY	18650 to 19150	18900	10MHz	QPSK	Full RB
OCCUPIED BANDWIDTH	18607 to 19193	18607, 18900, 19193	1.4MHz	QPSK, 16QAM, 64QAM	Full RB
	18615 to 19185	18615, 18900, 19185	3MHz	QPSK, 16QAM, 64QAM	Full RB
	18625 to 19175	18625, 18900, 19175	5MHz	QPSK, 16QAM, 64QAM	Full RB
	18650 to 19150	18650, 18900, 19150	10MHz	QPSK, 16QAM, 64QAM	Full RB
	18675 to 19125	18675, 18900, 19125	15MHz	QPSK, 16QAM, 64QAM	Full RB
	18700 to 19100	18700, 18900, 19100	20MHz	QPSK, 16QAM, 64QAM	Full RB
PEAK TO AVERAGE RATIO	18607 to 19193	18607, 18900, 19193	1.4MHz	64QAM	Full RB
	18615 to 19185	18615, 18900, 19185	3MHz	64QAM	Full RB
	18625 to 19175	18625, 18900, 19175	5MHz	64QAM	Full RB
	18650 to 19150	18650, 18900, 19150	10MHz	64QAM	Full RB
	18675 to 19125	18675, 18900, 19125	15MHz	64QAM	Full RB
	18700 to 19100	18700, 18900, 19100	20MHz	64QAM	Full RB
BAND EDGE	18607 to 19193	18607, 19193	1.4MHz	QPSK	1 RB/ 0,5 RB Offes Full RB
	18615 to 19185	18615, 19185	3MHz	QPSK	1 RB/ 0,14 RB Offest Full RB
	18625 to 19175	18625, 19175	5MHz	QPSK	1 RB/ 0,24 RB Offest Full RB
	18650 to 19150	18650, 19150	10MHz	QPSK	1 RB/ 0,49 RB Offest Full RB
	18675 to 19125	18675, 19125	15MHz	QPSK	1 RB/ 0,74 RB Offest Full RB
	18700 to 19100	18700, 19100	20MHz	QPSK	1 RB/ 0,99 RB Offest Full RB
CONDCUDED EMISSION	18607 to 19193	18607, 18900, 19193	1.4MHz	QPSK	1 RB, 0 RB Offest
	18615 to 19185	18615, 18900, 19185	3MHz	QPSK	1 RB, 0 RB Offest
	18625 to 19175	18625, 18900, 19175	5MHz	QPSK	1 RB, 0 RB Offest
	18650 to 19150	18650, 18900, 19150	10MHz	QPSK	1 RB, 0 RB Offest
	18675 to 19125	18675, 18900, 19125	15MHz	QPSK	1 RB, 0 RB Offest
	18700 to 19100	18700, 18900, 19100	20MHz	QPSK	1 RB, 0 RB Offest
RADIATED EMISSION	18700 to 19100	18700, 18900, 19100	20MHz	QPSK	1 RB, 0 RB Offest

Unless otherwise stated the results shown in this test report refer only to the sample(s) tested and such sample(s) are retained for 90 days only.

除非另有說明，此報告結果僅對測試之樣品負責，同時此樣品僅保留90天。本報告未經本公司書面許可，不可部份複製。

This document is issued by the Company subject to its General Conditions of Service printed overleaf, available on request or accessible at www.sgs.com/terms_and_conditions.htm and for electronic format documents, subject to Terms and Conditions for Electronic Documents at www.sgs.com/terms_e-document.htm. Attention is drawn to the limitation of liability, indemnification and jurisdiction issues defined therein. Any holder of this document is advised that information contained hereon reflects the Company's findings at the time of its intervention only and within the limits of Client's instructions, if any. The Company's sole responsibility is to its Client and this document does not exonerate parties to a transaction from exercising all their rights and obligations under the transaction documents. This document cannot be reproduced except in full, without prior written approval of the Company. Any unauthorized alteration, forgery or falsification of the content or appearance of this document is unlawful and offenders may be prosecuted to the fullest extent of the law.

LTE Band 4 MODE

TEST ITEM	AVAILABLE CHANNEL	TESTED CHANNEL	CHANNEL BANDWIDTH	MODULATION	MODE
EIRP	19957 to 19393	19957, 20175, 19393	1.4MHz	QPSK, 16QAM, 64QAM	1 RB/ 0,5 RB Offest
	19965 to 22385	19965, 20175, 22385	3MHz	QPSK, 16QAM, 64QAM	1 RB/ 0,14 RB Offest
	19975 to 20375	19975, 20175, 20375	5MHz	QPSK, 16QAM, 64QAM	1 RB/ 0,24 RB Offest
	20000 to 20350	20000, 20175, 20350	10MHz	QPSK, 16QAM, 64QAM	1 RB/ 0,49 RB Offest
	20025 to 20325	20025, 20175, 20325	15MHz	QPSK, 16QAM, 64QAM	1 RB/ 0,74 RB Offest
	20050 to 20300	20050, 20175, 20300	20MHz	QPSK, 16QAM, 64QAM	1 RB/ 0,99 RB Offest
FREQUENCY STABILITY	20000 to 20350	20175	10MHz	QPSK	Full RB
OCCUPIED BANDWIDTH	19957 to 19393	19957, 20175, 19393	1.4MHz	QPSK, 16QAM, 64QAM	Full RB
	19965 to 22385	19965, 20175, 22385	3MHz	QPSK, 16QAM, 64QAM	Full RB
	19975 to 20375	19975, 20175, 20375	5MHz	QPSK, 16QAM, 64QAM	Full RB
	20000 to 20350	20000, 20175, 20350	10MHz	QPSK, 16QAM, 64QAM	Full RB
	20025 to 20325	20025, 20175, 20325	15MHz	QPSK, 16QAM, 64QAM	Full RB
	20050 to 20300	20050, 20175, 20300	20MHz	QPSK, 16QAM, 64QAM	Full RB
PEAK TO AVERAGE RATIO	19957 to 19393	19957, 20175, 19393	1.4MHz	64QAM	Full RB
	19965 to 22385	19965, 20175, 22385	3MHz	64QAM	Full RB
	19975 to 20375	19975, 20175, 20375	5MHz	64QAM	Full RB
	20000 to 20350	20000, 20175, 20350	10MHz	64QAM	Full RB
	20025 to 20325	20025, 20175, 20325	15MHz	64QAM	Full RB
	20050 to 20300	20050, 20175, 20300	20MHz	64QAM	Full RB
BAND EDGE	19957 to 19393	19957, 19393	1.4MHz	QPSK	1 RB/ 0,5 RB Offes Full RB
	19965 to 22385	19965, 22385	3MHz	QPSK	1 RB/ 0,14 RB Offest Full RB
	19975 to 20375	19975, 20375	5MHz	QPSK	1 RB/ 0,24 RB Offest Full RB
	20000 to 20350	20000, 20350	10MHz	QPSK	1 RB/ 0,49 RB Offest Full RB
	20025 to 20325	20025, 20325	15MHz	QPSK	1 RB/ 0,74 RB Offest Full RB
	20050 to 20300	20050, 20300	20MHz	QPSK	1 RB/ 0,99 RB Offest Full RB
CONDCUDED EMISSION	19957 to 19393	19957, 20175, 19393	1.4MHz	QPSK	1 RB, 0 RB Offest
	19965 to 22385	19965, 20175, 22385	3MHz	QPSK	1 RB, 0 RB Offest
	19975 to 20375	19975, 20175, 20375	5MHz	QPSK	1 RB, 0 RB Offest
	20000 to 20350	20000, 20175, 20350	10MHz	QPSK	1 RB, 0 RB Offest
	20025 to 20325	20025, 20175, 20325	15MHz	QPSK	1 RB, 0 RB Offest
	20050 to 20300	20050, 20175, 20300	20MHz	QPSK	1 RB, 0 RB Offest
RADIATED EMISSION	19957 to 19393	19957, 20175, 19393	1.4MHz	QPSK	1 RB, 0 RB Offest

Unless otherwise stated the results shown in this test report refer only to the sample(s) tested and such sample(s) are retained for 90 days only.

除非另有說明，此報告結果僅對測試之樣品負責，同時此樣品僅保留90天。本報告未經本公司書面許可，不可部份複製。

This document is issued by the Company subject to its General Conditions of Service printed overleaf, available on request or accessible at www.sgs.com/terms_and_conditions.htm and for electronic format documents, subject to Terms and Conditions for Electronic Documents at www.sgs.com/terms_e-document.htm. Attention is drawn to the limitation of liability, indemnification and jurisdiction issues defined therein. Any holder of this document is advised that information contained hereon reflects the Company's findings at the time of its intervention only and within the limits of Client's instructions, if any. The Company's sole responsibility is to its Client and this document does not exonerate parties to a transaction from exercising all their rights and obligations under the transaction documents. This document cannot be reproduced except in full, without prior written approval of the Company. Any unauthorized alteration, forgery or falsification of the content or appearance of this document is unlawful and offenders may be prosecuted to the fullest extent of the law.

LTE Band 5 MODE

TEST ITEM	AVAILABLE CHANNEL	TESTED CHANNEL	CHANNEL BANDWIDTH	MODULATION	MODE
ERP	20470 to 20643	20470, 20525, 20643	1.4MHz	QPSK, 16QAM, 64QAM	1 RB/ 0,5 RB Offest
	20415 to 20635	20415, 20525, 20635	3MHz	QPSK, 16QAM, 64QAM	1 RB/ 0,14 RB Offest
	20425 to 20625	20425, 20525, 20625	5MHz	QPSK, 16QAM, 64QAM	1 RB/ 0,24 RB Offest
	20450 to 20600	20450, 20525, 20600	10MHz	QPSK, 16QAM, 64QAM	1 RB/ 0,49 RB Offest
FREQUENCY STABILITY	20450 to 20600	20525	10MHz	QPSK	Full RB
OCCUPIED BANDWIDTH	20470 to 20643	20470, 20525, 20643	1.4MHz	QPSK, 16QAM, 64QAM	Full RB
	20415 to 20635	20415, 20525, 20635	3MHz	QPSK, 16QAM, 64QAM	Full RB
	20425 to 20625	20425, 20525, 20625	5MHz	QPSK, 16QAM, 64QAM	Full RB
	20450 to 20600	20450, 20525, 20600	10MHz	QPSK, 16QAM, 64QAM	Full RB
BAND EDGE	20470 to 20643	20470, 20643	1.4MHz	QPSK	1 RB/ 0,5 RB Offes Full RB
	20415 to 20635	20415, 20635	3MHz	QPSK	1 RB/ 0,14 RB Offest Full RB
	20425 to 20625	20425, 20625	5MHz	QPSK	1 RB/ 0,24 RB Offest Full RB
	20450 to 20600	20450, 20600	10MHz	QPSK	1 RB/ 0,49 RB Offest Full RB
CONDCUDED EMISSION	20470 to 20643	20470, 20525, 20643	1.4MHz	QPSK	1 RB, 0 RB Offest
	20415 to 20635	20415, 20525, 20635	3MHz	QPSK	1 RB, 0 RB Offest
	20425 to 20625	20425, 20525, 20625	5MHz	QPSK	1 RB, 0 RB Offest
	20450 to 20600	20450, 20525, 20600	10MHz	QPSK	1 RB, 0 RB Offest
RADIATED EMISSION	20450 to 20600	20450, 20525, 20600	10MHz	QPSK	1 RB, 0 RB Offest

Unless otherwise stated the results shown in this test report refer only to the sample(s) tested and such sample(s) are retained for 90 days only.

除非另有說明，此報告結果僅對測試之樣品負責，同時此樣品僅保留90天。本報告未經本公司書面許可，不可部份複製。

This document is issued by the Company subject to its General Conditions of Service printed overleaf, available on request or accessible at www.sgs.com/terms_and_conditions.htm and for electronic format documents, subject to Terms and Conditions for Electronic Documents at www.sgs.com/terms_e-document.htm. Attention is drawn to the limitation of liability, indemnification and jurisdiction issues defined therein. Any holder of this document is advised that information contained hereon reflects the Company's findings at the time of its intervention only and within the limits of Client's instructions, if any. The Company's sole responsibility is to its Client and this document does not exonerate parties to a transaction from exercising all their rights and obligations under the transaction documents. This document cannot be reproduced except in full, without prior written approval of the Company. Any unauthorized alteration, forgery or falsification of the content or appearance of this document is unlawful and offenders may be prosecuted to the fullest extent of the law.

LTE Band 7 MODE

TEST ITEM	AVAILABLE CHANNEL	TESTED CHANNEL	CHANNEL BANDWIDTH	MODULATION	MODE
EIRP	20775 to 21425	20775, 21100, 21425	5MHz	QPSK, 16QAM, 64QAM	1 RB/ 0,24 RB Offest
	20800 to 21400	20800, 21100, 21400	10MHz	QPSK, 16QAM, 64QAM	1 RB/ 0,49 RB Offest
	20850 to 21375	20850, 21100, 21375	15MHz	QPSK, 16QAM, 64QAM	1 RB/ 0,74 RB Offest
	20850 to 21350	20850, 21100, 21350	20MHz	QPSK, 16QAM, 64QAM	1 RB/ 0,99 RB Offest
FREQUENCY STABILITY	20800 to 21400	21100	10MHz	QPSK	Full RB
OCCUPIED BANDWIDTH	20775 to 21425	20775, 21100, 21425	5MHz	QPSK, 16QAM, 64QAM	Full RB
	20800 to 21400	20800, 21100, 21400	10MHz	QPSK, 16QAM, 64QAM	Full RB
	20850 to 21375	20850, 21100, 21375	15MHz	QPSK, 16QAM, 64QAM	Full RB
	20850 to 21350	20850, 21100, 21350	20MHz	QPSK, 16QAM, 64QAM	Full RB
PEAK TO AVERAGE RATIO	20775 to 21425	20775, 21100, 21425	5MHz	64QAM	Full RB
	20800 to 21400	20800, 21100, 21400	10MHz	64QAM	Full RB
	20850 to 21375	20850, 21100, 21375	15MHz	64QAM	Full RB
	20850 to 21350	20850, 21100, 21350	20MHz	64QAM	Full RB
BAND EDGE	20775 to 21425	20775, 21100, 21425	5MHz	QPSK	1 RB/ 0,24 RB Offest Full RB
	20800 to 21400	20800, 21100, 21400	10MHz	QPSK	1 RB/ 0,49 RB Offest Full RB
	20850 to 21375	20850, 21100, 21375	15MHz	QPSK	1 RB/ 0,74 RB Offest Full RB
	20850 to 21350	20850, 21100, 21350	20MHz	QPSK	1 RB/ 0,99 RB Offest Full RB
CONDUCTED EMISSION	20775 to 21425	20775, 21100, 21425	5MHz	QPSK	1 RB, 0 RB Offest
	20800 to 21400	20800, 21100, 21400	10MHz	QPSK	1 RB, 0 RB Offest
	20850 to 21375	20850, 21100, 21375	15MHz	QPSK	1 RB, 0 RB Offest
	20850 to 21350	20850, 21100, 21350	20MHz	QPSK	1 RB, 0 RB Offest
RADIATED EMISSION	20850 to 21350	20850, 21100, 21350	20MHz	QPSK	1 RB, 99 RB Offest
EMISSION MASK	20775 to 21425	20775, 21100, 21425	5MHz	QPSK	1 RB/ 0,24 RB Offest 25 RB/ 0 Offset
	20800 to 21400	20800, 21100, 21400	10MHz	QPSK	1 RB/ 0,49 RB Offest 50 RB/ 0 Offset
	20850 to 21375	20850, 21100, 21375	15MHz	QPSK	1 RB/ 0,74 RB Offest 75 RB/ 0 Offset
	20850 to 21350	20850, 21100, 21350	20MHz	QPSK	1 RB/ 0,99 RB Offest 100 RB/ 0 Offset

Unless otherwise stated the results shown in this test report refer only to the sample(s) tested and such sample(s) are retained for 90 days only.

除非另有說明，此報告結果僅對測試之樣品負責，同時此樣品僅保留90天。本報告未經本公司書面許可，不可部份複製。

This document is issued by the Company subject to its General Conditions of Service printed overleaf, available on request or accessible at www.sgs.com/terms_and_conditions.htm and for electronic format documents, subject to Terms and Conditions for Electronic Documents at www.sgs.com/terms_e-document.htm. Attention is drawn to the limitation of liability, indemnification and jurisdiction issues defined therein. Any holder of this document is advised that information contained hereon reflects the Company's findings at the time of its intervention only and within the limits of Client's instructions, if any. The Company's sole responsibility is to its Client and this document does not exonerate parties to a transaction from exercising all their rights and obligations under the transaction documents. This document cannot be reproduced except in full, without prior written approval of the Company. Any unauthorized alteration, forgery or falsification of the content or appearance of this document is unlawful and offenders may be prosecuted to the fullest extent of the law.

LTE Band 12 MODE

TEST ITEM	AVAILABLE CHANNEL	TESTED CHANNEL	CHANNEL BANDWIDTH	MODULATION	MODE
ERP	23017 to 23173	23017, 23095, 23173	1.4MHz	QPSK, 16QAM, 64QAM	1 RB/ 0,5 RB Offest
	23025 to 23165	23025, 23095, 23165	3MHz	QPSK, 16QAM, 64QAM	1 RB/ 0,14 RB Offest
	23035 to 23155	23035, 23095, 23155	5MHz	QPSK, 16QAM, 64QAM	1 RB/ 0,24 RB Offest
	23060 to 23130	23060, 23095, 23130	10MHz	QPSK, 16QAM, 64QAM	1 RB/ 0,49 RB Offest
FREQUENCY STABILITY	23060 to 23130	23095	10MHz	QPSK	Full RB
OCCUPIED BANDWIDTH	23017 to 23173	23017, 23095, 23173	1.4MHz	QPSK, 16QAM, 64QAM	Full RB
	23025 to 23165	23025, 23095, 23165	3MHz	QPSK, 16QAM, 64QAM	Full RB
	23035 to 23155	23035, 23095, 23155	5MHz	QPSK, 16QAM, 64QAM	Full RB
	23060 to 23130	23060, 23095, 23130	10MHz	QPSK, 16QAM, 64QAM	Full RB
PEAK TO AVERAGE RATIO	23017 to 23173	23017, 23095, 23173	1.4MHz	64QAM	Full RB
	23025 to 23165	23025, 23095, 23165	3MHz	64QAM	Full RB
	23035 to 23155	23035, 23095, 23155	5MHz	64QAM	Full RB
	23060 to 23130	23060, 23095, 23130	10MHz	64QAM	Full RB
BAND EDGE	23017 to 23173	23017, 23095, 23173	1.4MHz	QPSK	1 RB/ 0,5 RB Offes Full RB
	23025 to 23165	23025, 23095, 23165	3MHz	QPSK	1 RB/ 0,14 RB Offest Full RB
	23035 to 23155	23035, 23095, 23155	5MHz	QPSK	1 RB/ 0,24 RB Offest Full RB
	23060 to 23130	23060, 23095, 23130	10MHz	QPSK	1 RB/ 0,49 RB Offest Full RB
CONDUCTED EMISSION	23017 to 23173	23017, 23095, 23173	1.4MHz	QPSK	1 RB, 0 RB Offest
	23025 to 23165	23025, 23095, 23165	3MHz	QPSK	1 RB, 0 RB Offest
	23035 to 23155	23035, 23095, 23155	5MHz	QPSK	1 RB, 0 RB Offest
	23060 to 23130	23060, 23095, 23130	10MHz	QPSK	1 RB, 0 RB Offest
RADIATED EMISSION	23060 to 23130	23060, 23095, 23130	10MHz	QPSK	1 RB, 49 RB Offest

Unless otherwise stated the results shown in this test report refer only to the sample(s) tested and such sample(s) are retained for 90 days only.

除非另有說明，此報告結果僅對測試之樣品負責，同時此樣品僅保留90天。本報告未經本公司書面許可，不可部份複製。

This document is issued by the Company subject to its General Conditions of Service printed overleaf, available on request or accessible at www.sgs.com/terms_and_conditions.htm and for electronic format documents, subject to Terms and Conditions for Electronic Documents at www.sgs.com/terms_e-document.htm. Attention is drawn to the limitation of liability, indemnification and jurisdiction issues defined therein. Any holder of this document is advised that information contained hereon reflects the Company's findings at the time of its intervention only and within the limits of Client's instructions, if any. The Company's sole responsibility is to its Client and this document does not exonerate parties to a transaction from exercising all their rights and obligations under the transaction documents. This document cannot be reproduced except in full, without prior written approval of the Company. Any unauthorized alteration, forgery or falsification of the content or appearance of this document is unlawful and offenders may be prosecuted to the fullest extent of the law.

LTE Band 13 MODE

TEST ITEM	AVAILABLE CHANNEL	TESTED CHANNEL	CHANNEL BANDWIDTH	MODULATION	MODE
ERP	23205 to 23255	23205, 23230, 23255	5MHz	QPSK, 16QAM, 64QAM	1 RB/ 0,24 RB Offest
	23230	23230	10MHz	QPSK, 16QAM, 64QAM	1 RB/ 0,49 RB Offest
FREQUENCY STABILITY	23230	23230	10MHz	QPSK	Full RB
OCCUPIED BANDWIDTH	23205 to 23255	23205, 23230, 23255	5MHz	QPSK, 16QAM, 64QAM	Full RB
	23230	23230	10MHz	QPSK, 16QAM, 64QAM	Full RB
PEAK TO AVERAGE RATIO	23205 to 23255	23205, 23230, 23255	5MHz	64QAM	Full RB
	23230	23230	10MHz	64QAM	Full RB
BAND EDGE	23205 to 23255	23205, 23255	5MHz	QPSK	1 RB/ 0,24 RB Offest Full RB
	23230	23230	10MHz	QPSK	1 RB/ 0,49 RB Offest Full RB
CONDCU-DETECTED EMISSION	23205 to 23255	23205, 23230, 23255	5MHz	QPSK	1 RB, 0 RB Offest
	23230	23230	10MHz	QPSK	1 RB, 0 RB Offest
RADIATED EMISSION	23205 to 23255	23205, 23230, 23255	5MHz	QPSK	1 RB, 24 RB Offest

LTE Band 17 MODE

TEST ITEM	AVAILABLE CHANNEL	TESTED CHANNEL	CHANNEL BANDWIDTH	MODULATION	MODE
ERP	23755 to 23825	23755, 23790, 23825	5MHz	QPSK, 16QAM, 64QAM	1 RB/ 0,24 RB Offest
	23780 to 23800	23780, 23790, 23800	10MHz	QPSK, 16QAM, 64QAM	1 RB/ 0,49 RB Offest
FREQUENCY STABILITY	23780 to 23800	23790	10MHz	QPSK	Full RB
OCCUPIED BANDWIDTH	23755 to 23825	23755, 23790, 23825	5MHz	QPSK, 16QAM, 64QAM	Full RB
	23780 to 23800	23780, 23790, 23800	10MHz	QPSK, 16QAM, 64QAM	Full RB
PEAK TO AVERAGE RATIO	23755 to 23825	23755, 23790, 23825	5MHz	64QAM	Full RB
	23780 to 23800	23780, 23790, 23800	10MHz	64QAM	Full RB
BAND EDGE	23755 to 23825	23755, 23825	5MHz	QPSK	1 RB/ 0,24 RB Offest Full RB
	23780 to 23800	23780, 23800	10MHz	QPSK	1 RB/ 0,49 RB Offest Full RB
CONDCU-DETECTED EMISSION	23755 to 23825	23755, 23790, 23825	5MHz	QPSK	1 RB, 0 RB Offest
	23780 to 23800	23780, 23790, 23800	10MHz	QPSK	1 RB, 0 RB Offest
RADIATED EMISSION	23780 to 23800	23780, 23800	10MHz	QPSK	1 RB, 49 RB Offest

Unless otherwise stated the results shown in this test report refer only to the sample(s) tested and such sample(s) are retained for 90 days only.

除非另有說明，此報告結果僅對測試之樣品負責，同時此樣品僅保留90天。本報告未經本公司書面許可，不可部份複製。

This document is issued by the Company subject to its General Conditions of Service printed overleaf, available on request or accessible at www.sgs.com/terms_and_conditions.htm and for electronic format documents, subject to Terms and Conditions for Electronic Documents at www.sgs.com/terms_e-document.htm. Attention is drawn to the limitation of liability, indemnification and jurisdiction issues defined therein. Any holder of this document is advised that information contained hereon reflects the Company's findings at the time of its intervention only and within the limits of Client's instructions, if any. The Company's sole responsibility is to its Client and this document does not exonerate parties to a transaction from exercising all their rights and obligations under the transaction documents. This document cannot be reproduced except in full, without prior written approval of the Company. Any unauthorized alteration, forgery or falsification of the content or appearance of this document is unlawful and offenders may be prosecuted to the fullest extent of the law.

LTE Band 38 MODE

TEST ITEM	AVAILABLE CHANNEL	TESTED CHANNEL	CHANNEL BANDWIDTH	MODULATION	MODE
EIRP	37775 to 38225	37775, 38000, 38225	5MHz	QPSK, 16QAM, 64QAM	1 RB/ 0,24 RB Offest
	37800 to 38200	37800 , 38000, 38200	10MHz	QPSK, 16QAM, 64QAM	1 RB/ 0,49 RB Offest
	37825 to 38175	37825 , 38000, 38175	15MHz	QPSK, 16QAM, 64QAM	1 RB/ 0,74 RB Offest
	37850 to 38150	37850 , 38000, 38150	20MHz	QPSK, 16QAM, 64QAM	1 RB/ 0,99 RB Offest
FREQUENCY STABILITY	37800 to 38200	37800 , 38000, 38200	10MHz	QPSK	Full RB
OCCUPIED BANDWIDTH	37775 to 38225	37775, 38000, 38225	5MHz	QPSK, 16QAM, 64QAM	Full RB
	37800 to 38200	37800 , 38000, 38200	10MHz	QPSK, 16QAM, 64QAM	Full RB
	37825 to 38175	37825 , 38000, 38175	15MHz	QPSK, 16QAM, 64QAM	Full RB
	37850 to 38150	37850 , 38000, 38150	20MHz	QPSK, 16QAM, 64QAM	Full RB
PEAK TO AVERAGE RATIO	37775 to 38225	37775, 38000, 38225	5MHz	64QAM	Full RB
	37800 to 38200	37800 , 38000, 38200	10MHz	64QAM	Full RB
	37825 to 38175	37825 , 38000, 38175	15MHz	64QAM	Full RB
	37850 to 38150	37850 , 38000, 38150	20MHz	64QAM	Full RB
BAND EDGE	37775 to 38225	37775, 38000, 38225	5MHz	QPSK	1 RB/ 0,24 RB Offest Full RB
	37800 to 38200	37800 , 38000, 38200	10MHz	QPSK	1 RB/ 0,49 RB Offest Full RB
	37825 to 38175	37825 , 38000, 38175	15MHz	QPSK	1 RB/ 0,74 RB Offest Full RB
	37850 to 38150	37850 , 38000, 38150	20MHz	QPSK	1 RB/ 0,99 RB Offest Full RB
CONDUCTED EMISSION	37775 to 38225	37775, 38000, 38225	5MHz	QPSK	1 RB, 0 RB Offest
	37800 to 38200	37800 , 38000, 38200	10MHz	QPSK	1 RB, 0 RB Offest
	37825 to 38175	37825 , 38000, 38175	15MHz	QPSK	1 RB, 0 RB Offest
	37850 to 38150	37850 , 38000, 38150	20MHz	QPSK	1 RB, 0 RB Offest
RADIATED EMISSION	37800 to 38200	37800 , 38000, 38200	10MHz	QPSK	1 RB, 49 RB Offest
EMISSION MASK	37775 to 38225	37775, 38000, 38225	5MHz	QPSK	1 RB/ 0,24 RB Offest 25 RB/ 0 Offset
	37800 to 38200	37800 , 38000, 38200	10MHz	QPSK	1 RB/ 0,49 RB Offest 50 RB/ 0 Offset
	37825 to 38175	37825 , 38000, 38175	15MHz	QPSK	1 RB/ 0,74 RB Offest 75 RB/ 0 Offset
	37850 to 38150	37850 , 38000, 38150	20MHz	QPSK	1 RB/ 0,99 RB Offest 100 RB/ 0 Offset

Unless otherwise stated the results shown in this test report refer only to the sample(s) tested and such sample(s) are retained for 90 days only.

除非另有說明，此報告結果僅對測試之樣品負責，同時此樣品僅保留90天。本報告未經本公司書面許可，不可部份複製。

This document is issued by the Company subject to its General Conditions of Service printed overleaf, available on request or accessible at www.sgs.com/terms_and_conditions.htm and for electronic format documents, subject to Terms and Conditions for Electronic Documents at www.sgs.com/terms_e-document.htm. Attention is drawn to the limitation of liability, indemnification and jurisdiction issues defined therein. Any holder of this document is advised that information contained hereon reflects the Company's findings at the time of its intervention only and within the limits of Client's instructions, if any. The Company's sole responsibility is to its Client and this document does not exonerate parties to a transaction from exercising all their rights and obligations under the transaction documents. This document cannot be reproduced except in full, without prior written approval of the Company. Any unauthorized alteration, forgery or falsification of the content or appearance of this document is unlawful and offenders may be prosecuted to the fullest extent of the law.

5. MEASUREMENT UNCERTAINTY

Test Items	Uncertainty
RF Output Power	+/- 1.15 dB
99% Occupied Bandwidth	+/- 0.89%
Out of Band Emissions at Antenna Terminals and Band Edge	+/- 0.89 dB
Frequency Stability vs. Temperature	+/- 2.64 Hz
3M Semi Anechoic Chamber / 30M~200M	+/- 4.12 dB
3M Semi Anechoic Chamber / 200MHz ~ 1GHz	+/- 4.68
3M Semi Anechoic Chamber / 1GHz ~ 8GHz	+/- 5.18
3M Semi Anechoic Chamber / 8GHz ~ 18GHz	+/- 5.47
3M Semi Anechoic Chamber / 18GHz ~ 26GHz	+/- 3.81
3M Semi Anechoic Chamber / 26GHz ~ 40GHz	+/- 3.87

Note:

1. This uncertainty represents an expanded uncertainty expressed at approximately the 95% confidence level using a coverage factor of k=2.
2. ISO/IEC 17025 requires that an estimate of the measurement uncertainties associated with the emissions test results be included in the report.
3. The conformity assessment statement in this report is based solely on the test results, measurement uncertainty is excluded.

Unless otherwise stated the results shown in this test report refer only to the sample(s) tested and such sample(s) are retained for 90 days only.

除非另有說明，此報告結果僅對測試之樣品負責，同時此樣品僅保留90天。本報告未經本公司書面許可，不可部份複製。

This document is issued by the Company subject to its General Conditions of Service printed overleaf, available on request or accessible at www.sgs.com/terms_and_conditions.htm and for electronic format documents, subject to Terms and Conditions for Electronic Documents at www.sgs.com/terms_e-document.htm. Attention is drawn to the limitation of liability, indemnification and jurisdiction issues defined therein. Any holder of this document is advised that information contained hereon reflects the Company's findings at the time of its intervention only and within the limits of Client's instructions, if any. The Company's sole responsibility is to its Client and this document does not exonerate parties to a transaction from exercising all their rights and obligations under the transaction documents. This document cannot be reproduced except in full, without prior written approval of the Company. Any unauthorized alteration, forgery or falsification of the content or appearance of this document is unlawful and offenders may be prosecuted to the fullest extent of the law.

6. MAXMUM OUTPUT POWER

6.1. Standard Applicable

A base station simulator was used to establish communication with the EUT. Its parameters were set to transmit the maximum power on the EUT. The measured power in the radio frequency on the transmitter output terminals.

ERP/EIRP LIMIT

According to FCC §2.1046

FCC 22.913(a) Mobile station is limited to 7W ERP.

FCC 24.232(b) Mobile and portable stations are limited to 2 W EIRP.

FCC 27.50(a)(3) Mobile and portable stations (hand-held devices) are limited to 250 mW/ 5MHz EIRP.

FCC 27.50(c)(10) Portable stations (hand-held devices) are limited to 3 watts ERP.

FCC 27.50(d)(4) Fixed, mobile, and portable (hand-held) stations are limited to 1W EIRP.

FCC 27, 50(h)(2) Mobile and other user stations. Mobile stations are limited to 2 W EIRP

6.2. Test Set-up

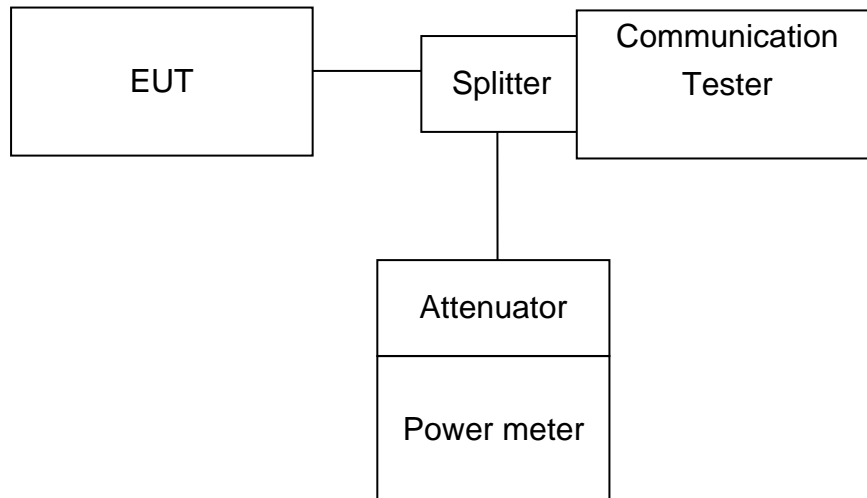

Note: Measurement setup for testing on Antenna connector

Unless otherwise stated the results shown in this test report refer only to the sample(s) tested and such sample(s) are retained for 90 days only.

除非另有說明，此報告結果僅對測試之樣品負責，同時此樣品僅保留90天。本報告未經本公司書面許可，不可部份複製。

This document is issued by the Company subject to its General Conditions of Service printed overleaf, available on request or accessible at www.sgs.com/terms_and_conditions.htm and for electronic format documents, subject to Terms and Conditions for Electronic Documents at www.sgs.com/terms_e-document.htm. Attention is drawn to the limitation of liability, indemnification and jurisdiction issues defined therein. Any holder of this document is advised that information contained hereon reflects the Company's findings at the time of its intervention only and within the limits of Client's instructions, if any. The Company's sole responsibility is to its Client and this document does not exonerate parties to a transaction from exercising all their rights and obligations under the transaction documents. This document cannot be reproduced except in full, without prior written approval of the Company. Any unauthorized alteration, forgery or falsification of the content or appearance of this document is unlawful and offenders may be prosecuted to the fullest extent of the law.

6.3. Measurement Procedure

The transmitter output was connected to a calibrated attenuator, the other end of which was connected to a power meter. Transmitter output was read off the power meter in dBm. The power output at the transmitter antenna port was determined by adding the value of the attenuator to the power meter reading. TS 151 010-1 is reference to conduct the test measurement of output power.

The Procedure of KDB941225 (SAR Measurement Procedures for 3G devices, (WCD-MA/HSPA) was used for EUT and Base station setting. RMC 12.2kps is used for this testing, and KDB 971168 D01 Power Meas License Digital System as the supplemental test methodology to adjust the proper setting obtaining the measurement results

All LTE bands conducted average power is obtained from the simulator telecommunication test set.

The following tests were conducted according to the test requirements outlined in section 6.2 of the 3GPP.

TEST PROCEDURE:

ANSI C63.26:2015

KDB 971168 Section 5.6

$$\text{ERP/EIRP} = \text{PMeas} + \text{GT-LC}$$

where: ERP/EIRP = effective or equivalent radiated power, respectively (expressed in the same units as PMeas, typically dBW or dBm);

PMeas = measured transmitter output power or PSD, in dBm or dBW;

GT = gain of the transmitting antenna, in dBd (ERP) or dBi (EIRP);

LC = signal attenuation in the connecting cable between the transmitter and antenna, in dB.2

For devices utilizing multiple antennas, KDB 662911 provides guidance for determining the effective array transmit antenna gain term to be used in the above equation.

Unless otherwise stated the results shown in this test report refer only to the sample(s) tested and such sample(s) are retained for 90 days only.

除非另有說明，此報告結果僅對測試之樣品負責，同時此樣品僅保留90天。本報告未經本公司書面許可，不可部份複製。

This document is issued by the Company subject to its General Conditions of Service printed overleaf, available on request or accessible at www.sgs.com/terms_and_conditions.htm and for electronic format documents, subject to Terms and Conditions for Electronic Documents at www.sgs.com/terms_e-document.htm. Attention is drawn to the limitation of liability, indemnification and jurisdiction issues defined therein. Any holder of this document is advised that information contained hereon reflects the Company's findings at the time of its intervention only and within the limits of Client's instructions, if any. The Company's sole responsibility is to its Client and this document does not exonerate parties to a transaction from exercising all their rights and obligations under the transaction documents. This document cannot be reproduced except in full, without prior written approval of the Company. Any unauthorized alteration, forgery or falsification of the content or appearance of this document is unlawful and offenders may be prosecuted to the fullest extent of the law.

6.4. Measurement Equipment Used

EQUIPMENT TYPE	MFR	MODEL NUMBER	SERIAL NUMBER	LAST CAL.	CAL DUE.
Digital Radio Communication Tester	R&S	CMU200	100535	09/17/2018	09/16/2019
DC Power Supply	Agilent	E3640A	KR93300208	08/15/2018	08/14/2019
Attenuator	Mini-Circuit	BW-S10W2+	1	02/26/2019	02/25/2020
Wideband Radio Communication Tester	R&S	CMW 500	116875	04/20/2018	04/19/2019

Unless otherwise stated the results shown in this test report refer only to the sample(s) tested and such sample(s) are retained for 90 days only.

除非另有說明，此報告結果僅對測試之樣品負責，同時此樣品僅保留90天。本報告未經本公司書面許可，不可部份複製。

This document is issued by the Company subject to its General Conditions of Service printed overleaf, available on request or accessible at www.sgs.com/terms_and_conditions.htm and for electronic format documents, subject to Terms and Conditions for Electronic Documents at www.sgs.com/terms_e-document.htm. Attention is drawn to the limitation of liability, indemnification and jurisdiction issues defined therein. Any holder of this document is advised that information contained hereon reflects the Company's findings at the time of its intervention only and within the limits of Client's instructions, if any. The Company's sole responsibility is to its Client and this document does not exonerate parties to a transaction from exercising all their rights and obligations under the transaction documents. This document cannot be reproduced except in full, without prior written approval of the Company. Any unauthorized alteration, forgery or falsification of the content or appearance of this document is unlawful and offenders may be prosecuted to the fullest extent of the law.

6.5. Measurement Result

RF Conducted Output Power GSM/GPRS/EDGE MODE:

GSM/GPRS/EDGE (GMSK; 8-PSK) Result:

EUT Mode	Freq. (MHz)	CH	Conducted Avg. Power (dBm)	Antenna Gain (dBi)	ERP (dBm)	EIRP (dBm)	Limit (dBm)	Margin (dB)
GSM 850	824.2	128	32.07	-5.40	24.52	26.67	38.50	-11.83
	836.6	190	31.85	-5.40	24.30	26.45	38.50	-12.05
	848.8	251	31.64	-5.40	24.09	26.24	38.50	-12.26
GSM 1900	1850.2	512	29.00	-2.00	24.85	27.00	33.00	-6.00
	1880.0	661	29.03	-2.00	24.88	27.03	33.00	-5.97
	1909.8	810	28.88	-2.00	24.73	26.88	33.00	-6.12
GPRS 850	824.2	128	32.04	-5.40	24.49	26.64	38.50	-11.86
	836.6	190	31.83	-5.40	24.28	26.43	38.50	-12.07
	848.8	251	31.63	-5.40	24.08	26.23	38.50	-12.27
GPRS 1900	1850.2	512	28.95	-2.00	24.80	26.95	33.00	-6.05
	1880.0	661	29.01	-2.00	24.86	27.01	33.00	-5.99
	1909.8	810	28.83	-2.00	24.68	26.83	33.00	-6.17

EUT Mode	Frequency (MHz)	CH	Average Burst Power (1DN 1UP) Class 8 (dBm)	Average Burst Power (1DN 2UP) Class 10 (dBm)	Average Burst Power (1DN 3UP) Class 12 (dBm)	Average Burst Power (1DN 4UP) Class 12 (dBm)
GPRS 850	824.2	128	32.04	29.82	27.79	26.74
	836.6	190	31.83	29.74	27.64	26.85
	848.8	251	31.63	29.67	27.61	26.73
GPRS 1900	1850.2	512	28.95	26.86	24.77	23.85
	1880.0	661	29.01	26.63	24.73	23.82
	1909.8	810	28.83	26.57	24.68	23.72

Unless otherwise stated the results shown in this test report refer only to the sample(s) tested and such sample(s) are retained for 90 days only.

除非另有說明，此報告結果僅對測試之樣品負責，同時此樣品僅保留90天。本報告未經本公司書面許可，不可部份複製。

This document is issued by the Company subject to its General Conditions of Service printed overleaf, available on request or accessible at www.sgs.com/terms_and_conditions.htm and for electronic format documents, subject to Terms and Conditions for Electronic Documents at www.sgs.com/terms_e-document.htm. Attention is drawn to the limitation of liability, indemnification and jurisdiction issues defined therein. Any holder of this document is advised that information contained hereon reflects the Company's findings at the time of its intervention only and within the limits of Client's instructions, if any. The Company's sole responsibility is to its Client and this document does not exonerate parties to a transaction from exercising all their rights and obligations under the transaction documents. This document cannot be reproduced except in full, without prior written approval of the Company. Any unauthorized alteration, forgery or falsification of the content or appearance of this document is unlawful and offenders may be prosecuted to the fullest extent of the law.

WCDMA MODE:

The following tests were completed according to the test requirements outlined in section 5.2 of the 3GPP TS34.121-1 specification. The EUT supports power Class 3, which has a nominal maximum output power of 24 dBm (+1.7/-3.7). RMC 12.2kps is used for this testing.

Results:

WCDMA/HSUPA/HSDPA Band II Result:

EUT Mode	Freq. (MHz)	CH	Conducted Avg. Power (dBm)	Antenna Gain (dBi)	ERP (dBm)	EIRP (dBm)	Limit (dBm)	Margin (dB)
WCDMA	1852.4	9262	22.36	-2.00	18.21	20.36	33.00	-12.64
	1880.0	9400	22.66	-2.00	18.51	20.66	33.00	-12.34
	1907.6	9538	22.52	-2.00	18.37	20.52	33.00	-12.48
HSDPA	1852.4	9262	21.36	-2.00	17.21	19.36	33.00	-13.64
	1880.0	9400	21.64	-2.00	17.49	19.64	33.00	-13.36
	1907.6	9538	21.48	-2.00	17.33	19.48	33.00	-13.52
HSUPA	1852.4	9262	21.33	-2.00	17.18	19.33	33.00	-13.67
	1880.0	9400	21.56	-2.00	17.41	19.56	33.00	-13.44
	1907.6	9538	21.45	-2.00	17.30	19.45	33.00	-13.55

WCDMA/HSUPA/HSDPA Band IV Result:

EUT Mode	Freq. (MHz)	CH	Conducted Avg. Power (dBm)	Antenna Gain (dBi)	ERP (dBm)	EIRP (dBm)	Limit (dBm)	Margin (dB)
WCDMA	1712.4	1312	22.50	-3.70	16.65	18.80	30.00	-11.20
	1732.6	1413	22.56	-3.70	16.71	18.86	30.00	-11.14
	1752.6	1513	22.55	-3.70	16.70	18.85	30.00	-11.15
HSDPA	1712.4	1312	21.51	-3.70	15.66	17.81	30.00	-12.19
	1732.6	1413	21.55	-3.70	15.70	17.85	30.00	-12.15
	1752.6	1513	21.59	-3.70	15.74	17.89	30.00	-12.11
HSUPA	1712.4	1312	21.47	-3.70	15.62	17.77	30.00	-12.23
	1732.6	1413	21.54	-3.70	15.69	17.84	30.00	-12.16
	1752.6	1513	21.59	-3.70	15.74	17.89	30.00	-12.11

Unless otherwise stated the results shown in this test report refer only to the sample(s) tested and such sample(s) are retained for 90 days only.

除非另有說明，此報告結果僅對測試之樣品負責，同時此樣品僅保留90天。本報告未經本公司書面許可，不可部份複製。

This document is issued by the Company subject to its General Conditions of Service printed overleaf, available on request or accessible at www.sgs.com/terms_and_conditions.htm and for electronic format documents, subject to Terms and Conditions for Electronic Documents at www.sgs.com/terms_e-document.htm. Attention is drawn to the limitation of liability, indemnification and jurisdiction issues defined therein. Any holder of this document is advised that information contained hereon reflects the Company's findings at the time of its intervention only and within the limits of Client's instructions, if any. The Company's sole responsibility is to its Client and this document does not exonerate parties to a transaction from exercising all their rights and obligations under the transaction documents. This document cannot be reproduced except in full, without prior written approval of the Company. Any unauthorized alteration, forgery or falsification of the content or appearance of this document is unlawful and offenders may be prosecuted to the fullest extent of the law.

WCDMA/HSUPA/HSDPA Band V Result:

EUT Mode	Freq. (MHz)	CH	Conducted Avg. Power (dBm)	Antenna Gain (dBi)	ERP (dBm)	EIRP (dBm)	Limit (dBm)	Margin (dB)
WCDMA	826.4	4132	22.80	-5.40	15.25	17.40	38.50	-21.10
	836.6	4183	22.97	-5.40	15.42	17.57	38.50	-20.93
	846.6	4233	22.92	-5.40	15.37	17.52	38.50	-20.98
HSDPA	826.4	4132	21.84	-5.40	14.29	16.44	38.50	-22.06
	836.6	4183	21.94	-5.40	14.39	16.54	38.50	-21.96
	846.6	4233	21.93	-5.40	14.38	16.53	38.50	-21.97
HSUPA	826.4	4132	21.88	-5.40	14.33	16.48	38.50	-22.02
	836.6	4183	21.90	-5.40	14.35	16.50	38.50	-22.00
	846.6	4233	21.89	-5.40	14.34	16.49	38.50	-22.01

Unless otherwise stated the results shown in this test report refer only to the sample(s) tested and such sample(s) are retained for 90 days only.

除非另有說明，此報告結果僅對測試之樣品負責，同時此樣品僅保留90天。本報告未經本公司書面許可，不可部份複製。

This document is issued by the Company subject to its General Conditions of Service printed overleaf, available on request or accessible at www.sgs.com/terms_and_conditions.htm and for electronic format documents, subject to Terms and Conditions for Electronic Documents at www.sgs.com/terms_e-document.htm. Attention is drawn to the limitation of liability, indemnification and jurisdiction issues defined therein. Any holder of this document is advised that information contained hereon reflects the Company's findings at the time of its intervention only and within the limits of Client's instructions, if any. The Company's sole responsibility is to its Client and this document does not exonerate parties to a transaction from exercising all their rights and obligations under the transaction documents. This document cannot be reproduced except in full, without prior written approval of the Company. Any unauthorized alteration, forgery or falsification of the content or appearance of this document is unlawful and offenders may be prosecuted to the fullest extent of the law.

HSDPA Release 6 MODE:

The following 4 Sub-Tests were completed according to the test requirements outlined in section 5.2A of the 3GPP TS34.121-1 specification. All TX RMS power requirements for Power Class 3 were met according to table 5.2AA.5 and 5.2B.5 All UE channels and power ratio's are set according to table C10.1.4 & C11.1.3 in the 3GPP TS34.121-1. RMC 12.2kps is used for this testing.

HSDPA SUB-TEST Setting

Table C.10.1.4: β values for transmitter characteristics tests with HS-DPCCH(FOR HSDPA)

Sub-test	β_c	β_d	β_d (SF)	β_c/β_d	β_{HS} (Note 1, Note 2)	CM (dB) (Note 3)	MPR (dB) (Note 3)	RMC (Kbps)
1	2/15	15/15	64	2/15	4/15	0.0	0.0	12.2
2	12/15 (Note 4)	15/15 (Note 4)	64	12/15 (Note 4)	24/15	1.0	0.0	12.2
3	15/15	8/15	64	15/8	30/15	1.5	0.5	12.2
4	15/15	4/15	64	15/4	30/15	1.5	0.5	12.2

Note: The recommended HSDPA MPRs are implemented as per following sub-tests.

HSPA (HSDPA & HSUPA) Release 6 MODE

The following 5 Sub-Tests were completed according to the test requirements outlined in section 5.2A of the 3GPP TS34.121-1 specification. All TX RMS power requirements for Power Class 3 were met according to table 5.2AA.5 and 5.2B.5 All UE channels and power ratio's are set according to table C11.1.3 in the 3GPP TS34.121-1. RMC 12.2kps is used for this testing

HSPA SUB-TEST Setting

Table C.11.1.3: β values for transmitter characteristics tests with HS-DPCCH and E-DCH(FOR HSUPA)

Sub-test	β_c	β_d	β_d (SF)	β_c/β_d	β_{HS}	β_{ec}	β_{ed}	β_{ed} (SF)	β_{ed} (Code s)	CM (dB)	MPR (dB)	AG Index	E-TFCI	RMC (Kbps)
1	11/15 (Note 3)	15/15 (Note 3)	64	11/15 (Note 3)	22/15	209/225	1309/225	4	1	1.0	0.0	20	75	12.2
2	6/15	15/15	64	6/15	12/15	12/15	94/75	4	1	3.0	2.0	12	67	12.2
3	15/15	9/15	64	15/9	30/15	30/15	β_{ed1} : 47/15 β_{ed2} : 47/15	4 4	2	2.0	1.0	15	92	12.2
4	2/15	15/15	64	2/15	4/15	2/15	56/75	4	1	3.0	2.0	17	71	12.2
5	15/15 (Note 4)	15/15 (Note 4)	64	15/15 (Note 4)	30/15	24/15	134/15	4	1	1.0	0.0	21	81	12.2

Note: The recommended HSUPA MPRs are implemented as per following sub-tests.

Unless otherwise stated the results shown in this test report refer only to the sample(s) tested and such sample(s) are retained for 90 days only.

除非另有說明，此報告結果僅對測試之樣品負責，同時此樣品僅保留90天。本報告未經本公司書面許可，不可部份複製。

This document is issued by the Company subject to its General Conditions of Service printed overleaf, available on request or accessible at www.sgs.com/terms_and_conditions.htm and for electronic format documents, subject to Terms and Conditions for Electronic Documents at www.sgs.com/terms_e-document.htm. Attention is drawn to the limitation of liability, indemnification and jurisdiction issues defined therein. Any holder of this document is advised that information contained hereon reflects the Company's findings at the time of its intervention only and within the limits of Client's instructions, if any. The Company's sole responsibility is to its Client and this document does not exonerate parties to a transaction from exercising all their rights and obligations under the transaction documents. This document cannot be reproduced except in full, without prior written approval of the Company. Any unauthorized alteration, forgery or falsification of the content or appearance of this document is unlawful and offenders may be prosecuted to the fullest extent of the law.

Results:

Mode	Sub test	Avg. Power (dBm)		
		Channel		
		9262.00	9400.00	9538.00
HSDPA II	1	21.36	21.64	21.48
	2	20.53	21.13	21.00
	3	20.54	21.12	20.96
	4	20.55	21.07	20.94

Mode	Sub test	Avg. Power (dBm)		
		Channel		
		1312.00	1413.00	1513.00
HSDPA IV	1	21.51	21.55	21.59
	2	20.96	21.02	21.05
	3	20.94	20.98	21.12
	4	20.97	20.97	21.09

Mode	Sub test	Avg. Power (dBm)		
		Channel		
		4132.00	4183.00	4233.00
HSDPA V	1	21.84	21.94	21.93
	2	21.34	21.42	21.38
	3	21.35	21.08	21.10
	4	21.29	21.41	21.38

Unless otherwise stated the results shown in this test report refer only to the sample(s) tested and such sample(s) are retained for 90 days only.

除非另有說明，此報告結果僅對測試之樣品負責，同時此樣品僅保留90天。本報告未經本公司書面許可，不可部份複製。

This document is issued by the Company subject to its General Conditions of Service printed overleaf, available on request or accessible at www.sgs.com/terms_and_conditions.htm and for electronic format documents, subject to Terms and Conditions for Electronic Documents at www.sgs.com/terms_e-document.htm. Attention is drawn to the limitation of liability, indemnification and jurisdiction issues defined therein. Any holder of this document is advised that information contained hereon reflects the Company's findings at the time of its intervention only and within the limits of Client's instructions, if any. The Company's sole responsibility is to its Client and this document does not exonerate parties to a transaction from exercising all their rights and obligations under the transaction documents. This document cannot be reproduced except in full, without prior written approval of the Company. Any unauthorized alteration, forgery or falsification of the content or appearance of this document is unlawful and offenders may be prosecuted to the fullest extent of the law.

Mode	Sub test	Avg. Power (dBm)		
		Channel		
		9262.00	9400.00	9538.00
HSUPA II	1	21.33	21.56	21.45
	2	19.31	19.58	19.43
	3	20.30	20.49	20.44
	4	19.31	19.50	19.41
	5	21.30	21.63	21.52

Mode	Sub test	Avg. Power (dBm)		
		Channel		
		1312.00	1413.00	1513.00
HSUPA IV	1	21.47	21.54	21.59
	2	19.47	19.52	19.51
	3	20.49	20.53	20.54
	4	19.49	19.52	19.57
	5	21.52	21.56	21.57

Mode	Sub test	Avg. Power (dBm)		
		Channel		
		4132.00	4183.00	4233.00
HSUPA V	1	21.88	21.90	21.89
	2	19.81	19.87	19.88
	3	20.78	20.86	20.89
	4	19.82	19.92	19.88
	5	21.80	21.92	21.88

WCDMA/HSDPA/HSUPA band II, IV, V

The EUT output power was controlled by simulator. Set Communication Tester MT8820C function key "UE Power Control" and enter max rated power 24dBm. The EUT is going to be set to max output power to 24dBm. Then record the read (see page 15 for measurement data). The min. power was measures by a function key "minimum power" then record the read. It is -52.3dBm. The power variation can be 0.1dB step by setting.

Unless otherwise stated the results shown in this test report refer only to the sample(s) tested and such sample(s) are retained for 90 days only.

除非另有說明，此報告結果僅對測試之樣品負責，同時此樣品僅保留90天。本報告未經本公司書面許可，不可部份複製。

This document is issued by the Company subject to its General Conditions of Service printed overleaf, available on request or accessible at www.sgs.com/terms_and_conditions.htm and for electronic format documents, subject to Terms and Conditions for Electronic Documents at www.sgs.com/terms_e-document.htm. Attention is drawn to the limitation of liability, indemnification and jurisdiction issues defined therein. Any holder of this document is advised that information contained hereon reflects the Company's findings at the time of its intervention only and within the limits of Client's instructions, if any. The Company's sole responsibility is to its Client and this document does not exonerate parties to a transaction from exercising all their rights and obligations under the transaction documents. This document cannot be reproduced except in full, without prior written approval of the Company. Any unauthorized alteration, forgery or falsification of the content or appearance of this document is unlawful and offenders may be prosecuted to the fullest extent of the law.

Minimum Communications Power Measurement

PCS 1900 band

PCL	0	1	2	3	4	5	6	7	8
Output power (dBm)	29.51	27.52	24.89	22.89	21.12	18.96	17.25	14.98	12.91

PCL	9	10	11	12	13	14	15
Output power (dBm)	11.21	9.43	7.34	4.95	2.89	1.02	-1.33

Note: The EUT output power was controlled by simulator. Set Communication Tester **CMU 200** PCL as above, and get the mobile phone output power reading.

WCDMA/HSDPA/HSUPA band V

The EUT output power was controlled by simulator. Set Communication Tester MT8820C function key "UE Power Control" and enter max rated power 24dBm. The EUT is going to be set to max output power to 24dBm. Then record the read (see page 15 for measurement data). The min. power was measures by a function key "minimum power" then record the read. It is -52.3dBm. The power variation can be 0.1dB step by setting.

Unless otherwise stated the results shown in this test report refer only to the sample(s) tested and such sample(s) are retained for 90 days only.

除非另有說明，此報告結果僅對測試之樣品負責，同時此樣品僅保留90天。本報告未經本公司書面許可，不可部份複製。

This document is issued by the Company subject to its General Conditions of Service printed overleaf, available on request or accessible at www.sgs.com/terms_and_conditions.htm and for electronic format documents, subject to Terms and Conditions for Electronic Documents at www.sgs.com/terms_e-document.htm. Attention is drawn to the limitation of liability, indemnification and jurisdiction issues defined therein. Any holder of this document is advised that information contained hereon reflects the Company's findings at the time of its intervention only and within the limits of Client's instructions, if any. The Company's sole responsibility is to its Client and this document does not exonerate parties to a transaction from exercising all their rights and obligations under the transaction documents. This document cannot be reproduced except in full, without prior written approval of the Company. Any unauthorized alteration, forgery or falsification of the content or appearance of this document is unlawful and offenders may be prosecuted to the fullest extent of the law.

LTE Result:

Antenna gain (dBi) -2

LTE Band 2_Uplink frequency band : 1850 to 1910 MHz									
BW (MHz)	UL Channel	Frequency (MHz)	Modulation	RB Size	RB Offset	Conducted Average (dBm)	EIRP Average (dBm)	EIRP Limit (dBm)	Margin (dB)
1.4	18607	1850.7	QPSK	1	0	22.25	20.25	33	-12.75
				1	5	22.27	20.27	33	-12.73
				3	2	22.22	20.22	33	-12.78
				6	0	21.29	19.29	33	-13.71
	18900	1880	QPSK	1	0	22.21	20.21	33	-12.79
				1	5	22.25	20.25	33	-12.75
				3	2	22.29	20.29	33	-12.71
				6	0	21.29	19.29	33	-13.71
	19193	1909.3	QPSK	1	0	22.29	20.29	33	-12.71
				1	5	22.28	20.28	33	-12.72
				3	2	22.30	20.30	33	-12.7
				6	0	21.28	19.28	33	-13.72
	18607	1850.7	16QAM	1	0	21.25	19.25	33	-13.75
				1	5	21.26	19.26	33	-13.74
				3	2	21.29	19.29	33	-13.71
				6	0	20.47	18.47	33	-14.53
	18900	1880	16QAM	1	0	21.26	19.26	33	-13.74
				1	5	21.27	19.27	33	-13.73
				3	2	21.26	19.26	33	-13.74
				6	0	20.48	18.48	33	-14.52
	19193	1909.3	16QAM	1	0	21.27	19.27	33	-13.73
				1	5	21.20	19.20	33	-13.8
				3	2	21.26	19.26	33	-13.74
				6	0	20.51	18.51	33	-14.49
	18607	1850.7	64QAM	1	0	20.48	18.48	33	-14.52
				1	5	20.50	18.50	33	-14.5
				3	2	20.46	18.46	33	-14.54
				6	0	19.51	17.51	33	-15.49
	18900	1880	64QAM	1	0	20.50	18.50	33	-14.5
				1	5	20.47	18.47	33	-14.53
				3	2	20.50	18.50	33	-14.5
				6	0	19.49	17.49	33	-15.51
	19193	1909.3	64QAM	1	0	20.52	18.52	33	-14.48
				1	5	20.48	18.48	33	-14.52
				3	2	20.45	18.45	33	-14.55
				6	0	19.43	17.43	33	-15.57

Unless otherwise stated the results shown in this test report refer only to the sample(s) tested and such sample(s) are retained for 90 days only.

除非另有說明，此報告結果僅對測試之樣品負責，同時此樣品僅保留90天。本報告未經本公司書面許可，不可部份複製。

This document is issued by the Company subject to its General Conditions of Service printed overleaf, available on request or accessible at www.sgs.com/terms_and_conditions.htm and for electronic format documents, subject to Terms and Conditions for Electronic Documents at www.sgs.com/terms_e-document.htm. Attention is drawn to the limitation of liability, indemnification and jurisdiction issues defined therein. Any holder of this document is advised that information contained hereon reflects the Company's findings at the time of its intervention only and within the limits of Client's instructions, if any. The Company's sole responsibility is to its Client and this document does not exonerate parties to a transaction from exercising all their rights and obligations under the transaction documents. This document cannot be reproduced except in full, without prior written approval of the Company. Any unauthorized alteration, forgery or falsification of the content or appearance of this document is unlawful and offenders may be prosecuted to the fullest extent of the law.

Antenna gain (dBi) -2

LTE Band 2_Uplink frequency band : 1850 to 1910 MHz									
BW (MHz)	UL Channel	Frequency (MHz)	Modulation	RB Size	RB Offset	Conducted Average (dBm)	EIRP Average (dBm)	EIRP Limit (dBm)	Margin (dB)
3	18615	1851.5	QPSK	1	0	22.10	20.10	33	-12.9
				1	14	21.98	19.98	33	-13.02
				8	4	21.23	19.23	33	-13.77
				15	0	20.97	18.97	33	-14.03
	18900	1880	QPSK	1	0	22.05	20.05	33	-12.95
				1	14	22.27	20.27	33	-12.73
				8	4	21.27	19.27	33	-13.73
				15	0	21.25	19.25	33	-13.75
	19185	1908.5	QPSK	1	0	22.40	20.40	33	-12.6
				1	14	22.17	20.17	33	-12.83
				8	4	21.27	19.27	33	-13.73
				15	0	21.26	19.26	33	-13.74
	18615	1851.5	16QAM	1	0	21.21	19.21	33	-13.79
				1	14	21.30	19.30	33	-13.7
				8	4	20.06	18.06	33	-14.94
				15	0	19.84	17.84	33	-15.16
	18900	1880	16QAM	1	0	21.09	19.09	33	-13.91
				1	14	21.31	19.31	33	-13.69
				8	4	20.46	18.46	33	-14.54
				15	0	20.08	18.08	33	-14.92
	19185	1908.5	16QAM	1	0	21.70	19.70	33	-13.3
				1	14	21.15	19.15	33	-13.85
				8	4	20.29	18.29	33	-14.71
				15	0	20.17	18.17	33	-14.83
	18615	1851.5	64QAM	1	0	20.57	18.57	33	-14.43
				1	14	20.73	18.73	33	-14.27
				8	4	19.42	17.42	33	-15.58
				15	0	19.32	17.32	33	-15.68
	18900	1880	64QAM	1	0	20.50	18.50	33	-14.5
				1	14	20.85	18.85	33	-14.15
				8	4	19.71	17.71	33	-15.29
				15	0	19.39	17.39	33	-15.61
	19185	1908.5	64QAM	1	0	21.10	19.10	33	-13.9
				1	14	20.68	18.68	33	-14.32
				8	4	19.70	17.70	33	-15.3
				15	0	19.48	17.48	33	-15.52

Unless otherwise stated the results shown in this test report refer only to the sample(s) tested and such sample(s) are retained for 90 days only.

除非另有說明，此報告結果僅對測試之樣品負責，同時此樣品僅保留90天。本報告未經本公司書面許可，不可部份複製。

This document is issued by the Company subject to its General Conditions of Service printed overleaf, available on request or accessible at www.sgs.com/terms_and_conditions.htm and for electronic format documents, subject to Terms and Conditions for Electronic Documents at www.sgs.com/terms_e-document.htm. Attention is drawn to the limitation of liability, indemnification and jurisdiction issues defined therein. Any holder of this document is advised that information contained hereon reflects the Company's findings at the time of its intervention only and within the limits of Client's instructions, if any. The Company's sole responsibility is to its Client and this document does not exonerate parties to a transaction from exercising all their rights and obligations under the transaction documents. This document cannot be reproduced except in full, without prior written approval of the Company. Any unauthorized alteration, forgery or falsification of the content or appearance of this document is unlawful and offenders may be prosecuted to the fullest extent of the law.

Antenna gain (dBi) -2

LTE Band 2_Uplink frequency band : 1850 to 1910 MHz									
BW (MHz)	UL Channel	Frequency (MHz)	Modulation	RB Size	RB Offset	Conducted Average (dBm)	EIRP Average (dBm)	EIRP Limit (dBm)	Margin (dB)
5	18625	1852.5	QPSK	1	0	22.21	20.21	33	-12.79
				1	24	22.02	20.02	33	-12.98
				12	6	21.10	19.10	33	-13.9
				25	0	20.91	18.91	33	-14.09
	18900	1880	QPSK	1	0	22.08	20.08	33	-12.92
				1	24	22.11	20.11	33	-12.89
				12	6	21.34	19.34	33	-13.66
				25	0	21.09	19.09	33	-13.91
	19175	1907.5	QPSK	1	0	22.38	20.38	33	-12.62
				1	24	22.24	20.24	33	-12.76
				12	6	21.31	19.31	33	-13.69
				25	0	21.19	19.19	33	-13.81
	18625	1852.5	16QAM	1	0	21.23	19.23	33	-13.77
				1	24	21.23	19.23	33	-13.77
				12	6	20.10	18.10	33	-14.9
				25	0	19.86	17.86	33	-15.14
	18900	1880	16QAM	1	0	21.04	19.04	33	-13.96
				1	24	21.31	19.31	33	-13.69
				12	6	20.29	18.29	33	-14.71
				25	0	20.06	18.06	33	-14.94
	19175	1907.5	16QAM	1	0	21.70	19.70	33	-13.3
				1	24	21.29	19.29	33	-13.71
				12	6	20.33	18.33	33	-14.67
				25	0	20.13	18.13	33	-14.87
	18625	1852.5	64QAM	1	0	20.73	18.73	33	-14.27
				1	24	20.71	18.71	33	-14.29
				12	6	19.51	17.51	33	-15.49
				25	0	19.34	17.34	33	-15.66
	18900	1880	64QAM	1	0	20.60	18.60	33	-14.4
				1	24	20.76	18.76	33	-14.24
				12	6	19.81	17.81	33	-15.19
				25	0	19.39	17.39	33	-15.61
	19175	1907.5	64QAM	1	0	21.19	19.19	33	-13.81
				1	24	20.67	18.67	33	-14.33
				12	6	19.64	17.64	33	-15.36
				25	0	19.60	17.60	33	-15.4

Unless otherwise stated the results shown in this test report refer only to the sample(s) tested and such sample(s) are retained for 90 days only.

除非另有說明，此報告結果僅對測試之樣品負責，同時此樣品僅保留90天。本報告未經本公司書面許可，不可部份複製。

This document is issued by the Company subject to its General Conditions of Service printed overleaf, available on request or accessible at www.sgs.com/terms_and_conditions.htm and for electronic format documents, subject to Terms and Conditions for Electronic Documents at www.sgs.com/terms_e-document.htm. Attention is drawn to the limitation of liability, indemnification and jurisdiction issues defined therein. Any holder of this document is advised that information contained hereon reflects the Company's findings at the time of its intervention only and within the limits of Client's instructions, if any. The Company's sole responsibility is to its Client and this document does not exonerate parties to a transaction from exercising all their rights and obligations under the transaction documents. This document cannot be reproduced except in full, without prior written approval of the Company. Any unauthorized alteration, forgery or falsification of the content or appearance of this document is unlawful and offenders may be prosecuted to the fullest extent of the law.

Antenna gain (dBi) -2

LTE Band 2_Uplink frequency band : 1850 to 1910 MHz									
BW (MHz)	UL Channel	Frequency (MHz)	Modulation	RB Size	RB Offset	Conducted Average (dBm)	EIRP Average (dBm)	EIRP Limit (dBm)	Margin (dB)
10	18650	1855	QPSK	1	0	22.10	20.10	33	-12.9
				1	49	21.99	19.99	33	-13.01
				25	12	21.07	19.07	33	-13.93
				50	0	20.82	18.82	33	-14.18
	18900	1880	QPSK	1	0	21.92	19.92	33	-13.08
				1	49	22.18	20.18	33	-12.82
				25	12	21.21	19.21	33	-13.79
				50	0	21.20	19.20	33	-13.8
	19150	1905	QPSK	1	0	22.37	20.37	33	-12.63
				1	49	22.10	20.10	33	-12.9
				25	12	21.20	19.20	33	-13.8
				50	0	21.22	19.22	33	-13.78
	18650	1855	16QAM	1	0	21.13	19.13	33	-13.87
				1	49	21.24	19.24	33	-13.76
				25	12	20.20	18.20	33	-14.8
				50	0	19.99	17.99	33	-15.01
	18900	1880	16QAM	1	0	21.03	19.03	33	-13.97
				1	49	21.21	19.21	33	-13.79
				25	12	20.32	18.32	33	-14.68
				50	0	20.00	18.00	33	-15
	19150	1905	16QAM	1	0	21.77	19.77	33	-13.23
				1	49	21.18	19.18	33	-13.82
				25	12	20.26	18.26	33	-14.74
				50	0	20.14	18.14	33	-14.86
	18650	1855	64QAM	1	0	20.73	18.73	33	-14.27
				1	49	20.77	18.77	33	-14.23
				25	12	19.57	17.57	33	-15.43
				50	0	19.30	17.30	33	-15.7
	18900	1880	64QAM	1	0	20.58	18.58	33	-14.42
				1	49	20.73	18.73	33	-14.27
				25	12	19.66	17.66	33	-15.34
				50	0	19.43	17.43	33	-15.57
	19150	1905	64QAM	1	0	21.30	19.30	33	-13.7
				1	49	20.70	18.70	33	-14.3
				25	12	19.70	17.70	33	-15.3
				50	0	19.68	17.68	33	-15.32

Unless otherwise stated the results shown in this test report refer only to the sample(s) tested and such sample(s) are retained for 90 days only.

除非另有說明，此報告結果僅對測試之樣品負責，同時此樣品僅保留90天。本報告未經本公司書面許可，不可部份複製。

This document is issued by the Company subject to its General Conditions of Service printed overleaf, available on request or accessible at www.sgs.com/terms_and_conditions.htm and for electronic format documents, subject to Terms and Conditions for Electronic Documents at www.sgs.com/terms_e-document.htm. Attention is drawn to the limitation of liability, indemnification and jurisdiction issues defined therein. Any holder of this document is advised that information contained hereon reflects the Company's findings at the time of its intervention only and within the limits of Client's instructions, if any. The Company's sole responsibility is to its Client and this document does not exonerate parties to a transaction from exercising all their rights and obligations under the transaction documents. This document cannot be reproduced except in full, without prior written approval of the Company. Any unauthorized alteration, forgery or falsification of the content or appearance of this document is unlawful and offenders may be prosecuted to the fullest extent of the law.

Antenna gain (dBi) -2

LTE Band 2_Uplink frequency band : 1850 to 1910 MHz									
BW (MHz)	UL Channel	Frequency (MHz)	Modulation	RB Size	RB Offset	Conducted Average (dBm)	EIRP Average (dBm)	EIRP Limit (dBm)	Margin (dB)
15	18675	1857.5	QPSK	1	0	22.13	20.13	33	-12.87
				1	74	22.00	20.00	33	-13
				36	18	21.14	19.14	33	-13.86
				75	0	20.85	18.85	33	-14.15
	18900	1880	QPSK	1	0	22.03	20.03	33	-12.97
				1	74	22.26	20.26	33	-12.74
				36	18	21.24	19.24	33	-13.76
				75	0	21.25	19.25	33	-13.75
	19125	1902.5	QPSK	1	0	22.39	20.39	33	-12.61
				1	74	22.17	20.17	33	-12.83
				36	18	21.35	19.35	33	-13.65
				75	0	21.09	19.09	33	-13.91
	18675	1857.5	16QAM	1	0	21.08	19.08	33	-13.92
				1	74	21.22	19.22	33	-13.78
				36	18	20.17	18.17	33	-14.83
				75	0	19.95	17.95	33	-15.05
	18900	1880	16QAM	1	0	21.09	19.09	33	-13.91
				1	74	21.32	19.32	33	-13.68
				36	18	20.46	18.46	33	-14.54
				75	0	20.06	18.06	33	-14.94
	19125	1902.5	16QAM	1	0	21.72	19.72	33	-13.28
				1	74	21.22	19.22	33	-13.78
				36	18	20.33	18.33	33	-14.67
				75	0	20.07	18.07	33	-14.93
	18675	1857.5	64QAM	1	0	20.74	18.74	33	-14.26
				1	74	20.80	18.80	33	-14.2
				36	18	19.39	17.39	33	-15.61
				75	0	19.47	17.47	33	-15.53
	18900	1880	64QAM	1	0	20.55	18.55	33	-14.45
				1	74	20.81	18.81	33	-14.19
				36	18	19.62	17.62	33	-15.38
				75	0	19.43	17.43	33	-15.57
	19125	1902.5	64QAM	1	0	21.21	19.21	33	-13.79
				1	74	20.73	18.73	33	-14.27
				36	18	19.65	17.65	33	-15.35
				75	0	19.53	17.53	33	-15.47

Unless otherwise stated the results shown in this test report refer only to the sample(s) tested and such sample(s) are retained for 90 days only.

除非另有說明，此報告結果僅對測試之樣品負責，同時此樣品僅保留90天。本報告未經本公司書面許可，不可部份複製。

This document is issued by the Company subject to its General Conditions of Service printed overleaf, available on request or accessible at www.sgs.com/terms_and_conditions.htm and for electronic format documents, subject to Terms and Conditions for Electronic Documents at www.sgs.com/terms_e-document.htm. Attention is drawn to the limitation of liability, indemnification and jurisdiction issues defined therein. Any holder of this document is advised that information contained hereon reflects the Company's findings at the time of its intervention only and within the limits of Client's instructions, if any. The Company's sole responsibility is to its Client and this document does not exonerate parties to a transaction from exercising all their rights and obligations under the transaction documents. This document cannot be reproduced except in full, without prior written approval of the Company. Any unauthorized alteration, forgery or falsification of the content or appearance of this document is unlawful and offenders may be prosecuted to the fullest extent of the law.

Antenna gain (dBi) -2

LTE Band 2_Uplink frequency band : 1850 to 1910 MHz									
BW (MHz)	UL Channel	Frequency (MHz)	Modulation	RB Size	RB Offset	Conducted Average (dBm)	EIRP Average (dBm)	EIRP Limit (dBm)	Margin (dB)
20	18700	1860	QPSK	1	0	22.22	20.22	33	-12.78
				1	99	22.02	20.02	33	-12.98
				50	25	21.25	19.25	33	-13.75
				100	0	21.01	19.01	33	-13.99
	18900	1880	QPSK	1	0	22.09	20.09	33	-12.91
				1	99	22.30	20.30	33	-12.7
				50	25	21.38	19.38	33	-13.62
				100	0	21.14	19.14	33	-13.86
	19100	1900	QPSK	1	0	22.53	20.53	33	-12.47
				1	99	22.25	20.25	33	-12.75
				50	25	21.38	19.38	33	-13.62
				100	0	21.26	19.26	33	-13.74
	18700	1860	16QAM	1	0	21.23	19.23	33	-13.77
				1	99	21.39	19.39	33	-13.61
				50	25	20.24	18.24	33	-14.76
				100	0	20.00	18.00	33	-15
	18900	1880	16QAM	1	0	21.18	19.18	33	-13.82
				1	99	21.39	19.39	33	-13.61
				50	25	20.46	18.46	33	-14.54
				100	0	20.18	18.18	33	-14.82
	19100	1900	16QAM	1	0	21.84	19.84	33	-13.16
				1	99	21.35	19.35	33	-13.65
				50	25	20.37	18.37	33	-14.63
				100	0	20.24	18.24	33	-14.76
	18700	1860	64QAM	1	0	20.74	18.74	33	-14.26
				1	99	20.88	18.88	33	-14.12
				50	25	19.59	17.59	33	-15.41
				100	0	19.47	17.47	33	-15.53
	18900	1880	64QAM	1	0	20.69	18.69	33	-14.31
				1	99	20.89	18.89	33	-14.11
				50	25	19.82	17.82	33	-15.18
				100	0	19.56	17.56	33	-15.44
	19100	1900	64QAM	1	0	21.30	19.30	33	-13.7
				1	99	20.81	18.81	33	-14.19
				50	25	19.80	17.80	33	-15.2
				100	0	19.68	17.68	33	-15.32

Unless otherwise stated the results shown in this test report refer only to the sample(s) tested and such sample(s) are retained for 90 days only.

除非另有說明，此報告結果僅對測試之樣品負責，同時此樣品僅保留90天。本報告未經本公司書面許可，不可部份複製。

This document is issued by the Company subject to its General Conditions of Service printed overleaf, available on request or accessible at www.sgs.com/terms_and_conditions.htm and for electronic format documents, subject to Terms and Conditions for Electronic Documents at www.sgs.com/terms_e-document.htm. Attention is drawn to the limitation of liability, indemnification and jurisdiction issues defined therein. Any holder of this document is advised that information contained hereon reflects the Company's findings at the time of its intervention only and within the limits of Client's instructions, if any. The Company's sole responsibility is to its Client and this document does not exonerate parties to a transaction from exercising all their rights and obligations under the transaction documents. This document cannot be reproduced except in full, without prior written approval of the Company. Any unauthorized alteration, forgery or falsification of the content or appearance of this document is unlawful and offenders may be prosecuted to the fullest extent of the law.

Antenna gain (dBi) -3.7

LTE Band 4_Uplink frequency band : 1710 to 1755 MHz									
BW (MHz)	UL Channel	Frequency (MHz)	Modulation	RB Size	RB Offset	Conducted Average (dBm)	EIRP Average (dBm)	EIRP Limit (dBm)	Margin (dB)
1.4	19957	1710.7	QPSK	1	0	21.95	18.25	30	-11.75
				1	5	21.99	18.29	30	-11.71
				3	2	22.03	18.33	30	-11.67
				6	0	20.98	17.28	30	-12.72
	20175	1732.5	QPSK	1	0	22.02	18.32	30	-11.68
				1	5	21.96	18.26	30	-11.74
				3	2	21.96	18.26	30	-11.74
				6	0	20.99	17.29	30	-12.71
	20393	1754.3	QPSK	1	0	21.97	18.27	30	-11.73
				1	5	21.96	18.26	30	-11.74
				3	2	22.03	18.33	30	-11.67
				6	0	20.99	17.29	30	-12.71
	19957	1710.7	16QAM	1	0	20.95	17.25	30	-12.75
				1	5	21.03	17.33	30	-12.67
				3	2	21.04	17.34	30	-12.66
				6	0	20.40	16.70	30	-13.3
	20175	1732.5	16QAM	1	0	21.01	17.31	30	-12.69
				1	5	20.97	17.27	30	-12.73
				3	2	21.00	17.30	30	-12.7
				6	0	20.44	16.74	30	-13.26
	20393	1754.3	16QAM	1	0	21.01	17.31	30	-12.69
				1	5	21.03	17.33	30	-12.67
				3	2	20.96	17.26	30	-12.74
				6	0	20.40	16.70	30	-13.3
	19957	1710.7	64QAM	1	0	20.38	16.68	30	-13.32
				1	5	20.44	16.74	30	-13.26
				3	2	20.37	16.67	30	-13.33
				6	0	19.60	15.90	30	-14.1
	20175	1732.5	64QAM	1	0	20.41	16.71	30	-13.29
				1	5	20.38	16.68	30	-13.32
				3	2	20.44	16.74	30	-13.26
				6	0	19.61	15.91	30	-14.09
	20393	1754.3	64QAM	1	0	20.36	16.66	30	-13.34
				1	5	20.38	16.68	30	-13.32
				3	2	20.41	16.71	30	-13.29
				6	0	19.64	15.94	30	-14.06

Unless otherwise stated the results shown in this test report refer only to the sample(s) tested and such sample(s) are retained for 90 days only.

除非另有說明，此報告結果僅對測試之樣品負責，同時此樣品僅保留90天。本報告未經本公司書面許可，不可部份複製。

This document is issued by the Company subject to its General Conditions of Service printed overleaf, available on request or accessible at www.sgs.com/terms_and_conditions.htm and for electronic format documents, subject to Terms and Conditions for Electronic Documents at www.sgs.com/terms_e-document.htm. Attention is drawn to the limitation of liability, indemnification and jurisdiction issues defined therein. Any holder of this document is advised that information contained hereon reflects the Company's findings at the time of its intervention only and within the limits of Client's instructions, if any. The Company's sole responsibility is to its Client and this document does not exonerate parties to a transaction from exercising all their rights and obligations under the transaction documents. This document cannot be reproduced except in full, without prior written approval of the Company. Any unauthorized alteration, forgery or falsification of the content or appearance of this document is unlawful and offenders may be prosecuted to the fullest extent of the law.

Antenna gain (dBi) -3.7

LTE Band 4_Uplink frequency band : 1710 to 1755 MHz									
BW (MHz)	UL Channel	Frequency (MHz)	Modulation	RB Size	RB Offset	Conducted Average (dBm)	EIRP Average (dBm)	EIRP Limit (dBm)	Margin (dB)
3	19965	1711.5	QPSK	1	0	21.67	17.97	30	-12.03
				1	14	21.67	17.97	30	-12.03
				8	4	21.16	17.46	30	-12.54
				15	0	21.06	17.36	30	-12.64
	20175	1732.5	QPSK	1	0	21.57	17.87	30	-12.13
				1	14	21.71	18.01	30	-11.99
				8	4	21.25	17.55	30	-12.45
				15	0	21.19	17.49	30	-12.51
	20385	1753.5	QPSK	1	0	21.60	17.90	30	-12.1
				1	14	21.79	18.09	30	-11.91
				8	4	21.11	17.41	30	-12.59
				15	0	20.91	17.21	30	-12.79
	19965	1711.5	16QAM	1	0	21.02	17.32	30	-12.68
				1	14	20.49	16.79	30	-13.21
				8	4	20.18	16.48	30	-13.52
				15	0	19.98	16.28	30	-13.72
	20175	1732.5	16QAM	1	0	20.87	17.17	30	-12.83
				1	14	20.49	16.79	30	-13.21
				8	4	20.29	16.59	30	-13.41
				15	0	19.96	16.26	30	-13.74
	20385	1753.5	16QAM	1	0	20.77	17.07	30	-12.93
				1	14	20.59	16.89	30	-13.11
				8	4	20.31	16.61	30	-13.39
				15	0	19.91	16.21	30	-13.79
	19965	1711.5	64QAM	1	0	20.60	16.90	30	-13.1
				1	14	19.82	16.12	30	-13.88
				8	4	19.48	15.78	30	-14.22
				15	0	19.51	15.81	30	-14.19
	20175	1732.5	64QAM	1	0	20.16	16.46	30	-13.54
				1	14	19.76	16.06	30	-13.94
				8	4	19.72	16.02	30	-13.98
				15	0	19.51	15.81	30	-14.19
	20385	1753.5	64QAM	1	0	20.20	16.50	30	-13.5
				1	14	19.86	16.16	30	-13.84
				8	4	19.58	15.88	30	-14.12
				15	0	19.28	15.58	30	-14.42

Unless otherwise stated the results shown in this test report refer only to the sample(s) tested and such sample(s) are retained for 90 days only.

除非另有說明，此報告結果僅對測試之樣品負責，同時此樣品僅保留90天。本報告未經本公司書面許可，不可部份複製。

This document is issued by the Company subject to its General Conditions of Service printed overleaf, available on request or accessible at www.sgs.com/terms_and_conditions.htm and for electronic format documents, subject to Terms and Conditions for Electronic Documents at www.sgs.com/terms_e-document.htm. Attention is drawn to the limitation of liability, indemnification and jurisdiction issues defined therein. Any holder of this document is advised that information contained hereon reflects the Company's findings at the time of its intervention only and within the limits of Client's instructions, if any. The Company's sole responsibility is to its Client and this document does not exonerate parties to a transaction from exercising all their rights and obligations under the transaction documents. This document cannot be reproduced except in full, without prior written approval of the Company. Any unauthorized alteration, forgery or falsification of the content or appearance of this document is unlawful and offenders may be prosecuted to the fullest extent of the law.

Antenna gain (dBi) -3.7

LTE Band 4_Uplink frequency band : 1710 to 1755 MHz									
BW (MHz)	UL Channel	Frequency (MHz)	Modulation	RB Size	RB Offset	Conducted Average (dBm)	EIRP Average (dBm)	EIRP Limit (dBm)	Margin (dB)
5	19975	1712.5	QPSK	1	0	21.72	18.02	30	-11.98
				1	24	21.65	17.95	30	-12.05
				12	6	21.17	17.47	30	-12.53
				25	0	21.11	17.41	30	-12.59
	20175	1732.5	QPSK	1	0	21.68	17.98	30	-12.02
				1	24	21.60	17.90	30	-12.1
				12	6	21.12	17.42	30	-12.58
				25	0	21.17	17.47	30	-12.53
	20375	1752.5	QPSK	1	0	21.66	17.96	30	-12.04
				1	24	21.86	18.16	30	-11.84
				12	6	21.30	17.60	30	-12.4
				25	0	21.06	17.36	30	-12.64
	19975	1712.5	16QAM	1	0	21.11	17.41	30	-12.59
				1	24	20.39	16.69	30	-13.31
				12	6	20.26	16.56	30	-13.44
				25	0	20.02	16.32	30	-13.68
	20175	1732.5	16QAM	1	0	20.86	17.16	30	-12.84
				1	24	20.47	16.77	30	-13.23
				12	6	20.39	16.69	30	-13.31
				25	0	20.01	16.31	30	-13.69
	20375	1752.5	16QAM	1	0	20.83	17.13	30	-12.87
				1	24	20.45	16.75	30	-13.25
				12	6	20.32	16.62	30	-13.38
				25	0	19.93	16.23	30	-13.77
	19975	1712.5	64QAM	1	0	20.47	16.77	30	-13.23
				1	24	19.82	16.12	30	-13.88
				12	6	19.46	15.76	30	-14.24
				25	0	19.53	15.83	30	-14.17
	20175	1732.5	64QAM	1	0	20.13	16.43	30	-13.57
				1	24	19.77	16.07	30	-13.93
				12	6	19.75	16.05	30	-13.95
				25	0	19.39	15.69	30	-14.31
	20375	1752.5	64QAM	1	0	20.05	16.35	30	-13.65
				1	24	19.87	16.17	30	-13.83
				12	6	19.69	15.99	30	-14.01
				25	0	19.28	15.58	30	-14.42

Unless otherwise stated the results shown in this test report refer only to the sample(s) tested and such sample(s) are retained for 90 days only.

除非另有說明，此報告結果僅對測試之樣品負責，同時此樣品僅保留90天。本報告未經本公司書面許可，不可部份複製。

This document is issued by the Company subject to its General Conditions of Service printed overleaf, available on request or accessible at www.sgs.com/terms_and_conditions.htm and for electronic format documents, subject to Terms and Conditions for Electronic Documents at www.sgs.com/terms_e-document.htm. Attention is drawn to the limitation of liability, indemnification and jurisdiction issues defined therein. Any holder of this document is advised that information contained hereon reflects the Company's findings at the time of its intervention only and within the limits of Client's instructions, if any. The Company's sole responsibility is to its Client and this document does not exonerate parties to a transaction from exercising all their rights and obligations under the transaction documents. This document cannot be reproduced except in full, without prior written approval of the Company. Any unauthorized alteration, forgery or falsification of the content or appearance of this document is unlawful and offenders may be prosecuted to the fullest extent of the law.

Antenna gain (dBi) -3.7

LTE Band 4_Uplink frequency band : 1710 to 1755 MHz									
BW (MHz)	UL Channel	Frequency (MHz)	Modulation	RB Size	RB Offset	Conducted Average (dBm)	EIRP Average (dBm)	EIRP Limit (dBm)	Margin (dB)
10	20000	1715	QPSK	1	0	21.72	18.02	30	-11.98
				1	49	21.62	17.92	30	-12.08
				25	12	21.13	17.43	30	-12.57
				50	0	21.11	17.41	30	-12.59
	20175	1732.5	QPSK	1	0	21.65	17.95	30	-12.05
				1	49	21.67	17.97	30	-12.03
				25	12	21.22	17.52	30	-12.48
				50	0	21.02	17.32	30	-12.68
	20375	1750	QPSK	1	0	21.55	17.85	30	-12.15
				1	49	21.72	18.02	30	-11.98
				25	12	21.17	17.47	30	-12.53
				50	0	20.97	17.27	30	-12.73
	20000	1715	16QAM	1	0	20.95	17.25	30	-12.75
				1	49	20.48	16.78	30	-13.22
				25	12	20.15	16.45	30	-13.55
				50	0	20.05	16.35	30	-13.65
	20175	1732.5	16QAM	1	0	20.76	17.06	30	-12.94
				1	49	20.50	16.80	30	-13.2
				25	12	20.26	16.56	30	-13.44
				50	0	20.01	16.31	30	-13.69
	20375	1750	16QAM	1	0	20.67	16.97	30	-13.03
				1	49	20.59	16.89	30	-13.11
				25	12	20.27	16.57	30	-13.43
				50	0	20.09	16.39	30	-13.61
	20000	1715	64QAM	1	0	20.50	16.80	30	-13.2
				1	49	19.83	16.13	30	-13.87
				25	12	19.42	15.72	30	-14.28
				50	0	19.56	15.86	30	-14.14
	20175	1732.5	64QAM	1	0	20.17	16.47	30	-13.53
				1	49	19.81	16.11	30	-13.89
				25	12	19.69	15.99	30	-14.01
				50	0	19.49	15.79	30	-14.21
	20375	1750	64QAM	1	0	20.21	16.51	30	-13.49
				1	49	19.91	16.21	30	-13.79
				25	12	19.71	16.01	30	-13.99
				50	0	19.35	15.65	30	-14.35

Unless otherwise stated the results shown in this test report refer only to the sample(s) tested and such sample(s) are retained for 90 days only.

除非另有說明，此報告結果僅對測試之樣品負責，同時此樣品僅保留90天。本報告未經本公司書面許可，不可部份複製。

This document is issued by the Company subject to its General Conditions of Service printed overleaf, available on request or accessible at www.sgs.com/terms_and_conditions.htm and for electronic format documents, subject to Terms and Conditions for Electronic Documents at www.sgs.com/terms_e-document.htm. Attention is drawn to the limitation of liability, indemnification and jurisdiction issues defined therein. Any holder of this document is advised that information contained hereon reflects the Company's findings at the time of its intervention only and within the limits of Client's instructions, if any. The Company's sole responsibility is to its Client and this document does not exonerate parties to a transaction from exercising all their rights and obligations under the transaction documents. This document cannot be reproduced except in full, without prior written approval of the Company. Any unauthorized alteration, forgery or falsification of the content or appearance of this document is unlawful and offenders may be prosecuted to the fullest extent of the law.

Antenna gain (dBi) -3.7

LTE Band 4_Uplink frequency band : 1710 to 1755 MHz									
BW (MHz)	UL Channel	Frequency (MHz)	Modulation	RB Size	RB Offset	Conducted Average (dBm)	EIRP Average (dBm)	EIRP Limit (dBm)	Margin (dB)
15	20025	1717.5	QPSK	1	0	21.78	18.08	30	-11.92
				1	74	21.59	17.89	30	-12.11
				36	18	21.23	17.53	30	-12.47
				75	0	21.08	17.38	30	-12.62
	20175	1732.5	QPSK	1	0	21.62	17.92	30	-12.08
				1	74	21.59	17.89	30	-12.11
				36	18	21.28	17.58	30	-12.42
				75	0	21.04	17.34	30	-12.66
	20325	1747.5	QPSK	1	0	21.52	17.82	30	-12.18
				1	74	21.75	18.05	30	-11.95
				36	18	21.22	17.52	30	-12.48
				75	0	21.05	17.35	30	-12.65
	20025	1717.5	16QAM	1	0	21.01	17.31	30	-12.69
				1	74	20.45	16.75	30	-13.25
				36	18	20.17	16.47	30	-13.53
				75	0	19.99	16.29	30	-13.71
	20175	1732.5	16QAM	1	0	20.74	17.04	30	-12.96
				1	74	20.48	16.78	30	-13.22
				36	18	20.35	16.65	30	-13.35
				75	0	20.09	16.39	30	-13.61
	20325	1747.5	16QAM	1	0	20.72	17.02	30	-12.98
				1	74	20.47	16.77	30	-13.23
				36	18	20.29	16.59	30	-13.41
				75	0	19.91	16.21	30	-13.79
	20025	1717.5	64QAM	1	0	20.47	16.77	30	-13.23
				1	74	19.89	16.19	30	-13.81
				36	18	19.42	15.72	30	-14.28
				75	0	19.56	15.86	30	-14.14
	20175	1732.5	64QAM	1	0	20.13	16.43	30	-13.57
				1	74	19.93	16.23	30	-13.77
				36	18	19.84	16.14	30	-13.86
				75	0	19.53	15.83	30	-14.17
	20325	1747.5	64QAM	1	0	20.10	16.40	30	-13.6
				1	74	19.87	16.17	30	-13.83
				36	18	19.73	16.03	30	-13.97
				75	0	19.34	15.64	30	-14.36

Unless otherwise stated the results shown in this test report refer only to the sample(s) tested and such sample(s) are retained for 90 days only.

除非另有說明，此報告結果僅對測試之樣品負責，同時此樣品僅保留90天。本報告未經本公司書面許可，不可部份複製。

This document is issued by the Company subject to its General Conditions of Service printed overleaf, available on request or accessible at www.sgs.com/terms_and_conditions.htm and for electronic format documents, subject to Terms and Conditions for Electronic Documents at www.sgs.com/terms_e-document.htm. Attention is drawn to the limitation of liability, indemnification and jurisdiction issues defined therein. Any holder of this document is advised that information contained hereon reflects the Company's findings at the time of its intervention only and within the limits of Client's instructions, if any. The Company's sole responsibility is to its Client and this document does not exonerate parties to a transaction from exercising all their rights and obligations under the transaction documents. This document cannot be reproduced except in full, without prior written approval of the Company. Any unauthorized alteration, forgery or falsification of the content or appearance of this document is unlawful and offenders may be prosecuted to the fullest extent of the law.

Antenna gain (dBi) -3.7

LTE Band 4_Uplink frequency band : 1710 to 1755 MHz									
BW (MHz)	UL Channel	Frequency (MHz)	Modulation	RB Size	RB Offset	Conducted Average (dBm)	EIRP Average (dBm)	EIRP Limit (dBm)	Margin (dB)
20	20050	1720	QPSK	1	0	21.81	18.11	30	-11.89
				1	99	21.78	18.08	30	-11.92
				50	25	21.28	17.58	30	-12.42
				100	0	21.19	17.49	30	-12.51
	20175	1732.5	QPSK	1	0	21.75	18.05	30	-11.95
				1	99	21.73	18.03	30	-11.97
				50	25	21.32	17.62	30	-12.38
				100	0	21.20	17.50	30	-12.5
	20300	1745	QPSK	1	0	21.71	18.01	30	-11.99
				1	99	21.86	18.16	30	-11.84
				50	25	21.30	17.60	30	-12.4
				100	0	21.10	17.40	30	-12.6
	20050	1720	16QAM	1	0	21.12	17.42	30	-12.58
				1	99	20.54	16.84	30	-13.16
				50	25	20.27	16.57	30	-13.43
				100	0	20.12	16.42	30	-13.58
	20175	1732.5	16QAM	1	0	20.91	17.21	30	-12.79
				1	99	20.55	16.85	30	-13.15
				50	25	20.44	16.74	30	-13.26
				100	0	20.14	16.44	30	-13.56
	20300	1745	16QAM	1	0	20.84	17.14	30	-12.86
				1	99	20.62	16.92	30	-13.08
				50	25	20.36	16.66	30	-13.34
				100	0	20.10	16.40	30	-13.6
	20050	1720	64QAM	1	0	20.60	16.90	30	-13.1
				1	99	19.97	16.27	30	-13.73
				50	25	19.61	15.91	30	-14.09
				100	0	19.57	15.87	30	-14.13
	20175	1732.5	64QAM	1	0	20.25	16.55	30	-13.45
				1	99	19.95	16.25	30	-13.75
				50	25	19.85	16.15	30	-13.85
				100	0	19.53	15.83	30	-14.17
	20300	1745	64QAM	1	0	20.22	16.52	30	-13.48
				1	99	19.99	16.29	30	-13.71
				50	25	19.73	16.03	30	-13.97
				100	0	19.41	15.71	30	-14.29

Unless otherwise stated the results shown in this test report refer only to the sample(s) tested and such sample(s) are retained for 90 days only.

除非另有說明，此報告結果僅對測試之樣品負責，同時此樣品僅保留90天。本報告未經本公司書面許可，不可部份複製。

This document is issued by the Company subject to its General Conditions of Service printed overleaf, available on request or accessible at www.sgs.com/terms_and_conditions.htm and for electronic format documents, subject to Terms and Conditions for Electronic Documents at www.sgs.com/terms_e-document.htm. Attention is drawn to the limitation of liability, indemnification and jurisdiction issues defined therein. Any holder of this document is advised that information contained hereon reflects the Company's findings at the time of its intervention only and within the limits of Client's instructions, if any. The Company's sole responsibility is to its Client and this document does not exonerate parties to a transaction from exercising all their rights and obligations under the transaction documents. This document cannot be reproduced except in full, without prior written approval of the Company. Any unauthorized alteration, forgery or falsification of the content or appearance of this document is unlawful and offenders may be prosecuted to the fullest extent of the law.

Antenna gain (dBi) -5.4

LTE Band 5_Uplink frequency band : 824 to 849 MHz										
BW (MHz)	UL Channel	Frequency (MHz)	Modulation	RB Size	RB Offset	Conducted Average (dBm)	ERP Average (dBm)	EIRP Average (dBm)	EIRP Limit (dBm)	Margin (dB)
1.4	20407	824.7	QPSK	1	0	22.54	14.99	17.14	38.45	-21.31
				1	5	22.46	14.91	17.06	38.45	-21.39
				3	2	22.52	14.97	17.12	38.45	-21.33
				6	0	21.49	13.94	16.09	38.45	-22.36
	20525	836.5	QPSK	1	0	22.49	14.94	17.09	38.45	-21.36
				1	5	22.49	14.94	17.09	38.45	-21.36
				3	2	22.51	14.96	17.11	38.45	-21.34
				6	0	21.51	13.96	16.11	38.45	-22.34
	20643	848.3	QPSK	1	0	22.52	14.97	17.12	38.45	-21.33
				1	5	22.53	14.98	17.13	38.45	-21.32
				3	2	22.51	14.96	17.11	38.45	-21.34
				6	0	21.49	13.94	16.09	38.45	-22.36
	20407	824.7	16QAM	1	0	21.52	13.97	16.12	38.45	-22.33
				1	5	21.53	13.98	16.13	38.45	-22.32
				3	2	21.45	13.90	16.05	38.45	-22.4
				6	0	20.47	12.92	15.07	38.45	-23.38
	20525	836.5	16QAM	1	0	21.47	13.92	16.07	38.45	-22.38
				1	5	21.46	13.91	16.06	38.45	-22.39
				3	2	21.47	13.92	16.07	38.45	-22.38
				6	0	20.46	12.91	15.06	38.45	-23.39
	20643	848.3	16QAM	1	0	21.48	13.93	16.08	38.45	-22.37
				1	5	21.47	13.92	16.07	38.45	-22.38
				3	2	21.55	14.00	16.15	38.45	-22.3
				6	0	20.54	12.99	15.14	38.45	-23.31
	20407	824.7	64QAM	1	0	20.81	13.26	15.41	38.45	-23.04
				1	5	20.82	13.27	15.42	38.45	-23.03
				3	2	20.67	13.12	15.27	38.45	-23.18
				6	0	19.74	12.19	14.34	38.45	-24.11
	20525	836.5	64QAM	1	0	20.76	13.21	15.36	38.45	-23.09
				1	5	20.72	13.17	15.32	38.45	-23.13
				3	2	20.72	13.17	15.32	38.45	-23.13
				6	0	19.70	12.15	14.30	38.45	-24.15
	20643	848.3	64QAM	1	0	20.74	13.19	15.34	38.45	-23.11
				1	5	20.75	13.20	15.35	38.45	-23.1
				3	2	20.75	13.20	15.35	38.45	-23.1
				6	0	19.77	12.22	14.37	38.45	-24.08

Unless otherwise stated the results shown in this test report refer only to the sample(s) tested and such sample(s) are retained for 90 days only.

除非另有說明，此報告結果僅對測試之樣品負責，同時此樣品僅保留90天。本報告未經本公司書面許可，不可部份複製。

This document is issued by the Company subject to its General Conditions of Service printed overleaf, available on request or accessible at www.sgs.com/terms_and_conditions.htm and for electronic format documents, subject to Terms and Conditions for Electronic Documents at www.sgs.com/terms_e-document.htm. Attention is drawn to the limitation of liability, indemnification and jurisdiction issues defined therein. Any holder of this document is advised that information contained hereon reflects the Company's findings at the time of its intervention only and within the limits of Client's instructions, if any. The Company's sole responsibility is to its Client and this document does not exonerate parties to a transaction from exercising all their rights and obligations under the transaction documents. This document cannot be reproduced except in full, without prior written approval of the Company. Any unauthorized alteration, forgery or falsification of the content or appearance of this document is unlawful and offenders may be prosecuted to the fullest extent of the law.

Antenna gain (dBi) -5.4

LTE Band 5_Uplink frequency band : 824 to 849 MHz										
BW (MHz)	UL Channel	Frequency (MHz)	Modulation	RB Size	RB Offset	Conducted Average (dBm)	ERP Average (dBm)	EIRP Average (dBm)	EIRP Limit (dBm)	Margin (dB)
3	20415	825.5	QPSK	1	0	22.48	14.93	17.08	38.45	-21.37
				1	14	22.40	14.85	17.00	38.45	-21.45
				8	4	21.32	13.77	15.92	38.45	-22.53
				15	0	21.17	13.62	15.77	38.45	-22.68
	20525	836.5	QPSK	1	0	22.49	14.94	17.09	38.45	-21.36
				1	14	22.26	14.71	16.86	38.45	-21.59
				8	4	21.50	13.95	16.10	38.45	-22.35
				15	0	21.31	13.76	15.91	38.45	-22.54
	20635	847.5	QPSK	1	0	22.20	14.65	16.80	38.45	-21.65
				1	14	22.21	14.66	16.81	38.45	-21.64
				8	4	21.57	14.02	16.17	38.45	-22.28
				15	0	21.21	13.66	15.81	38.45	-22.64
	20415	825.5	16QAM	1	0	21.23	13.68	15.83	38.45	-22.62
				1	14	22.15	14.60	16.75	38.45	-21.7
				8	4	20.25	12.70	14.85	38.45	-23.6
				15	0	20.29	12.74	14.89	38.45	-23.56
	20525	836.5	16QAM	1	0	21.22	13.67	15.82	38.45	-22.63
				1	14	21.71	14.16	16.31	38.45	-22.14
				8	4	20.38	12.83	14.98	38.45	-23.47
				15	0	20.34	12.79	14.94	38.45	-23.51
	20635	847.5	16QAM	1	0	21.60	14.05	16.20	38.45	-22.25
				1	14	21.89	14.34	16.49	38.45	-21.96
				8	4	20.47	12.92	15.07	38.45	-23.38
				15	0	20.30	12.75	14.90	38.45	-23.55
	20415	825.5	64QAM	1	0	20.64	13.09	15.24	38.45	-23.21
				1	14	21.40	13.85	16.00	38.45	-22.45
				8	4	19.62	12.07	14.22	38.45	-24.23
				15	0	19.62	12.07	14.22	38.45	-24.23
	20525	836.5	64QAM	1	0	20.62	13.07	15.22	38.45	-23.23
				1	14	21.10	13.55	15.70	38.45	-22.75
				8	4	19.91	12.36	14.51	38.45	-23.94
				15	0	19.72	12.17	14.32	38.45	-24.13
	20635	847.5	64QAM	1	0	20.93	13.38	15.53	38.45	-22.92
				1	14	21.37	13.82	15.97	38.45	-22.48
				8	4	19.77	12.22	14.37	38.45	-24.08
				15	0	19.74	12.19	14.34	38.45	-24.11

Unless otherwise stated the results shown in this test report refer only to the sample(s) tested and such sample(s) are retained for 90 days only.

除非另有說明，此報告結果僅對測試之樣品負責，同時此樣品僅保留90天。本報告未經本公司書面許可，不可部份複製。

This document is issued by the Company subject to its General Conditions of Service printed overleaf, available on request or accessible at www.sgs.com/terms_and_conditions.htm and for electronic format documents, subject to Terms and Conditions for Electronic Documents at www.sgs.com/terms_e-document.htm. Attention is drawn to the limitation of liability, indemnification and jurisdiction issues defined therein. Any holder of this document is advised that information contained hereon reflects the Company's findings at the time of its intervention only and within the limits of Client's instructions, if any. The Company's sole responsibility is to its Client and this document does not exonerate parties to a transaction from exercising all their rights and obligations under the transaction documents. This document cannot be reproduced except in full, without prior written approval of the Company. Any unauthorized alteration, forgery or falsification of the content or appearance of this document is unlawful and offenders may be prosecuted to the fullest extent of the law.

Antenna gain (dBi) -5.4

LTE Band 5_Uplink frequency band : 824 to 849 MHz										
BW (MHz)	UL Channel	Frequency (MHz)	Modulation	RB Size	RB Offset	Conducted Average (dBm)	ERP Average (dBm)	EIRP Average (dBm)	EIRP Limit (dBm)	Margin (dB)
5	20425	826.5	QPSK	1	0	22.51	14.96	17.11	38.45	-21.34
				1	24	22.52	14.97	17.12	38.45	-21.33
				12	6	21.40	13.85	16.00	38.45	-22.45
				25	0	21.21	13.66	15.81	38.45	-22.64
	20525	836.5	QPSK	1	0	22.34	14.79	16.94	38.45	-21.51
				1	24	22.38	14.83	16.98	38.45	-21.47
				12	6	21.46	13.91	16.06	38.45	-22.39
				25	0	21.19	13.64	15.79	38.45	-22.66
	20625	846.5	QPSK	1	0	22.20	14.65	16.80	38.45	-21.65
				1	24	22.23	14.68	16.83	38.45	-21.62
				12	6	21.50	13.95	16.10	38.45	-22.35
				25	0	21.23	13.68	15.83	38.45	-22.62
	20425	826.5	16QAM	1	0	21.31	13.76	15.91	38.45	-22.54
				1	24	22.06	14.51	16.66	38.45	-21.79
				12	6	20.39	12.84	14.99	38.45	-23.46
				25	0	20.14	12.59	14.74	38.45	-23.71
	20525	836.5	16QAM	1	0	21.24	13.69	15.84	38.45	-22.61
				1	24	21.76	14.21	16.36	38.45	-22.09
				12	6	20.35	12.80	14.95	38.45	-23.5
				25	0	20.25	12.70	14.85	38.45	-23.6
	20625	846.5	16QAM	1	0	21.57	14.02	16.17	38.45	-22.28
				1	24	21.99	14.44	16.59	38.45	-21.86
				12	6	20.36	12.81	14.96	38.45	-23.49
				25	0	20.33	12.78	14.93	38.45	-23.52
	20425	826.5	64QAM	1	0	20.71	13.16	15.31	38.45	-23.14
				1	24	21.40	13.85	16.00	38.45	-22.45
				12	6	19.61	12.06	14.21	38.45	-24.24
				25	0	19.73	12.18	14.33	38.45	-24.12
	20525	836.5	64QAM	1	0	20.58	13.03	15.18	38.45	-23.27
				1	24	21.06	13.51	15.66	38.45	-22.79
				12	6	19.95	12.40	14.55	38.45	-23.9
				25	0	19.69	12.14	14.29	38.45	-24.16
	20625	846.5	64QAM	1	0	20.95	13.40	15.55	38.45	-22.9
				1	24	21.41	13.86	16.01	38.45	-22.44
				12	6	19.71	12.16	14.31	38.45	-24.14
				25	0	19.66	12.11	14.26	38.45	-24.19

Unless otherwise stated the results shown in this test report refer only to the sample(s) tested and such sample(s) are retained for 90 days only.

除非另有說明，此報告結果僅對測試之樣品負責，同時此樣品僅保留90天。本報告未經本公司書面許可，不可部份複製。

This document is issued by the Company subject to its General Conditions of Service printed overleaf, available on request or accessible at www.sgs.com/terms_and_conditions.htm and for electronic format documents, subject to Terms and Conditions for Electronic Documents at www.sgs.com/terms_e-document.htm. Attention is drawn to the limitation of liability, indemnification and jurisdiction issues defined therein. Any holder of this document is advised that information contained hereon reflects the Company's findings at the time of its intervention only and within the limits of Client's instructions, if any. The Company's sole responsibility is to its Client and this document does not exonerate parties to a transaction from exercising all their rights and obligations under the transaction documents. This document cannot be reproduced except in full, without prior written approval of the Company. Any unauthorized alteration, forgery or falsification of the content or appearance of this document is unlawful and offenders may be prosecuted to the fullest extent of the law.

Antenna gain (dBi) -5.4

LTE Band 5_Uplink frequency band : 824 to 849 MHz										
BW (MHz)	UL Channel	Frequency (MHz)	Modulation	RB Size	RB Offset	Conducted Average (dBm)	ERP Average (dBm)	EIRP Average (dBm)	EIRP Limit (dBm)	Margin (dB)
10	20450	829	QPSK	1	0	22.58	15.03	17.18	38.45	-21.27
				1	49	22.56	15.01	17.16	38.45	-21.29
				25	12	21.48	13.93	16.08	38.45	-22.37
				50	0	21.34	13.79	15.94	38.45	-22.51
	20525	836.5	QPSK	1	0	22.51	14.96	17.11	38.45	-21.34
				1	49	22.40	14.85	17.00	38.45	-21.45
				25	12	21.51	13.96	16.11	38.45	-22.34
				50	0	21.35	13.80	15.95	38.45	-22.5
	20600	844	QPSK	1	0	22.37	14.82	16.97	38.45	-21.48
				1	49	22.36	14.81	16.96	38.45	-21.49
				25	12	21.63	14.08	16.23	38.45	-22.22
				50	0	21.41	13.86	16.01	38.45	-22.44
	20450	829	16QAM	1	0	21.40	13.85	16.00	38.45	-22.45
				1	49	22.20	14.65	16.80	38.45	-21.65
				25	12	20.44	12.89	15.04	38.45	-23.41
				50	0	20.31	12.76	14.91	38.45	-23.54
	20525	836.5	16QAM	1	0	21.39	13.84	15.99	38.45	-22.46
				1	49	21.80	14.25	16.40	38.45	-22.05
				25	12	20.55	13.00	15.15	38.45	-23.3
				50	0	20.38	12.83	14.98	38.45	-23.47
	20600	844	16QAM	1	0	21.66	14.11	16.26	38.45	-22.19
				1	49	22.06	14.51	16.66	38.45	-21.79
				25	12	20.54	12.99	15.14	38.45	-23.31
				50	0	20.37	12.82	14.97	38.45	-23.48
	20450	829	64QAM	1	0	20.72	13.17	15.32	38.45	-23.13
				1	49	21.56	14.01	16.16	38.45	-22.29
				25	12	19.80	12.25	14.40	38.45	-24.05
				50	0	19.79	12.24	14.39	38.45	-24.06
	20525	836.5	64QAM	1	0	20.73	13.18	15.33	38.45	-23.12
				1	49	21.22	13.67	15.82	38.45	-22.63
				25	12	20.04	12.49	14.64	38.45	-23.81
				50	0	19.81	12.26	14.41	38.45	-24.04
	20600	844	64QAM	1	0	21.10	13.55	15.70	38.45	-22.75
				1	49	21.45	13.90	16.05	38.45	-22.4
				25	12	19.88	12.33	14.48	38.45	-23.97
				50	0	19.77	12.22	14.37	38.45	-24.08

Unless otherwise stated the results shown in this test report refer only to the sample(s) tested and such sample(s) are retained for 90 days only.

除非另有說明，此報告結果僅對測試之樣品負責，同時此樣品僅保留90天。本報告未經本公司書面許可，不可部份複製。

This document is issued by the Company subject to its General Conditions of Service printed overleaf, available on request or accessible at www.sgs.com/terms_and_conditions.htm and for electronic format documents, subject to Terms and Conditions for Electronic Documents at www.sgs.com/terms_e-document.htm. Attention is drawn to the limitation of liability, indemnification and jurisdiction issues defined therein. Any holder of this document is advised that information contained hereon reflects the Company's findings at the time of its intervention only and within the limits of Client's instructions, if any. The Company's sole responsibility is to its Client and this document does not exonerate parties to a transaction from exercising all their rights and obligations under the transaction documents. This document cannot be reproduced except in full, without prior written approval of the Company. Any unauthorized alteration, forgery or falsification of the content or appearance of this document is unlawful and offenders may be prosecuted to the fullest extent of the law.

Antenna gain (dBi) 0.5

LTE Band 7_Uplink frequency band : 2500 to 2570 MHz

BW (MHz)	UL Channel	Frequency (MHz)	Modulation	RB Size	RB Offset	Conducted Average (dBm)	EIRP Average (dBm)	EIRP Limit (dBm)	Margin (dB)
5	20775	2502.5	QPSK	1	0	22.43	22.93	33.00	-10.07
				1	24	22.44	22.94	33.00	-10.06
				12	6	21.35	21.85	33.00	-11.15
				25	0	21.34	21.84	33.00	-11.16
	21100	2535	QPSK	1	0	22.15	22.65	33.00	-10.35
				1	24	22.55	23.05	33.00	-9.95
				12	6	21.56	22.06	33.00	-10.94
				25	0	21.17	21.67	33.00	-11.33
	21375	2567.5	QPSK	1	0	22.48	22.98	33.00	-10.02
				1	24	22.51	23.01	33.00	-9.99
				12	6	21.30	21.80	33.00	-11.2
				25	0	21.24	21.74	33.00	-11.26
	20775	2502.5	16QAM	1	0	21.97	22.47	33.00	-10.53
				1	24	21.91	22.41	33.00	-10.59
				12	6	20.54	21.04	33.00	-11.96
				25	0	20.36	20.86	33.00	-12.14
	21100	2535	16QAM	1	0	21.63	22.13	33.00	-10.87
				1	24	21.45	21.95	33.00	-11.05
				12	6	20.40	20.90	33.00	-12.1
				25	0	20.22	20.72	33.00	-12.28
	21375	2567.5	16QAM	1	0	21.50	22.00	33.00	-11
				1	24	21.86	22.36	33.00	-10.64
				12	6	20.39	20.89	33.00	-12.11
				25	0	20.35	20.85	33.00	-12.15
	20775	2502.5	64QAM	1	0	21.29	21.79	33.00	-11.21
				1	24	21.45	21.95	33.00	-11.05
				12	6	20.04	20.54	33.00	-12.46
				25	0	19.78	20.28	33.00	-12.72
	21100	2535	64QAM	1	0	21.17	21.67	33.00	-11.33
				1	24	21.05	21.55	33.00	-11.45
				12	6	19.86	20.36	33.00	-12.64
				25	0	19.58	20.08	33.00	-12.92
	21375	2567.5	64QAM	1	0	20.92	21.42	33.00	-11.58
				1	24	21.30	21.80	33.00	-11.2
				12	6	19.88	20.38	33.00	-12.62
				25	0	19.60	20.10	33.00	-12.9

Unless otherwise stated the results shown in this test report refer only to the sample(s) tested and such sample(s) are retained for 90 days only.

除非另有說明，此報告結果僅對測試之樣品負責，同時此樣品僅保留90天。本報告未經本公司書面許可，不可部份複製。

This document is issued by the Company subject to its General Conditions of Service printed overleaf, available on request or accessible at www.sgs.com/terms_and_conditions.htm and for electronic format documents, subject to Terms and Conditions for Electronic Documents at www.sgs.com/terms_e-document.htm. Attention is drawn to the limitation of liability, indemnification and jurisdiction issues defined therein. Any holder of this document is advised that information contained hereon reflects the Company's findings at the time of its intervention only and within the limits of Client's instructions, if any. The Company's sole responsibility is to its Client and this document does not exonerate parties to a transaction from exercising all their rights and obligations under the transaction documents. This document cannot be reproduced except in full, without prior written approval of the Company. Any unauthorized alteration, forgery or falsification of the content or appearance of this document is unlawful and offenders may be prosecuted to the fullest extent of the law.

Antenna gain (dBi) 0.5

LTE Band 7_Uplink frequency band : 2500 to 2570 MHz									
BW (MHz)	UL Channel	Frequency (MHz)	Modulation	RB Size	RB Offset	Conducted Average (dBm)	EIRP Average (dBm)	EIRP Limit (dBm)	Margin (dB)
10	20800	2505	QPSK	1	0	22.28	22.78	33.00	-10.22
				1	49	22.54	23.04	33.00	-9.96
				25	12	21.47	21.97	33.00	-11.03
				50	0	21.36	21.86	33.00	-11.14
	21100	2535	QPSK	1	0	22.28	22.78	33.00	-10.22
				1	49	22.57	23.07	33.00	-9.93
				25	12	21.59	22.09	33.00	-10.91
				50	0	21.39	21.89	33.00	-11.11
	21350	2565	QPSK	1	0	22.33	22.83	33.00	-10.17
				1	49	22.58	23.08	33.00	-9.92
				25	12	21.43	21.93	33.00	-11.07
				50	0	21.25	21.75	33.00	-11.25
	20800	2505	16QAM	1	0	21.96	22.46	33.00	-10.54
				1	49	21.85	22.35	33.00	-10.65
				25	12	20.61	21.11	33.00	-11.89
				50	0	20.36	20.86	33.00	-12.14
	21100	2535	16QAM	1	0	21.70	22.20	33.00	-10.8
				1	49	21.56	22.06	33.00	-10.94
				25	12	20.40	20.90	33.00	-12.1
				50	0	20.13	20.63	33.00	-12.37
	21350	2565	16QAM	1	0	21.60	22.10	33.00	-10.9
				1	49	21.74	22.24	33.00	-10.76
				25	12	20.36	20.86	33.00	-12.14
				50	0	20.38	20.88	33.00	-12.12
	20800	2505	64QAM	1	0	21.44	21.94	33.00	-11.06
				1	49	21.47	21.97	33.00	-11.03
				25	12	20.00	20.50	33.00	-12.5
				50	0	19.63	20.13	33.00	-12.87
	21100	2535	64QAM	1	0	21.08	21.58	33.00	-11.42
				1	49	20.93	21.43	33.00	-11.57
				25	12	19.83	20.33	33.00	-12.67
				50	0	19.67	20.17	33.00	-12.83
	21350	2565	64QAM	1	0	20.90	21.40	33.00	-11.6
				1	49	21.30	21.80	33.00	-11.2
				25	12	19.98	20.48	33.00	-12.52
				50	0	19.68	20.18	33.00	-12.82

Unless otherwise stated the results shown in this test report refer only to the sample(s) tested and such sample(s) are retained for 90 days only.

除非另有說明，此報告結果僅對測試之樣品負責，同時此樣品僅保留90天。本報告未經本公司書面許可，不可部份複製。

This document is issued by the Company subject to its General Conditions of Service printed overleaf, available on request or accessible at www.sgs.com/terms_and_conditions.htm and for electronic format documents, subject to Terms and Conditions for Electronic Documents at www.sgs.com/terms_e-document.htm. Attention is drawn to the limitation of liability, indemnification and jurisdiction issues defined therein. Any holder of this document is advised that information contained hereon reflects the Company's findings at the time of its intervention only and within the limits of Client's instructions, if any. The Company's sole responsibility is to its Client and this document does not exonerate parties to a transaction from exercising all their rights and obligations under the transaction documents. This document cannot be reproduced except in full, without prior written approval of the Company. Any unauthorized alteration, forgery or falsification of the content or appearance of this document is unlawful and offenders may be prosecuted to the fullest extent of the law.

Antenna gain (dBi) 0.5

LTE Band 7_Uplink frequency band : 2500 to 2570 MHz

BW (MHz)	UL Channel	Frequency (MHz)	Modulation	RB Size	RB Offset	Conducted Average (dBm)	EIRP Average (dBm)	EIRP Limit (dBm)	Margin (dB)
15	20825	2507.5	QPSK	1	0	22.40	22.90	33.00	-10.1
				1	74	22.61	23.11	33.00	-9.89
				36	18	21.58	22.08	33.00	-10.92
				75	0	21.42	21.92	33.00	-11.08
	21100	2535	QPSK	1	0	22.17	22.67	33.00	-10.33
				1	74	22.61	23.11	33.00	-9.89
				36	18	21.42	21.92	33.00	-11.08
				75	0	21.17	21.67	33.00	-11.33
	21375	2562.5	QPSK	1	0	22.42	22.92	33.00	-10.08
				1	74	22.48	22.98	33.00	-10.02
				36	18	21.36	21.86	33.00	-11.14
				75	0	21.26	21.76	33.00	-11.24
	20825	2507.5	16QAM	1	0	21.99	22.49	33.00	-10.51
				1	74	22.05	22.55	33.00	-10.45
				36	18	20.59	21.09	33.00	-11.91
				75	0	20.19	20.69	33.00	-12.31
	21100	2535	16QAM	1	0	21.56	22.06	33.00	-10.94
				1	74	21.55	22.05	33.00	-10.95
				36	18	20.42	20.92	33.00	-12.08
				75	0	20.11	20.61	33.00	-12.39
	21375	2562.5	16QAM	1	0	21.50	22.00	33.00	-11
				1	74	21.77	22.27	33.00	-10.73
				36	18	20.34	20.84	33.00	-12.16
				75	0	20.33	20.83	33.00	-12.17
	20825	2507.5	64QAM	1	0	21.45	21.95	33.00	-11.05
				1	74	21.46	21.96	33.00	-11.04
				36	18	20.00	20.50	33.00	-12.5
				75	0	19.68	20.18	33.00	-12.82
	21100	2535	64QAM	1	0	21.10	21.60	33.00	-11.4
				1	74	21.00	21.50	33.00	-11.5
				36	18	19.86	20.36	33.00	-12.64
				75	0	19.53	20.03	33.00	-12.97
21375	2562.5	64QAM	1	0	20.92	21.42	33.00	-11.58	
			1	74	21.25	21.75	33.00	-11.25	
			36	18	19.92	20.42	33.00	-12.58	
			75	0	19.65	20.15	33.00	-12.85	

Unless otherwise stated the results shown in this test report refer only to the sample(s) tested and such sample(s) are retained for 90 days only.

除非另有說明，此報告結果僅對測試之樣品負責，同時此樣品僅保留90天。本報告未經本公司書面許可，不可部份複製。

This document is issued by the Company subject to its General Conditions of Service printed overleaf, available on request or accessible at www.sgs.com/terms_and_conditions.htm and for electronic format documents, subject to Terms and Conditions for Electronic Documents at www.sgs.com/terms_e-document.htm. Attention is drawn to the limitation of liability, indemnification and jurisdiction issues defined therein. Any holder of this document is advised that information contained hereon reflects the Company's findings at the time of its intervention only and within the limits of Client's instructions, if any. The Company's sole responsibility is to its Client and this document does not exonerate parties to a transaction from exercising all their rights and obligations under the transaction documents. This document cannot be reproduced except in full, without prior written approval of the Company. Any unauthorized alteration, forgery or falsification of the content or appearance of this document is unlawful and offenders may be prosecuted to the fullest extent of the law.

Antenna gain (dBi) 0.5

LTE Band 7_Uplink frequency band : 2500 to 2570 MHz

BW (MHz)	UL Channel	Frequency (MHz)	Modulation	RB Size	RB Offset	Conducted Average (dBm)	EIRP Average (dBm)	EIRP Limit (dBm)	Margin (dB)
20	20850	2510	QPSK	1	0	22.45	22.95	33.00	-10.05
				1	99	22.66	23.16	33.00	-9.84
				50	25	21.59	22.09	33.00	-10.91
				100	0	21.44	21.94	33.00	-11.06
	21100	2535	QPSK	1	0	22.28	22.78	33.00	-10.22
				1	99	22.63	23.13	33.00	-9.87
				50	25	21.63	22.13	33.00	-10.87
				100	0	21.35	21.85	33.00	-11.15
	21350	2560	QPSK	1	0	22.54	23.04	33.00	-9.96
				1	99	22.51	23.01	33.00	-9.99
				50	25	21.50	22.00	33.00	-11
				100	0	21.36	21.86	33.00	-11.14
	20850	2510	16QAM	1	0	22.07	22.57	33.00	-10.43
				1	99	22.11	22.61	33.00	-10.39
				50	25	20.62	21.12	33.00	-11.88
				100	0	20.35	20.85	33.00	-12.15
	21100	2535	16QAM	1	0	21.75	22.25	33.00	-10.75
				1	99	21.63	22.13	33.00	-10.87
				50	25	20.55	21.05	33.00	-11.95
				100	0	20.25	20.75	33.00	-12.25
	21350	2560	16QAM	1	0	21.60	22.10	33.00	-10.9
				1	99	21.90	22.40	33.00	-10.6
				50	25	20.49	20.99	33.00	-12.01
				100	0	20.33	20.83	33.00	-12.17
	20850	2510	64QAM	1	0	21.50	22.00	33.00	-11
				1	99	21.49	21.99	33.00	-11.01
				50	25	20.16	20.66	33.00	-12.34
				100	0	19.84	20.34	33.00	-12.66
	21100	2535	64QAM	1	0	21.30	21.80	33.00	-11.2
				1	99	21.06	21.56	33.00	-11.44
				50	25	19.99	20.49	33.00	-12.51
				100	0	19.70	20.20	33.00	-12.8
	21350	2560	64QAM	1	0	21.04	21.54	33.00	-11.46
				1	99	21.34	21.84	33.00	-11.16
				50	25	20.02	20.52	33.00	-12.48
				100	0	19.82	20.32	33.00	-12.68

Unless otherwise stated the results shown in this test report refer only to the sample(s) tested and such sample(s) are retained for 90 days only.

除非另有說明，此報告結果僅對測試之樣品負責，同時此樣品僅保留90天。本報告未經本公司書面許可，不可部份複製。

This document is issued by the Company subject to its General Conditions of Service printed overleaf, available on request or accessible at www.sgs.com/terms_and_conditions.htm and for electronic format documents, subject to Terms and Conditions for Electronic Documents at www.sgs.com/terms_e-document.htm. Attention is drawn to the limitation of liability, indemnification and jurisdiction issues defined therein. Any holder of this document is advised that information contained hereon reflects the Company's findings at the time of its intervention only and within the limits of Client's instructions, if any. The Company's sole responsibility is to its Client and this document does not exonerate parties to a transaction from exercising all their rights and obligations under the transaction documents. This document cannot be reproduced except in full, without prior written approval of the Company. Any unauthorized alteration, forgery or falsification of the content or appearance of this document is unlawful and offenders may be prosecuted to the fullest extent of the law.

Antenna gain (dBi) -7.8

LTE Band 12_Uplink frequency band : 699 to 716 MHz										
BW (MHz)	UL Channel	Frequency (MHz)	Modulation	RB Size	RB Offset	Conducted Average (dBm)	ERP Average (dBm)	EIRP Average (dBm)	EIRP Limit (dBm)	Margin (dB)
1.4	23017	699.7	QPSK	1	0	22.57	12.62	14.77	34.77	-20
				1	5	22.60	12.65	14.80	34.77	-19.97
				3	2	22.59	12.64	14.79	34.77	-19.98
				6	0	21.61	11.66	13.81	34.77	-20.96
	23095	707.5	QPSK	1	0	22.60	12.65	14.80	34.77	-19.97
				1	5	22.57	12.62	14.77	34.77	-20
				3	2	22.61	12.66	14.81	34.77	-19.96
				6	0	21.53	11.58	13.73	34.77	-21.04
	23173	715.5	QPSK	1	0	22.57	12.62	14.77	34.77	-20
				1	5	22.62	12.67	14.82	34.77	-19.95
				3	2	22.52	12.57	14.72	34.77	-20.05
				6	0	21.54	11.59	13.74	34.77	-21.03
	23017	699.7	16QAM	1	0	21.59	11.64	13.79	34.77	-20.98
				1	5	21.54	11.59	13.74	34.77	-21.03
				3	2	21.61	11.66	13.81	34.77	-20.96
				6	0	20.55	10.60	12.75	34.77	-22.02
	23095	707.5	16QAM	1	0	21.59	11.64	13.79	34.77	-20.98
				1	5	21.53	11.58	13.73	34.77	-21.04
				3	2	21.57	11.62	13.77	34.77	-21
				6	0	20.57	10.62	12.77	34.77	-22
	23173	715.5	16QAM	1	0	21.58	11.63	13.78	34.77	-20.99
				1	5	21.52	11.57	13.72	34.77	-21.05
				3	2	21.60	11.65	13.80	34.77	-20.97
				6	0	20.53	10.58	12.73	34.77	-22.04
	23017	699.7	64QAM	1	0	20.95	11.00	13.15	34.77	-21.62
				1	5	20.89	10.94	13.09	34.77	-21.68
				3	2	21.05	11.10	13.25	34.77	-21.52
				6	0	19.95	10.00	12.15	34.77	-22.62
	23095	707.5	64QAM	1	0	21.02	11.07	13.22	34.77	-21.55
				1	5	20.91	10.96	13.11	34.77	-21.66
				3	2	21.01	11.06	13.21	34.77	-21.56
				6	0	19.97	10.02	12.17	34.77	-22.6
	23173	715.5	64QAM	1	0	20.94	10.99	13.14	34.77	-21.63
				1	5	20.95	11.00	13.15	34.77	-21.62
				3	2	21.00	11.05	13.20	34.77	-21.57
				6	0	19.90	9.95	12.10	34.77	-22.67

Unless otherwise stated the results shown in this test report refer only to the sample(s) tested and such sample(s) are retained for 90 days only.

除非另有說明，此報告結果僅對測試之樣品負責，同時此樣品僅保留90天。本報告未經本公司書面許可，不可部份複製。

This document is issued by the Company subject to its General Conditions of Service printed overleaf, available on request or accessible at www.sgs.com/terms_and_conditions.htm and for electronic format documents, subject to Terms and Conditions for Electronic Documents at www.sgs.com/terms_e-document.htm. Attention is drawn to the limitation of liability, indemnification and jurisdiction issues defined therein. Any holder of this document is advised that information contained hereon reflects the Company's findings at the time of its intervention only and within the limits of Client's instructions, if any. The Company's sole responsibility is to its Client and this document does not exonerate parties to a transaction from exercising all their rights and obligations under the transaction documents. This document cannot be reproduced except in full, without prior written approval of the Company. Any unauthorized alteration, forgery or falsification of the content or appearance of this document is unlawful and offenders may be prosecuted to the fullest extent of the law.

Antenna gain (dBi) -7.8

LTE Band 12_Uplink frequency band : 699 to 716 MHz										
BW (MHz)	UL Channel	Frequency (MHz)	Modulation	RB Size	RB Offset	Conducted Average (dBm)	ERP Average (dBm)	EIRP Average (dBm)	EIRP Limit (dBm)	Margin (dB)
3	23025	700.5	QPSK	1	0	22.47	12.52	14.67	34.77	-20.1
				1	14	22.96	13.01	15.16	34.77	-19.61
				8	4	21.75	11.80	13.95	34.77	-20.82
				15	0	21.48	11.53	13.68	34.77	-21.09
	23095	707.5	QPSK	1	0	22.65	12.70	14.85	34.77	-19.92
				1	14	22.73	12.78	14.93	34.77	-19.84
				8	4	21.82	11.87	14.02	34.77	-20.75
				15	0	21.56	11.61	13.76	34.77	-21.01
	23165	714.5	QPSK	1	0	22.61	12.66	14.81	34.77	-19.96
				1	14	22.55	12.60	14.75	34.77	-20.02
				8	4	21.85	11.90	14.05	34.77	-20.72
				15	0	21.37	11.42	13.57	34.77	-21.2
	23025	700.5	16QAM	1	0	22.07	12.12	14.27	34.77	-20.5
				1	14	21.93	11.98	14.13	34.77	-20.64
				8	4	20.71	10.76	12.91	34.77	-21.86
				15	0	20.63	10.68	12.83	34.77	-21.94
	23095	707.5	16QAM	1	0	21.83	11.88	14.03	34.77	-20.74
				1	14	22.28	12.33	14.48	34.77	-20.29
				8	4	20.59	10.64	12.79	34.77	-21.98
				15	0	20.47	10.52	12.67	34.77	-22.1
	23165	714.5	16QAM	1	0	21.41	11.46	13.61	34.77	-21.16
				1	14	21.63	11.68	13.83	34.77	-20.94
				8	4	20.73	10.78	12.93	34.77	-21.84
				15	0	20.65	10.70	12.85	34.77	-21.92
	23025	700.5	64QAM	1	0	21.64	11.69	13.84	34.77	-20.93
				1	14	21.67	11.72	13.87	34.77	-20.9
				8	4	20.29	10.34	12.49	34.77	-22.28
				15	0	20.26	10.31	12.46	34.77	-22.31
	23095	707.5	64QAM	1	0	21.32	11.37	13.52	34.77	-21.25
				1	14	21.84	11.89	14.04	34.77	-20.73
				8	4	20.35	10.40	12.55	34.77	-22.22
				15	0	19.99	10.04	12.19	34.77	-22.58
	23165	714.5	64QAM	1	0	21.14	11.19	13.34	34.77	-21.43
				1	14	21.23	11.28	13.43	34.77	-21.34
				8	4	20.34	10.39	12.54	34.77	-22.23
				15	0	20.17	10.22	12.37	34.77	-22.4

Unless otherwise stated the results shown in this test report refer only to the sample(s) tested and such sample(s) are retained for 90 days only.

除非另有說明，此報告結果僅對測試之樣品負責，同時此樣品僅保留90天。本報告未經本公司書面許可，不可部份複製。

This document is issued by the Company subject to its General Conditions of Service printed overleaf, available on request or accessible at www.sgs.com/terms_and_conditions.htm and for electronic format documents, subject to Terms and Conditions for Electronic Documents at www.sgs.com/terms_e-document.htm. Attention is drawn to the limitation of liability, indemnification and jurisdiction issues defined therein. Any holder of this document is advised that information contained hereon reflects the Company's findings at the time of its intervention only and within the limits of Client's instructions, if any. The Company's sole responsibility is to its Client and this document does not exonerate parties to a transaction from exercising all their rights and obligations under the transaction documents. This document cannot be reproduced except in full, without prior written approval of the Company. Any unauthorized alteration, forgery or falsification of the content or appearance of this document is unlawful and offenders may be prosecuted to the fullest extent of the law.

Antenna gain (dBi) -7.8

LTE Band 12_Uplink frequency band : 699 to 716 MHz										
BW (MHz)	UL Channel	Frequency (MHz)	Modulation	RB Size	RB Offset	Conducted Average (dBm)	ERP Average (dBm)	EIRP Average (dBm)	EIRP Limit (dBm)	Margin (dB)
5	23035	701.5	QPSK	1	0	22.44	12.49	14.64	34.77	-20.13
				1	24	22.95	13.00	15.15	34.77	-19.62
				12	6	21.80	11.85	14.00	34.77	-20.77
				25	0	21.48	11.53	13.68	34.77	-21.09
	23095	707.5	QPSK	1	0	22.59	12.64	14.79	34.77	-19.98
				1	24	22.67	12.72	14.87	34.77	-19.9
				12	6	21.68	11.73	13.88	34.77	-20.89
				25	0	21.53	11.58	13.73	34.77	-21.04
	23155	713.5	QPSK	1	0	22.46	12.51	14.66	34.77	-20.11
				1	24	22.58	12.63	14.78	34.77	-19.99
				12	6	21.82	11.87	14.02	34.77	-20.75
				25	0	21.55	11.60	13.75	34.77	-21.02
	23035	701.5	16QAM	1	0	22.11	12.16	14.31	34.77	-20.46
				1	24	22.00	12.05	14.20	34.77	-20.57
				12	6	20.65	10.70	12.85	34.77	-21.92
				25	0	20.57	10.62	12.77	34.77	-22
	23095	707.5	16QAM	1	0	21.86	11.91	14.06	34.77	-20.71
				1	24	22.37	12.42	14.57	34.77	-20.2
				12	6	20.78	10.83	12.98	34.77	-21.79
				25	0	20.38	10.43	12.58	34.77	-22.19
	23155	713.5	16QAM	1	0	21.57	11.62	13.77	34.77	-21
				1	24	21.78	11.83	13.98	34.77	-20.79
				12	6	20.64	10.69	12.84	34.77	-21.93
				25	0	20.58	10.63	12.78	34.77	-21.99
	23035	701.5	64QAM	1	0	21.61	11.66	13.81	34.77	-20.96
				1	24	21.61	11.66	13.81	34.77	-20.96
				12	6	20.31	10.36	12.51	34.77	-22.26
				25	0	20.20	10.25	12.40	34.77	-22.37
	23095	707.5	64QAM	1	0	21.41	11.46	13.61	34.77	-21.16
				1	24	21.84	11.89	14.04	34.77	-20.73
				12	6	20.19	10.24	12.39	34.77	-22.38
				25	0	19.99	10.04	12.19	34.77	-22.58
	23155	713.5	64QAM	1	0	21.17	11.22	13.37	34.77	-21.4
				1	24	21.30	11.35	13.50	34.77	-21.27
				12	6	20.26	10.31	12.46	34.77	-22.31
				25	0	20.10	10.15	12.30	34.77	-22.47

Unless otherwise stated the results shown in this test report refer only to the sample(s) tested and such sample(s) are retained for 90 days only.

除非另有說明，此報告結果僅對測試之樣品負責，同時此樣品僅保留90天。本報告未經本公司書面許可，不可部份複製。

This document is issued by the Company subject to its General Conditions of Service printed overleaf, available on request or accessible at www.sgs.com/terms_and_conditions.htm and for electronic format documents, subject to Terms and Conditions for Electronic Documents at www.sgs.com/terms_e-document.htm. Attention is drawn to the limitation of liability, indemnification and jurisdiction issues defined therein. Any holder of this document is advised that information contained hereon reflects the Company's findings at the time of its intervention only and within the limits of Client's instructions, if any. The Company's sole responsibility is to its Client and this document does not exonerate parties to a transaction from exercising all their rights and obligations under the transaction documents. This document cannot be reproduced except in full, without prior written approval of the Company. Any unauthorized alteration, forgery or falsification of the content or appearance of this document is unlawful and offenders may be prosecuted to the fullest extent of the law.

Antenna gain (dBi) -7.8

LTE Band 12_Uplink frequency band : 699 to 716 MHz										
BW (MHz)	UL Channel	Frequency (MHz)	Modulation	RB Size	RB Offset	Conducted Average (dBm)	ERP Average (dBm)	EIRP Average (dBm)	EIRP Limit (dBm)	Margin (dB)
10	23060	704	QPSK	1	0	22.57	12.62	14.77	34.77	-20
				1	49	22.98	13.03	15.18	34.77	-19.59
				25	12	21.81	11.86	14.01	34.77	-20.76
				50	0	21.60	11.65	13.80	34.77	-20.97
	23095	707.5	QPSK	1	0	22.72	12.77	14.92	34.77	-19.85
				1	49	22.86	12.91	15.06	34.77	-19.71
				25	12	21.86	11.91	14.06	34.77	-20.71
				50	0	21.58	11.63	13.78	34.77	-20.99
	23130	711	QPSK	1	0	22.62	12.67	14.82	34.77	-19.95
				1	49	22.72	12.77	14.92	34.77	-19.85
				25	12	21.96	12.01	14.16	34.77	-20.61
				50	0	21.56	11.61	13.76	34.77	-21.01
	23060	704	16QAM	1	0	22.12	12.17	14.32	34.77	-20.45
				1	49	22.09	12.14	14.29	34.77	-20.48
				25	12	20.73	10.78	12.93	34.77	-21.84
				50	0	20.66	10.71	12.86	34.77	-21.91
	23095	707.5	16QAM	1	0	22.01	12.06	14.21	34.77	-20.56
				1	49	22.39	12.44	14.59	34.77	-20.18
				25	12	20.78	10.83	12.98	34.77	-21.79
				50	0	20.57	10.62	12.77	34.77	-22
	23130	711	16QAM	1	0	21.61	11.66	13.81	34.77	-20.96
				1	49	21.80	11.85	14.00	34.77	-20.77
				25	12	20.84	10.89	13.04	34.77	-21.73
				50	0	20.67	10.72	12.87	34.77	-21.9
	23060	704	64QAM	1	0	21.69	11.74	13.89	34.77	-20.88
				1	49	21.69	11.74	13.89	34.77	-20.88
				25	12	20.38	10.43	12.58	34.77	-22.19
				50	0	20.27	10.32	12.47	34.77	-22.3
	23095	707.5	64QAM	1	0	21.48	11.53	13.68	34.77	-21.09
				1	49	21.92	11.97	14.12	34.77	-20.65
				25	12	20.38	10.43	12.58	34.77	-22.19
				50	0	20.16	10.21	12.36	34.77	-22.41
	23130	711	64QAM	1	0	21.17	11.22	13.37	34.77	-21.4
				1	49	21.32	11.37	13.52	34.77	-21.25
				25	12	20.41	10.46	12.61	34.77	-22.16
				50	0	20.25	10.30	12.45	34.77	-22.32

Unless otherwise stated the results shown in this test report refer only to the sample(s) tested and such sample(s) are retained for 90 days only.

除非另有說明，此報告結果僅對測試之樣品負責，同時此樣品僅保留90天。本報告未經本公司書面許可，不可部份複製。

This document is issued by the Company subject to its General Conditions of Service printed overleaf, available on request or accessible at www.sgs.com/terms_and_conditions.htm and for electronic format documents, subject to Terms and Conditions for Electronic Documents at www.sgs.com/terms_e-document.htm. Attention is drawn to the limitation of liability, indemnification and jurisdiction issues defined therein. Any holder of this document is advised that information contained hereon reflects the Company's findings at the time of its intervention only and within the limits of Client's instructions, if any. The Company's sole responsibility is to its Client and this document does not exonerate parties to a transaction from exercising all their rights and obligations under the transaction documents. This document cannot be reproduced except in full, without prior written approval of the Company. Any unauthorized alteration, forgery or falsification of the content or appearance of this document is unlawful and offenders may be prosecuted to the fullest extent of the law.

Antenna gain (dBi) -6.6

LTE Band 13_Uplink frequency band : 777 to 787 MHz										
BW (MHz)	UL Channel	Frequency (MHz)	Modulation	RB Size	RB Offset	Conducted Average (dBm)	ERP Average (dBm)	EIRP Average (dBm)	EIRP Limit (dBm)	Margin (dB)
5	23205	779.5	QPSK	1	0	22.48	13.73	15.88	34.77	-18.89
				1	24	22.54	13.79	15.94	34.77	-18.83
				12	6	21.66	12.91	15.06	34.77	-19.71
				25	0	21.62	12.87	15.02	34.77	-19.75
	23230	782	QPSK	1	0	22.38	13.63	15.78	34.77	-18.99
				1	24	22.58	13.83	15.98	34.77	-18.79
				12	6	21.59	12.84	14.99	34.77	-19.78
				25	0	21.50	12.75	14.90	34.77	-19.87
	23255	784.5	QPSK	1	0	22.51	13.76	15.91	34.77	-18.86
				1	24	22.55	13.80	15.95	34.77	-18.82
				12	6	21.74	12.99	15.14	34.77	-19.63
				25	0	21.52	12.77	14.92	34.77	-19.85
	23205	779.5	16QAM	1	0	21.88	13.13	15.28	34.77	-19.49
				1	24	21.55	12.80	14.95	34.77	-19.82
				12	6	20.63	11.88	14.03	34.77	-20.74
				25	0	20.65	11.90	14.05	34.77	-20.72
	23230	782	16QAM	1	0	21.86	13.11	15.26	34.77	-19.51
				1	24	21.72	12.97	15.12	34.77	-19.65
				12	6	20.66	11.91	14.06	34.77	-20.71
				25	0	20.65	11.90	14.05	34.77	-20.72
	23255	784.5	16QAM	1	0	21.67	12.92	15.07	34.77	-19.7
				1	24	21.89	13.14	15.29	34.77	-19.48
				12	6	20.63	11.88	14.03	34.77	-20.74
				25	0	20.55	11.80	13.95	34.77	-20.82
	23205	779.5	64QAM	1	0	21.35	12.60	14.75	34.77	-20.02
				1	24	21.07	12.32	14.47	34.77	-20.3
				12	6	19.91	11.16	13.31	34.77	-21.46
				25	0	19.79	11.04	13.19	34.77	-21.58
	23230	782	64QAM	1	0	21.33	12.58	14.73	34.77	-20.04
				1	24	21.21	12.46	14.61	34.77	-20.16
				12	6	19.93	11.18	13.33	34.77	-21.44
				25	0	19.92	11.17	13.32	34.77	-21.45
	23255	784.5	64QAM	1	0	21.14	12.39	14.54	34.77	-20.23
				1	24	21.38	12.63	14.78	34.77	-19.99
				12	6	19.99	11.24	13.39	34.77	-21.38
				25	0	19.89	11.14	13.29	34.77	-21.48

Unless otherwise stated the results shown in this test report refer only to the sample(s) tested and such sample(s) are retained for 90 days only.

除非另有說明，此報告結果僅對測試之樣品負責，同時此樣品僅保留90天。本報告未經本公司書面許可，不可部份複製。

This document is issued by the Company subject to its General Conditions of Service printed overleaf, available on request or accessible at www.sgs.com/terms_and_conditions.htm and for electronic format documents, subject to Terms and Conditions for Electronic Documents at www.sgs.com/terms_e-document.htm. Attention is drawn to the limitation of liability, indemnification and jurisdiction issues defined therein. Any holder of this document is advised that information contained hereon reflects the Company's findings at the time of its intervention only and within the limits of Client's instructions, if any. The Company's sole responsibility is to its Client and this document does not exonerate parties to a transaction from exercising all their rights and obligations under the transaction documents. This document cannot be reproduced except in full, without prior written approval of the Company. Any unauthorized alteration, forgery or falsification of the content or appearance of this document is unlawful and offenders may be prosecuted to the fullest extent of the law.

Antenna gain (dBi) -6.6

LTE Band 13_Uplink frequency band : 777 to 787 MHz										
BW (MHz)	UL Channel	Frequency (MHz)	Modulation	RB Size	RB Offset	Conducted Average (dBm)	ERP Average (dBm)	EIRP Average (dBm)	EIRP Limit (dBm)	Margin (dB)
10	23230	782	QPSK	1	0	22.49	13.74	15.89	34.77	-18.88
				1	49	22.38	13.63	15.78	34.77	-18.99
				25	12	21.54	12.79	14.94	34.77	-19.83
				50	0	21.31	12.56	14.71	34.77	-20.06
	23230	782	16QAM	1	0	21.51	12.76	14.91	34.77	-19.86
				1	49	21.52	12.77	14.92	34.77	-19.85
				25	12	20.56	11.81	13.96	34.77	-20.81
				50	0	20.30	11.55	13.70	34.77	-21.07
	23230	782	64QAM	1	0	20.93	12.18	14.33	34.77	-20.44
				1	49	20.98	12.23	14.38	34.77	-20.39
				25	12	19.98	11.23	13.38	34.77	-21.39
				50	0	19.77	11.02	13.17	34.77	-21.6

Unless otherwise stated the results shown in this test report refer only to the sample(s) tested and such sample(s) are retained for 90 days only.

除非另有說明，此報告結果僅對測試之樣品負責，同時此樣品僅保留90天。本報告未經本公司書面許可，不可部份複製。

This document is issued by the Company subject to its General Conditions of Service printed overleaf, available on request or accessible at www.sgs.com/terms_and_conditions.htm and for electronic format documents, subject to Terms and Conditions for Electronic Documents at www.sgs.com/terms_e-document.htm. Attention is drawn to the limitation of liability, indemnification and jurisdiction issues defined therein. Any holder of this document is advised that information contained hereon reflects the Company's findings at the time of its intervention only and within the limits of Client's instructions, if any. The Company's sole responsibility is to its Client and this document does not exonerate parties to a transaction from exercising all their rights and obligations under the transaction documents. This document cannot be reproduced except in full, without prior written approval of the Company. Any unauthorized alteration, forgery or falsification of the content or appearance of this document is unlawful and offenders may be prosecuted to the fullest extent of the law.

Antenna gain (dBi) -7.8

LTE Band 17_Uplink frequency band : 704 to 716 MHz										
BW (MHz)	UL Channel	Frequency (MHz)	Modulation	RB Size	RB Offset	Conducted Average (dBm)	ERP Average (dBm)	EIRP Average (dBm)	EIRP Limit (dBm)	Margin (dB)
5	23755	706.5	QPSK	1	0	22.42	12.47	14.62	34.77	-20.15
				1	24	22.54	12.59	14.74	34.77	-20.03
				12	6	21.85	11.90	14.05	34.77	-20.72
				25	0	21.68	11.73	13.88	34.77	-20.89
	23790	710	QPSK	1	0	22.36	12.41	14.56	34.77	-20.21
				1	24	22.58	12.63	14.78	34.77	-19.99
				12	6	21.82	11.87	14.02	34.77	-20.75
				25	0	21.79	11.84	13.99	34.77	-20.78
	23825	713.5	QPSK	1	0	22.28	12.33	14.48	34.77	-20.29
				1	24	22.58	12.63	14.78	34.77	-19.99
				12	6	21.94	11.99	14.14	34.77	-20.63
				25	0	21.71	11.76	13.91	34.77	-20.86
	23755	706.5	16QAM	1	0	21.46	11.51	13.66	34.77	-21.11
				1	24	21.94	11.99	14.14	34.77	-20.63
				12	6	20.86	10.91	13.06	34.77	-21.71
				25	0	20.72	10.77	12.92	34.77	-21.85
	23790	710	16QAM	1	0	21.40	11.45	13.60	34.77	-21.17
				1	24	22.17	12.22	14.37	34.77	-20.4
				12	6	20.93	10.98	13.13	34.77	-21.64
				25	0	20.88	10.93	13.08	34.77	-21.69
	23825	713.5	16QAM	1	0	21.57	11.62	13.77	34.77	-21
				1	24	21.77	11.82	13.97	34.77	-20.8
				12	6	20.83	10.88	13.03	34.77	-21.74
				25	0	20.74	10.79	12.94	34.77	-21.83
	23755	706.5	64QAM	1	0	20.65	10.70	12.85	34.77	-21.92
				1	24	21.00	11.05	13.20	34.77	-21.57
				12	6	19.98	10.03	12.18	34.77	-22.59
				25	0	19.89	9.94	12.09	34.77	-22.68
	23790	710	64QAM	1	0	20.48	10.53	12.68	34.77	-22.09
				1	24	21.36	11.41	13.56	34.77	-21.21
				12	6	20.09	10.14	12.29	34.77	-22.48
				25	0	19.99	10.04	12.19	34.77	-22.58
	23825	713.5	64QAM	1	0	20.68	10.73	12.88	34.77	-21.89
				1	24	20.84	10.89	13.04	34.77	-21.73
				12	6	19.96	10.01	12.16	34.77	-22.61
				25	0	19.78	9.83	11.98	34.77	-22.79

Unless otherwise stated the results shown in this test report refer only to the sample(s) tested and such sample(s) are retained for 90 days only.

除非另有說明，此報告結果僅對測試之樣品負責，同時此樣品僅保留90天。本報告未經本公司書面許可，不可部份複製。

This document is issued by the Company subject to its General Conditions of Service printed overleaf, available on request or accessible at www.sgs.com/terms_and_conditions.htm and for electronic format documents, subject to Terms and Conditions for Electronic Documents at www.sgs.com/terms_e-document.htm. Attention is drawn to the limitation of liability, indemnification and jurisdiction issues defined therein. Any holder of this document is advised that information contained hereon reflects the Company's findings at the time of its intervention only and within the limits of Client's instructions, if any. The Company's sole responsibility is to its Client and this document does not exonerate parties to a transaction from exercising all their rights and obligations under the transaction documents. This document cannot be reproduced except in full, without prior written approval of the Company. Any unauthorized alteration, forgery or falsification of the content or appearance of this document is unlawful and offenders may be prosecuted to the fullest extent of the law.

Antenna gain (dBi) -7.8

LTE Band 17_Uplink frequency band : 704 to 716 MHz										
BW (MHz)	UL Channel	Frequency (MHz)	Modulation	RB Size	RB Offset	Conducted Average (dBm)	ERP Average (dBm)	EIRP Average (dBm)	EIRP Limit (dBm)	Margin (dB)
10	23780	709	QPSK	1	0	22.40	12.45	14.60	34.77	-20.17
				1	49	22.61	12.66	14.81	34.77	-19.96
				25	12	21.74	11.79	13.94	34.77	-20.83
				50	0	21.60	11.65	13.80	34.77	-20.97
	23790	710	QPSK	1	0	22.74	12.79	14.94	34.77	-19.83
				1	49	22.78	12.83	14.98	34.77	-19.79
				25	12	21.86	11.91	14.06	34.77	-20.71
				50	0	21.63	11.68	13.83	34.77	-20.94
	23800	711	QPSK	1	0	22.66	12.71	14.86	34.77	-19.91
				1	49	22.79	12.84	14.99	34.77	-19.78
				25	12	21.80	11.85	14.00	34.77	-20.77
				50	0	21.56	11.61	13.76	34.77	-21.01
	23780	709	16QAM	1	0	21.86	11.91	14.06	34.77	-20.71
				1	49	21.86	11.91	14.06	34.77	-20.71
				25	12	20.78	10.83	12.98	34.77	-21.79
				50	0	20.55	10.60	12.75	34.77	-22.02
	23790	710	16QAM	1	0	21.87	11.92	14.07	34.77	-20.7
				1	49	21.89	11.94	14.09	34.77	-20.68
				25	12	20.78	10.83	12.98	34.77	-21.79
				50	0	20.63	10.68	12.83	34.77	-21.94
	23800	711	16QAM	1	0	21.88	11.93	14.08	34.77	-20.69
				1	49	22.04	12.09	14.24	34.77	-20.53
				25	12	20.82	10.87	13.02	34.77	-21.75
				50	0	20.53	10.58	12.73	34.77	-22.04
	23780	709	64QAM	1	0	21.24	11.29	13.44	34.77	-21.33
				1	49	21.27	11.32	13.47	34.77	-21.3
				25	12	20.11	10.16	12.31	34.77	-22.46
				50	0	19.94	9.99	12.14	34.77	-22.63
	23790	710	64QAM	1	0	21.22	11.27	13.42	34.77	-21.35
				1	49	21.24	11.29	13.44	34.77	-21.33
				25	12	20.15	10.20	12.35	34.77	-22.42
				50	0	19.98	10.03	12.18	34.77	-22.59
	23800	711	64QAM	1	0	21.23	11.28	13.43	34.77	-21.34
				1	49	21.47	11.52	13.67	34.77	-21.1
				25	12	20.14	10.19	12.34	34.77	-22.43
				50	0	19.82	9.87	12.02	34.77	-22.75

Unless otherwise stated the results shown in this test report refer only to the sample(s) tested and such sample(s) are retained for 90 days only.

除非另有說明，此報告結果僅對測試之樣品負責，同時此樣品僅保留90天。本報告未經本公司書面許可，不可部份複製。

This document is issued by the Company subject to its General Conditions of Service printed overleaf, available on request or accessible at www.sgs.com/terms_and_conditions.htm and for electronic format documents, subject to Terms and Conditions for Electronic Documents at www.sgs.com/terms_e-document.htm. Attention is drawn to the limitation of liability, indemnification and jurisdiction issues defined therein. Any holder of this document is advised that information contained hereon reflects the Company's findings at the time of its intervention only and within the limits of Client's instructions, if any. The Company's sole responsibility is to its Client and this document does not exonerate parties to a transaction from exercising all their rights and obligations under the transaction documents. This document cannot be reproduced except in full, without prior written approval of the Company. Any unauthorized alteration, forgery or falsification of the content or appearance of this document is unlawful and offenders may be prosecuted to the fullest extent of the law.

Antenna gain (dBi) 0.5

LTE Band 38_Uplink frequency band : 2570 to 2620 MHz									
BW (MHz)	UL Channel	Frequency (MHz)	Modulation	RB Size	RB Offset	Conducted Average (dBm)	EIRP Average (dBm)	EIRP Limit (dBm)	Margin (dB)
5	37775	2572.5	QPSK	1	0	22.37	22.87	33	-10.13
				1	24	22.36	22.86	33	-10.14
				12	6	21.56	22.06	33	-10.94
				25	0	21.40	21.90	33	-11.1
	38000	2595	QPSK	1	0	22.27	22.77	33	-10.23
				1	24	22.51	23.01	33	-9.99
				12	6	21.64	22.14	33	-10.86
				25	0	21.29	21.79	33	-11.21
	38225	2617.5	QPSK	1	0	22.51	23.01	33	-9.99
				1	24	22.38	22.88	33	-10.12
				12	6	21.61	22.11	33	-10.89
				25	0	21.31	21.81	33	-11.19
	37775	2572.5	16QAM	1	0	21.44	21.94	33	-11.06
				1	24	21.64	22.14	33	-10.86
				12	6	20.52	21.02	33	-11.98
				25	0	20.29	20.79	33	-12.21
	38000	2595	16QAM	1	0	21.50	22.00	33	-11
				1	24	21.69	22.19	33	-10.81
				12	6	20.45	20.95	33	-12.05
				25	0	20.38	20.88	33	-12.12
	38225	2617.5	16QAM	1	0	21.61	22.11	33	-10.89
				1	24	21.50	22.00	33	-11
				12	6	20.51	21.01	33	-11.99
				25	0	20.42	20.92	33	-12.08
	37775	2572.5	64QAM	1	0	21.27	21.77	33	-11.23
				1	24	21.65	22.15	33	-10.85
				12	6	20.46	20.96	33	-12.04
				25	0	20.44	20.94	33	-12.06
	38000	2595	64QAM	1	0	21.48	21.98	33	-11.02
				1	24	21.48	21.98	33	-11.02
				12	6	20.48	20.98	33	-12.02
				25	0	20.36	20.86	33	-12.14
	38225	2617.5	64QAM	1	0	21.54	22.04	33	-10.96
				1	24	21.47	21.97	33	-11.03
				12	6	20.48	20.98	33	-12.02
				25	0	20.28	20.78	33	-12.22

Unless otherwise stated the results shown in this test report refer only to the sample(s) tested and such sample(s) are retained for 90 days only.

除非另有說明，此報告結果僅對測試之樣品負責，同時此樣品僅保留90天。本報告未經本公司書面許可，不可部份複製。

This document is issued by the Company subject to its General Conditions of Service printed overleaf, available on request or accessible at www.sgs.com/terms_and_conditions.htm and for electronic format documents, subject to Terms and Conditions for Electronic Documents at www.sgs.com/terms_e-document.htm. Attention is drawn to the limitation of liability, indemnification and jurisdiction issues defined therein. Any holder of this document is advised that information contained hereon reflects the Company's findings at the time of its intervention only and within the limits of Client's instructions, if any. The Company's sole responsibility is to its Client and this document does not exonerate parties to a transaction from exercising all their rights and obligations under the transaction documents. This document cannot be reproduced except in full, without prior written approval of the Company. Any unauthorized alteration, forgery or falsification of the content or appearance of this document is unlawful and offenders may be prosecuted to the fullest extent of the law.

Antenna gain (dBi) 0.5

LTE Band 38_Uplink frequency band : 2570 to 2620 MHz									
BW (MHz)	UL Channel	Frequency (MHz)	Modulation	RB Size	RB Offset	Conducted Average (dBm)	EIRP Average (dBm)	EIRP Limit (dBm)	Margin (dB)
10	37800	2575	QPSK	1	0	22.40	22.90	33	-10.1
				1	49	22.45	22.95	33	-10.05
				25	12	21.61	22.11	33	-10.89
				50	0	21.33	21.83	33	-11.17
	38000	2595	QPSK	1	0	22.31	22.81	33	-10.19
				1	49	22.52	23.02	33	-9.98
				25	12	21.48	21.98	33	-11.02
				50	0	21.33	21.83	33	-11.17
	38200	2615	QPSK	1	0	22.41	22.91	33	-10.09
				1	49	22.32	22.82	33	-10.18
				25	12	21.73	22.23	33	-10.77
				50	0	21.28	21.78	33	-11.22
	37800	2575	16QAM	1	0	21.47	21.97	33	-11.03
				1	49	21.48	21.98	33	-11.02
				25	12	20.56	21.06	33	-11.94
				50	0	20.30	20.80	33	-12.2
	38000	2595	16QAM	1	0	21.40	21.90	33	-11.1
				1	49	21.60	22.10	33	-10.9
				25	12	20.61	21.11	33	-11.89
				50	0	20.33	20.83	33	-12.17
	38200	2615	16QAM	1	0	21.60	22.10	33	-10.9
				1	49	21.56	22.06	33	-10.94
				25	12	20.56	21.06	33	-11.94
				50	0	20.44	20.94	33	-12.06
	37800	2575	64QAM	1	0	21.36	21.86	33	-11.14
				1	49	21.58	22.08	33	-10.92
				25	12	20.37	20.87	33	-12.13
				50	0	20.41	20.91	33	-12.09
	38000	2595	64QAM	1	0	21.41	21.91	33	-11.09
				1	49	21.53	22.03	33	-10.97
				25	12	20.52	21.02	33	-11.98
				50	0	20.33	20.83	33	-12.17
	38200	2615	64QAM	1	0	21.49	21.99	33	-11.01
				1	49	21.45	21.95	33	-11.05
				25	12	20.41	20.91	33	-12.09
				50	0	20.38	20.88	33	-12.12

Unless otherwise stated the results shown in this test report refer only to the sample(s) tested and such sample(s) are retained for 90 days only.

除非另有說明，此報告結果僅對測試之樣品負責，同時此樣品僅保留90天。本報告未經本公司書面許可，不可部份複製。

This document is issued by the Company subject to its General Conditions of Service printed overleaf, available on request or accessible at www.sgs.com/terms_and_conditions.htm and for electronic format documents, subject to Terms and Conditions for Electronic Documents at www.sgs.com/terms_e-document.htm. Attention is drawn to the limitation of liability, indemnification and jurisdiction issues defined therein. Any holder of this document is advised that information contained hereon reflects the Company's findings at the time of its intervention only and within the limits of Client's instructions, if any. The Company's sole responsibility is to its Client and this document does not exonerate parties to a transaction from exercising all their rights and obligations under the transaction documents. This document cannot be reproduced except in full, without prior written approval of the Company. Any unauthorized alteration, forgery or falsification of the content or appearance of this document is unlawful and offenders may be prosecuted to the fullest extent of the law.

Antenna gain (dBi) 0.5

LTE Band 38_Uplink frequency band : 2570 to 2620 MHz									
BW (MHz)	UL Channel	Frequency (MHz)	Modulation	RB Size	RB Offset	Conducted Average (dBm)	EIRP Average (dBm)	EIRP Limit (dBm)	Margin (dB)
15	37825	2577.5	QPSK	1	0	22.25	22.75	33	-10.25
				1	74	22.48	22.98	33	-10.02
				36	19	21.65	22.15	33	-10.85
				75	0	21.28	21.78	33	-11.22
	38000	2595	QPSK	1	0	22.36	22.86	33	-10.14
				1	74	22.49	22.99	33	-10.01
				36	19	21.58	22.08	33	-10.92
				75	0	21.43	21.93	33	-11.07
	38175	2612.5	QPSK	1	0	22.53	23.03	33	-9.97
				1	74	22.41	22.91	33	-10.09
				36	19	21.70	22.20	33	-10.8
				75	0	21.34	21.84	33	-11.16
	37825	2577.5	16QAM	1	0	21.56	22.06	33	-10.94
				1	74	21.55	22.05	33	-10.95
				36	19	20.53	21.03	33	-11.97
				75	0	20.28	20.78	33	-12.22
	38000	2595	16QAM	1	0	21.48	21.98	33	-11.02
				1	74	21.67	22.17	33	-10.83
				36	19	20.44	20.94	33	-12.06
				75	0	20.25	20.75	33	-12.25
	38175	2612.5	16QAM	1	0	21.51	22.01	33	-10.99
				1	74	21.48	21.98	33	-11.02
				36	19	20.57	21.07	33	-11.93
				75	0	20.41	20.91	33	-12.09
	37825	2577.5	64QAM	1	0	21.25	21.75	33	-11.25
				1	74	21.50	22.00	33	-11
				36	19	20.45	20.95	33	-12.05
				75	0	20.47	20.97	33	-12.03
	38000	2595	64QAM	1	0	21.52	22.02	33	-10.98
				1	74	21.55	22.05	33	-10.95
				36	19	20.54	21.04	33	-11.96
				75	0	20.29	20.79	33	-12.21
	38175	2612.5	64QAM	1	0	21.43	21.93	33	-11.07
				1	74	21.48	21.98	33	-11.02
				36	19	20.44	20.94	33	-12.06
				75	0	20.38	20.88	33	-12.12

Unless otherwise stated the results shown in this test report refer only to the sample(s) tested and such sample(s) are retained for 90 days only.

除非另有說明，此報告結果僅對測試之樣品負責，同時此樣品僅保留90天。本報告未經本公司書面許可，不可部份複製。

This document is issued by the Company subject to its General Conditions of Service printed overleaf, available on request or accessible at www.sgs.com/terms_and_conditions.htm and for electronic format documents, subject to Terms and Conditions for Electronic Documents at www.sgs.com/terms_e-document.htm. Attention is drawn to the limitation of liability, indemnification and jurisdiction issues defined therein. Any holder of this document is advised that information contained hereon reflects the Company's findings at the time of its intervention only and within the limits of Client's instructions, if any. The Company's sole responsibility is to its Client and this document does not exonerate parties to a transaction from exercising all their rights and obligations under the transaction documents. This document cannot be reproduced except in full, without prior written approval of the Company. Any unauthorized alteration, forgery or falsification of the content or appearance of this document is unlawful and offenders may be prosecuted to the fullest extent of the law.

Antenna gain (dBi) 0.5

LTE Band 38_Uplink frequency band : 2570 to 2620 MHz									
BW (MHz)	UL Channel	Frequency (MHz)	Modulation	RB Size	RB Offset	Conducted Average (dBm)	EIRP Average (dBm)	EIRP Limit (dBm)	Margin (dB)
20	37850	2580	QPSK	1	0	22.44	22.94	33	-10.06
				1	99	22.52	23.02	33	-9.98
				50	25	21.67	22.17	33	-10.83
				100	0	21.43	21.93	33	-11.07
	38000	2595	QPSK	1	0	22.42	22.92	33	-10.08
				1	99	22.56	23.06	33	-9.94
				50	25	21.65	22.15	33	-10.85
				100	0	21.46	21.96	33	-11.04
	38150	2610	QPSK	1	0	22.53	23.03	33	-9.97
				1	99	22.42	22.92	33	-10.08
				50	25	21.79	22.29	33	-10.71
				100	0	21.46	21.96	33	-11.04
	37850	2580	16QAM	1	0	21.58	22.08	33	-10.92
				1	99	21.66	22.16	33	-10.84
				50	25	20.67	21.17	33	-11.83
				100	0	20.41	20.91	33	-12.09
	38000	2595	16QAM	1	0	21.59	22.09	33	-10.91
				1	99	21.72	22.22	33	-10.78
				50	25	20.63	21.13	33	-11.87
				100	0	20.44	20.94	33	-12.06
	38150	2610	16QAM	1	0	21.68	22.18	33	-10.82
				1	99	21.67	22.17	33	-10.83
				50	25	20.70	21.20	33	-11.8
				100	0	20.45	20.95	33	-12.05
	37850	2580	64QAM	1	0	21.42	21.92	33	-11.08
				1	99	21.67	22.17	33	-10.83
				50	25	20.53	21.03	33	-11.97
				100	0	20.48	20.98	33	-12.02
	38000	2595	64QAM	1	0	21.57	22.07	33	-10.93
				1	99	21.60	22.10	33	-10.9
				50	25	20.63	21.13	33	-11.87
				100	0	20.48	20.98	33	-12.02
	38150	2610	64QAM	1	0	21.62	22.12	33	-10.88
				1	99	21.61	22.11	33	-10.89
				50	25	20.50	21.00	33	-12
				100	0	20.47	20.97	33	-12.03

Unless otherwise stated the results shown in this test report refer only to the sample(s) tested and such sample(s) are retained for 90 days only.

除非另有說明，此報告結果僅對測試之樣品負責，同時此樣品僅保留90天。本報告未經本公司書面許可，不可部份複製。

This document is issued by the Company subject to its General Conditions of Service printed overleaf, available on request or accessible at www.sgs.com/terms_and_conditions.htm and for electronic format documents, subject to Terms and Conditions for Electronic Documents at www.sgs.com/terms_e-document.htm. Attention is drawn to the limitation of liability, indemnification and jurisdiction issues defined therein. Any holder of this document is advised that information contained hereon reflects the Company's findings at the time of its intervention only and within the limits of Client's instructions, if any. The Company's sole responsibility is to its Client and this document does not exonerate parties to a transaction from exercising all their rights and obligations under the transaction documents. This document cannot be reproduced except in full, without prior written approval of the Company. Any unauthorized alteration, forgery or falsification of the content or appearance of this document is unlawful and offenders may be prosecuted to the fullest extent of the law.

7. OCCUPIED BANDWIDTH MEASUREMENT

7.1. Standard Applicable

The occupied bandwidth is the frequency bandwidth such that, below its lower and above its upper frequency limits, the mean powers radiated are each equal to 0.5 percent of the total mean power.

7.2. Test Set-up

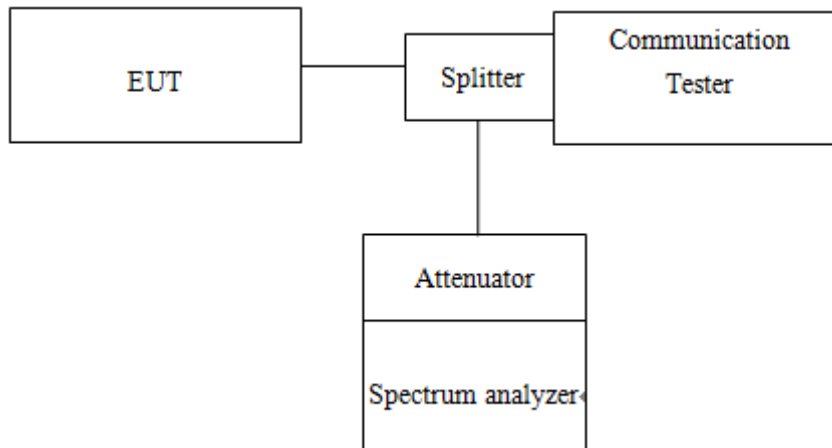

7.3. Measurement Procedure

99% &26dB Bandwidth with detector peak

The EUT's output RF connector was connected with a short cable to the spectrum analyzer, RBW was set to about 1% of emission BW, VBW= 3 times RBW, -26dBc display line was placed on the screen (or 26dB bandwidth), the occupied bandwidth is the delta frequency between the two points where the display line intersects the signal trace. Then set RBW to 99% bandwidth, RBW= 1%, VBW= 3 RBW, with span > 2 * Signal BW, set % Power = 99%.

99% Bandwidth with detector sample

The EUT's output RF connector was connected with a short cable to the spectrum analyzer, RBW was set to about 1% ~ 5% of emission BW, VBW= 3 times RBW, -20dBc display line was placed on the screen (or 20dB bandwidth). Set RBW to 99% bandwidth, RBW= 1% ~ 5%, VBW= 3 RBW, with span > 2 * Signal BW, set % Power = 99%.

Unless otherwise stated the results shown in this test report refer only to the sample(s) tested and such sample(s) are retained for 90 days only.

除非另有說明，此報告結果僅對測試之樣品負責，同時此樣品僅保留90天。本報告未經本公司書面許可，不可部份複製。

This document is issued by the Company subject to its General Conditions of Service printed overleaf, available on request or accessible at www.sgs.com/terms_and_conditions.htm and for electronic format documents, subject to Terms and Conditions for Electronic Documents at www.sgs.com/terms_e-document.htm. Attention is drawn to the limitation of liability, indemnification and jurisdiction issues defined therein. Any holder of this document is advised that information contained hereon reflects the Company's findings at the time of its intervention only and within the limits of Client's instructions, if any. The Company's sole responsibility is to its Client and this document does not exonerate parties to a transaction from exercising all their rights and obligations under the transaction documents. This document cannot be reproduced except in full, without prior written approval of the Company. Any unauthorized alteration, forgery or falsification of the content or appearance of this document is unlawful and offenders may be prosecuted to the fullest extent of the law.

7.4. Measurement Equipment Used

EQUIPMENT TYPE	MFR	MODEL NUMBER	SERIAL NUMBER	LAST CAL.	CAL DUE.
EXA Spectrum Analyzer	Agilent	N9010A	MY53400256	11/21/2018	11/20/2019
Digital Radio Communication Tester	R&S	CMU200	100535	09/17/2018	09/16/2019
DC Power Supply	Agilent	E3640A	KR93300208	08/15/2018	08/14/2019
Attenuator	Mini-Circuit	BW-S10W2+	1	02/26/2019	02/25/2020
DC Block	Mini-Circuits	BLK-18-S+	31129(1)	02/26/2019	02/25/2020
Splitter	RF-LAMBAD	RFLT2W1G18G	11-JSPD022-013	02/26/2019	02/25/2020
Coaxial Cables	Woken	00100A1F1A185C	RF12	02/26/2019	02/25/2020
Wideband Radio Communication Tester	R&S	CMW 500	116875	04/20/2018	04/19/2019

Unless otherwise stated the results shown in this test report refer only to the sample(s) tested and such sample(s) are retained for 90 days only.

除非另有說明，此報告結果僅對測試之樣品負責，同時此樣品僅保留90天。本報告未經本公司書面許可，不可部份複製。

This document is issued by the Company subject to its General Conditions of Service printed overleaf, available on request or accessible at www.sgs.com/terms_and_conditions.htm and for electronic format documents, subject to Terms and Conditions for Electronic Documents at www.sgs.com/terms_e-document.htm. Attention is drawn to the limitation of liability, indemnification and jurisdiction issues defined therein. Any holder of this document is advised that information contained hereon reflects the Company's findings at the time of its intervention only and within the limits of Client's instructions, if any. The Company's sole responsibility is to its Client and this document does not exonerate parties to a transaction from exercising all their rights and obligations under the transaction documents. This document cannot be reproduced except in full, without prior written approval of the Company. Any unauthorized alteration, forgery or falsification of the content or appearance of this document is unlawful and offenders may be prosecuted to the fullest extent of the law.

7.5. Measurement Result

Freq. (MHz)	CH	99% BW (MHz)		26 dB BW (MHz)	
		GSM 850	GPRS 850	GPRS 850	GPRS 850
824.2	128	0.24070	0.24450	0.302	0.310
836.6	190	0.24930	0.24804	0.312	0.317
848.8	251	0.24480	0.24299	0.317	0.317

Freq. (MHz)	CH	99% BW (MHz)		26 dB BW (MHz)	
		GSM 1900	GPRS 1900	GSM 1900	GPRS 1900
1850.2	512	0.24428	0.24566	0.312	0.312
1880.0	661	0.24437	0.24480	0.319	0.314
1909.8	810	0.25077	0.23912	0.306	0.301

Freq. (MHz)	CH	99% BW (MHz)			26 dB BW (MHz)		
		WCDMA II	HSDPA II	HSUPA II	WCDMA II	HSDPA II	HSUPA II
1852.40	9262	4.12660	4.14980	4.14440	4.670	4.705	4.658
1880.00	9400	4.15150	4.14300	4.15660	4.691	4.717	4.725
1907.60	9538	4.16240	4.15050	4.14830	4.691	4.703	4.708

Freq. (MHz)	CH	99% BW (MHz)			26 dB BW (MHz)		
		WCDMA IV	HSDPA IV	HSUPA IV	WCDMA IV	HSDPA IV	HSUPA IV
1712.40	1312	4.71500	4.68600	4.66800	4.143	4.150	4.136
1732.60	1413	4.70100	4.70000	4.68800	4.143	4.138	4.135
1752.60	1513	4.68400	4.70700	4.70500	4.150	4.133	4.146

Freq. (MHz)	CH	99% BW (MHz)			26 dB BW (MHz)		
		WCDMA V	HSDPA V	HSUPA V	WCDMA V	HSDPA V	HSUPA V
826.40	4132	4.14270	4.12560	4.13330	4.669	4.674	4.652
836.60	4183	4.12650	4.13790	4.13080	4.675	4.681	4.676
846.60	4233	4.14550	4.11420	4.13290	4.646	4.665	4.697

Unless otherwise stated the results shown in this test report refer only to the sample(s) tested and such sample(s) are retained for 90 days only.

除非另有說明，此報告結果僅對測試之樣品負責，同時此樣品僅保留90天。本報告未經本公司書面許可，不可部份複製。

This document is issued by the Company subject to its General Conditions of Service printed overleaf, available on request or accessible at www.sgs.com/terms_and_conditions.htm and for electronic format documents, subject to Terms and Conditions for Electronic Documents at www.sgs.com/terms_e-document.htm. Attention is drawn to the limitation of liability, indemnification and jurisdiction issues defined therein. Any holder of this document is advised that information contained hereon reflects the Company's findings at the time of its intervention only and within the limits of Client's instructions, if any. The Company's sole responsibility is to its Client and this document does not exonerate parties to a transaction from exercising all their rights and obligations under the transaction documents. This document cannot be reproduced except in full, without prior written approval of the Company. Any unauthorized alteration, forgery or falsification of the content or appearance of this document is unlawful and offenders may be prosecuted to the fullest extent of the law.

LTE BAND 2 Channel bandwidth: 1.4MHz							
Freq. (MHz)	CH	99% BW (MHz)			26 dB BW (MHz)		
		QPSK	16QAM	64QAM	QPSK	16QAM	64QAM
1850.7	18607	1.0898	1.0929	1.0949	1.235	1.233	1.235
1880.0	18900	1.0954	1.0962	1.0970	1.236	1.234	1.230
1909.3	19193	1.0930	1.0968	1.0967	1.234	1.231	1.227

LTE BAND 2 Channel bandwidth: 3MHz							
Freq. (MHz)	CH	99% BW (MHz)			26 dB BW (MHz)		
		QPSK	16QAM	64QAM	QPSK	16QAM	64QAM
1851.5	18615	2.7001	2.7048	2.6960	2.995	3.009	3.009
1880.0	18900	2.7013	2.7007	2.7016	3.004	3.014	3.011
1908.5	19185	2.7016	2.6998	2.7043	3.001	3.021	3.005

LTE BAND 2 Channel bandwidth: 5MHz							
Freq. (MHz)	CH	99% BW (MHz)			26 dB BW (MHz)		
		QPSK	16QAM	64QAM	QPSK	16QAM	64QAM
1852.5	18625	4.4985	4.5040	4.5028	4.982	4.965	4.970
1880.0	18900	4.4985	4.5035	4.5041	4.978	4.951	4.973
1907.5	19175	4.5004	4.5056	4.4979	4.973	4.946	4.952

LTE BAND 2 Channel bandwidth: 10MHz							
Freq. (MHz)	CH	99% BW (MHz)			26 dB BW (MHz)		
		QPSK	16QAM	64QAM	QPSK	16QAM	64QAM
1855.0	18650	8.9981	8.9735	8.9659	9.860	9.760	9.801
1880.0	18900	8.9994	8.9642	8.9769	9.859	9.704	9.717
1905.0	19150	9.0067	8.9716	8.9665	9.825	9.797	9.771

LTE BAND 2 Channel bandwidth: 15MHz							
Freq. (MHz)	CH	99% BW (MHz)			26 dB BW (MHz)		
		QPSK	16QAM	64QAM	QPSK	16QAM	64QAM
1857.5	18675	13.491	13.476	13.461	14.677	14.720	14.599
1880.0	18900	13.495	13.459	13.462	14.681	14.744	14.710
1902.5	19125	13.483	13.470	13.482	14.728	14.659	14.717

LTE BAND 2 Channel bandwidth: 20MHz							
Freq. (MHz)	CH	99% BW (MHz)			26 dB BW (MHz)		
		QPSK	16QAM	64QAM	QPSK	16QAM	64QAM
1860.0	18700	17.934	17.953	17.966	19.317	19.471	19.452
1880.0	18900	17.936	17.979	17.959	19.420	19.535	19.517
1900.0	19100	17.945	17.978	17.968	19.385	19.464	19.464

LTE BAND 4 Channel bandwidth: 1.4MHz							
Freq. (MHz)	CH	99% BW (MHz)			26 dB BW (MHz)		
		QPSK	16QAM	64QAM	QPSK	16QAM	64QAM
1710.7	19957	1.0926	1.0957	1.0961	1.230	1.242	1.228
1732.5	20175	1.0939	1.0930	1.0965	1.232	1.232	1.235
1754.3	20393	1.0923	1.0943	1.0962	1.240	1.241	1.244

LTE BAND 4 Channel bandwidth: 3MHz							
Freq. (MHz)	CH	99% BW (MHz)			26 dB BW (MHz)		
		QPSK	16QAM	64QAM	QPSK	16QAM	64QAM
1711.5	19965	2.7000	2.7028	2.6975	2.995	3.007	3.013
1732.5	20175	2.6999	2.6990	2.6997	2.983	3.005	3.009
1753.5	20385	2.6981	2.7003	2.7027	3.001	3.000	3.011

LTE BAND 4 Channel bandwidth: 5MHz							
Freq. (MHz)	CH	99% BW (MHz)			26 dB BW (MHz)		
		QPSK	16QAM	64QAM	QPSK	16QAM	64QAM
1712.5	19957	4.5072	4.5028	4.5078	4.965	4.917	4.985
1732.5	20175	4.5006	4.5047	4.5044	4.944	4.988	4.981
1752.5	20375	4.4960	4.5052	4.5060	4.983	4.964	4.961

LTE BAND 4 Channel bandwidth: 10MHz							
Freq. (MHz)	CH	99% BW (MHz)			26 dB BW (MHz)		
		QPSK	16QAM	64QAM	QPSK	16QAM	64QAM
1715.0	20000	8.9679	8.9656	8.9618	9.731	9.770	9.819
1732.5	20175	8.9734	8.9654	8.9741	9.762	9.748	9.722
1750.0	20350	8.9596	8.9652	8.9679	9.820	9.726	9.792

LTE BAND 4 Channel bandwidth: 15MHz							
Freq. (MHz)	CH	99% BW (MHz)			26 dB BW (MHz)		
		QPSK	16QAM	64QAM	QPSK	16QAM	64QAM
1717.5	20025	13.507	13.449	13.465	14.723	14.417	14.608
1732.5	20175	13.466	13.493	13.470	14.646	14.728	14.710
1747.5	20325	13.455	13.455	13.457	14.716	14.676	14.677

LTE BAND 4 Channel bandwidth: 20MHz							
Freq. (MHz)	CH	99% BW (MHz)			26 dB BW (MHz)		
		QPSK	16QAM	64QAM	QPSK	16QAM	64QAM
1720.0	20050	17.941	17.965	17.942	19.515	19.487	19.355
1732.5	20175	17.974	17.994	18.005	19.583	19.471	19.485
1745.0	20300	17.955	17.945	17.918	19.353	19.409	19.387

Unless otherwise stated the results shown in this test report refer only to the sample(s) tested and such sample(s) are retained for 90 days only.

除非另有說明，此報告結果僅對測試之樣品負責，同時此樣品僅保留90天。本報告未經本公司書面許可，不可部份複製。

This document is issued by the Company subject to its General Conditions of Service printed overleaf, available on request or accessible at www.sgs.com/terms_and_conditions.htm and for electronic format documents, subject to Terms and Conditions for Electronic Documents at www.sgs.com/terms_e-document.htm. Attention is drawn to the limitation of liability, indemnification and jurisdiction issues defined therein. Any holder of this document is advised that information contained hereon reflects the Company's findings at the time of its intervention only and within the limits of Client's instructions, if any. The Company's sole responsibility is to its Client and this document does not exonerate parties to a transaction from exercising all their rights and obligations under the transaction documents. This document cannot be reproduced except in full, without prior written approval of the Company. Any unauthorized alteration, forgery or falsification of the content or appearance of this document is unlawful and offenders may be prosecuted to the fullest extent of the law.

LTE BAND 5 Channel bandwidth: 1.4MHz							
Freq. (MHz)	CH	99% BW (MHz)			26 dB BW (MHz)		
		QPSK	16QAM	64QAM	QPSK	16QAM	64QAM
824.7	20407	1.0915	1.0925	1.0925	1.229	1.242	1.241
836.5	20525	1.0912	1.0971	1.0932	1.228	1.242	1.233
848.3	20643	1.0869	1.0983	1.0970	1.242	1.228	1.228

LTE BAND 5 Channel bandwidth: 3MHz							
Freq. (MHz)	CH	99% BW (MHz)			26 dB BW (MHz)		
		QPSK	16QAM	64QAM	QPSK	16QAM	64QAM
825.5	20415	2.6964	2.6989	2.7019	3.010	2.977	2.978
836.5	20525	2.6990	2.7001	2.7045	3.001	2.992	2.982
847.5	20635	2.6977	2.6978	2.7060	3.010	3.007	2.996

LTE BAND 5 Channel bandwidth: 5MHz							
Freq. (MHz)	CH	99% BW (MHz)			26 dB BW (MHz)		
		QPSK	16QAM	64QAM	QPSK	16QAM	64QAM
826.5	20425	4.5068	4.5067	4.4972	4.976	4.926	4.930
836.5	20525	4.4998	4.5041	4.5073	4.981	4.948	4.948
846.5	20625	4.5049	4.5033	4.4987	4.955	4.936	5.000

LTE BAND 5 Channel bandwidth: 10MHz							
Freq. (MHz)	CH	99% BW (MHz)			26 dB BW (MHz)		
		QPSK	16QAM	64QAM	QPSK	16QAM	64QAM
829.0	20450	8.9937	8.9898	8.9913	9.540	9.752	9.765
836.5	20525	8.9743	8.9599	8.9720	9.694	9.776	9.708
844.0	20600	9.0035	9.0016	9.0087	9.834	9.728	9.707

LTE BAND 7 Channel bandwidth: 5MHz							
Freq. (MHz)	CH	99% BW (MHz)			26 dB BW (MHz)		
		QPSK	16QAM	64QAM	QPSK	16QAM	64QAM
2502.5	20775	4.5035	4.5026	4.4990	4.967	4.915	4.971
2535.0	21100	4.4957	4.4966	4.5038	4.930	4.926	4.951
2567.5	21425	4.4928	4.4962	4.5134	4.991	4.927	4.982

LTE BAND 7 Channel bandwidth: 10MHz							
Freq. (MHz)	CH	99% BW (MHz)			26 dB BW (MHz)		
		QPSK	16QAM	64QAM	QPSK	16QAM	64QAM
2505.0	20800	8.9912	8.9734	8.9723	9.816	9.733	9.661
2535.0	21100	8.9886	8.9627	8.9720	9.812	9.696	9.743
2565.0	21400	9.0011	8.9831	8.9763	9.763	9.742	9.718

LTE BAND 7 Channel bandwidth: 15MHz							
Freq. (MHz)	CH	99% BW (MHz)			26 dB BW (MHz)		
		QPSK	16QAM	64QAM	QPSK	16QAM	64QAM
2507.5	20825	13.434	13.482	13.471	14.613	14.738	14.588
2535.0	21100	13.457	13.443	13.443	14.694	14.512	14.596
2562.5	21375	13.481	13.446	13.467	14.639	14.608	14.729

LTE BAND 7 Channel bandwidth: 20MHz							
Freq. (MHz)	CH	99% BW (MHz)			26 dB BW (MHz)		
		QPSK	16QAM	64QAM	QPSK	16QAM	64QAM
2510.0	20850	17.936	17.954	17.929	19.508	19.491	19.432
2535.0	21100	17.934	17.946	17.941	19.517	19.244	19.522
2560.0	21350	17.937	17.941	17.920	19.326	19.409	19.462

LTE BAND 12 Channel bandwidth: 1.4MHz							
Freq. (MHz)	CH	99% BW (MHz)			26 dB BW (MHz)		
		QPSK	16QAM	64QAM	QPSK	16QAM	64QAM
699.7	23017	1.0943	1.0921	1.0953	1.246	1.240	1.234
707.5	23095	1.0957	1.0970	1.0906	1.228	1.244	1.222
715.3	23173	1.0926	1.0948	1.0946	1.233	1.242	1.233

LTE BAND 12 Channel bandwidth: 3MHz							
Freq. (MHz)	CH	99% BW (MHz)			26 dB BW (MHz)		
		QPSK	16QAM	64QAM	QPSK	16QAM	64QAM
700.5	23025	2.7004	2.7028	2.6968	2.995	3.000	3.010
707.5	23095	2.6968	2.7071	2.7015	3.015	2.990	2.960
714.5	23165	2.6993	2.7021	2.7028	2.988	2.995	3.007

LTE BAND 12 Channel bandwidth: 5MHz							
Freq. (MHz)	CH	99% BW (MHz)			26 dB BW (MHz)		
		QPSK	16QAM	64QAM	QPSK	16QAM	64QAM
701.5	23035	4.4912	4.5133	4.5127	4.964	4.948	4.954
707.5	23095	4.4971	4.4912	4.5058	4.923	4.903	4.923
713.5	23155	4.5004	4.5080	4.5032	4.937	4.916	4.974

LTE BAND 12 Channel bandwidth: 10MHz							
Freq. (MHz)	CH	99% BW (MHz)			26 dB BW (MHz)		
		QPSK	16QAM	64QAM	QPSK	16QAM	64QAM
704.0	23060	8.9779	8.9837	8.9651	9.811	9.739	9.784
707.5	23095	9.0130	8.9680	8.9491	9.817	9.738	9.751
711.0	23130	9.0093	8.9771	8.9743	9.785	9.772	9.702

LTE BAND 13 Channel bandwidth: 5MHz							
Freq. (MHz)	CH	99% BW (MHz)			26 dB BW (MHz)		
		QPSK	16QAM	64QAM	QPSK	16QAM	64QAM
779.5	23205	4.5117	4.4907	4.5152	4.994	4.951	4.925
782.0	23230	4.5009	4.5139	4.5018	4.943	4.959	4.949
784.5	23255	4.4878	4.4980	4.4954	4.946	4.930	4.875

LTE BAND 13 Channel bandwidth: 10MHz							
Freq. (MHz)	CH	99% BW (MHz)			26 dB BW (MHz)		
		QPSK	16QAM	64QAM	QPSK	16QAM	64QAM
782.0	23230	9.009	8.971	8.959	9.746	9.732	9.687

Unless otherwise stated the results shown in this test report refer only to the sample(s) tested and such sample(s) are retained for 90 days only.

除非另有說明，此報告結果僅對測試之樣品負責，同時此樣品僅保留90天。本報告未經本公司書面許可，不可部份複製。

This document is issued by the Company subject to its General Conditions of Service printed overleaf, available on request or accessible at www.sgs.com/terms_and_conditions.htm and for electronic format documents, subject to Terms and Conditions for Electronic Documents at www.sgs.com/terms_e-document.htm. Attention is drawn to the limitation of liability, indemnification and jurisdiction issues defined therein. Any holder of this document is advised that information contained hereon reflects the Company's findings at the time of its intervention only and within the limits of Client's instructions, if any. The Company's sole responsibility is to its Client and this document does not exonerate parties to a transaction from exercising all their rights and obligations under the transaction documents. This document cannot be reproduced except in full, without prior written approval of the Company. Any unauthorized alteration, forgery or falsification of the content or appearance of this document is unlawful and offenders may be prosecuted to the fullest extent of the law.

LTE BAND 17 Channel bandwidth: 5MHz							
Freq. (MHz)	CH	99% BW (MHz)			26 dB BW (MHz)		
		QPSK	16QAM	64QAM	QPSK	16QAM	64QAM
706.5	23755	4.5005	4.5110	4.5107	4.914	4.973	4.951
710.0	23790	4.4995	4.4998	4.5025	4.926	4.941	4.949
713.5	23825	4.5010	4.5118	4.5089	5.001	4.954	4.942

LTE BAND 17 Channel bandwidth: 10MHz							
Freq. (MHz)	CH	99% BW (MHz)			26 dB BW (MHz)		
		QPSK	16QAM	64QAM	QPSK	16QAM	64QAM
709.0	23780	8.9939	8.9483	8.9533	9.748	9.741	9.720
710.0	23790	8.9956	8.9833	8.9450	9.813	9.741	9.732
711.0	23800	8.9910	8.9713	8.9715	9.752	9.743	9.729

LTE BAND 38 Channel bandwidth: 5MHz							
Freq. (MHz)	CH	99% BW (MHz)			26 dB BW (MHz)		
		QPSK	16QAM	64QAM	QPSK	16QAM	64QAM
2572.5	37775	4.5058	4.5101	4.4963	4.952	4.950	4.913
2595.0	38000	4.5050	4.4942	4.5102	5.125	4.901	4.867
2617.5	38225	4.5063	4.4830	4.4998	4.966	4.893	4.924

LTE BAND 38 Channel bandwidth: 10MHz							
Freq. (MHz)	CH	99% BW (MHz)			26 dB BW (MHz)		
		QPSK	16QAM	64QAM	QPSK	16QAM	64QAM
2575.0	37800	8.9685	8.9885	8.9801	9.691	9.644	9.679
2595.0	38000	8.9695	8.9733	8.9611	9.607	9.639	9.692
2615.0	38200	8.9574	8.9366	8.9866	9.656	9.658	9.678

LTE BAND 38 Channel bandwidth: 15MHz							
Freq. (MHz)	CH	99% BW (MHz)			26 dB BW (MHz)		
		QPSK	16QAM	64QAM	QPSK	16QAM	64QAM
2577.5	37825	13.490	13.465	13.432	14.399	14.723	14.612
2595.0	38000	13.435	13.488	13.418	14.485	14.525	14.516
2612.5	38175	13.488	13.464	13.472	14.496	14.588	14.578

LTE BAND 38 Channel bandwidth: 20MHz							
Freq. (MHz)	CH	99% BW (MHz)			26 dB BW (MHz)		
		QPSK	16QAM	64QAM	QPSK	16QAM	64QAM
2580.0	37850	17.935	17.899	17.872	19.197	19.232	19.185
2595.0	38000	17.909	17.933	17.930	19.275	19.292	19.406
2610.0	38150	17.975	17.878	17.924	19.273	19.328	19.315

Unless otherwise stated the results shown in this test report refer only to the sample(s) tested and such sample(s) are retained for 90 days only.

除非另有說明，此報告結果僅對測試之樣品負責，同時此樣品僅保留90天。本報告未經本公司書面許可，不可部份複製。

This document is issued by the Company subject to its General Conditions of Service printed overleaf, available on request or accessible at www.sgs.com/terms_and_conditions.htm and for electronic format documents, subject to Terms and Conditions for Electronic Documents at www.sgs.com/terms_e-document.htm. Attention is drawn to the limitation of liability, indemnification and jurisdiction issues defined therein. Any holder of this document is advised that information contained hereon reflects the Company's findings at the time of its intervention only and within the limits of Client's instructions, if any. The Company's sole responsibility is to its Client and this document does not exonerate parties to a transaction from exercising all their rights and obligations under the transaction documents. This document cannot be reproduced except in full, without prior written approval of the Company. Any unauthorized alteration, forgery or falsification of the content or appearance of this document is unlawful and offenders may be prosecuted to the fullest extent of the law.

GSM_850MHz_LowCH128-824.2

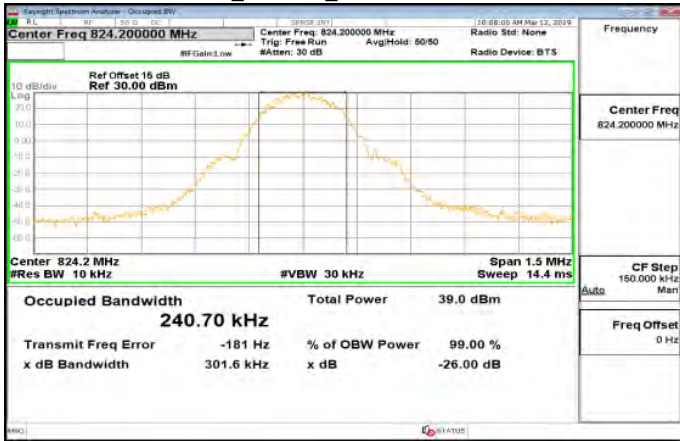

GPRS_850MHz_LowCH128-824.2

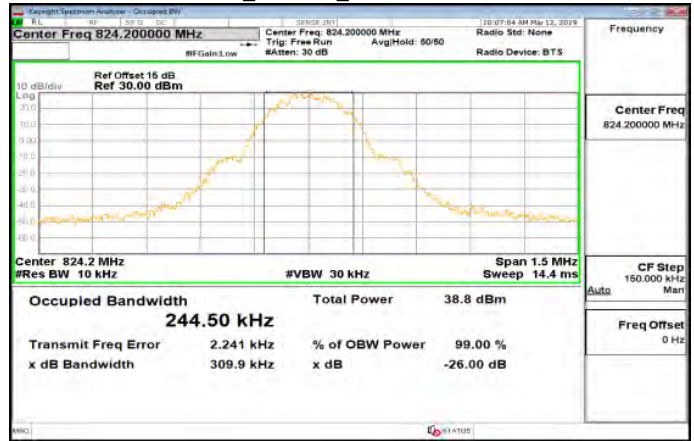

GSM_850MHz_MidCH190-836.6

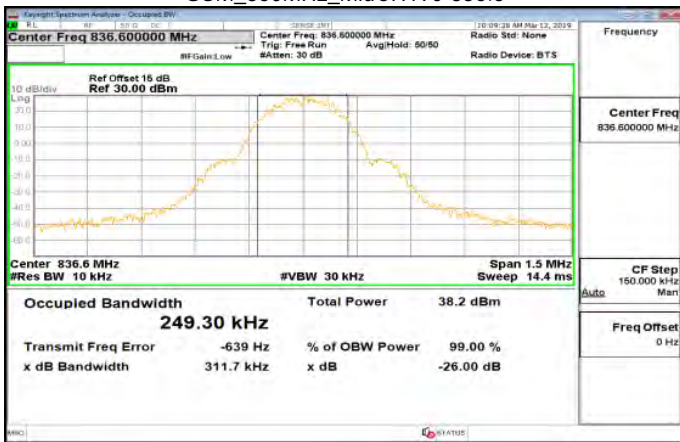

GPRS_850MHz_MidCH190-836.6

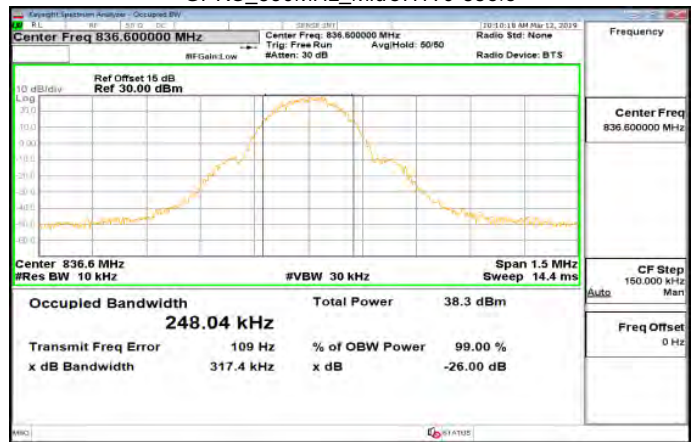

GSM_850MHz_HighCH251-848.8

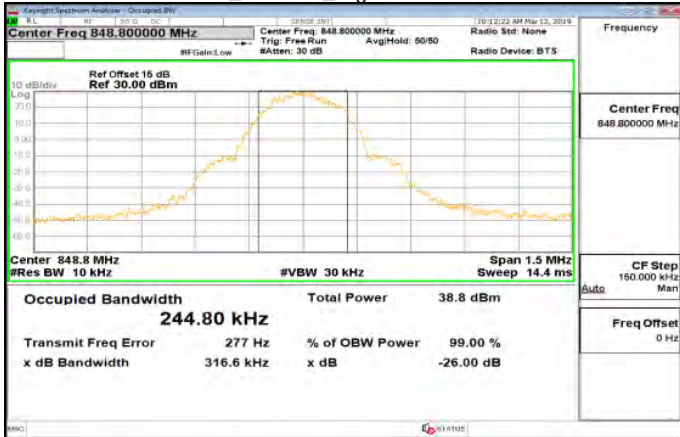

GPRS_850MHz_HighCH251-848.8

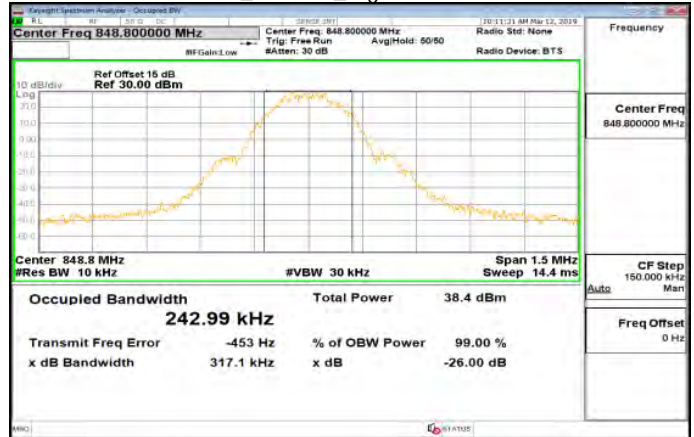

Unless otherwise stated the results shown in this test report refer only to the sample(s) tested and such sample(s) are retained for 90 days only.

除非另有說明，此報告結果僅對測試之樣品負責，同時此樣品僅保留90天。本報告未經本公司書面許可，不可部份複製。

This document is issued by the Company subject to its General Conditions of Service printed overleaf, available on request or accessible at www.sgs.com/terms_and_conditions.htm and for electronic format documents, subject to Terms and Conditions for Electronic Documents at www.sgs.com/terms_e-document.htm. Attention is drawn to the limitation of liability, indemnification and jurisdiction issues defined therein. Any holder of this document is advised that information contained hereon reflects the Company's findings at the time of its intervention only and within the limits of Client's instructions, if any. The Company's sole responsibility is to its Client and this document does not exonerate parties to a transaction from exercising all their rights and obligations under the transaction documents. This document cannot be reproduced except in full, without prior written approval of the Company. Any unauthorized alteration, forgery or falsification of the content or appearance of this document is unlawful and offenders may be prosecuted to the fullest extent of the law.

GSM_1900MHz_LowCH512-1850.2

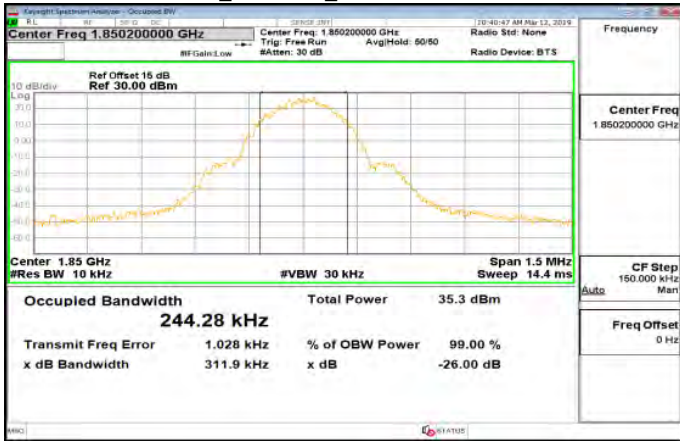

GPRS_1900MHz_LowCH512-1850.2

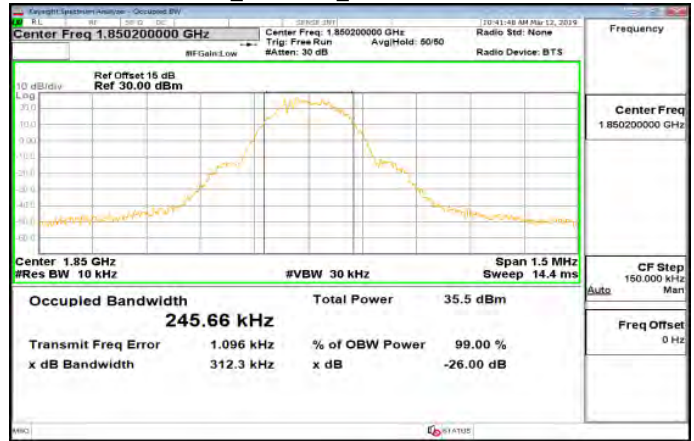

GSM_1900MHz_MidCH661-1880

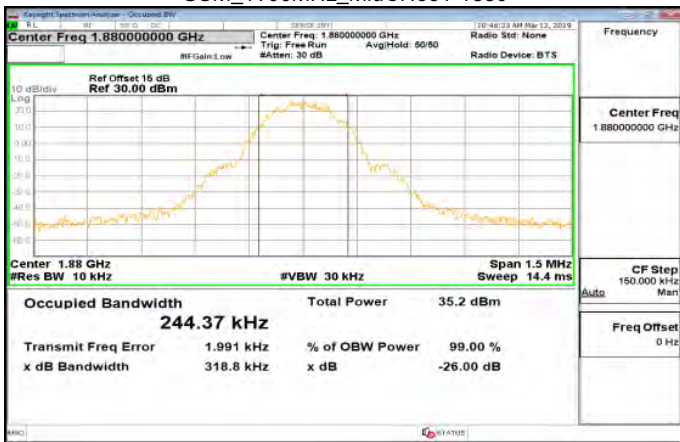

GPRS_1900MHz_MidCH661-1880

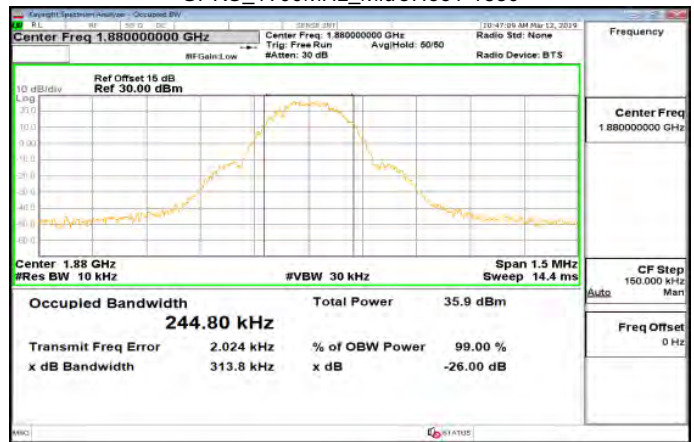

GSM_1900MHz_HighCH810-1909.8

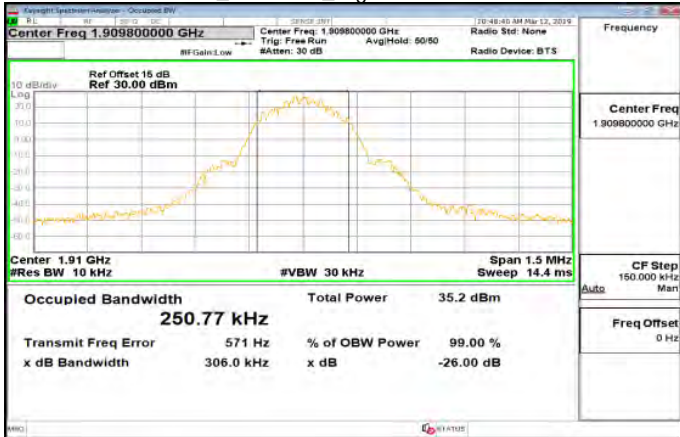

GPRS_1900MHz_HighCH810-1909.8

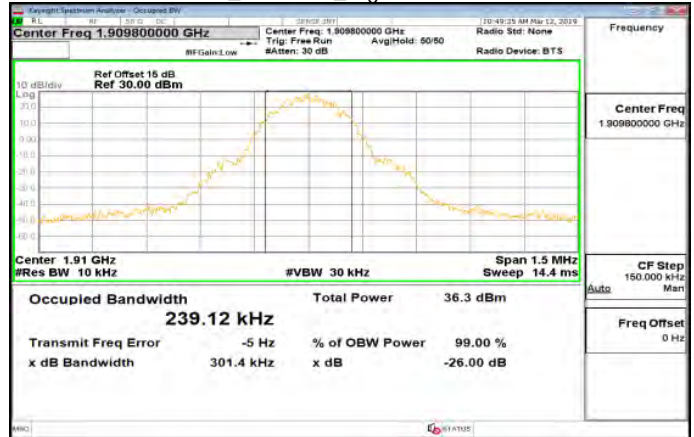

Unless otherwise stated the results shown in this test report refer only to the sample(s) tested and such sample(s) are retained for 90 days only.

除非另有說明，此報告結果僅對測試之樣品負責，同時此樣品僅保留90天。本報告未經本公司書面許可，不可部份複製。

This document is issued by the Company subject to its General Conditions of Service printed overleaf, available on request or accessible at www.sgs.com/terms_and_conditions.htm and for electronic format documents, subject to Terms and Conditions for Electronic Documents at www.sgs.com/terms_e-document.htm. Attention is drawn to the limitation of liability, indemnification and jurisdiction issues defined therein. Any holder of this document is advised that information contained hereon reflects the Company's findings at the time of its intervention only and within the limits of Client's instructions, if any. The Company's sole responsibility is to its Client and this document does not exonerate parties to a transaction from exercising all their rights and obligations under the transaction documents. This document cannot be reproduced except in full, without prior written approval of the Company. Any unauthorized alteration, forgery or falsification of the content or appearance of this document is unlawful and offenders may be prosecuted to the fullest extent of the law.

WCDMA_B2_LowCH9262-1852.4

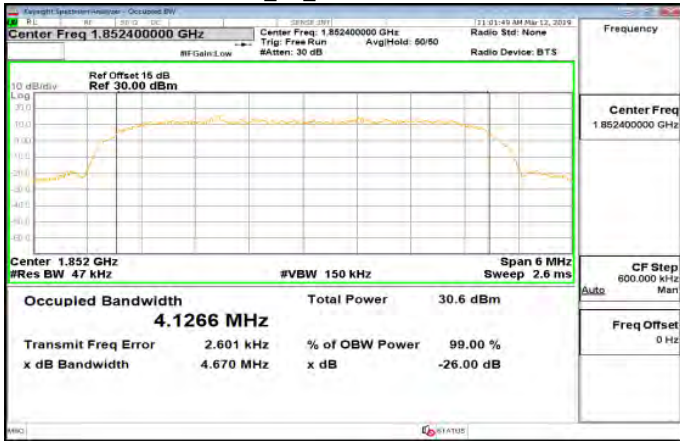

HSDPA_B2_LowCH9262-1852.4

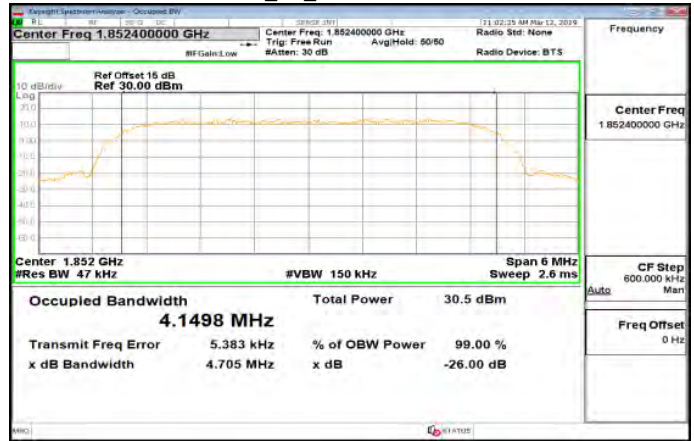

WCDMA_B2_MidCH9400-1880

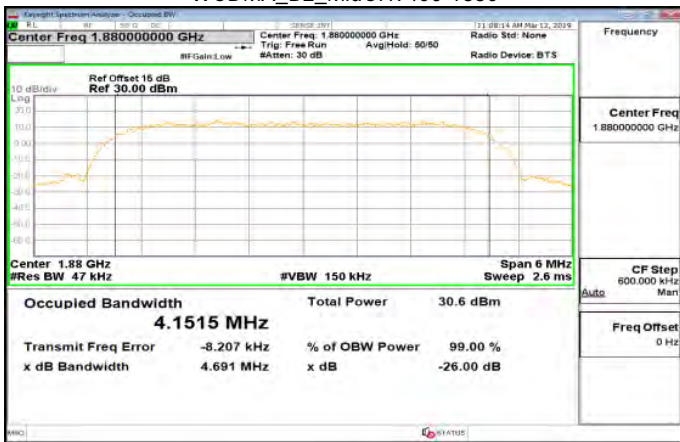

HSDPA_B2_MidCH9400-1880

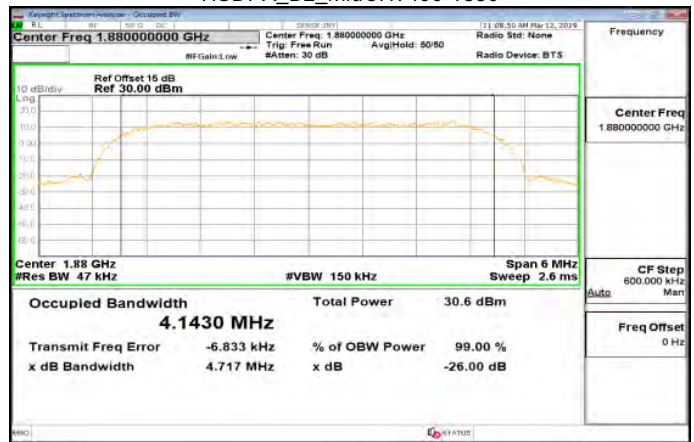

WCDMA_B2_HighCH9538-1907.6

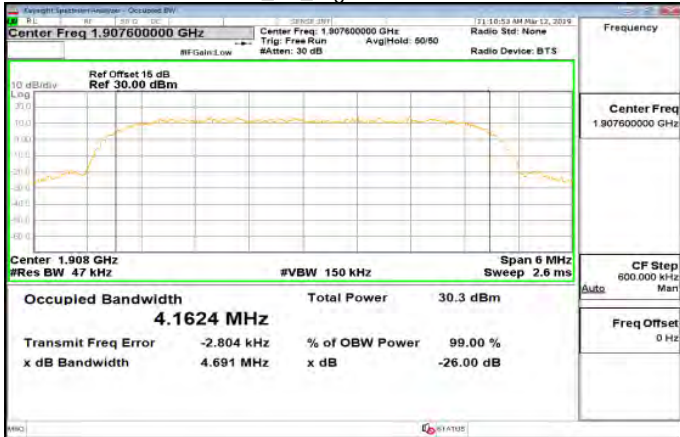

HSDPA_B2_HighCH9538-1907.6

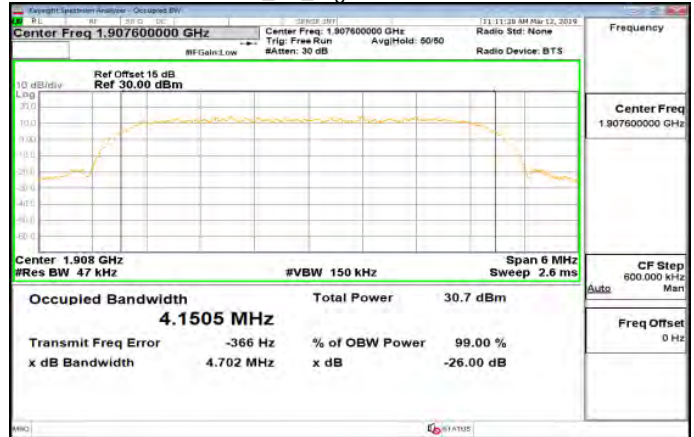

Unless otherwise stated the results shown in this test report refer only to the sample(s) tested and such sample(s) are retained for 90 days only.

除非另有說明，此報告結果僅對測試之樣品負責，同時此樣品僅保留90天。本報告未經本公司書面許可，不可部份複製。

This document is issued by the Company subject to its General Conditions of Service printed overleaf, available on request or accessible at www.sgs.com/terms_and_conditions.htm and for electronic format documents, subject to Terms and Conditions for Electronic Documents at www.sgs.com/terms_e-document.htm. Attention is drawn to the limitation of liability, indemnification and jurisdiction issues defined therein. Any holder of this document is advised that information contained hereon reflects the Company's findings at the time of its intervention only and within the limits of Client's instructions, if any. The Company's sole responsibility is to its Client and this document does not exonerate parties to a transaction from exercising all their rights and obligations under the transaction documents. This document cannot be reproduced except in full, without prior written approval of the Company. Any unauthorized alteration, forgery or falsification of the content or appearance of this document is unlawful and offenders may be prosecuted to the fullest extent of the law.

HSUPA_B2_LowCH9262-1852.4

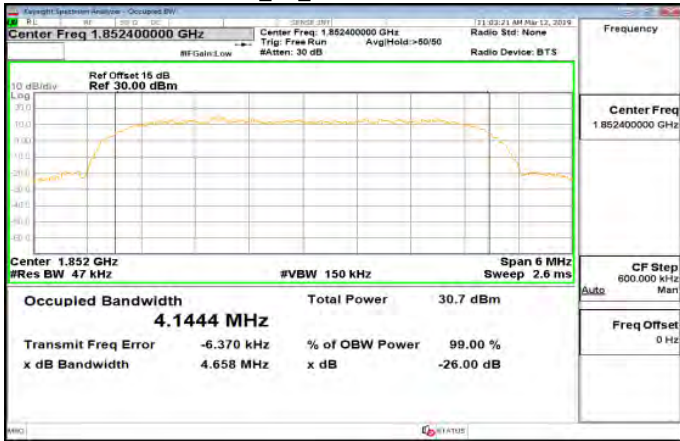

WCDMA_B4_LowCH1312-1712.4

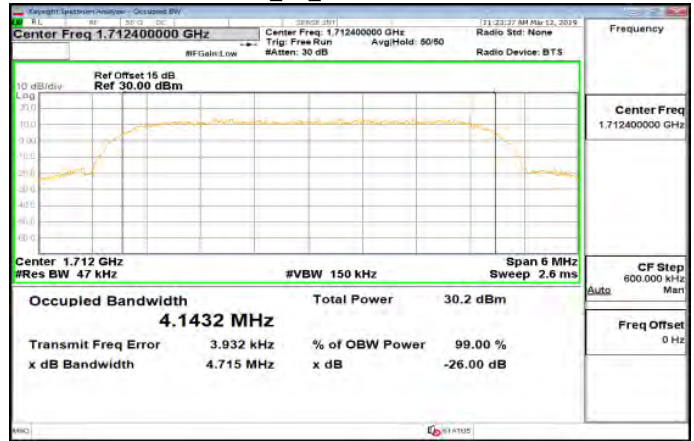

HSUPA_B2_MidCH9400-1880

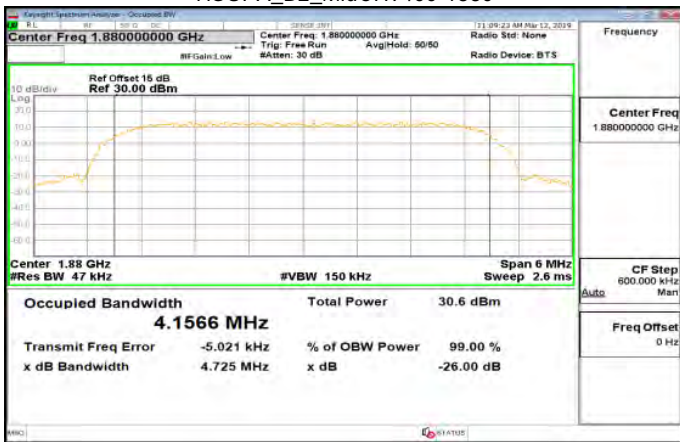

WCDMA_B4_MidCH1413-1732.6

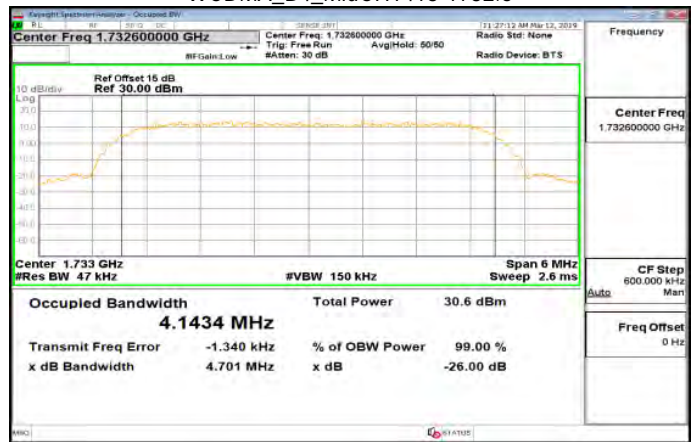

HSUPA_B2_HighCH9538-1907.6

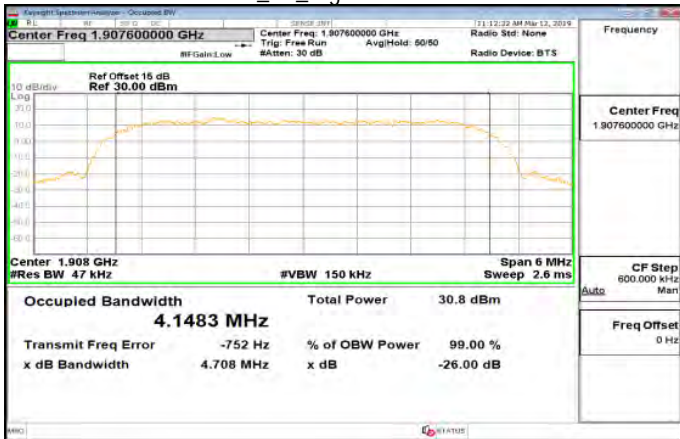

WCDMA_B4_HighCH1513-1752.6

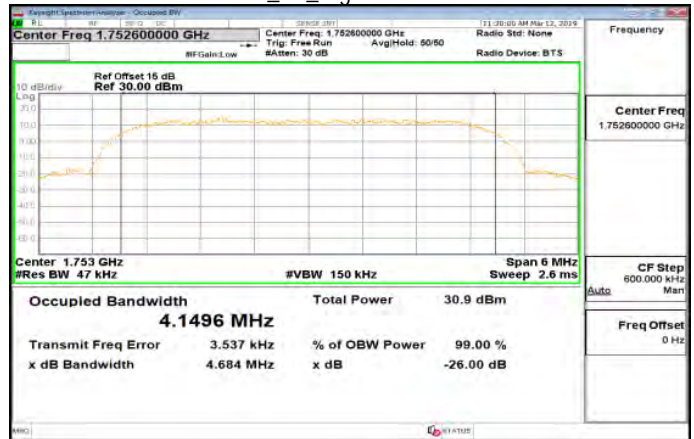

Unless otherwise stated the results shown in this test report refer only to the sample(s) tested and such sample(s) are retained for 90 days only.

除非另有說明，此報告結果僅對測試之樣品負責，同時此樣品僅保留90天。本報告未經本公司書面許可，不可部份複製。

This document is issued by the Company subject to its General Conditions of Service printed overleaf, available on request or accessible at www.sgs.com/terms_and_conditions.htm and for electronic format documents, subject to Terms and Conditions for Electronic Documents at www.sgs.com/terms_e-document.htm. Attention is drawn to the limitation of liability, indemnification and jurisdiction issues defined therein. Any holder of this document is advised that information contained hereon reflects the Company's findings at the time of its intervention only and within the limits of Client's instructions, if any. The Company's sole responsibility is to its Client and this document does not exonerate parties to a transaction from exercising all their rights and obligations under the transaction documents. This document cannot be reproduced except in full, without prior written approval of the Company. Any unauthorized alteration, forgery or falsification of the content or appearance of this document is unlawful and offenders may be prosecuted to the fullest extent of the law.

HSDPA_B4_LowCH1312-1712.4

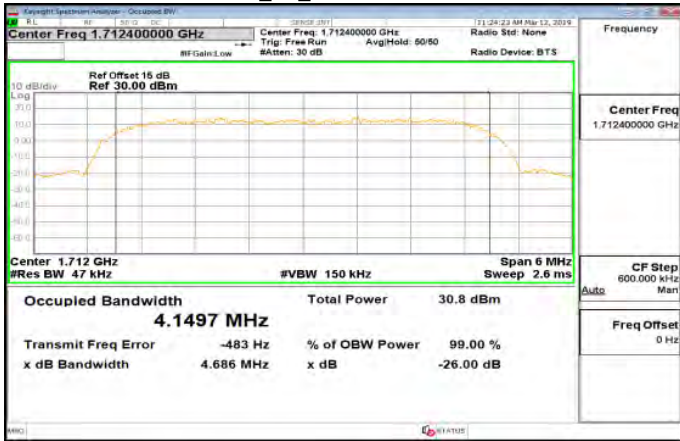

HSUPA_B4_LowCH1312-1712.4

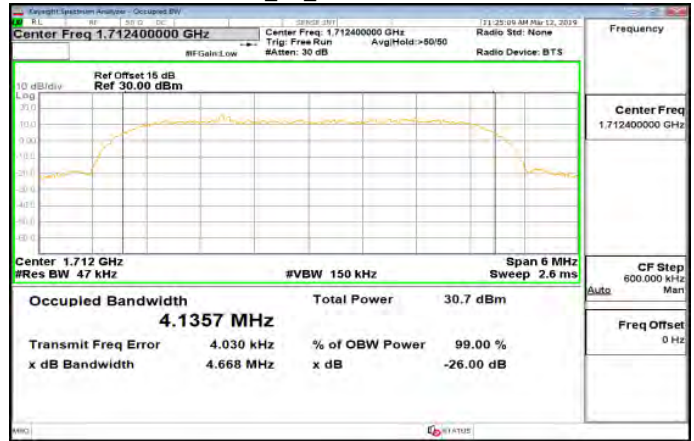

HSDPA_B4_MidCH1413-1732.6

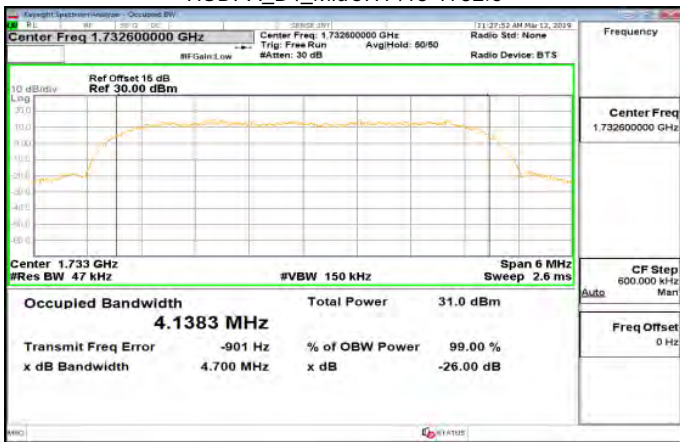

HSUPA_B4_MidCH1413-1732.6

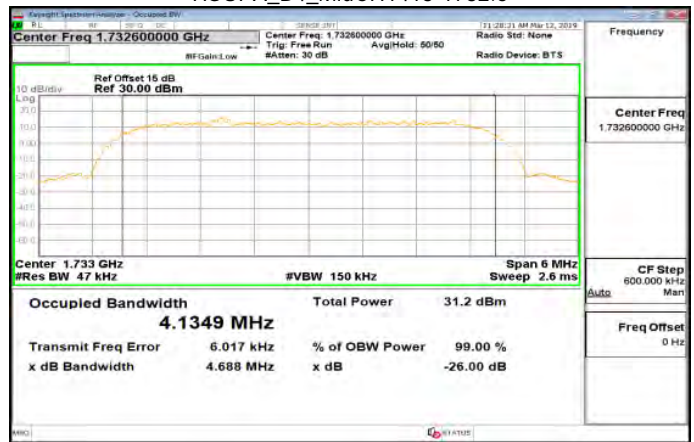

HSDPA_B4_HighCH1513-1752.6

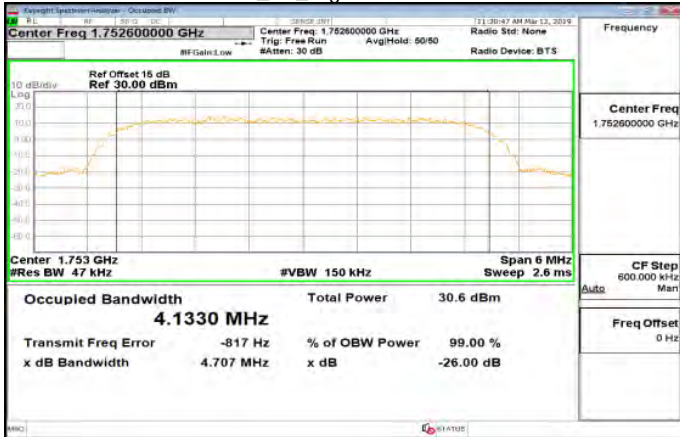

HSUPA_B4_HighCH1513-1752.6

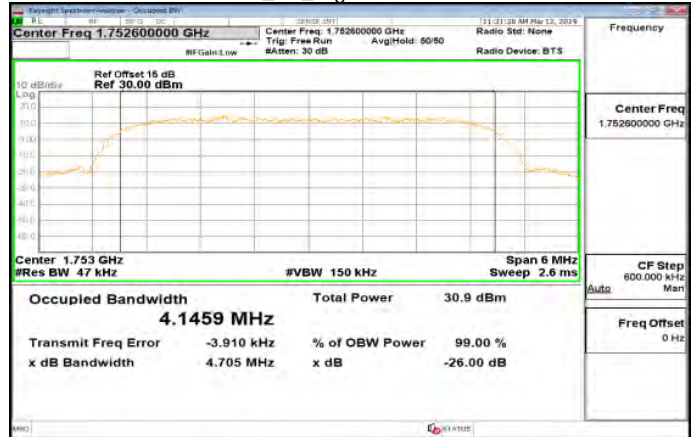

Unless otherwise stated the results shown in this test report refer only to the sample(s) tested and such sample(s) are retained for 90 days only.

除非另有說明，此報告結果僅對測試之樣品負責，同時此樣品僅保留90天。本報告未經本公司書面許可，不可部份複製。

This document is issued by the Company subject to its General Conditions of Service printed overleaf, available on request or accessible at www.sgs.com/terms_and_conditions.htm and for electronic format documents, subject to Terms and Conditions for Electronic Documents at www.sgs.com/terms_e-document.htm. Attention is drawn to the limitation of liability, indemnification and jurisdiction issues defined therein. Any holder of this document is advised that information contained hereon reflects the Company's findings at the time of its intervention only and within the limits of Client's instructions, if any. The Company's sole responsibility is to its Client and this document does not exonerate parties to a transaction from exercising all their rights and obligations under the transaction documents. This document cannot be reproduced except in full, without prior written approval of the Company. Any unauthorized alteration, forgery or falsification of the content or appearance of this document is unlawful and offenders may be prosecuted to the fullest extent of the law.

WCDMA_B5_LowCH4132-826.4

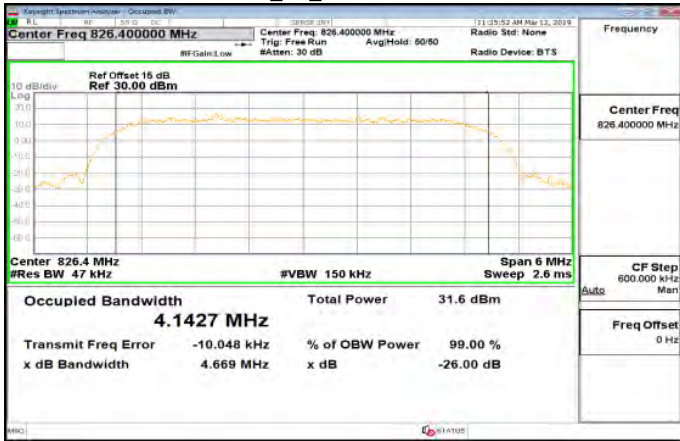

HSDPA_B5_LowCH4132-826.4

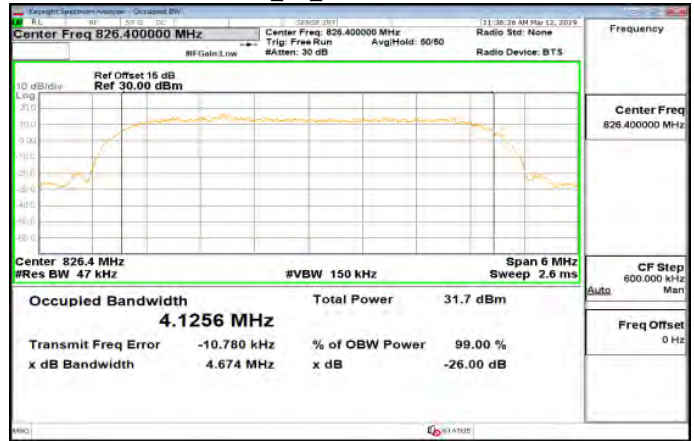

WCDMA_B5_MidCH4183-836.6

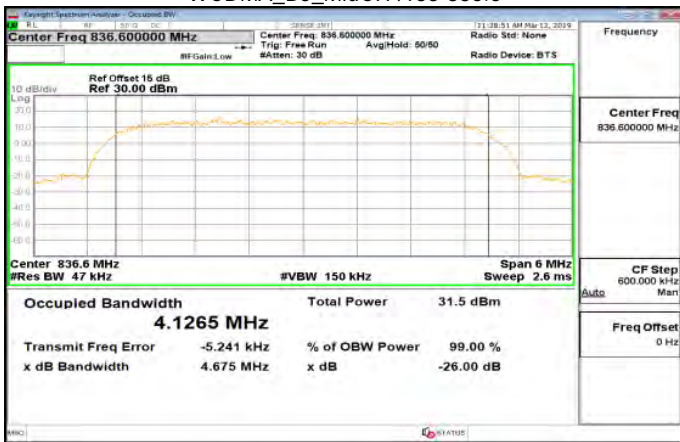

HSDPA_B5_MidCH4183-836.6

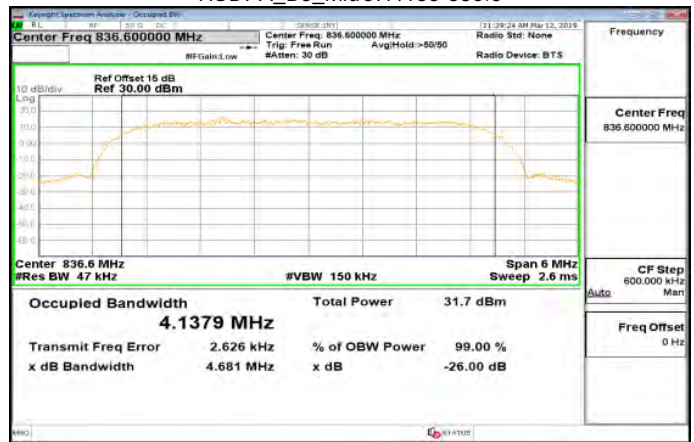

WCDMA_B5_HighCH4233-846.6

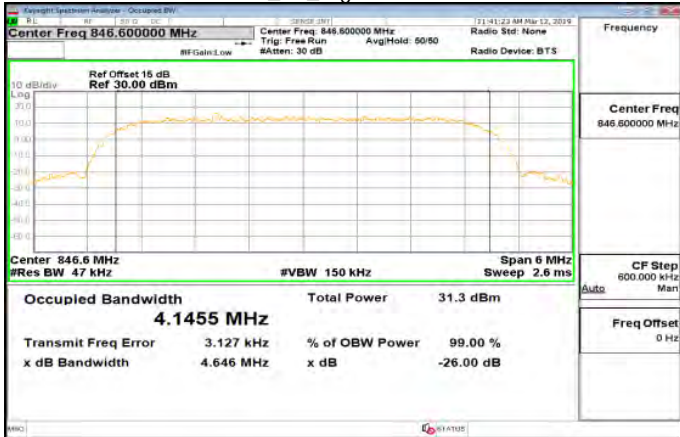

HSDPA_B5_HighCH4233-846.6

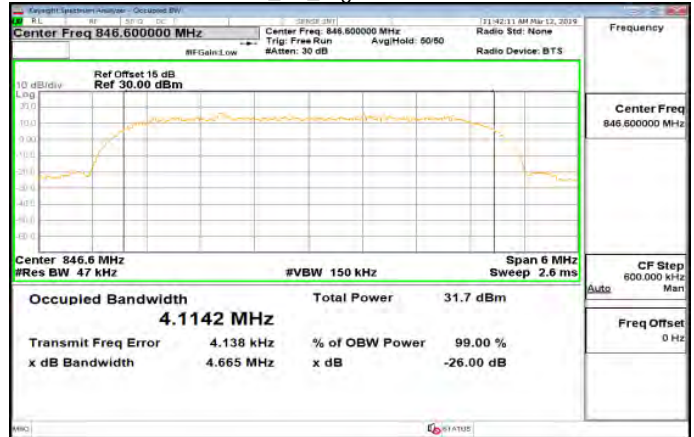

Unless otherwise stated the results shown in this test report refer only to the sample(s) tested and such sample(s) are retained for 90 days only.

除非另有說明，此報告結果僅對測試之樣品負責，同時此樣品僅保留90天。本報告未經本公司書面許可，不可部份複製。

This document is issued by the Company subject to its General Conditions of Service printed overleaf, available on request or accessible at www.sgs.com/terms_and_conditions.htm and for electronic format documents, subject to Terms and Conditions for Electronic Documents at www.sgs.com/terms_e-document.htm. Attention is drawn to the limitation of liability, indemnification and jurisdiction issues defined therein. Any holder of this document is advised that information contained hereon reflects the Company's findings at the time of its intervention only and within the limits of Client's instructions, if any. The Company's sole responsibility is to its Client and this document does not exonerate parties to a transaction from exercising all their rights and obligations under the transaction documents. This document cannot be reproduced except in full, without prior written approval of the Company. Any unauthorized alteration, forgery or falsification of the content or appearance of this document is unlawful and offenders may be prosecuted to the fullest extent of the law.

HSUPA_B5_LowCH4132-826.4

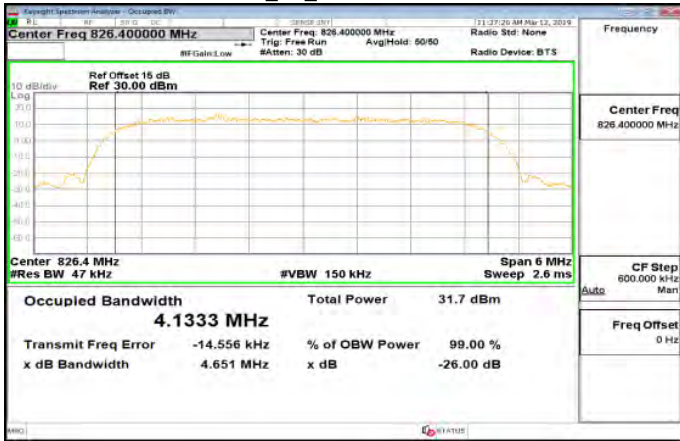

Band2_1_4MHz_QPSK_6_0_Main_LowCH18607-1850.7

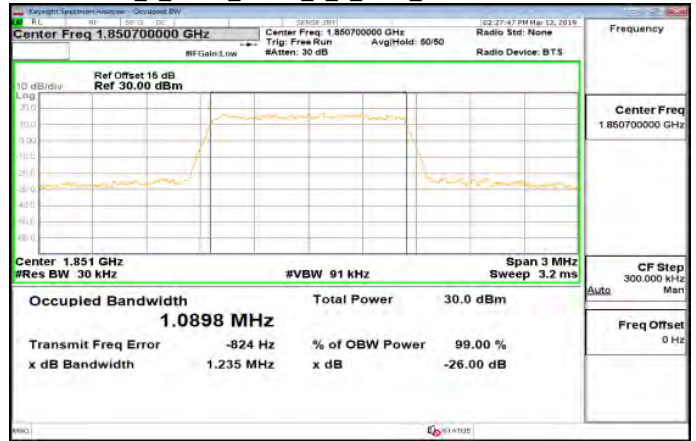

HSUPA_B5_MidCH4183-836.6

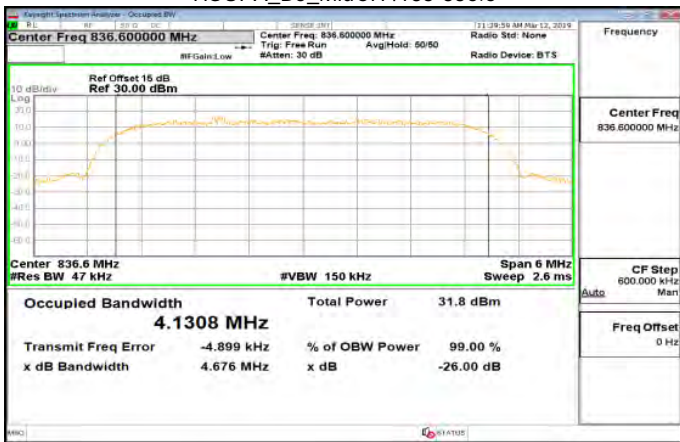

Band2_1_4MHz_QPSK_6_0_Main_MidCH18900-1880

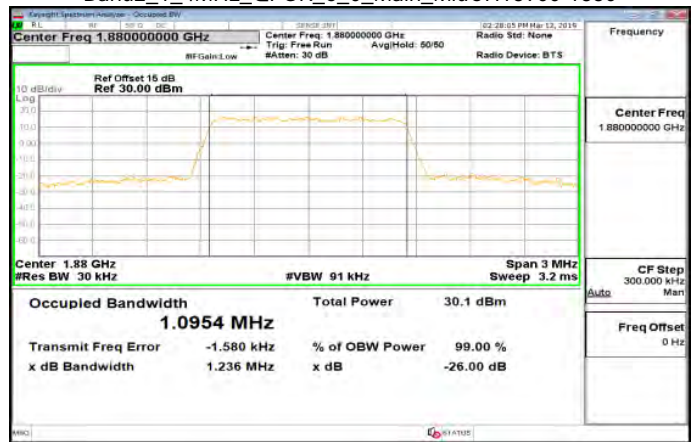

HSUPA_B5_HighCH4233-846.6

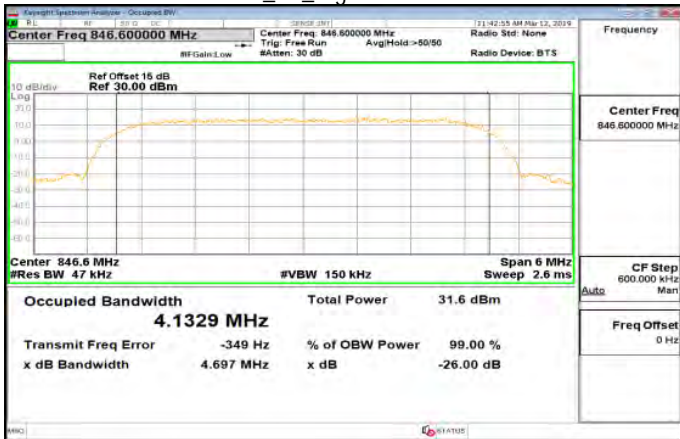

Band2_1_4MHz_QPSK_6_0_Main_HighCH19193-1909.3

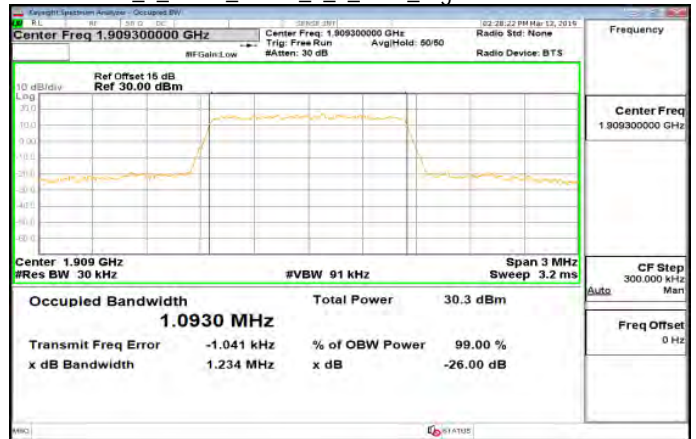

Unless otherwise stated the results shown in this test report refer only to the sample(s) tested and such sample(s) are retained for 90 days only.

除非另有說明，此報告結果僅對測試之樣品負責，同時此樣品僅保留90天。本報告未經本公司書面許可，不可部份複製。

This document is issued by the Company subject to its General Conditions of Service printed overleaf, available on request or accessible at www.sgs.com/terms_and_conditions.htm and for electronic format documents, subject to Terms and Conditions for Electronic Documents at www.sgs.com/terms_e-document.htm. Attention is drawn to the limitation of liability, indemnification and jurisdiction issues defined therein. Any holder of this document is advised that information contained hereon reflects the Company's findings at the time of its intervention only and within the limits of Client's instructions, if any. The Company's sole responsibility is to its Client and this document does not exonerate parties to a transaction from exercising all their rights and obligations under the transaction documents. This document cannot be reproduced except in full, without prior written approval of the Company. Any unauthorized alteration, forgery or falsification of the content or appearance of this document is unlawful and offenders may be prosecuted to the fullest extent of the law.

Band2_1_4MHz_16QAM_6_0_Main_LowCH18607-1850.7

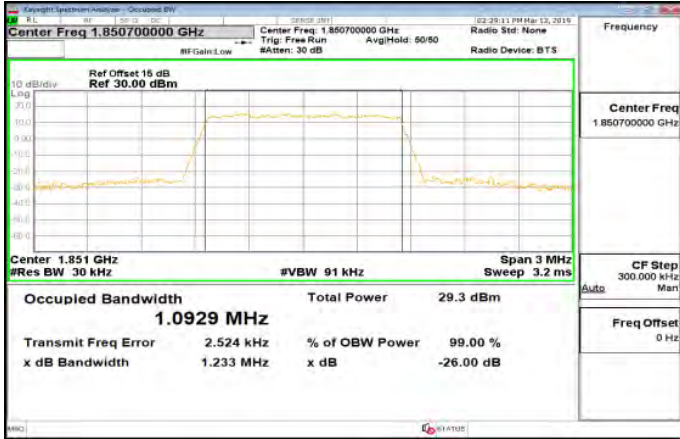

Band2_1_4MHz_64QAM_6_0_Main_LowCH18607-1850.7

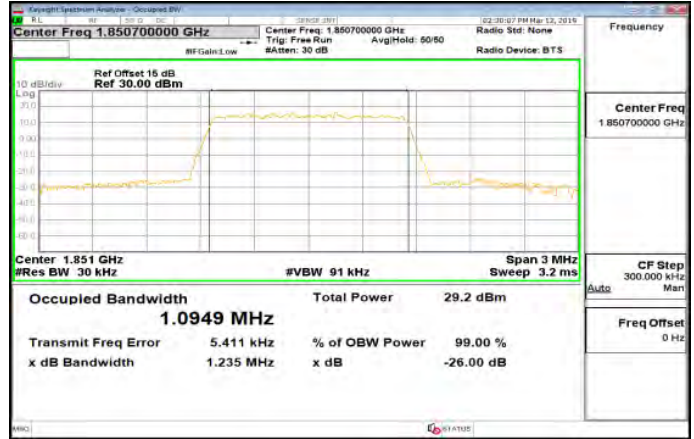

Band2_1_4MHz_16QAM_6_0_Main_MidCH18900-1880

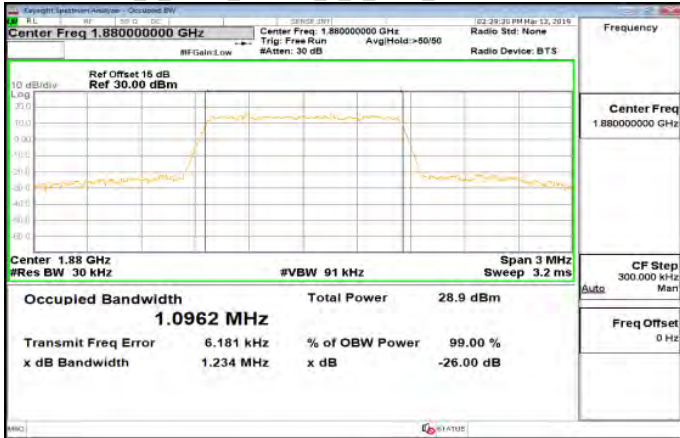

Band2_1_4MHz_64QAM_6_0_Main_MidCH18900-1880

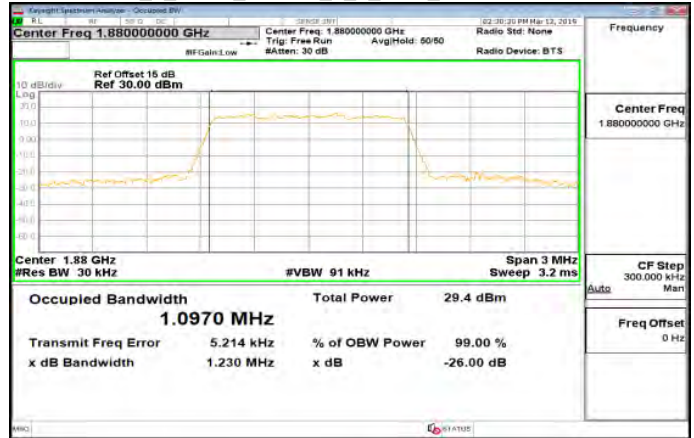

Band2_1_4MHz_16QAM_6_0_Main_HighCH19193-1909.3

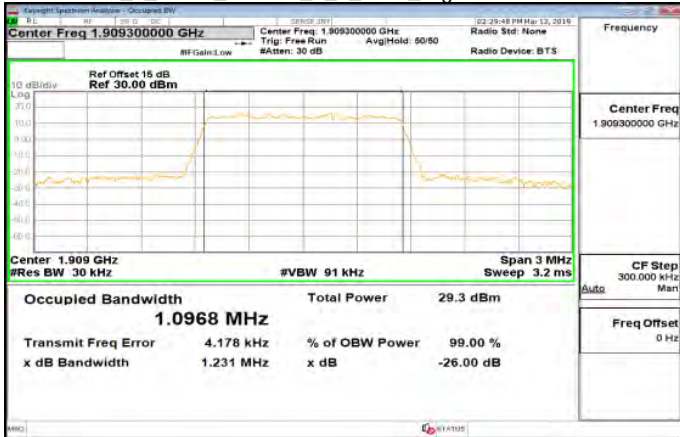

Band2_1_4MHz_64QAM_6_0_Main_HighCH19193-1909.3

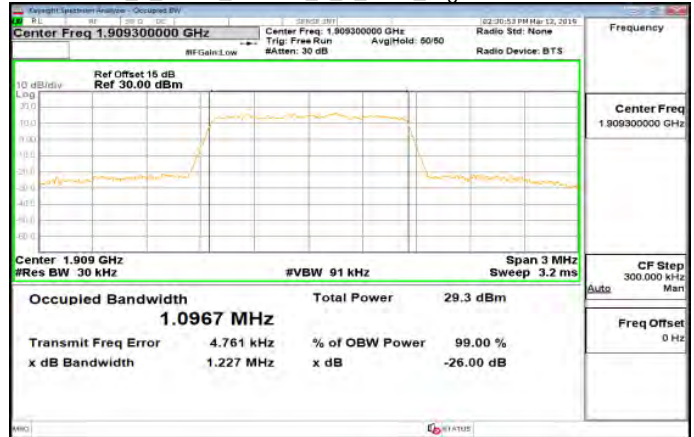

Unless otherwise stated the results shown in this test report refer only to the sample(s) tested and such sample(s) are retained for 90 days only.

除非另有說明，此報告結果僅對測試之樣品負責，同時此樣品僅保留90天。本報告未經本公司書面許可，不可部份複製。

This document is issued by the Company subject to its General Conditions of Service printed overleaf, available on request or accessible at www.sgs.com/terms_and_conditions.htm and for electronic format documents, subject to Terms and Conditions for Electronic Documents at www.sgs.com/terms_e-document.htm. Attention is drawn to the limitation of liability, indemnification and jurisdiction issues defined therein. Any holder of this document is advised that information contained hereon reflects the Company's findings at the time of its intervention only and within the limits of Client's instructions, if any. The Company's sole responsibility is to its Client and this document does not exonerate parties to a transaction from exercising all their rights and obligations under the transaction documents. This document cannot be reproduced except in full, without prior written approval of the Company. Any unauthorized alteration, forgery or falsification of the content or appearance of this document is unlawful and offenders may be prosecuted to the fullest extent of the law.

Band2_3MHz_QPSK_15_0_Main_LowCH18615-1851.5

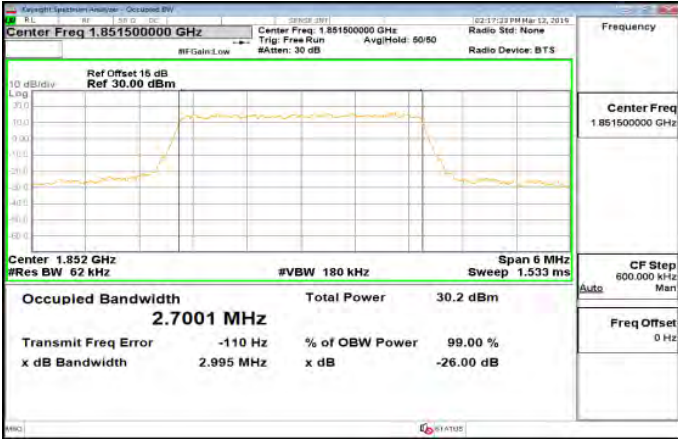

Band2_3MHz_16QAM_15_0_Main_LowCH18615-1851.5

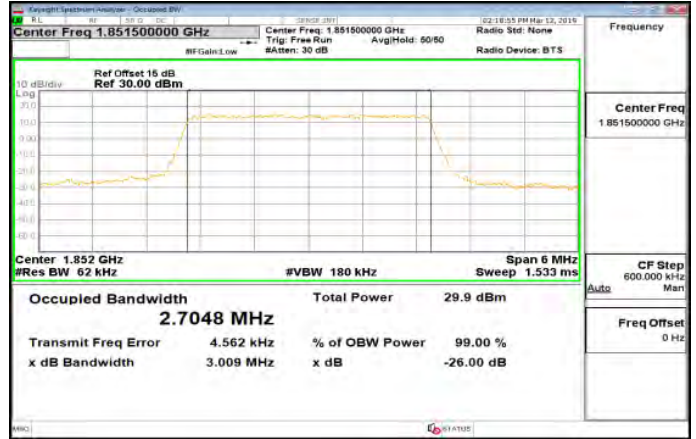

Band2_3MHz_QPSK_15_0_Main_MidCH18900-1880

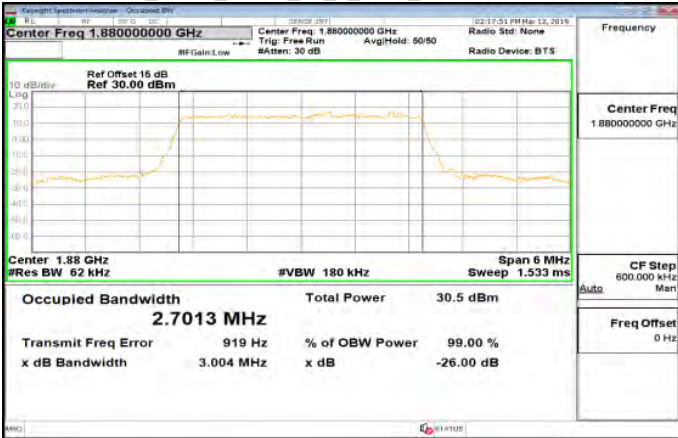

Band2_3MHz_16QAM_15_0_Main_MidCH18900-1880

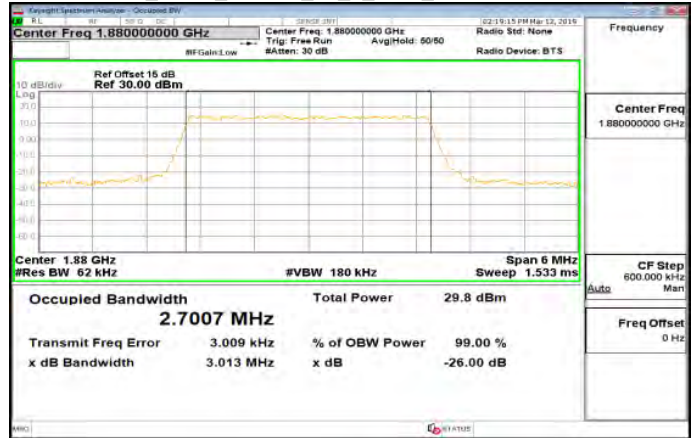

Band2_3MHz_QPSK_15_0_Main_HighCH19185-1908.5

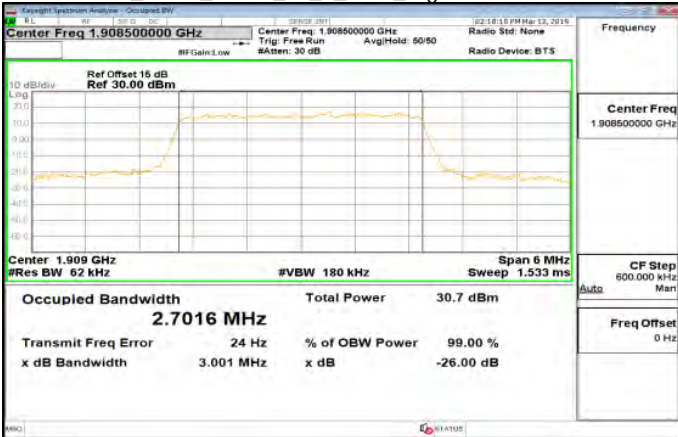

Band2_3MHz_16QAM_15_0_Main_HighCH19185-1908.5

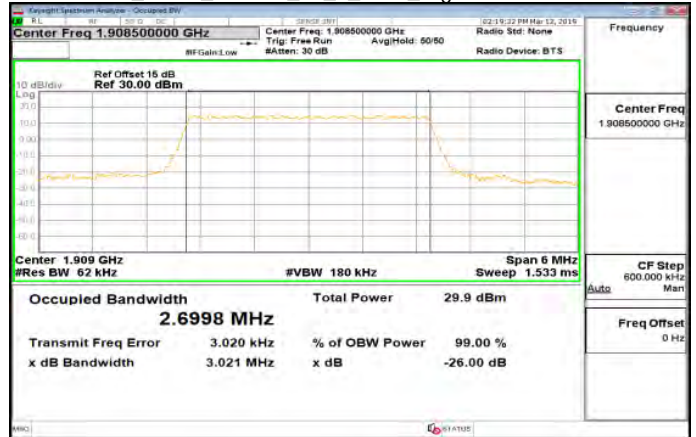

Unless otherwise stated the results shown in this test report refer only to the sample(s) tested and such sample(s) are retained for 90 days only.

除非另有說明，此報告結果僅對測試之樣品負責，同時此樣品僅保留90天。本報告未經本公司書面許可，不可部份複製。

This document is issued by the Company subject to its General Conditions of Service printed overleaf, available on request or accessible at www.sgs.com/terms_and_conditions.htm and for electronic format documents, subject to Terms and Conditions for Electronic Documents at www.sgs.com/terms_e-document.htm. Attention is drawn to the limitation of liability, indemnification and jurisdiction issues defined therein. Any holder of this document is advised that information contained hereon reflects the Company's findings at the time of its intervention only and within the limits of Client's instructions, if any. The Company's sole responsibility is to its Client and this document does not exonerate parties to a transaction from exercising all their rights and obligations under the transaction documents. This document cannot be reproduced except in full, without prior written approval of the Company. Any unauthorized alteration, forgery or falsification of the content or appearance of this document is unlawful and offenders may be prosecuted to the fullest extent of the law.

Band2_3MHz_64QAM_15_0_Main_LowCH18615-1851.5

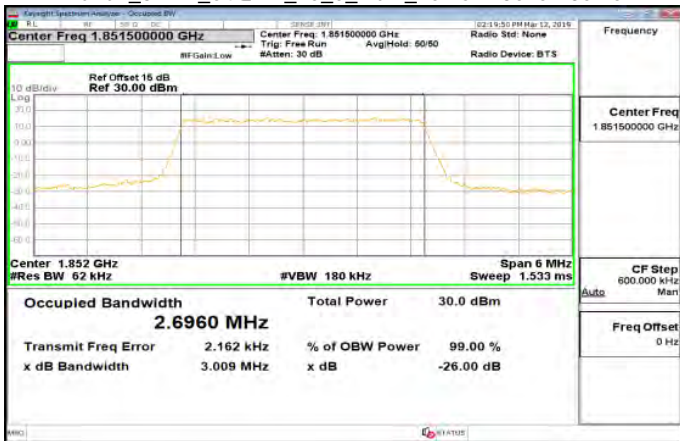

Band2_5MHz_QPSK_25_0_Main_LowCH18625-1852.5

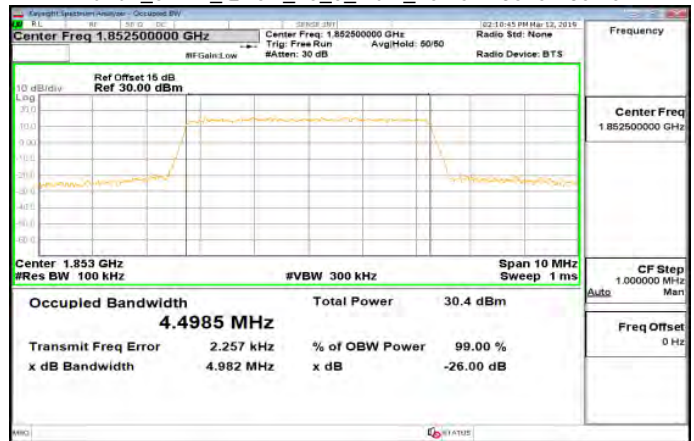

Band2_3MHz_64QAM_15_0_Main_MidCH18900-1880

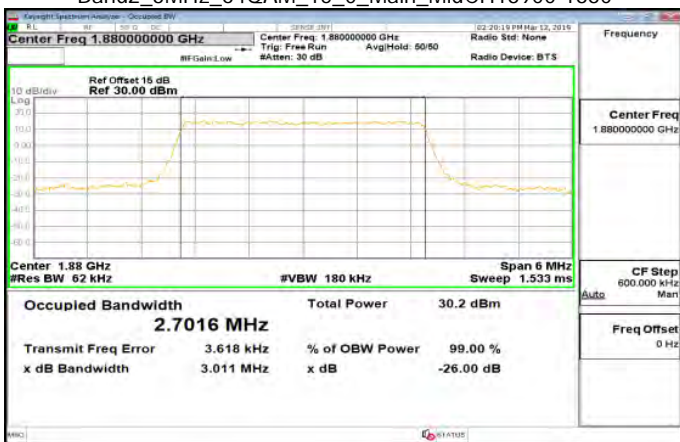

Band2_5MHz_QPSK_25_0_Main_MidCH18900-1880

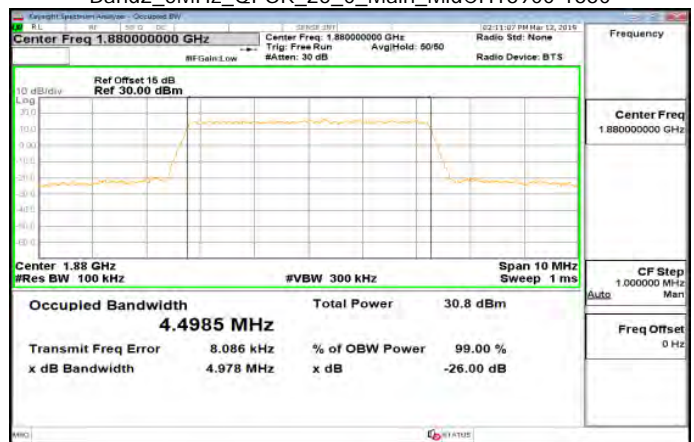

Band2_3MHz_64QAM_15_0_Main_HighCH19185-1908.5

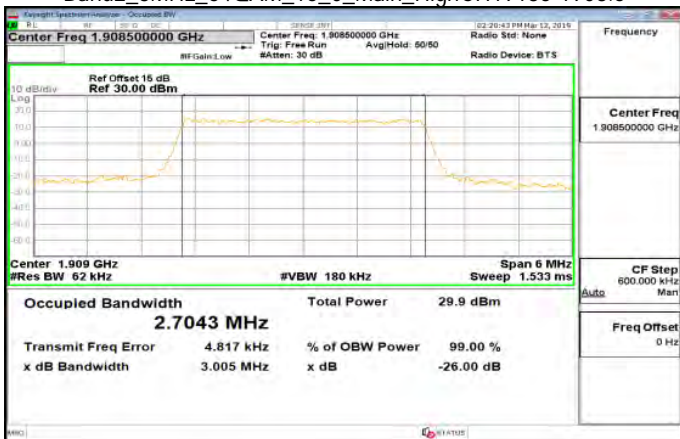

Band2_5MHz_QPSK_25_0_Main_HighCH19175-1907.5

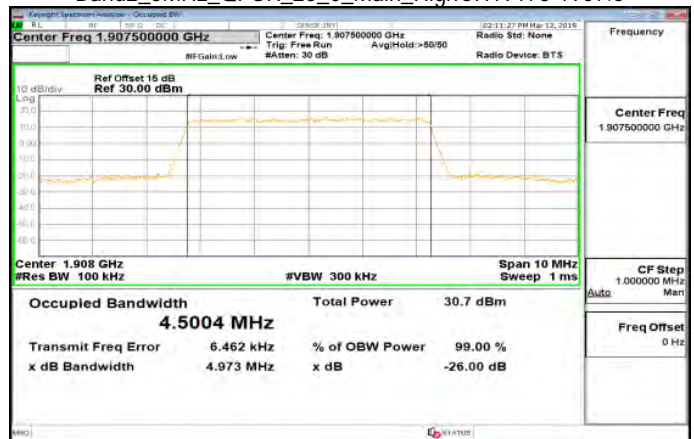

Unless otherwise stated the results shown in this test report refer only to the sample(s) tested and such sample(s) are retained for 90 days only.

除非另有說明，此報告結果僅對測試之樣品負責，同時此樣品僅保留90天。本報告未經本公司書面許可，不可部份複製。

This document is issued by the Company subject to its General Conditions of Service printed overleaf, available on request or accessible at www.sgs.com/terms_and_conditions.htm and for electronic format documents, subject to Terms and Conditions for Electronic Documents at www.sgs.com/terms_e-document.htm. Attention is drawn to the limitation of liability, indemnification and jurisdiction issues defined therein. Any holder of this document is advised that information contained hereon reflects the Company's findings at the time of its intervention only and within the limits of Client's instructions, if any. The Company's sole responsibility is to its Client and this document does not exonerate parties to a transaction from exercising all their rights and obligations under the transaction documents. This document cannot be reproduced except in full, without prior written approval of the Company. Any unauthorized alteration, forgery or falsification of the content or appearance of this document is unlawful and offenders may be prosecuted to the fullest extent of the law.

Band2_5MHz_16QAM_25_0_Main_LowCH18625-1852.5

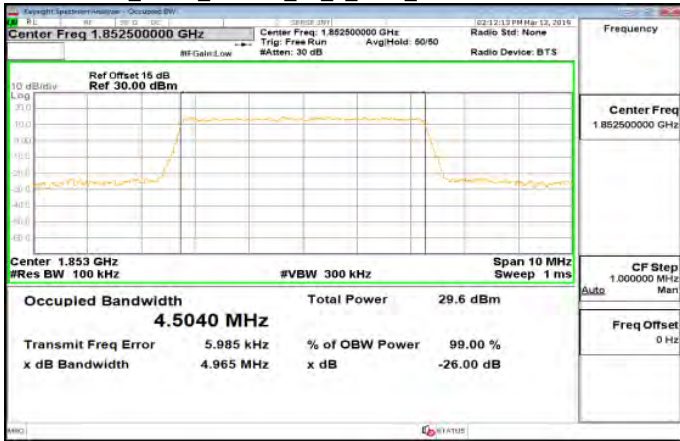

Band2_5MHz_64QAM_25_0_Main_LowCH18625-1852.5

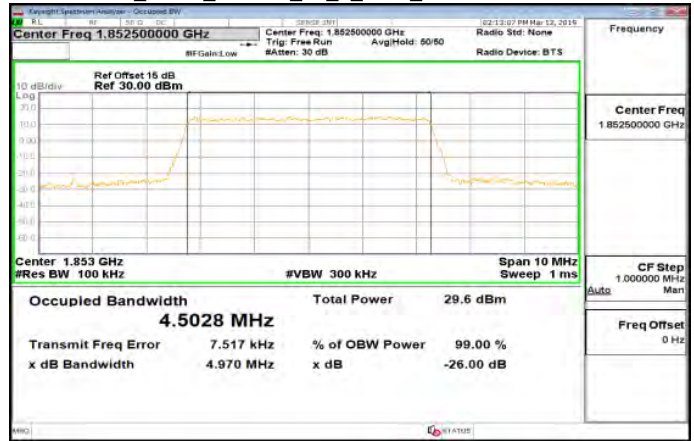

Band2_5MHz_16QAM_25_0_Main_MidCH18900-1880

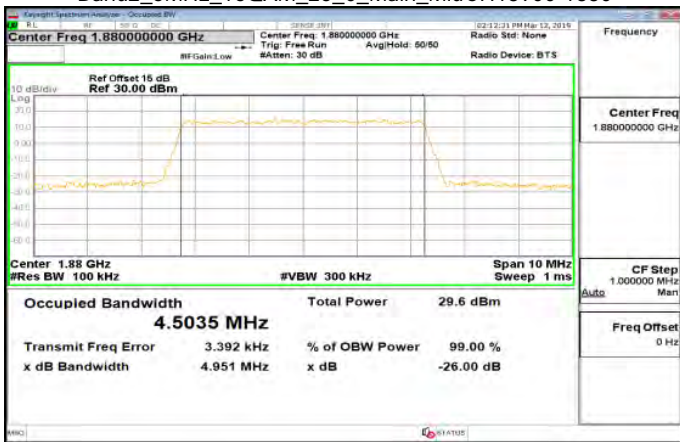

Band2_5MHz_64QAM_25_0_Main_MidCH18900-1880

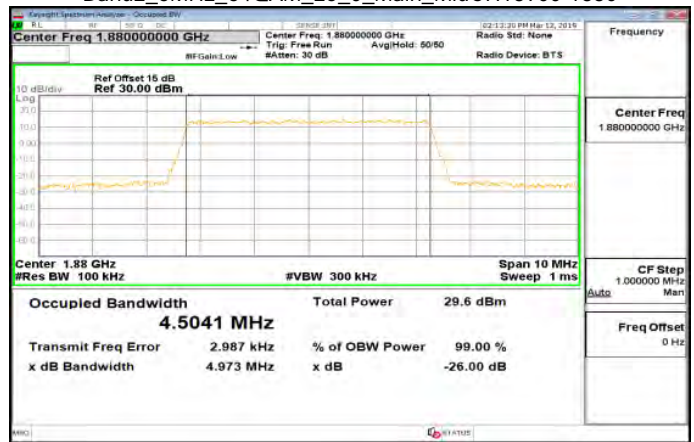

Band2_5MHz_16QAM_25_0_Main_HighCH19175-1907.5

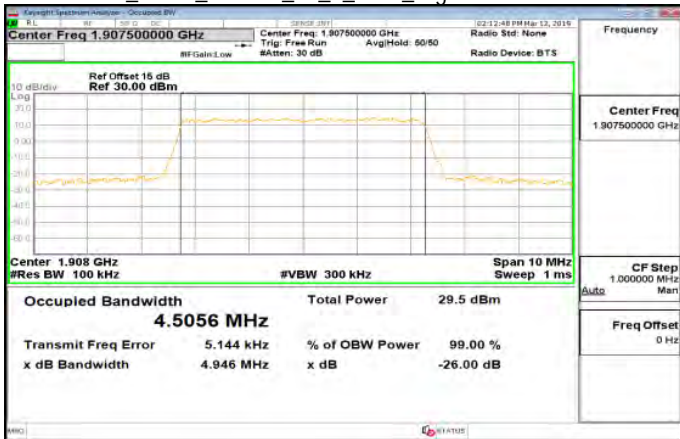

Band2_5MHz_64QAM_25_0_Main_HighCH19175-1907.5

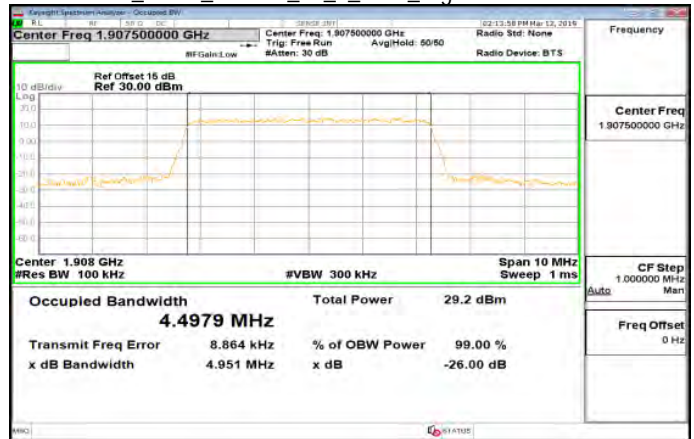

Unless otherwise stated the results shown in this test report refer only to the sample(s) tested and such sample(s) are retained for 90 days only.

除非另有說明，此報告結果僅對測試之樣品負責，同時此樣品僅保留90天。本報告未經本公司書面許可，不可部份複製。

This document is issued by the Company subject to its General Conditions of Service printed overleaf, available on request or accessible at www.sgs.com/terms_and_conditions.htm and for electronic format documents, subject to Terms and Conditions for Electronic Documents at www.sgs.com/terms_e-document.htm. Attention is drawn to the limitation of liability, indemnification and jurisdiction issues defined therein. Any holder of this document is advised that information contained hereon reflects the Company's findings at the time of its intervention only and within the limits of Client's instructions, if any. The Company's sole responsibility is to its Client and this document does not exonerate parties to a transaction from exercising all their rights and obligations under the transaction documents. This document cannot be reproduced except in full, without prior written approval of the Company. Any unauthorized alteration, forgery or falsification of the content or appearance of this document is unlawful and offenders may be prosecuted to the fullest extent of the law.

Band2_10MHz_QPSK_50_0_Main_LowCH18650-1855

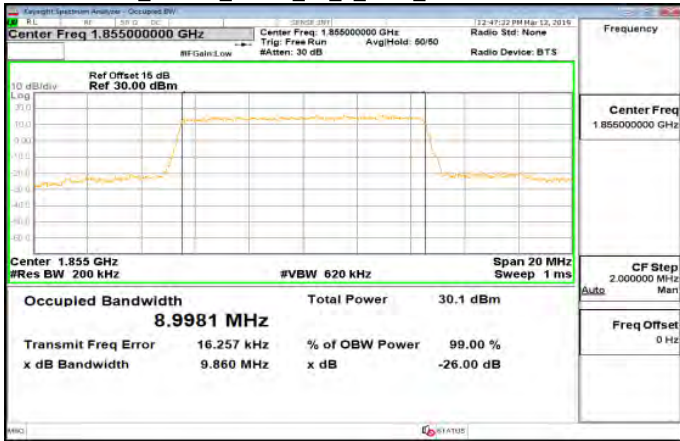

Band2_10MHz_16QAM_50_0_Main_LowCH18650-1855

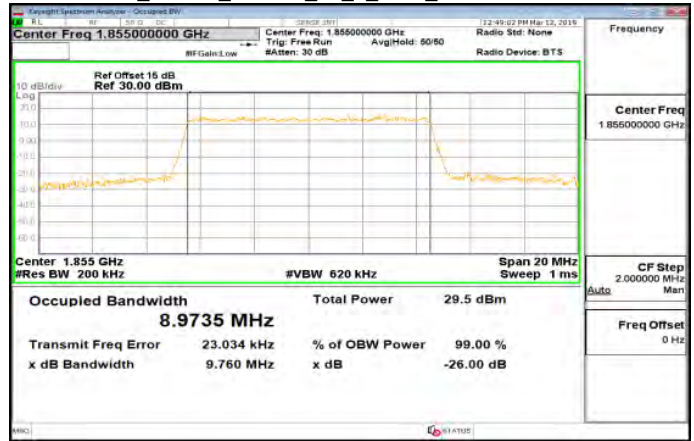

Band2_10MHz_QPSK_50_0_Main_MidCH18900-1880

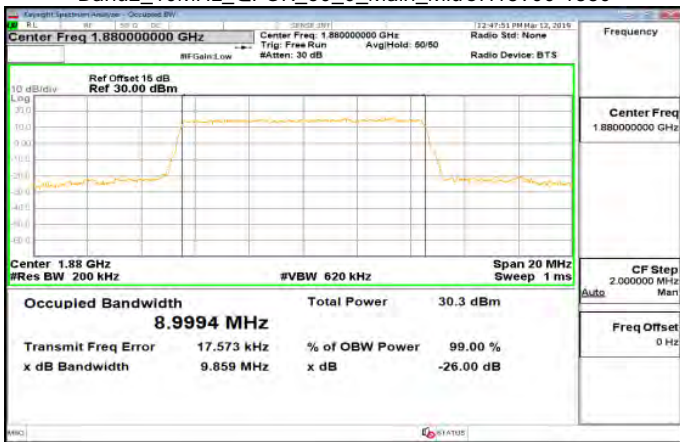

Band2_10MHz_16QAM_50_0_Main_MidCH18900-1880

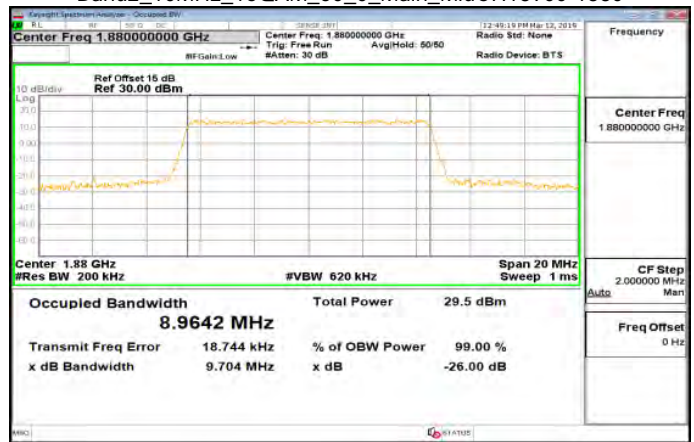

Band2_10MHz_QPSK_50_0_Main_HighCH19150-1905

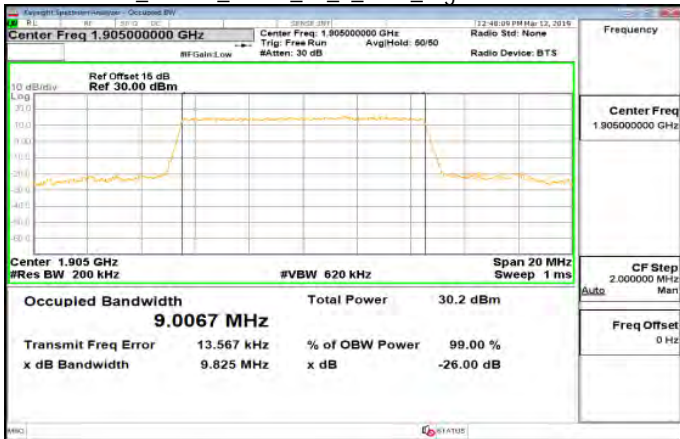

Band2_10MHz_16QAM_50_0_Main_HighCH19150-1905

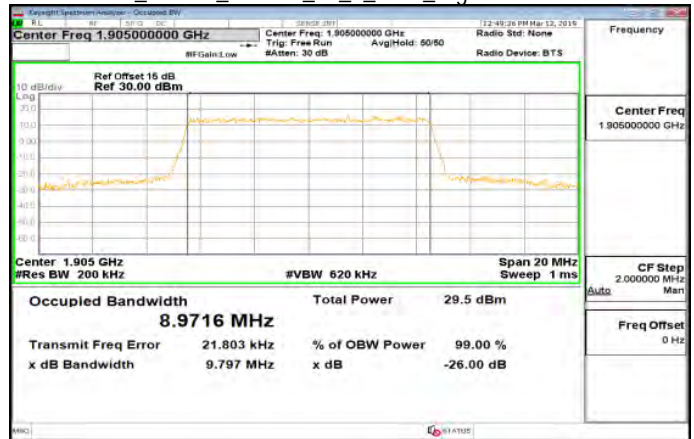

Unless otherwise stated the results shown in this test report refer only to the sample(s) tested and such sample(s) are retained for 90 days only.

除非另有說明，此報告結果僅對測試之樣品負責，同時此樣品僅保留90天。本報告未經本公司書面許可，不可部份複製。

This document is issued by the Company subject to its General Conditions of Service printed overleaf, available on request or accessible at www.sgs.com/terms_and_conditions.htm and for electronic format documents, subject to Terms and Conditions for Electronic Documents at www.sgs.com/terms_e-document.htm. Attention is drawn to the limitation of liability, indemnification and jurisdiction issues defined therein. Any holder of this document is advised that information contained hereon reflects the Company's findings at the time of its intervention only and within the limits of Client's instructions, if any. The Company's sole responsibility is to its Client and this document does not exonerate parties to a transaction from exercising all their rights and obligations under the transaction documents. This document cannot be reproduced except in full, without prior written approval of the Company. Any unauthorized alteration, forgery or falsification of the content or appearance of this document is unlawful and offenders may be prosecuted to the fullest extent of the law.

Band2_10MHz_64QAM_50_0_Main_LowCH18650-1855

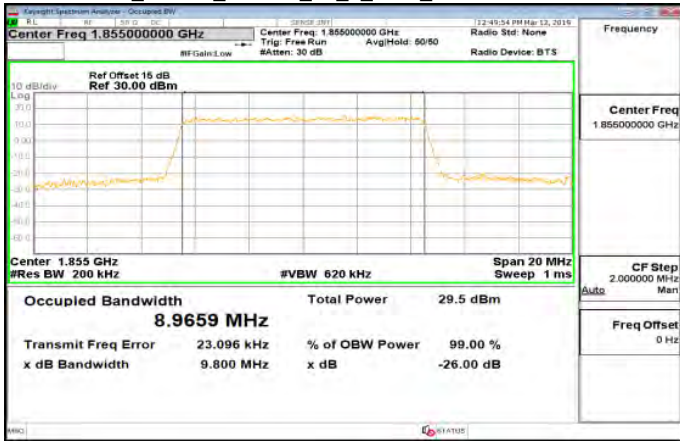

Band2_15MHz_QPSK_75_0_Main_LowCH18675-1857.5

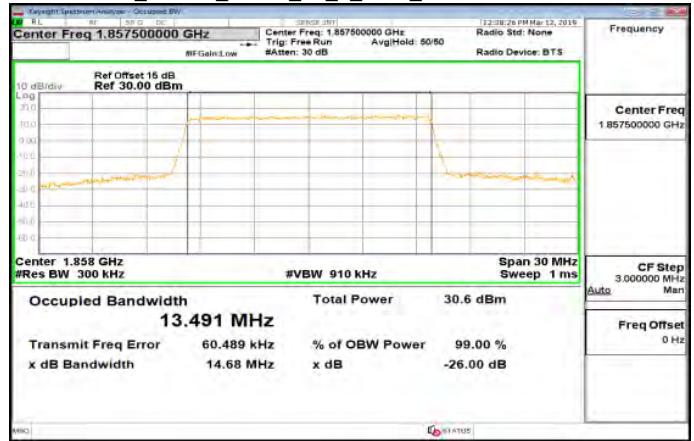

Band2_10MHz_64QAM_50_0_Main_MidCH18900-1880

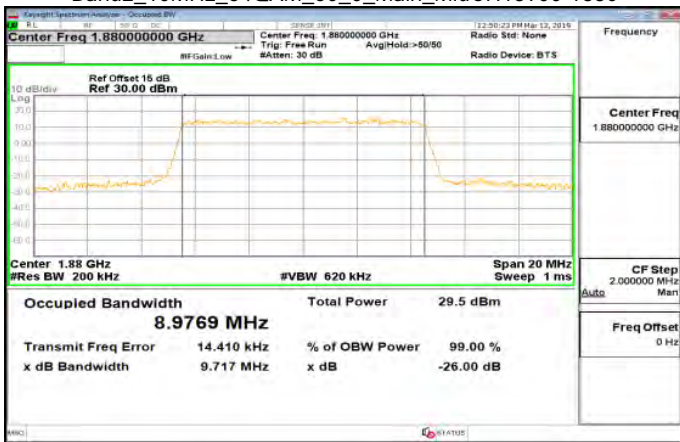

Band2_15MHz_QPSK_75_0_Main_MidCH18900-1880

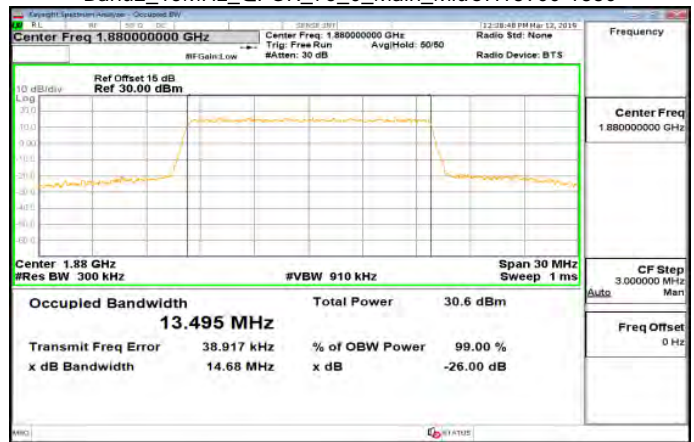

Band2_10MHz_64QAM_50_0_Main_HighCH19150-1905

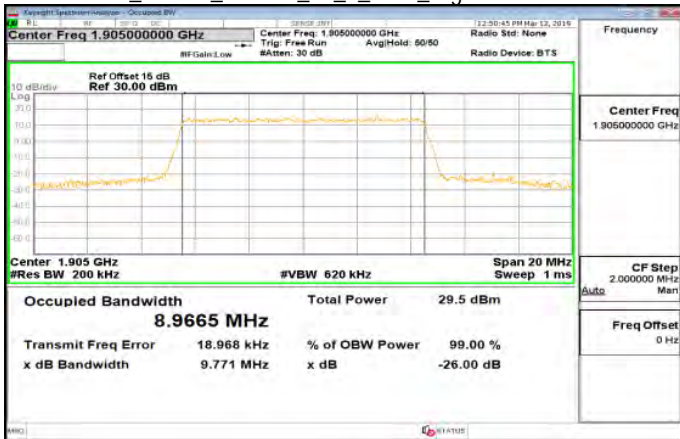

Band2_15MHz_QPSK_75_0_Main_HighCH19125-1902.5

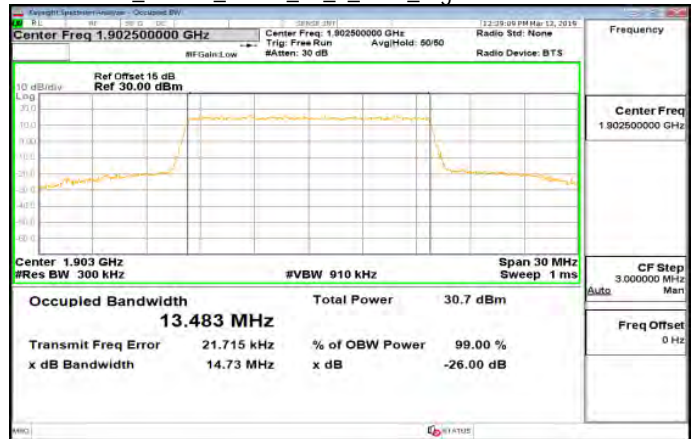

Unless otherwise stated the results shown in this test report refer only to the sample(s) tested and such sample(s) are retained for 90 days only.

除非另有說明，此報告結果僅對測試之樣品負責，同時此樣品僅保留90天。本報告未經本公司書面許可，不可部份複製。

This document is issued by the Company subject to its General Conditions of Service printed overleaf, available on request or accessible at www.sgs.com/terms_and_conditions.htm and for electronic format documents, subject to Terms and Conditions for Electronic Documents at www.sgs.com/terms_e-document.htm. Attention is drawn to the limitation of liability, indemnification and jurisdiction issues defined therein. Any holder of this document is advised that information contained hereon reflects the Company's findings at the time of its intervention only and within the limits of Client's instructions, if any. The Company's sole responsibility is to its Client and this document does not exonerate parties to a transaction from exercising all their rights and obligations under the transaction documents. This document cannot be reproduced except in full, without prior written approval of the Company. Any unauthorized alteration, forgery or falsification of the content or appearance of this document is unlawful and offenders may be prosecuted to the fullest extent of the law.

Band2_15MHz_16QAM_75_0_Main_LowCH18675-1857.5

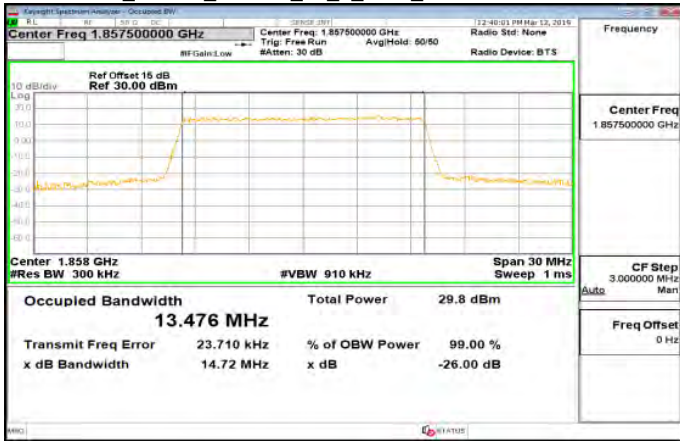

Band2_15MHz_64QAM_75_0_Main_LowCH18675-1857.5

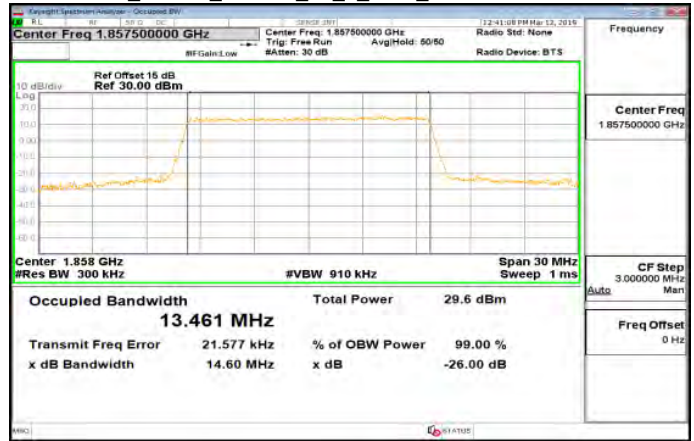

Band2_15MHz_16QAM_75_0_Main_MidCH18900-1880

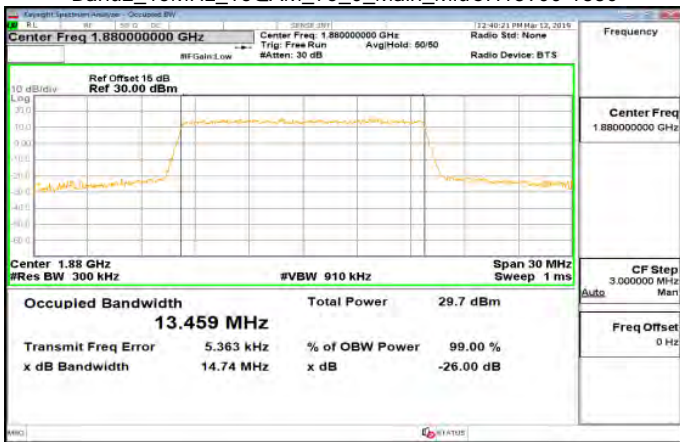

Band2_15MHz_64QAM_75_0_Main_MidCH18900-1880

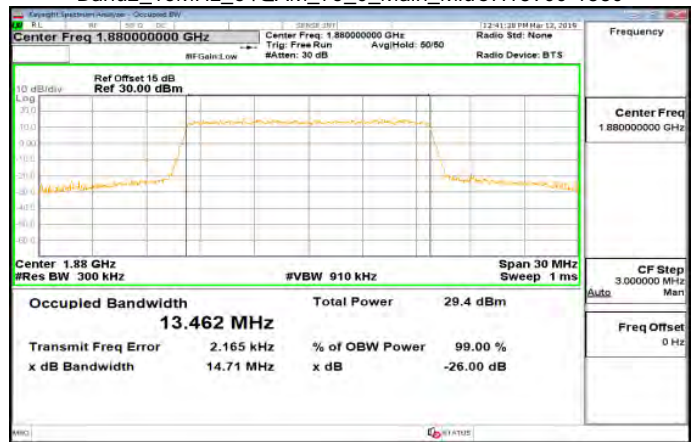

Band2_15MHz_16QAM_75_0_Main_HighCH19125-1902.5

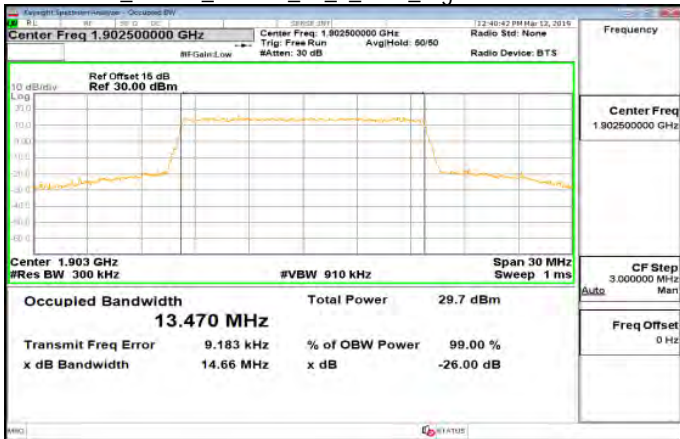

Band2_15MHz_64QAM_75_0_Main_HighCH19125-1902.5

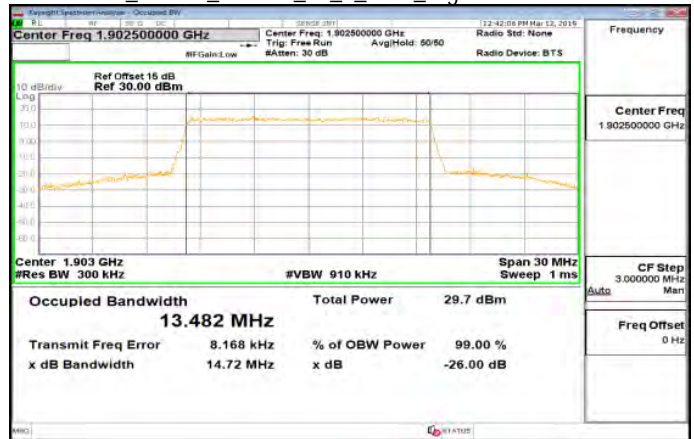

Unless otherwise stated the results shown in this test report refer only to the sample(s) tested and such sample(s) are retained for 90 days only.

除非另有說明，此報告結果僅對測試之樣品負責，同時此樣品僅保留90天。本報告未經本公司書面許可，不可部份複製。

This document is issued by the Company subject to its General Conditions of Service printed overleaf, available on request or accessible at www.sgs.com/terms_and_conditions.htm and for electronic format documents, subject to Terms and Conditions for Electronic Documents at www.sgs.com/terms_e-document.htm. Attention is drawn to the limitation of liability, indemnification and jurisdiction issues defined therein. Any holder of this document is advised that information contained hereon reflects the Company's findings at the time of its intervention only and within the limits of Client's instructions, if any. The Company's sole responsibility is to its Client and this document does not exonerate parties to a transaction from exercising all their rights and obligations under the transaction documents. This document cannot be reproduced except in full, without prior written approval of the Company. Any unauthorized alteration, forgery or falsification of the content or appearance of this document is unlawful and offenders may be prosecuted to the fullest extent of the law.

Band2_20MHz_QPSK_100_0_Main_LowCH18700-1860

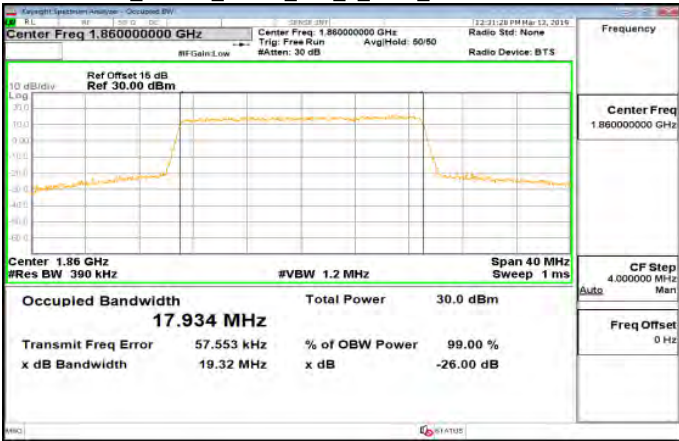

Band2_20MHz_16QAM_100_0_Main_LowCH18700-1860

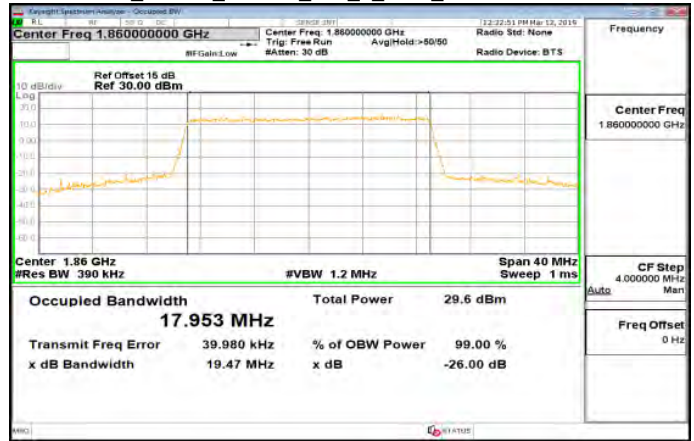

Band2_20MHz_QPSK_100_0_Main_MidCH18900-1880

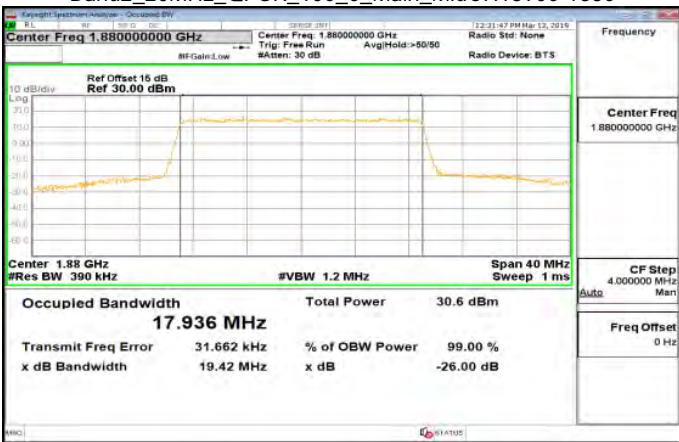

Band2_20MHz_16QAM_100_0_Main_MidCH18900-1880

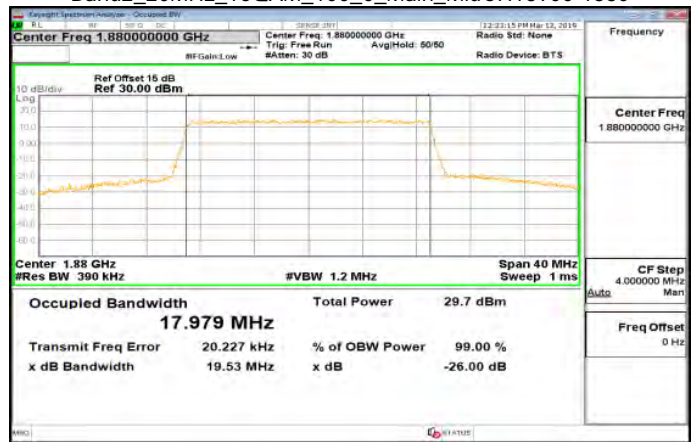

Band2_20MHz_QPSK_100_0_Main_HighCH19100-1900

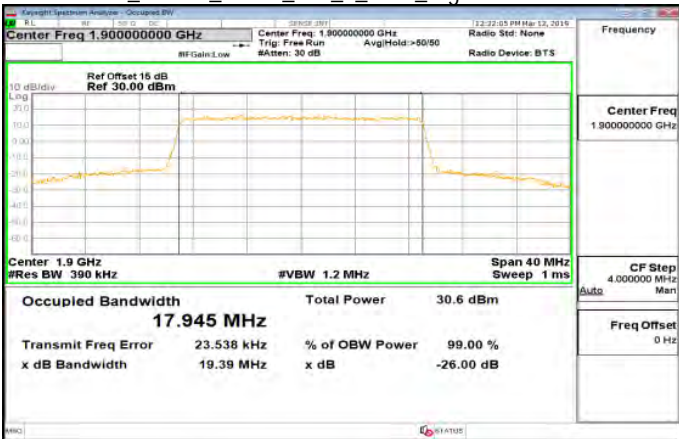

Band2_20MHz_16QAM_100_0_Main_HighCH19100-1900

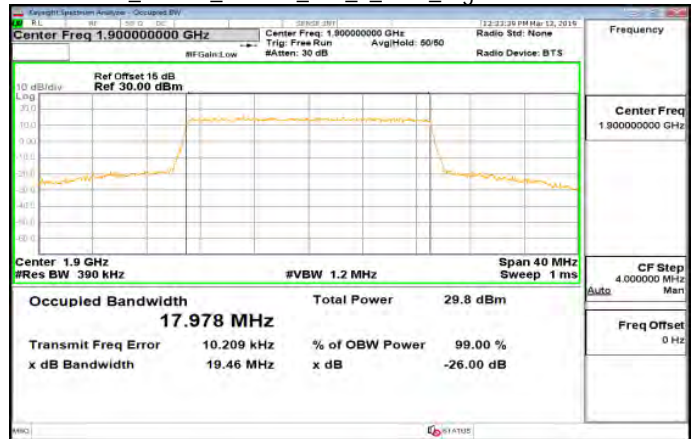

Unless otherwise stated the results shown in this test report refer only to the sample(s) tested and such sample(s) are retained for 90 days only.

除非另有說明，此報告結果僅對測試之樣品負責，同時此樣品僅保留90天。本報告未經本公司書面許可，不可部份複製。

This document is issued by the Company subject to its General Conditions of Service printed overleaf, available on request or accessible at www.sgs.com/terms_and_conditions.htm and for electronic format documents, subject to Terms and Conditions for Electronic Documents at www.sgs.com/terms_e-document.htm. Attention is drawn to the limitation of liability, indemnification and jurisdiction issues defined therein. Any holder of this document is advised that information contained hereon reflects the Company's findings at the time of its intervention only and within the limits of Client's instructions, if any. The Company's sole responsibility is to its Client and this document does not exonerate parties to a transaction from exercising all their rights and obligations under the transaction documents. This document cannot be reproduced except in full, without prior written approval of the Company. Any unauthorized alteration, forgery or falsification of the content or appearance of this document is unlawful and offenders may be prosecuted to the fullest extent of the law.

Band2_20MHz_64QAM_100_0_Main_LowCH18700-1860

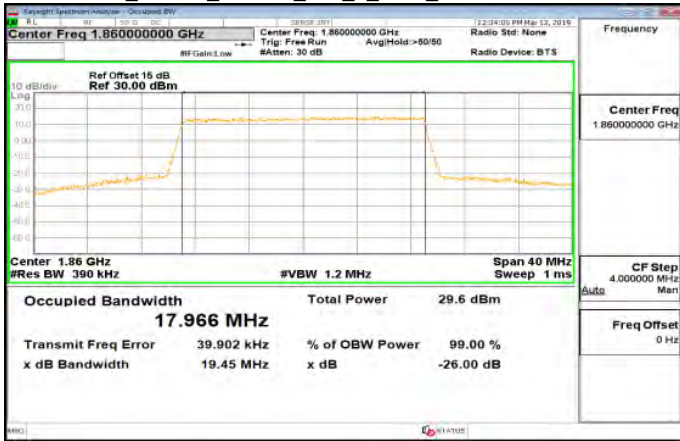

Band4_1_4MHz_QPSK_6_0_Main_LowCH19957-1710.7

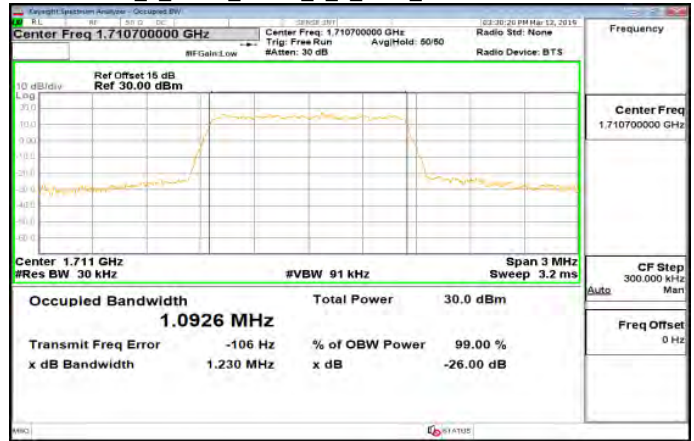

Band2_20MHz_64QAM_100_0_Main_MidCH18900-1880

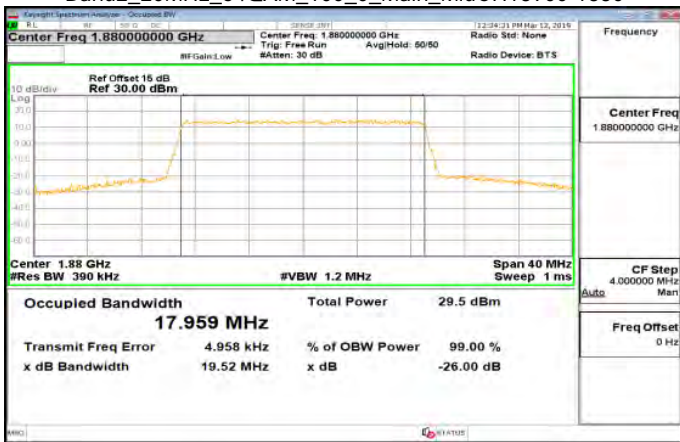

Band4_1_4MHz_QPSK_6_0_Main_MidCH20175-1732.5

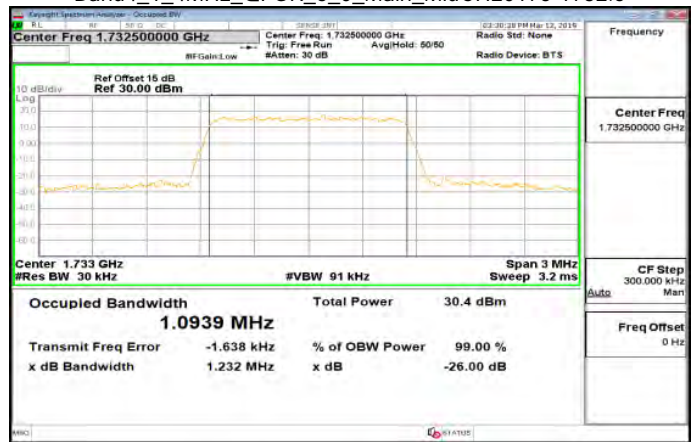

Band2_20MHz_64QAM_100_0_Main_HighCH19100-1900

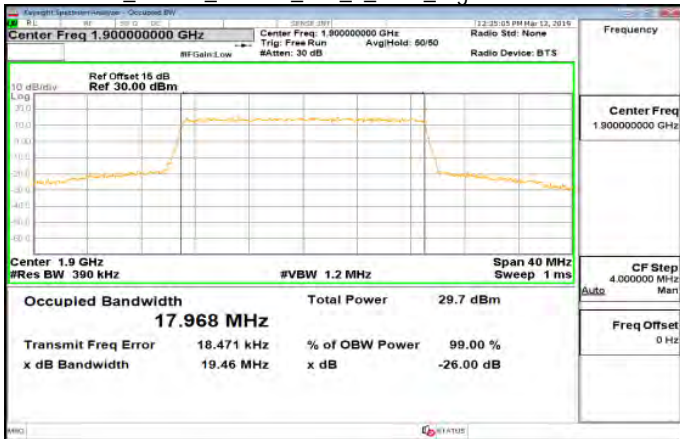

Band4_1_4MHz_QPSK_6_0_Main_HighCH20393-1754.3

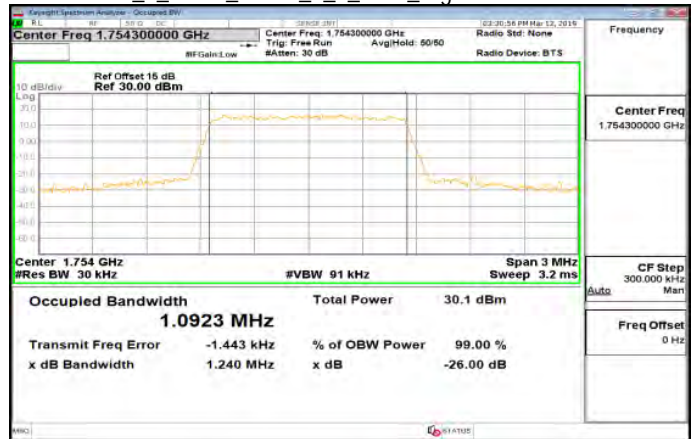

Unless otherwise stated the results shown in this test report refer only to the sample(s) tested and such sample(s) are retained for 90 days only.

除非另有說明，此報告結果僅對測試之樣品負責，同時此樣品僅保留90天。本報告未經本公司書面許可，不可部份複製。

This document is issued by the Company subject to its General Conditions of Service printed overleaf, available on request or accessible at www.sgs.com/terms_and_conditions.htm and for electronic format documents, subject to Terms and Conditions for Electronic Documents at www.sgs.com/terms_e-document.htm. Attention is drawn to the limitation of liability, indemnification and jurisdiction issues defined therein. Any holder of this document is advised that information contained hereon reflects the Company's findings at the time of its intervention only and within the limits of Client's instructions, if any. The Company's sole responsibility is to its Client and this document does not exonerate parties to a transaction from exercising all their rights and obligations under the transaction documents. This document cannot be reproduced except in full, without prior written approval of the Company. Any unauthorized alteration, forgery or falsification of the content or appearance of this document is unlawful and offenders may be prosecuted to the fullest extent of the law.

Band4_1_4MHz_16QAM_6_0_Main_LowCH19957-1710.7

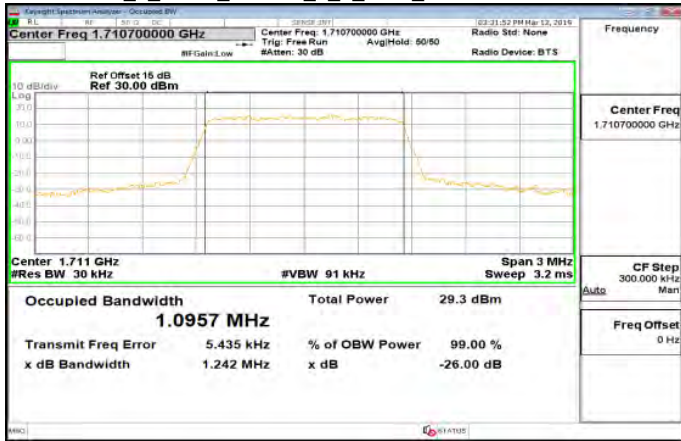

Band4_1_4MHz_64QAM_6_0_Main_LowCH19957-1710.7

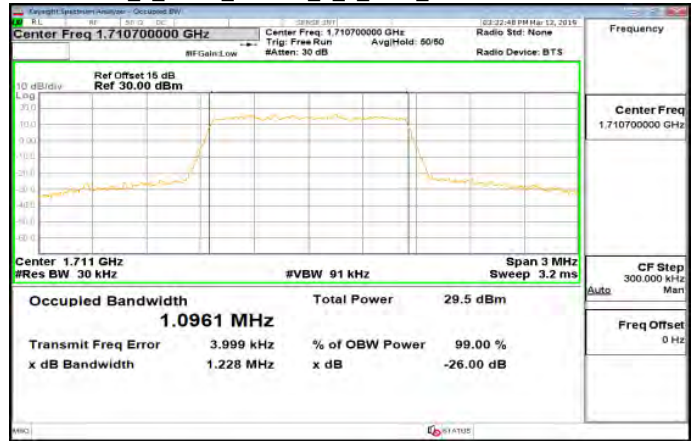

Band4_1_4MHz_16QAM_6_0_Main_MidCH20175-1732.5

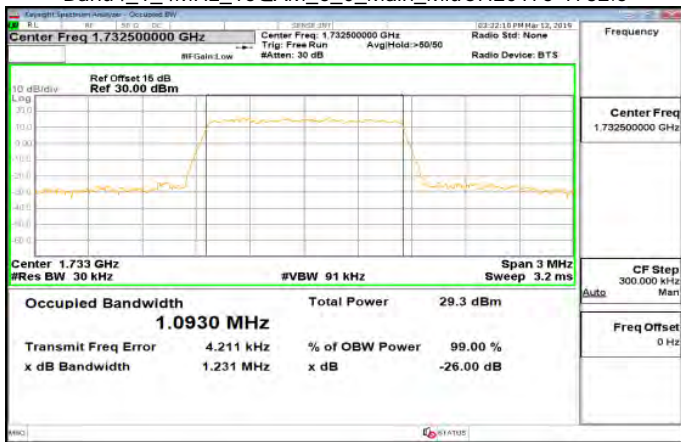

Band4_1_4MHz_64QAM_6_0_Main_MidCH20175-1732.5

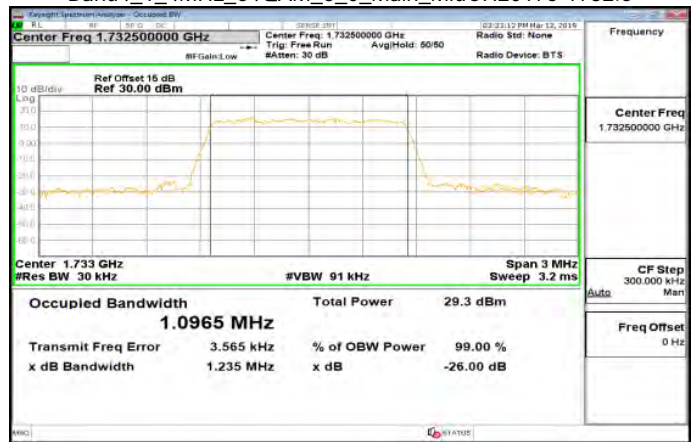

Band4_1_4MHz_16QAM_6_0_Main_HighCH20393-1754.3

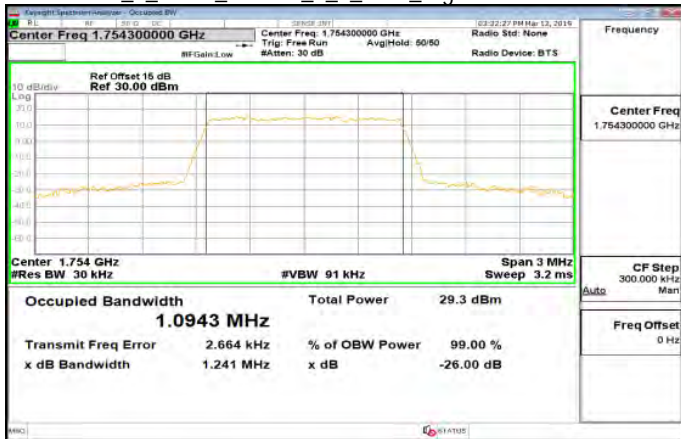

Band4_1_4MHz_64QAM_6_0_Main_HighCH20393-1754.3

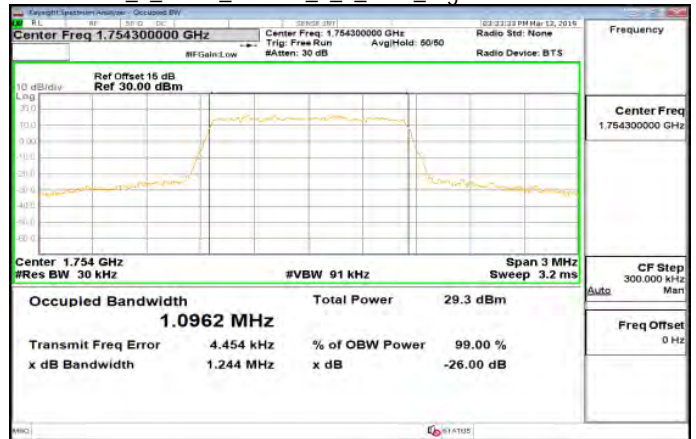

Unless otherwise stated the results shown in this test report refer only to the sample(s) tested and such sample(s) are retained for 90 days only.

除非另有說明，此報告結果僅對測試之樣品負責，同時此樣品僅保留90天。本報告未經本公司書面許可，不可部份複製。

This document is issued by the Company subject to its General Conditions of Service printed overleaf, available on request or accessible at www.sgs.com/terms_and_conditions.htm and for electronic format documents, subject to Terms and Conditions for Electronic Documents at www.sgs.com/terms_e-document.htm. Attention is drawn to the limitation of liability, indemnification and jurisdiction issues defined therein. Any holder of this document is advised that information contained hereon reflects the Company's findings at the time of its intervention only and within the limits of Client's instructions, if any. The Company's sole responsibility is to its Client and this document does not exonerate parties to a transaction from exercising all their rights and obligations under the transaction documents. This document cannot be reproduced except in full, without prior written approval of the Company. Any unauthorized alteration, forgery or falsification of the content or appearance of this document is unlawful and offenders may be prosecuted to the fullest extent of the law.

Band4_3MHz_QPSK_15_0_Main_LowCH19965-1711.5

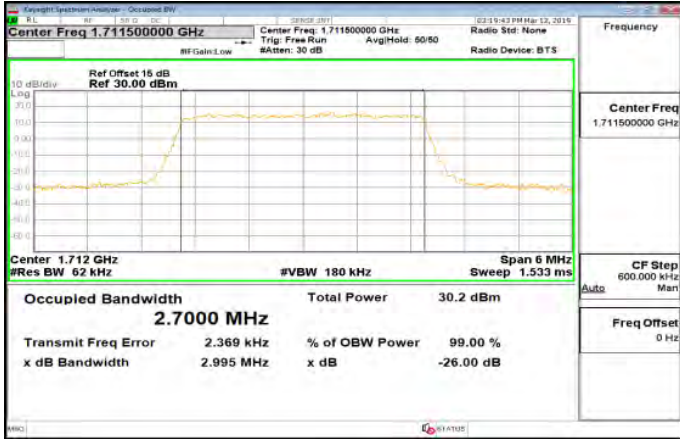

Band4_3MHz_16QAM_15_0_Main_LowCH19965-1711.5

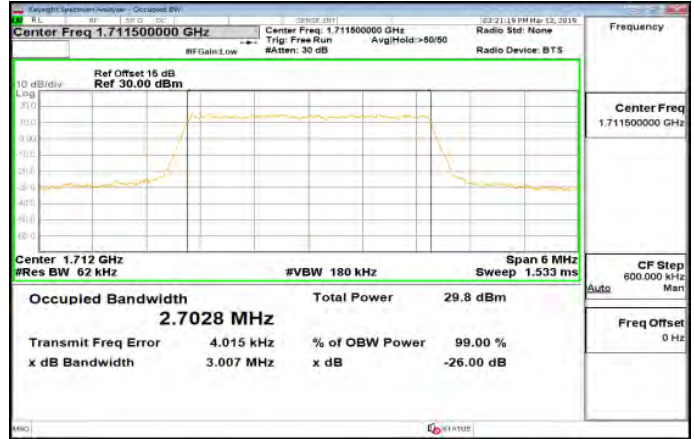

Band4_3MHz_QPSK_15_0_Main_MidCH20175-1732.5

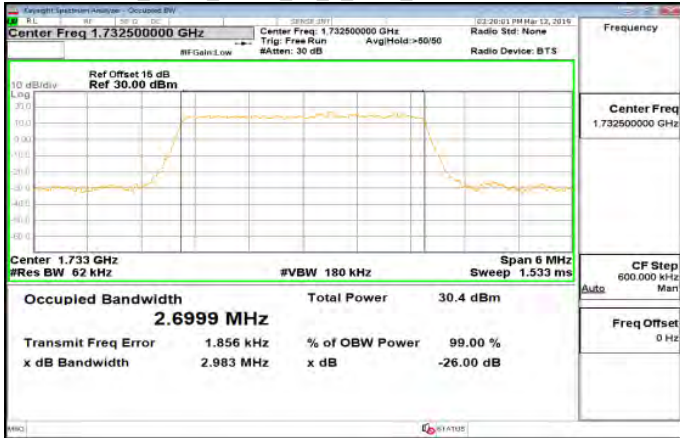

Band4_3MHz_16QAM_15_0_Main_MidCH20175-1732.5

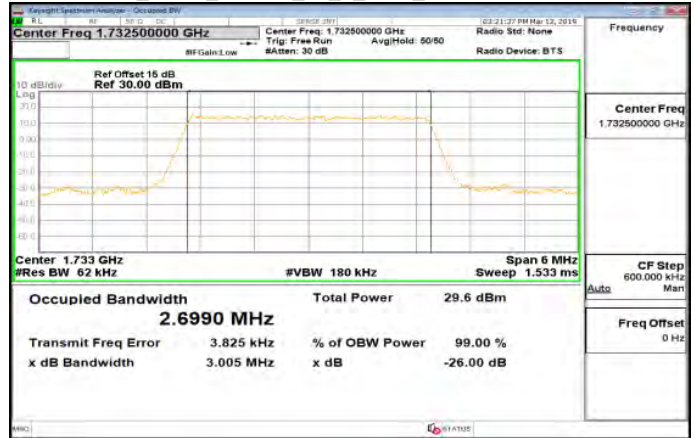

Band4_3MHz_QPSK_15_0_Main_HighCH20385-1753.5

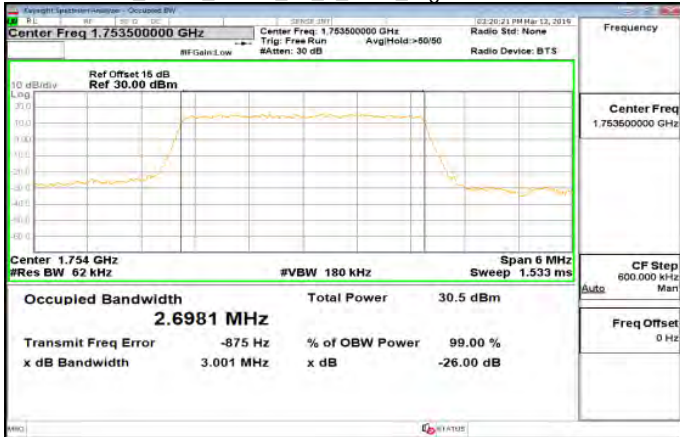

Band4_3MHz_16QAM_15_0_Main_HighCH20385-1753.5

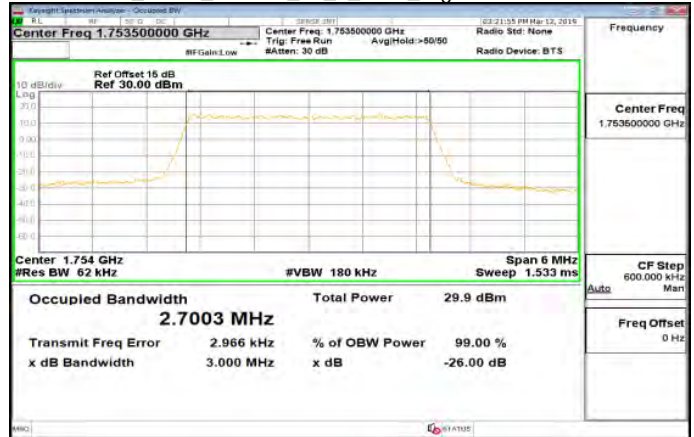

Unless otherwise stated the results shown in this test report refer only to the sample(s) tested and such sample(s) are retained for 90 days only.

除非另有說明，此報告結果僅對測試之樣品負責，同時此樣品僅保留90天。本報告未經本公司書面許可，不可部份複製。

This document is issued by the Company subject to its General Conditions of Service printed overleaf, available on request or accessible at www.sgs.com/terms_and_conditions.htm and for electronic format documents, subject to Terms and Conditions for Electronic Documents at www.sgs.com/terms_e-document.htm. Attention is drawn to the limitation of liability, indemnification and jurisdiction issues defined therein. Any holder of this document is advised that information contained hereon reflects the Company's findings at the time of its intervention only and within the limits of Client's instructions, if any. The Company's sole responsibility is to its Client and this document does not exonerate parties to a transaction from exercising all their rights and obligations under the transaction documents. This document cannot be reproduced except in full, without prior written approval of the Company. Any unauthorized alteration, forgery or falsification of the content or appearance of this document is unlawful and offenders may be prosecuted to the fullest extent of the law.

Band4_3MHz_64QAM_15_0_Main_LowCH19965-1711.5

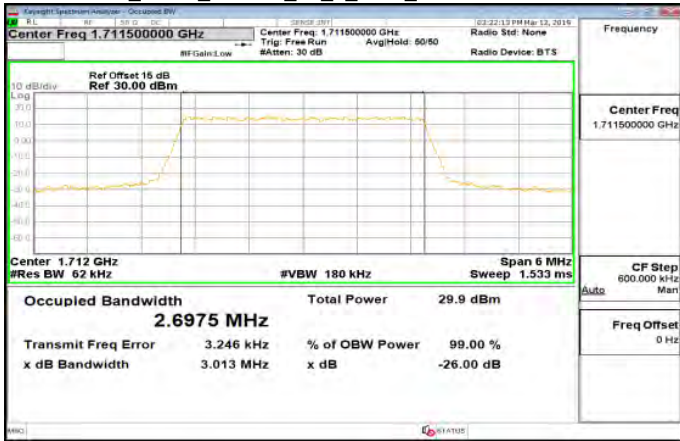

Band4_5MHz_QPSK_25_0_Main_LowCH19975-1712.5

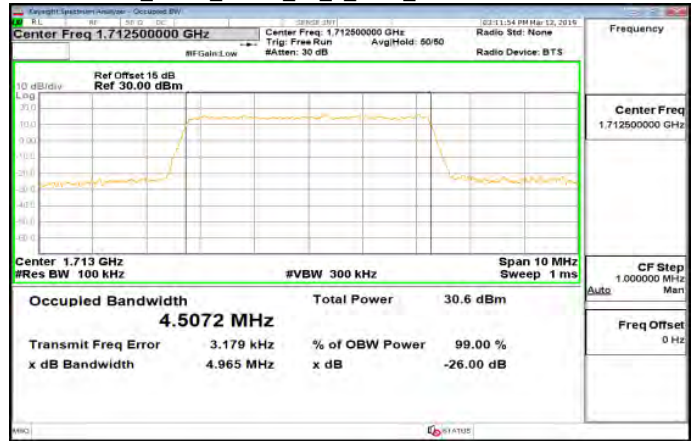

Band4_3MHz_64QAM_15_0_Main_MidCH20175-1732.5

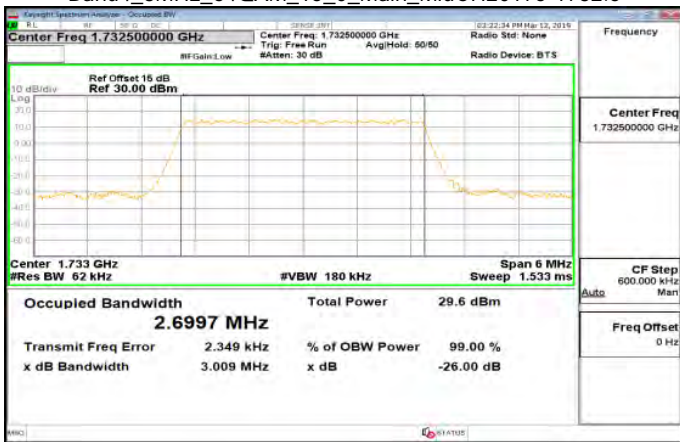

Band4_5MHz_QPSK_25_0_Main_MidCH20175-1732.5

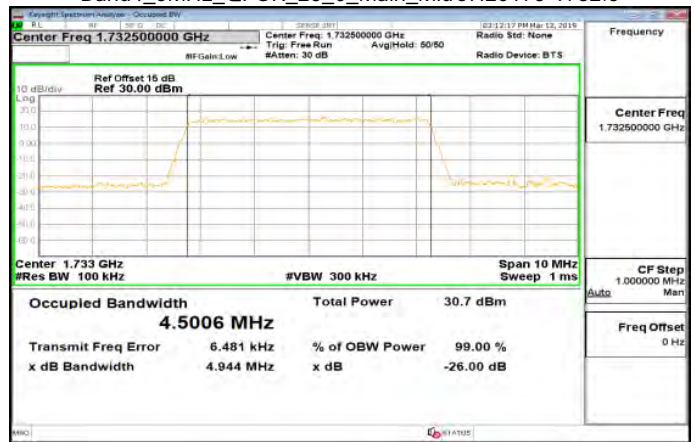

Band4_3MHz_64QAM_15_0_Main_HighCH20385-1753.5

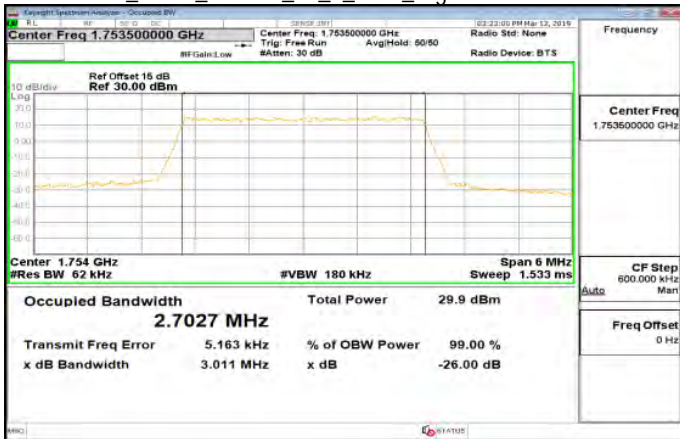

Band4_5MHz_QPSK_25_0_Main_HighCH20375-1752.5

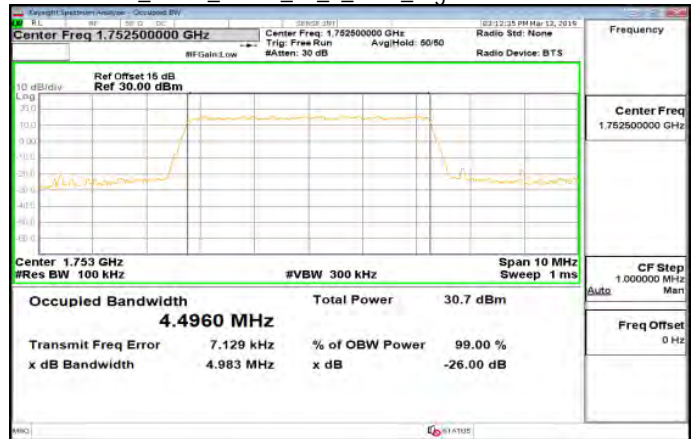

Unless otherwise stated the results shown in this test report refer only to the sample(s) tested and such sample(s) are retained for 90 days only.

除非另有說明，此報告結果僅對測試之樣品負責，同時此樣品僅保留90天。本報告未經本公司書面許可，不可部份複製。

This document is issued by the Company subject to its General Conditions of Service printed overleaf, available on request or accessible at www.sgs.com/terms_and_conditions.htm and for electronic format documents, subject to Terms and Conditions for Electronic Documents at www.sgs.com/terms_e-document.htm. Attention is drawn to the limitation of liability, indemnification and jurisdiction issues defined therein. Any holder of this document is advised that information contained hereon reflects the Company's findings at the time of its intervention only and within the limits of Client's instructions, if any. The Company's sole responsibility is to its Client and this document does not exonerate parties to a transaction from exercising all their rights and obligations under the transaction documents. This document cannot be reproduced except in full, without prior written approval of the Company. Any unauthorized alteration, forgery or falsification of the content or appearance of this document is unlawful and offenders may be prosecuted to the fullest extent of the law.

Band4_10MHz_QPSK_50_0_Main_LowCH20000-1715

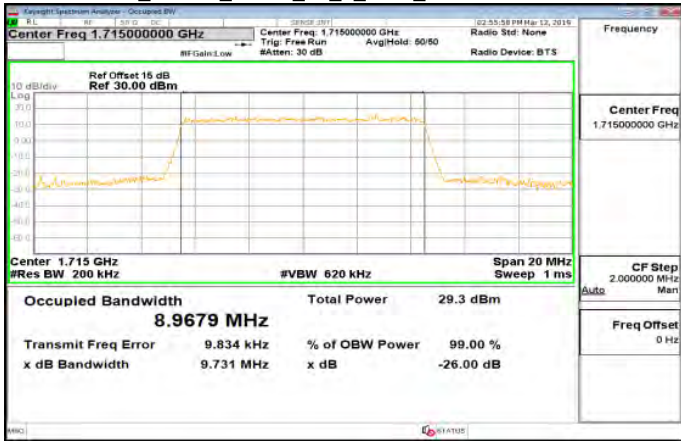

Band4_10MHz_16QAM_50_0_Main_LowCH20000-1715

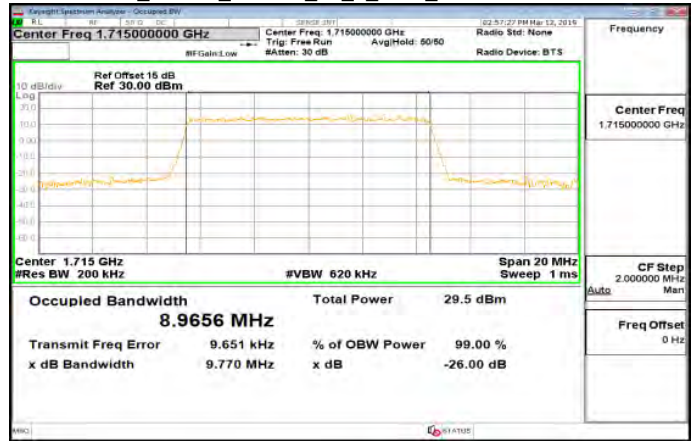

Band4_10MHz_QPSK_50_0_Main_MidCH20175-1732.5

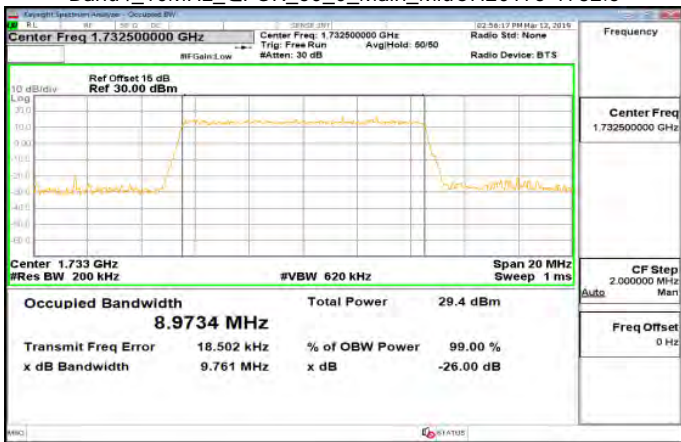

Band4_10MHz_16QAM_50_0_Main_MidCH20175-1732.5

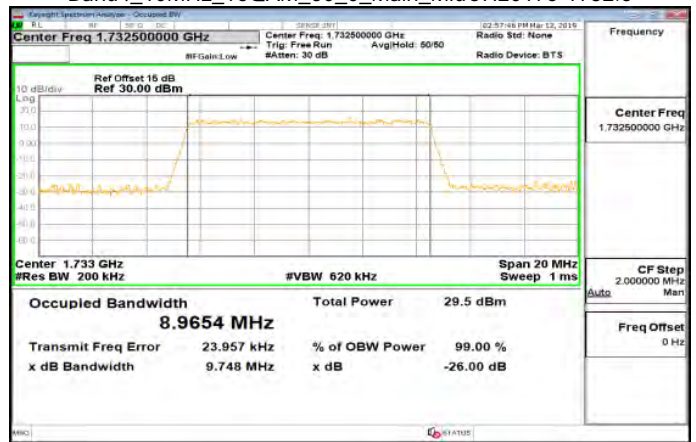

Band4_10MHz_QPSK_50_0_Main_HighCH20350-1750

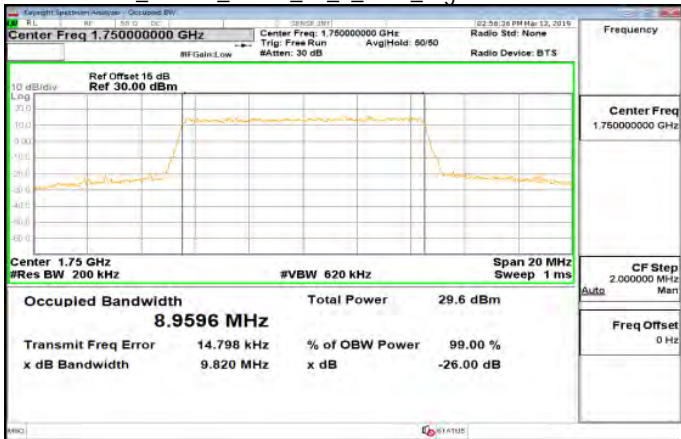

Band4_10MHz_16QAM_50_0_Main_HighCH20350-1750

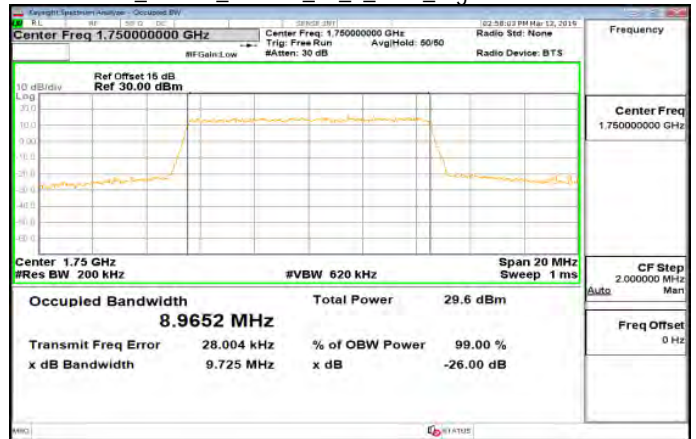

Unless otherwise stated the results shown in this test report refer only to the sample(s) tested and such sample(s) are retained for 90 days only.

除非另有說明，此報告結果僅對測試之樣品負責，同時此樣品僅保留90天。本報告未經本公司書面許可，不可部份複製。

This document is issued by the Company subject to its General Conditions of Service printed overleaf, available on request or accessible at www.sgs.com/terms_and_conditions.htm and for electronic format documents, subject to Terms and Conditions for Electronic Documents at www.sgs.com/terms_e-document.htm. Attention is drawn to the limitation of liability, indemnification and jurisdiction issues defined therein. Any holder of this document is advised that information contained hereon reflects the Company's findings at the time of its intervention only and within the limits of Client's instructions, if any. The Company's sole responsibility is to its Client and this document does not exonerate parties to a transaction from exercising all their rights and obligations under the transaction documents. This document cannot be reproduced except in full, without prior written approval of the Company. Any unauthorized alteration, forgery or falsification of the content or appearance of this document is unlawful and offenders may be prosecuted to the fullest extent of the law.

Band4_10MHz_64QAM_50_0_Main_LowCH2000-1715

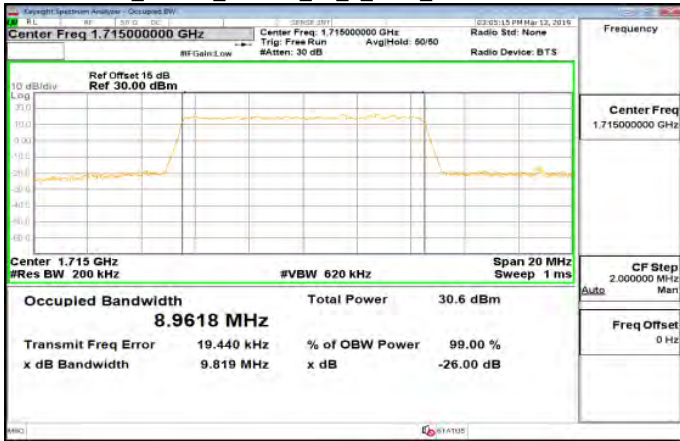

Band4_15MHz_QPSK_75_0_Main_LowCH20025-1717.5

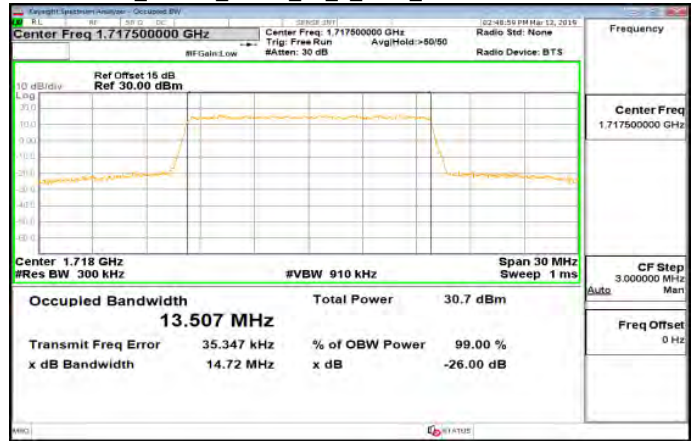

Band4_10MHz_64QAM_50_0_Main_MidCH20175-1732.5

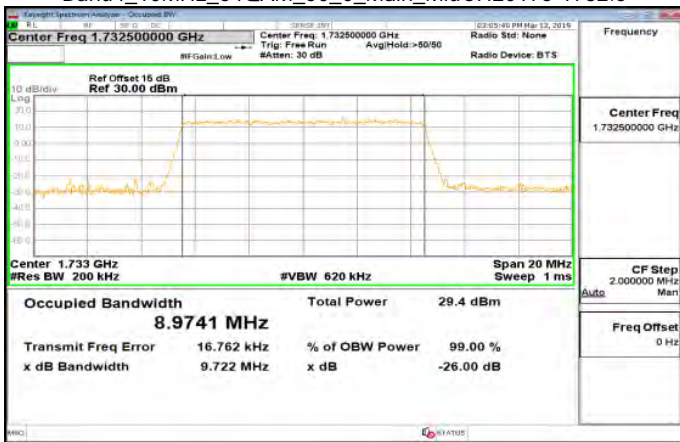

Band4_15MHz_QPSK_75_0_Main_MidCH20175-1732.5

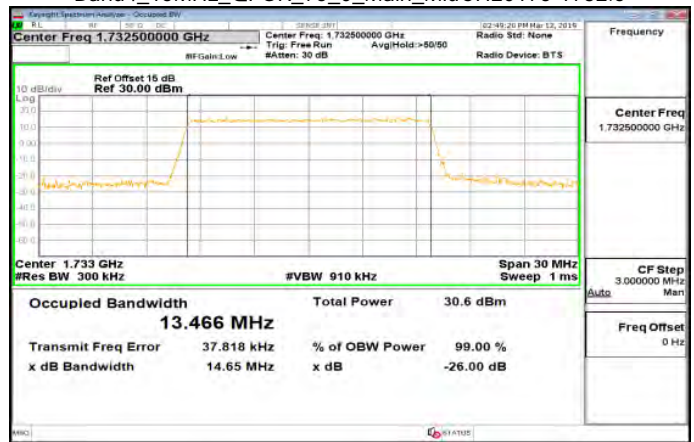

Band4_10MHz_64QAM_50_0_Main_HighCH20350-1750

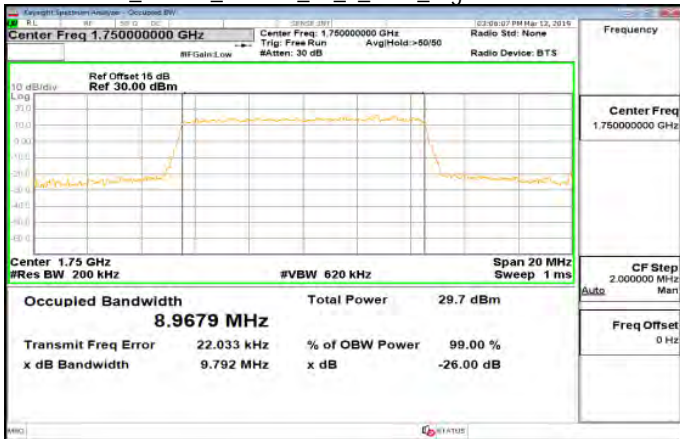

Band4_15MHz_QPSK_75_0_Main_HighCH20325-1747.5

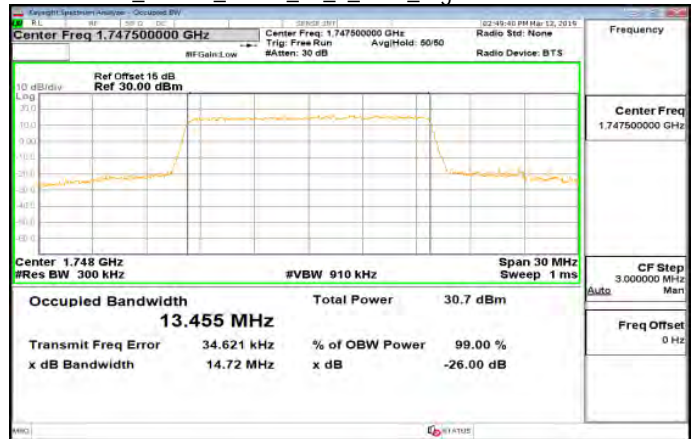

Unless otherwise stated the results shown in this test report refer only to the sample(s) tested and such sample(s) are retained for 90 days only.

除非另有說明，此報告結果僅對測試之樣品負責，同時此樣品僅保留90天。本報告未經本公司書面許可，不可部份複製。

This document is issued by the Company subject to its General Conditions of Service printed overleaf, available on request or accessible at www.sgs.com/terms_and_conditions.htm and for electronic format documents, subject to Terms and Conditions for Electronic Documents at www.sgs.com/terms_e-document.htm. Attention is drawn to the limitation of liability, indemnification and jurisdiction issues defined therein. Any holder of this document is advised that information contained hereon reflects the Company's findings at the time of its intervention only and within the limits of Client's instructions, if any. The Company's sole responsibility is to its Client and this document does not exonerate parties to a transaction from exercising all their rights and obligations under the transaction documents. This document cannot be reproduced except in full, without prior written approval of the Company. Any unauthorized alteration, forgery or falsification of the content or appearance of this document is unlawful and offenders may be prosecuted to the fullest extent of the law.

Band4_15MHz_16QAM_75_0_Main_LowCH20025-1717.5

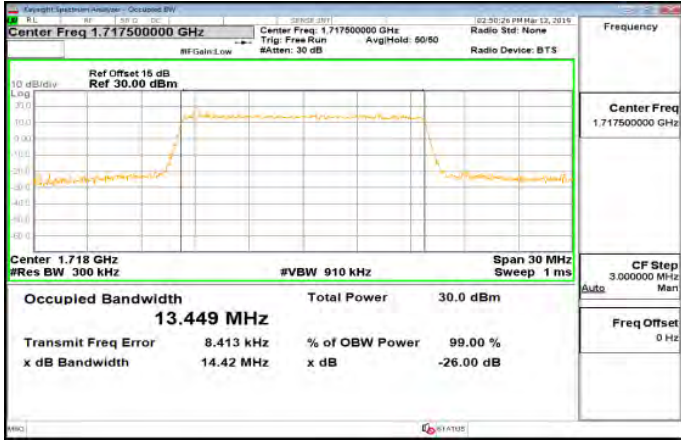

Band4_15MHz_64QAM_75_0_Main_LowCH20025-1717.5

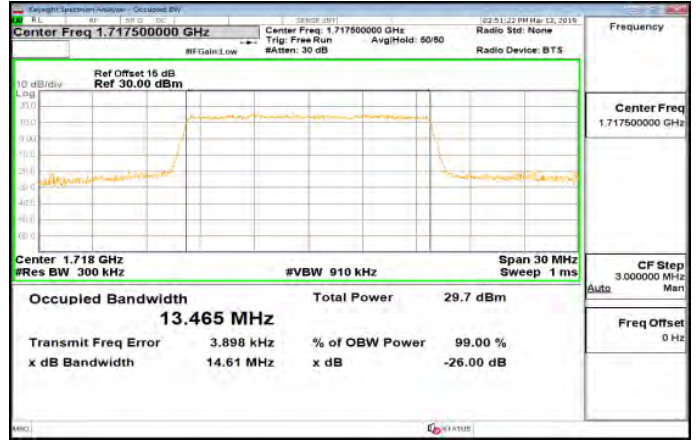

Band4_15MHz_16QAM_75_0_Main_MidCH20175-1732.5

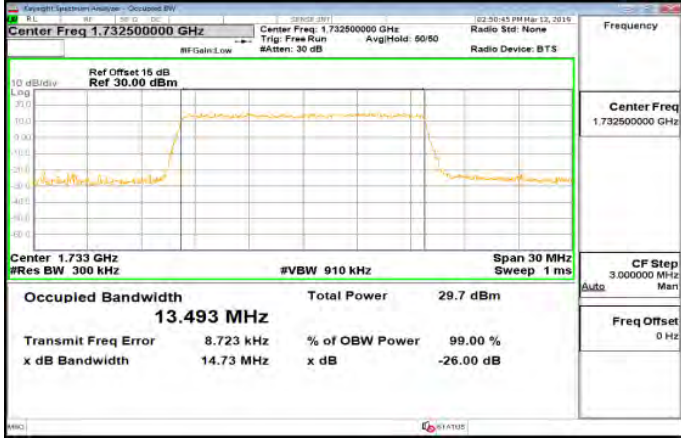

Band4_15MHz_64QAM_75_0_Main_MidCH20175-1732.5

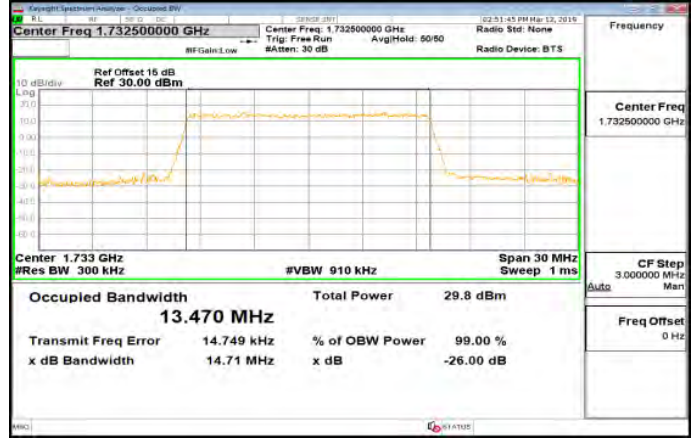

Band4_15MHz_16QAM_75_0_Main_HighCH20325-1747.5

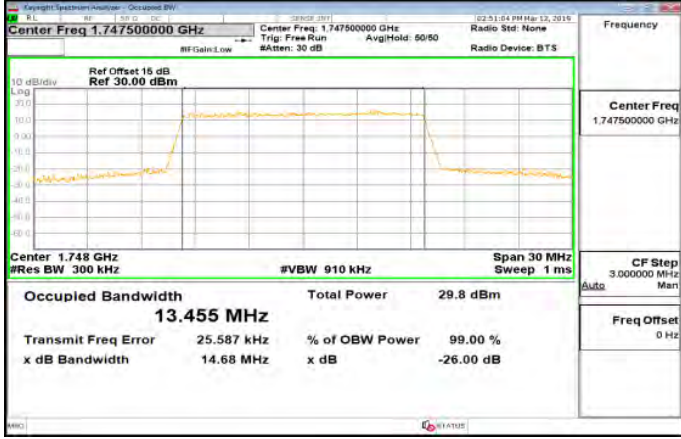

Band4_15MHz_64QAM_75_0_Main_HighCH20325-1747.5

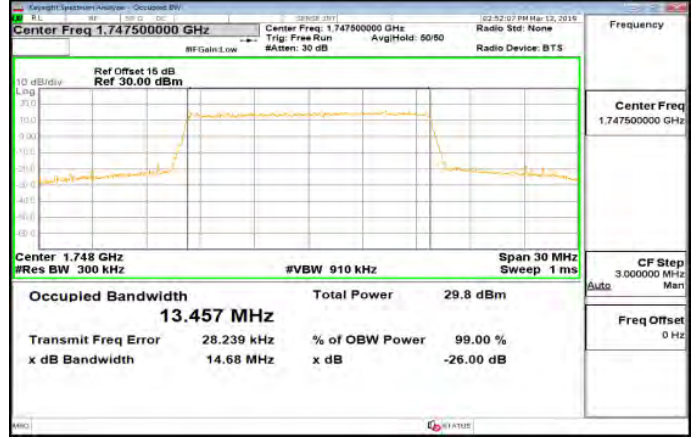

Unless otherwise stated the results shown in this test report refer only to the sample(s) tested and such sample(s) are retained for 90 days only.

除非另有說明，此報告結果僅對測試之樣品負責，同時此樣品僅保留90天。本報告未經本公司書面許可，不可部份複製。

This document is issued by the Company subject to its General Conditions of Service printed overleaf, available on request or accessible at www.sgs.com/terms_and_conditions.htm and for electronic format documents, subject to Terms and Conditions for Electronic Documents at www.sgs.com/terms_e-document.htm. Attention is drawn to the limitation of liability, indemnification and jurisdiction issues defined therein. Any holder of this document is advised that information contained hereon reflects the Company's findings at the time of its intervention only and within the limits of Client's instructions, if any. The Company's sole responsibility is to its Client and this document does not exonerate parties to a transaction from exercising all their rights and obligations under the transaction documents. This document cannot be reproduced except in full, without prior written approval of the Company. Any unauthorized alteration, forgery or falsification of the content or appearance of this document is unlawful and offenders may be prosecuted to the fullest extent of the law.

Band4_20MHz_QPSK_100_0_Main_LowCH20050-1720

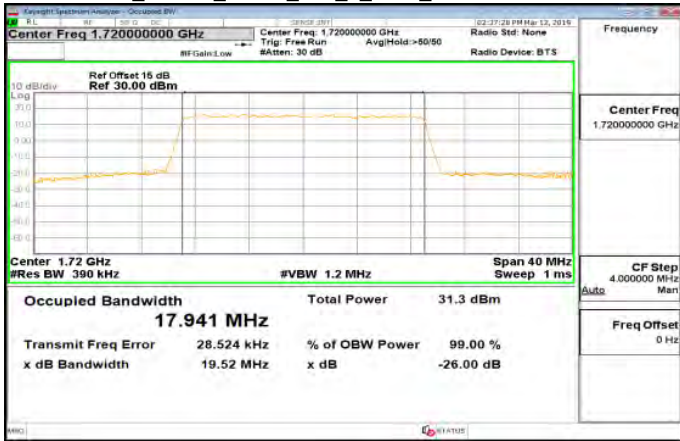

Band4_20MHz_16QAM_100_0_Main_LowCH20050-1720

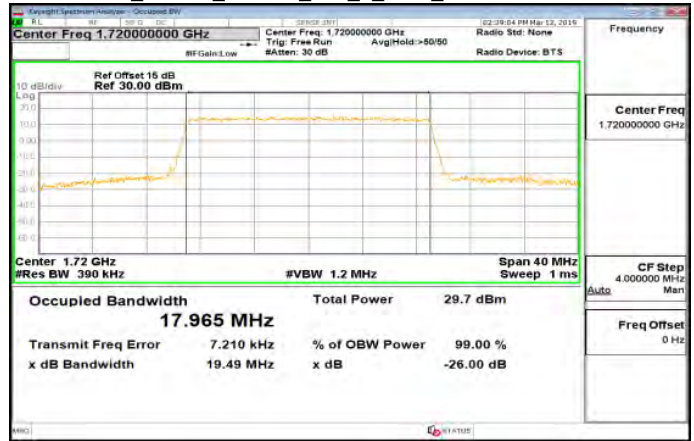

Band4_20MHz_QPSK_100_0_Main_MidCH20175-1732.5

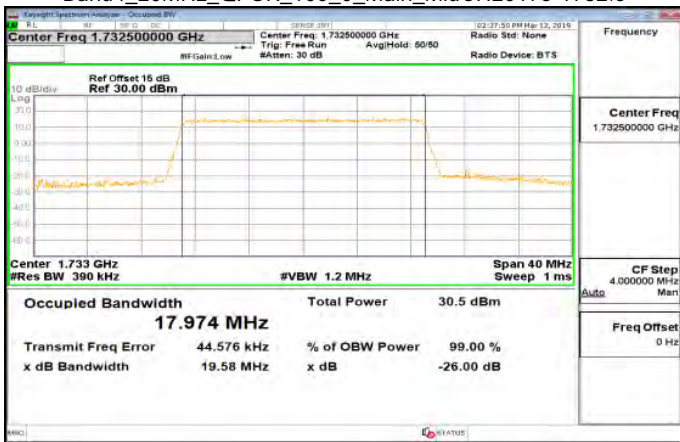

Band4_20MHz_16QAM_100_0_Main_MidCH20175-1732.5

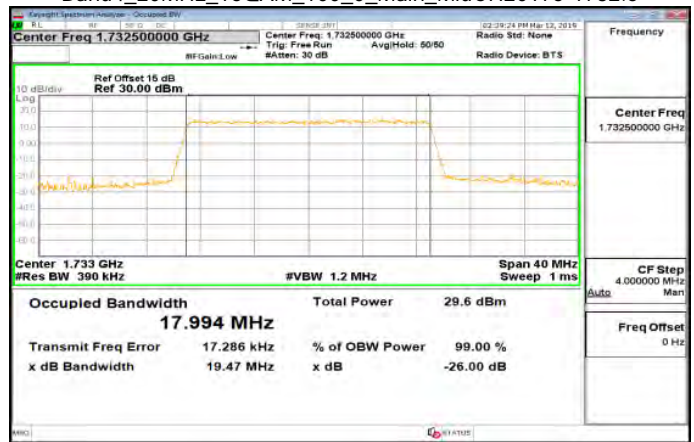

Band4_20MHz_QPSK_100_0_Main_HighCH20300-1745

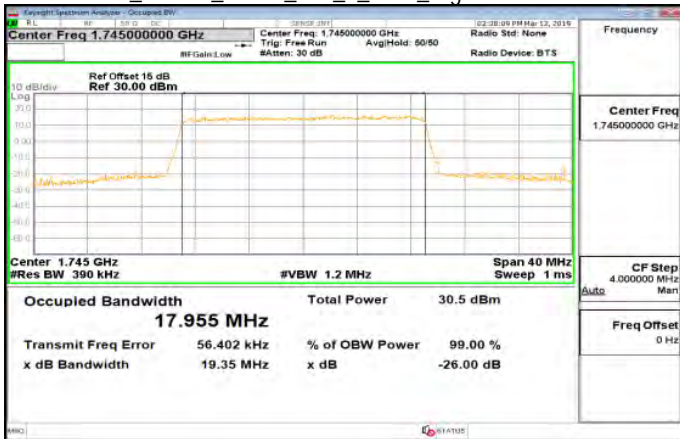

Band4_20MHz_16QAM_100_0_Main_HighCH20300-1745

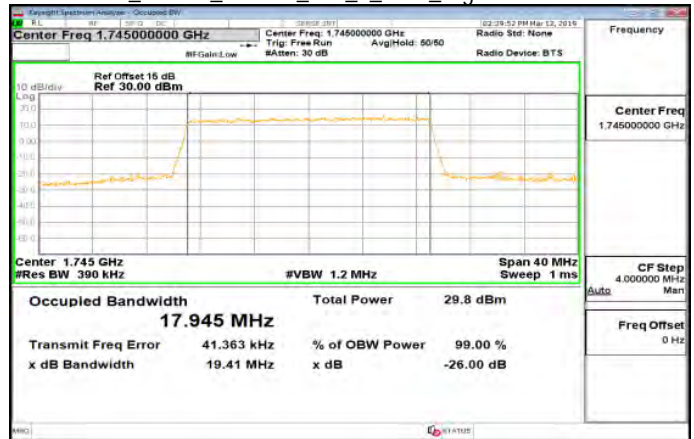

Unless otherwise stated the results shown in this test report refer only to the sample(s) tested and such sample(s) are retained for 90 days only.

除非另有說明，此報告結果僅對測試之樣品負責，同時此樣品僅保留90天。本報告未經本公司書面許可，不可部份複製。

This document is issued by the Company subject to its General Conditions of Service printed overleaf, available on request or accessible at www.sgs.com/terms_and_conditions.htm and for electronic format documents, subject to Terms and Conditions for Electronic Documents at www.sgs.com/terms_e-document.htm. Attention is drawn to the limitation of liability, indemnification and jurisdiction issues defined therein. Any holder of this document is advised that information contained hereon reflects the Company's findings at the time of its intervention only and within the limits of Client's instructions, if any. The Company's sole responsibility is to its Client and this document does not exonerate parties to a transaction from exercising all their rights and obligations under the transaction documents. This document cannot be reproduced except in full, without prior written approval of the Company. Any unauthorized alteration, forgery or falsification of the content or appearance of this document is unlawful and offenders may be prosecuted to the fullest extent of the law.

Band4_20MHz_64QAM_100_0_Main_LowCH20050-1720

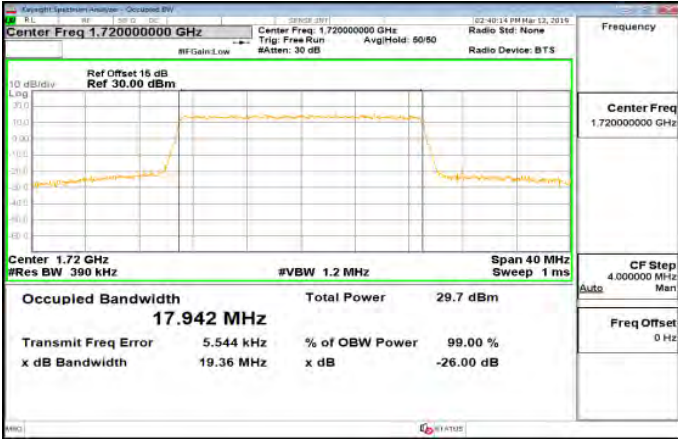

Band5_1_4MHz_QPSK_6_0_Main_LowCH20407-824.7

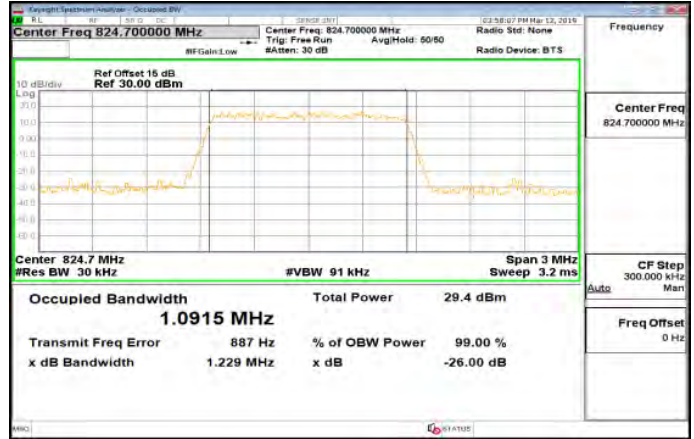

Band4_20MHz_64QAM_100_0_Main_MidCH20175-1732.5

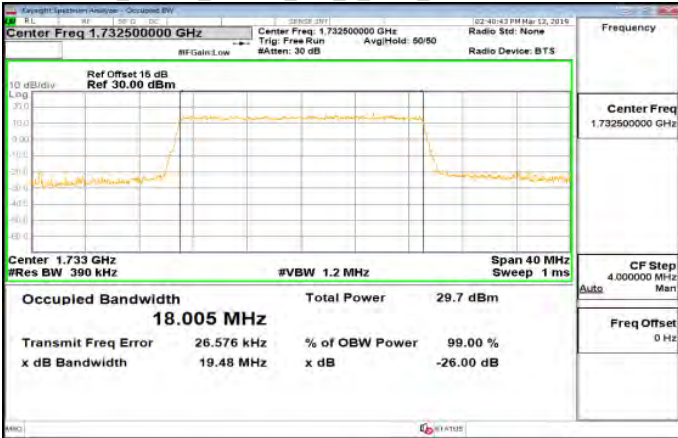

Band5_1_4MHz_QPSK_6_0_Main_MidCH20525-836.5

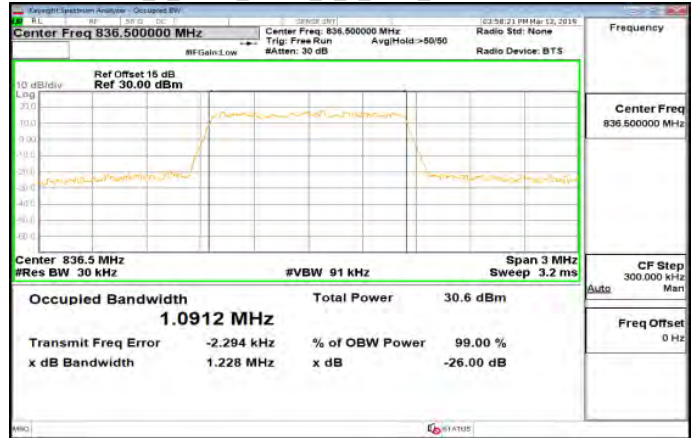

Band4_20MHz_64QAM_100_0_Main_HighCH20300-1745

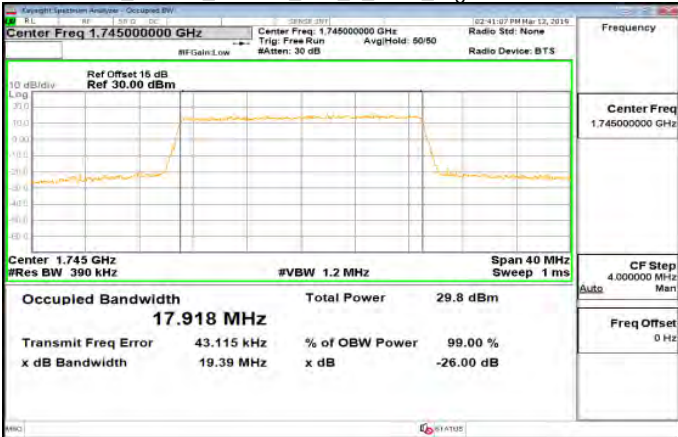

Band5_1_4MHz_QPSK_6_0_Main_HighCH20643-848.3

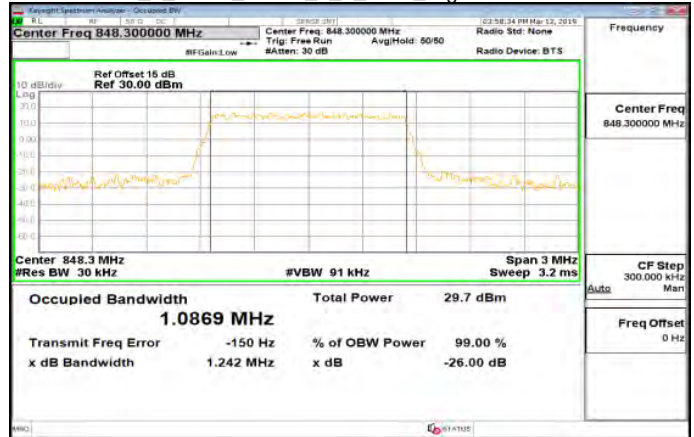

Unless otherwise stated the results shown in this test report refer only to the sample(s) tested and such sample(s) are retained for 90 days only.

除非另有說明，此報告結果僅對測試之樣品負責，同時此樣品僅保留90天。本報告未經本公司書面許可，不可部份複製。

This document is issued by the Company subject to its General Conditions of Service printed overleaf, available on request or accessible at www.sgs.com/terms_and_conditions.htm and for electronic format documents, subject to Terms and Conditions for Electronic Documents at www.sgs.com/terms_e-document.htm. Attention is drawn to the limitation of liability, indemnification and jurisdiction issues defined therein. Any holder of this document is advised that information contained hereon reflects the Company's findings at the time of its intervention only and within the limits of Client's instructions, if any. The Company's sole responsibility is to its Client and this document does not exonerate parties to a transaction from exercising all their rights and obligations under the transaction documents. This document cannot be reproduced except in full, without prior written approval of the Company. Any unauthorized alteration, forgery or falsification of the content or appearance of this document is unlawful and offenders may be prosecuted to the fullest extent of the law.

Band5_1_4MHz_16QAM_6_0_Main_LowCH20407-824.7

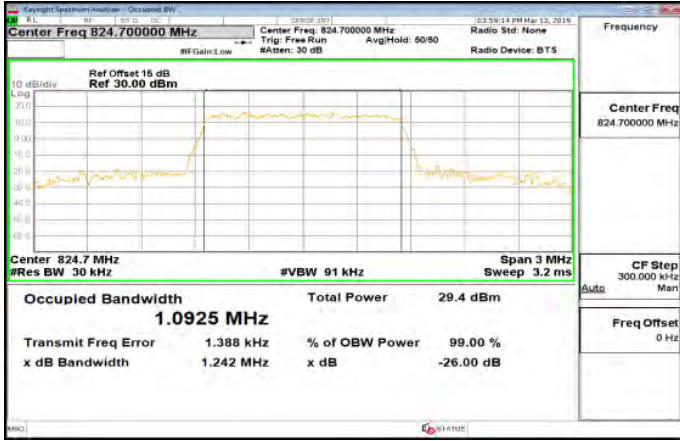

Band5_1_4MHz_64QAM_6_0_Main_LowCH20407-824.7

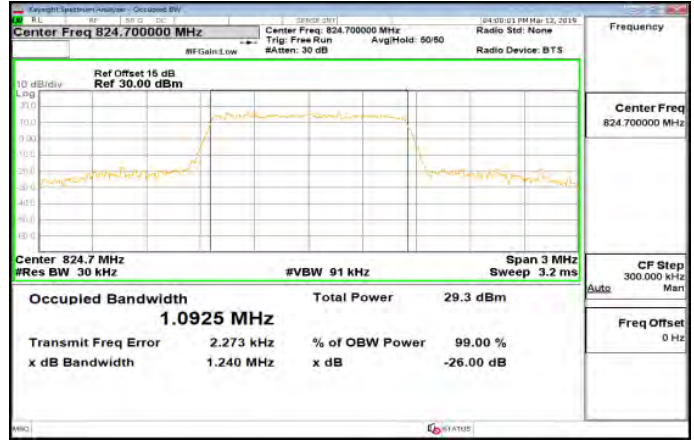

Band5_1_4MHz_16QAM_6_0_Main_MidCH20525-836.5

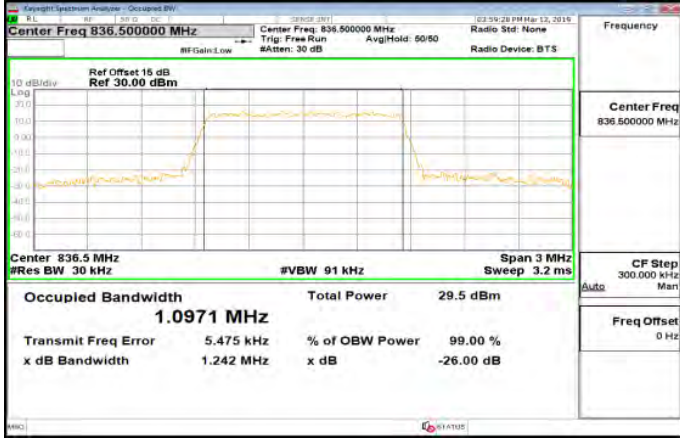

Band5_1_4MHz_64QAM_6_0_Main_MidCH20525-836.5

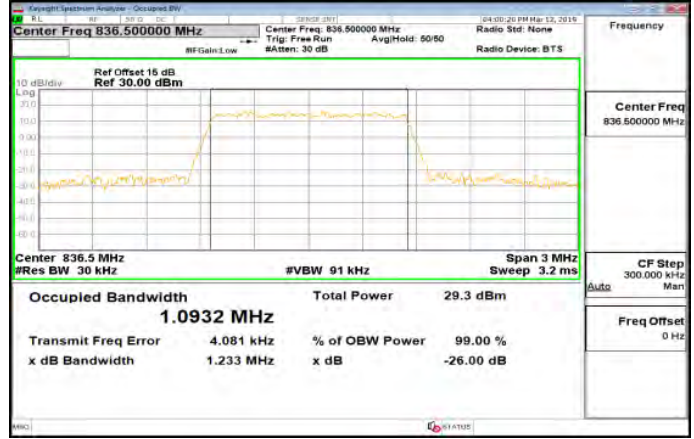

Band5_1_4MHz_16QAM_6_0_Main_HighCH20643-848.3

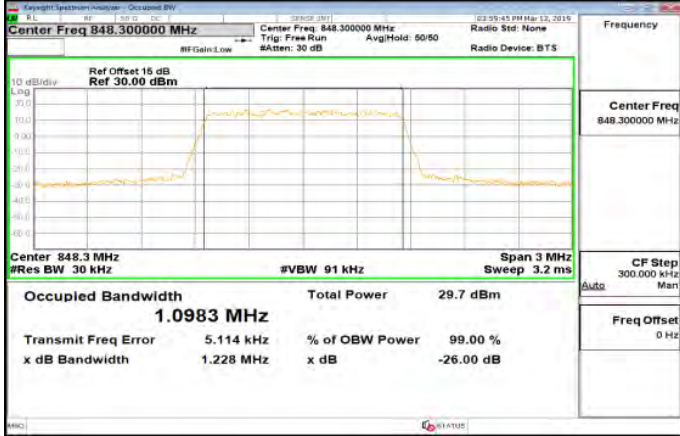

Band5_1_4MHz_64QAM_6_0_Main_HighCH20643-848.3

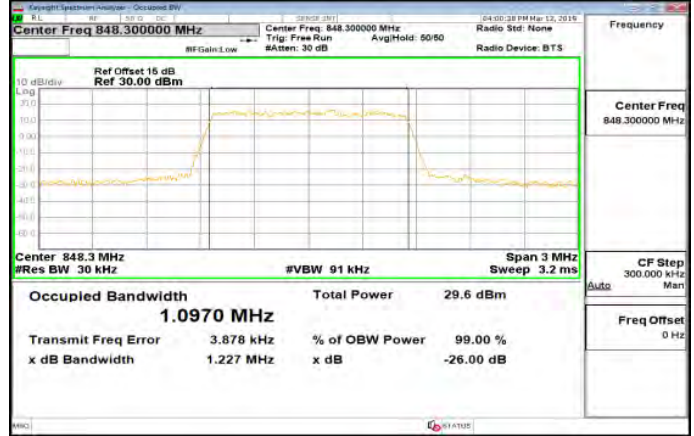

Unless otherwise stated the results shown in this test report refer only to the sample(s) tested and such sample(s) are retained for 90 days only.

除非另有說明，此報告結果僅對測試之樣品負責，同時此樣品僅保留90天。本報告未經本公司書面許可，不可部份複製。

This document is issued by the Company subject to its General Conditions of Service printed overleaf, available on request or accessible at www.sgs.com/terms_and_conditions.htm and for electronic format documents, subject to Terms and Conditions for Electronic Documents at www.sgs.com/terms_e-document.htm. Attention is drawn to the limitation of liability, indemnification and jurisdiction issues defined therein. Any holder of this document is advised that information contained hereon reflects the Company's findings at the time of its intervention only and within the limits of Client's instructions, if any. The Company's sole responsibility is to its Client and this document does not exonerate parties to a transaction from exercising all their rights and obligations under the transaction documents. This document cannot be reproduced except in full, without prior written approval of the Company. Any unauthorized alteration, forgery or falsification of the content or appearance of this document is unlawful and offenders may be prosecuted to the fullest extent of the law.

Band5_3MHz_QPSK_15_0_Main_LowCH20415-825.5

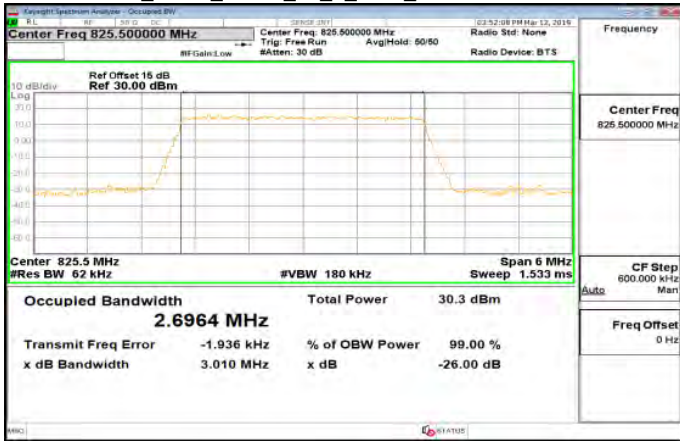

Band5_3MHz_16QAM_15_0_Main_LowCH20415-825.5

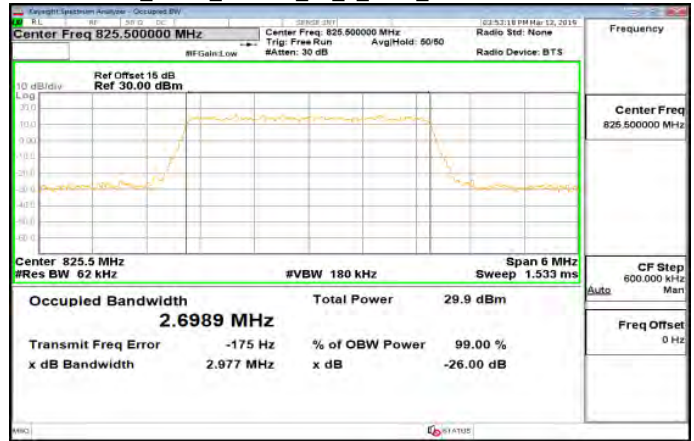

Band5_3MHz_QPSK_15_0_Main_MidCH20525-836.5

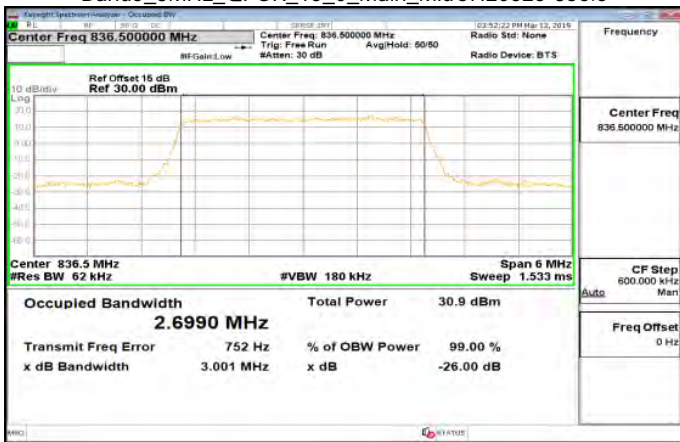

Band5_3MHz_16QAM_15_0_Main_MidCH20525-836.5

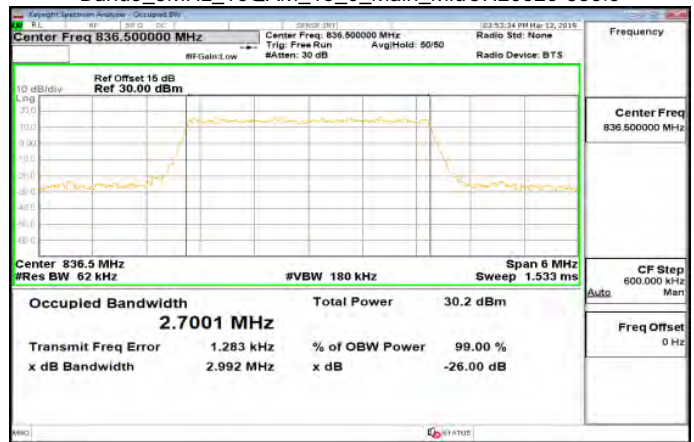

Band5_3MHz_QPSK_15_0_Main_HighCH20635-847.5

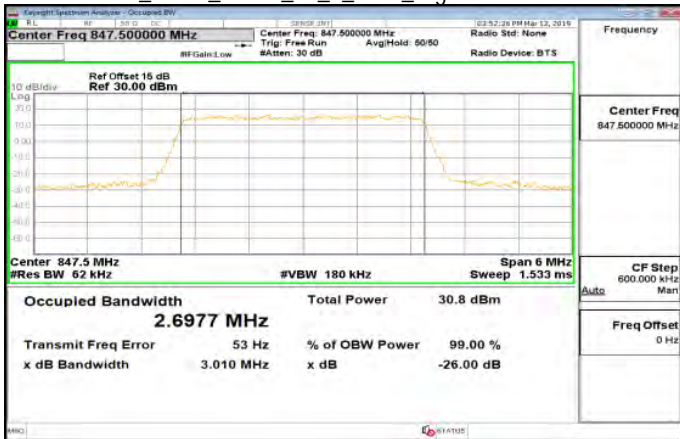

Band5_3MHz_16QAM_15_0_Main_HighCH20635-847.5

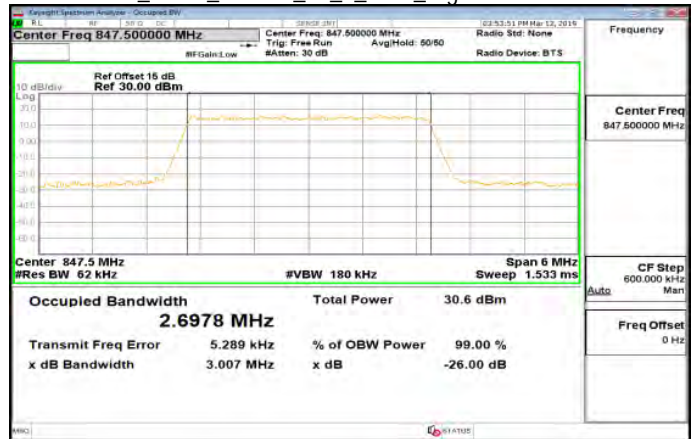

Unless otherwise stated the results shown in this test report refer only to the sample(s) tested and such sample(s) are retained for 90 days only.

除非另有說明，此報告結果僅對測試之樣品負責，同時此樣品僅保留90天。本報告未經本公司書面許可，不可部份複製。

This document is issued by the Company subject to its General Conditions of Service printed overleaf, available on request or accessible at www.sgs.com/terms_and_conditions.htm and for electronic format documents, subject to Terms and Conditions for Electronic Documents at www.sgs.com/terms_e-document.htm. Attention is drawn to the limitation of liability, indemnification and jurisdiction issues defined therein. Any holder of this document is advised that information contained hereon reflects the Company's findings at the time of its intervention only and within the limits of Client's instructions, if any. The Company's sole responsibility is to its Client and this document does not exonerate parties to a transaction from exercising all their rights and obligations under the transaction documents. This document cannot be reproduced except in full, without prior written approval of the Company. Any unauthorized alteration, forgery or falsification of the content or appearance of this document is unlawful and offenders may be prosecuted to the fullest extent of the law.

Band5_3MHz_64QAM_15_0_Main_LowCH20415-825.5

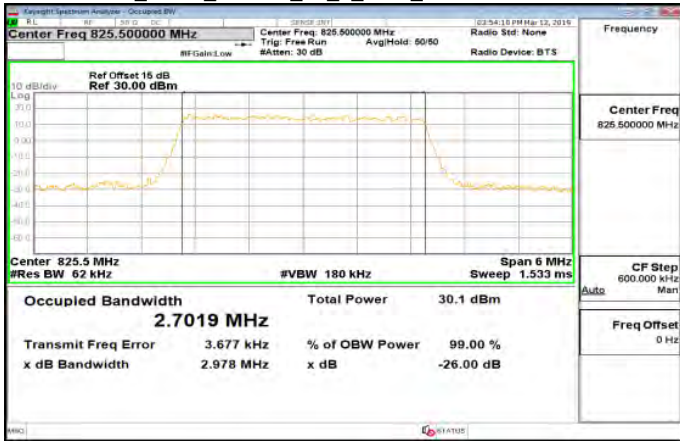

Band5_5MHz_QPSK_25_0_Main_LowCH20425-826.5

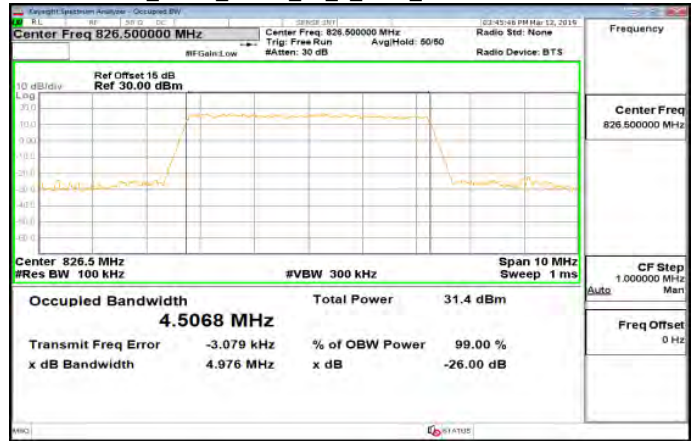

Band5_3MHz_64QAM_15_0_Main_MidCH20525-836.5

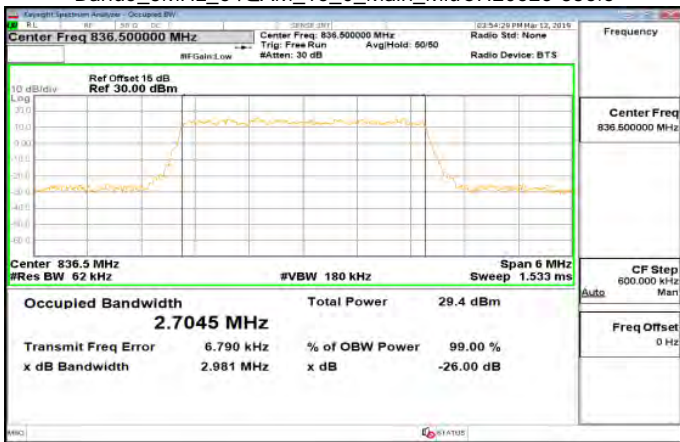

Band5_5MHz_QPSK_25_0_Main_MidCH20525-836.5

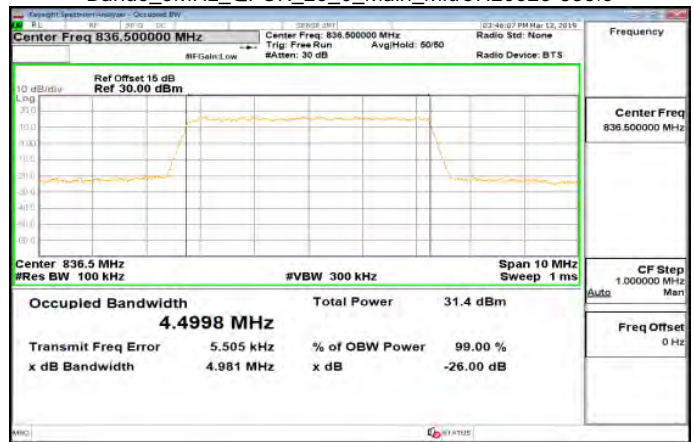

Band5_3MHz_64QAM_15_0_Main_HighCH20635-847.5

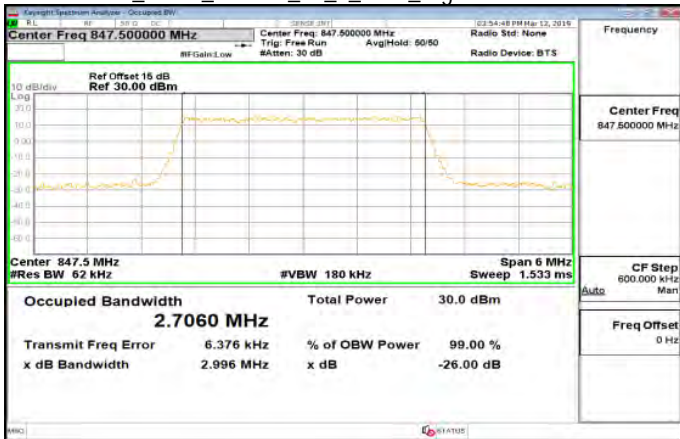

Band5_5MHz_QPSK_25_0_Main_HighCH20625-846.5

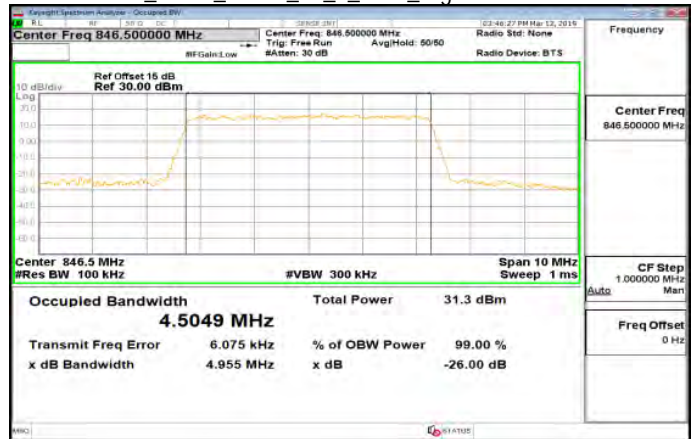

Unless otherwise stated the results shown in this test report refer only to the sample(s) tested and such sample(s) are retained for 90 days only.

除非另有說明，此報告結果僅對測試之樣品負責，同時此樣品僅保留90天。本報告未經本公司書面許可，不可部份複製。

This document is issued by the Company subject to its General Conditions of Service printed overleaf, available on request or accessible at www.sgs.com/terms_and_conditions.htm and for electronic format documents, subject to Terms and Conditions for Electronic Documents at www.sgs.com/terms_e-document.htm. Attention is drawn to the limitation of liability, indemnification and jurisdiction issues defined therein. Any holder of this document is advised that information contained hereon reflects the Company's findings at the time of its intervention only and within the limits of Client's instructions, if any. The Company's sole responsibility is to its Client and this document does not exonerate parties to a transaction from exercising all their rights and obligations under the transaction documents. This document cannot be reproduced except in full, without prior written approval of the Company. Any unauthorized alteration, forgery or falsification of the content or appearance of this document is unlawful and offenders may be prosecuted to the fullest extent of the law.

Band5_5MHz_16QAM_25_0_Main_LowCH20425-826.5

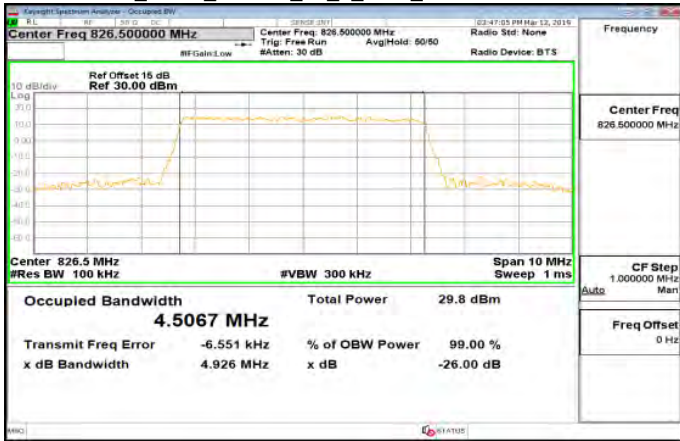

Band5_5MHz_64QAM_25_0_Main_LowCH20425-826.5

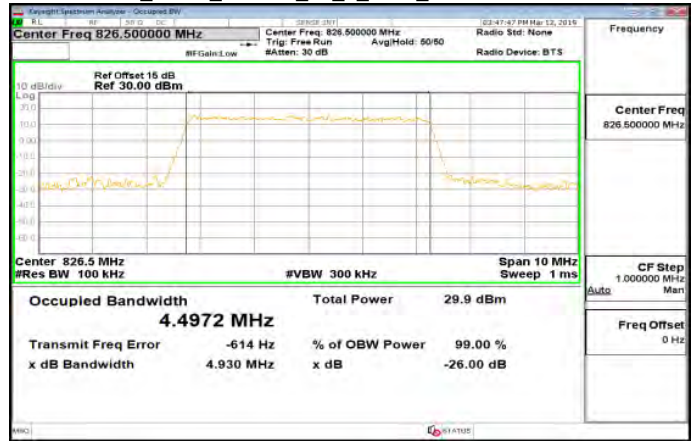

Band5_5MHz_16QAM_25_0_Main_MidCH20525-836.5

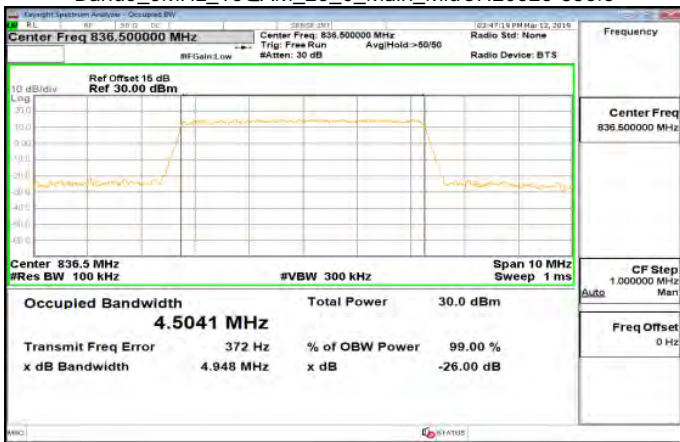

Band5_5MHz_64QAM_25_0_Main_MidCH20525-836.5

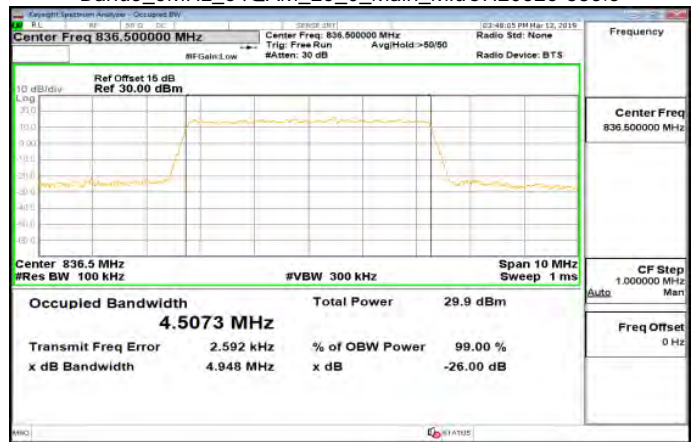

Band5_5MHz_16QAM_25_0_Main_HighCH20625-846.5

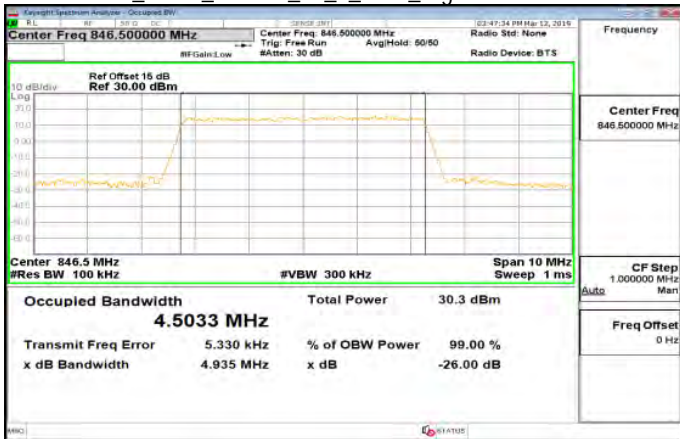

Band5_5MHz_64QAM_25_0_Main_HighCH20625-846.5

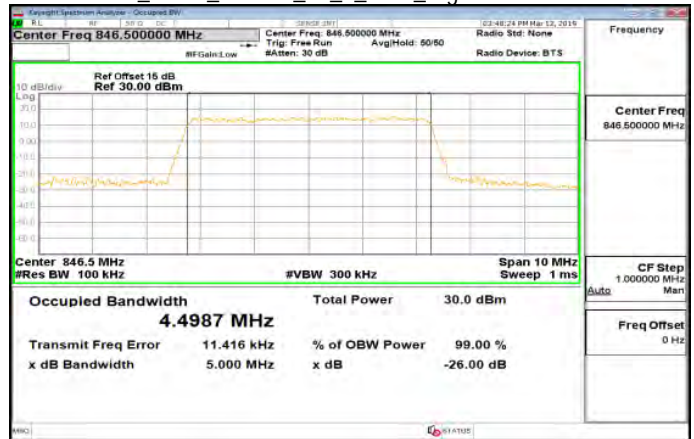

Unless otherwise stated the results shown in this test report refer only to the sample(s) tested and such sample(s) are retained for 90 days only.

除非另有說明，此報告結果僅對測試之樣品負責，同時此樣品僅保留90天。本報告未經本公司書面許可，不可部份複製。

This document is issued by the Company subject to its General Conditions of Service printed overleaf, available on request or accessible at www.sgs.com/terms_and_conditions.htm and for electronic format documents, subject to Terms and Conditions for Electronic Documents at www.sgs.com/terms_e-document.htm. Attention is drawn to the limitation of liability, indemnification and jurisdiction issues defined therein. Any holder of this document is advised that information contained hereon reflects the Company's findings at the time of its intervention only and within the limits of Client's instructions, if any. The Company's sole responsibility is to its Client and this document does not exonerate parties to a transaction from exercising all their rights and obligations under the transaction documents. This document cannot be reproduced except in full, without prior written approval of the Company. Any unauthorized alteration, forgery or falsification of the content or appearance of this document is unlawful and offenders may be prosecuted to the fullest extent of the law.

Band5_10MHz_QPSK_50_0_Main_LowCH20450-829

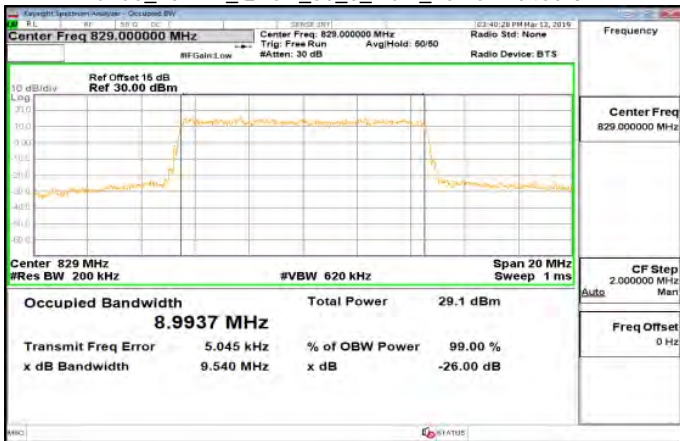

Band5_10MHz_16QAM_50_0_Main_LowCH20450-829

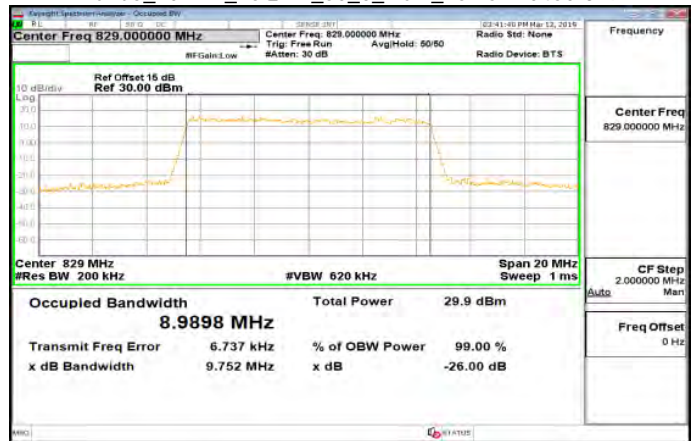

Band5_10MHz_QPSK_50_0_Main_MidCH20525-836.5

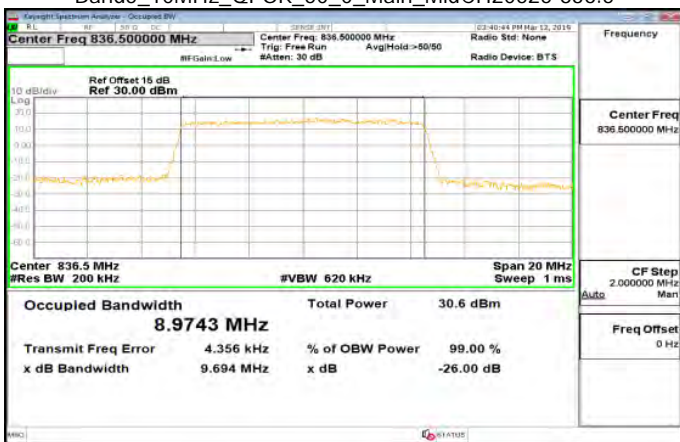

Band5_10MHz_16QAM_50_0_Main_MidCH20525-836.5

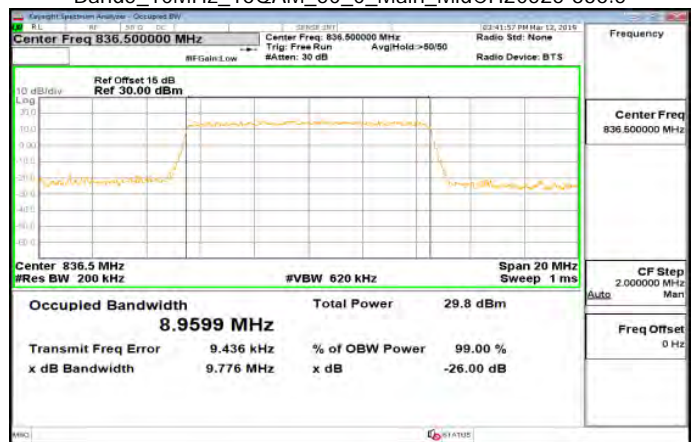

Band5_10MHz_QPSK_50_0_Main_HighCH20600-844

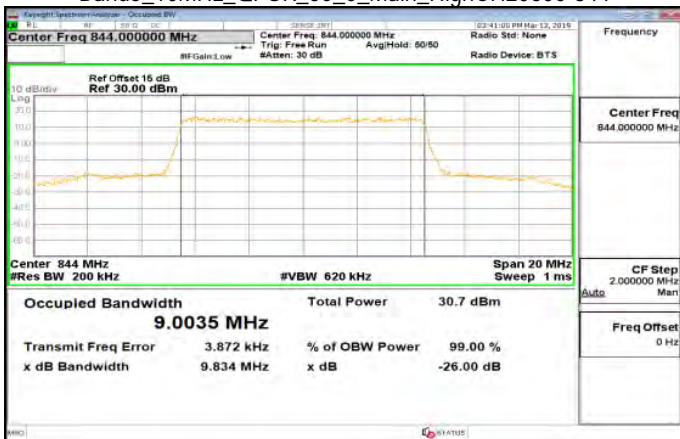

Band5_10MHz_16QAM_50_0_Main_HighCH20600-844

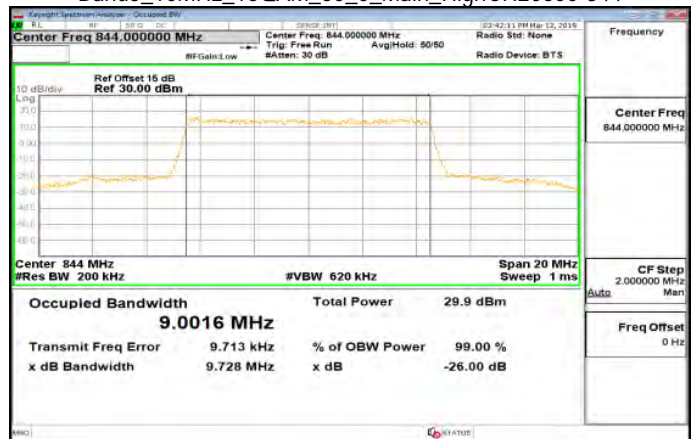

Unless otherwise stated the results shown in this test report refer only to the sample(s) tested and such sample(s) are retained for 90 days only.

除非另有說明，此報告結果僅對測試之樣品負責，同時此樣品僅保留90天。本報告未經本公司書面許可，不可部份複製。

This document is issued by the Company subject to its General Conditions of Service printed overleaf, available on request or accessible at www.sgs.com/terms_and_conditions.htm and for electronic format documents, subject to Terms and Conditions for Electronic Documents at www.sgs.com/terms_e-document.htm. Attention is drawn to the limitation of liability, indemnification and jurisdiction issues defined therein. Any holder of this document is advised that information contained hereon reflects the Company's findings at the time of its intervention only and within the limits of Client's instructions, if any. The Company's sole responsibility is to its Client and this document does not exonerate parties to a transaction from exercising all their rights and obligations under the transaction documents. This document cannot be reproduced except in full, without prior written approval of the Company. Any unauthorized alteration, forgery or falsification of the content or appearance of this document is unlawful and offenders may be prosecuted to the fullest extent of the law.

Band5_10MHz_64QAM_50_0_Main_LowCH20450-829

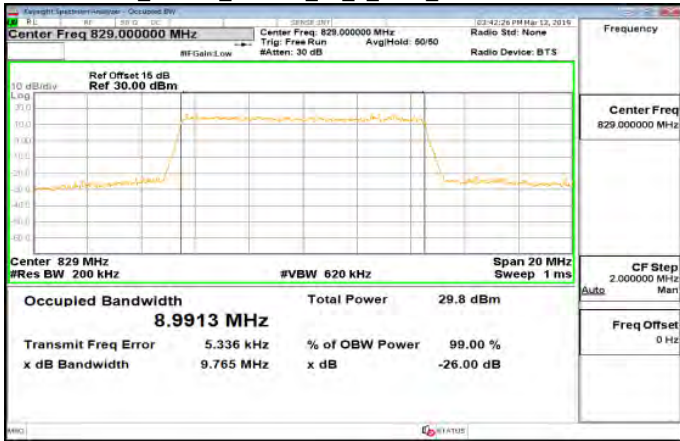

Band7_5MHz_QPSK_25_0_Main_LowCH20775-2502.5

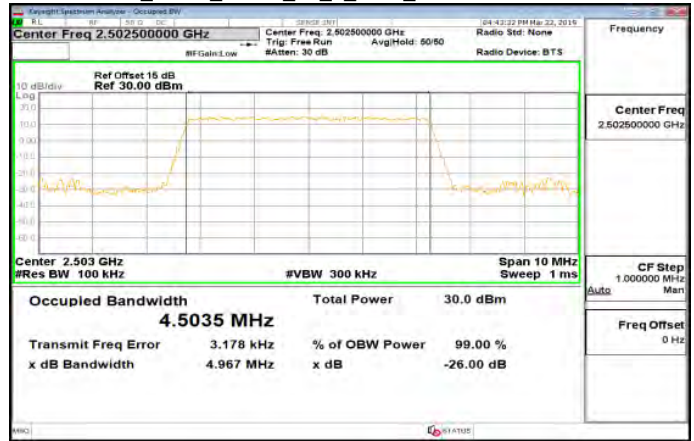

Band5_10MHz_64QAM_50_0_Main_MidCH20525-836.5

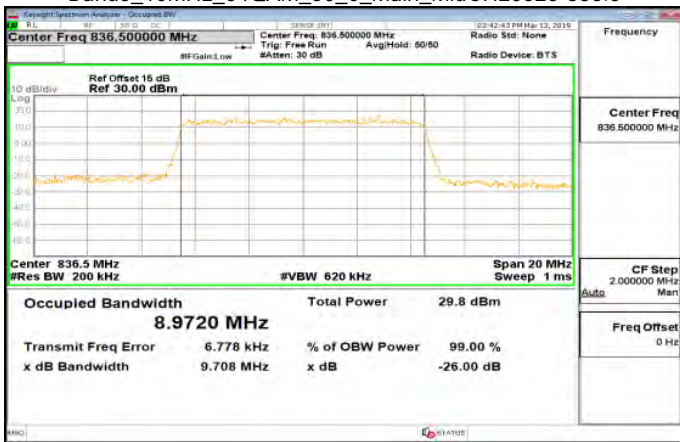

Band7_5MHz_QPSK_25_0_Main_MidCH21100-2535

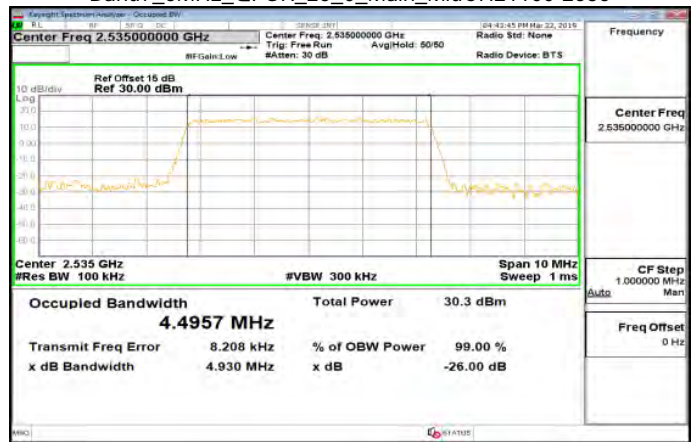

Band5_10MHz_64QAM_50_0_Main_HighCH20600-844

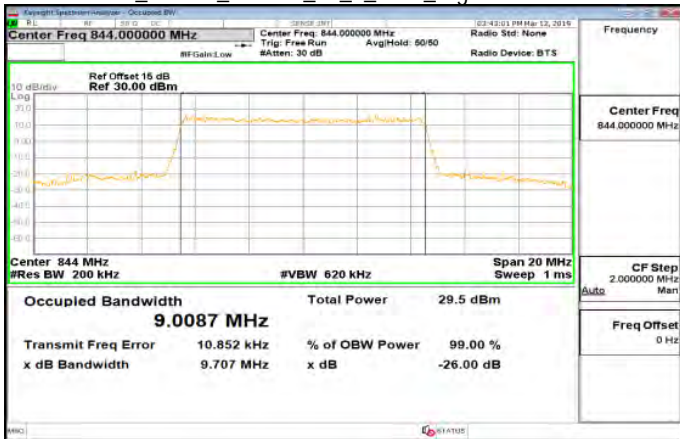

Band7_5MHz_QPSK_25_0_Main_HighCH21425-2567.5

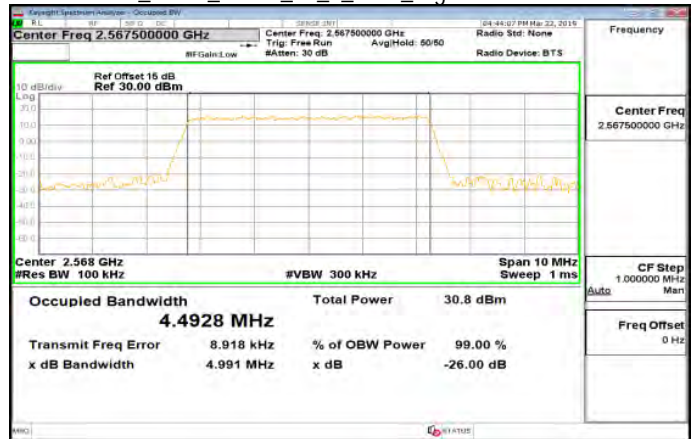

Unless otherwise stated the results shown in this test report refer only to the sample(s) tested and such sample(s) are retained for 90 days only.

除非另有說明，此報告結果僅對測試之樣品負責，同時此樣品僅保留90天。本報告未經本公司書面許可，不可部份複製。

This document is issued by the Company subject to its General Conditions of Service printed overleaf, available on request or accessible at www.sgs.com/terms_and_conditions.htm and for electronic format documents, subject to Terms and Conditions for Electronic Documents at www.sgs.com/terms_e-document.htm. Attention is drawn to the limitation of liability, indemnification and jurisdiction issues defined therein. Any holder of this document is advised that information contained hereon reflects the Company's findings at the time of its intervention only and within the limits of Client's instructions, if any. The Company's sole responsibility is to its Client and this document does not exonerate parties to a transaction from exercising all their rights and obligations under the transaction documents. This document cannot be reproduced except in full, without prior written approval of the Company. Any unauthorized alteration, forgery or falsification of the content or appearance of this document is unlawful and offenders may be prosecuted to the fullest extent of the law.

Band7_5MHz_16QAM_25_0_Main_LowCH20775-2502.5

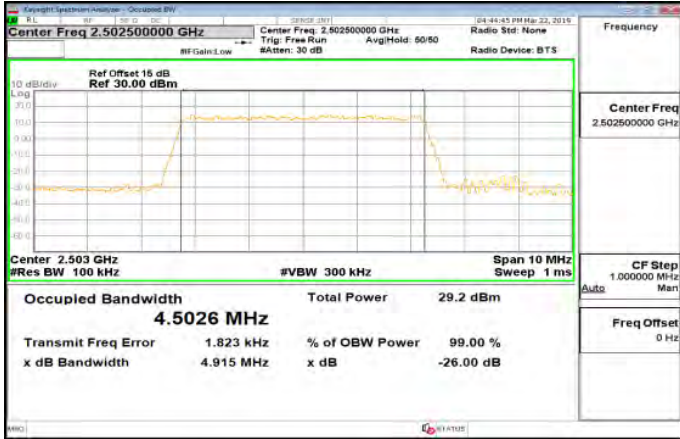

Band7_5MHz_64QAM_25_0_Main_LowCH20775-2502.5

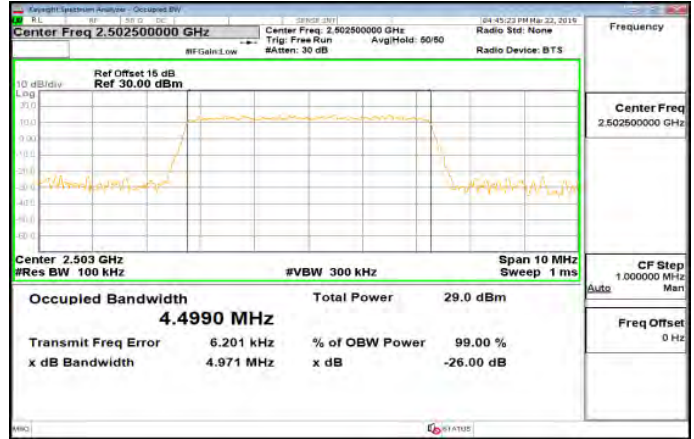

Band7_5MHz_16QAM_25_0_Main_MidCH21100-2535

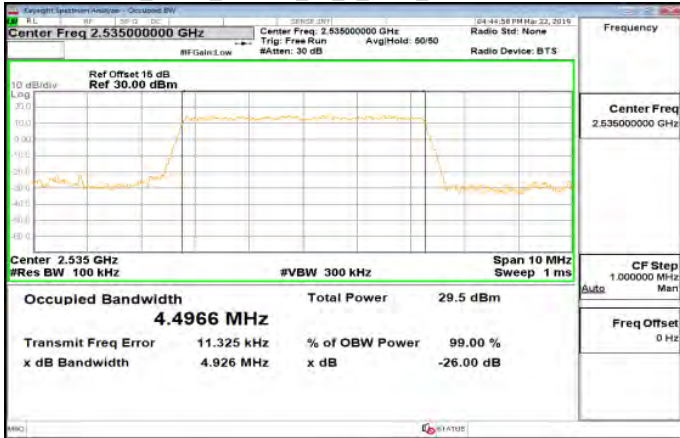

Band7_5MHz_64QAM_25_0_Main_MidCH21100-2535

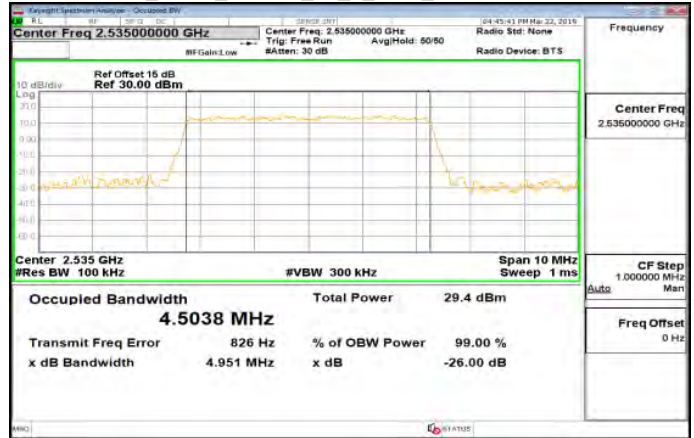

Band7_5MHz_16QAM_25_0_Main_HighCH21425-2567.5

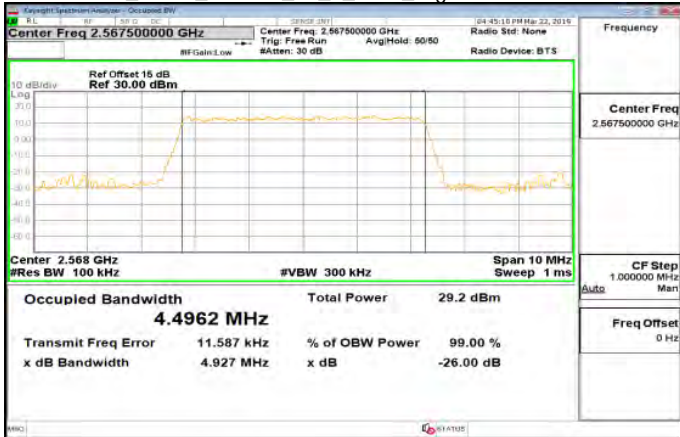

Band7_5MHz_64QAM_25_0_Main_HighCH21425-2567.5

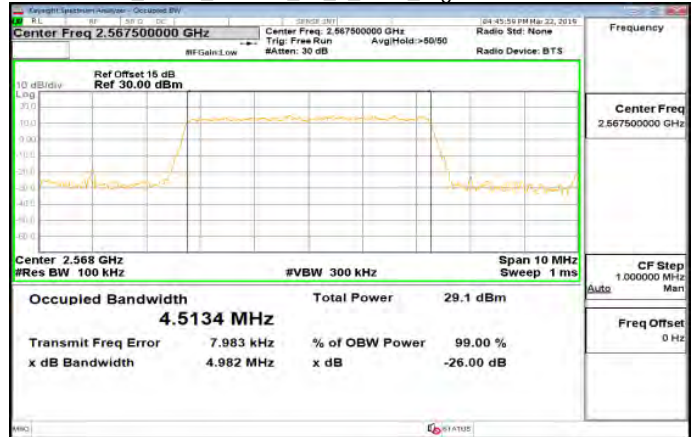

Unless otherwise stated the results shown in this test report refer only to the sample(s) tested and such sample(s) are retained for 90 days only.

除非另有說明，此報告結果僅對測試之樣品負責，同時此樣品僅保留90天。本報告未經本公司書面許可，不可部份複製。

This document is issued by the Company subject to its General Conditions of Service printed overleaf, available on request or accessible at www.sgs.com/terms_and_conditions.htm and for electronic format documents, subject to Terms and Conditions for Electronic Documents at www.sgs.com/terms_e-document.htm. Attention is drawn to the limitation of liability, indemnification and jurisdiction issues defined therein. Any holder of this document is advised that information contained hereon reflects the Company's findings at the time of its intervention only and within the limits of Client's instructions, if any. The Company's sole responsibility is to its Client and this document does not exonerate parties to a transaction from exercising all their rights and obligations under the transaction documents. This document cannot be reproduced except in full, without prior written approval of the Company. Any unauthorized alteration, forgery or falsification of the content or appearance of this document is unlawful and offenders may be prosecuted to the fullest extent of the law.

Band7_10MHz_QPSK_50_0_Main_LowCH20800-2505

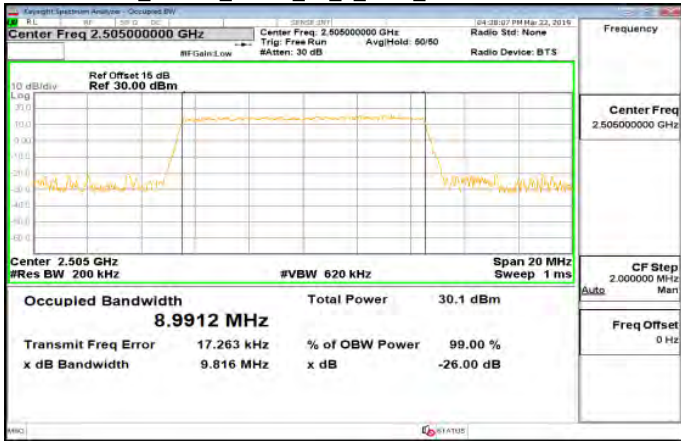

Band7_10MHz_16QAM_50_0_Main_LowCH20800-2505

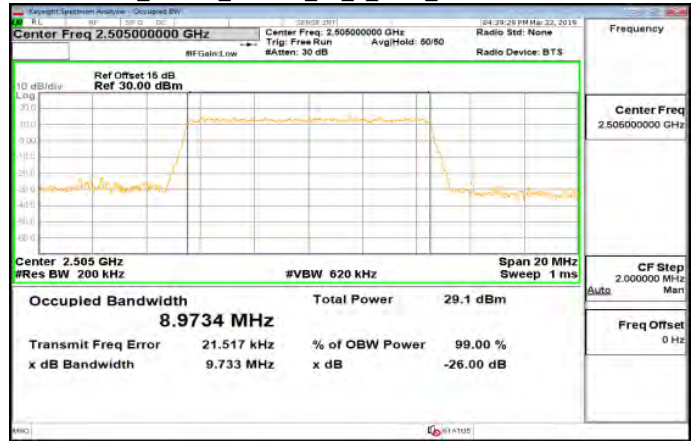

Band7_10MHz_QPSK_50_0_Main_MidCH21100-2535

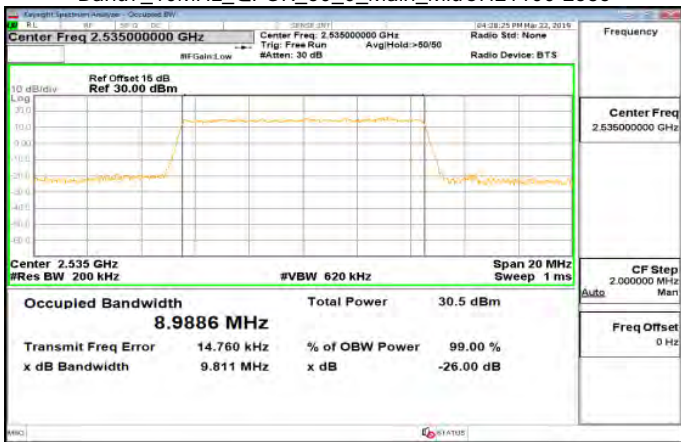

Band7_10MHz_16QAM_50_0_Main_MidCH21100-2535

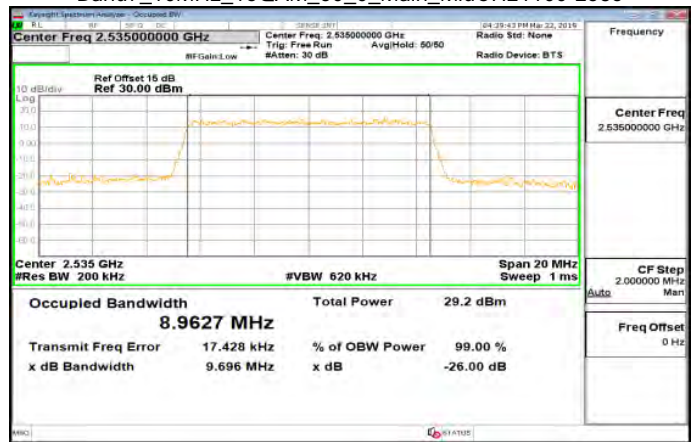

Band7_10MHz_QPSK_50_0_Main_HighCH21400-2565

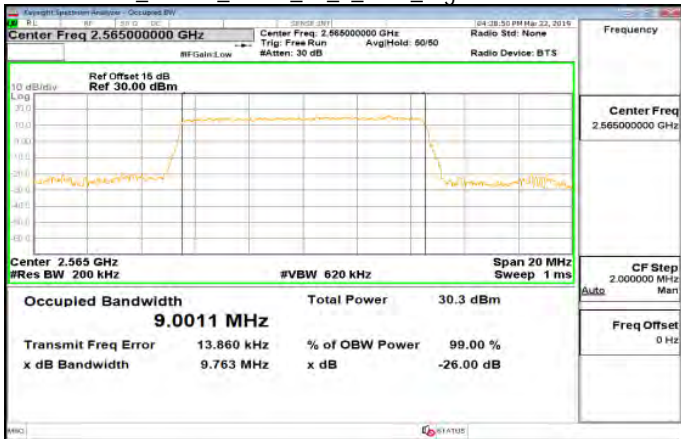

Band7_10MHz_16QAM_50_0_Main_HighCH21400-2565

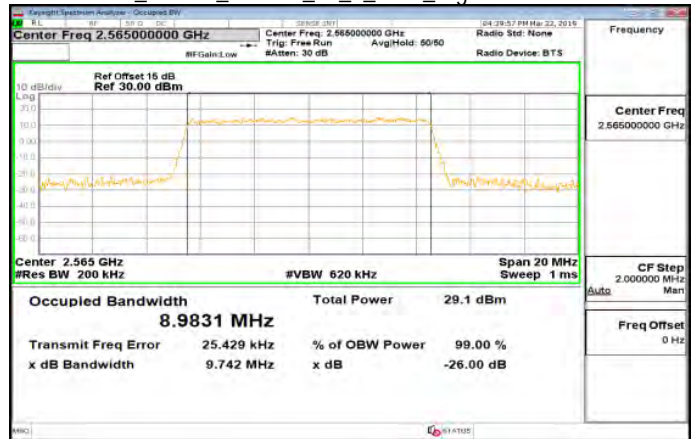

Unless otherwise stated the results shown in this test report refer only to the sample(s) tested and such sample(s) are retained for 90 days only.

除非另有說明，此報告結果僅對測試之樣品負責，同時此樣品僅保留90天。本報告未經本公司書面許可，不可部份複製。

This document is issued by the Company subject to its General Conditions of Service printed overleaf, available on request or accessible at www.sgs.com/terms_and_conditions.htm and for electronic format documents, subject to Terms and Conditions for Electronic Documents at www.sgs.com/terms_e-document.htm. Attention is drawn to the limitation of liability, indemnification and jurisdiction issues defined therein. Any holder of this document is advised that information contained hereon reflects the Company's findings at the time of its intervention only and within the limits of Client's instructions, if any. The Company's sole responsibility is to its Client and this document does not exonerate parties to a transaction from exercising all their rights and obligations under the transaction documents. This document cannot be reproduced except in full, without prior written approval of the Company. Any unauthorized alteration, forgery or falsification of the content or appearance of this document is unlawful and offenders may be prosecuted to the fullest extent of the law.

Band7_10MHz_64QAM_50_0_Main_LowCH20800-2505

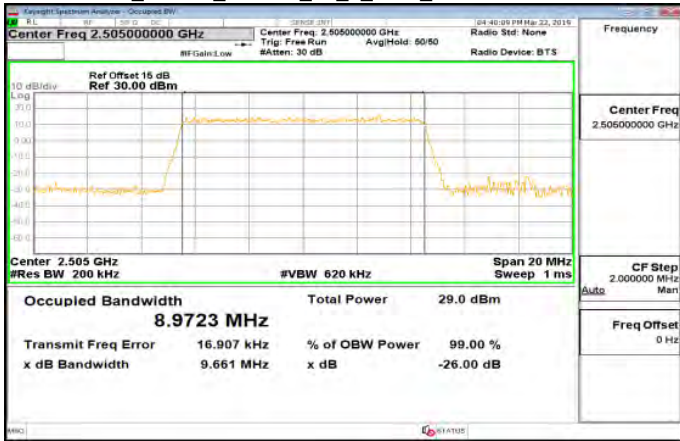

Band7_15MHz_QPSK_75_0_Main_LowCH20825-2507.5

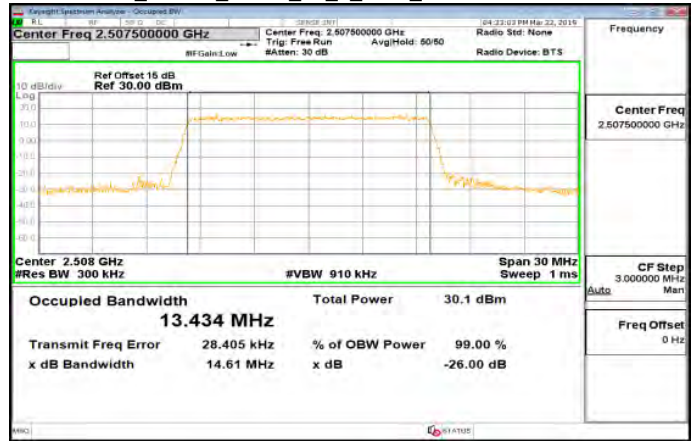

Band7_10MHz_64QAM_50_0_Main_MidCH21100-2535

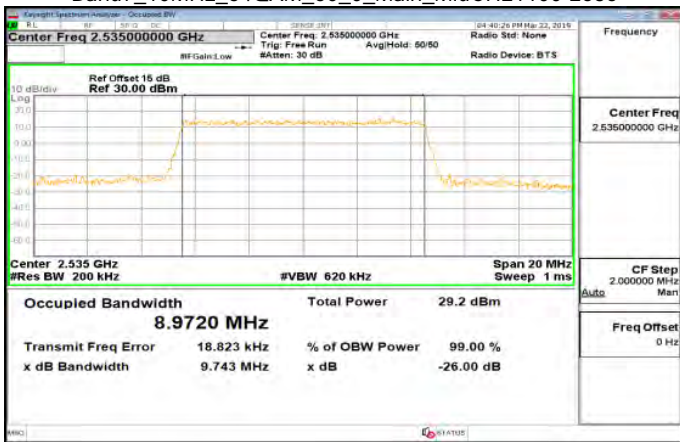

Band7_15MHz_QPSK_75_0_Main_MidCH21100-2535

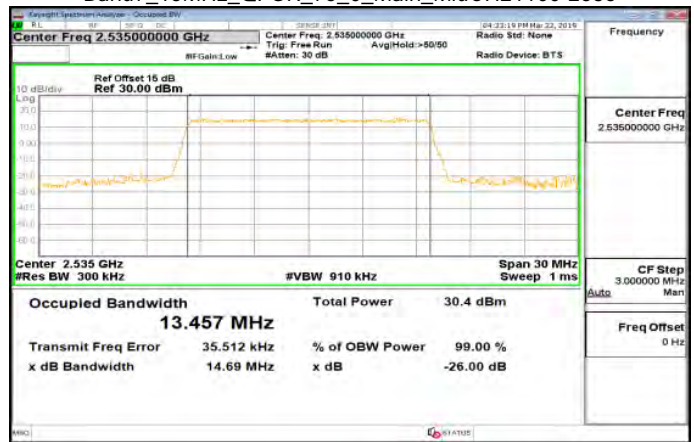

Band7_10MHz_64QAM_50_0_Main_HighCH21400-2565

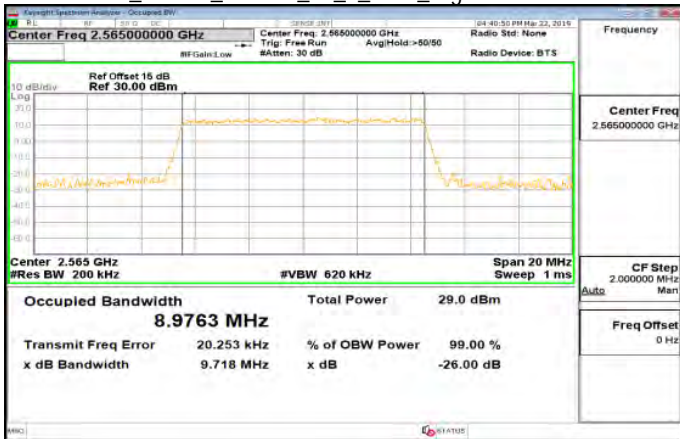

Band7_15MHz_QPSK_75_0_Main_HighCH21375-2562.5

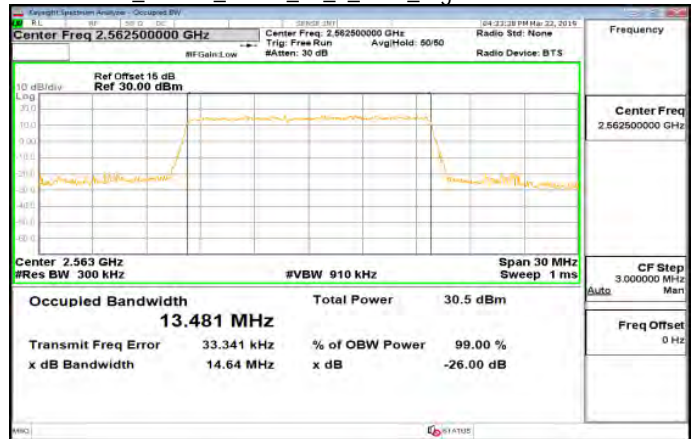

Unless otherwise stated the results shown in this test report refer only to the sample(s) tested and such sample(s) are retained for 90 days only.

除非另有說明，此報告結果僅對測試之樣品負責，同時此樣品僅保留90天。本報告未經本公司書面許可，不可部份複製。

This document is issued by the Company subject to its General Conditions of Service printed overleaf, available on request or accessible at www.sgs.com/terms_and_conditions.htm and for electronic format documents, subject to Terms and Conditions for Electronic Documents at www.sgs.com/terms_e-document.htm. Attention is drawn to the limitation of liability, indemnification and jurisdiction issues defined therein. Any holder of this document is advised that information contained hereon reflects the Company's findings at the time of its intervention only and within the limits of Client's instructions, if any. The Company's sole responsibility is to its Client and this document does not exonerate parties to a transaction from exercising all their rights and obligations under the transaction documents. This document cannot be reproduced except in full, without prior written approval of the Company. Any unauthorized alteration, forgery or falsification of the content or appearance of this document is unlawful and offenders may be prosecuted to the fullest extent of the law.

Band7_15MHz_16QAM_75_0_Main_LowCH20825-2507.5

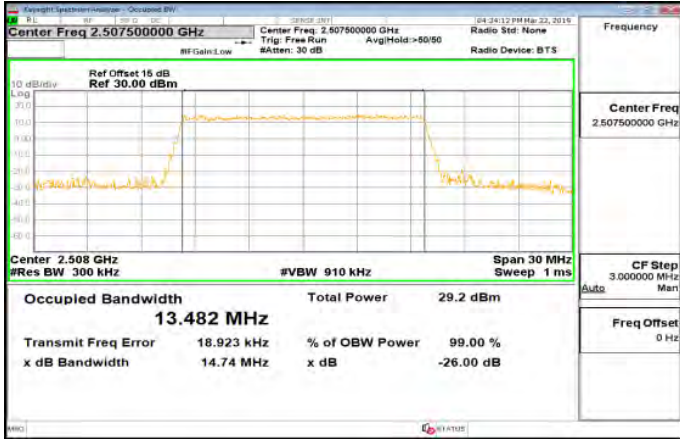

Band7_15MHz_64QAM_75_0_Main_LowCH20825-2507.5

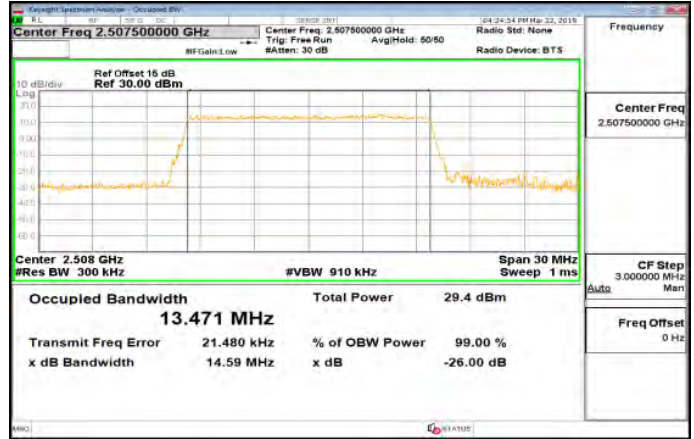

Band7_15MHz_16QAM_75_0_Main_MidCH21100-2535

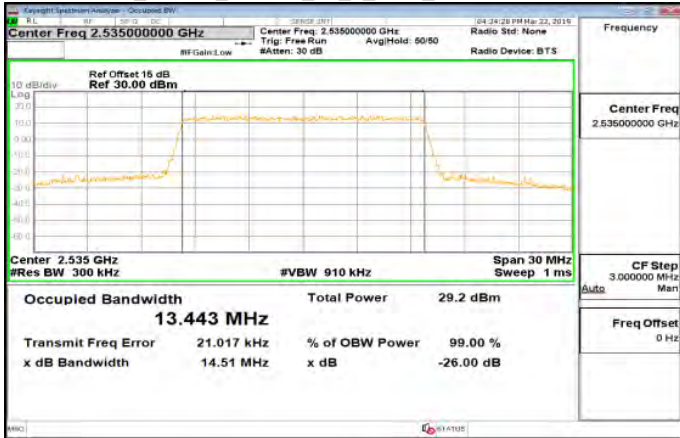

Band7_15MHz_64QAM_75_0_Main_MidCH21100-2535

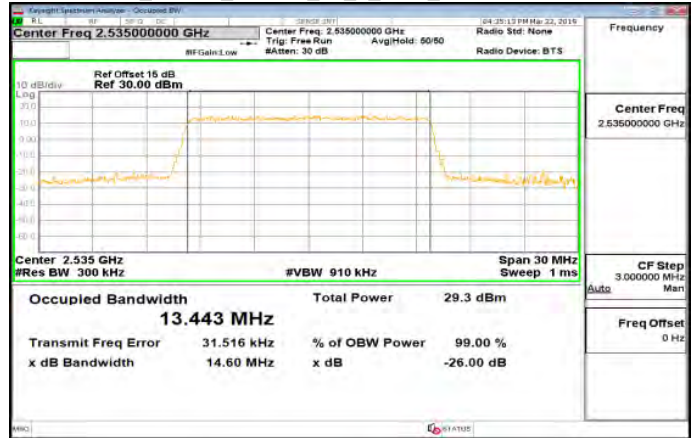

Band7_15MHz_16QAM_75_0_Main_HighCH21375-2562.5

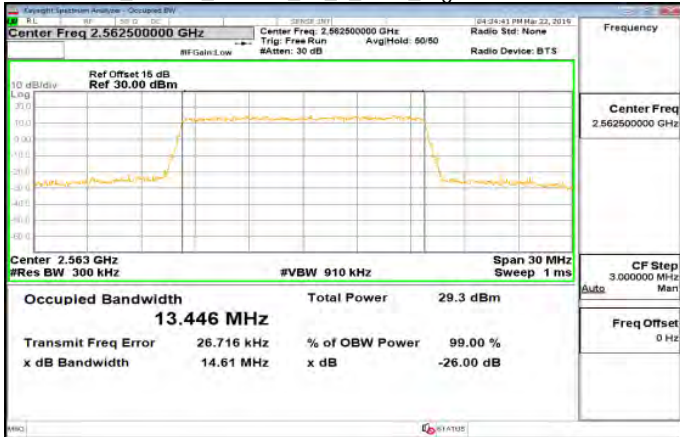

Band7_15MHz_64QAM_75_0_Main_HighCH21375-2562.5

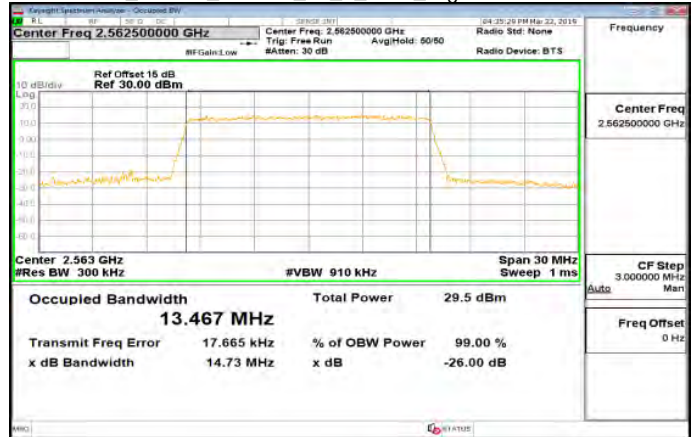

Unless otherwise stated the results shown in this test report refer only to the sample(s) tested and such sample(s) are retained for 90 days only.

除非另有說明，此報告結果僅對測試之樣品負責，同時此樣品僅保留90天。本報告未經本公司書面許可，不可部份複製。

This document is issued by the Company subject to its General Conditions of Service printed overleaf, available on request or accessible at www.sgs.com/terms_and_conditions.htm and for electronic format documents, subject to Terms and Conditions for Electronic Documents at www.sgs.com/terms_e-document.htm. Attention is drawn to the limitation of liability, indemnification and jurisdiction issues defined therein. Any holder of this document is advised that information contained hereon reflects the Company's findings at the time of its intervention only and within the limits of Client's instructions, if any. The Company's sole responsibility is to its Client and this document does not exonerate parties to a transaction from exercising all their rights and obligations under the transaction documents. This document cannot be reproduced except in full, without prior written approval of the Company. Any unauthorized alteration, forgery or falsification of the content or appearance of this document is unlawful and offenders may be prosecuted to the fullest extent of the law.

Band7_20MHz_QPSK_100_0_Main_LowCH20850-2510

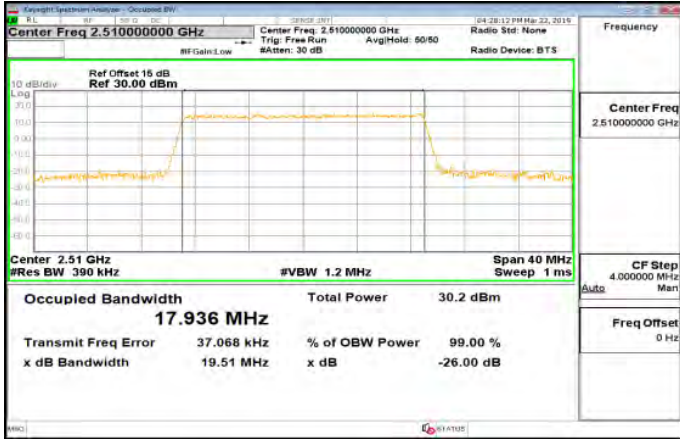

Band7_20MHz_16QAM_100_0_Main_LowCH20850-2510

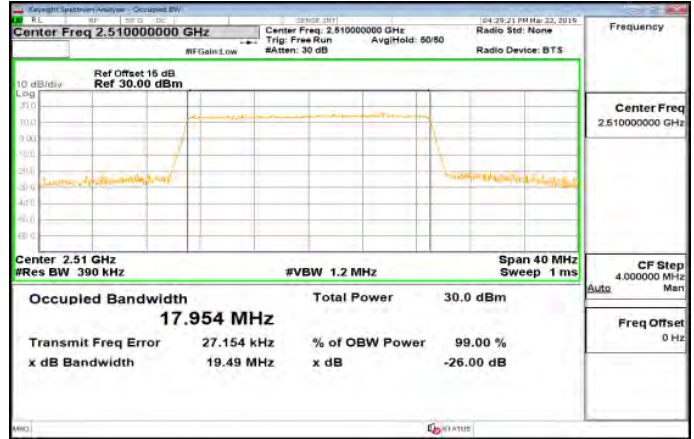

Band7_20MHz_QPSK_100_0_Main_MidCH21100-2535

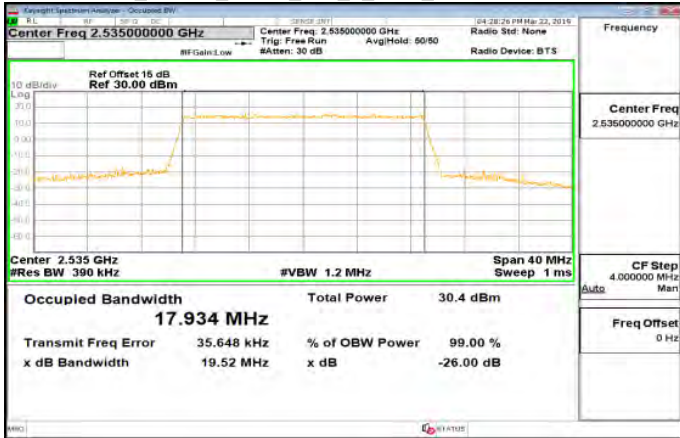

Band7_20MHz_16QAM_100_0_Main_MidCH21100-2535

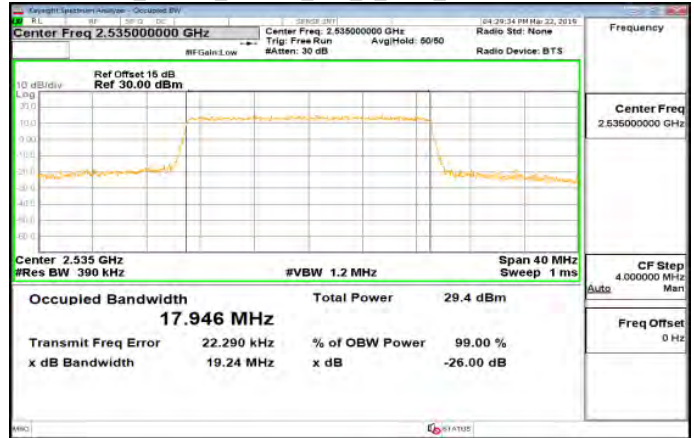

Band7_20MHz_QPSK_100_0_Main_HighCH21350-2560

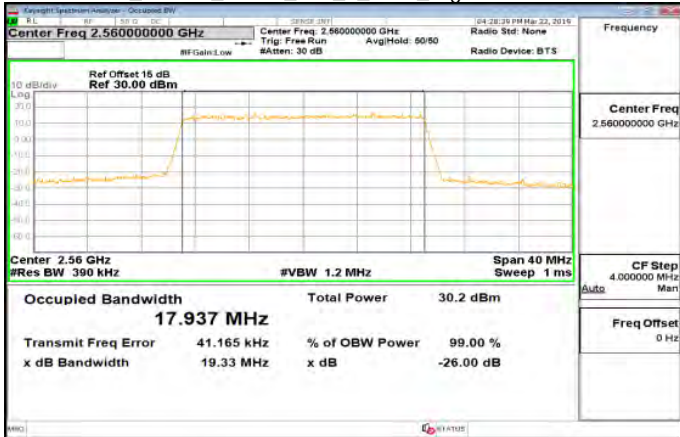

Band7_20MHz_16QAM_100_0_Main_HighCH21350-2560

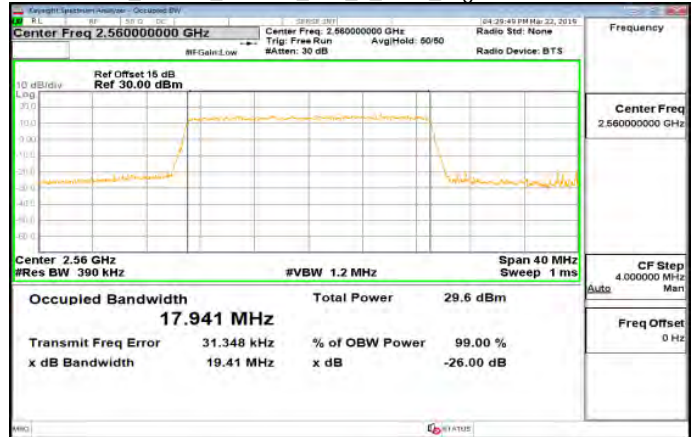

Unless otherwise stated the results shown in this test report refer only to the sample(s) tested and such sample(s) are retained for 90 days only.

除非另有說明，此報告結果僅對測試之樣品負責，同時此樣品僅保留90天。本報告未經本公司書面許可，不可部份複製。

This document is issued by the Company subject to its General Conditions of Service printed overleaf, available on request or accessible at www.sgs.com/terms_and_conditions.htm and for electronic format documents, subject to Terms and Conditions for Electronic Documents at www.sgs.com/terms_e-document.htm. Attention is drawn to the limitation of liability, indemnification and jurisdiction issues defined therein. Any holder of this document is advised that information contained hereon reflects the Company's findings at the time of its intervention only and within the limits of Client's instructions, if any. The Company's sole responsibility is to its Client and this document does not exonerate parties to a transaction from exercising all their rights and obligations under the transaction documents. This document cannot be reproduced except in full, without prior written approval of the Company. Any unauthorized alteration, forgery or falsification of the content or appearance of this document is unlawful and offenders may be prosecuted to the fullest extent of the law.

Band7_20MHz_64QAM_100_0_Main_LowCH20850-2510

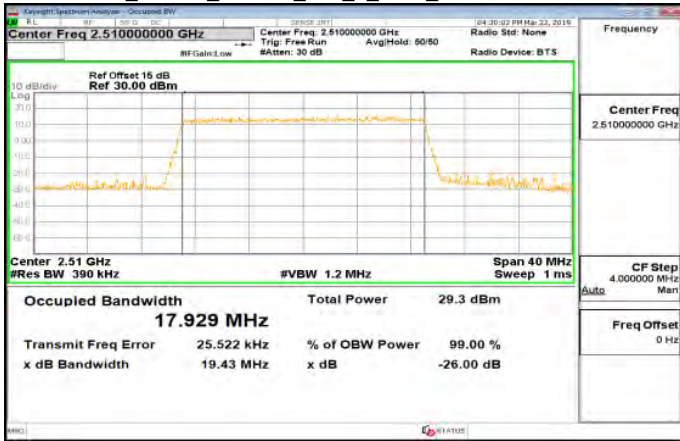

Band12_1_4MHz_QPSK_6_0_Main_LowCH23017-699.7

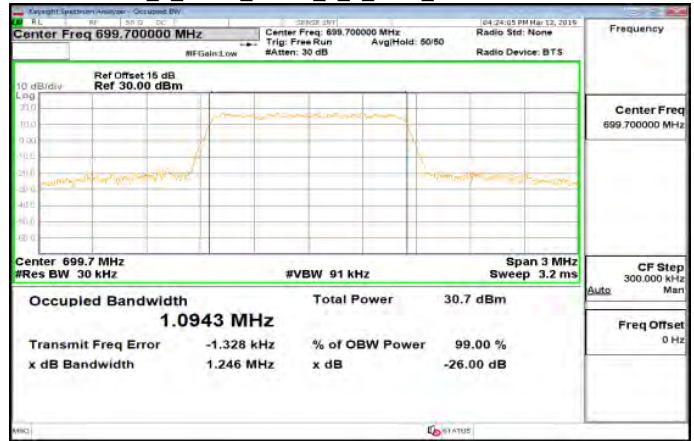

Band7_20MHz_64QAM_100_0_Main_MidCH21100-2535

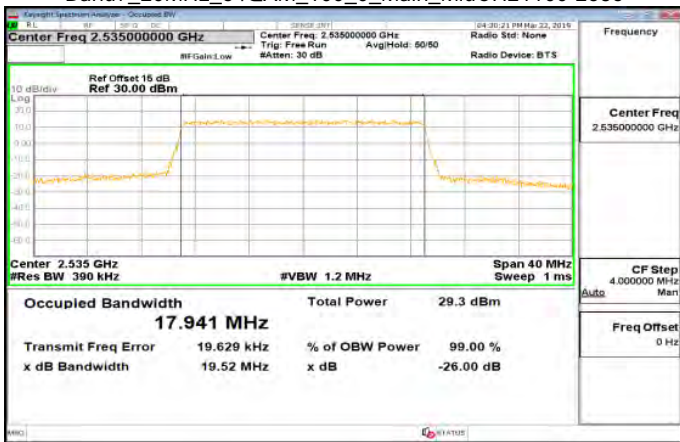

Band12_1_4MHz_QPSK_6_0_Main_MidCH23095-707.5

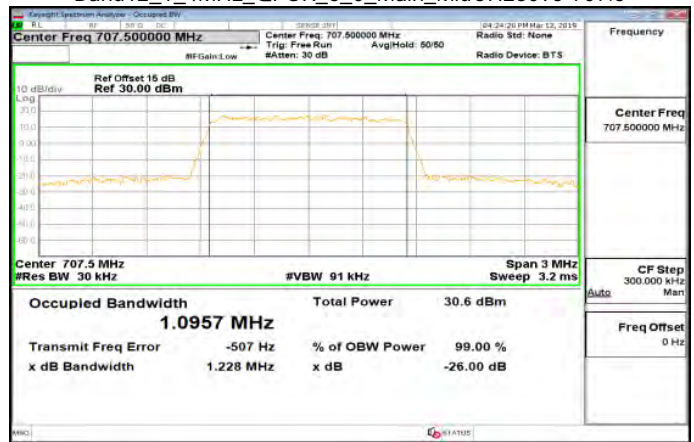

Band7_20MHz_64QAM_100_0_Main_HighCH21350-2560

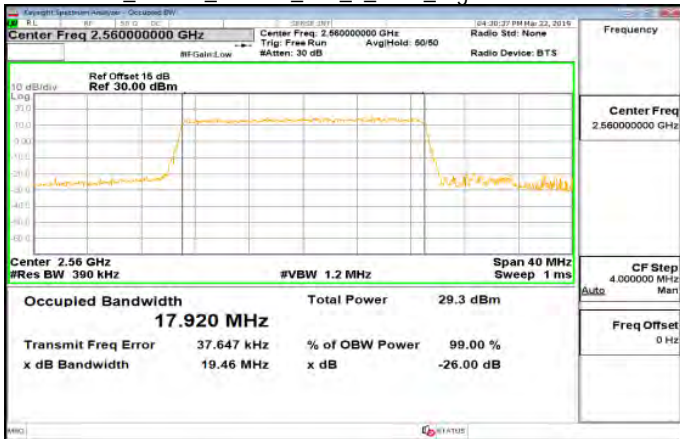

Band12_1_4MHz_QPSK_6_0_Main_HighCH23173-715.3

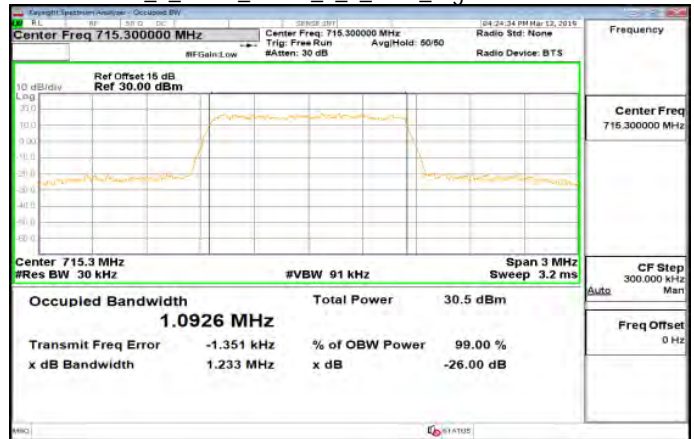

Unless otherwise stated the results shown in this test report refer only to the sample(s) tested and such sample(s) are retained for 90 days only.

除非另有說明，此報告結果僅對測試之樣品負責，同時此樣品僅保留90天。本報告未經本公司書面許可，不可部份複製。

This document is issued by the Company subject to its General Conditions of Service printed overleaf, available on request or accessible at www.sgs.com/terms_and_conditions.htm and for electronic format documents, subject to Terms and Conditions for Electronic Documents at www.sgs.com/terms_e-document.htm. Attention is drawn to the limitation of liability, indemnification and jurisdiction issues defined therein. Any holder of this document is advised that information contained hereon reflects the Company's findings at the time of its intervention only and within the limits of Client's instructions, if any. The Company's sole responsibility is to its Client and this document does not exonerate parties to a transaction from exercising all their rights and obligations under the transaction documents. This document cannot be reproduced except in full, without prior written approval of the Company. Any unauthorized alteration, forgery or falsification of the content or appearance of this document is unlawful and offenders may be prosecuted to the fullest extent of the law.

Band12_1_4MHz_16QAM_6_0_Main_LowCH23017-699.7

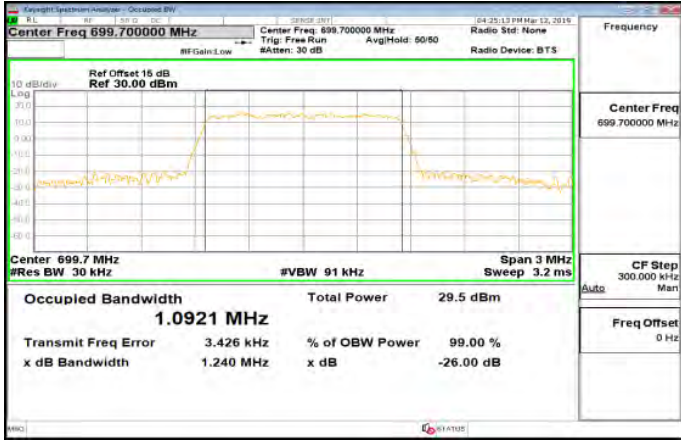

Band12_1_4MHz_64QAM_6_0_Main_LowCH23017-699.7

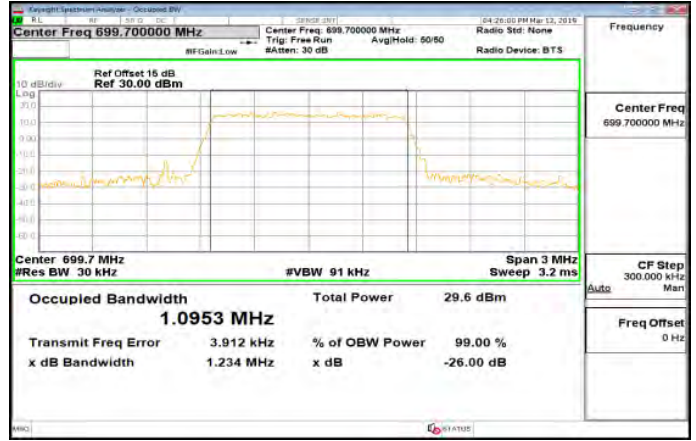

Band12_1_4MHz_16QAM_6_0_Main_MidCH23095-707.5

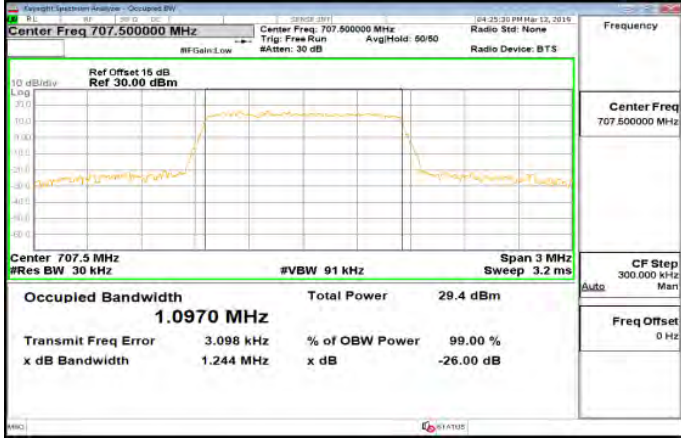

Band12_1_4MHz_64QAM_6_0_Main_MidCH23095-707.5

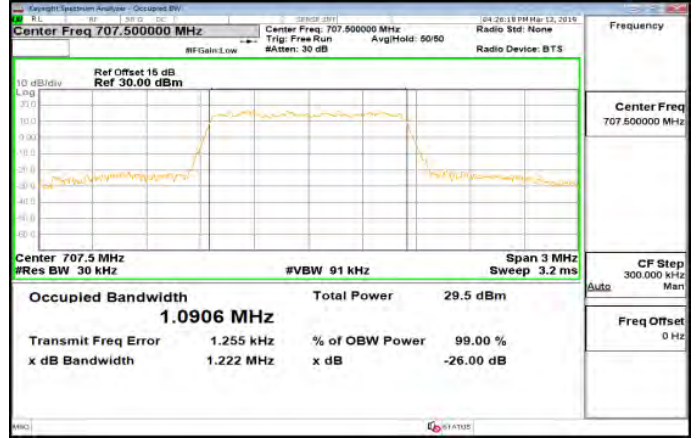

Band12_1_4MHz_16QAM_6_0_Main_HighCH23173-715.3

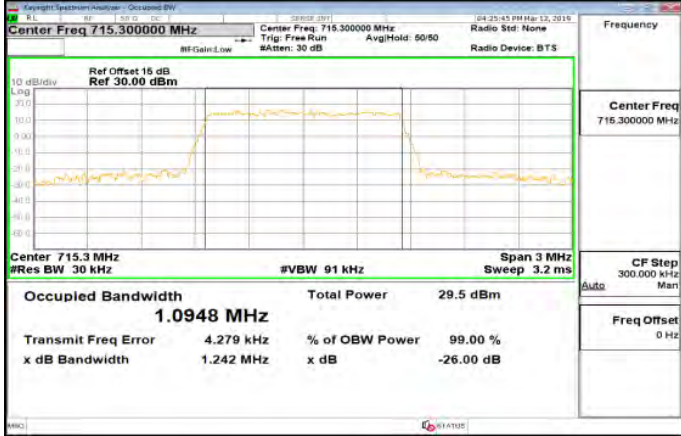

Band12_1_4MHz_64QAM_6_0_Main_HighCH23173-715.3

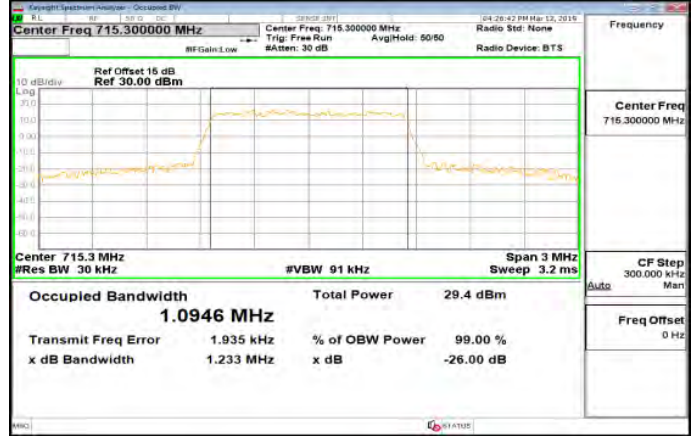

Unless otherwise stated the results shown in this test report refer only to the sample(s) tested and such sample(s) are retained for 90 days only.

除非另有說明，此報告結果僅對測試之樣品負責，同時此樣品僅保留90天。本報告未經本公司書面許可，不可部份複製。

This document is issued by the Company subject to its General Conditions of Service printed overleaf, available on request or accessible at www.sgs.com/terms_and_conditions.htm and for electronic format documents, subject to Terms and Conditions for Electronic Documents at www.sgs.com/terms_e-document.htm. Attention is drawn to the limitation of liability, indemnification and jurisdiction issues defined therein. Any holder of this document is advised that information contained hereon reflects the Company's findings at the time of its intervention only and within the limits of Client's instructions, if any. The Company's sole responsibility is to its Client and this document does not exonerate parties to a transaction from exercising all their rights and obligations under the transaction documents. This document cannot be reproduced except in full, without prior written approval of the Company. Any unauthorized alteration, forgery or falsification of the content or appearance of this document is unlawful and offenders may be prosecuted to the fullest extent of the law.

Band12_3MHz_OPSK_15_0_Main_LowCH23025-700.5

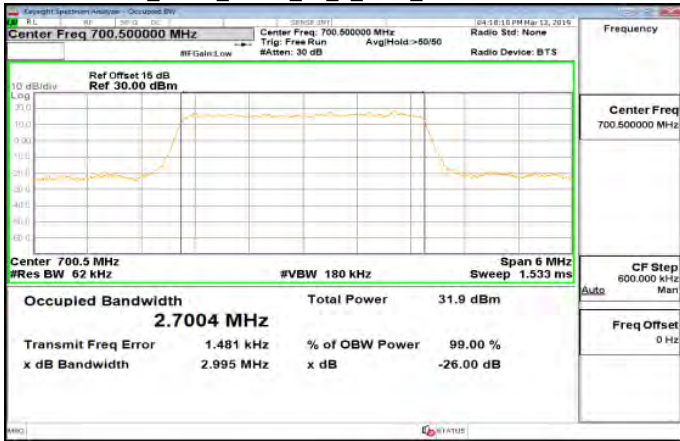

Band12_3MHz_16QAM_15_0_Main_LowCH23025-700.5

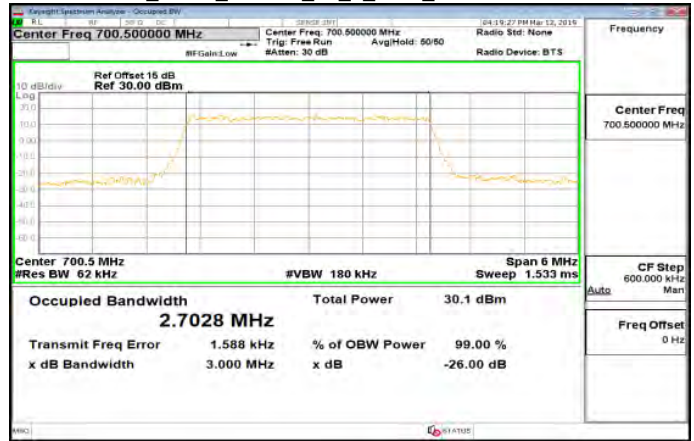

Band12_3MHz_OPSK_15_0_Main_MidCH23095-707.5

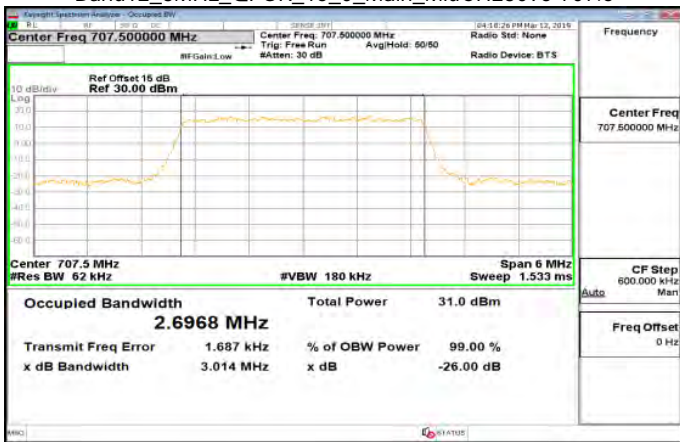

Band12_3MHz_16QAM_15_0_Main_MidCH23095-707.5

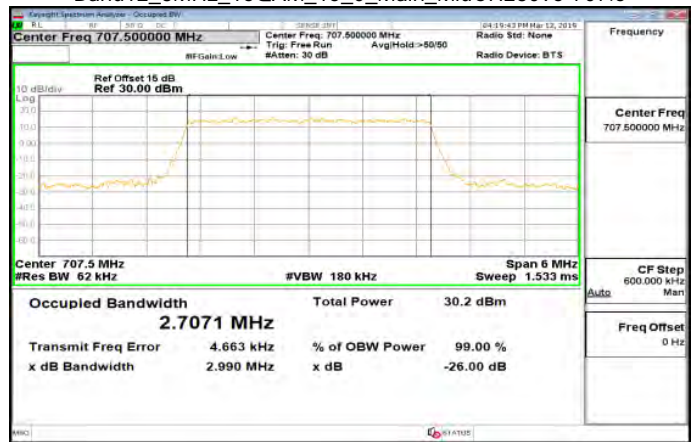

Band12_3MHz_OPSK_15_0_Main_HighCH23165-714.5

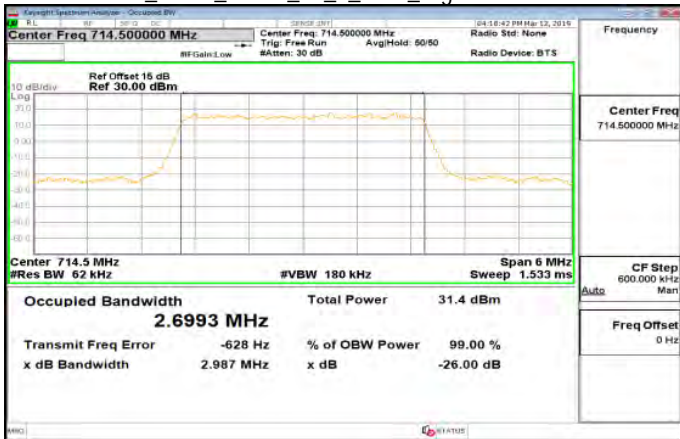

Band12_3MHz_16QAM_15_0_Main_HighCH23165-714.5

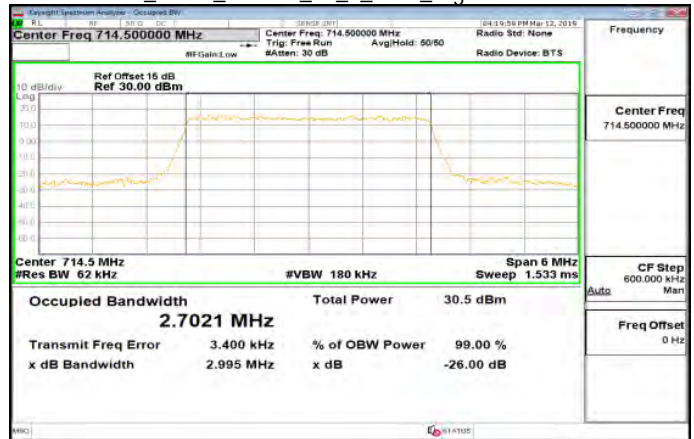

Unless otherwise stated the results shown in this test report refer only to the sample(s) tested and such sample(s) are retained for 90 days only.

除非另有說明，此報告結果僅對測試之樣品負責，同時此樣品僅保留90天。本報告未經本公司書面許可，不可部份複製。

This document is issued by the Company subject to its General Conditions of Service printed overleaf, available on request or accessible at www.sgs.com/terms_and_conditions.htm and for electronic format documents, subject to Terms and Conditions for Electronic Documents at www.sgs.com/terms_e-document.htm. Attention is drawn to the limitation of liability, indemnification and jurisdiction issues defined therein. Any holder of this document is advised that information contained hereon reflects the Company's findings at the time of its intervention only and within the limits of Client's instructions, if any. The Company's sole responsibility is to its Client and this document does not exonerate parties to a transaction from exercising all their rights and obligations under the transaction documents. This document cannot be reproduced except in full, without prior written approval of the Company. Any unauthorized alteration, forgery or falsification of the content or appearance of this document is unlawful and offenders may be prosecuted to the fullest extent of the law.

Band12_3MHz_64QAM_15_0_Main_LowCH23025-700.5

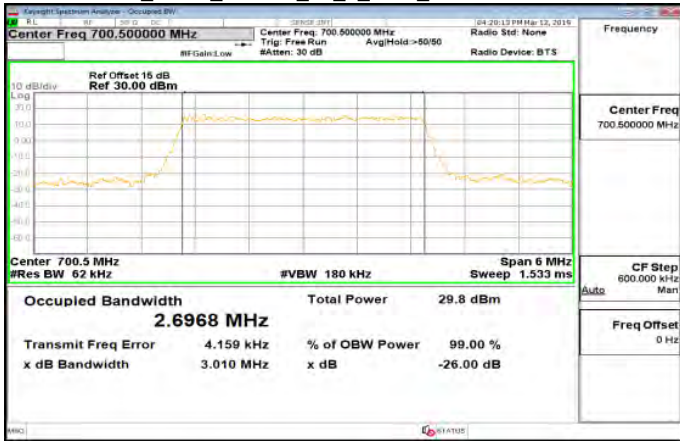

Band12_5MHz_QPSK_25_0_Main_LowCH23035-701.5

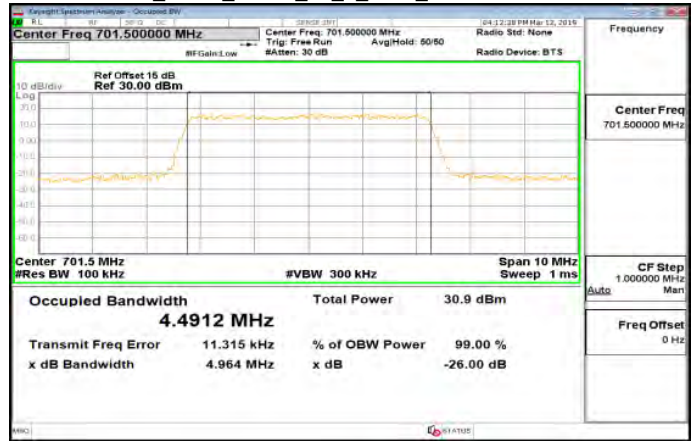

Band12_3MHz_64QAM_15_0_Main_MidCH23095-707.5

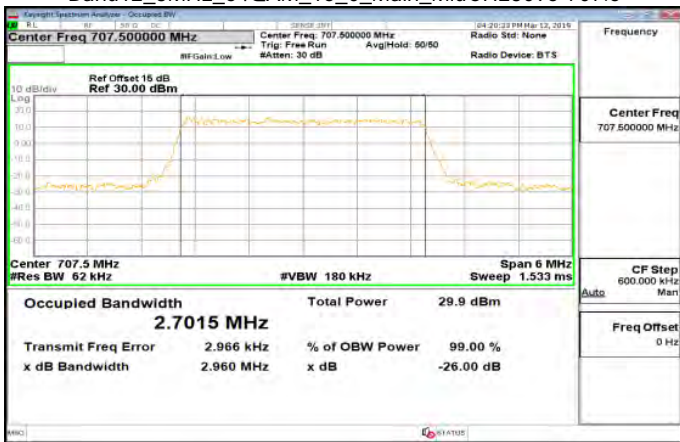

Band12_5MHz_QPSK_25_0_Main_MidCH23095-707.5

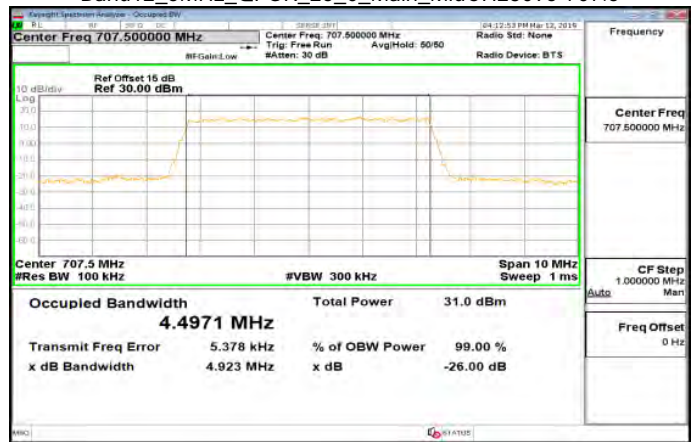

Band12_3MHz_64QAM_15_0_Main_HighCH23165-714.5

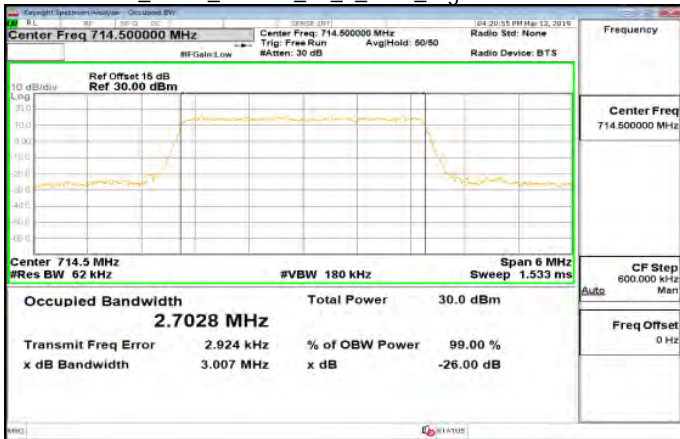

Band12_5MHz_QPSK_25_0_Main_HighCH23155-713.5

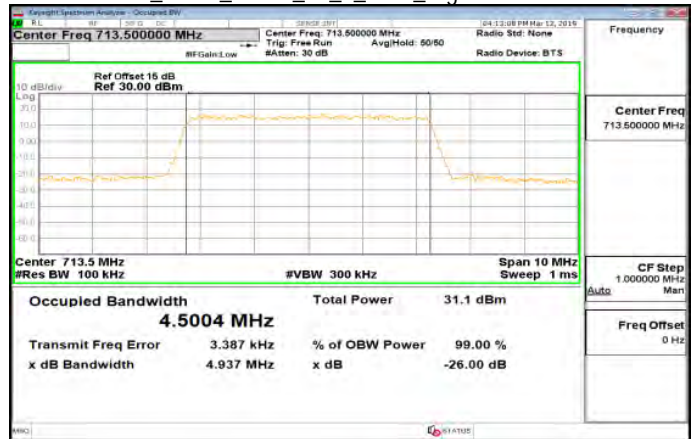

Unless otherwise stated the results shown in this test report refer only to the sample(s) tested and such sample(s) are retained for 90 days only.

除非另有說明，此報告結果僅對測試之樣品負責，同時此樣品僅保留90天。本報告未經本公司書面許可，不可部份複製。

This document is issued by the Company subject to its General Conditions of Service printed overleaf, available on request or accessible at www.sgs.com/terms_and_conditions.htm and for electronic format documents, subject to Terms and Conditions for Electronic Documents at www.sgs.com/terms_e-document.htm. Attention is drawn to the limitation of liability, indemnification and jurisdiction issues defined therein. Any holder of this document is advised that information contained hereon reflects the Company's findings at the time of its intervention only and within the limits of Client's instructions, if any. The Company's sole responsibility is to its Client and this document does not exonerate parties to a transaction from exercising all their rights and obligations under the transaction documents. This document cannot be reproduced except in full, without prior written approval of the Company. Any unauthorized alteration, forgery or falsification of the content or appearance of this document is unlawful and offenders may be prosecuted to the fullest extent of the law.

Band12_5MHz_16QAM_25_0_Main_LowCH23035-701.5

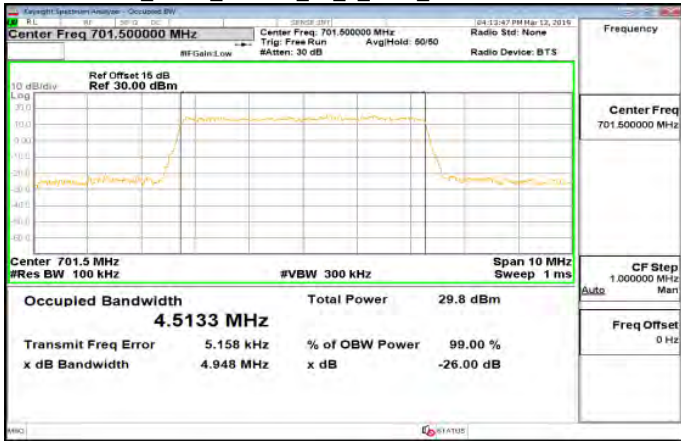

Band12_5MHz_64QAM_25_0_Main_LowCH23035-701.5

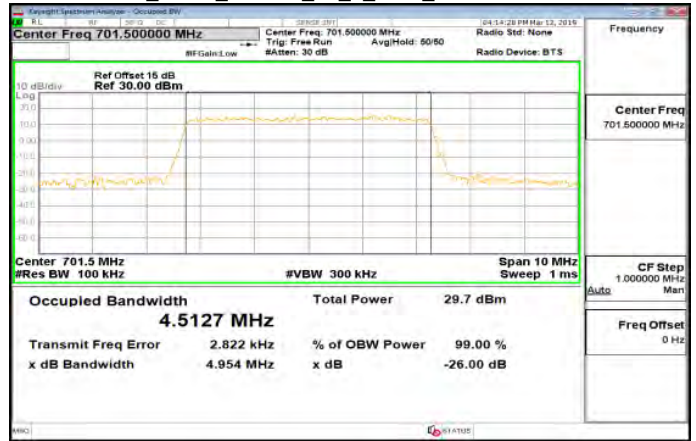

Band12_5MHz_16QAM_25_0_Main_MidCH23095-707.5

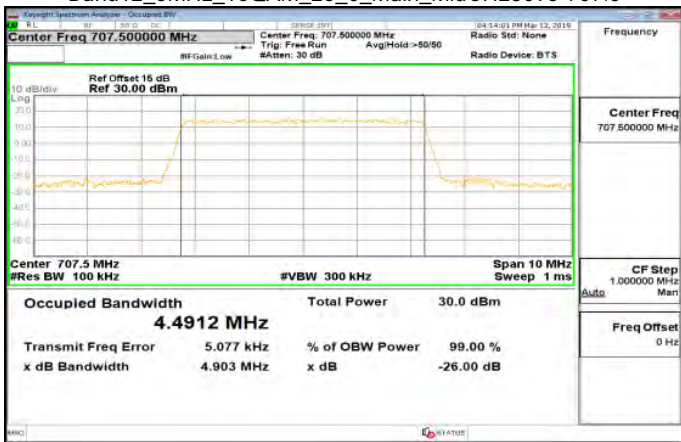

Band12_5MHz_64QAM_25_0_Main_MidCH23095-707.5

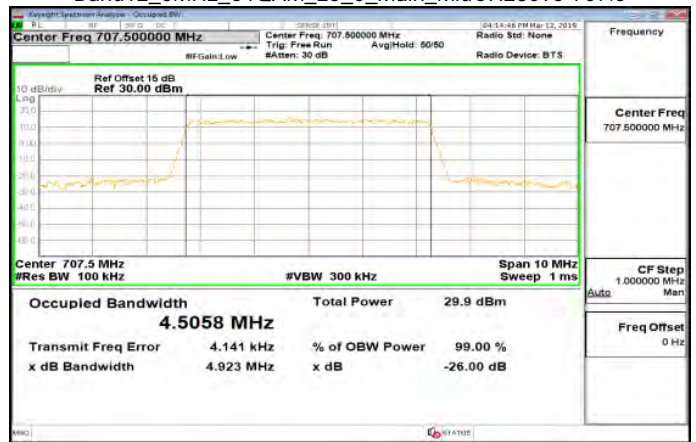

Band12_5MHz_16QAM_25_0_Main_HighCH23155-713.5

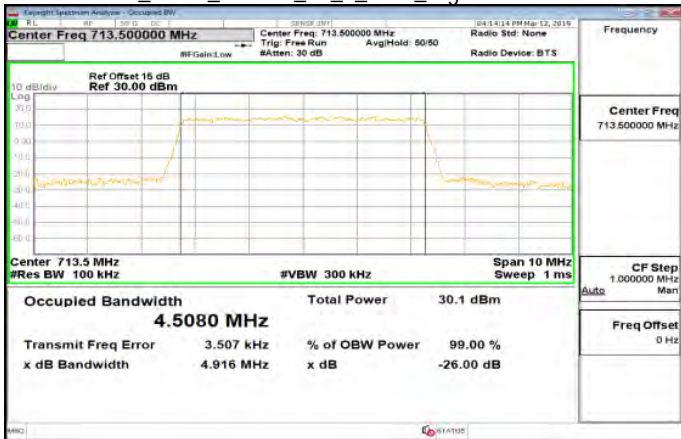

Band12_5MHz_64QAM_25_0_Main_HighCH23155-713.5

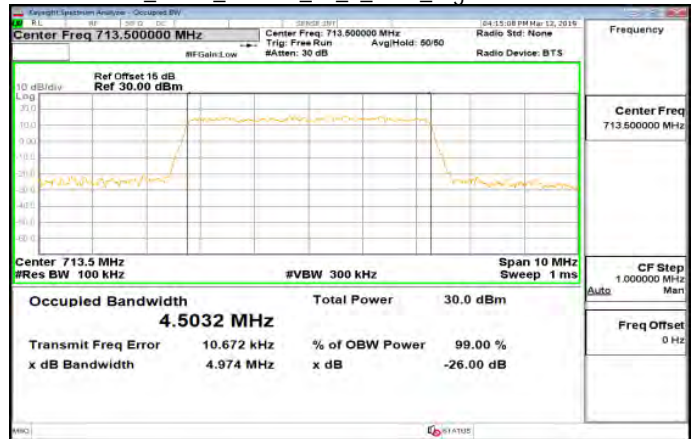

Unless otherwise stated the results shown in this test report refer only to the sample(s) tested and such sample(s) are retained for 90 days only.

除非另有說明，此報告結果僅對測試之樣品負責，同時此樣品僅保留90天。本報告未經本公司書面許可，不可部份複製。

This document is issued by the Company subject to its General Conditions of Service printed overleaf, available on request or accessible at www.sgs.com/terms_and_conditions.htm and for electronic format documents, subject to Terms and Conditions for Electronic Documents at www.sgs.com/terms_e-document.htm. Attention is drawn to the limitation of liability, indemnification and jurisdiction issues defined therein. Any holder of this document is advised that information contained hereon reflects the Company's findings at the time of its intervention only and within the limits of Client's instructions, if any. The Company's sole responsibility is to its Client and this document does not exonerate parties to a transaction from exercising all their rights and obligations under the transaction documents. This document cannot be reproduced except in full, without prior written approval of the Company. Any unauthorized alteration, forgery or falsification of the content or appearance of this document is unlawful and offenders may be prosecuted to the fullest extent of the law.

Band12_10MHz_QPSK_50_0_Main_LowCH23060-704

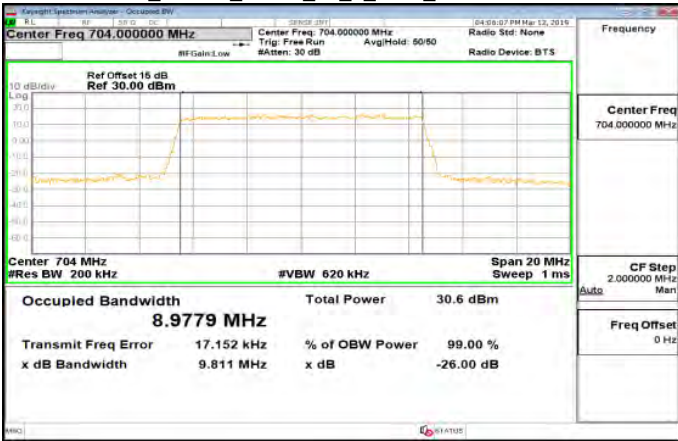

Band12_10MHz_16QAM_50_0_Main_LowCH23060-704

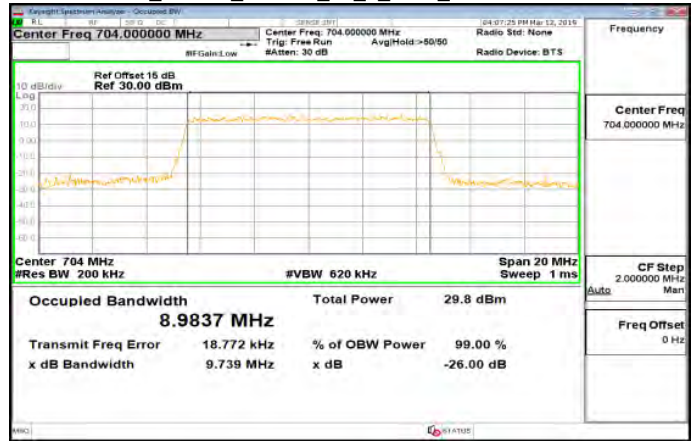

Band12_10MHz_QPSK_50_0_Main_MidCH23095-707.5

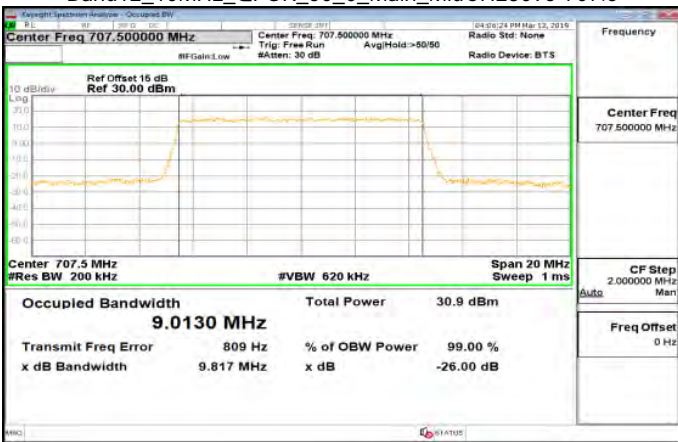

Band12_10MHz_16QAM_50_0_Main_MidCH23095-707.5

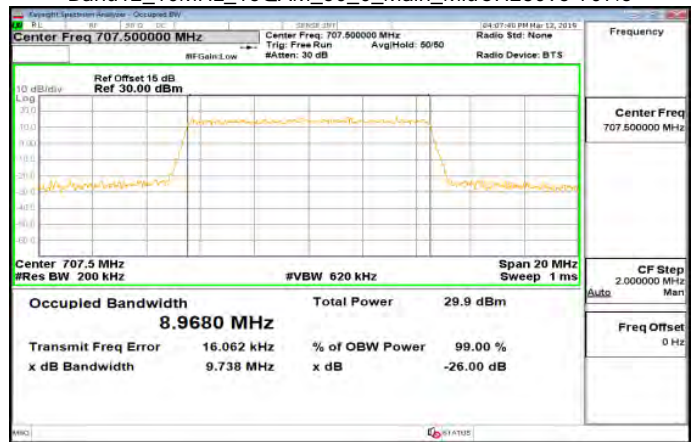

Band12_10MHz_QPSK_50_0_Main_HighCH23130-711

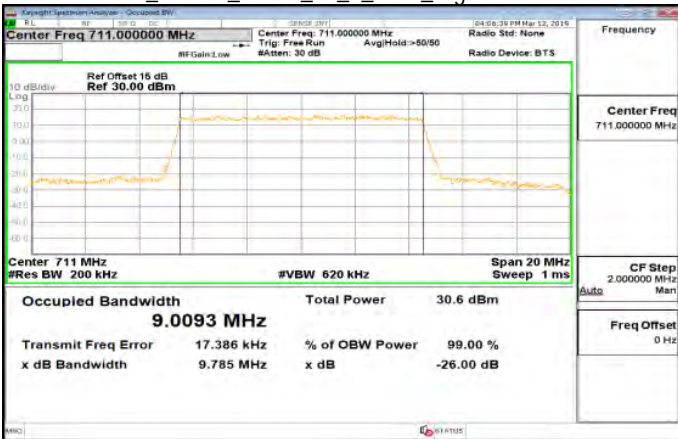

Band12_10MHz_16QAM_50_0_Main_HighCH23130-711

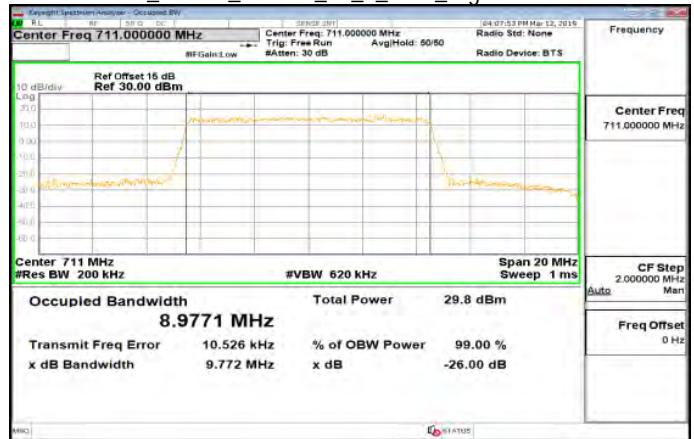

Unless otherwise stated the results shown in this test report refer only to the sample(s) tested and such sample(s) are retained for 90 days only.

除非另有說明，此報告結果僅對測試之樣品負責，同時此樣品僅保留90天。本報告未經本公司書面許可，不可部份複製。

This document is issued by the Company subject to its General Conditions of Service printed overleaf, available on request or accessible at www.sgs.com/terms_and_conditions.htm and for electronic format documents, subject to Terms and Conditions for Electronic Documents at www.sgs.com/terms_e-document.htm. Attention is drawn to the limitation of liability, indemnification and jurisdiction issues defined therein. Any holder of this document is advised that information contained hereon reflects the Company's findings at the time of its intervention only and within the limits of Client's instructions, if any. The Company's sole responsibility is to its Client and this document does not exonerate parties to a transaction from exercising all their rights and obligations under the transaction documents. This document cannot be reproduced except in full, without prior written approval of the Company. Any unauthorized alteration, forgery or falsification of the content or appearance of this document is unlawful and offenders may be prosecuted to the fullest extent of the law.

Band12_10MHz_64QAM_50_0_Main_LowCH23060-704

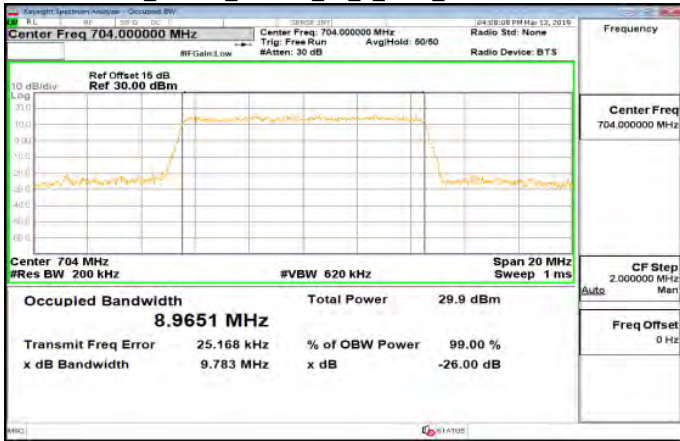

Band13_5MHz_QPSK_25_0_Main_LowCH23205-779.5

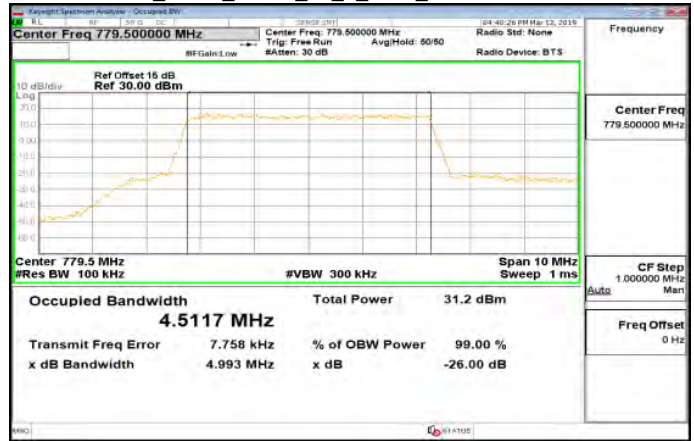

Band12_10MHz_64QAM_50_0_Main_MidCH23095-707.5

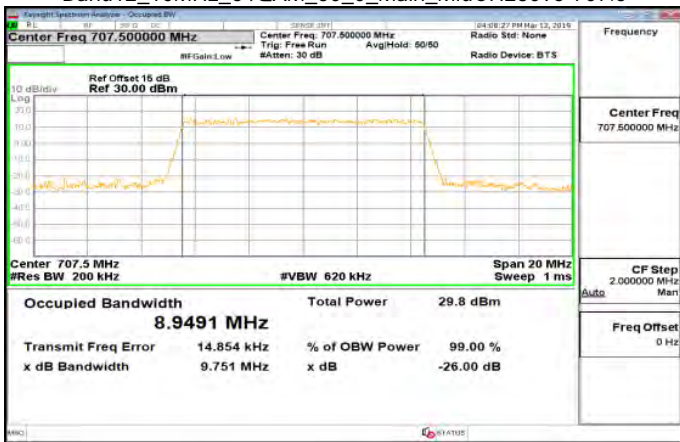

Band13_5MHz_QPSK_25_0_Main_MidCH23230-782

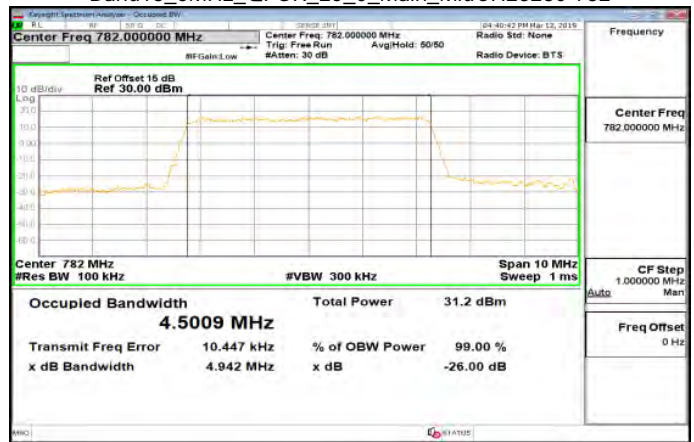

Band12_10MHz_64QAM_50_0_Main_HighCH23130-711

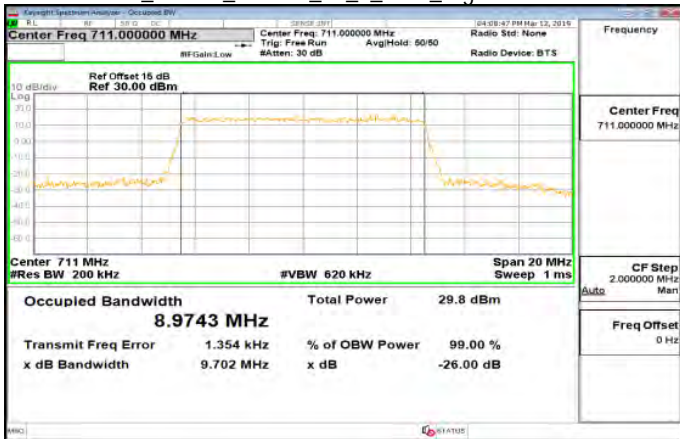

Band13_5MHz_QPSK_25_0_Main_HighCH23255-784.5

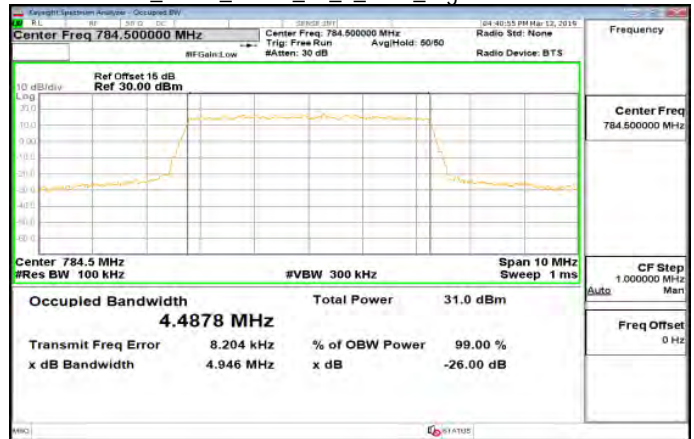

Unless otherwise stated the results shown in this test report refer only to the sample(s) tested and such sample(s) are retained for 90 days only.

除非另有說明，此報告結果僅對測試之樣品負責，同時此樣品僅保留90天。本報告未經本公司書面許可，不可部份複製。

This document is issued by the Company subject to its General Conditions of Service printed overleaf, available on request or accessible at www.sgs.com/terms_and_conditions.htm and for electronic format documents, subject to Terms and Conditions for Electronic Documents at www.sgs.com/terms_e-document.htm. Attention is drawn to the limitation of liability, indemnification and jurisdiction issues defined therein. Any holder of this document is advised that information contained hereon reflects the Company's findings at the time of its intervention only and within the limits of Client's instructions, if any. The Company's sole responsibility is to its Client and this document does not exonerate parties to a transaction from exercising all their rights and obligations under the transaction documents. This document cannot be reproduced except in full, without prior written approval of the Company. Any unauthorized alteration, forgery or falsification of the content or appearance of this document is unlawful and offenders may be prosecuted to the fullest extent of the law.

Band13_5MHz_16QAM_25_0_Main_LowCH23205-779.5

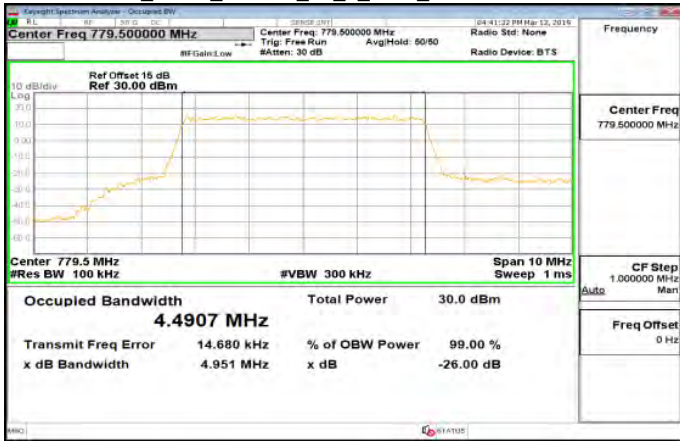

Band13_5MHz_64QAM_25_0_Main_LowCH23205-779.5

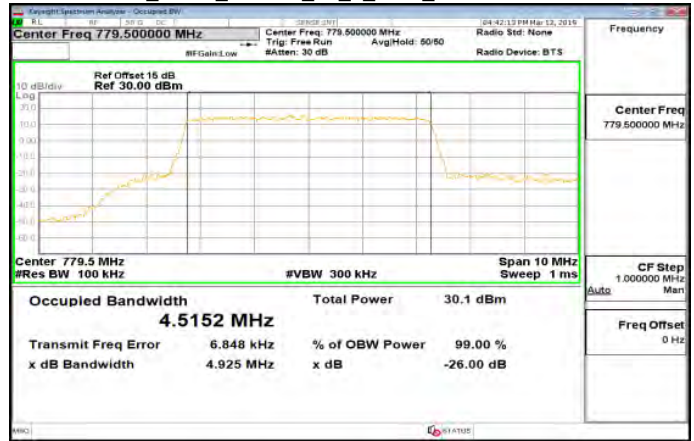

Band13_5MHz_16QAM_25_0_Main_MidCH23230-782

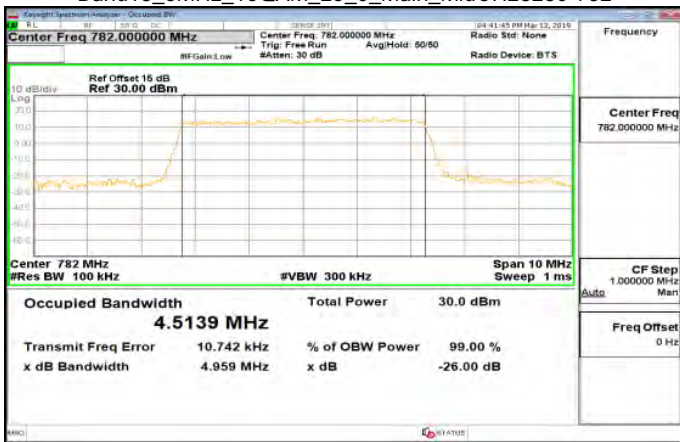

Band13_5MHz_64QAM_25_0_Main_MidCH23230-782

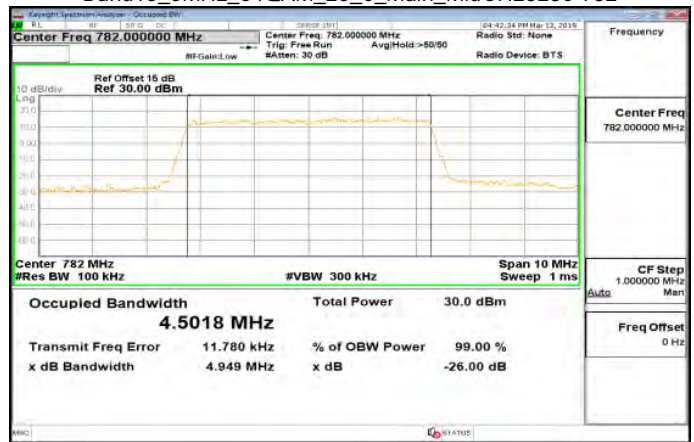

Band13_5MHz_16QAM_25_0_Main_HighCH23255-784.5

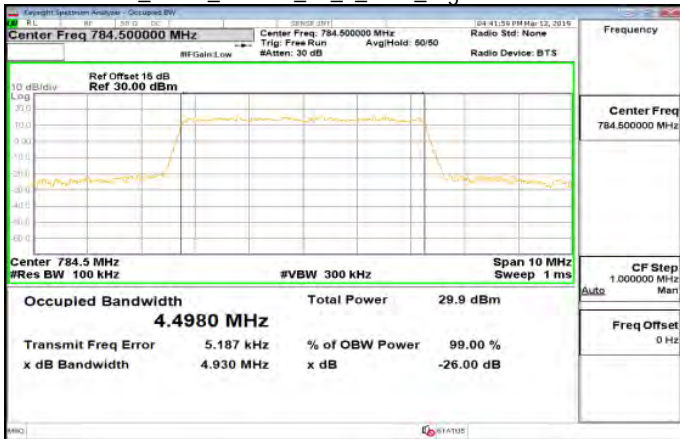

Band13_5MHz_64QAM_25_0_Main_HighCH23255-784.5

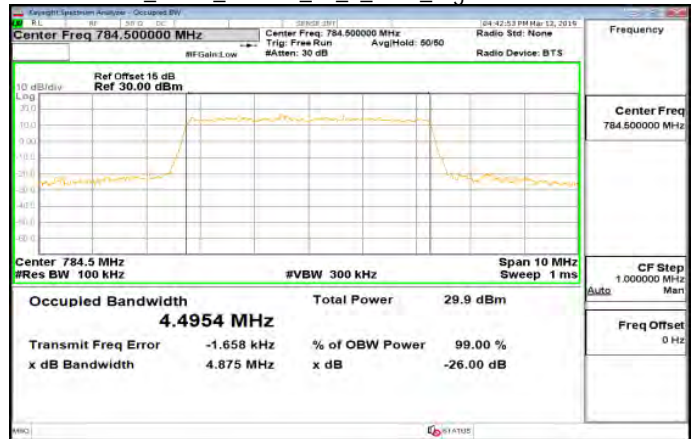

Unless otherwise stated the results shown in this test report refer only to the sample(s) tested and such sample(s) are retained for 90 days only.

除非另有說明，此報告結果僅對測試之樣品負責，同時此樣品僅保留90天。本報告未經本公司書面許可，不可部份複製。

This document is issued by the Company subject to its General Conditions of Service printed overleaf, available on request or accessible at www.sgs.com/terms_and_conditions.htm and for electronic format documents, subject to Terms and Conditions for Electronic Documents at www.sgs.com/terms_e-document.htm. Attention is drawn to the limitation of liability, indemnification and jurisdiction issues defined therein. Any holder of this document is advised that information contained hereon reflects the Company's findings at the time of its intervention only and within the limits of Client's instructions, if any. The Company's sole responsibility is to its Client and this document does not exonerate parties to a transaction from exercising all their rights and obligations under the transaction documents. This document cannot be reproduced except in full, without prior written approval of the Company. Any unauthorized alteration, forgery or falsification of the content or appearance of this document is unlawful and offenders may be prosecuted to the fullest extent of the law.