

30MHz~3GHz\_Band12\_3MHz\_QPSK\_1\_0\_LowCH23025-700.5

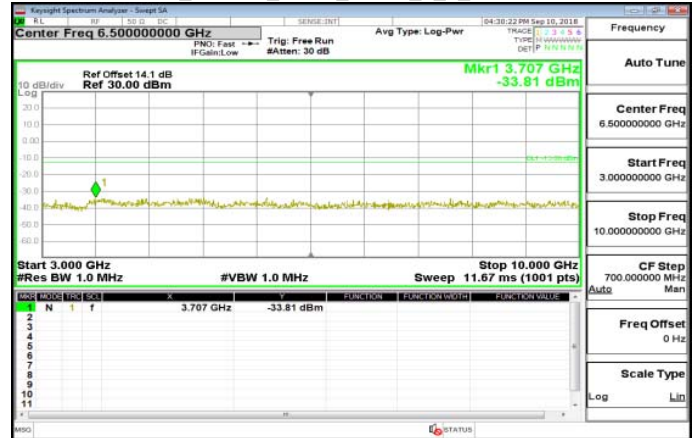

3GHz~10GHz\_Band12\_3MHz\_QPSK\_1\_0\_MidCH23095-707.5



3GHz~10GHz\_Band12\_3MHz\_QPSK\_1\_0\_LowCH23025-700.5

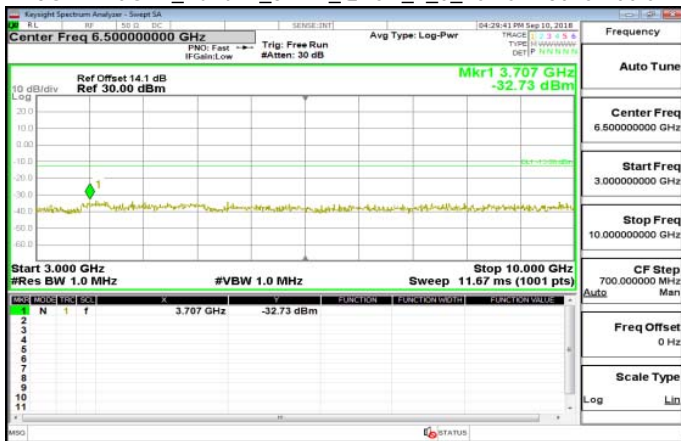

30MHz~3GHz\_Band12\_3MHz\_QPSK\_1\_0\_HighCH23165-714.5

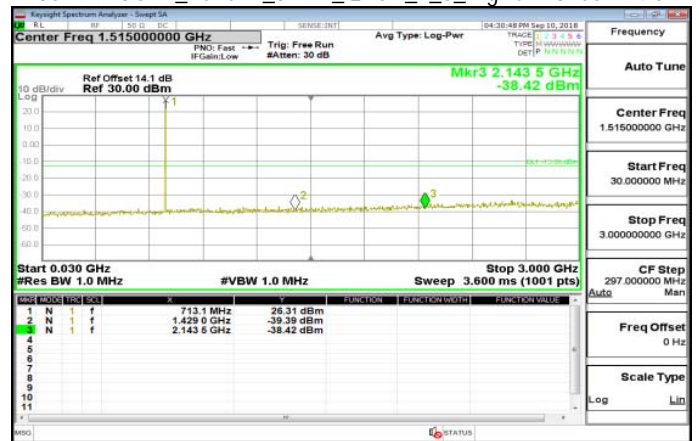

30MHz~3GHz\_Band12\_3MHz\_QPSK\_1\_0\_MidCH23095-707.5

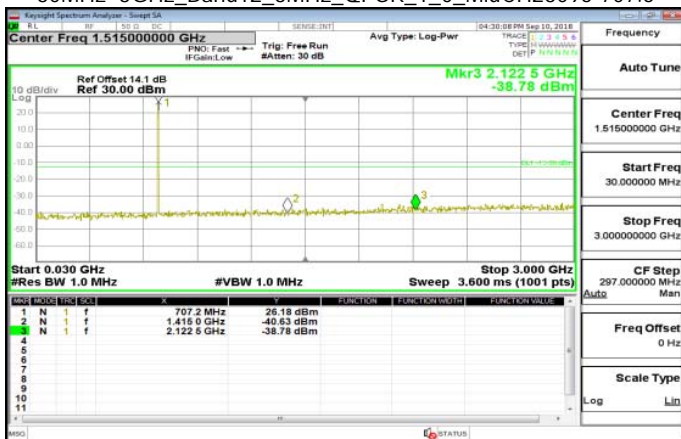

3GHz~10GHz\_Band12\_3MHz\_QPSK\_1\_0\_HighCH23165-714.5

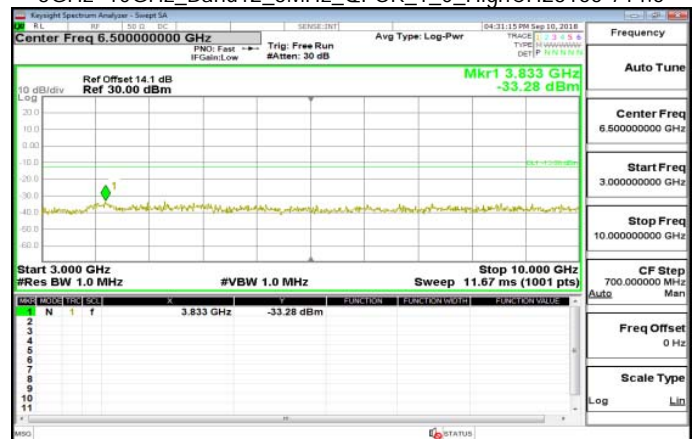

Unless otherwise stated the results shown in this test report refer only to the sample(s) tested and such sample(s) are retained for 90 days only.

除非另有說明，此報告結果僅對測試之樣品負責，同時此樣品僅保留90天。本報告未經本公司書面許可，不可部份複製。

This document is issued by the Company subject to its General Conditions of Service printed overleaf, available on request or accessible at [www.sgs.com/terms\\_and\\_conditions.htm](http://www.sgs.com/terms_and_conditions.htm) and, for electronic format documents, subject to Terms and Conditions for Electronic Documents at [www.sgs.com/terms\\_e-document.htm](http://www.sgs.com/terms_e-document.htm). Attention is drawn to the limitation of liability, indemnification and jurisdiction issues defined therein. Any holder of this document is advised that information contained hereon reflects the Company's findings at the time of its intervention only and within the limits of Client's instructions, if any. The Company's sole responsibility is to its Client and this document does not exonerate parties to a transaction from exercising all their rights and obligations under the transaction documents. This document cannot be reproduced except in full, without prior written approval of the Company. Any unauthorized alteration, forgery or falsification of the content or appearance of this document is unlawful and offenders may be prosecuted to the fullest extent of the law.

30MHz~3GHz\_Band12\_5MHz\_QPSK\_1\_0\_LowCH23035-701.5



3GHz~10GHz\_Band12\_5MHz\_QPSK\_1\_0\_MidCH23095-707.5

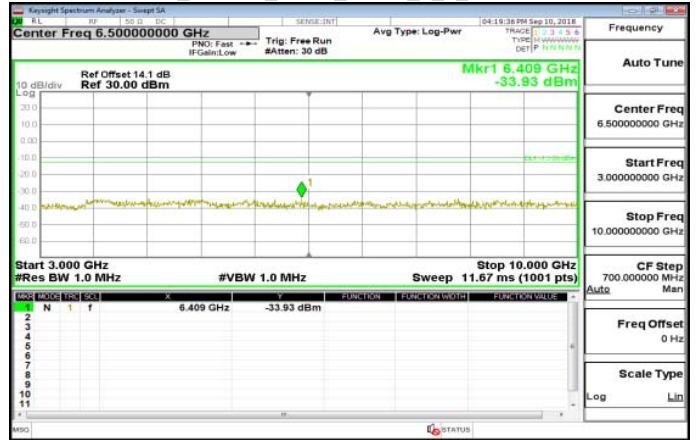

3GHz~10GHz\_Band12\_5MHz\_QPSK\_1\_0\_LowCH23035-701.5

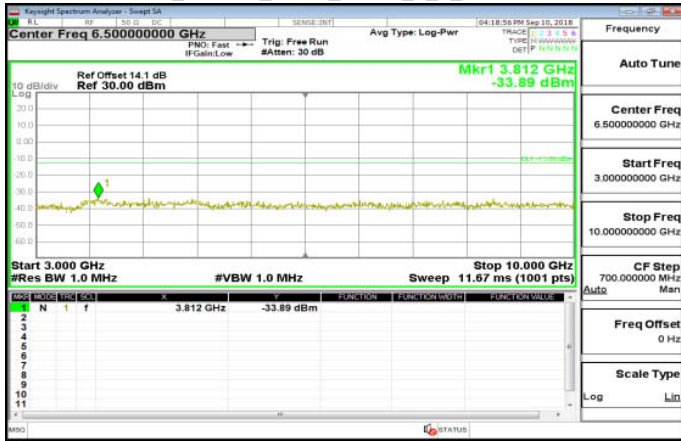

30MHz~3GHz\_Band12\_5MHz\_QPSK\_1\_0\_HighCH23155-713.5



30MHz~3GHz\_Band12\_5MHz\_QPSK\_1\_0\_MidCH23095-707.5

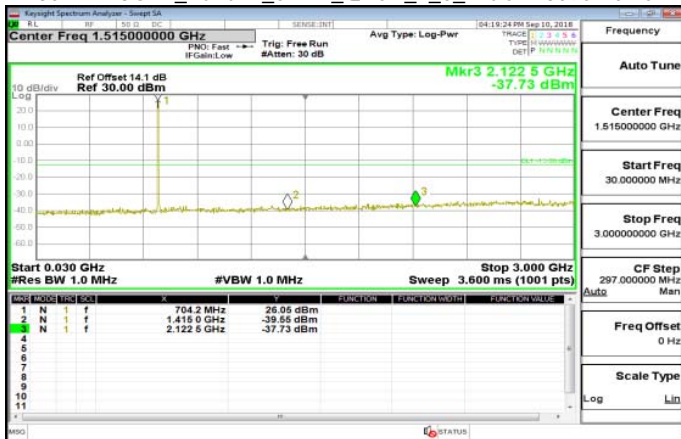

3GHz~10GHz\_Band12\_5MHz\_QPSK\_1\_0\_HighCH23155-713.5

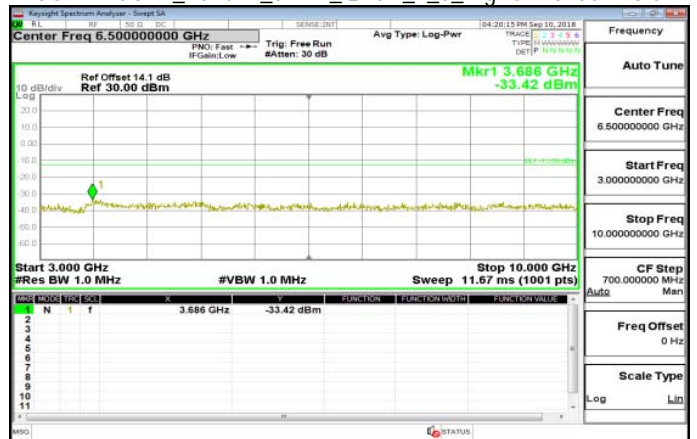

Unless otherwise stated the results shown in this test report refer only to the sample(s) tested and such sample(s) are retained for 90 days only. 除非另有說明，此報告結果僅對測試之樣品負責，同時此樣品僅保留90天。本報告未經本公司書面許可，不可部份複製。

This document is issued by the Company subject to its General Conditions of Service printed overleaf, available on request or accessible at [www.sgs.com/terms\\_and\\_conditions.htm](http://www.sgs.com/terms_and_conditions.htm) and, for electronic format documents, subject to Terms and Conditions for Electronic Documents at [www.sgs.com/terms\\_e-document.htm](http://www.sgs.com/terms_e-document.htm). Attention is drawn to the limitation of liability, indemnification and jurisdiction issues defined therein. Any holder of this document is advised that information contained hereon reflects the Company's findings at the time of its intervention only and within the limits of Client's instructions, if any. The Company's sole responsibility is to its Client and this document does not exonerate parties to a transaction from exercising all their rights and obligations under the transaction documents. This document cannot be reproduced except in full, without prior written approval of the Company. Any unauthorized alteration, forgery or falsification of the content or appearance of this document is unlawful and offenders may be prosecuted to the fullest extent of the law.

30MHz-3GHz\_Band12\_10MHz\_QPSK\_1\_0\_LowCH23060-704



3GHz-10GHz\_Band12\_10MHz\_QPSK\_1\_0\_MidCH23095-707.5

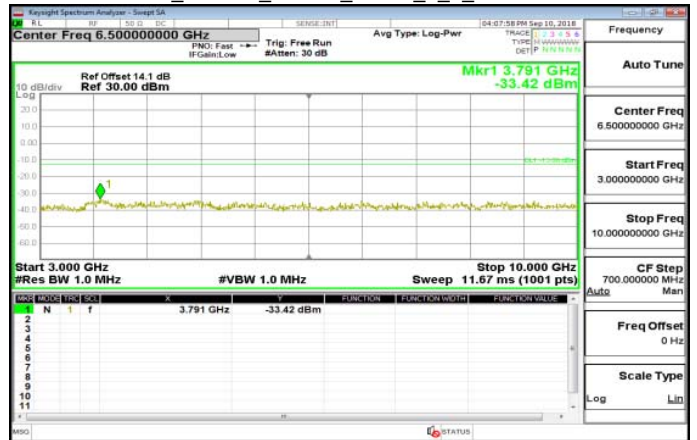

3GHz-10GHz\_Band12\_10MHz\_QPSK\_1\_0\_LowCH23060-704

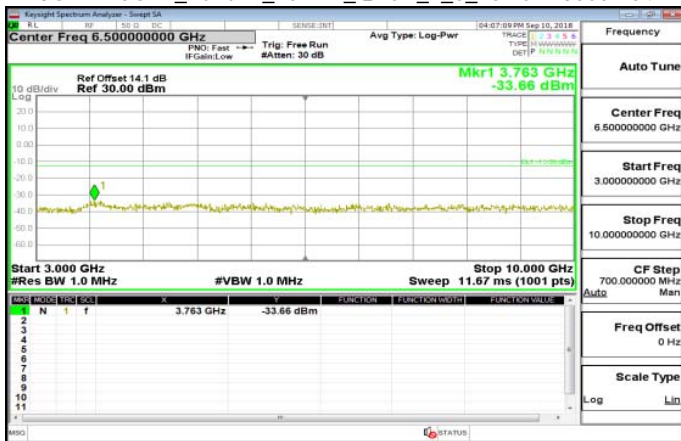

30MHz-3GHz\_Band12\_10MHz\_QPSK\_1\_0\_HighCH23130-711

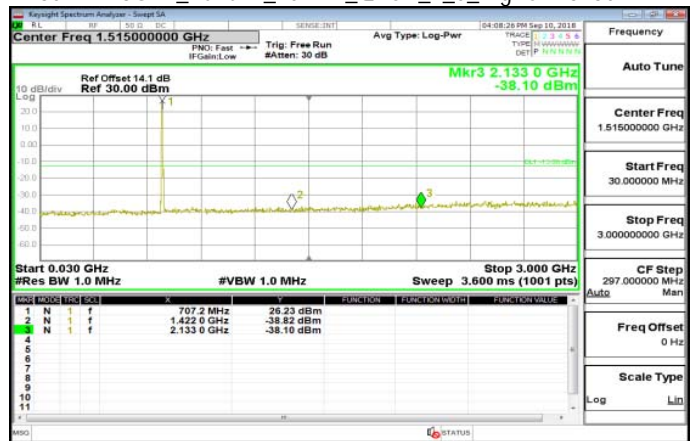

30MHz-3GHz\_Band12\_10MHz\_QPSK\_1\_0\_MidCH23095-707.5

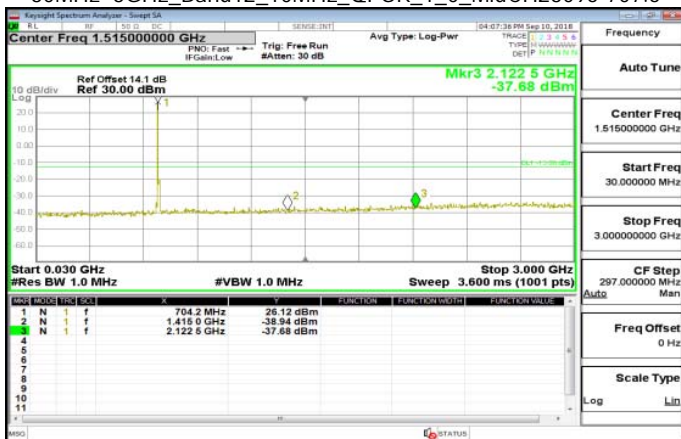

3GHz-10GHz\_Band12\_10MHz\_QPSK\_1\_0\_HighCH23130-711

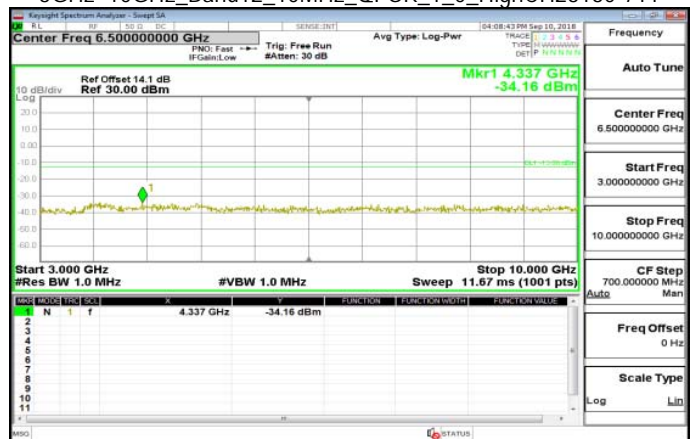

Unless otherwise stated the results shown in this test report refer only to the sample(s) tested and such sample(s) are retained for 90 days only.

除非另有說明，此報告結果僅對測試之樣品負責，同時此樣品僅保留90天。本報告未經本公司書面許可，不可部份複製。

This document is issued by the Company subject to its General Conditions of Service printed overleaf, available on request or accessible at [www.sgs.com/terms\\_and\\_conditions.htm](http://www.sgs.com/terms_and_conditions.htm) and, for electronic format documents, subject to Terms and Conditions for Electronic Documents at [www.sgs.com/terms\\_e-document.htm](http://www.sgs.com/terms_e-document.htm). Attention is drawn to the limitation of liability, indemnification and jurisdiction issues defined therein. Any holder of this document is advised that information contained hereon reflects the Company's findings at the time of its intervention only and within the limits of Client's instructions, if any. The Company's sole responsibility is to its Client and this document does not exonerate parties to a transaction from exercising all their rights and obligations under the transaction documents. This document cannot be reproduced except in full, without prior written approval of the Company. Any unauthorized alteration, forgery or falsification of the content or appearance of this document is unlawful and offenders may be prosecuted to the fullest extent of the law.

30MHz~3GHz\_Band17\_5MHz\_QPSK\_1\_0\_LowCH23755-706.5



3GHz~10GHz\_Band17\_5MHz\_QPSK\_1\_0\_MidCH23790-710

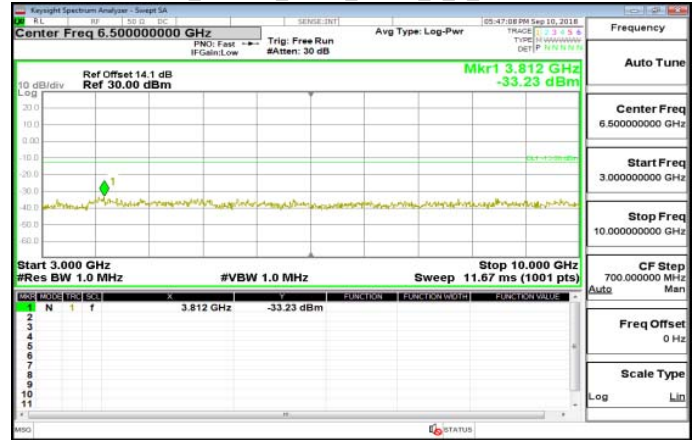

3GHz~10GHz\_Band17\_5MHz\_QPSK\_1\_0\_LowCH23755-706.5

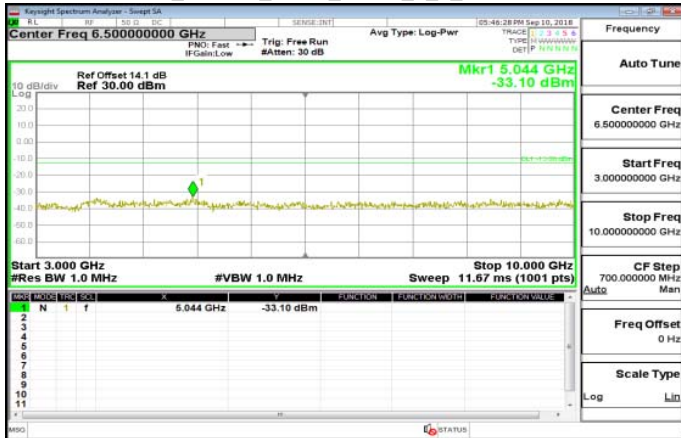

30MHz~3GHz\_Band17\_5MHz\_QPSK\_1\_0\_HighCH23825-713.5



30MHz~3GHz\_Band17\_5MHz\_QPSK\_1\_0\_MidCH23790-710

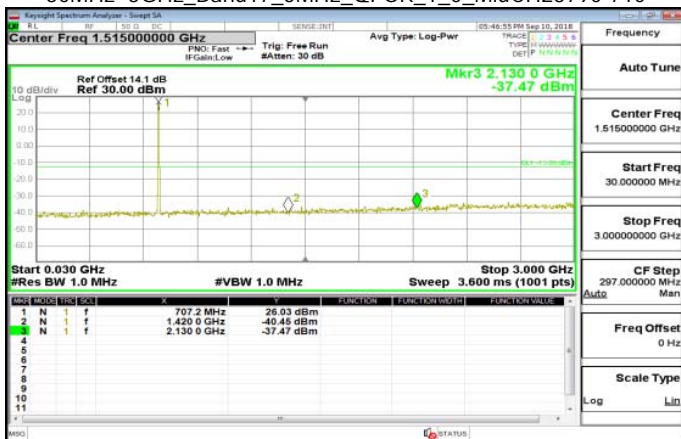

3GHz~10GHz\_Band17\_5MHz\_QPSK\_1\_0\_HighCH23825-713.5

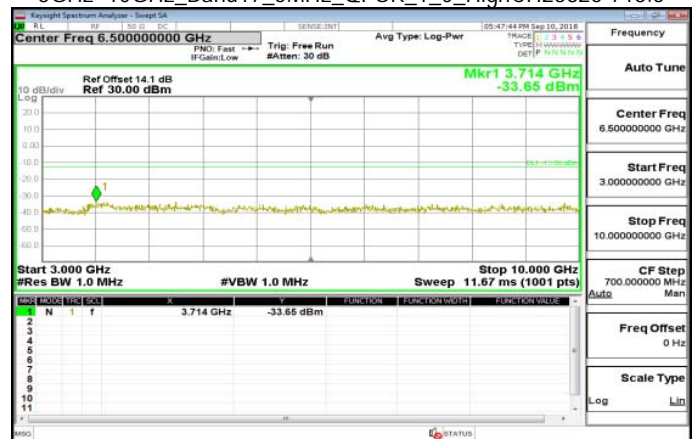

Unless otherwise stated the results shown in this test report refer only to the sample(s) tested and such sample(s) are retained for 90 days only.

除非另有說明，此報告結果僅對測試之樣品負責，同時此樣品僅保留90天。本報告未經本公司書面許可，不可部份複製。

This document is issued by the Company subject to its General Conditions of Service printed overleaf, available on request or accessible at [www.sgs.com/terms\\_and\\_conditions.htm](http://www.sgs.com/terms_and_conditions.htm) and, for electronic format documents, subject to Terms and Conditions for Electronic Documents at [www.sgs.com/terms\\_e-document.htm](http://www.sgs.com/terms_e-document.htm). Attention is drawn to the limitation of liability, indemnification and jurisdiction issues defined therein. Any holder of this document is advised that information contained hereon reflects the Company's findings at the time of its intervention only and within the limits of Client's instructions, if any. The Company's sole responsibility is to its Client and this document does not exonerate parties to a transaction from exercising all their rights and obligations under the transaction documents. This document cannot be reproduced except in full, without prior written approval of the Company. Any unauthorized alteration, forgery or falsification of the content or appearance of this document is unlawful and offenders may be prosecuted to the fullest extent of the law.

30MHz-3GHz\_Band17\_10MHz\_QPSK\_1\_0\_LowCH23780-709

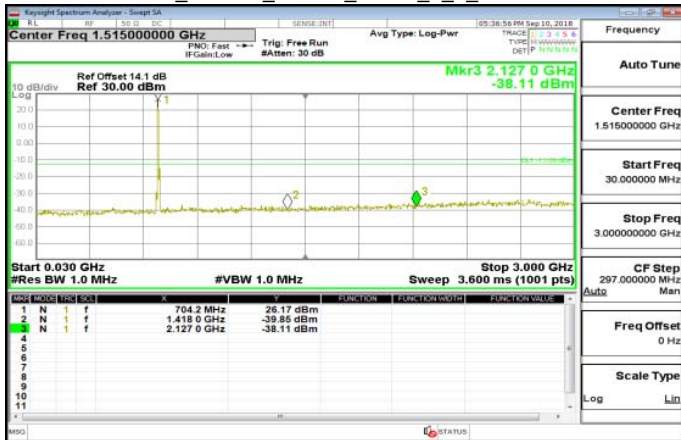

3GHz-10GHz\_Band17\_10MHz\_QPSK\_1\_0\_MidCH23790-710

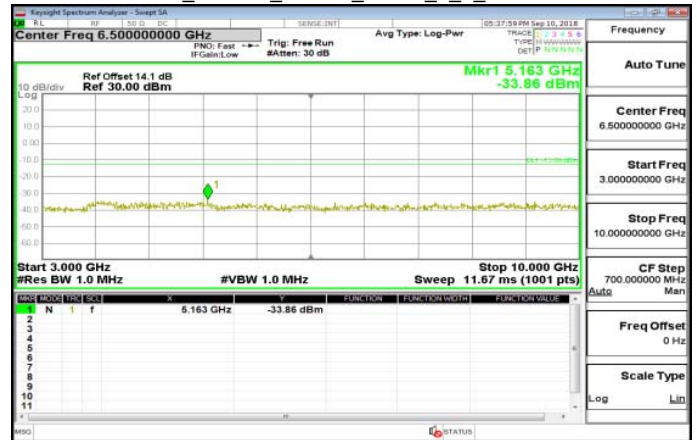

3GHz-10GHz\_Band17\_10MHz\_QPSK\_1\_0\_LowCH23780-709

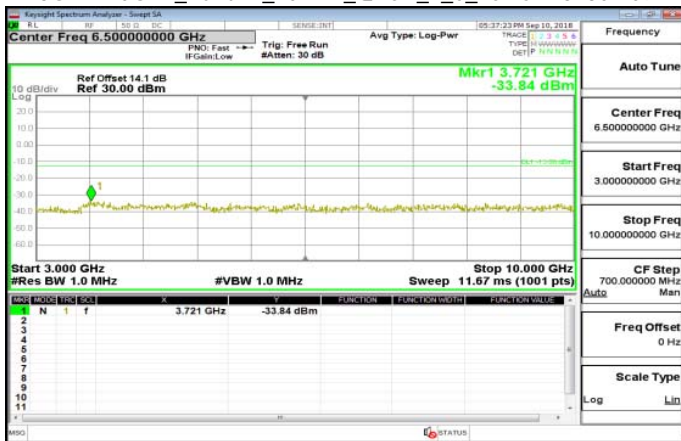

30MHz-3GHz\_Band17\_10MHz\_QPSK\_1\_0\_HighCH23800-711

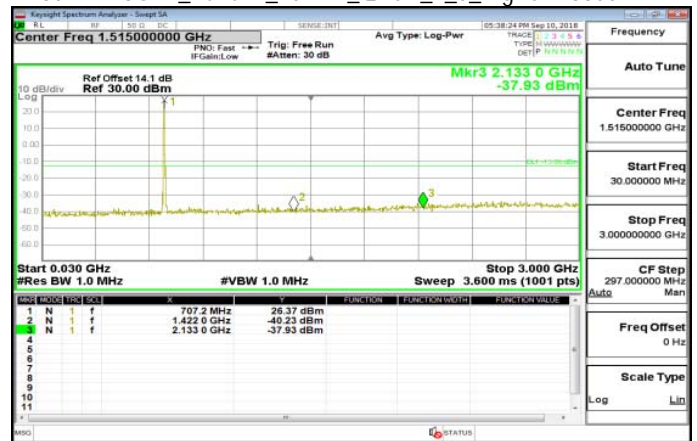

30MHz-3GHz\_Band17\_10MHz\_QPSK\_1\_0\_MidCH23790-710

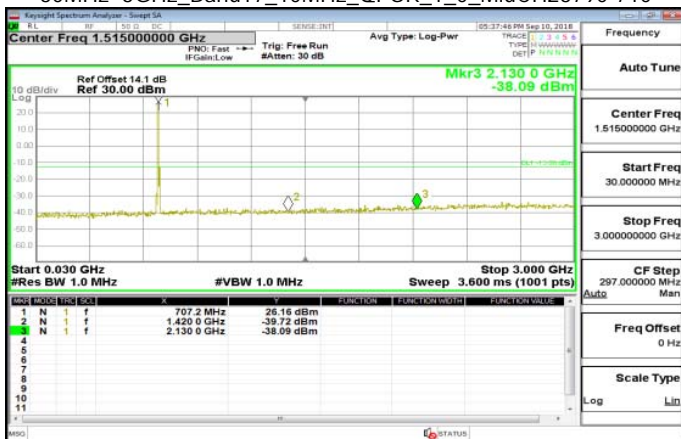

3GHz-10GHz\_Band17\_10MHz\_QPSK\_1\_0\_HighCH23800-711

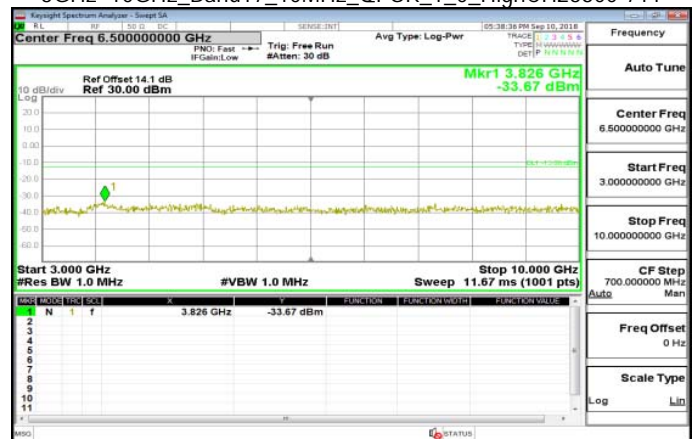

Unless otherwise stated the results shown in this test report refer only to the sample(s) tested and such sample(s) are retained for 90 days only. 除非另有說明，此報告結果僅對測試之樣品負責，同時此樣品僅保留90天。本報告未經本公司書面許可，不可部份複製。

This document is issued by the Company subject to its General Conditions of Service printed overleaf, available on request or accessible at [www.sgs.com/terms\\_and\\_conditions.htm](http://www.sgs.com/terms_and_conditions.htm) and, for electronic format documents, subject to Terms and Conditions for Electronic Documents at [www.sgs.com/terms\\_e-document.htm](http://www.sgs.com/terms_e-document.htm). Attention is drawn to the limitation of liability, indemnification and jurisdiction issues defined therein. Any holder of this document is advised that information contained hereon reflects the Company's findings at the time of its intervention only and within the limits of Client's instructions, if any. The Company's sole responsibility is to its Client and this document does not exonerate parties to a transaction from exercising all their rights and obligations under the transaction documents. This document cannot be reproduced except in full, without prior written approval of the Company. Any unauthorized alteration, forgery or falsification of the content or appearance of this document is unlawful and offenders may be prosecuted to the fullest extent of the law.

## 10. FIELD STRENGTH OF SPURIOUS RADIATION MEASUREMENT

### 10.1. Standard Applicable

According to FCC §2.1053,

FCC §22.917(a) , §24.238(a) , §27.53 (h) , the magnitude of each spurious and harmonic emission that can be detected when the equipment is operated under the conditions specified in the instruction manual and/ or alignment procedure, shall not be less than  $43 + 10 \log$  (mean output power in watts) dBc below the mean power output outside a license's frequency block (-13dBm).

FCC §27.53(g)

Compliance with this provision is based on the use of measurement instrumentation employing a resolution bandwidth of 100 kilohertz or greater. However, in the 100 kilohertz bands immediately outside and adjacent to a licensee's frequency block, a resolution bandwidth of at least 30 kHz may be employed.

FCC §27.53(h) (3)

Compliance with this provision is based on the use of measurement instrumentation employing a resolution bandwidth of 1 megahertz or greater. However, in the 1 megahertz bands immediately outside and adjacent to the licensee's frequency block, a resolution bandwidth of at least one percent of the emission bandwidth of the fundamental emission of the transmitter may be employed. The emission bandwidth is defined as the width of the signal between two points, one below the carrier center frequency and one above the carrier center frequency, outside of which all emissions are attenuated at least 26 dB below the transmitter power.

Unless otherwise stated the results shown in this test report refer only to the sample(s) tested and such sample(s) are retained for 90 days only.

除非另有說明，此報告結果僅對測試之樣品負責，同時此樣品僅保留90天。本報告未經本公司書面許可，不可部份複製。

This document is issued by the Company subject to its General Conditions of Service printed overleaf, available on request or accessible at [www.sgs.com/terms\\_and\\_conditions.htm](http://www.sgs.com/terms_and_conditions.htm) and, for electronic format documents, subject to Terms and Conditions for Electronic Documents at [www.sgs.com/terms\\_e-document.htm](http://www.sgs.com/terms_e-document.htm). Attention is drawn to the limitation of liability, indemnification and jurisdiction issues defined therein. Any holder of this document is advised that information contained hereon reflects the Company's findings at the time of its intervention only and within the limits of Client's instructions, if any. The Company's sole responsibility is to its Client and this document does not exonerate parties to a transaction from exercising all their rights and obligations under the transaction documents. This document cannot be reproduced except in full, without prior written approval of the Company. Any unauthorized alteration, forgery or falsification of the content or appearance of this document is unlawful and offenders may be prosecuted to the fullest extent of the law.

SGS Taiwan Ltd.

台灣檢驗科技股份有限公司

No.134,WuKungRoad,NewTaipeiIndustrialPark,WukuDistrict,NewTaipeiCity,Taiwan24803/新北市五股區新北產業園區五工路 134 號

t (886-2) 2299-3279

f (886-2) 2298-0488

[www.tw.sgs.com](http://www.tw.sgs.com)

Member of SGS Group

## FCC §27.53(m) (4)

For mobile digital stations, the attenuation factor shall be not less than  $40 + 10 \log (P)$  dB on all frequencies between the channel edge and 5 megahertz from the channel edge,  $43 + 10 \log (P)$  dB on all frequencies between 5 megahertz and X megahertz from the channel edge, and  $55 + 10 \log (P)$  dB on all frequencies more than X megahertz from the channel edge, where X is the greater of 6 megahertz or the actual emission bandwidth as defined in paragraph (m)(6) of this section. In addition, the attenuation factor shall not be less than  $43 + 10 \log (P)$  dB on all frequencies between 2490.5 MHz and 2496 MHz and  $55 + 10 \log (P)$  dB on or below 2490.5 MHz. Mobile Satellite Service licensees operating on frequencies below 2495 MHz may also submit a documented interference complaint against BRS licensees operating on channel BRS Channel 1 on the same terms and conditions as adjacent channel BRS or EBS licensees.

Measurement procedure. Compliance with these rules is based on the use of measurement instrumentation employing a resolution bandwidth of 1 megahertz or greater. However, in the 1 MHz bands immediately outside and adjacent to the frequency block a resolution bandwidth of at least one percent of the emission bandwidth of the fundamental emission of the transmitter may be employed; for mobile digital stations, in the 1 megahertz bands immediately outside and adjacent to the frequency block a resolution bandwidth of at least two percent may be employed, except when the 1 megahertz band is 2495-2496 MHz, in which case a resolution bandwidth of at least one percent may be employed. A narrower resolution bandwidth is permitted in all cases to improve measurement accuracy provided the measured power is integrated over the full required measurement bandwidth (i.e. 1 megahertz or 1 percent of emission bandwidth, as specified; or 1 megahertz or 2 percent for mobile digital stations, except in the band 2495-2496 MHz). The emission bandwidth is defined as the width of the signal between two points, one below the carrier center frequency and one above the carrier center frequency, outside of which all emissions are attenuated at least 26 dB below the transmitter power. With respect to television operations, measurements must be made of the separate visual and aural operating powers at sufficiently frequent intervals to ensure compliance with the rules.

Unless otherwise stated the results shown in this test report refer only to the sample(s) tested and such sample(s) are retained for 90 days only.

除非另有說明，此報告結果僅對測試之樣品負責，同時此樣品僅保留90天。本報告未經本公司書面許可，不可部份複製。

This document is issued by the Company subject to its General Conditions of Service printed overleaf, available on request or accessible at [www.sgs.com/terms\\_and\\_conditions.htm](http://www.sgs.com/terms_and_conditions.htm) and, for electronic format documents, subject to Terms and Conditions for Electronic Documents at [www.sgs.com/terms\\_e-document.htm](http://www.sgs.com/terms_e-document.htm). Attention is drawn to the limitation of liability, indemnification and jurisdiction issues defined therein. Any holder of this document is advised that information contained hereon reflects the Company's findings at the time of its intervention only and within the limits of Client's instructions, if any. The Company's sole responsibility is to its Client and this document does not exonerate parties to a transaction from exercising all their rights and obligations under the transaction documents. This document cannot be reproduced except in full, without prior written approval of the Company. Any unauthorized alteration, forgery or falsification of the content or appearance of this document is unlawful and offenders may be prosecuted to the fullest extent of the law.

SGS Taiwan Ltd.

台灣檢驗科技股份有限公司

No.134,WuKungRoad,NewTaipeiIndustrialPark,WukuDistrict,NewTaipeiCity,Taiwan24803/新北市五股區新北產業園區五工路 134 號

t (886-2) 2299-3279

f (886-2) 2298-0488

[www.tw.sgs.com](http://www.tw.sgs.com)

Member of SGS Group

**Table 2 — Unwanted Emissions for Mobile, Portable and Low-Power Fixed Subscriber Equipment**

Frequency (MHz)	Attenuation (dB)
<2200	$43 + 10 \log_{10}(p)$
2200 - 2288	$70 + 10 \log_{10}(p)$
2288 - 2292	$67 + 10 \log_{10}(p)$
2292 - 2296	$61 + 10 \log_{10}(p)$
2296 - 2300	$55 + 10 \log_{10}(p)$
2300 - 2305	$43 + 10 \log_{10}(p)$
2305 - 2320	$43 + 10 \log_{10}(p)^{\text{Note}}$
2320 - 2324	$55 + 10 \log_{10}(p)$
2324 - 2328	$61 + 10 \log_{10}(p)$
2328 - 2337	$67 + 10 \log_{10}(p)$
2337 - 2341	$61 + 10 \log_{10}(p)$
2341 - 2345	$55 + 10 \log_{10}(p)$
2345 - 2360	$43 + 10 \log_{10}(p)^{\text{Note}}$
2360 - 2365	$43 + 10 \log_{10}(p)$
2365 - 2395	$70 + 10 \log_{10}(p)$
>2395	$43 + 10 \log_{10}(p)$

**Note:** Measured at the edges of the highest and lowest frequency range(s) in which the equipment is designed to operate. See Section 1.2 for the permitted frequency ranges for various equipment types.

Unless otherwise stated the results shown in this test report refer only to the sample(s) tested and such sample(s) are retained for 90 days only.

除非另有說明，此報告結果僅對測試之樣品負責，同時此樣品僅保留90天。本報告未經本公司書面許可，不可部份複製。

This document is issued by the Company subject to its General Conditions of Service printed overleaf, available on request or accessible at [www.sgs.com/terms\\_and\\_conditions.htm](http://www.sgs.com/terms_and_conditions.htm) and, for electronic format documents, subject to Terms and Conditions for Electronic Documents at [www.sgs.com/terms\\_e-document.htm](http://www.sgs.com/terms_e-document.htm). Attention is drawn to the limitation of liability, indemnification and jurisdiction issues defined therein. Any holder of this document is advised that information contained hereon reflects the Company's findings at the time of its intervention only and within the limits of Client's instructions, if any. The Company's sole responsibility is to its Client and this document does not exonerate parties to a transaction from exercising all their rights and obligations under the transaction documents. This document cannot be reproduced except in full, without prior written approval of the Company. Any unauthorized alteration, forgery or falsification of the content or appearance of this document is unlawful and offenders may be prosecuted to the fullest extent of the law.

SGS Taiwan Ltd.

No.134,WuKungRoad,NewTaipeiIndustrialPark,WukuDistrict,NewTaipeiCity,Taiwan24803/新北市五股區新北產業園區五工路 134 號

台灣檢驗科技股份有限公司

t (886-2) 2299-3279

f (886-2) 2298-0488

www.tw.sgs.com

Member of SGS Group



## 10.2. EUT Setup

### Radiated Emission Test Set-Up, Frequency Below 1000MHz

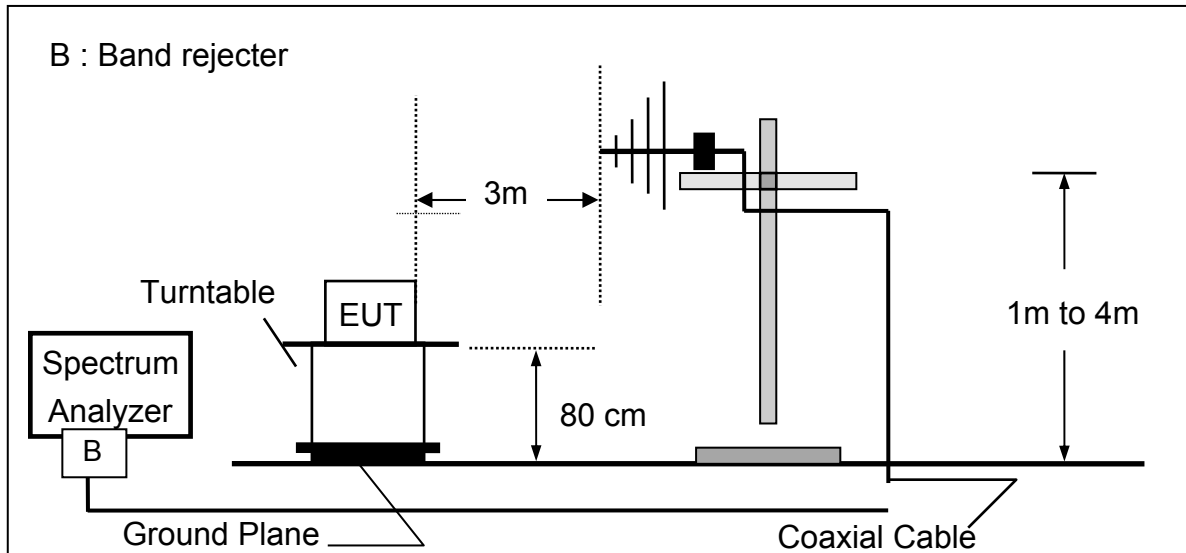

### Radiated Emission Test Set-UP Frequency Over 1 GHz

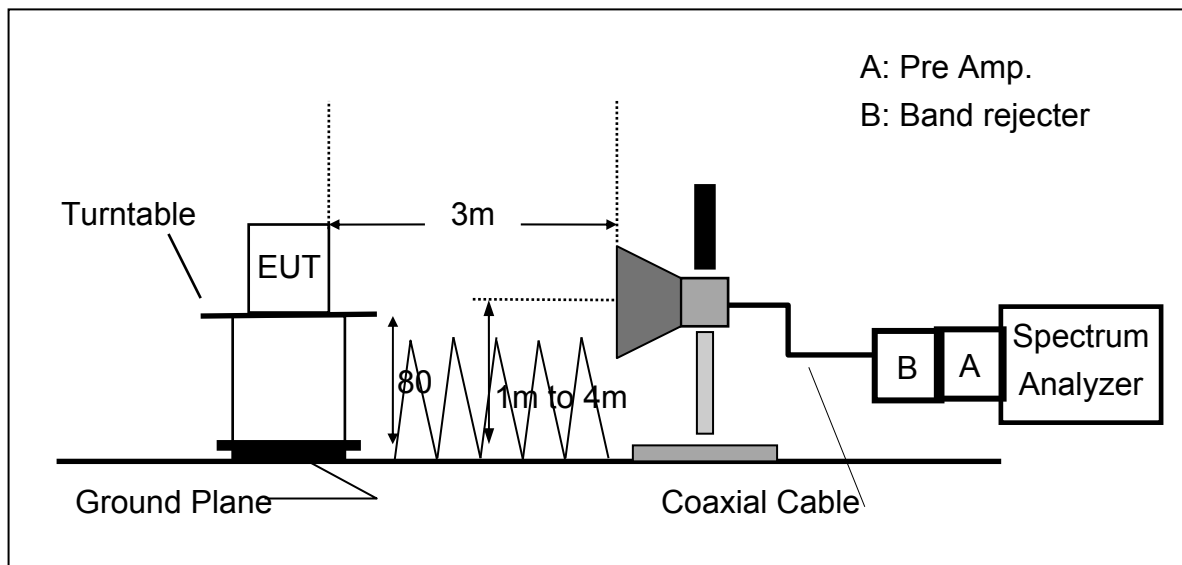

Unless otherwise stated the results shown in this test report refer only to the sample(s) tested and such sample(s) are retained for 90 days only.

除非另有說明，此報告結果僅對測試之樣品負責，同時此樣品僅保留90天。本報告未經本公司書面許可，不可部份複製。

This document is issued by the Company subject to its General Conditions of Service printed overleaf, available on request or accessible at [www.sgs.com/terms\\_and\\_conditions.htm](http://www.sgs.com/terms_and_conditions.htm) and, for electronic format documents, subject to Terms and Conditions for Electronic Documents at [www.sgs.com/terms\\_e-document.htm](http://www.sgs.com/terms_e-document.htm). Attention is drawn to the limitation of liability, indemnification and jurisdiction issues defined therein. Any holder of this document is advised that information contained hereon reflects the Company's findings at the time of its intervention only and within the limits of Client's instructions, if any. The Company's sole responsibility is to its Client and this document does not exonerate parties to a transaction from exercising all their rights and obligations under the transaction documents. This document cannot be reproduced except in full, without prior written approval of the Company. Any unauthorized alteration, forgery or falsification of the content or appearance of this document is unlawful and offenders may be prosecuted to the fullest extent of the law.

### 10.3. Measurement Procedure:

The EUT was placed on a non-conductive; the measurement antenna was placed at a distance of 3 meters from the EUT. During the tests, the antenna height and the EUT azimuth were varied in order to identify the maximum level of emissions from the EUT. This maximization process was repeated with the EUT positioned in each of its three orthogonal orientations.

The frequency range up to tenth harmonic was investigated for each of three fundamental frequencies (low, middle and high channels). Once spurious emission was identified, the power of the emission was determined using the substitution method.

The spurious emissions attenuation was calculated as the difference between radiated power at the fundamental frequency and the spurious emissions frequency.

$$\text{ERP (dBm)} = \text{SG Level(dBm)} + \text{Antenna Gain(dBd)} + \text{Cable Loss(dB)}$$

$$\text{EIRP (dBm)} = \text{SG Level(dBm)} + \text{Antenna Gain(dBi)} + \text{Cable Loss(dB)}$$

Note : “F” : denotes Fundamental Frequency. ; “H” : denotes Harmonic Frequency.

“E” : denotes Band Edge Frequency. ; “S” : denotes Spurious Frequency.

“---” : denotes Noise Floor.

### 10.4. Measurement Equipment Used:

EQUIPMENT TYPE	MFR	MODEL NUMBER	SERIAL NUMBER	LAST CAL.	CAL DUE.
Bi-log Antenna	SCHWAZBECK	VULB9168	378	2017/12/29	2018/12/28
Horn Antenna	Schwarzbeck	BBHA9120D	1441	2018/08/16	2019/08/15
Horn Antenna	Schwarzbeck	BBHA9170	184	2017/12/12	2018/12/11
Loop Antenna	ETS.LINDGREN	6502	148045	2017/09/26	2018/09/25
3m Site NSA	SGS	966 chamber	N/A	2018/01/02	2019/01/01
Spectrum Analyzer	Agilent	E4446A	MY51100003	2018/05/15	2019/05/14
EMI Test Receiver	R&S	ESCI7	100335	2018/02/02	2019/02/01
Pre-Amplifier	HP	8449B	3008A00578	2018/01/02	2019/01/01
Pre-Amplifier	HP	8447D	2944A07676	2018/01/02	2019/01/01
Pre-Amplifier	EMC Instruments	EMC184045B	980135	2017/10/27	2018/10/26
Attenuator	Mini-Circuit	BW-S10W2+	2	2018/01/02	2019/01/01
2GHz High Pass Filter	Micro-Tronics	HPM50110	36	2018/01/02	2019/01/01
Filter 5150-5350 MHz	Micro-Tronics	BRM50703	1	2018/01/02	2019/01/01
Low Loss Cable	Huber Suhner	966_RX	9	2018/01/02	2019/01/01

Unless otherwise stated the results shown in this test report refer only to the sample(s) tested and such sample(s) are retained for 90 days only.

除非另有說明，此報告結果僅對測試之樣品負責，同時此樣品僅保留90天。本報告未經本公司書面許可，不可部份複製。

This document is issued by the Company subject to its General Conditions of Service printed overleaf, available on request or accessible at [www.sgs.com/terms\\_and\\_conditions.htm](http://www.sgs.com/terms_and_conditions.htm) and, for electronic format documents, subject to Terms and Conditions for Electronic Documents at [www.sgs.com/terms\\_e-document.htm](http://www.sgs.com/terms_e-document.htm). Attention is drawn to the limitation of liability, indemnification and jurisdiction issues defined therein. Any holder of this document is advised that information contained hereon reflects the Company's findings at the time of its intervention only and within the limits of Client's instructions, if any. The Company's sole responsibility is to its Client and this document does not exonerate parties to a transaction from exercising all their rights and obligations under the transaction documents. This document cannot be reproduced except in full, without prior written approval of the Company. Any unauthorized alteration, forgery or falsification of the content or appearance of this document is unlawful and offenders may be prosecuted to the fullest extent of the law.

### 10.5. Measurement Result:

#### Radiated Spurious Emission Measurement Result: GPRS 850 Mode

Operation Band	:GPRS 850	Temp./Humi.	:24 deg_C / 61 RH
Fundamental Frequency	:824.2 MHz	Engineer	:Tin
Operation Mode	:Tx CH LOW		
EUT Pol.	:E2 Plane	Measurement Antenna	:VERTICAL
		Pol.	

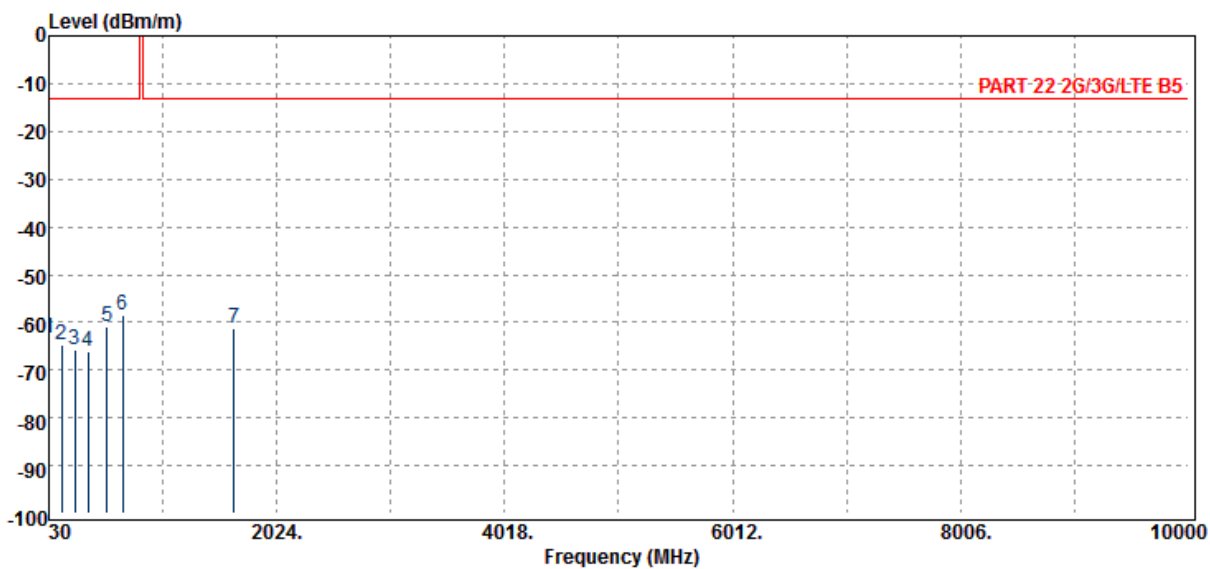

Freq. MHz	ERP/EIRP dBm	SG Output Level dBm	Antenna Gain dBd/dBi	Cable Loss dB	Limit dBm	Margin dB
30.00	-63.24	-48.08	-14.58	-0.58	-13.00	-50.24
141.55	-64.60	-61.10	-2.22	-1.27	-13.00	-51.60
259.89	-65.70	-67.67	3.67	-1.70	-13.00	-52.70
374.35	-65.99	-67.74	3.78	-2.04	-13.00	-52.99
537.31	-60.85	-62.79	4.00	-2.07	-13.00	-47.85
675.05	-58.39	-59.49	3.75	-2.65	-13.00	-45.39
1648.40	-61.15	-63.78	6.97	-4.35	-13.00	-48.15

Unless otherwise stated the results shown in this test report refer only to the sample(s) tested and such sample(s) are retained for 90 days only.

除非另有說明，此報告結果僅對測試之樣品負責，同時此樣品僅保留90天。本報告未經本公司書面許可，不可部份複製。

This document is issued by the Company subject to its General Conditions of Service printed overleaf, available on request or accessible at [www.sgs.com/terms\\_and\\_conditions.htm](http://www.sgs.com/terms_and_conditions.htm) and, for electronic format documents, subject to Terms and Conditions for Electronic Documents at [www.sgs.com/terms\\_e-document.htm](http://www.sgs.com/terms_e-document.htm). Attention is drawn to the limitation of liability, indemnification and jurisdiction issues defined therein. Any holder of this document is advised that information contained hereon reflects the Company's findings at the time of its intervention only and within the limits of Client's instructions, if any. The Company's sole responsibility is to its Client and this document does not exonerate parties to a transaction from exercising all their rights and obligations under the transaction documents. This document cannot be reproduced except in full, without prior written approval of the Company. Any unauthorized alteration, forgery or falsification of the content or appearance of this document is unlawful and offenders may be prosecuted to the fullest extent of the law.

SGS Taiwan Ltd.

No.134,WuKungRoad,NewTaipeiIndustrialPark,WukuDistrict,NewTaipeiCity,Taiwan24803/新北市五股區新北產業園區五工路 134 號

台灣檢驗科技股份有限公司

t (886-2) 2299-3279

f (886-2) 2298-0488

www.tw.sgs.com

Member of SGS Group

Operation Band	:GPRS 850	Temp./Humi.	:24 deg_C / 61 RH
Fundamental Frequency	:824.2 MHz	Engineer	:Tin
Operation Mode	:Tx CH LOW		
EUT Pol.	:E2 Plane	Measurement Antenna Pol.	:HORIZONTAL

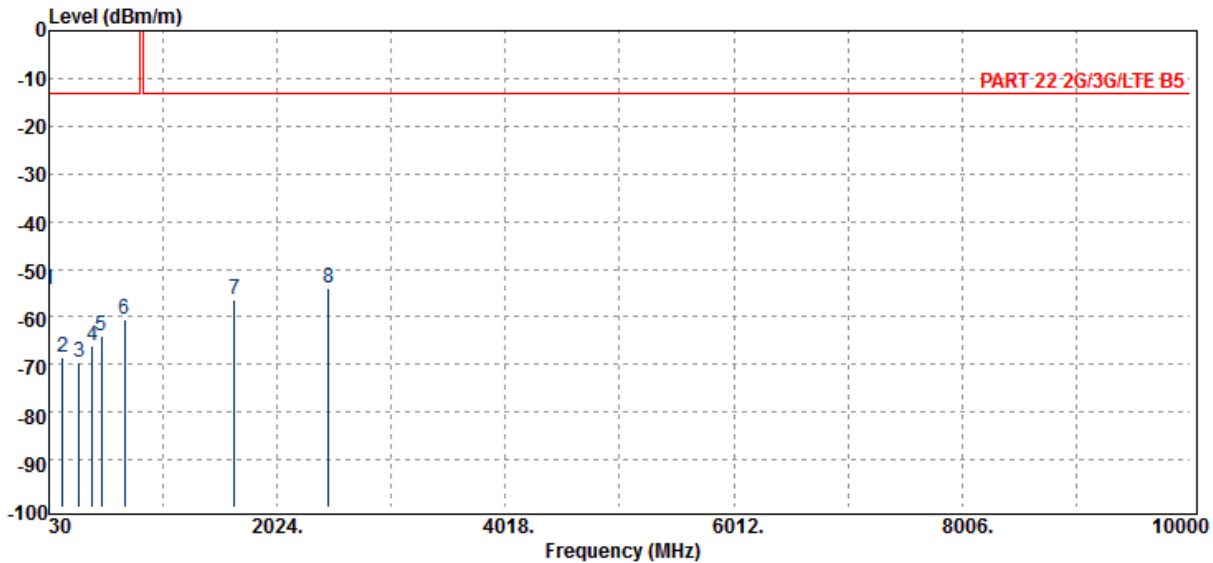

Freq. MHz	ERP/EIRP dBm	SG Output Level dBm	Antenna Gain dBd/dBi	Cable Loss dB	Limit dBm	Margin dB
30.00	-54.41	-39.25	-14.58	-0.58	-13.00	-41.41
146.40	-68.49	-65.22	-1.98	-1.29	-13.00	-55.49
291.90	-69.41	-71.08	3.46	-1.79	-13.00	-56.41
411.21	-66.10	-67.64	3.67	-2.13	-13.00	-53.10
490.75	-63.85	-65.85	3.96	-1.96	-13.00	-50.85
692.51	-60.48	-61.42	3.70	-2.76	-13.00	-47.48
1648.40	-56.40	-59.03	6.97	-4.35	-13.00	-43.40
2472.60	-53.86	-56.70	8.34	-5.49	-13.00	-40.86

Unless otherwise stated the results shown in this test report refer only to the sample(s) tested and such sample(s) are retained for 90 days only.

除非另有說明，此報告結果僅對測試之樣品負責，同時此樣品僅保留90天。本報告未經本公司書面許可，不可部份複製。

This document is issued by the Company subject to its General Conditions of Service printed overleaf, available on request or accessible at [www.sgs.com/terms\\_and\\_conditions.htm](http://www.sgs.com/terms_and_conditions.htm) and, for electronic format documents, subject to Terms and Conditions for Electronic Documents at [www.sgs.com/terms\\_e-document.htm](http://www.sgs.com/terms_e-document.htm). Attention is drawn to the limitation of liability, indemnification and jurisdiction issues defined therein. Any holder of this document is advised that information contained hereon reflects the Company's findings at the time of its intervention only and within the limits of Client's instructions, if any. The Company's sole responsibility is to its Client and this document does not exonerate parties to a transaction from exercising all their rights and obligations under the transaction documents. This document cannot be reproduced except in full, without prior written approval of the Company. Any unauthorized alteration, forgery or falsification of the content or appearance of this document is unlawful and offenders may be prosecuted to the fullest extent of the law.

SGS Taiwan Ltd.

No.134,WuKungRoad,NewTaipeiIndustrialPark,WukuDistrict,NewTaipeiCity,Taiwan24803/新北市五股區新北產業園區五工路 134 號

台灣檢驗科技股份有限公司

t (886-2) 2299-3279

f (886-2) 2298-0488

www.tw.sgs.com

Member of SGS Group

Operation Band	:GPRS 850	Temp./Humi.	:24 deg_C / 61 RH
Fundamental Frequency	:836.6 MHz	Engineer	:Tin
Operation Mode	:Tx CH MID	Measurement Antenna	:VERTICAL
EUT Pol.	:E2 Plane	Pol.	

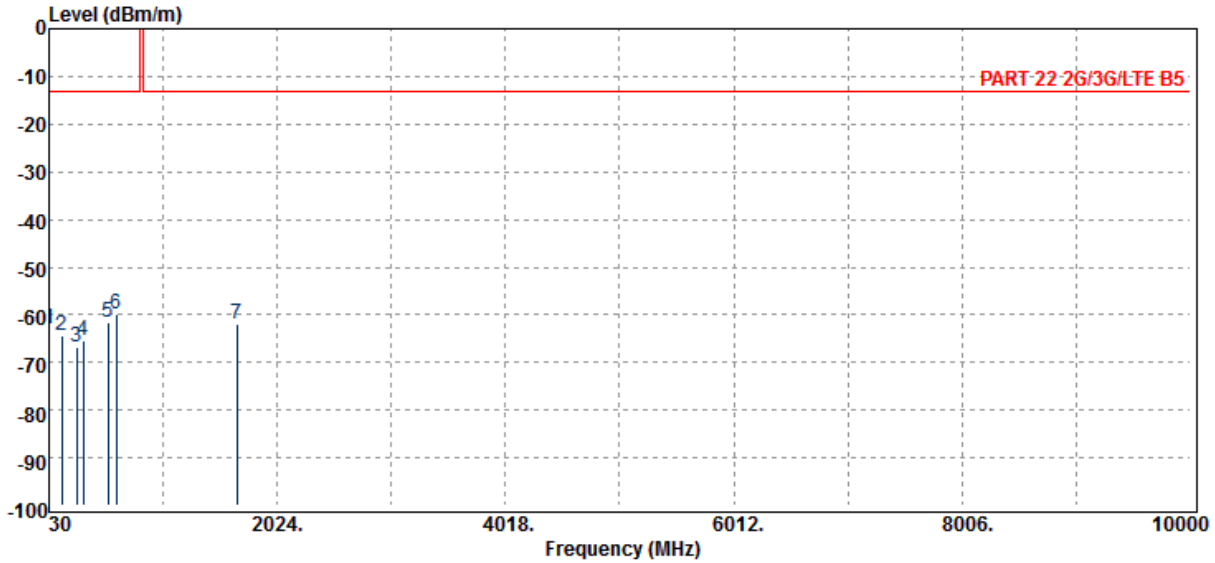

Freq. MHz	ERP/EIRP dBm	SG Output Level dBm	Antenna Gain dBd/dBi	Cable Loss dB	Limit dBm	Margin dB
30.00	-63.03	-47.87	-14.58	-0.58	-13.00	-50.03
138.64	-64.25	-60.73	-2.26	-1.25	-13.00	-51.25
272.50	-66.81	-68.56	3.48	-1.73	-13.00	-53.81
332.64	-65.49	-67.34	3.78	-1.93	-13.00	-52.49
546.04	-61.47	-63.65	3.99	-1.81	-13.00	-48.47
614.91	-59.85	-61.01	3.63	-2.47	-13.00	-46.85
1673.20	-62.08	-64.74	7.06	-4.39	-13.00	-49.08

Unless otherwise stated the results shown in this test report refer only to the sample(s) tested and such sample(s) are retained for 90 days only.

除非另有說明，此報告結果僅對測試之樣品負責，同時此樣品僅保留90天。本報告未經本公司書面許可，不可部份複製。

This document is issued by the Company subject to its General Conditions of Service printed overleaf, available on request or accessible at [www.sgs.com/terms\\_and\\_conditions.htm](http://www.sgs.com/terms_and_conditions.htm) and, for electronic format documents, subject to Terms and Conditions for Electronic Documents at [www.sgs.com/terms\\_e-document.htm](http://www.sgs.com/terms_e-document.htm). Attention is drawn to the limitation of liability, indemnification and jurisdiction issues defined therein. Any holder of this document is advised that information contained hereon reflects the Company's findings at the time of its intervention only and within the limits of Client's instructions, if any. The Company's sole responsibility is to its Client and this document does not exonerate parties to a transaction from exercising all their rights and obligations under the transaction documents. This document cannot be reproduced except in full, without prior written approval of the Company. Any unauthorized alteration, forgery or falsification of the content or appearance of this document is unlawful and offenders may be prosecuted to the fullest extent of the law.

SGS Taiwan Ltd.

No.134,WuKungRoad,NewTaipeiIndustrialPark,WukuDistrict,NewTaipeiCity,Taiwan24803/新北市五股區新北產業園區五工路 134 號

台灣檢驗科技股份有限公司

t (886-2) 2299-3279

f (886-2) 2298-0488

www.tw.sgs.com

Member of SGS Group

Operation Band	:GPRS 850	Temp./Humi.	:24 deg_C / 61 RH
Fundamental Frequency	:836.6 MHz	Engineer	:Tin
Operation Mode	:Tx CH MID	Measurement Antenna	:HORIZONTAL
EUT Pol.	:E2 Plane	Pol.	

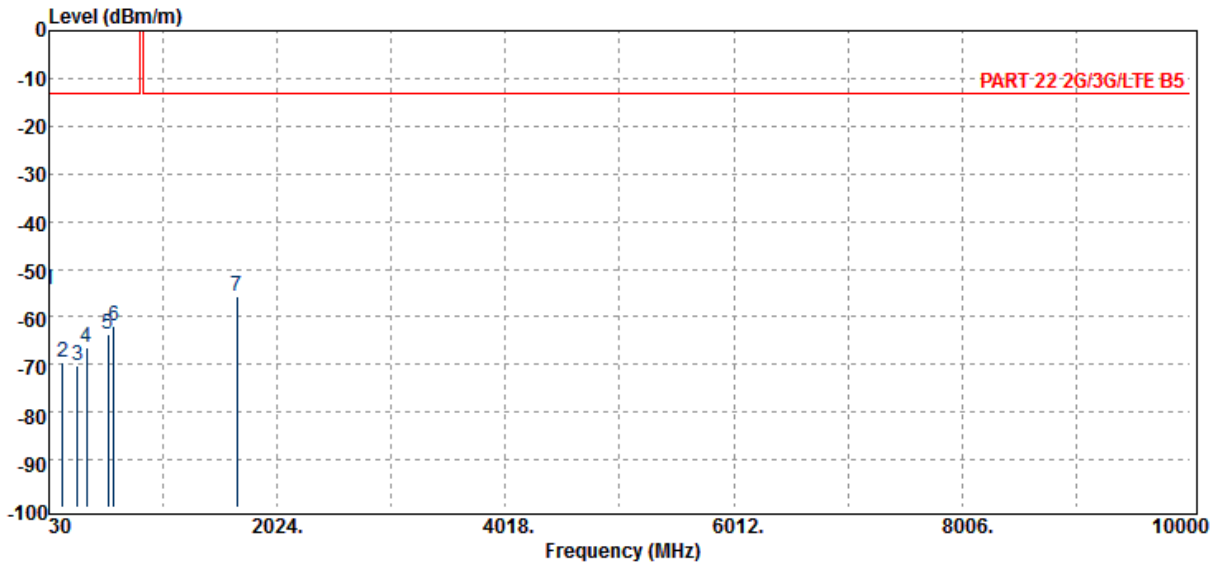

Freq. MHz	ERP/EIRP dBm	SG Output Level dBm	Antenna Gain dBd/dBi	Cable Loss dB	Limit dBm	Margin dB
30.00	-54.26	-39.10	-14.58	-0.58	-13.00	-41.26
146.40	-69.57	-66.30	-1.98	-1.29	-13.00	-56.57
280.26	-70.24	-71.91	3.42	-1.75	-13.00	-57.24
354.95	-66.27	-68.07	3.84	-2.04	-13.00	-53.27
548.95	-63.80	-65.81	3.98	-1.97	-13.00	-50.80
599.39	-61.81	-63.19	3.54	-2.17	-13.00	-48.81
1673.20	-55.68	-58.34	7.06	-4.39	-13.00	-42.68

Unless otherwise stated the results shown in this test report refer only to the sample(s) tested and such sample(s) are retained for 90 days only.

除非另有說明，此報告結果僅對測試之樣品負責，同時此樣品僅保留90天。本報告未經本公司書面許可，不可部份複製。

This document is issued by the Company subject to its General Conditions of Service printed overleaf, available on request or accessible at [www.sgs.com/terms\\_and\\_conditions.htm](http://www.sgs.com/terms_and_conditions.htm) and, for electronic format documents, subject to Terms and Conditions for Electronic Documents at [www.sgs.com/terms\\_e-document.htm](http://www.sgs.com/terms_e-document.htm). Attention is drawn to the limitation of liability, indemnification and jurisdiction issues defined therein. Any holder of this document is advised that information contained hereon reflects the Company's findings at the time of its intervention only and within the limits of Client's instructions, if any. The Company's sole responsibility is to its Client and this document does not exonerate parties to a transaction from exercising all their rights and obligations under the transaction documents. This document cannot be reproduced except in full, without prior written approval of the Company. Any unauthorized alteration, forgery or falsification of the content or appearance of this document is unlawful and offenders may be prosecuted to the fullest extent of the law.

Operation Band	:GPRS 850	Temp./Humi.	:24 deg_C / 61 RH
Fundamental Frequency	:848.8 MHz	Engineer	:Tin
Operation Mode	:Tx CH HIGH		
EUT Pol.	:E2 Plane	Measurement Antenna Pol.	:VERTICAL

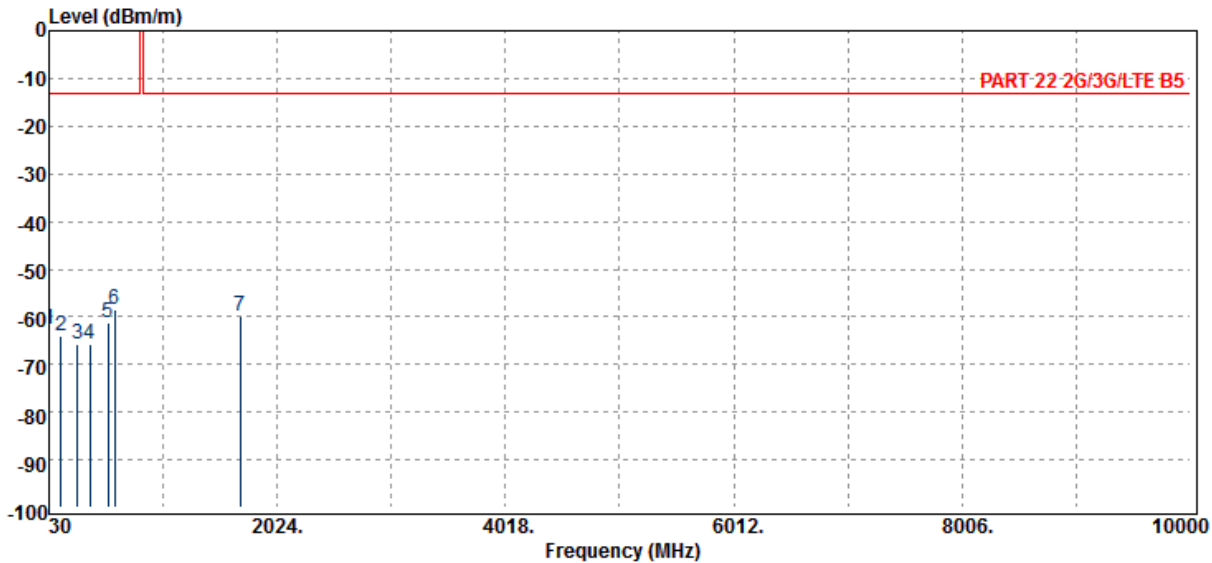

Freq. MHz	ERP/EIRP dBm	SG Output Level dBm	Antenna Gain dBd/dBi	Cable Loss dB	Limit dBm	Margin dB
30.00	-62.52	-47.36	-14.58	-0.58	-13.00	-49.52
134.76	-64.18	-60.82	-2.12	-1.23	-13.00	-51.18
282.20	-65.85	-67.52	3.42	-1.75	-13.00	-52.85
386.96	-65.76	-67.49	3.75	-2.02	-13.00	-52.76
548.95	-61.37	-63.38	3.98	-1.97	-13.00	-48.37
604.24	-58.56	-59.98	3.56	-2.14	-13.00	-45.56
1697.60	-59.90	-62.61	7.14	-4.43	-13.00	-46.90

Unless otherwise stated the results shown in this test report refer only to the sample(s) tested and such sample(s) are retained for 90 days only.

除非另有說明，此報告結果僅對測試之樣品負責，同時此樣品僅保留90天。本報告未經本公司書面許可，不可部份複製。

This document is issued by the Company subject to its General Conditions of Service printed overleaf, available on request or accessible at [www.sgs.com/terms\\_and\\_conditions.htm](http://www.sgs.com/terms_and_conditions.htm) and, for electronic format documents, subject to Terms and Conditions for Electronic Documents at [www.sgs.com/terms\\_e-document.htm](http://www.sgs.com/terms_e-document.htm). Attention is drawn to the limitation of liability, indemnification and jurisdiction issues defined therein. Any holder of this document is advised that information contained hereon reflects the Company's findings at the time of its intervention only and within the limits of Client's instructions, if any. The Company's sole responsibility is to its Client and this document does not exonerate parties to a transaction from exercising all their rights and obligations under the transaction documents. This document cannot be reproduced except in full, without prior written approval of the Company. Any unauthorized alteration, forgery or falsification of the content or appearance of this document is unlawful and offenders may be prosecuted to the fullest extent of the law.

Operation Band	:GPRS 850	Temp./Humi.	:24 deg_C / 61 RH
Fundamental Frequency	:848.8 MHz	Engineer	:Tin
Operation Mode	:Tx CH HIGH		
EUT Pol.	:E2 Plane	Measurement Antenna Pol.	:HORIZONTAL

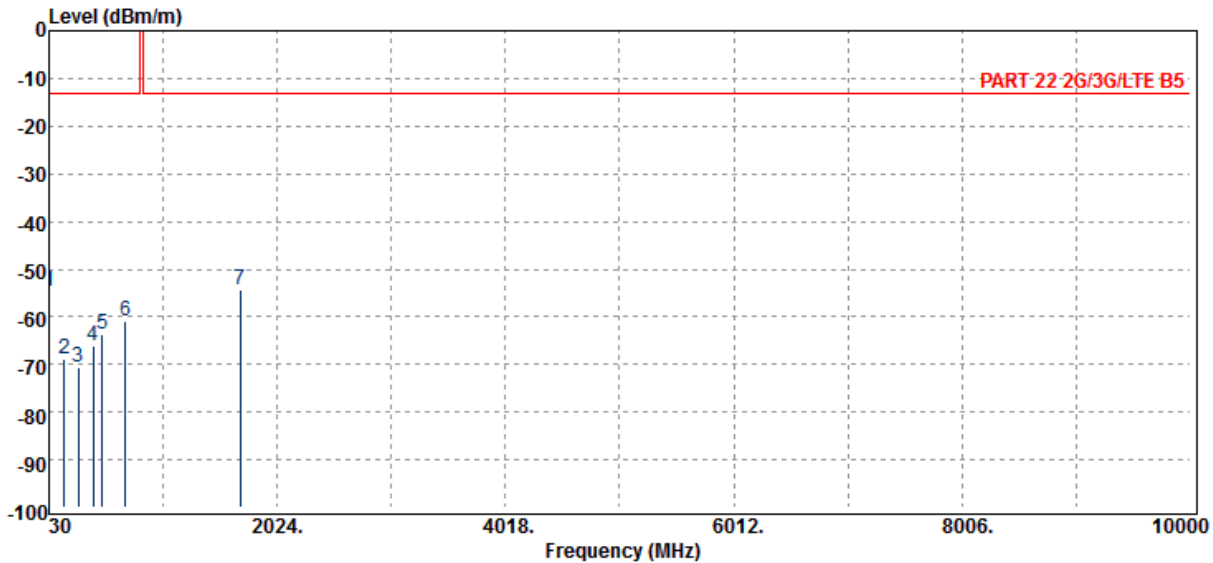

Freq. MHz	ERP/EIRP dBm	SG Output Level dBm	Antenna Gain dBd/dBi	Cable Loss dB	Limit dBm	Margin dB
30.00	-54.54	-39.38	-14.58	-0.58	-13.00	-41.54
160.95	-68.89	-66.40	-1.18	-1.30	-13.00	-55.89
285.11	-70.61	-72.27	3.42	-1.76	-13.00	-57.61
415.09	-66.05	-67.59	3.66	-2.12	-13.00	-53.05
493.66	-63.73	-65.68	3.99	-2.04	-13.00	-50.73
697.36	-61.06	-62.36	3.68	-2.38	-13.00	-48.06
1697.60	-54.31	-57.02	7.14	-4.43	-13.00	-41.31

Unless otherwise stated the results shown in this test report refer only to the sample(s) tested and such sample(s) are retained for 90 days only.

除非另有說明，此報告結果僅對測試之樣品負責，同時此樣品僅保留90天。本報告未經本公司書面許可，不可部份複製。

This document is issued by the Company subject to its General Conditions of Service printed overleaf, available on request or accessible at [www.sgs.com/terms\\_and\\_conditions.htm](http://www.sgs.com/terms_and_conditions.htm) and, for electronic format documents, subject to Terms and Conditions for Electronic Documents at [www.sgs.com/terms\\_e-document.htm](http://www.sgs.com/terms_e-document.htm). Attention is drawn to the limitation of liability, indemnification and jurisdiction issues defined therein. Any holder of this document is advised that information contained hereon reflects the Company's findings at the time of its intervention only and within the limits of Client's instructions, if any. The Company's sole responsibility is to its Client and this document does not exonerate parties to a transaction from exercising all their rights and obligations under the transaction documents. This document cannot be reproduced except in full, without prior written approval of the Company. Any unauthorized alteration, forgery or falsification of the content or appearance of this document is unlawful and offenders may be prosecuted to the fullest extent of the law.

SGS Taiwan Ltd.

No.134,WuKungRoad,NewTaipeiIndustrialPark,WukuDistrict,NewTaipeiCity,Taiwan24803/新北市五股區新北產業園區五工路 134 號

台灣檢驗科技股份有限公司

t (886-2) 2299-3279

f (886-2) 2298-0488

www.tw.sgs.com

Member of SGS Group



**Radiated Spurious Emission Measurement Result: GPRS 1900 Mode**

Operation Band :GPRS 1900 Temp./Humi. :22 deg\_C / 61 RH  
 Fundamental Frequency :1850.2 MHz Engineer :Tin  
 Operation Mode :Tx CH LOW  
 EUT Pol. :E2 Plane Measurement Antenna Pol.:VERTICAL

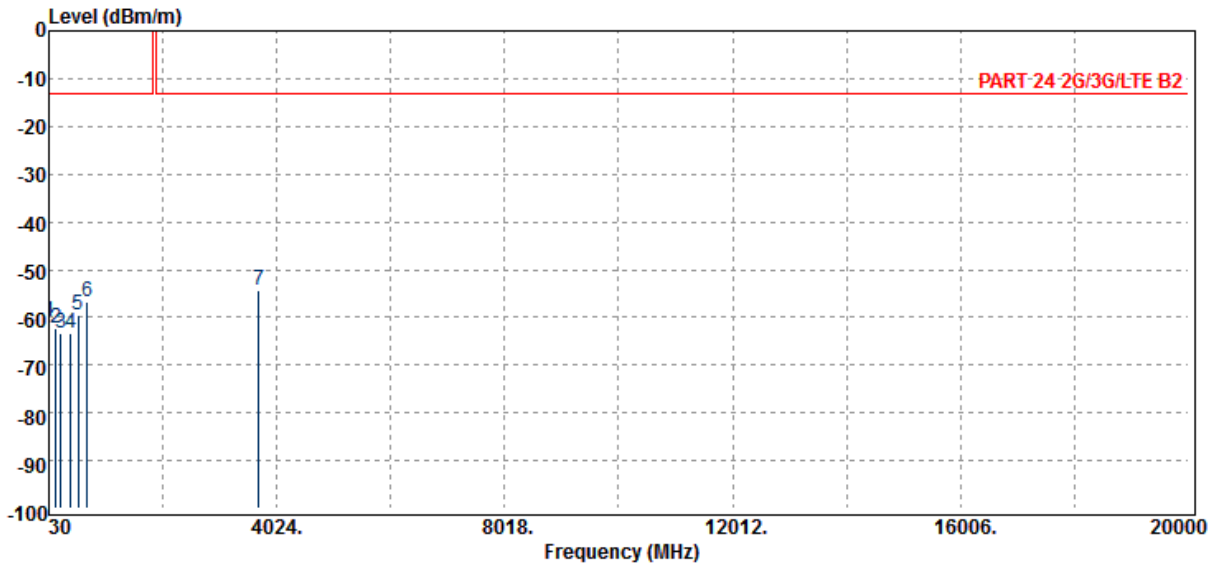

Freq. MHz	ERP/EIRP dBm	SG Output Level dBm	Antenna Gain dBd/dBi	Cable Loss dB	Limit dBm	Margin dB
30.00	-60.74	-47.73	-12.43	-0.58	-13.00	-47.74
158.04	-62.19	-61.69	0.80	-1.30	-13.00	-49.19
240.49	-63.24	-67.20	5.63	-1.67	-13.00	-50.24
416.06	-63.20	-66.89	5.81	-2.12	-13.00	-50.20
544.10	-59.35	-63.70	6.14	-1.79	-13.00	-46.35
697.36	-56.83	-60.28	5.83	-2.38	-13.00	-43.83
3700.40	-54.18	-59.83	12.57	-6.91	-13.00	-41.18

Unless otherwise stated the results shown in this test report refer only to the sample(s) tested and such sample(s) are retained for 90 days only.

除非另有說明，此報告結果僅對測試之樣品負責，同時此樣品僅保留90天。本報告未經本公司書面許可，不可部份複製。

This document is issued by the Company subject to its General Conditions of Service printed overleaf, available on request or accessible at [www.sgs.com/terms\\_and\\_conditions.htm](http://www.sgs.com/terms_and_conditions.htm) and, for electronic format documents, subject to Terms and Conditions for Electronic Documents at [www.sgs.com/terms\\_e-document.htm](http://www.sgs.com/terms_e-document.htm). Attention is drawn to the limitation of liability, indemnification and jurisdiction issues defined therein. Any holder of this document is advised that information contained hereon reflects the Company's findings at the time of its intervention only and within the limits of Client's instructions, if any. The Company's sole responsibility is to its Client and this document does not exonerate parties to a transaction from exercising all their rights and obligations under the transaction documents. This document cannot be reproduced except in full, without prior written approval of the Company. Any unauthorized alteration, forgery or falsification of the content or appearance of this document is unlawful and offenders may be prosecuted to the fullest extent of the law.

SGS Taiwan Ltd.

No.134,WuKungRoad,NewTaipeiIndustrialPark,WukuDistrict,NewTaipeiCity,Taiwan24803/新北市五股區新北產業園區五工路 134 號

台灣檢驗科技股份有限公司

t (886-2) 2299-3279

f (886-2) 2298-0488

www.tw.sgs.com

Member of SGS Group

Operation Band	:GPRS 1900	Temp./Humi.	:22 deg_C / 61 RH
Fundamental Frequency	:1850.2 MHz	Engineer	:Tin
Operation Mode	:Tx CH LOW	Measurement	Antenna :HORIZONTAL
EUT Pol.	:E2 Plane	Pol.	

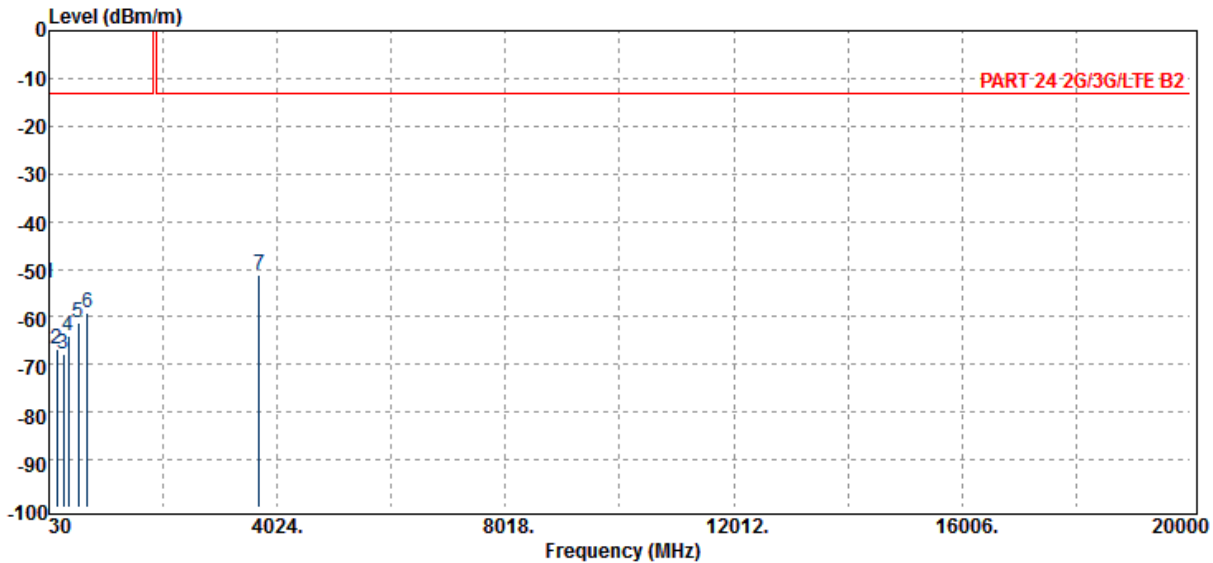

Freq. MHz	ERP/EIRP dBm	SG Output Level dBm	Antenna Gain dBd/dBi	Cable Loss dB	Limit dBm	Margin dB
30.00	-52.91	-39.90	-12.43	-0.58	-13.00	-39.91
160.95	-66.70	-66.36	0.97	-1.30	-13.00	-53.70
282.20	-67.79	-71.60	5.57	-1.75	-13.00	-54.79
369.50	-63.87	-67.77	5.95	-2.06	-13.00	-50.87
541.19	-61.34	-65.57	6.14	-1.91	-13.00	-48.34
700.27	-59.16	-62.82	5.82	-2.16	-13.00	-46.16
3700.40	-51.15	-56.80	12.57	-6.91	-13.00	-38.15

Unless otherwise stated the results shown in this test report refer only to the sample(s) tested and such sample(s) are retained for 90 days only.

除非另有說明，此報告結果僅對測試之樣品負責，同時此樣品僅保留90天。本報告未經本公司書面許可，不可部份複製。

This document is issued by the Company subject to its General Conditions of Service printed overleaf, available on request or accessible at [www.sgs.com/terms\\_and\\_conditions.htm](http://www.sgs.com/terms_and_conditions.htm) and, for electronic format documents, subject to Terms and Conditions for Electronic Documents at [www.sgs.com/terms\\_e-document.htm](http://www.sgs.com/terms_e-document.htm). Attention is drawn to the limitation of liability, indemnification and jurisdiction issues defined therein. Any holder of this document is advised that information contained hereon reflects the Company's findings at the time of its intervention only and within the limits of Client's instructions, if any. The Company's sole responsibility is to its Client and this document does not exonerate parties to a transaction from exercising all their rights and obligations under the transaction documents. This document cannot be reproduced except in full, without prior written approval of the Company. Any unauthorized alteration, forgery or falsification of the content or appearance of this document is unlawful and offenders may be prosecuted to the fullest extent of the law.

Operation Band	:GPRS 1900	Temp./Humi.	:22 deg_C / 61 RH
Fundamental Frequency	:1880 MHz	Engineer	:Tin
Operation Mode	:Tx CH MID	Measurement Antenna	:VERTICAL
EUT Pol.	:E2 Plane	Pol.	

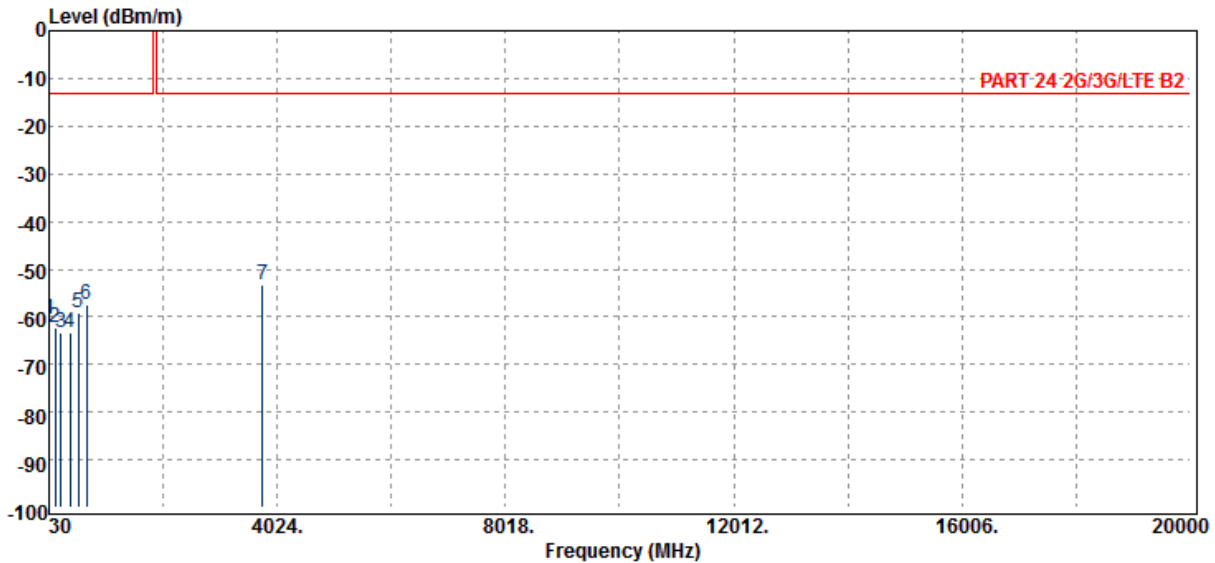

Freq. MHz	ERP/EIRP dBm	SG Output Level dBm	Antenna Gain dBd/dBi	Cable Loss dB	Limit dBm	Margin dB
30.00	-60.43	-47.42	-12.43	-0.58	-13.00	-47.43
144.46	-62.40	-61.19	0.07	-1.28	-13.00	-49.40
239.52	-63.29	-67.24	5.62	-1.67	-13.00	-50.29
393.75	-63.33	-67.14	5.88	-2.07	-13.00	-50.33
548.95	-59.14	-63.30	6.13	-1.97	-13.00	-46.14
686.69	-57.58	-60.24	5.87	-3.21	-13.00	-44.58
3760.00	-53.25	-58.98	12.61	-6.89	-13.00	-40.25

Unless otherwise stated the results shown in this test report refer only to the sample(s) tested and such sample(s) are retained for 90 days only.

除非另有說明，此報告結果僅對測試之樣品負責，同時此樣品僅保留90天。本報告未經本公司書面許可，不可部份複製。

This document is issued by the Company subject to its General Conditions of Service printed overleaf, available on request or accessible at [www.sgs.com/terms\\_and\\_conditions.htm](http://www.sgs.com/terms_and_conditions.htm) and, for electronic format documents, subject to Terms and Conditions for Electronic Documents at [www.sgs.com/terms\\_e-document.htm](http://www.sgs.com/terms_e-document.htm). Attention is drawn to the limitation of liability, indemnification and jurisdiction issues defined therein. Any holder of this document is advised that information contained hereon reflects the Company's findings at the time of its intervention only and within the limits of Client's instructions, if any. The Company's sole responsibility is to its Client and this document does not exonerate parties to a transaction from exercising all their rights and obligations under the transaction documents. This document cannot be reproduced except in full, without prior written approval of the Company. Any unauthorized alteration, forgery or falsification of the content or appearance of this document is unlawful and offenders may be prosecuted to the fullest extent of the law.

SGS Taiwan Ltd.

No.134,WuKungRoad,NewTaipeiIndustrialPark,WukuDistrict,NewTaipeiCity,Taiwan24803/新北市五股區新北產業園區五工路 134 號

台灣檢驗科技股份有限公司

t (886-2) 2299-3279

f (886-2) 2298-0488

www.tw.sgs.com

Member of SGS Group

Operation Band	:GPRS 1900	Temp./Humi.	:22 deg_C / 61 RH
Fundamental Frequency	:1880 MHz	Engineer	:Tin
Operation Mode	:Tx CH MID	Measurement	Antenna :HORIZONTAL
EUT Pol.	:E2 Plane	Pol.	

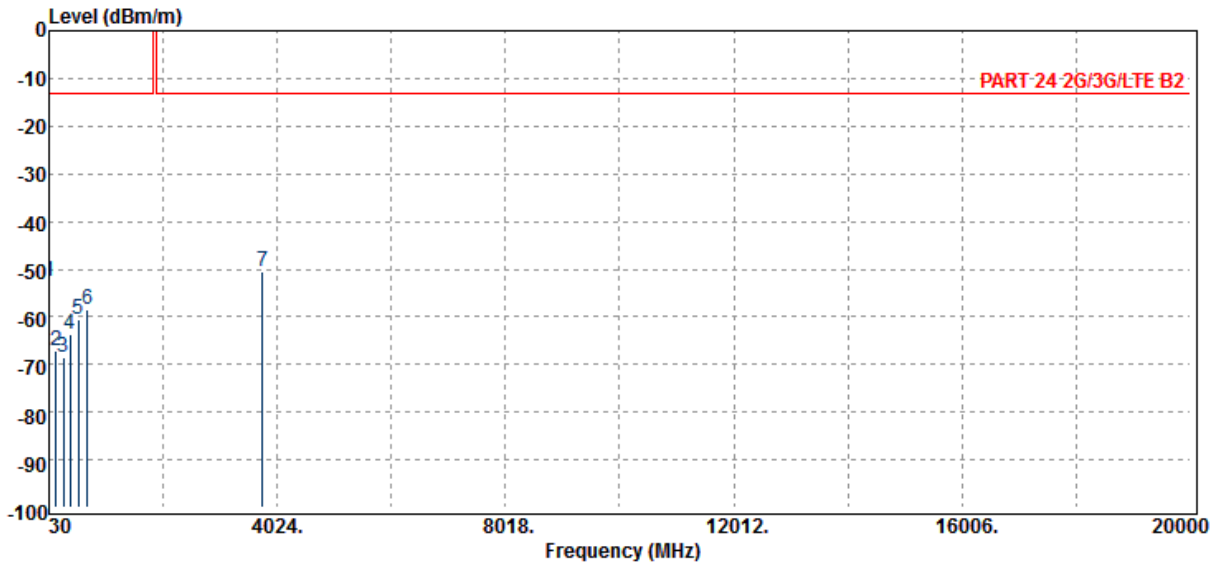

Freq. MHz	ERP/EIRP dBm	SG Output Level dBm	Antenna Gain dBd/dBi	Cable Loss dB	Limit dBm	Margin dB
30.00	-52.43	-39.42	-12.43	-0.58	-13.00	-39.43
149.31	-67.01	-66.03	0.31	-1.29	-13.00	-54.01
277.35	-68.35	-72.20	5.59	-1.74	-13.00	-55.35
391.81	-63.57	-67.40	5.89	-2.06	-13.00	-50.57
547.01	-60.56	-64.83	6.13	-1.86	-13.00	-47.56
696.39	-58.59	-61.97	5.84	-2.46	-13.00	-45.59
3760.00	-50.69	-56.42	12.61	-6.89	-13.00	-37.69

Unless otherwise stated the results shown in this test report refer only to the sample(s) tested and such sample(s) are retained for 90 days only.

除非另有說明，此報告結果僅對測試之樣品負責，同時此樣品僅保留90天。本報告未經本公司書面許可，不可部份複製。

This document is issued by the Company subject to its General Conditions of Service printed overleaf, available on request or accessible at [www.sgs.com/terms\\_and\\_conditions.htm](http://www.sgs.com/terms_and_conditions.htm) and, for electronic format documents, subject to Terms and Conditions for Electronic Documents at [www.sgs.com/terms\\_e-document.htm](http://www.sgs.com/terms_e-document.htm). Attention is drawn to the limitation of liability, indemnification and jurisdiction issues defined therein. Any holder of this document is advised that information contained hereon reflects the Company's findings at the time of its intervention only and within the limits of Client's instructions, if any. The Company's sole responsibility is to its Client and this document does not exonerate parties to a transaction from exercising all their rights and obligations under the transaction documents. This document cannot be reproduced except in full, without prior written approval of the Company. Any unauthorized alteration, forgery or falsification of the content or appearance of this document is unlawful and offenders may be prosecuted to the fullest extent of the law.

Operation Band	:GPRS 1900	Temp./Humi.	:22 deg_C / 61 RH
Fundamental Frequency	:1909.8 MHz	Engineer	:Tin
Operation Mode	:Tx CH HIGH	Measurement Antenna	:VERTICAL
EUT Pol.	:E2 Plane	Pol.	

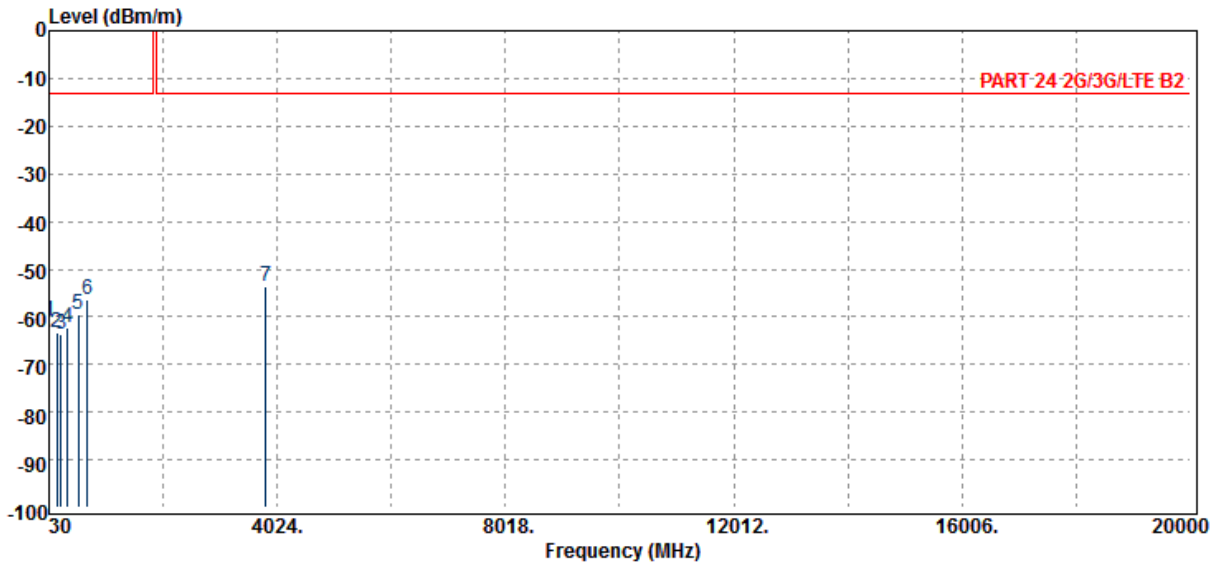

Freq. MHz	ERP/EIRP dBm	SG Output Level dBm	Antenna Gain dBd/dBi	Cable Loss dB	Limit dBm	Margin dB
30.00	-61.05	-48.04	-12.43	-0.58	-13.00	-48.05
172.59	-63.17	-63.78	1.95	-1.34	-13.00	-50.17
243.40	-63.80	-67.77	5.65	-1.68	-13.00	-50.80
359.80	-62.35	-66.27	5.98	-2.06	-13.00	-49.35
537.31	-59.48	-63.56	6.15	-2.07	-13.00	-46.48
699.30	-56.30	-59.90	5.83	-2.24	-13.00	-43.30
3819.60	-53.73	-59.37	12.66	-7.02	-13.00	-40.73

Unless otherwise stated the results shown in this test report refer only to the sample(s) tested and such sample(s) are retained for 90 days only.

除非另有說明，此報告結果僅對測試之樣品負責，同時此樣品僅保留90天。本報告未經本公司書面許可，不可部份複製。

This document is issued by the Company subject to its General Conditions of Service printed overleaf, available on request or accessible at [www.sgs.com/terms\\_and\\_conditions.htm](http://www.sgs.com/terms_and_conditions.htm) and, for electronic format documents, subject to Terms and Conditions for Electronic Documents at [www.sgs.com/terms\\_e-document.htm](http://www.sgs.com/terms_e-document.htm). Attention is drawn to the limitation of liability, indemnification and jurisdiction issues defined therein. Any holder of this document is advised that information contained hereon reflects the Company's findings at the time of its intervention only and within the limits of Client's instructions, if any. The Company's sole responsibility is to its Client and this document does not exonerate parties to a transaction from exercising all their rights and obligations under the transaction documents. This document cannot be reproduced except in full, without prior written approval of the Company. Any unauthorized alteration, forgery or falsification of the content or appearance of this document is unlawful and offenders may be prosecuted to the fullest extent of the law.

Operation Band	:GPRS 1900	Temp./Humi.	:22 deg_C / 61 RH
Fundamental Frequency	:1909.8 MHz	Engineer	:Tin
Operation Mode	:Tx CH HIGH	Measurement Antenna	:HORIZONTAL
EUT Pol.	:E2 Plane	Pol.	

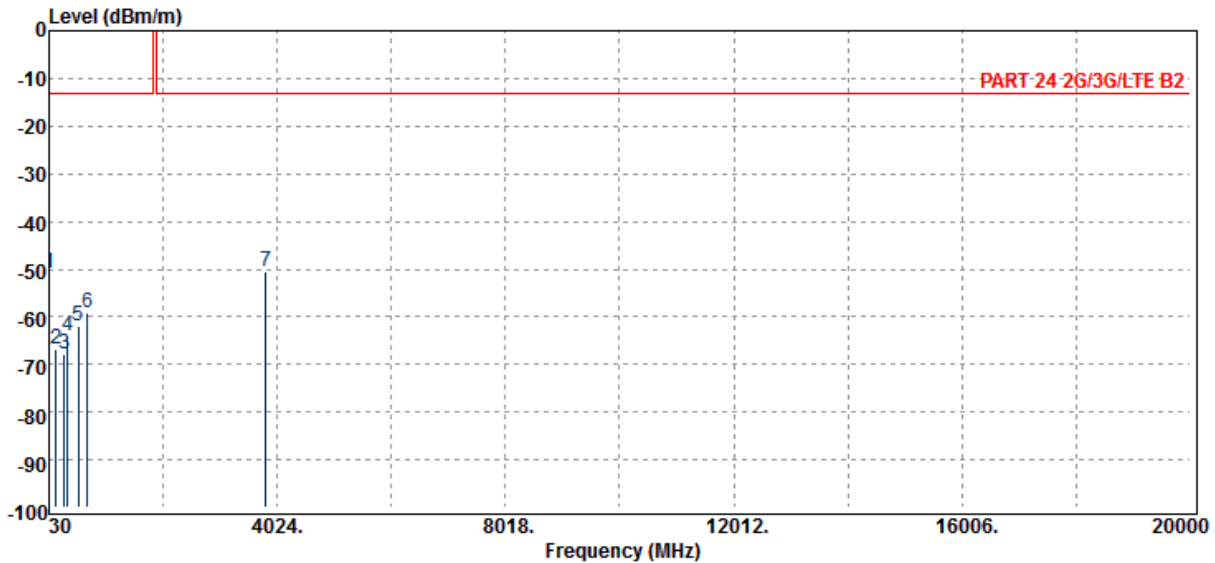

Freq. MHz	ERP/EIRP dBm	SG Output Level dBm	Antenna Gain dBd/dBi	Cable Loss dB	Limit dBm	Margin dB
30.00	-50.95	-37.94	-12.43	-0.58	-13.00	-37.95
151.25	-66.81	-65.93	0.42	-1.29	-13.00	-53.81
296.75	-67.91	-71.80	5.70	-1.81	-13.00	-54.91
359.80	-63.93	-67.85	5.98	-2.06	-13.00	-50.93
547.01	-61.87	-66.14	6.13	-1.86	-13.00	-48.87
696.39	-59.30	-62.68	5.84	-2.46	-13.00	-46.30
3819.60	-50.61	-56.25	12.66	-7.02	-13.00	-37.61

Unless otherwise stated the results shown in this test report refer only to the sample(s) tested and such sample(s) are retained for 90 days only.

除非另有說明，此報告結果僅對測試之樣品負責，同時此樣品僅保留90天。本報告未經本公司書面許可，不可部份複製。

This document is issued by the Company subject to its General Conditions of Service printed overleaf, available on request or accessible at [www.sgs.com/terms\\_and\\_conditions.htm](http://www.sgs.com/terms_and_conditions.htm) and, for electronic format documents, subject to Terms and Conditions for Electronic Documents at [www.sgs.com/terms\\_e-document.htm](http://www.sgs.com/terms_e-document.htm). Attention is drawn to the limitation of liability, indemnification and jurisdiction issues defined therein. Any holder of this document is advised that information contained hereon reflects the Company's findings at the time of its intervention only and within the limits of Client's instructions, if any. The Company's sole responsibility is to its Client and this document does not exonerate parties to a transaction from exercising all their rights and obligations under the transaction documents. This document cannot be reproduced except in full, without prior written approval of the Company. Any unauthorized alteration, forgery or falsification of the content or appearance of this document is unlawful and offenders may be prosecuted to the fullest extent of the law.

### Radiated Spurious Emission Measurement Result: WCDMA Band 2 Mode

Operation Band :WCDMA B2 Temp./Humi. :22 deg\_C / 61 RH  
 Fundamental Frequency :1852.4 MHz Engineer :Tin  
 Operation Mode :Tx CH LOW  
 EUT Pol. :E2 Plane Measurement Antenna Pol.:VERTICAL

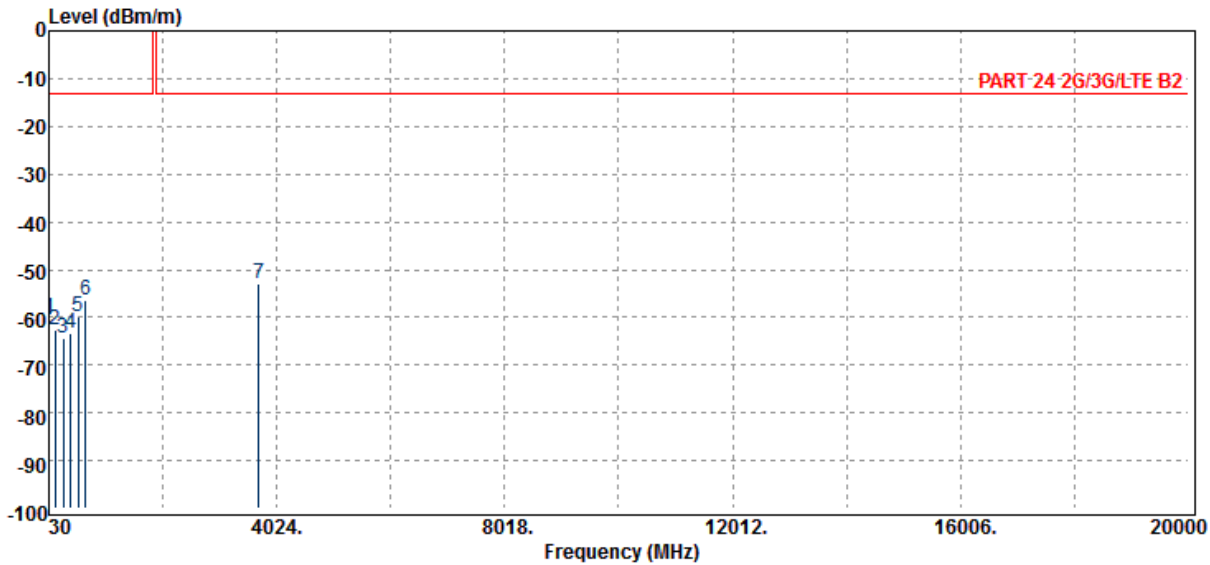

Freq. MHz	ERP/EIRP dBm	SG Output Level dBm	Antenna Gain dBd/dBi	Cable Loss dB	Limit dBm	Margin dB
30.00	-60.11	-47.10	-12.43	-0.58	-13.00	-47.11
139.61	-62.58	-61.18	-0.14	-1.26	-13.00	-49.58
277.35	-64.46	-68.31	5.59	-1.74	-13.00	-51.46
411.21	-63.43	-67.12	5.82	-2.13	-13.00	-50.43
539.25	-59.84	-63.99	6.15	-1.99	-13.00	-46.84
679.90	-56.28	-59.18	5.89	-2.99	-13.00	-43.28
3704.80	-53.07	-58.73	12.57	-6.90	-13.00	-40.07

Unless otherwise stated the results shown in this test report refer only to the sample(s) tested and such sample(s) are retained for 90 days only.

除非另有說明，此報告結果僅對測試之樣品負責，同時此樣品僅保留90天。本報告未經本公司書面許可，不可部份複製。

This document is issued by the Company subject to its General Conditions of Service printed overleaf, available on request or accessible at [www.sgs.com/terms\\_and\\_conditions.htm](http://www.sgs.com/terms_and_conditions.htm) and, for electronic format documents, subject to Terms and Conditions for Electronic Documents at [www.sgs.com/terms\\_e-document.htm](http://www.sgs.com/terms_e-document.htm). Attention is drawn to the limitation of liability, indemnification and jurisdiction issues defined therein. Any holder of this document is advised that information contained hereon reflects the Company's findings at the time of its intervention only and within the limits of Client's instructions, if any. The Company's sole responsibility is to its Client and this document does not exonerate parties to a transaction from exercising all their rights and obligations under the transaction documents. This document cannot be reproduced except in full, without prior written approval of the Company. Any unauthorized alteration, forgery or falsification of the content or appearance of this document is unlawful and offenders may be prosecuted to the fullest extent of the law.

Operation Band	:WCDMA B2	Temp./Humi.	:22 deg_C / 61 RH
Fundamental Frequency	:1852.4 MHz	Engineer	:Tin
Operation Mode	:Tx CH LOW	Measurement Antenna	:HORIZONTAL
EUT Pol.	:E2 Plane	Pol.	

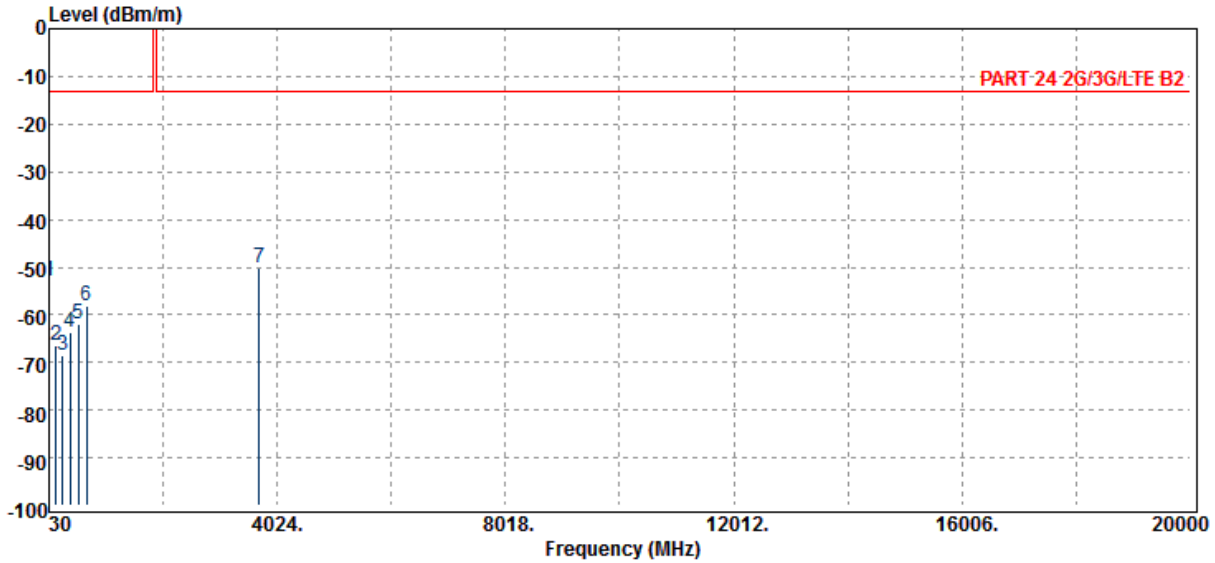

Freq. MHz	ERP/EIRP dBm	SG Output Level dBm	Antenna Gain dBd/dBi	Cable Loss dB	Limit dBm	Margin dB
30.00	-52.93	-39.92	-12.43	-0.58	-13.00	-39.93
148.34	-66.50	-65.48	0.26	-1.29	-13.00	-53.50
274.44	-68.37	-72.25	5.61	-1.73	-13.00	-55.37
398.60	-63.70	-67.46	5.87	-2.10	-13.00	-50.70
542.16	-61.82	-66.10	6.14	-1.87	-13.00	-48.82
694.45	-58.20	-61.43	5.84	-2.61	-13.00	-45.20
3704.80	-50.23	-55.90	12.57	-6.90	-13.00	-37.23

Unless otherwise stated the results shown in this test report refer only to the sample(s) tested and such sample(s) are retained for 90 days only.

除非另有說明，此報告結果僅對測試之樣品負責，同時此樣品僅保留90天。本報告未經本公司書面許可，不可部份複製。

This document is issued by the Company subject to its General Conditions of Service printed overleaf, available on request or accessible at [www.sgs.com/terms\\_and\\_conditions.htm](http://www.sgs.com/terms_and_conditions.htm) and, for electronic format documents, subject to Terms and Conditions for Electronic Documents at [www.sgs.com/terms\\_e-document.htm](http://www.sgs.com/terms_e-document.htm). Attention is drawn to the limitation of liability, indemnification and jurisdiction issues defined therein. Any holder of this document is advised that information contained hereon reflects the Company's findings at the time of its intervention only and within the limits of Client's instructions, if any. The Company's sole responsibility is to its Client and this document does not exonerate parties to a transaction from exercising all their rights and obligations under the transaction documents. This document cannot be reproduced except in full, without prior written approval of the Company. Any unauthorized alteration, forgery or falsification of the content or appearance of this document is unlawful and offenders may be prosecuted to the fullest extent of the law.



Operation Band	:WCDMA B2	Temp./Humi.	:22 deg_C / 61 RH
Fundamental Frequency	:1880 MHz	Engineer	:Tin
Operation Mode	:Tx CH MID	Measurement Antenna	:VERTICAL
EUT Pol.	:E2 Plane	Pol.	

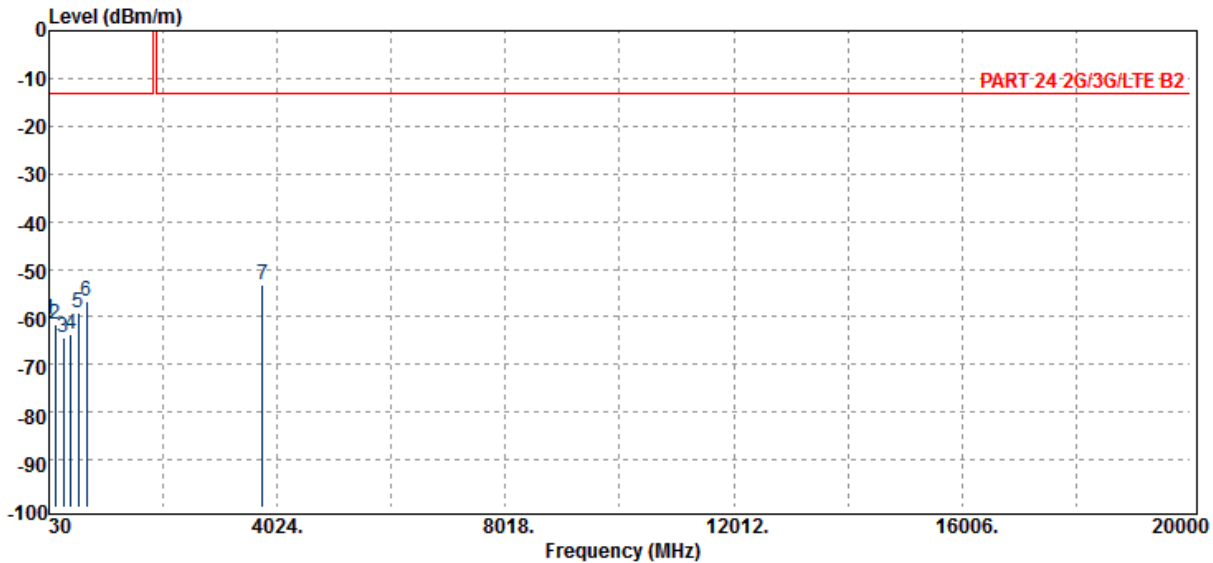

Freq. MHz	ERP/EIRP dBm	SG Output Level dBm	Antenna Gain dBd/dBi	Cable Loss dB	Limit dBm	Margin dB
30.00	-60.63	-47.62	-12.43	-0.58	-13.00	-47.63
141.55	-61.50	-60.16	-0.07	-1.27	-13.00	-48.50
285.11	-64.47	-68.28	5.57	-1.76	-13.00	-51.47
418.00	-63.58	-67.26	5.80	-2.11	-13.00	-50.58
537.31	-59.06	-63.14	6.15	-2.07	-13.00	-46.06
686.69	-56.84	-59.50	5.87	-3.21	-13.00	-43.84
3760.00	-53.35	-59.08	12.61	-6.89	-13.00	-40.35

Unless otherwise stated the results shown in this test report refer only to the sample(s) tested and such sample(s) are retained for 90 days only.

除非另有說明，此報告結果僅對測試之樣品負責，同時此樣品僅保留90天。本報告未經本公司書面許可，不可部份複製。

This document is issued by the Company subject to its General Conditions of Service printed overleaf, available on request or accessible at [www.sgs.com/terms\\_and\\_conditions.htm](http://www.sgs.com/terms_and_conditions.htm) and, for electronic format documents, subject to Terms and Conditions for Electronic Documents at [www.sgs.com/terms\\_e-document.htm](http://www.sgs.com/terms_e-document.htm). Attention is drawn to the limitation of liability, indemnification and jurisdiction issues defined therein. Any holder of this document is advised that information contained hereon reflects the Company's findings at the time of its intervention only and within the limits of Client's instructions, if any. The Company's sole responsibility is to its Client and this document does not exonerate parties to a transaction from exercising all their rights and obligations under the transaction documents. This document cannot be reproduced except in full, without prior written approval of the Company. Any unauthorized alteration, forgery or falsification of the content or appearance of this document is unlawful and offenders may be prosecuted to the fullest extent of the law.

Operation Band	:WCDMA B2	Temp./Humi.	:22 deg_C / 61 RH
Fundamental Frequency	:1880 MHz	Engineer	:Tin
Operation Mode	:Tx CH MID	Measurement Antenna	:HORIZONTAL
EUT Pol.	:E2 Plane	Pol.	

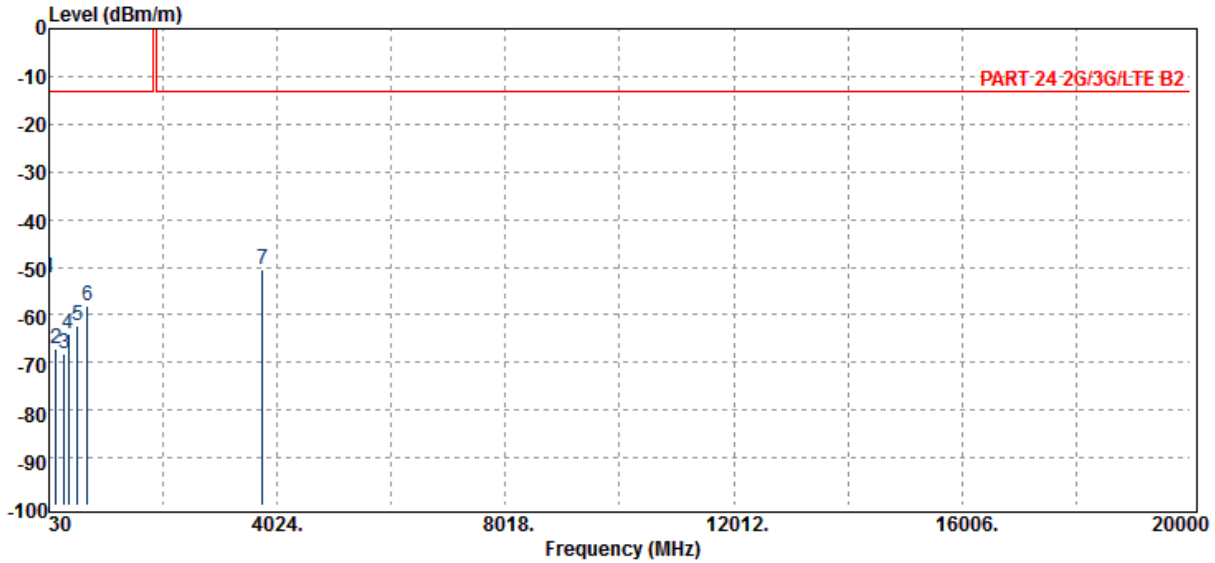

Freq. MHz	ERP/EIRP dBm	SG Output Level dBm	Antenna Gain dBd/dBi	Cable Loss dB	Limit dBm	Margin dB
30.00	-52.36	-39.35	-12.43	-0.58	-13.00	-39.36
158.04	-66.97	-66.47	0.80	-1.30	-13.00	-53.97
298.69	-68.15	-72.07	5.74	-1.82	-13.00	-55.15
364.65	-63.95	-67.84	5.96	-2.07	-13.00	-50.95
532.46	-62.44	-66.33	6.16	-2.27	-13.00	-49.44
697.36	-58.21	-61.66	5.83	-2.38	-13.00	-45.21
3760.00	-50.59	-56.32	12.61	-6.89	-13.00	-37.59

Unless otherwise stated the results shown in this test report refer only to the sample(s) tested and such sample(s) are retained for 90 days only.

除非另有說明，此報告結果僅對測試之樣品負責，同時此樣品僅保留90天。本報告未經本公司書面許可，不可部份複製。

This document is issued by the Company subject to its General Conditions of Service printed overleaf, available on request or accessible at [www.sgs.com/terms\\_and\\_conditions.htm](http://www.sgs.com/terms_and_conditions.htm) and, for electronic format documents, subject to Terms and Conditions for Electronic Documents at [www.sgs.com/terms\\_e-document.htm](http://www.sgs.com/terms_e-document.htm). Attention is drawn to the limitation of liability, indemnification and jurisdiction issues defined therein. Any holder of this document is advised that information contained hereon reflects the Company's findings at the time of its intervention only and within the limits of Client's instructions, if any. The Company's sole responsibility is to its Client and this document does not exonerate parties to a transaction from exercising all their rights and obligations under the transaction documents. This document cannot be reproduced except in full, without prior written approval of the Company. Any unauthorized alteration, forgery or falsification of the content or appearance of this document is unlawful and offenders may be prosecuted to the fullest extent of the law.

Operation Band	:WCDMA B2	Temp./Humi.	:22 deg_C / 61 RH
Fundamental Frequency	:1907.6 MHz	Engineer	:Tin
Operation Mode	:Tx CH HIGH	Measurement	Antenna:VERTICAL
EUT Pol.	:E2 Plane	Pol.	

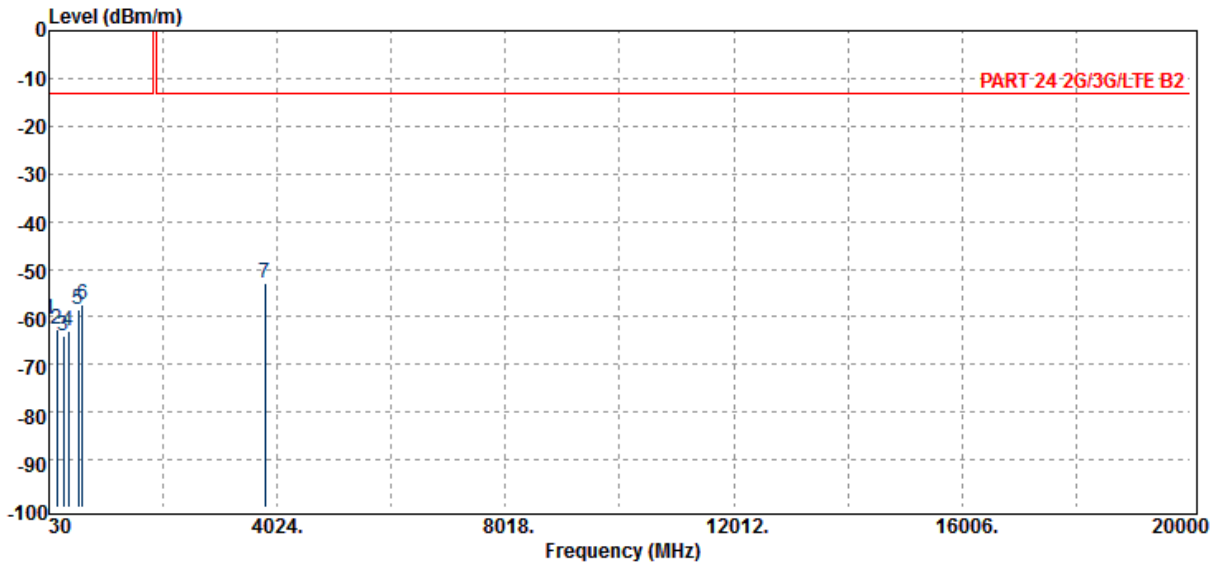

Freq. MHz	ERP/EIRP dBm	SG Output Level dBm	Antenna Gain dBd/dBi	Cable Loss dB	Limit dBm	Margin dB
30.00	-60.72	-47.72	-12.43	-0.58	-13.00	-47.72
165.80	-62.78	-62.74	1.27	-1.31	-13.00	-49.78
280.26	-63.99	-67.81	5.57	-1.75	-13.00	-50.99
376.29	-63.11	-67.01	5.93	-2.03	-13.00	-50.11
542.16	-58.59	-62.86	6.14	-1.87	-13.00	-45.59
619.76	-57.33	-60.50	5.81	-2.63	-13.00	-44.33
3815.20	-52.78	-58.43	12.66	-7.00	-13.00	-39.78

Unless otherwise stated the results shown in this test report refer only to the sample(s) tested and such sample(s) are retained for 90 days only.

除非另有說明，此報告結果僅對測試之樣品負責，同時此樣品僅保留90天。本報告未經本公司書面許可，不可部份複製。

This document is issued by the Company subject to its General Conditions of Service printed overleaf, available on request or accessible at [www.sgs.com/terms\\_and\\_conditions.htm](http://www.sgs.com/terms_and_conditions.htm) and, for electronic format documents, subject to Terms and Conditions for Electronic Documents at [www.sgs.com/terms\\_e-document.htm](http://www.sgs.com/terms_e-document.htm). Attention is drawn to the limitation of liability, indemnification and jurisdiction issues defined therein. Any holder of this document is advised that information contained hereon reflects the Company's findings at the time of its intervention only and within the limits of Client's instructions, if any. The Company's sole responsibility is to its Client and this document does not exonerate parties to a transaction from exercising all their rights and obligations under the transaction documents. This document cannot be reproduced except in full, without prior written approval of the Company. Any unauthorized alteration, forgery or falsification of the content or appearance of this document is unlawful and offenders may be prosecuted to the fullest extent of the law.

Operation Band	:WCDMA B2	Temp./Humi.	:22 deg_C / 61 RH
Fundamental Frequency	:1907.6 MHz	Engineer	:Tin
Operation Mode	:Tx CH HIGH	Measurement Antenna	:HORIZONTAL
EUT Pol.	:E2 Plane	Pol.	

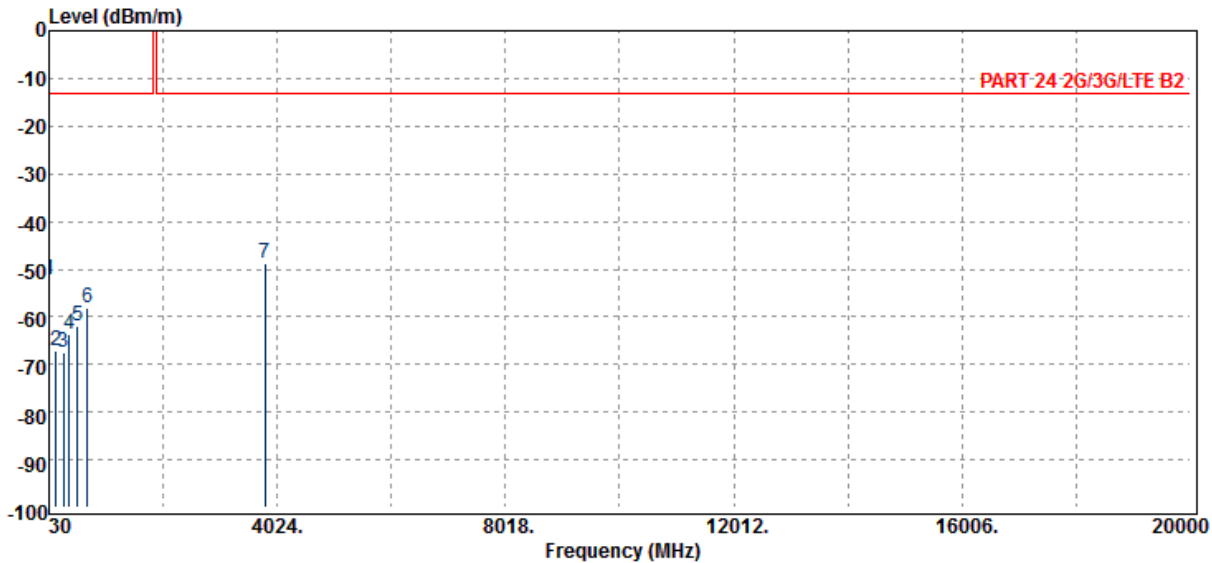

Freq. MHz	ERP/EIRP dBm	SG Output Level dBm	Antenna Gain dBd/dBi	Cable Loss dB	Limit dBm	Margin dB
30.00	-52.15	-39.14	-12.43	-0.58	-13.00	-39.15
146.40	-67.16	-66.04	0.17	-1.29	-13.00	-54.16
282.20	-67.55	-71.37	5.57	-1.75	-13.00	-54.55
386.96	-63.59	-67.46	5.90	-2.02	-13.00	-50.59
531.49	-61.96	-65.81	6.16	-2.31	-13.00	-48.96
696.39	-58.10	-61.48	5.84	-2.46	-13.00	-45.10
3815.20	-48.85	-54.50	12.66	-7.00	-13.00	-35.85

Unless otherwise stated the results shown in this test report refer only to the sample(s) tested and such sample(s) are retained for 90 days only.

除非另有說明，此報告結果僅對測試之樣品負責，同時此樣品僅保留90天。本報告未經本公司書面許可，不可部份複製。

This document is issued by the Company subject to its General Conditions of Service printed overleaf, available on request or accessible at [www.sgs.com/terms\\_and\\_conditions.htm](http://www.sgs.com/terms_and_conditions.htm) and, for electronic format documents, subject to Terms and Conditions for Electronic Documents at [www.sgs.com/terms\\_e-document.htm](http://www.sgs.com/terms_e-document.htm). Attention is drawn to the limitation of liability, indemnification and jurisdiction issues defined therein. Any holder of this document is advised that information contained hereon reflects the Company's findings at the time of its intervention only and within the limits of Client's instructions, if any. The Company's sole responsibility is to its Client and this document does not exonerate parties to a transaction from exercising all their rights and obligations under the transaction documents. This document cannot be reproduced except in full, without prior written approval of the Company. Any unauthorized alteration, forgery or falsification of the content or appearance of this document is unlawful and offenders may be prosecuted to the fullest extent of the law.

### Radiated Spurious Emission Measurement Result: HSDPA Band 4 Mode

Operation Band :HSDPA B4 Temp./Humi. :22 deg\_C / 62 RH  
 Fundamental Frequency :1712.4 MHz Engineer :Tin  
 Operation Mode :Tx CH LOW  
 EUT Pol. :E2 Plane Measurement Antenna Pol.:VERTICAL

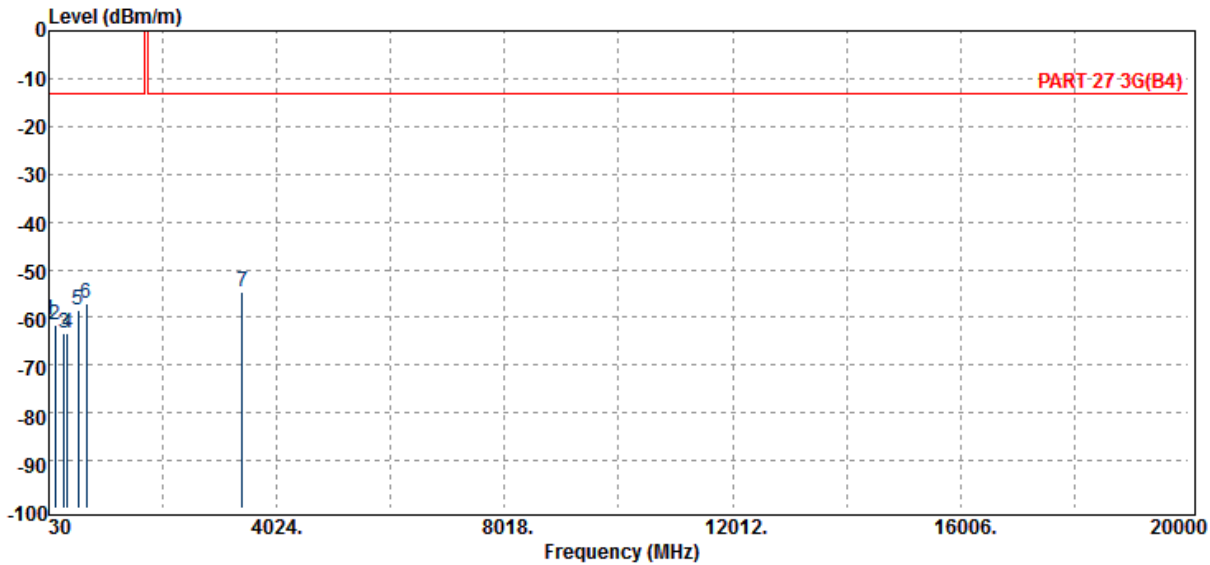

Freq. MHz	ERP/EIRP dBm	SG Output Level dBm	Antenna Gain dBd/dBi	Cable Loss dB	Limit dBm	Margin dB
30.00	-60.67	-47.66	-12.43	-0.58	-13.00	-47.67
144.46	-61.70	-60.49	0.07	-1.28	-13.00	-48.70
299.66	-63.47	-67.41	5.76	-1.82	-13.00	-50.47
350.10	-63.28	-67.26	6.00	-2.02	-13.00	-50.28
541.19	-58.36	-62.60	6.14	-1.91	-13.00	-45.36
689.60	-57.07	-59.95	5.86	-2.98	-13.00	-44.07
3424.80	-54.54	-60.23	12.23	-6.54	-13.00	-41.54

Unless otherwise stated the results shown in this test report refer only to the sample(s) tested and such sample(s) are retained for 90 days only.

除非另有說明，此報告結果僅對測試之樣品負責，同時此樣品僅保留90天。本報告未經本公司書面許可，不可部份複製。

This document is issued by the Company subject to its General Conditions of Service printed overleaf, available on request or accessible at [www.sgs.com/terms\\_and\\_conditions.htm](http://www.sgs.com/terms_and_conditions.htm) and, for electronic format documents, subject to Terms and Conditions for Electronic Documents at [www.sgs.com/terms\\_e-document.htm](http://www.sgs.com/terms_e-document.htm). Attention is drawn to the limitation of liability, indemnification and jurisdiction issues defined therein. Any holder of this document is advised that information contained hereon reflects the Company's findings at the time of its intervention only and within the limits of Client's instructions, if any. The Company's sole responsibility is to its Client and this document does not exonerate parties to a transaction from exercising all their rights and obligations under the transaction documents. This document cannot be reproduced except in full, without prior written approval of the Company. Any unauthorized alteration, forgery or falsification of the content or appearance of this document is unlawful and offenders may be prosecuted to the fullest extent of the law.

Operation Band	:HSDPA B4	Temp./Humi.	:22 deg_C / 62 RH
Fundamental Frequency	:1712.4 MHz	Engineer	:Tin
Operation Mode	:Tx CH LOW		
EUT Pol.	:E2 Plane	Measurement Antenna Pol.	:HORIZONTAL

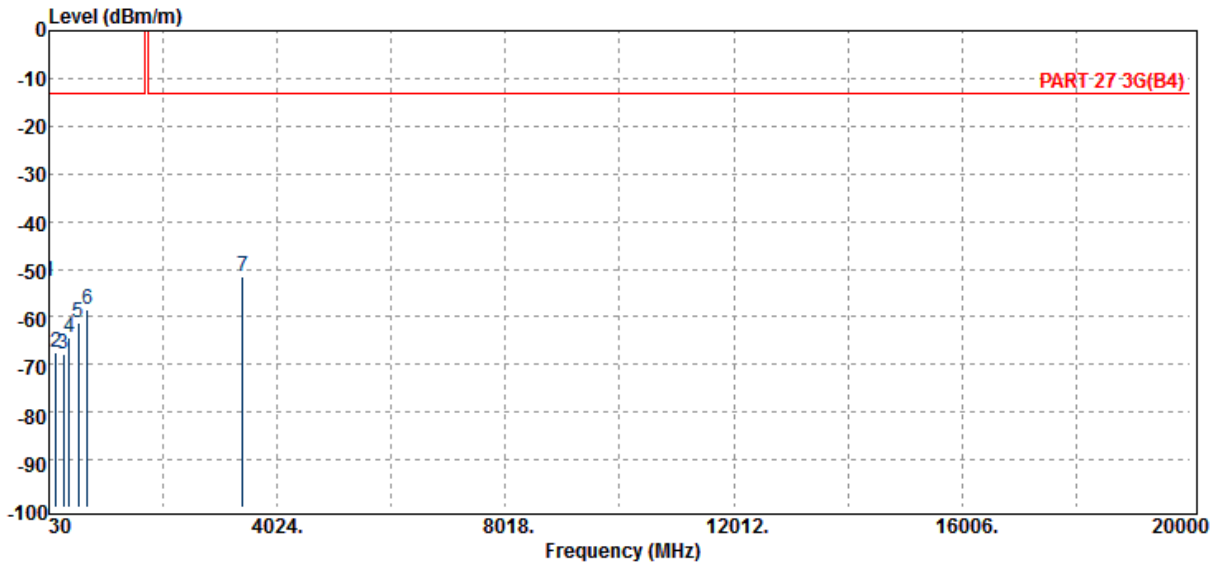

Freq. MHz	ERP/EIRP dBm	SG Output Level dBm	Antenna Gain dBd/dBi	Cable Loss dB	Limit dBm	Margin dB
30.00	-52.60	-39.59	-12.43	-0.58	-13.00	-39.60
153.19	-67.35	-66.58	0.53	-1.30	-13.00	-54.35
284.14	-67.96	-71.77	5.57	-1.76	-13.00	-54.96
377.26	-64.27	-68.17	5.93	-2.03	-13.00	-51.27
542.16	-61.34	-65.61	6.14	-1.87	-13.00	-48.34
696.39	-58.49	-61.86	5.84	-2.46	-13.00	-45.49
3424.80	-51.70	-57.39	12.23	-6.54	-13.00	-38.70

Unless otherwise stated the results shown in this test report refer only to the sample(s) tested and such sample(s) are retained for 90 days only.

除非另有說明，此報告結果僅對測試之樣品負責，同時此樣品僅保留90天。本報告未經本公司書面許可，不可部份複製。

This document is issued by the Company subject to its General Conditions of Service printed overleaf, available on request or accessible at [www.sgs.com/terms\\_and\\_conditions.htm](http://www.sgs.com/terms_and_conditions.htm) and, for electronic format documents, subject to Terms and Conditions for Electronic Documents at [www.sgs.com/terms\\_e-document.htm](http://www.sgs.com/terms_e-document.htm). Attention is drawn to the limitation of liability, indemnification and jurisdiction issues defined therein. Any holder of this document is advised that information contained hereon reflects the Company's findings at the time of its intervention only and within the limits of Client's instructions, if any. The Company's sole responsibility is to its Client and this document does not exonerate parties to a transaction from exercising all their rights and obligations under the transaction documents. This document cannot be reproduced except in full, without prior written approval of the Company. Any unauthorized alteration, forgery or falsification of the content or appearance of this document is unlawful and offenders may be prosecuted to the fullest extent of the law.

Operation Band	:HSDPA B4	Temp./Humi.	:22 deg_C / 62 RH
Fundamental Frequency	:1732.6 MHz	Engineer	:Tin
Operation Mode	:Tx CH MID	Measurement	Antenna:VERTICAL
EUT Pol.	:E2 Plane	Pol.	

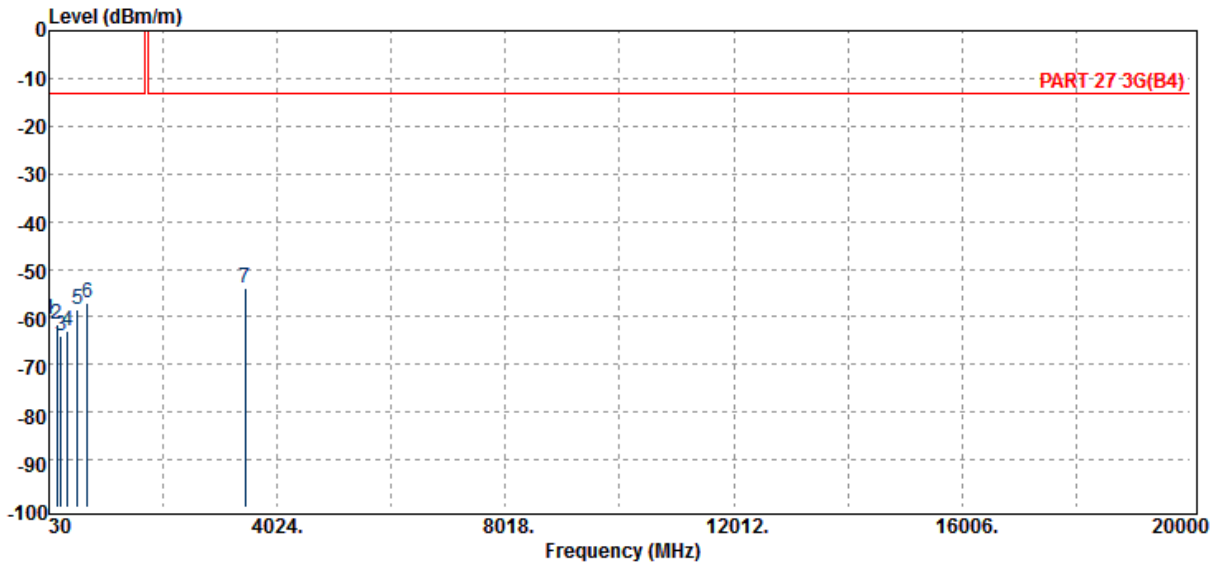

Freq. MHz	ERP/EIRP dBm	SG Output Level dBm	Antenna Gain dBd/dBi	Cable Loss dB	Limit dBm	Margin dB
30.00	-60.54	-47.53	-12.43	-0.58	-13.00	-47.54
160.95	-61.44	-61.10	0.97	-1.30	-13.00	-48.44
241.46	-64.11	-68.07	5.64	-1.68	-13.00	-51.11
357.86	-62.88	-66.81	5.98	-2.05	-13.00	-49.88
532.46	-58.45	-62.34	6.16	-2.27	-13.00	-45.45
699.30	-57.14	-60.73	5.83	-2.24	-13.00	-44.14
3465.20	-53.86	-59.62	12.32	-6.56	-13.00	-40.86

Unless otherwise stated the results shown in this test report refer only to the sample(s) tested and such sample(s) are retained for 90 days only.

除非另有說明，此報告結果僅對測試之樣品負責，同時此樣品僅保留90天。本報告未經本公司書面許可，不可部份複製。

This document is issued by the Company subject to its General Conditions of Service printed overleaf, available on request or accessible at [www.sgs.com/terms\\_and\\_conditions.htm](http://www.sgs.com/terms_and_conditions.htm) and, for electronic format documents, subject to Terms and Conditions for Electronic Documents at [www.sgs.com/terms\\_e-document.htm](http://www.sgs.com/terms_e-document.htm). Attention is drawn to the limitation of liability, indemnification and jurisdiction issues defined therein. Any holder of this document is advised that information contained hereon reflects the Company's findings at the time of its intervention only and within the limits of Client's instructions, if any. The Company's sole responsibility is to its Client and this document does not exonerate parties to a transaction from exercising all their rights and obligations under the transaction documents. This document cannot be reproduced except in full, without prior written approval of the Company. Any unauthorized alteration, forgery or falsification of the content or appearance of this document is unlawful and offenders may be prosecuted to the fullest extent of the law.

SGS Taiwan Ltd.

No.134,WuKungRoad,NewTaipeiIndustrialPark,WukuDistrict,NewTaipeiCity,Taiwan24803/新北市五股區新北產業園區五工路 134 號

台灣檢驗科技股份有限公司

t (886-2) 2299-3279

f (886-2) 2298-0488

www.tw.sgs.com

Member of SGS Group

Operation Band	:HSDPA B4	Temp./Humi.	:22 deg_C / 62 RH
Fundamental Frequency	:1732.6 MHz	Engineer	:Tin
Operation Mode	:Tx CH MID		
EUT Pol.	:E2 Plane	Measurement Antenna Pol.	:HORIZONTAL

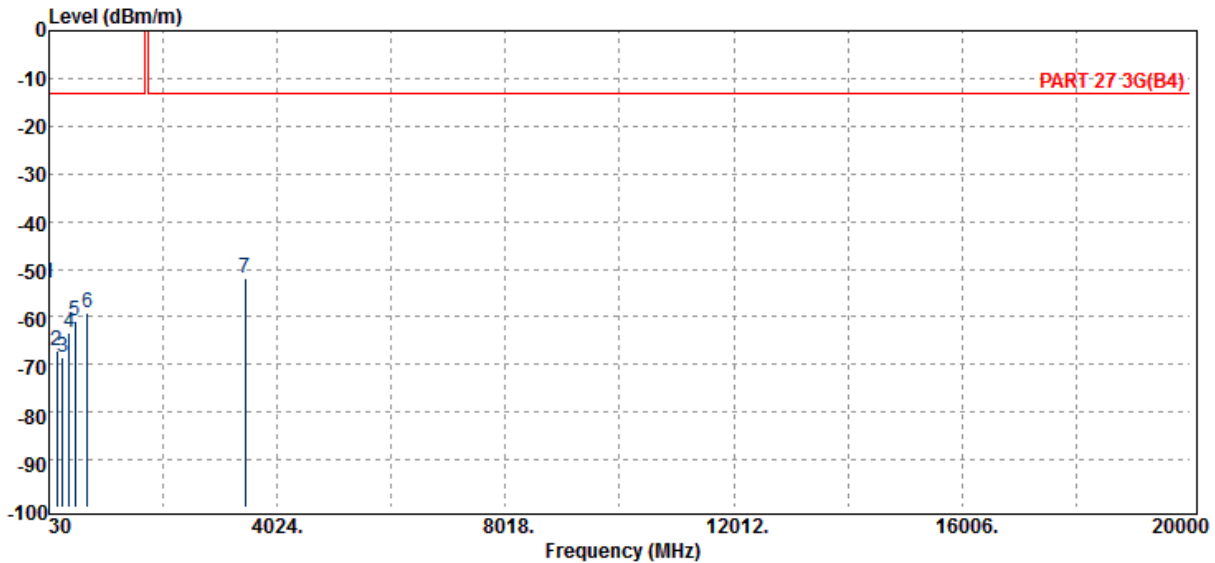

Freq. MHz	ERP/EIRP dBm	SG Output Level dBm	Antenna Gain dBd/dBi	Cable Loss dB	Limit dBm	Margin dB
30.00	-53.01	-40.00	-12.43	-0.58	-13.00	-40.01
163.86	-66.96	-66.81	1.15	-1.31	-13.00	-53.96
274.44	-68.39	-72.27	5.61	-1.73	-13.00	-55.39
388.90	-63.27	-67.13	5.89	-2.04	-13.00	-50.27
487.84	-60.74	-64.93	6.08	-1.89	-13.00	-47.74
696.39	-59.01	-62.38	5.84	-2.46	-13.00	-46.01
3465.20	-51.75	-57.51	12.32	-6.56	-13.00	-38.75

Unless otherwise stated the results shown in this test report refer only to the sample(s) tested and such sample(s) are retained for 90 days only.

除非另有說明，此報告結果僅對測試之樣品負責，同時此樣品僅保留90天。本報告未經本公司書面許可，不可部份複製。

This document is issued by the Company subject to its General Conditions of Service printed overleaf, available on request or accessible at [www.sgs.com/terms\\_and\\_conditions.htm](http://www.sgs.com/terms_and_conditions.htm) and, for electronic format documents, subject to Terms and Conditions for Electronic Documents at [www.sgs.com/terms\\_e-document.htm](http://www.sgs.com/terms_e-document.htm). Attention is drawn to the limitation of liability, indemnification and jurisdiction issues defined therein. Any holder of this document is advised that information contained hereon reflects the Company's findings at the time of its intervention only and within the limits of Client's instructions, if any. The Company's sole responsibility is to its Client and this document does not exonerate parties to a transaction from exercising all their rights and obligations under the transaction documents. This document cannot be reproduced except in full, without prior written approval of the Company. Any unauthorized alteration, forgery or falsification of the content or appearance of this document is unlawful and offenders may be prosecuted to the fullest extent of the law.



Operation Band	:HSDPA B4	Temp./Humi.	:22 deg_C / 62 RH
Fundamental Frequency	:1752.6 MHz	Engineer	:Tin
Operation Mode	:Tx CH HIGH	Measurement	Antenna:VERTICAL
EUT Pol.	:E2 Plane	Pol.	

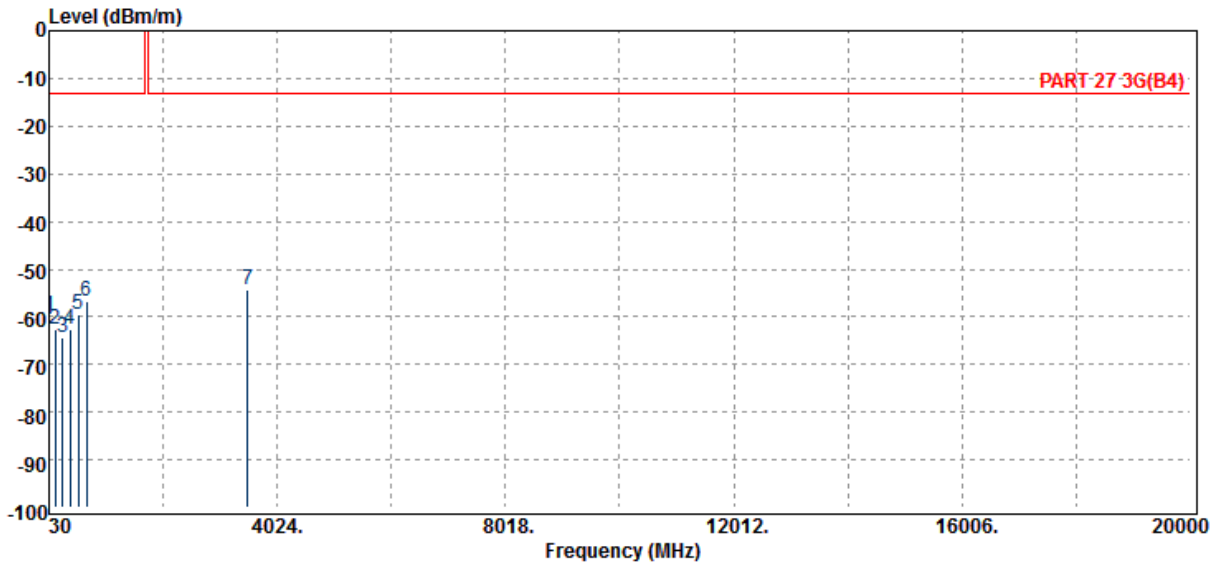

Freq. MHz	ERP/EIRP dBm	SG Output Level dBm	Antenna Gain dBd/dBi	Cable Loss dB	Limit dBm	Margin dB
30.00	-59.78	-46.77	-12.43	-0.58	-13.00	-46.78
143.49	-62.58	-61.32	0.02	-1.28	-13.00	-49.58
270.56	-64.24	-68.17	5.65	-1.72	-13.00	-51.24
401.51	-62.48	-66.21	5.86	-2.13	-13.00	-49.48
547.01	-59.55	-63.82	6.13	-1.86	-13.00	-46.55
689.60	-56.83	-59.71	5.86	-2.98	-13.00	-43.83
3505.20	-54.33	-60.07	12.40	-6.66	-13.00	-41.33

Unless otherwise stated the results shown in this test report refer only to the sample(s) tested and such sample(s) are retained for 90 days only.

除非另有說明，此報告結果僅對測試之樣品負責，同時此樣品僅保留90天。本報告未經本公司書面許可，不可部份複製。

This document is issued by the Company subject to its General Conditions of Service printed overleaf, available on request or accessible at [www.sgs.com/terms\\_and\\_conditions.htm](http://www.sgs.com/terms_and_conditions.htm) and, for electronic format documents, subject to Terms and Conditions for Electronic Documents at [www.sgs.com/terms\\_e-document.htm](http://www.sgs.com/terms_e-document.htm). Attention is drawn to the limitation of liability, indemnification and jurisdiction issues defined therein. Any holder of this document is advised that information contained hereon reflects the Company's findings at the time of its intervention only and within the limits of Client's instructions, if any. The Company's sole responsibility is to its Client and this document does not exonerate parties to a transaction from exercising all their rights and obligations under the transaction documents. This document cannot be reproduced except in full, without prior written approval of the Company. Any unauthorized alteration, forgery or falsification of the content or appearance of this document is unlawful and offenders may be prosecuted to the fullest extent of the law.

SGS Taiwan Ltd.

No.134,WuKungRoad,NewTaipeiIndustrialPark,WukuDistrict,NewTaipeiCity,Taiwan24803/新北市五股區新北產業園區五工路 134 號

台灣檢驗科技股份有限公司

t (886-2) 2299-3279

f (886-2) 2298-0488

www.tw.sgs.com

Member of SGS Group

Operation Band	:HSDPA B4	Temp./Humi.	:22 deg_C / 62 RH
Fundamental Frequency	:1752.6 MHz	Engineer	:Tin
Operation Mode	:Tx CH HIGH		
EUT Pol.	:E2 Plane	Measurement Antenna Pol.	:HORIZONTAL

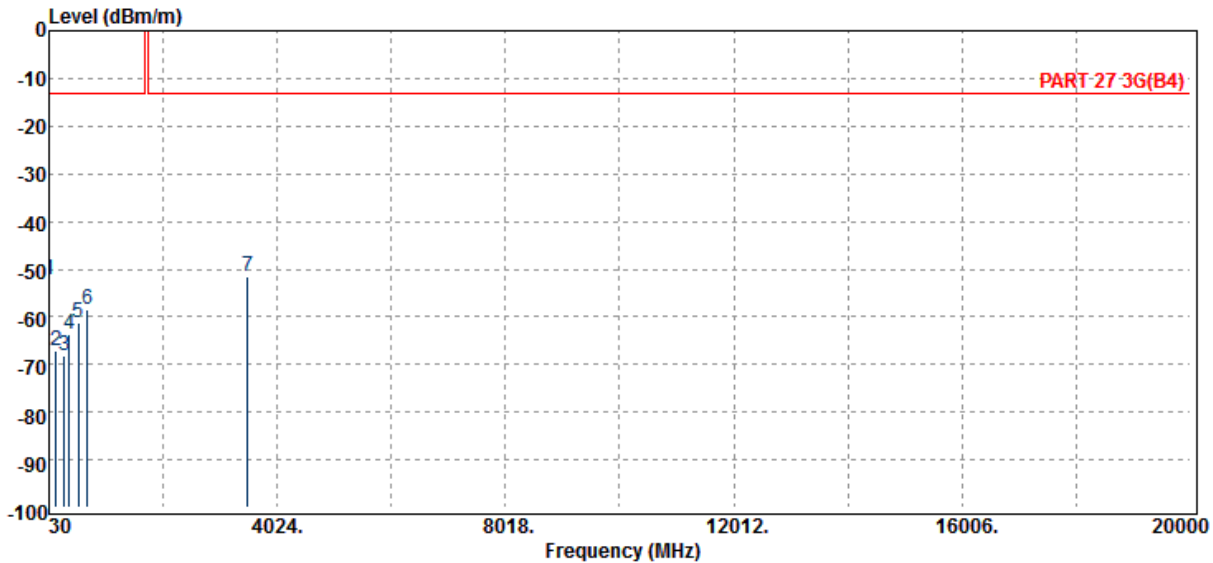

Freq. MHz	ERP/EIRP dBm	SG Output Level dBm	Antenna Gain dBd/dBi	Cable Loss dB	Limit dBm	Margin dB
30.00	-52.33	-39.32	-12.43	-0.58	-13.00	-39.33
158.04	-67.15	-66.65	0.80	-1.30	-13.00	-54.15
293.84	-68.34	-72.19	5.65	-1.80	-13.00	-55.34
381.14	-63.81	-67.70	5.92	-2.02	-13.00	-50.81
544.10	-61.11	-65.46	6.14	-1.79	-13.00	-48.11
696.39	-58.56	-61.94	5.84	-2.46	-13.00	-45.56
3505.20	-51.48	-57.22	12.40	-6.66	-13.00	-38.48

Unless otherwise stated the results shown in this test report refer only to the sample(s) tested and such sample(s) are retained for 90 days only.

除非另有說明，此報告結果僅對測試之樣品負責，同時此樣品僅保留90天。本報告未經本公司書面許可，不可部份複製。

This document is issued by the Company subject to its General Conditions of Service printed overleaf, available on request or accessible at [www.sgs.com/terms\\_and\\_conditions.htm](http://www.sgs.com/terms_and_conditions.htm) and, for electronic format documents, subject to Terms and Conditions for Electronic Documents at [www.sgs.com/terms\\_e-document.htm](http://www.sgs.com/terms_e-document.htm). Attention is drawn to the limitation of liability, indemnification and jurisdiction issues defined therein. Any holder of this document is advised that information contained hereon reflects the Company's findings at the time of its intervention only and within the limits of Client's instructions, if any. The Company's sole responsibility is to its Client and this document does not exonerate parties to a transaction from exercising all their rights and obligations under the transaction documents. This document cannot be reproduced except in full, without prior written approval of the Company. Any unauthorized alteration, forgery or falsification of the content or appearance of this document is unlawful and offenders may be prosecuted to the fullest extent of the law.

### Radiated Spurious Emission Measurement Result: LTE-Band 2 (The Worst Case)

Operation Band :LTE B2 Temp./Humi. :24.1 deg\_C / 65 RH  
 Fundamental Frequency :1860 MHz Engineer :Tin  
 Operation Mode :Tx CH LOW  
 EUT Pol. :E2 Plane Measurement Antenna Pol.:VERTICAL

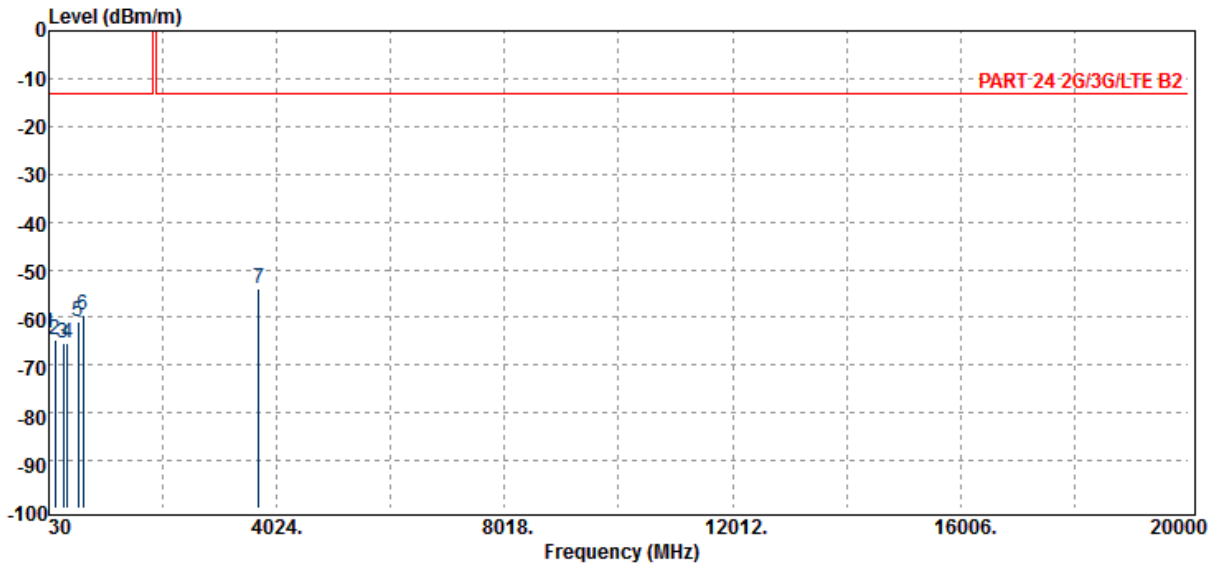

Freq. MHz	ERP/EIRP dBm	SG Output Level dBm	Antenna Gain dBd/dBi	Cable Loss dB	Limit dBm	Margin dB
30.00	-63.32	-48.16	-14.58	-0.58	-13.00	-50.32
133.79	-64.66	-61.35	-2.09	-1.23	-13.00	-51.66
284.14	-65.56	-67.22	3.42	-1.76	-13.00	-52.56
361.74	-65.23	-66.99	3.82	-2.06	-13.00	-52.23
547.01	-60.80	-62.92	3.98	-1.86	-13.00	-47.80
628.49	-59.36	-60.34	3.71	-2.73	-13.00	-46.36
3705.00	-54.01	-59.67	12.57	-6.90	-13.00	-41.01

Unless otherwise stated the results shown in this test report refer only to the sample(s) tested and such sample(s) are retained for 90 days only.

除非另有說明，此報告結果僅對測試之樣品負責，同時此樣品僅保留90天。本報告未經本公司書面許可，不可部份複製。

This document is issued by the Company subject to its General Conditions of Service printed overleaf, available on request or accessible at [www.sgs.com/terms\\_and\\_conditions.htm](http://www.sgs.com/terms_and_conditions.htm) and, for electronic format documents, subject to Terms and Conditions for Electronic Documents at [www.sgs.com/terms\\_e-document.htm](http://www.sgs.com/terms_e-document.htm). Attention is drawn to the limitation of liability, indemnification and jurisdiction issues defined therein. Any holder of this document is advised that information contained hereon reflects the Company's findings at the time of its intervention only and within the limits of Client's instructions, if any. The Company's sole responsibility is to its Client and this document does not exonerate parties to a transaction from exercising all their rights and obligations under the transaction documents. This document cannot be reproduced except in full, without prior written approval of the Company. Any unauthorized alteration, forgery or falsification of the content or appearance of this document is unlawful and offenders may be prosecuted to the fullest extent of the law.

SGS Taiwan Ltd.

No.134,WuKungRoad,NewTaipeiIndustrialPark,WukuDistrict,NewTaipeiCity,Taiwan24803/新北市五股區新北產業園區五工路 134 號

台灣檢驗科技股份有限公司

t (886-2) 2299-3279

f (886-2) 2298-0488

www.tw.sgs.com

Member of SGS Group

Operation Band	:LTE B2	Temp./Humi.	:24.1 deg_C / 65 RH
Fundamental Frequency	:1860 MHz	Engineer	:Tin
Operation Mode	:Tx CH LOW		
EUT Pol.	:E2 Plane	Measurement Antenna Pol.	:HORIZONTAL

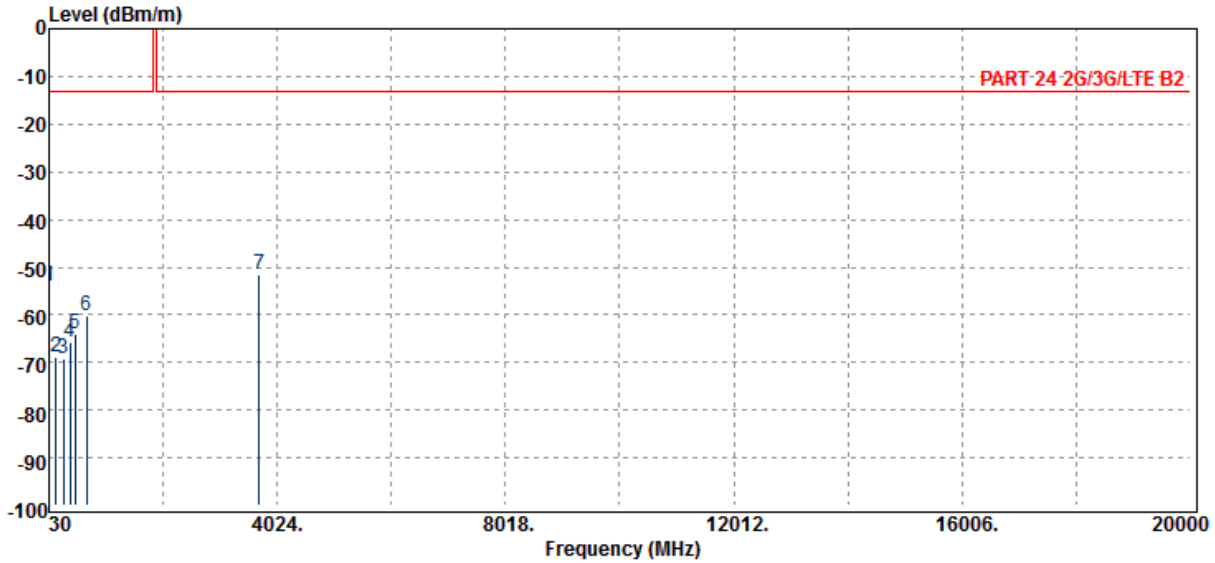

Freq. MHz	ERP/EIRP dBm	SG Output Level dBm	Antenna Gain dBd/dBi	Cable Loss dB	Limit dBm	Margin dB
30.00	-53.93	-38.77	-14.58	-0.58	-13.00	-40.93
153.19	-68.72	-65.80	-1.62	-1.30	-13.00	-55.72
282.20	-69.31	-70.98	3.42	-1.75	-13.00	-56.31
395.69	-65.87	-67.51	3.73	-2.08	-13.00	-52.87
490.75	-63.90	-65.90	3.96	-1.96	-13.00	-50.90
694.45	-60.34	-61.43	3.69	-2.61	-13.00	-47.34
3705.00	-51.68	-57.35	12.57	-6.90	-13.00	-38.68

Unless otherwise stated the results shown in this test report refer only to the sample(s) tested and such sample(s) are retained for 90 days only.

除非另有說明，此報告結果僅對測試之樣品負責，同時此樣品僅保留90天。本報告未經本公司書面許可，不可部份複製。

This document is issued by the Company subject to its General Conditions of Service printed overleaf, available on request or accessible at [www.sgs.com/terms\\_and\\_conditions.htm](http://www.sgs.com/terms_and_conditions.htm) and, for electronic format documents, subject to Terms and Conditions for Electronic Documents at [www.sgs.com/terms\\_e-document.htm](http://www.sgs.com/terms_e-document.htm). Attention is drawn to the limitation of liability, indemnification and jurisdiction issues defined therein. Any holder of this document is advised that information contained hereon reflects the Company's findings at the time of its intervention only and within the limits of Client's instructions, if any. The Company's sole responsibility is to its Client and this document does not exonerate parties to a transaction from exercising all their rights and obligations under the transaction documents. This document cannot be reproduced except in full, without prior written approval of the Company. Any unauthorized alteration, forgery or falsification of the content or appearance of this document is unlawful and offenders may be prosecuted to the fullest extent of the law.

SGS Taiwan Ltd.

No.134,WuKungRoad,NewTaipeiIndustrialPark,WukuDistrict,NewTaipeiCity,Taiwan24803/新北市五股區新北產業園區五工路 134 號

台灣檢驗科技股份有限公司

t (886-2) 2299-3279

f (886-2) 2298-0488

www.tw.sgs.com

Member of SGS Group

Operation Band	:LTE B2	Temp./Humi.	:24.1 deg_C / 65 RH
Fundamental Frequency	:1880 MHz	Engineer	:Tin
Operation Mode	:Tx CH MID	Measurement Antenna	:VERTICAL
EUT Pol.	:E2 Plane	Pol.	

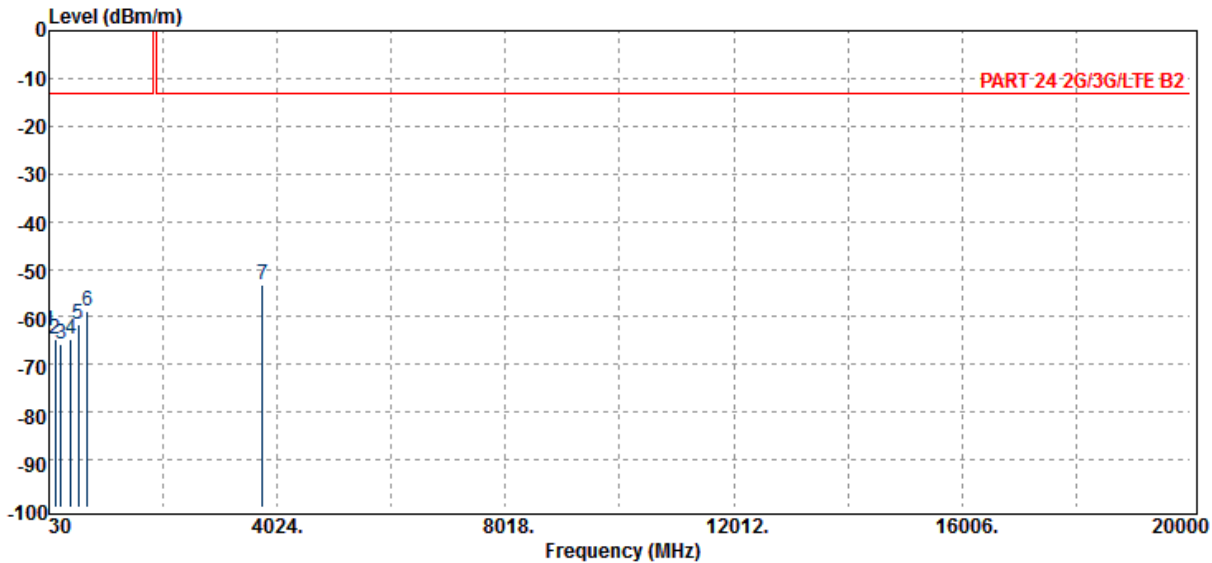

Freq. MHz	ERP/EIRP dBm	SG Output Level dBm	Antenna Gain dBd/dBi	Cable Loss dB	Limit dBm	Margin dB
30.00	-62.87	-47.71	-14.58	-0.58	-13.00	-49.87
139.61	-64.64	-61.09	-2.29	-1.26	-13.00	-51.64
240.49	-65.74	-67.55	3.48	-1.67	-13.00	-52.74
416.06	-64.75	-66.29	3.66	-2.12	-13.00	-51.75
541.19	-61.65	-63.74	3.99	-1.91	-13.00	-48.65
696.39	-58.70	-59.93	3.69	-2.46	-13.00	-45.70
3760.00	-53.33	-59.06	12.61	-6.89	-13.00	-40.33

Unless otherwise stated the results shown in this test report refer only to the sample(s) tested and such sample(s) are retained for 90 days only.

除非另有說明，此報告結果僅對測試之樣品負責，同時此樣品僅保留90天。本報告未經本公司書面許可，不可部份複製。

This document is issued by the Company subject to its General Conditions of Service printed overleaf, available on request or accessible at [www.sgs.com/terms\\_and\\_conditions.htm](http://www.sgs.com/terms_and_conditions.htm) and, for electronic format documents, subject to Terms and Conditions for Electronic Documents at [www.sgs.com/terms\\_e-document.htm](http://www.sgs.com/terms_e-document.htm). Attention is drawn to the limitation of liability, indemnification and jurisdiction issues defined therein. Any holder of this document is advised that information contained hereon reflects the Company's findings at the time of its intervention only and within the limits of Client's instructions, if any. The Company's sole responsibility is to its Client and this document does not exonerate parties to a transaction from exercising all their rights and obligations under the transaction documents. This document cannot be reproduced except in full, without prior written approval of the Company. Any unauthorized alteration, forgery or falsification of the content or appearance of this document is unlawful and offenders may be prosecuted to the fullest extent of the law.

SGS Taiwan Ltd.

No.134,WuKungRoad,NewTaipeiIndustrialPark,WukuDistrict,NewTaipeiCity,Taiwan24803/新北市五股區新北產業園區五工路 134 號

台灣檢驗科技股份有限公司

t (886-2) 2299-3279

f (886-2) 2298-0488

www.tw.sgs.com

Member of SGS Group

Operation Band	:LTE B2	Temp./Humi.	:24.1 deg_C / 65 RH
Fundamental Frequency	:1880 MHz	Engineer	:Tin
Operation Mode	:Tx CH MID		
EUT Pol.	:E2 Plane	Measurement Antenna Pol.	:HORIZONTAL

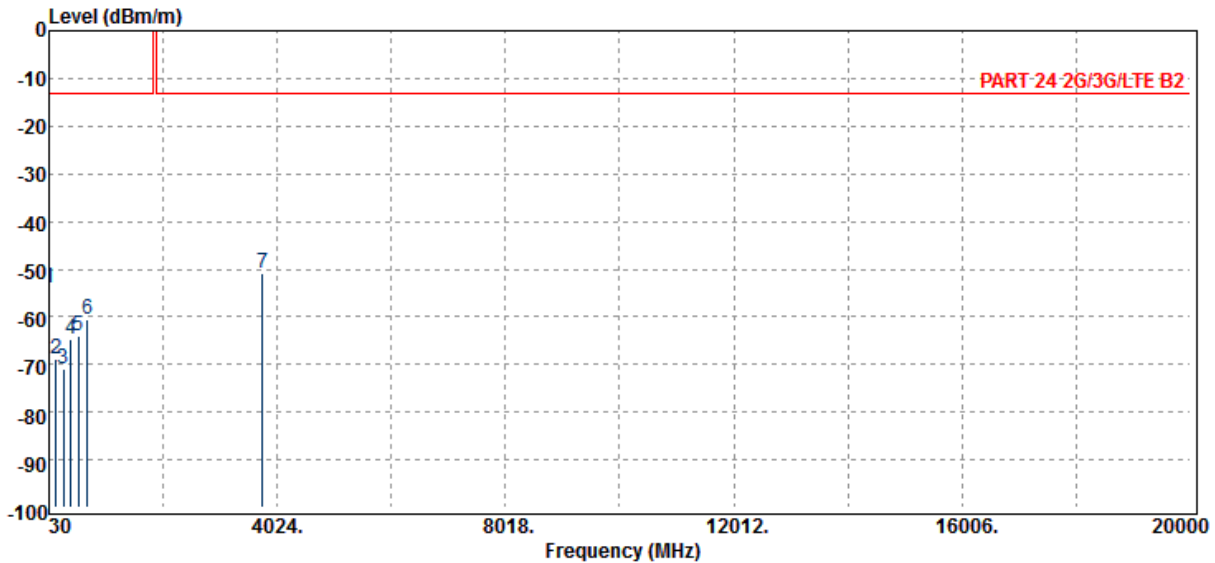

Freq. MHz	ERP/EIRP dBm	SG Output Level dBm	Antenna Gain dBd/dBi	Cable Loss dB	Limit dBm	Margin dB
30.00	-53.88	-38.72	-14.58	-0.58	-13.00	-40.88
146.40	-68.84	-65.57	-1.98	-1.29	-13.00	-55.84
289.96	-70.78	-72.42	3.42	-1.78	-13.00	-57.78
411.21	-64.55	-66.09	3.67	-2.13	-13.00	-51.55
547.01	-64.12	-66.24	3.98	-1.86	-13.00	-51.12
700.27	-60.66	-62.18	3.67	-2.16	-13.00	-47.66
3760.00	-51.00	-56.73	12.61	-6.89	-13.00	-38.00

Unless otherwise stated the results shown in this test report refer only to the sample(s) tested and such sample(s) are retained for 90 days only.

除非另有說明，此報告結果僅對測試之樣品負責，同時此樣品僅保留90天。本報告未經本公司書面許可，不可部份複製。

This document is issued by the Company subject to its General Conditions of Service printed overleaf, available on request or accessible at [www.sgs.com/terms\\_and\\_conditions.htm](http://www.sgs.com/terms_and_conditions.htm) and, for electronic format documents, subject to Terms and Conditions for Electronic Documents at [www.sgs.com/terms\\_e-document.htm](http://www.sgs.com/terms_e-document.htm). Attention is drawn to the limitation of liability, indemnification and jurisdiction issues defined therein. Any holder of this document is advised that information contained hereon reflects the Company's findings at the time of its intervention only and within the limits of Client's instructions, if any. The Company's sole responsibility is to its Client and this document does not exonerate parties to a transaction from exercising all their rights and obligations under the transaction documents. This document cannot be reproduced except in full, without prior written approval of the Company. Any unauthorized alteration, forgery or falsification of the content or appearance of this document is unlawful and offenders may be prosecuted to the fullest extent of the law.

SGS Taiwan Ltd.

No.134,WuKungRoad,NewTaipeiIndustrialPark,WukuDistrict,NewTaipeiCity,Taiwan24803/新北市五股區新北產業園區五工路 134 號

台灣檢驗科技股份有限公司

t (886-2) 2299-3279

f (886-2) 2298-0488

www.tw.sgs.com

Member of SGS Group

Operation Band	:LTE B2	Temp./Humi.	:24.1 deg_C / 65 RH
Fundamental Frequency	:1900 MHz	Engineer	:Tin
Operation Mode	:Tx CH HIGH		
EUT Pol.	:E2 Plane	Measurement Antenna Pol.	:VERTICAL

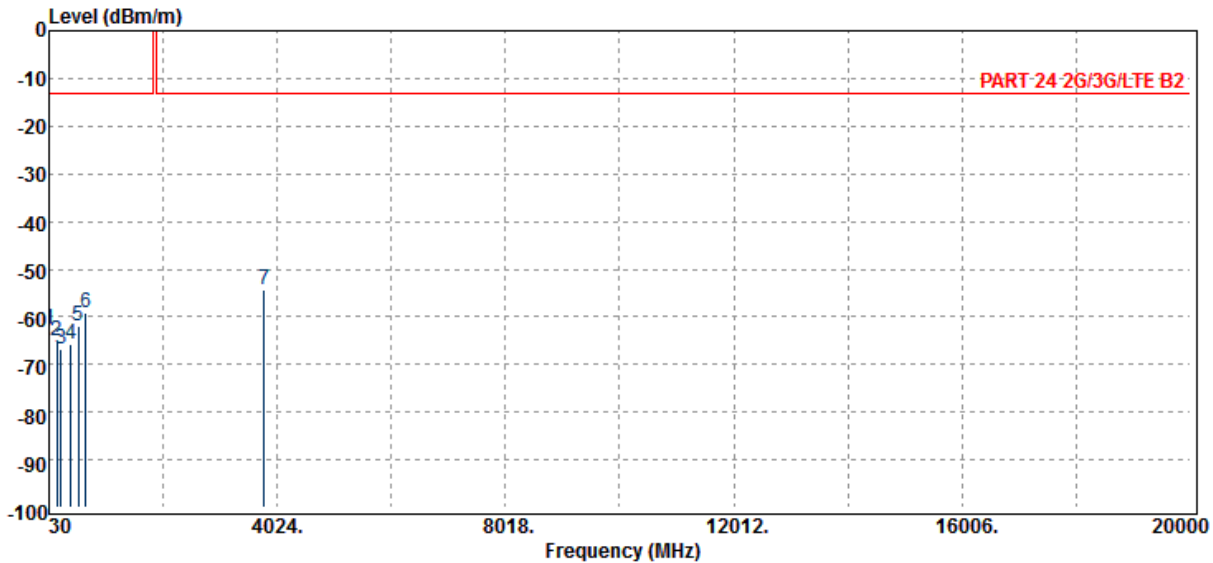

Freq. MHz	ERP/EIRP dBm	SG Output Level dBm	Antenna Gain dBd/dBi	Cable Loss dB	Limit dBm	Margin dB
30.00	-62.53	-47.38	-14.58	-0.58	-13.00	-49.53
173.56	-64.89	-63.50	-0.04	-1.35	-13.00	-51.89
245.34	-66.86	-68.68	3.51	-1.69	-13.00	-53.86
413.15	-65.81	-67.35	3.67	-2.13	-13.00	-52.81
546.04	-61.79	-63.97	3.99	-1.81	-13.00	-48.79
673.11	-59.27	-60.51	3.76	-2.52	-13.00	-46.27
3800.00	-54.18	-59.86	12.65	-6.96	-13.00	-41.18

Unless otherwise stated the results shown in this test report refer only to the sample(s) tested and such sample(s) are retained for 90 days only.

除非另有說明，此報告結果僅對測試之樣品負責，同時此樣品僅保留90天。本報告未經本公司書面許可，不可部份複製。

This document is issued by the Company subject to its General Conditions of Service printed overleaf, available on request or accessible at [www.sgs.com/terms\\_and\\_conditions.htm](http://www.sgs.com/terms_and_conditions.htm) and, for electronic format documents, subject to Terms and Conditions for Electronic Documents at [www.sgs.com/terms\\_e-document.htm](http://www.sgs.com/terms_e-document.htm). Attention is drawn to the limitation of liability, indemnification and jurisdiction issues defined therein. Any holder of this document is advised that information contained hereon reflects the Company's findings at the time of its intervention only and within the limits of Client's instructions, if any. The Company's sole responsibility is to its Client and this document does not exonerate parties to a transaction from exercising all their rights and obligations under the transaction documents. This document cannot be reproduced except in full, without prior written approval of the Company. Any unauthorized alteration, forgery or falsification of the content or appearance of this document is unlawful and offenders may be prosecuted to the fullest extent of the law.

SGS Taiwan Ltd.

No.134,WuKungRoad,NewTaipeiIndustrialPark,WukuDistrict,NewTaipeiCity,Taiwan24803/新北市五股區新北產業園區五工路 134 號

台灣檢驗科技股份有限公司

t (886-2) 2299-3279

f (886-2) 2298-0488

www.tw.sgs.com

Member of SGS Group

Operation Band	:LTE B2	Temp./Humi.	:24.1 deg_C / 65 RH
Fundamental Frequency	:1900 MHz	Engineer	:Tin
Operation Mode	:Tx CH HIGH		
EUT Pol.	:E2 Plane	Measurement Antenna Pol.	:HORIZONTAL

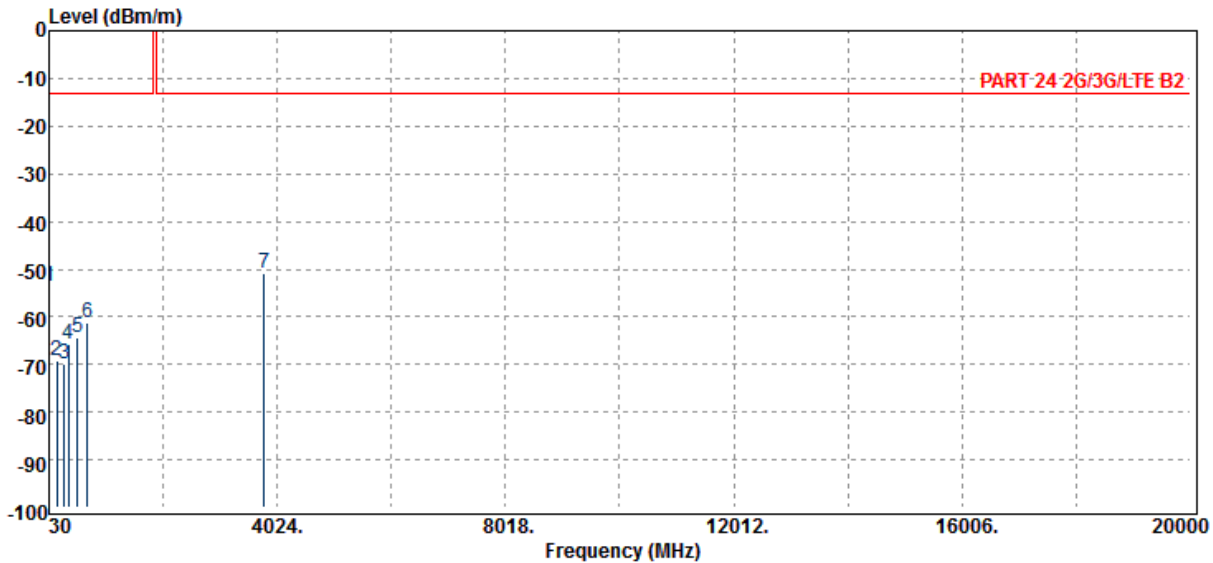

Freq. MHz	ERP/EIRP dBm	SG Output Level dBm	Antenna Gain dBd/dBi	Cable Loss dB	Limit dBm	Margin dB
30.00	-53.66	-38.50	-14.58	-0.58	-13.00	-40.66
165.80	-69.22	-67.03	-0.88	-1.31	-13.00	-56.22
293.84	-69.75	-71.45	3.50	-1.80	-13.00	-56.75
364.65	-65.92	-67.66	3.81	-2.07	-13.00	-52.92
529.55	-64.23	-65.85	4.01	-2.39	-13.00	-51.23
696.39	-61.22	-62.45	3.69	-2.46	-13.00	-48.22
3800.00	-50.85	-56.54	12.65	-6.96	-13.00	-37.85

Unless otherwise stated the results shown in this test report refer only to the sample(s) tested and such sample(s) are retained for 90 days only.

除非另有說明，此報告結果僅對測試之樣品負責，同時此樣品僅保留90天。本報告未經本公司書面許可，不可部份複製。

This document is issued by the Company subject to its General Conditions of Service printed overleaf, available on request or accessible at [www.sgs.com/terms\\_and\\_conditions.htm](http://www.sgs.com/terms_and_conditions.htm) and, for electronic format documents, subject to Terms and Conditions for Electronic Documents at [www.sgs.com/terms\\_e-document.htm](http://www.sgs.com/terms_e-document.htm). Attention is drawn to the limitation of liability, indemnification and jurisdiction issues defined therein. Any holder of this document is advised that information contained hereon reflects the Company's findings at the time of its intervention only and within the limits of Client's instructions, if any. The Company's sole responsibility is to its Client and this document does not exonerate parties to a transaction from exercising all their rights and obligations under the transaction documents. This document cannot be reproduced except in full, without prior written approval of the Company. Any unauthorized alteration, forgery or falsification of the content or appearance of this document is unlawful and offenders may be prosecuted to the fullest extent of the law.



### Radiated Spurious Emission Measurement Result: LTE-Band 4 (The Worst Case)

Operation Band	:LTE B4	Temp./Humi.	:24.1 deg_C / 65 RH
Fundamental Frequency	:1717.5 MHz	Engineer	:Tin
Operation Mode	:Tx CH LOW		
EUT Pol.	:E2 Plane	Measurement Antenna Pol.	:VERTICAL

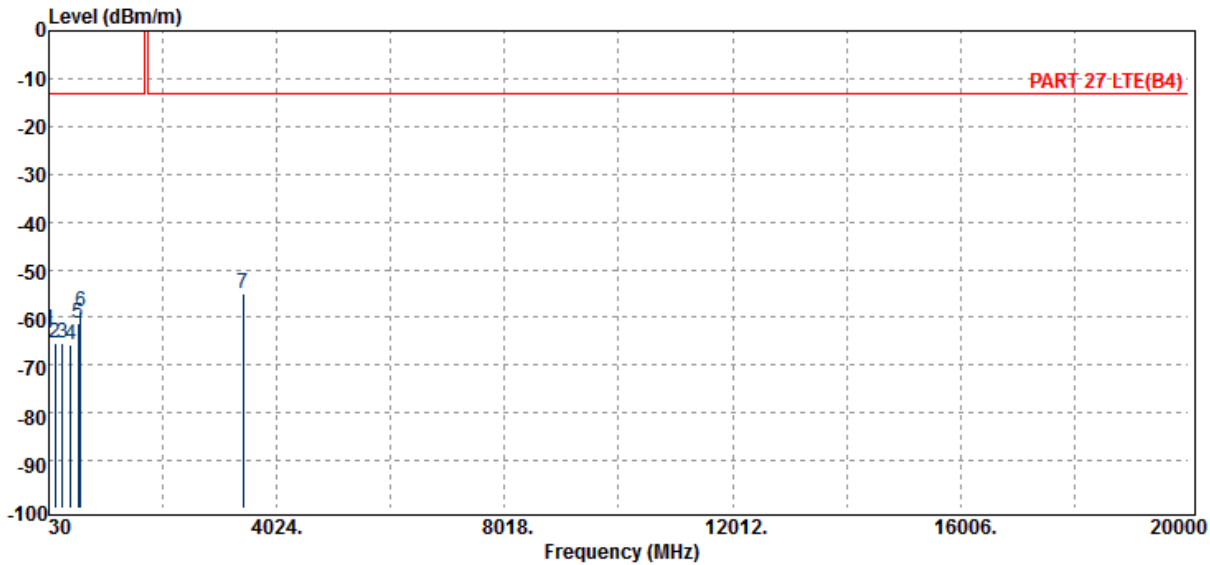

Freq. MHz	ERP/EIRP dBm	SG Output Level dBm	Antenna Gain dBd/dBi	Cable Loss dB	Limit dBm	Margin dB
30.00	-62.48	-47.32	-14.58	-0.58	-13.00	-49.48
144.46	-65.29	-61.93	-2.08	-1.28	-13.00	-52.29
265.71	-65.41	-67.27	3.57	-1.71	-13.00	-52.41
408.30	-65.76	-67.30	3.68	-2.14	-13.00	-52.76
548.95	-61.14	-63.15	3.98	-1.97	-13.00	-48.14
579.99	-58.69	-60.01	3.71	-2.39	-13.00	-45.69
3435.00	-55.06	-60.77	12.25	-6.55	-13.00	-42.06

Unless otherwise stated the results shown in this test report refer only to the sample(s) tested and such sample(s) are retained for 90 days only.

除非另有說明，此報告結果僅對測試之樣品負責，同時此樣品僅保留90天。本報告未經本公司書面許可，不可部份複製。

This document is issued by the Company subject to its General Conditions of Service printed overleaf, available on request or accessible at [www.sgs.com/terms\\_and\\_conditions.htm](http://www.sgs.com/terms_and_conditions.htm) and, for electronic format documents, subject to Terms and Conditions for Electronic Documents at [www.sgs.com/terms\\_e-document.htm](http://www.sgs.com/terms_e-document.htm). Attention is drawn to the limitation of liability, indemnification and jurisdiction issues defined therein. Any holder of this document is advised that information contained hereon reflects the Company's findings at the time of its intervention only and within the limits of Client's instructions, if any. The Company's sole responsibility is to its Client and this document does not exonerate parties to a transaction from exercising all their rights and obligations under the transaction documents. This document cannot be reproduced except in full, without prior written approval of the Company. Any unauthorized alteration, forgery or falsification of the content or appearance of this document is unlawful and offenders may be prosecuted to the fullest extent of the law.

SGS Taiwan Ltd.

No.134,WuKungRoad,NewTaipeiIndustrialPark,WukuDistrict,NewTaipeiCity,Taiwan24803/新北市五股區新北產業園區五工路 134 號

台灣檢驗科技股份有限公司

t (886-2) 2299-3279

f (886-2) 2298-0488

www.tw.sgs.com

Member of SGS Group

Operation Band	:LTE B4	Temp./Humi.	:24.1 deg_C / 65 RH
Fundamental Frequency	:1717.5 MHz	Engineer	:Tin
Operation Mode	:Tx CH LOW		
EUT Pol.	:E2 Plane	Measurement Antenna Pol.	:HORIZONTAL

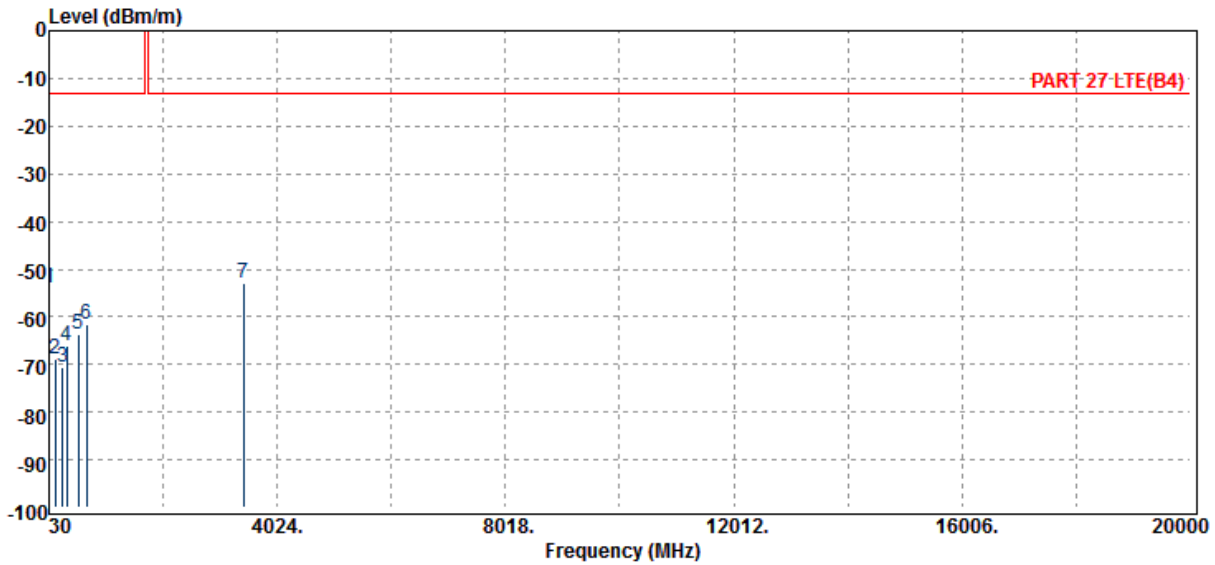

Freq. MHz	ERP/EIRP dBm	SG Output Level dBm	Antenna Gain dBd/dBi	Cable Loss dB	Limit dBm	Margin dB
30.00	-53.94	-38.78	-14.58	-0.58	-13.00	-40.94
139.61	-69.03	-65.48	-2.29	-1.26	-13.00	-56.03
274.44	-70.75	-72.48	3.46	-1.73	-13.00	-57.75
340.40	-66.18	-68.01	3.81	-1.98	-13.00	-53.18
546.04	-63.69	-65.87	3.99	-1.81	-13.00	-50.69
689.60	-61.56	-62.28	3.71	-2.98	-13.00	-48.56
3435.00	-52.78	-58.49	12.25	-6.55	-13.00	-39.78

Unless otherwise stated the results shown in this test report refer only to the sample(s) tested and such sample(s) are retained for 90 days only.

除非另有說明，此報告結果僅對測試之樣品負責，同時此樣品僅保留90天。本報告未經本公司書面許可，不可部份複製。

This document is issued by the Company subject to its General Conditions of Service printed overleaf, available on request or accessible at [www.sgs.com/terms\\_and\\_conditions.htm](http://www.sgs.com/terms_and_conditions.htm) and, for electronic format documents, subject to Terms and Conditions for Electronic Documents at [www.sgs.com/terms\\_e-document.htm](http://www.sgs.com/terms_e-document.htm). Attention is drawn to the limitation of liability, indemnification and jurisdiction issues defined therein. Any holder of this document is advised that information contained hereon reflects the Company's findings at the time of its intervention only and within the limits of Client's instructions, if any. The Company's sole responsibility is to its Client and this document does not exonerate parties to a transaction from exercising all their rights and obligations under the transaction documents. This document cannot be reproduced except in full, without prior written approval of the Company. Any unauthorized alteration, forgery or falsification of the content or appearance of this document is unlawful and offenders may be prosecuted to the fullest extent of the law.

Operation Band	:LTE B4	Temp./Humi.	:24.1 deg_C / 65 RH
Fundamental Frequency	:1732.5 MHz	Engineer	:Tin
Operation Mode	:Tx CH MID	Measurement Antenna	:VERTICAL
EUT Pol.	:E2 Plane	Pol.	

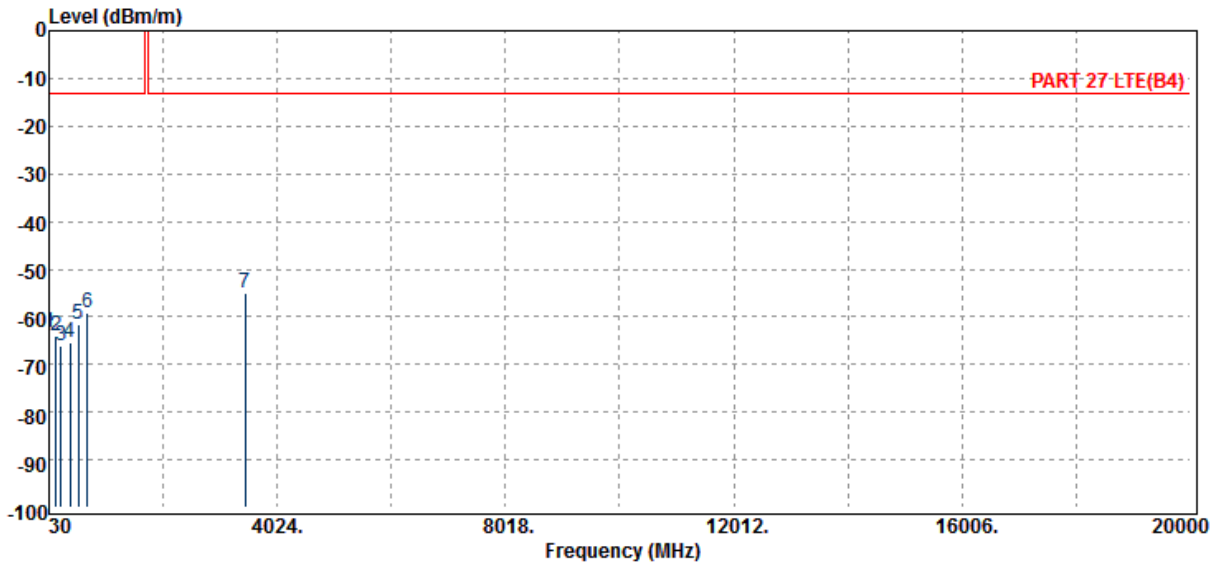

Freq. MHz	ERP/EIRP dBm	SG Output Level dBm	Antenna Gain dBd/dBi	Cable Loss dB	Limit dBm	Margin dB
30.00	-63.26	-48.11	-14.58	-0.58	-13.00	-50.26
156.10	-64.02	-61.26	-1.46	-1.30	-13.00	-51.02
239.52	-66.18	-67.99	3.47	-1.67	-13.00	-53.18
403.45	-65.56	-67.12	3.70	-2.14	-13.00	-52.56
542.16	-61.70	-63.82	3.99	-1.87	-13.00	-48.70
696.39	-59.23	-60.46	3.69	-2.46	-13.00	-46.23
3465.00	-55.16	-60.92	12.32	-6.56	-13.00	-42.16

Unless otherwise stated the results shown in this test report refer only to the sample(s) tested and such sample(s) are retained for 90 days only.

除非另有說明，此報告結果僅對測試之樣品負責，同時此樣品僅保留90天。本報告未經本公司書面許可，不可部份複製。

This document is issued by the Company subject to its General Conditions of Service printed overleaf, available on request or accessible at [www.sgs.com/terms\\_and\\_conditions.htm](http://www.sgs.com/terms_and_conditions.htm) and, for electronic format documents, subject to Terms and Conditions for Electronic Documents at [www.sgs.com/terms\\_e-document.htm](http://www.sgs.com/terms_e-document.htm). Attention is drawn to the limitation of liability, indemnification and jurisdiction issues defined therein. Any holder of this document is advised that information contained hereon reflects the Company's findings at the time of its intervention only and within the limits of Client's instructions, if any. The Company's sole responsibility is to its Client and this document does not exonerate parties to a transaction from exercising all their rights and obligations under the transaction documents. This document cannot be reproduced except in full, without prior written approval of the Company. Any unauthorized alteration, forgery or falsification of the content or appearance of this document is unlawful and offenders may be prosecuted to the fullest extent of the law.

SGS Taiwan Ltd.

No.134,WuKungRoad,NewTaipeiIndustrialPark,WukuDistrict,NewTaipeiCity,Taiwan24803/新北市五股區新北產業園區五工路 134 號

台灣檢驗科技股份有限公司

t (886-2) 2299-3279

f (886-2) 2298-0488

www.tw.sgs.com

Member of SGS Group

Operation Band	:LTE B4	Temp./Humi.	:24.1 deg_C / 65 RH
Fundamental Frequency	:1732.5 MHz	Engineer	:Tin
Operation Mode	:Tx CH MID		
EUT Pol.	:E2 Plane	Measurement Antenna Pol.	:HORIZONTAL

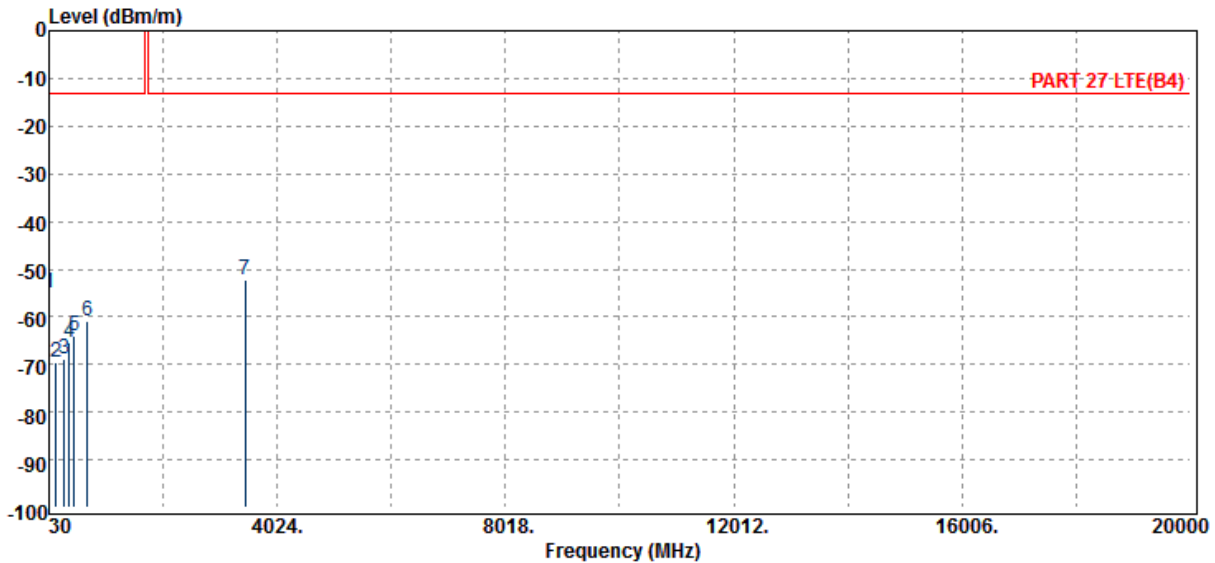

Freq. MHz	ERP/EIRP dBm	SG Output Level dBm	Antenna Gain dBd/dBi	Cable Loss dB	Limit dBm	Margin dB
31.94	-55.08	-40.40	-14.08	-0.59	-13.00	-42.08
159.01	-69.40	-66.80	-1.30	-1.30	-13.00	-56.40
296.75	-68.71	-70.45	3.55	-1.81	-13.00	-55.71
384.05	-65.43	-67.18	3.76	-2.01	-13.00	-52.43
473.29	-64.18	-65.70	3.78	-2.26	-13.00	-51.18
699.30	-60.90	-62.35	3.68	-2.24	-13.00	-47.90
3465.00	-52.21	-57.97	12.32	-6.56	-13.00	-39.21

Unless otherwise stated the results shown in this test report refer only to the sample(s) tested and such sample(s) are retained for 90 days only.

除非另有說明，此報告結果僅對測試之樣品負責，同時此樣品僅保留90天。本報告未經本公司書面許可，不可部份複製。

This document is issued by the Company subject to its General Conditions of Service printed overleaf, available on request or accessible at [www.sgs.com/terms\\_and\\_conditions.htm](http://www.sgs.com/terms_and_conditions.htm) and, for electronic format documents, subject to Terms and Conditions for Electronic Documents at [www.sgs.com/terms\\_e-document.htm](http://www.sgs.com/terms_e-document.htm). Attention is drawn to the limitation of liability, indemnification and jurisdiction issues defined therein. Any holder of this document is advised that information contained hereon reflects the Company's findings at the time of its intervention only and within the limits of Client's instructions, if any. The Company's sole responsibility is to its Client and this document does not exonerate parties to a transaction from exercising all their rights and obligations under the transaction documents. This document cannot be reproduced except in full, without prior written approval of the Company. Any unauthorized alteration, forgery or falsification of the content or appearance of this document is unlawful and offenders may be prosecuted to the fullest extent of the law.

Operation Band	:LTE B4	Temp./Humi.	:24.1 deg_C / 65 RH
Fundamental Frequency	:1747.5 MHz	Engineer	:Tin
Operation Mode	:Tx CH HIGH	Measurement	Antenna:VERTICAL
EUT Pol.	:E2 Plane	Pol.	

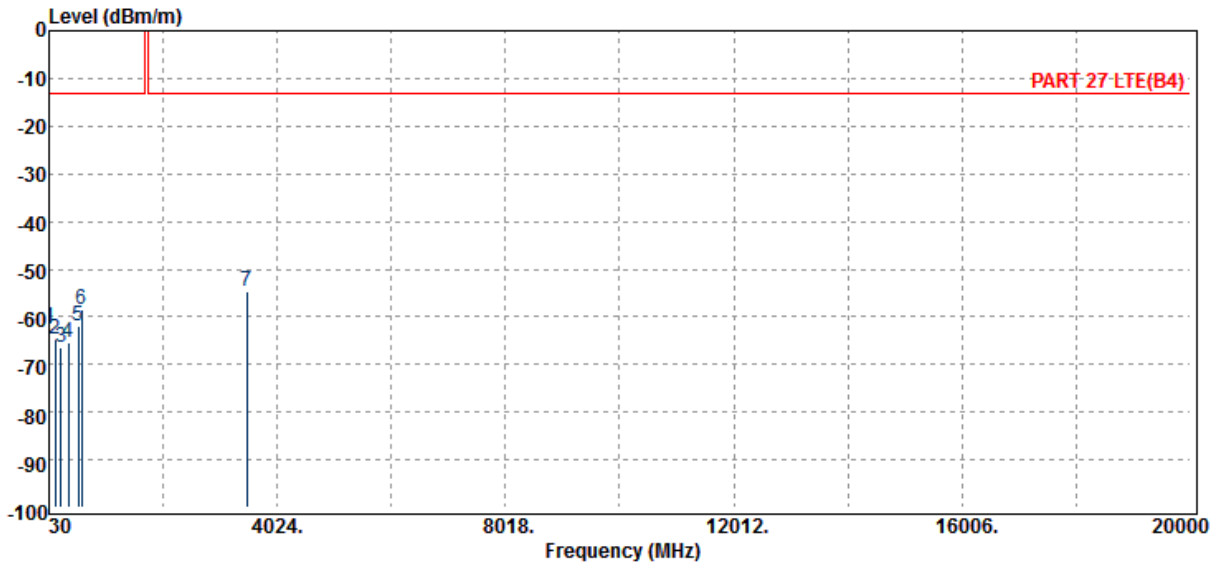

Freq. MHz	ERP/EIRP dBm	SG Output Level dBm	Antenna Gain dBd/dBi	Cable Loss dB	Limit dBm	Margin dB
30.00	-62.31	-47.15	-14.58	-0.58	-13.00	-49.31
144.46	-64.78	-61.42	-2.08	-1.28	-13.00	-51.78
239.52	-66.40	-68.20	3.47	-1.67	-13.00	-53.40
367.56	-65.23	-66.97	3.80	-2.06	-13.00	-52.23
546.04	-61.99	-64.16	3.99	-1.81	-13.00	-48.99
607.15	-58.31	-59.68	3.58	-2.21	-13.00	-45.31
3495.00	-54.75	-60.53	12.39	-6.61	-13.00	-41.75

Unless otherwise stated the results shown in this test report refer only to the sample(s) tested and such sample(s) are retained for 90 days only.

除非另有說明，此報告結果僅對測試之樣品負責，同時此樣品僅保留90天。本報告未經本公司書面許可，不可部份複製。

This document is issued by the Company subject to its General Conditions of Service printed overleaf, available on request or accessible at [www.sgs.com/terms\\_and\\_conditions.htm](http://www.sgs.com/terms_and_conditions.htm) and, for electronic format documents, subject to Terms and Conditions for Electronic Documents at [www.sgs.com/terms\\_e-document.htm](http://www.sgs.com/terms_e-document.htm). Attention is drawn to the limitation of liability, indemnification and jurisdiction issues defined therein. Any holder of this document is advised that information contained hereon reflects the Company's findings at the time of its intervention only and within the limits of Client's instructions, if any. The Company's sole responsibility is to its Client and this document does not exonerate parties to a transaction from exercising all their rights and obligations under the transaction documents. This document cannot be reproduced except in full, without prior written approval of the Company. Any unauthorized alteration, forgery or falsification of the content or appearance of this document is unlawful and offenders may be prosecuted to the fullest extent of the law.

SGS Taiwan Ltd.

No.134,WuKungRoad,NewTaipeiIndustrialPark,WukuDistrict,NewTaipeiCity,Taiwan24803/新北市五股區新北產業園區五工路 134 號

台灣檢驗科技股份有限公司

t (886-2) 2299-3279

f (886-2) 2298-0488

www.tw.sgs.com

Member of SGS Group

Operation Band	:LTE B4	Temp./Humi.	:24.1 deg_C / 65 RH
Fundamental Frequency	:1747.5 MHz	Engineer	:Tin
Operation Mode	:Tx CH HIGH		
EUT Pol.	:E2 Plane	Measurement Antenna Pol.	:HORIZONTAL

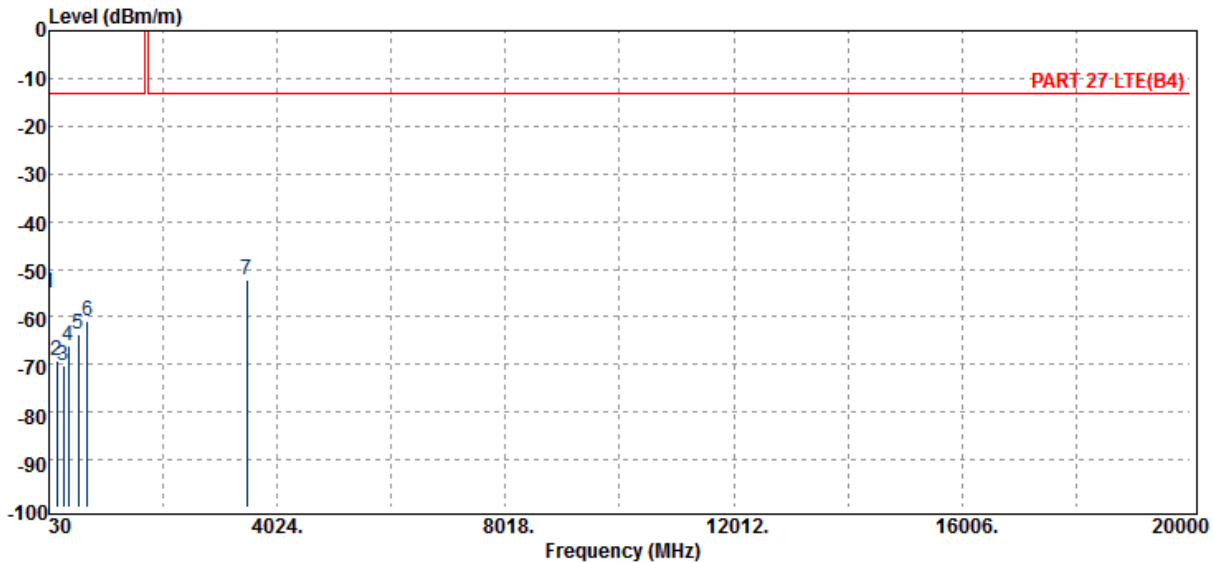

Freq. MHz	ERP/EIRP dBm	SG Output Level dBm	Antenna Gain dBd/dBi	Cable Loss dB	Limit dBm	Margin dB
30.00	-54.92	-39.76	-14.58	-0.58	-13.00	-41.92
167.74	-69.10	-67.02	-0.76	-1.32	-13.00	-56.10
280.26	-70.18	-71.85	3.42	-1.75	-13.00	-57.18
366.59	-66.19	-67.93	3.81	-2.07	-13.00	-53.19
539.25	-63.77	-65.78	4.00	-1.99	-13.00	-50.77
697.36	-60.94	-62.24	3.68	-2.38	-13.00	-47.94
3495.00	-52.14	-57.93	12.39	-6.61	-13.00	-39.14

Unless otherwise stated the results shown in this test report refer only to the sample(s) tested and such sample(s) are retained for 90 days only.

除非另有說明，此報告結果僅對測試之樣品負責，同時此樣品僅保留90天。本報告未經本公司書面許可，不可部份複製。

This document is issued by the Company subject to its General Conditions of Service printed overleaf, available on request or accessible at [www.sgs.com/terms\\_and\\_conditions.htm](http://www.sgs.com/terms_and_conditions.htm) and, for electronic format documents, subject to Terms and Conditions for Electronic Documents at [www.sgs.com/terms\\_e-document.htm](http://www.sgs.com/terms_e-document.htm). Attention is drawn to the limitation of liability, indemnification and jurisdiction issues defined therein. Any holder of this document is advised that information contained hereon reflects the Company's findings at the time of its intervention only and within the limits of Client's instructions, if any. The Company's sole responsibility is to its Client and this document does not exonerate parties to a transaction from exercising all their rights and obligations under the transaction documents. This document cannot be reproduced except in full, without prior written approval of the Company. Any unauthorized alteration, forgery or falsification of the content or appearance of this document is unlawful and offenders may be prosecuted to the fullest extent of the law.

### Radiated Spurious Emission Measurement Result: LTE-Band 12 (The Worst Case)

Operation Band :LTE B12 Temp./Humi. :24.1 deg\_C / 65 RH  
 Fundamental Frequency :701.5 MHz Engineer :Tin  
 Operation Mode :Tx CH LOW  
 EUT Pol. :E2 Plane Measurement Antenna Pol.:VERTICAL

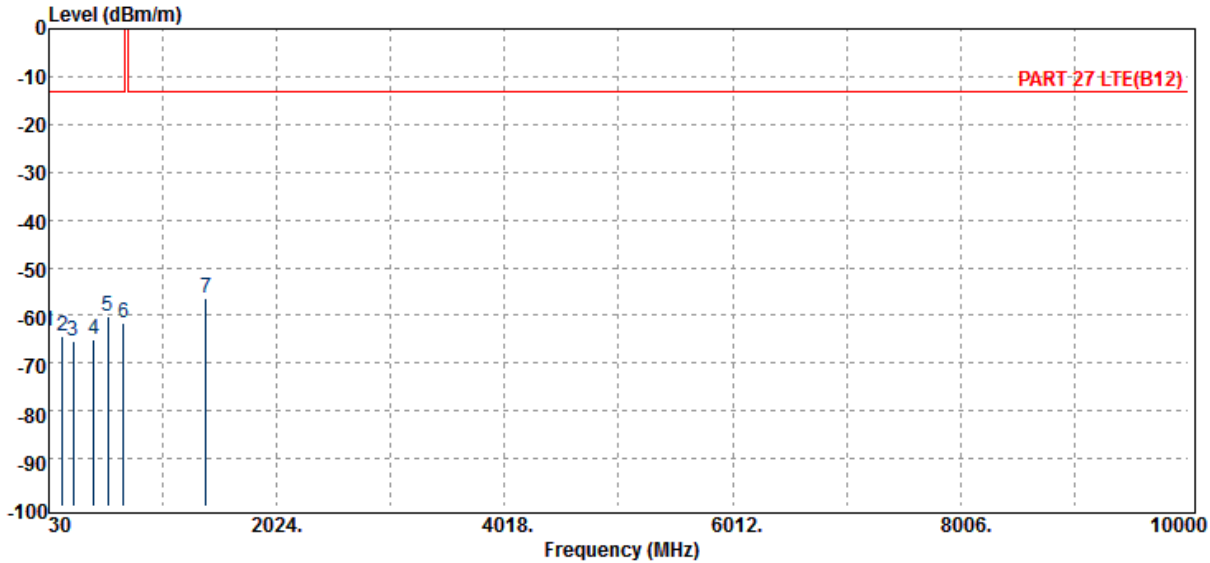

Freq. MHz	ERP/EIRP dBm	SG Output Level dBm	Antenna Gain dBd/dBi	Cable Loss dB	Limit dBm	Margin dB
30.00	-63.23	-48.07	-14.58	-0.58	-13.00	-50.23
146.40	-64.42	-61.15	-1.98	-1.29	-13.00	-51.42
245.34	-65.46	-67.27	3.51	-1.69	-13.00	-52.46
419.94	-65.18	-66.71	3.64	-2.11	-13.00	-52.18
546.04	-60.28	-62.45	3.99	-1.81	-13.00	-47.28
684.75	-61.57	-61.97	3.72	-3.32	-13.00	-48.57
1403.00	-56.28	-60.50	8.20	-3.99	-13.00	-43.28

Unless otherwise stated the results shown in this test report refer only to the sample(s) tested and such sample(s) are retained for 90 days only.

除非另有說明，此報告結果僅對測試之樣品負責，同時此樣品僅保留90天。本報告未經本公司書面許可，不可部份複製。

This document is issued by the Company subject to its General Conditions of Service printed overleaf, available on request or accessible at [www.sgs.com/terms\\_and\\_conditions.htm](http://www.sgs.com/terms_and_conditions.htm) and, for electronic format documents, subject to Terms and Conditions for Electronic Documents at [www.sgs.com/terms\\_e-document.htm](http://www.sgs.com/terms_e-document.htm). Attention is drawn to the limitation of liability, indemnification and jurisdiction issues defined therein. Any holder of this document is advised that information contained hereon reflects the Company's findings at the time of its intervention only and within the limits of Client's instructions, if any. The Company's sole responsibility is to its Client and this document does not exonerate parties to a transaction from exercising all their rights and obligations under the transaction documents. This document cannot be reproduced except in full, without prior written approval of the Company. Any unauthorized alteration, forgery or falsification of the content or appearance of this document is unlawful and offenders may be prosecuted to the fullest extent of the law.

SGS Taiwan Ltd.

No.134,WuKungRoad,NewTaipeiIndustrialPark,WukuDistrict,NewTaipeiCity,Taiwan24803/新北市五股區新北產業園區五工路 134 號

台灣檢驗科技股份有限公司

t (886-2) 2299-3279

f (886-2) 2298-0488

www.tw.sgs.com

Member of SGS Group

Operation Band	:LTE B12	Temp./Humi.	:24.1 deg_C / 65 RH
Fundamental Frequency	:701.5 MHz	Engineer	:Tin
Operation Mode	:Tx CH LOW		
EUT Pol.	:E2 Plane	Measurement Antenna Pol.	:HORIZONTAL

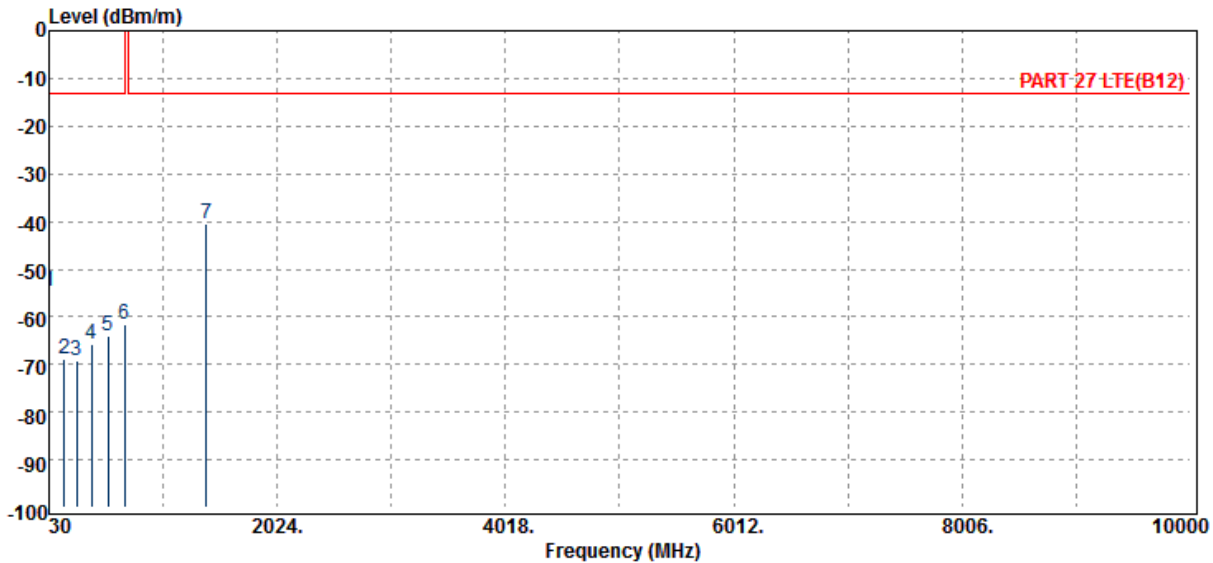

Freq. MHz	ERP/EIRP dBm	SG Output Level dBm	Antenna Gain dBd/dBi	Cable Loss dB	Limit dBm	Margin dB
30.00	-54.57	-39.41	-14.58	-0.58	-13.00	-41.57
160.95	-68.84	-66.36	-1.18	-1.30	-13.00	-55.84
272.50	-69.28	-71.03	3.48	-1.73	-13.00	-56.28
401.51	-65.66	-67.24	3.71	-2.13	-13.00	-52.66
548.95	-63.85	-65.86	3.98	-1.97	-13.00	-50.85
691.54	-61.62	-62.48	3.70	-2.83	-13.00	-48.62
1403.00	-40.57	-44.78	8.20	-3.99	-13.00	-27.57

Unless otherwise stated the results shown in this test report refer only to the sample(s) tested and such sample(s) are retained for 90 days only.

除非另有說明，此報告結果僅對測試之樣品負責，同時此樣品僅保留90天。本報告未經本公司書面許可，不可部份複製。

This document is issued by the Company subject to its General Conditions of Service printed overleaf, available on request or accessible at [www.sgs.com/terms\\_and\\_conditions.htm](http://www.sgs.com/terms_and_conditions.htm) and, for electronic format documents, subject to Terms and Conditions for Electronic Documents at [www.sgs.com/terms\\_e-document.htm](http://www.sgs.com/terms_e-document.htm). Attention is drawn to the limitation of liability, indemnification and jurisdiction issues defined therein. Any holder of this document is advised that information contained hereon reflects the Company's findings at the time of its intervention only and within the limits of Client's instructions, if any. The Company's sole responsibility is to its Client and this document does not exonerate parties to a transaction from exercising all their rights and obligations under the transaction documents. This document cannot be reproduced except in full, without prior written approval of the Company. Any unauthorized alteration, forgery or falsification of the content or appearance of this document is unlawful and offenders may be prosecuted to the fullest extent of the law.



Operation Band	:LTE B12	Temp./Humi.	:24.1 deg_C / 65 RH
Fundamental Frequency	:707.5 MHz	Engineer	:Tin
Operation Mode	:Tx CH MID	Measurement Antenna	:VERTICAL
EUT Pol.	:E2 Plane	Pol.	

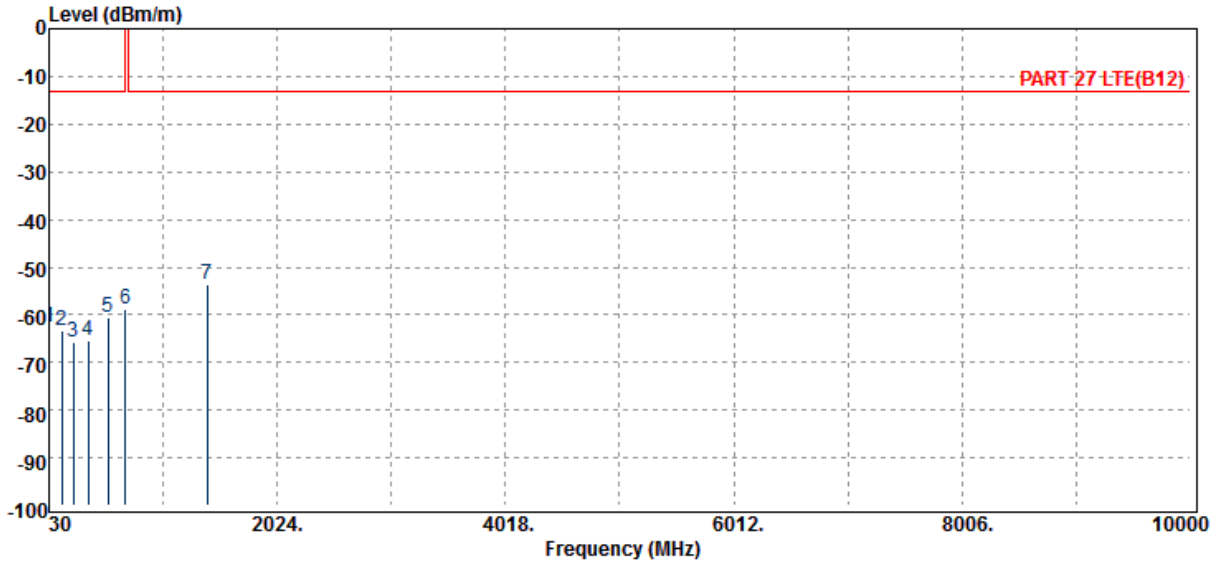

Freq. MHz	ERP/EIRP dBm	SG Output Level dBm	Antenna Gain dBd/dBi	Cable Loss dB	Limit dBm	Margin dB
30.00	-62.67	-47.51	-14.58	-0.58	-13.00	-49.67
138.64	-63.25	-59.74	-2.26	-1.25	-13.00	-50.25
241.46	-65.79	-67.60	3.49	-1.68	-13.00	-52.79
371.44	-65.40	-67.14	3.79	-2.05	-13.00	-52.40
544.10	-60.50	-62.70	3.99	-1.79	-13.00	-47.50
696.39	-58.85	-60.08	3.69	-2.46	-13.00	-45.85
1415.00	-53.54	-57.79	8.25	-4.01	-13.00	-40.54

Unless otherwise stated the results shown in this test report refer only to the sample(s) tested and such sample(s) are retained for 90 days only.

除非另有說明，此報告結果僅對測試之樣品負責，同時此樣品僅保留90天。本報告未經本公司書面許可，不可部份複製。

This document is issued by the Company subject to its General Conditions of Service printed overleaf, available on request or accessible at [www.sgs.com/terms\\_and\\_conditions.htm](http://www.sgs.com/terms_and_conditions.htm) and, for electronic format documents, subject to Terms and Conditions for Electronic Documents at [www.sgs.com/terms\\_e-document.htm](http://www.sgs.com/terms_e-document.htm). Attention is drawn to the limitation of liability, indemnification and jurisdiction issues defined therein. Any holder of this document is advised that information contained hereon reflects the Company's findings at the time of its intervention only and within the limits of Client's instructions, if any. The Company's sole responsibility is to its Client and this document does not exonerate parties to a transaction from exercising all their rights and obligations under the transaction documents. This document cannot be reproduced except in full, without prior written approval of the Company. Any unauthorized alteration, forgery or falsification of the content or appearance of this document is unlawful and offenders may be prosecuted to the fullest extent of the law.

Operation Band	:LTE B12	Temp./Humi.	:24.1 deg_C / 65 RH
Fundamental Frequency	:707.5 MHz	Engineer	:Tin
Operation Mode	:Tx CH MID	Measurement Antenna	:HORIZONTAL
EUT Pol.	:E2 Plane	Pol.	

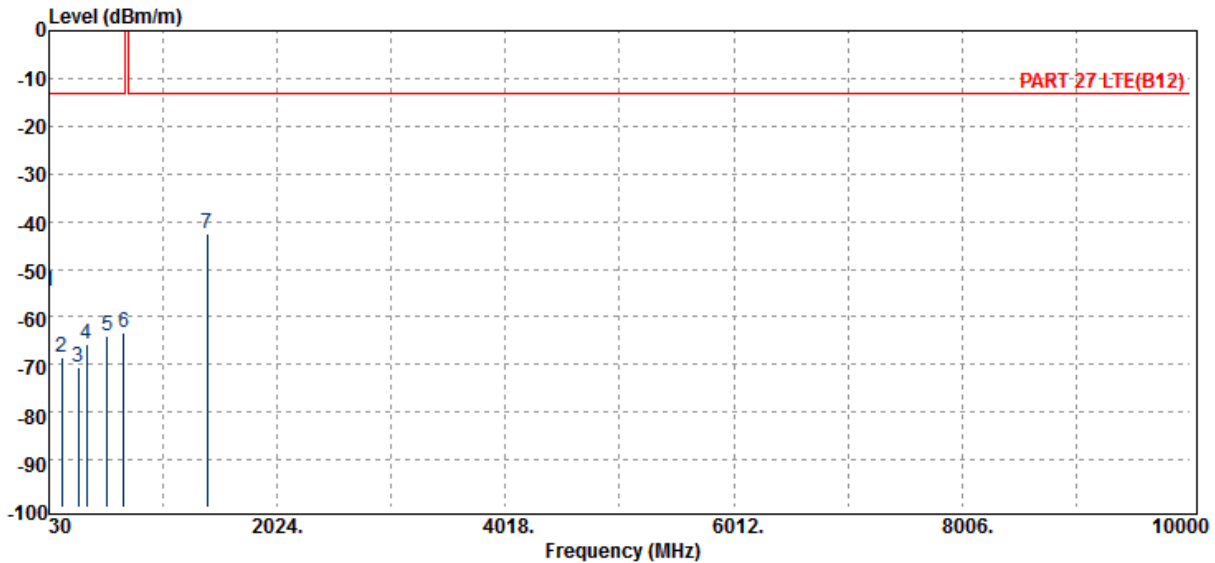

Freq. MHz	ERP/EIRP dBm	SG Output Level dBm	Antenna Gain dBd/dBi	Cable Loss dB	Limit dBm	Margin dB
30.00	-54.56	-39.40	-14.58	-0.58	-13.00	-41.56
141.55	-68.63	-65.13	-2.22	-1.27	-13.00	-55.63
284.14	-70.52	-72.18	3.42	-1.76	-13.00	-57.52
356.89	-65.63	-67.42	3.83	-2.05	-13.00	-52.63
541.19	-64.01	-66.10	3.99	-1.91	-13.00	-51.01
685.72	-63.27	-63.70	3.72	-3.29	-13.00	-50.27
1415.00	-42.40	-46.65	8.25	-4.01	-13.00	-29.40

Unless otherwise stated the results shown in this test report refer only to the sample(s) tested and such sample(s) are retained for 90 days only.

除非另有說明，此報告結果僅對測試之樣品負責，同時此樣品僅保留90天。本報告未經本公司書面許可，不可部份複製。

This document is issued by the Company subject to its General Conditions of Service printed overleaf, available on request or accessible at [www.sgs.com/terms\\_and\\_conditions.htm](http://www.sgs.com/terms_and_conditions.htm) and, for electronic format documents, subject to Terms and Conditions for Electronic Documents at [www.sgs.com/terms\\_e-document.htm](http://www.sgs.com/terms_e-document.htm). Attention is drawn to the limitation of liability, indemnification and jurisdiction issues defined therein. Any holder of this document is advised that information contained hereon reflects the Company's findings at the time of its intervention only and within the limits of Client's instructions, if any. The Company's sole responsibility is to its Client and this document does not exonerate parties to a transaction from exercising all their rights and obligations under the transaction documents. This document cannot be reproduced except in full, without prior written approval of the Company. Any unauthorized alteration, forgery or falsification of the content or appearance of this document is unlawful and offenders may be prosecuted to the fullest extent of the law.

Operation Band	:LTE B12	Temp./Humi.	:24.1 deg_C / 65 RH
Fundamental Frequency	:713.5 MHz	Engineer	:Tin
Operation Mode	:Tx CH HIGH	Measurement Antenna	:VERTICAL
EUT Pol.	:E2 Plane	Pol.	

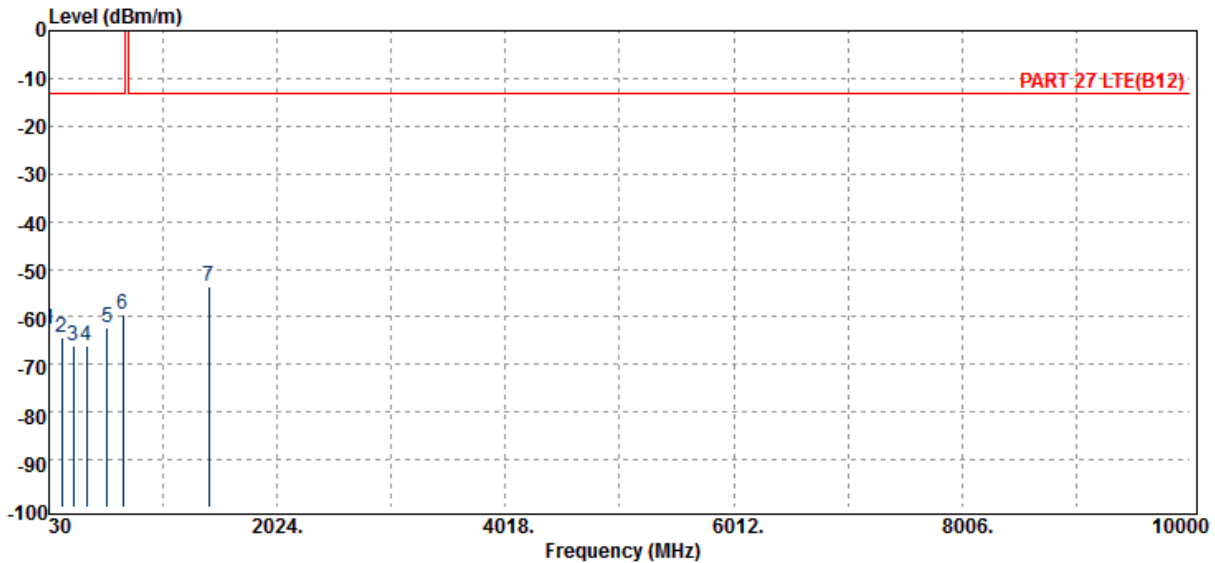

Freq. MHz	ERP/EIRP dBm	SG Output Level dBm	Antenna Gain dBd/dBi	Cable Loss dB	Limit dBm	Margin dB
30.00	-62.62	-47.46	-14.58	-0.58	-13.00	-49.62
141.55	-64.45	-60.95	-2.22	-1.27	-13.00	-51.45
239.52	-66.06	-67.86	3.47	-1.67	-13.00	-53.06
357.86	-66.01	-67.79	3.83	-2.05	-13.00	-53.01
542.16	-62.21	-64.33	3.99	-1.87	-13.00	-49.21
673.11	-59.67	-60.92	3.76	-2.52	-13.00	-46.67
1427.00	-53.73	-58.01	8.30	-4.03	-13.00	-40.73

Unless otherwise stated the results shown in this test report refer only to the sample(s) tested and such sample(s) are retained for 90 days only.

除非另有說明，此報告結果僅對測試之樣品負責，同時此樣品僅保留90天。本報告未經本公司書面許可，不可部份複製。

This document is issued by the Company subject to its General Conditions of Service printed overleaf, available on request or accessible at [www.sgs.com/terms\\_and\\_conditions.htm](http://www.sgs.com/terms_and_conditions.htm) and, for electronic format documents, subject to Terms and Conditions for Electronic Documents at [www.sgs.com/terms\\_e-document.htm](http://www.sgs.com/terms_e-document.htm). Attention is drawn to the limitation of liability, indemnification and jurisdiction issues defined therein. Any holder of this document is advised that information contained hereon reflects the Company's findings at the time of its intervention only and within the limits of Client's instructions, if any. The Company's sole responsibility is to its Client and this document does not exonerate parties to a transaction from exercising all their rights and obligations under the transaction documents. This document cannot be reproduced except in full, without prior written approval of the Company. Any unauthorized alteration, forgery or falsification of the content or appearance of this document is unlawful and offenders may be prosecuted to the fullest extent of the law.

SGS Taiwan Ltd.

No.134,WuKungRoad,NewTaipeiIndustrialPark,WukuDistrict,NewTaipeiCity,Taiwan24803/新北市五股區新北產業園區五工路 134 號

台灣檢驗科技股份有限公司

t (886-2) 2299-3279

f (886-2) 2298-0488

www.tw.sgs.com

Member of SGS Group

Operation Band	:LTE B12	Temp./Humi.	:24.1 deg_C / 65 RH
Fundamental Frequency	:713.5 MHz	Engineer	:Tin
Operation Mode	:Tx CH HIGH	Measurement Antenna	:HORIZONTAL
EUT Pol.	:E2 Plane	Pol.	

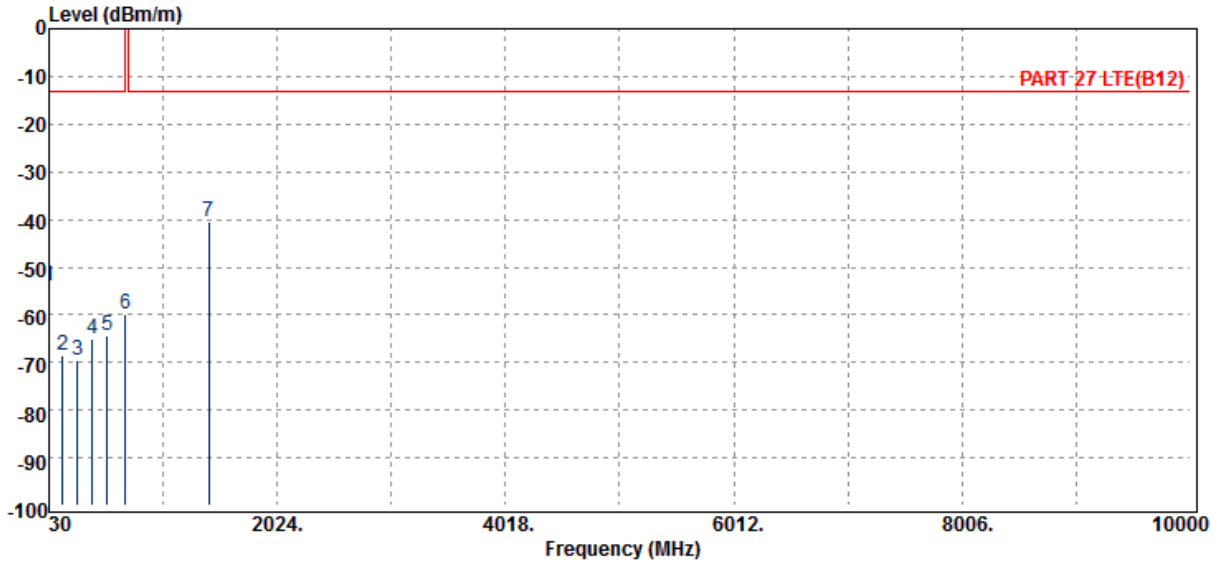

Freq. MHz	ERP/EIRP dBm	SG Output Level dBm	Antenna Gain dBd/dBi	Cable Loss dB	Limit dBm	Margin dB
30.00	-54.02	-38.86	-14.58	-0.58	-13.00	-41.02
146.40	-68.67	-65.40	-1.98	-1.29	-13.00	-55.67
282.20	-69.42	-71.09	3.42	-1.75	-13.00	-56.42
406.36	-65.00	-66.55	3.69	-2.15	-13.00	-52.00
542.16	-64.31	-66.43	3.99	-1.87	-13.00	-51.31
696.39	-59.99	-61.22	3.69	-2.46	-13.00	-46.99
1427.00	-40.60	-44.87	8.30	-4.03	-13.00	-27.60

Unless otherwise stated the results shown in this test report refer only to the sample(s) tested and such sample(s) are retained for 90 days only.

除非另有說明，此報告結果僅對測試之樣品負責，同時此樣品僅保留90天。本報告未經本公司書面許可，不可部份複製。

This document is issued by the Company subject to its General Conditions of Service printed overleaf, available on request or accessible at [www.sgs.com/terms\\_and\\_conditions.htm](http://www.sgs.com/terms_and_conditions.htm) and, for electronic format documents, subject to Terms and Conditions for Electronic Documents at [www.sgs.com/terms\\_e-document.htm](http://www.sgs.com/terms_e-document.htm). Attention is drawn to the limitation of liability, indemnification and jurisdiction issues defined therein. Any holder of this document is advised that information contained hereon reflects the Company's findings at the time of its intervention only and within the limits of Client's instructions, if any. The Company's sole responsibility is to its Client and this document does not exonerate parties to a transaction from exercising all their rights and obligations under the transaction documents. This document cannot be reproduced except in full, without prior written approval of the Company. Any unauthorized alteration, forgery or falsification of the content or appearance of this document is unlawful and offenders may be prosecuted to the fullest extent of the law.

### Radiated Spurious Emission Measurement Result: LTE-Band 17 (The Worst Case)

Operation Band :LTE B17 Temp./Humi. :24.1 deg\_C / 65 RH  
 Fundamental Frequency :706.5 MHz Engineer :Tin  
 Operation Mode :Tx CH LOW  
 EUT Pol. :E2 Plane Measurement Antenna Pol.:VERTICAL

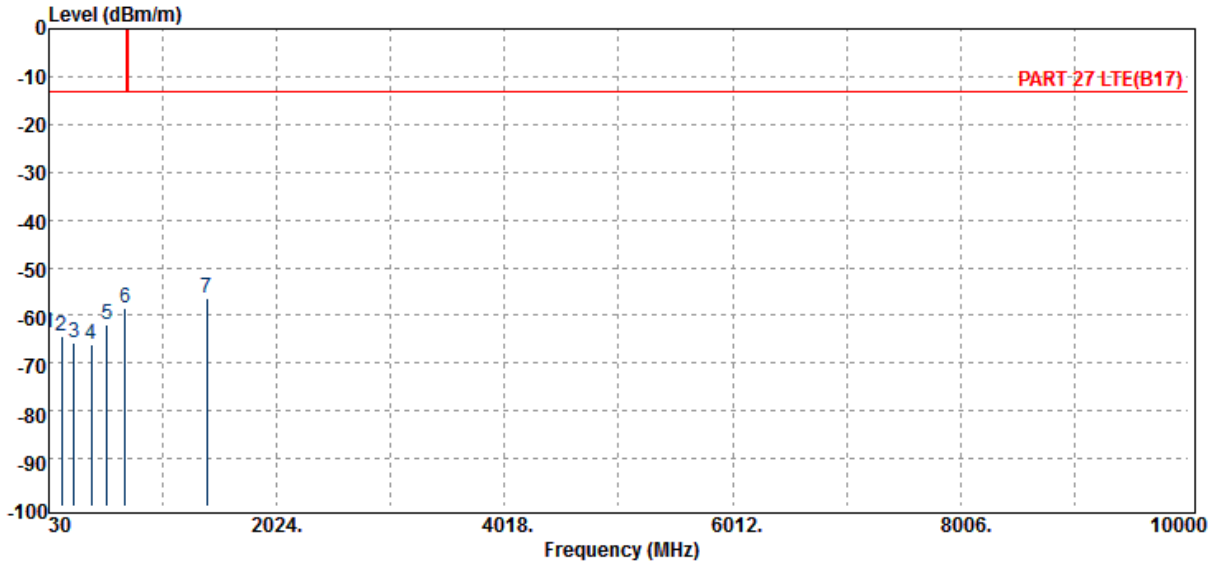

Freq. MHz	ERP/EIRP dBm	SG Output Level dBm	Antenna Gain dBd/dBi	Cable Loss dB	Limit dBm	Margin dB
30.00	-63.74	-48.58	-14.58	-0.58	-13.00	-50.74
141.55	-64.35	-60.86	-2.22	-1.27	-13.00	-51.35
253.10	-65.68	-67.56	3.58	-1.70	-13.00	-52.68
398.60	-66.02	-67.64	3.72	-2.10	-13.00	-53.02
537.31	-62.00	-63.93	4.00	-2.07	-13.00	-49.00
699.30	-58.65	-60.09	3.68	-2.24	-13.00	-45.65
1413.00	-56.51	-60.75	8.25	-4.00	-13.00	-43.51

Unless otherwise stated the results shown in this test report refer only to the sample(s) tested and such sample(s) are retained for 90 days only.

除非另有說明，此報告結果僅對測試之樣品負責，同時此樣品僅保留90天。本報告未經本公司書面許可，不可部份複製。

This document is issued by the Company subject to its General Conditions of Service printed overleaf, available on request or accessible at [www.sgs.com/terms\\_and\\_conditions.htm](http://www.sgs.com/terms_and_conditions.htm) and, for electronic format documents, subject to Terms and Conditions for Electronic Documents at [www.sgs.com/terms\\_e-document.htm](http://www.sgs.com/terms_e-document.htm). Attention is drawn to the limitation of liability, indemnification and jurisdiction issues defined therein. Any holder of this document is advised that information contained hereon reflects the Company's findings at the time of its intervention only and within the limits of Client's instructions, if any. The Company's sole responsibility is to its Client and this document does not exonerate parties to a transaction from exercising all their rights and obligations under the transaction documents. This document cannot be reproduced except in full, without prior written approval of the Company. Any unauthorized alteration, forgery or falsification of the content or appearance of this document is unlawful and offenders may be prosecuted to the fullest extent of the law.

SGS Taiwan Ltd.

No.134,WuKungRoad,NewTaipeiIndustrialPark,WukuDistrict,NewTaipeiCity,Taiwan24803/新北市五股區新北產業園區五工路 134 號

台灣檢驗科技股份有限公司

t (886-2) 2299-3279

f (886-2) 2298-0488

www.tw.sgs.com

Member of SGS Group

Operation Band	:LTE B17	Temp./Humi.	:24.1 deg_C / 65 RH
Fundamental Frequency	:706.5 MHz	Engineer	:Tin
Operation Mode	:Tx CH LOW		
EUT Pol.	:E2 Plane	Measurement Antenna Pol.	:HORIZONTAL

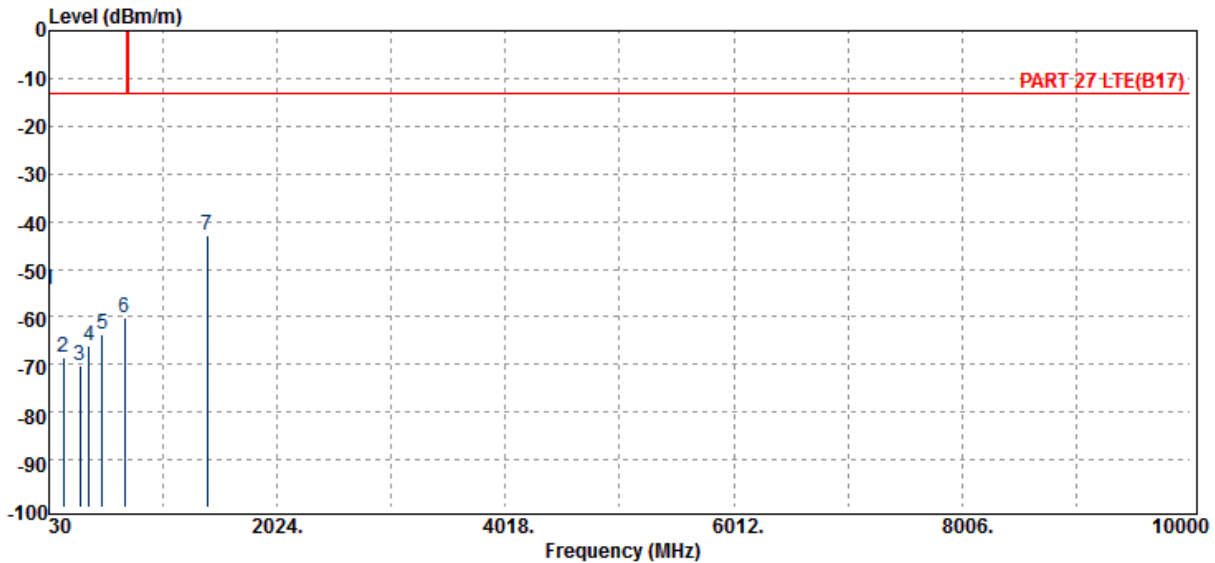

Freq. MHz	ERP/EIRP dBm	SG Output Level dBm	Antenna Gain dBd/dBi	Cable Loss dB	Limit dBm	Margin dB
30.00	-54.38	-39.22	-14.58	-0.58	-13.00	-41.38
159.01	-68.60	-66.00	-1.30	-1.30	-13.00	-55.60
299.66	-70.41	-72.20	3.61	-1.82	-13.00	-57.41
376.29	-66.24	-67.98	3.78	-2.03	-13.00	-53.24
498.51	-63.76	-65.64	4.04	-2.16	-13.00	-50.76
692.51	-60.17	-61.11	3.70	-2.76	-13.00	-47.17
1413.00	-42.84	-47.08	8.25	-4.00	-13.00	-29.84

Unless otherwise stated the results shown in this test report refer only to the sample(s) tested and such sample(s) are retained for 90 days only.

除非另有說明，此報告結果僅對測試之樣品負責，同時此樣品僅保留90天。本報告未經本公司書面許可，不可部份複製。

This document is issued by the Company subject to its General Conditions of Service printed overleaf, available on request or accessible at [www.sgs.com/terms\\_and\\_conditions.htm](http://www.sgs.com/terms_and_conditions.htm) and, for electronic format documents, subject to Terms and Conditions for Electronic Documents at [www.sgs.com/terms\\_e-document.htm](http://www.sgs.com/terms_e-document.htm). Attention is drawn to the limitation of liability, indemnification and jurisdiction issues defined therein. Any holder of this document is advised that information contained hereon reflects the Company's findings at the time of its intervention only and within the limits of Client's instructions, if any. The Company's sole responsibility is to its Client and this document does not exonerate parties to a transaction from exercising all their rights and obligations under the transaction documents. This document cannot be reproduced except in full, without prior written approval of the Company. Any unauthorized alteration, forgery or falsification of the content or appearance of this document is unlawful and offenders may be prosecuted to the fullest extent of the law.

Operation Band	:LTE B17	Temp./Humi.	:24.1 deg_C / 65 RH
Fundamental Frequency	:710 MHz	Engineer	:Tin
Operation Mode	:Tx CH MID	Measurement Antenna	:VERTICAL
EUT Pol.	:E2 Plane	Pol.	

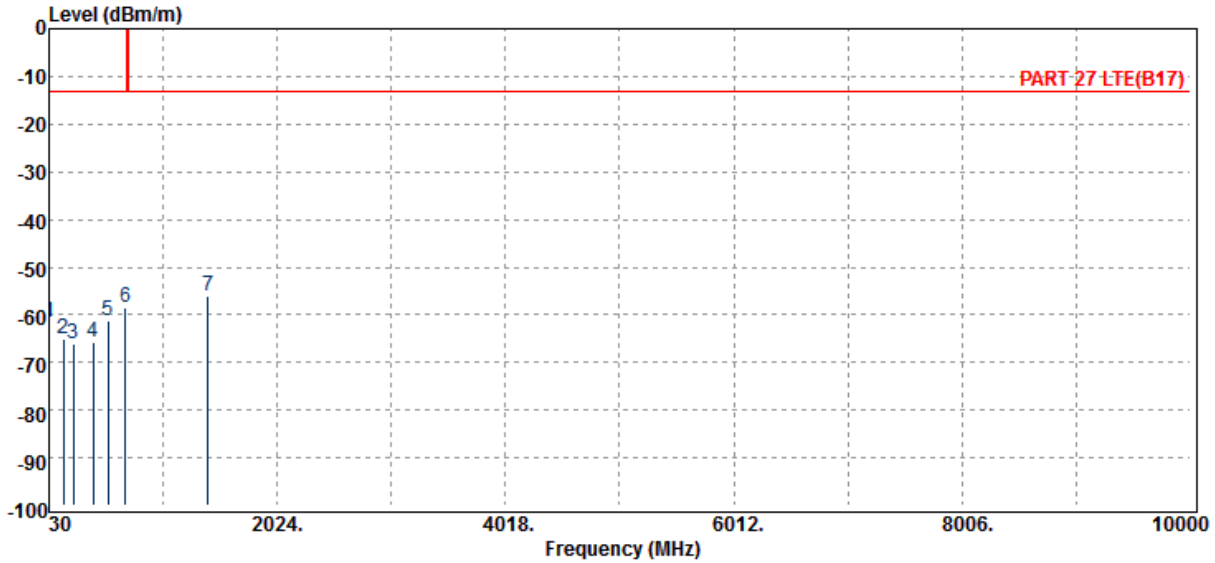

Freq. MHz	ERP/EIRP dBm	SG Output Level dBm	Antenna Gain dBd/dBi	Cable Loss dB	Limit dBm	Margin dB
30.00	-61.71	-46.55	-14.58	-0.58	-13.00	-48.71
156.10	-65.03	-62.28	-1.46	-1.30	-13.00	-52.03
239.52	-66.13	-67.93	3.47	-1.67	-13.00	-53.13
415.09	-65.70	-67.24	3.66	-2.12	-13.00	-52.70
544.10	-61.08	-63.28	3.99	-1.79	-13.00	-48.08
694.45	-58.59	-59.67	3.69	-2.61	-13.00	-45.59
1420.00	-55.93	-60.20	8.28	-4.01	-13.00	-42.93

Unless otherwise stated the results shown in this test report refer only to the sample(s) tested and such sample(s) are retained for 90 days only.

除非另有說明，此報告結果僅對測試之樣品負責，同時此樣品僅保留90天。本報告未經本公司書面許可，不可部份複製。

This document is issued by the Company subject to its General Conditions of Service printed overleaf, available on request or accessible at [www.sgs.com/terms\\_and\\_conditions.htm](http://www.sgs.com/terms_and_conditions.htm) and, for electronic format documents, subject to Terms and Conditions for Electronic Documents at [www.sgs.com/terms\\_e-document.htm](http://www.sgs.com/terms_e-document.htm). Attention is drawn to the limitation of liability, indemnification and jurisdiction issues defined therein. Any holder of this document is advised that information contained hereon reflects the Company's findings at the time of its intervention only and within the limits of Client's instructions, if any. The Company's sole responsibility is to its Client and this document does not exonerate parties to a transaction from exercising all their rights and obligations under the transaction documents. This document cannot be reproduced except in full, without prior written approval of the Company. Any unauthorized alteration, forgery or falsification of the content or appearance of this document is unlawful and offenders may be prosecuted to the fullest extent of the law.

Operation Band	:LTE B17	Temp./Humi.	:24.1 deg_C / 65 RH
Fundamental Frequency	:710 MHz	Engineer	:Tin
Operation Mode	:Tx CH MID		
EUT Pol.	:E2 Plane	Measurement Antenna Pol.	:HORIZONTAL

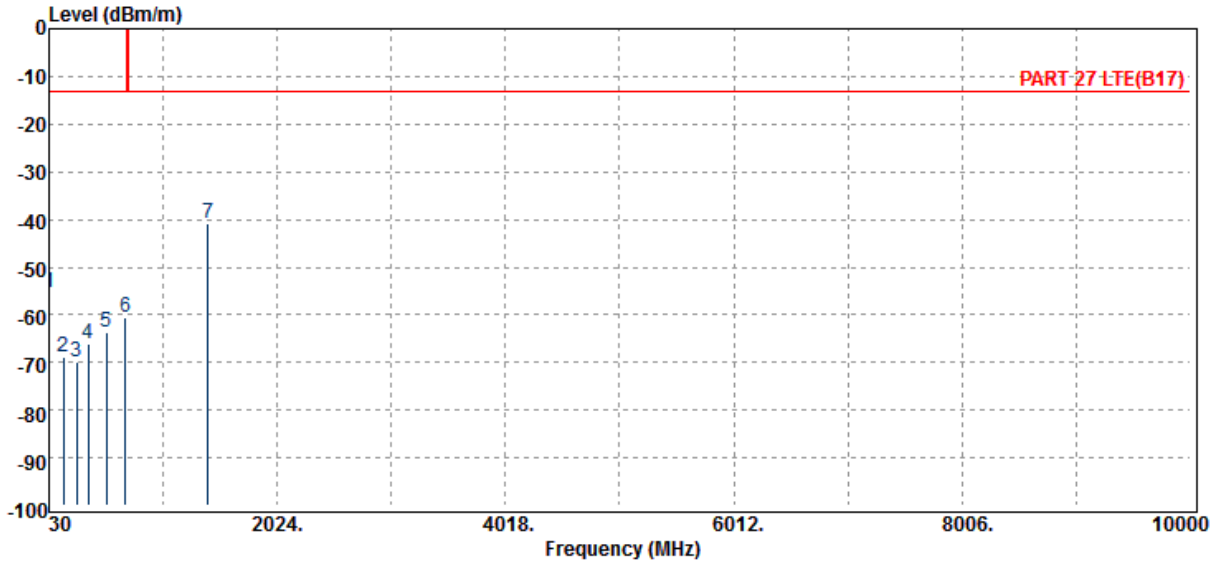

Freq. MHz	ERP/EIRP dBm	SG Output Level dBm	Antenna Gain dBd/dBi	Cable Loss dB	Limit dBm	Margin dB
30.00	-55.32	-40.16	-14.58	-0.58	-13.00	-42.32
154.16	-68.87	-66.01	-1.57	-1.30	-13.00	-55.87
269.59	-69.86	-71.65	3.51	-1.72	-13.00	-56.86
374.35	-65.93	-67.67	3.78	-2.04	-13.00	-52.93
532.46	-63.67	-65.41	4.01	-2.27	-13.00	-50.67
697.36	-60.48	-61.78	3.68	-2.38	-13.00	-47.48
1420.00	-40.76	-45.02	8.28	-4.01	-13.00	-27.76

Unless otherwise stated the results shown in this test report refer only to the sample(s) tested and such sample(s) are retained for 90 days only.

除非另有說明，此報告結果僅對測試之樣品負責，同時此樣品僅保留90天。本報告未經本公司書面許可，不可部份複製。

This document is issued by the Company subject to its General Conditions of Service printed overleaf, available on request or accessible at [www.sgs.com/terms\\_and\\_conditions.htm](http://www.sgs.com/terms_and_conditions.htm) and, for electronic format documents, subject to Terms and Conditions for Electronic Documents at [www.sgs.com/terms\\_e-document.htm](http://www.sgs.com/terms_e-document.htm). Attention is drawn to the limitation of liability, indemnification and jurisdiction issues defined therein. Any holder of this document is advised that information contained hereon reflects the Company's findings at the time of its intervention only and within the limits of Client's instructions, if any. The Company's sole responsibility is to its Client and this document does not exonerate parties to a transaction from exercising all their rights and obligations under the transaction documents. This document cannot be reproduced except in full, without prior written approval of the Company. Any unauthorized alteration, forgery or falsification of the content or appearance of this document is unlawful and offenders may be prosecuted to the fullest extent of the law.



Operation Band	:LTE B17	Temp./Humi.	:24.1 deg_C / 65 RH
Fundamental Frequency	:713.5 MHz	Engineer	:Tin
Operation Mode	:Tx CH HIGH	Measurement Antenna	:VERTICAL
EUT Pol.	:E2 Plane	Pol.	

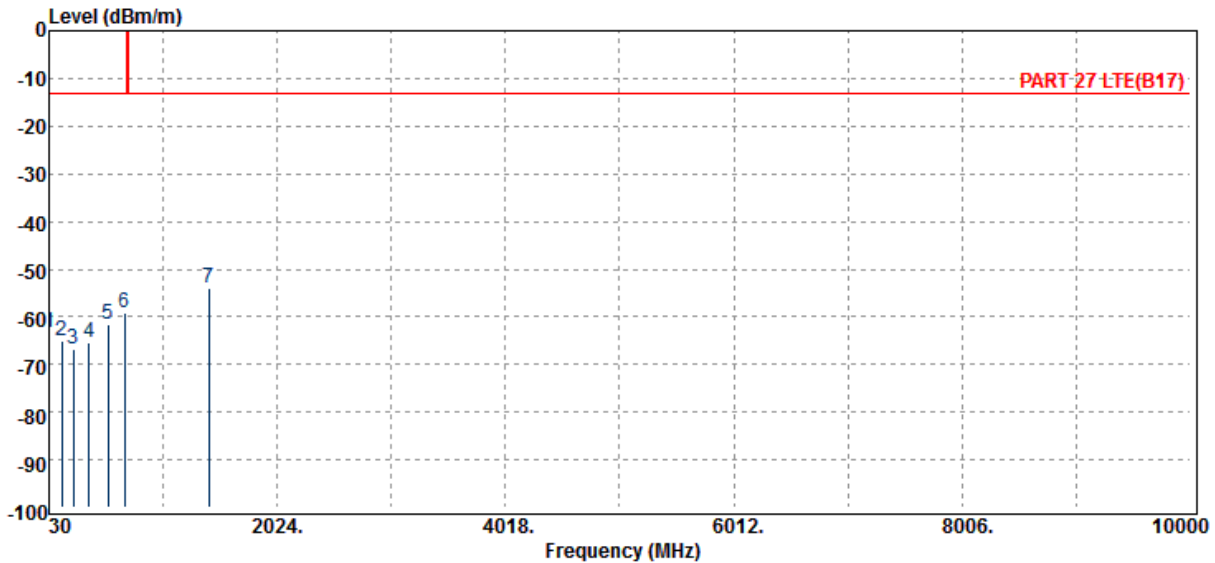

Freq. MHz	ERP/EIRP dBm	SG Output Level dBm	Antenna Gain dBd/dBi	Cable Loss dB	Limit dBm	Margin dB
30.00	-63.42	-48.26	-14.58	-0.58	-13.00	-50.42
138.64	-65.06	-61.55	-2.26	-1.25	-13.00	-52.06
245.34	-66.76	-68.58	3.51	-1.69	-13.00	-53.76
381.14	-65.35	-67.10	3.77	-2.02	-13.00	-52.35
544.10	-61.50	-63.69	3.99	-1.79	-13.00	-48.50
691.54	-59.27	-60.14	3.70	-2.83	-13.00	-46.27
1427.00	-53.82	-58.09	8.30	-4.03	-13.00	-40.82

Unless otherwise stated the results shown in this test report refer only to the sample(s) tested and such sample(s) are retained for 90 days only.

除非另有說明，此報告結果僅對測試之樣品負責，同時此樣品僅保留90天。本報告未經本公司書面許可，不可部份複製。

This document is issued by the Company subject to its General Conditions of Service printed overleaf, available on request or accessible at [www.sgs.com/terms\\_and\\_conditions.htm](http://www.sgs.com/terms_and_conditions.htm) and, for electronic format documents, subject to Terms and Conditions for Electronic Documents at [www.sgs.com/terms\\_e-document.htm](http://www.sgs.com/terms_e-document.htm). Attention is drawn to the limitation of liability, indemnification and jurisdiction issues defined therein. Any holder of this document is advised that information contained hereon reflects the Company's findings at the time of its intervention only and within the limits of Client's instructions, if any. The Company's sole responsibility is to its Client and this document does not exonerate parties to a transaction from exercising all their rights and obligations under the transaction documents. This document cannot be reproduced except in full, without prior written approval of the Company. Any unauthorized alteration, forgery or falsification of the content or appearance of this document is unlawful and offenders may be prosecuted to the fullest extent of the law.

SGS Taiwan Ltd.

No.134,WuKungRoad,NewTaipeiIndustrialPark,WukuDistrict,NewTaipeiCity,Taiwan24803/新北市五股區新北產業園區五工路 134 號

台灣檢驗科技股份有限公司

t (886-2) 2299-3279

f (886-2) 2298-0488

www.tw.sgs.com

Member of SGS Group

Operation Band	:LTE B17	Temp./Humi.	:24.1 deg_C / 65 RH
Fundamental Frequency	:713.5 MHz	Engineer	:Tin
Operation Mode	:Tx CH HIGH		
EUT Pol.	:E2 Plane	Measurement Antenna Pol.	:HORIZONTAL

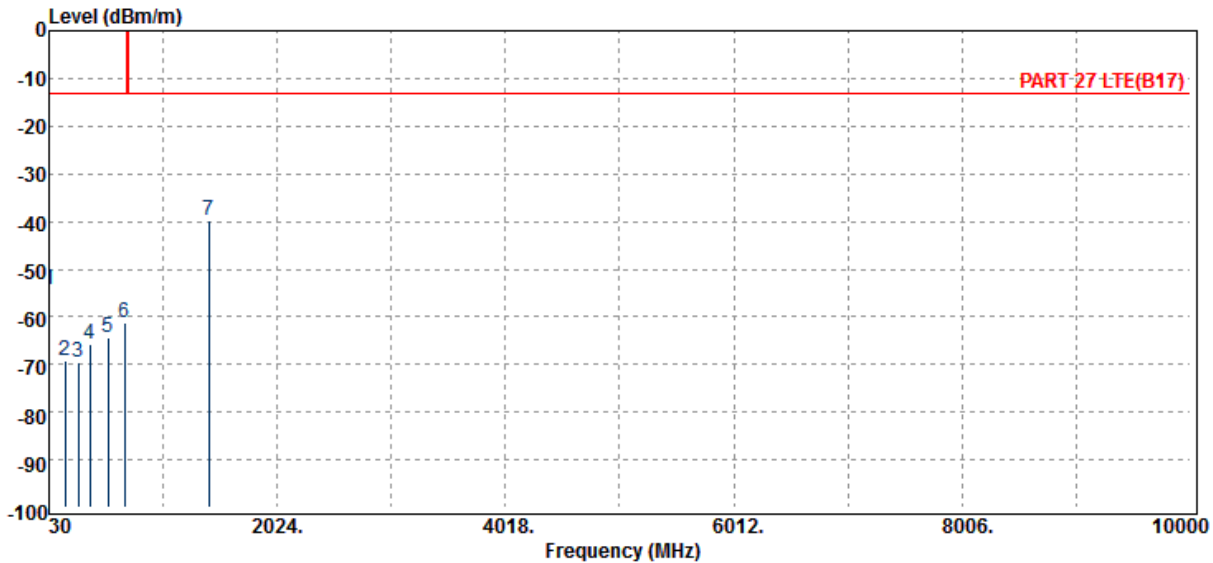

Freq. MHz	ERP/EIRP dBm	SG Output Level dBm	Antenna Gain dBd/dBi	Cable Loss dB	Limit dBm	Margin dB
30.00	-54.40	-39.24	-14.58	-0.58	-13.00	-41.40
167.74	-69.07	-66.99	-0.76	-1.32	-13.00	-56.07
285.11	-69.59	-71.25	3.42	-1.76	-13.00	-56.59
388.90	-65.90	-67.60	3.74	-2.04	-13.00	-52.90
544.10	-64.46	-66.66	3.99	-1.79	-13.00	-51.46
691.54	-61.12	-61.98	3.70	-2.83	-13.00	-48.12
1427.00	-39.67	-43.95	8.30	-4.03	-13.00	-26.67

Unless otherwise stated the results shown in this test report refer only to the sample(s) tested and such sample(s) are retained for 90 days only.

除非另有說明，此報告結果僅對測試之樣品負責，同時此樣品僅保留90天。本報告未經本公司書面許可，不可部份複製。

This document is issued by the Company subject to its General Conditions of Service printed overleaf, available on request or accessible at [www.sgs.com/terms\\_and\\_conditions.htm](http://www.sgs.com/terms_and_conditions.htm) and, for electronic format documents, subject to Terms and Conditions for Electronic Documents at [www.sgs.com/terms\\_e-document.htm](http://www.sgs.com/terms_e-document.htm). Attention is drawn to the limitation of liability, indemnification and jurisdiction issues defined therein. Any holder of this document is advised that information contained hereon reflects the Company's findings at the time of its intervention only and within the limits of Client's instructions, if any. The Company's sole responsibility is to its Client and this document does not exonerate parties to a transaction from exercising all their rights and obligations under the transaction documents. This document cannot be reproduced except in full, without prior written approval of the Company. Any unauthorized alteration, forgery or falsification of the content or appearance of this document is unlawful and offenders may be prosecuted to the fullest extent of the law.

## 11. FREQUENCY STABILITY MEASUREMENT

### 11.1. Standard Applicable

The frequency stability shall be sufficient to ensure that the fundamental emission stays within the authorized frequency block.

### 11.2. Test Set-up

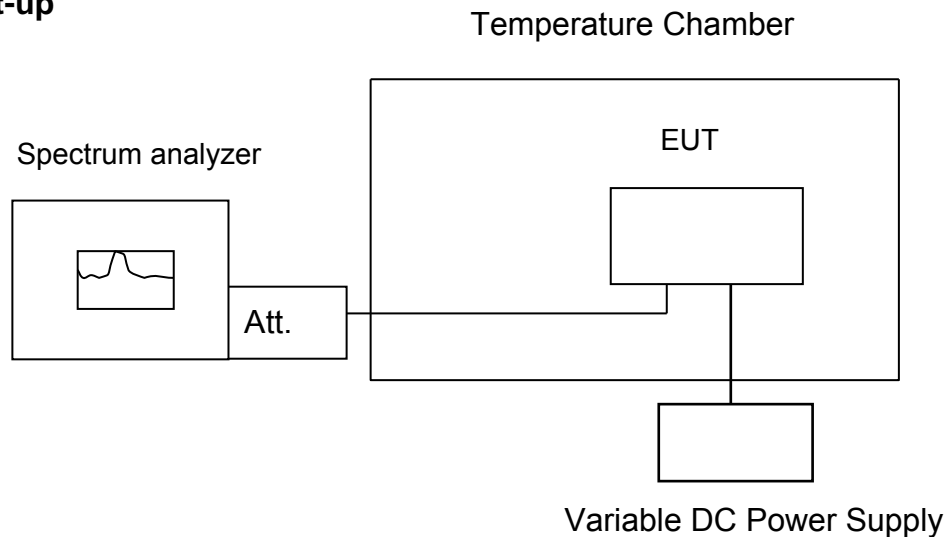

**Note:** Measurement setup for testing on Antenna connector

### 11.3. Measurement Procedure

The equipment under test was connected to an external AC or DC power supply and input rated voltage. RF output was connected to a frequency counter or spectrum analyzer via feed through attenuators. The EUT was placed inside the temperature chamber. Set the spectrum analyzer RBW low enough to obtain the desired frequency resolution and measure EUT 25°C operating frequency as reference frequency. Turn EUT off and set the chamber temperature to -30°C. After the temperature stabilized for approximately 30 minutes recorded the frequency. Repeat step measure with 10°C increased per stage until the highest temperature of +50°C reached.

Set chamber temperature to 25°C. Use a variable AC power supply / DC power source to power the EUT and set the voltage to rated voltage. Set the spectrum analyzer RBW low enough to obtain the desired frequency resolution and recorded the frequency.

Reduce the input voltage to specify extreme voltage variation (+/- 15%) and endpoint as declared by the manufacturer, record the maximum frequency change.

Unless otherwise stated the results shown in this test report refer only to the sample(s) tested and such sample(s) are retained for 90 days only.

除非另有說明，此報告結果僅對測試之樣品負責，同時此樣品僅保留90天。本報告未經本公司書面許可，不可部份複製。

This document is issued by the Company subject to its General Conditions of Service printed overleaf, available on request or accessible at [www.sgs.com/terms\\_and\\_conditions.htm](http://www.sgs.com/terms_and_conditions.htm) and, for electronic format documents, subject to Terms and Conditions for Electronic Documents at [www.sgs.com/terms\\_e-document.htm](http://www.sgs.com/terms_e-document.htm). Attention is drawn to the limitation of liability, indemnification and jurisdiction issues defined therein. Any holder of this document is advised that information contained hereon reflects the Company's findings at the time of its intervention only and within the limits of Client's instructions, if any. The Company's sole responsibility is to its Client and this document does not exonerate parties to a transaction from exercising all their rights and obligations under the transaction documents. This document cannot be reproduced except in full, without prior written approval of the Company. Any unauthorized alteration, forgery or falsification of the content or appearance of this document is unlawful and offenders may be prosecuted to the fullest extent of the law.

#### 11.4. Measurement Equipment Used

EQUIPMENT TYPE	MFR	MODEL NUMBER	SERIAL NUMBER	LAST CAL.	CAL DUE.
EXA Spectrum Analyzer	Agilent	N9010A	MY57120290	2018/02/14	2019/02/13
Radio Communication Analyer	Anritsu	MT8820C	6200995019	2018/04/05	2019/04/04
DC Power Supply	Anritsu	E3640A	MY40000811	2017/12/18	2018/12/17
Attenuator	Mini-Circuit	BW-S10W2+	2	2018/01/02	2019/01/01
DC Block	Mini-Circuits	BLK-18-S+	1	2018/01/02	2019/01/01
Splitter	RF-LAMBAD	RFLT2W1G18G	11-JSPF412-018	2018/01/02	2019/01/01
Coaxial Cables	N/A	WK CE Cable	N/A	2018/01/02	2019/01/01

Unless otherwise stated the results shown in this test report refer only to the sample(s) tested and such sample(s) are retained for 90 days only.

除非另有說明，此報告結果僅對測試之樣品負責，同時此樣品僅保留90天。本報告未經本公司書面許可，不可部份複製。

This document is issued by the Company subject to its General Conditions of Service printed overleaf, available on request or accessible at [www.sgs.com/terms\\_and\\_conditions.htm](http://www.sgs.com/terms_and_conditions.htm) and, for electronic format documents, subject to Terms and Conditions for Electronic Documents at [www.sgs.com/terms\\_e-document.htm](http://www.sgs.com/terms_e-document.htm). Attention is drawn to the limitation of liability, indemnification and jurisdiction issues defined therein. Any holder of this document is advised that information contained hereon reflects the Company's findings at the time of its intervention only and within the limits of Client's instructions, if any. The Company's sole responsibility is to its Client and this document does not exonerate parties to a transaction from exercising all their rights and obligations under the transaction documents. This document cannot be reproduced except in full, without prior written approval of the Company. Any unauthorized alteration, forgery or falsification of the content or appearance of this document is unlawful and offenders may be prosecuted to the fullest extent of the law.

SGS Taiwan Ltd.

No.134,WuKungRoad,NewTaipeiIndustrialPark,WukuDistrict,NewTaipeiCity,Taiwan24803/新北市五股區新北產業園區五工路 134 號

台灣檢驗科技股份有限公司

t (886-2) 2299-3279

f (886-2) 2298-0488

[www.tw.sgs.com](http://www.tw.sgs.com)

Member of SGS Group

## 11.5. Measurement Result

### FREQUENCY ERROR vs. VOLTAGE

Reference Frequency: GPRS 850 Mid Channel 836.6 MHz				
Limit: +/- 2.5 ppm				
Power Supply	Environment	Frequency	Delta (Hz)	Limit (Hz)
Vdc	Temperature (°C)	(MHz)		
4.43	20	836.59991	-90	2091
3.85	20	836.60048	479.9999999	2091
3.27	20	836.60019	190	2091
3 (End point)	20	836.60009	90	2091

### FREQUENCY ERROR vs. TEMPERATURE

Reference Frequency: GPRS 850 Mid Channel 836.6 MHz				
Limit: +/- 2.5 ppm				
Power Supply	Environment	Frequency	Delta (Hz)	Limit (Hz)
Vdc	Temperature (°C)	(MHz)		
3.85	50	836.60023	230	2091
3.85	40	836.60016	159.9999999	2091
3.85	30	836.6	0	2091
3.85	20	836.60048	479.9999999	2091
3.85	10	836.60027	270	2091
3.85	0	836.60032	320	2091
3.85	-10	836.60006	59.99999996	2091
3.85	-20	836.59997	-30.00000004	2091
3.85	-30	836.60007	69.99999994	2091

Unless otherwise stated the results shown in this test report refer only to the sample(s) tested and such sample(s) are retained for 90 days only.

除非另有說明，此報告結果僅對測試之樣品負責，同時此樣品僅保留90天。本報告未經本公司書面許可，不可部份複製。

This document is issued by the Company subject to its General Conditions of Service printed overleaf, available on request or accessible at [www.sgs.com/terms\\_and\\_conditions.htm](http://www.sgs.com/terms_and_conditions.htm) and, for electronic format documents, subject to Terms and Conditions for Electronic Documents at [www.sgs.com/terms\\_e-document.htm](http://www.sgs.com/terms_e-document.htm). Attention is drawn to the limitation of liability, indemnification and jurisdiction issues defined therein. Any holder of this document is advised that information contained hereon reflects the Company's findings at the time of its intervention only and within the limits of Client's instructions, if any. The Company's sole responsibility is to its Client and this document does not exonerate parties to a transaction from exercising all their rights and obligations under the transaction documents. This document cannot be reproduced except in full, without prior written approval of the Company. Any unauthorized alteration, forgery or falsification of the content or appearance of this document is unlawful and offenders may be prosecuted to the fullest extent of the law.

### FREQUENCY ERROR vs. VOLTAGE

Reference Frequency: GPRS 1900 Mid Channel 1880 MHz				
Limit: +/- 2.5 ppm				
Power Supply	Environment	Frequency	Delta (Hz)	Limit (Hz)
Vdc	Temperature (°C)	(MHz)		
4.43	20	1879.99995	-50.0000001	4700
3.85	20	1880.00004	39.9999999	4700
3.27	20	1880.0001	99.99999997	4700
3 (End point)	20	1879.9999	-99.99999997	4700

### FREQUENCY ERROR vs. TEMPERATURE

Reference Frequency: GPRS 1900 Mid Channel 1880 MHz				
Limit: +/- 2.5 ppm = Hz				
Power Supply	Environment	Frequency	Delta (Hz)	Limit (Hz)
Vdc	Temperature (°C)	(MHz)		
3.85	50	1880.0001	99.99999997	4700
3.85	40	1880.00008	80.00000003	4700
3.85	30	1880.00004	39.9999999	4700
3.85	20	1880.00004	39.9999999	4700
3.85	10	1879.99992	-80.00000003	4700
3.85	0	1879.99994	-60.00000008	4700
3.85	-10	1880	0	4700
3.85	-20	1879.99992	-80.00000003	4700
3.85	-30	1879.99993	-70.00000005	4700

Unless otherwise stated the results shown in this test report refer only to the sample(s) tested and such sample(s) are retained for 90 days only.

除非另有說明，此報告結果僅對測試之樣品負責，同時此樣品僅保留90天。本報告未經本公司書面許可，不可部份複製。

This document is issued by the Company subject to its General Conditions of Service printed overleaf, available on request or accessible at [www.sgs.com/terms\\_and\\_conditions.htm](http://www.sgs.com/terms_and_conditions.htm) and, for electronic format documents, subject to Terms and Conditions for Electronic Documents at [www.sgs.com/terms\\_e-document.htm](http://www.sgs.com/terms_e-document.htm). Attention is drawn to the limitation of liability, indemnification and jurisdiction issues defined therein. Any holder of this document is advised that information contained hereon reflects the Company's findings at the time of its intervention only and within the limits of Client's instructions, if any. The Company's sole responsibility is to its Client and this document does not exonerate parties to a transaction from exercising all their rights and obligations under the transaction documents. This document cannot be reproduced except in full, without prior written approval of the Company. Any unauthorized alteration, forgery or falsification of the content or appearance of this document is unlawful and offenders may be prosecuted to the fullest extent of the law.

### FREQUENCY ERROR vs. VOLTAGE

Reference Frequency: WCDMA II Mid Channel 1880 MHz				
Limit: +/- 2.5 ppm				
Power Supply	Environment	Frequency	Delta (Hz)	Limit (Hz)
Vdc	Temperature (°C)	(MHz)		
4.43	20	1879.99995	-50.0000001	4700
3.85	20	1880.00006	60.00000008	4700
3.27	20	1879.99992	-80.00000003	4700
3 (End point)	20	1880.00004	39.9999999	4700

### FREQUENCY ERROR vs. TEMPERATURE

Reference Frequency: WCDMA II Mid Channel 1880 MHz				
Limit: +/- 2.5 ppm				
Power Supply	Environment	Frequency	Delta (Hz)	Limit (Hz)
Vdc	Temperature (°C)	(MHz)		
3.85	50	1880.00004	39.9999999	4700
3.85	40	1880.00003	29.99999992	4700
3.85	30	1880	0	4700
3.85	20	1880.00006	60.00000008	4700
3.85	10	1880.00008	80.00000003	4700
3.85	0	1880.00007	70.00000005	4700
3.85	-10	1880.00006	60.00000008	4700
3.85	-20	1880.00004	39.9999999	4700
3.85	-30	1879.99996	-39.9999999	4700

Unless otherwise stated the results shown in this test report refer only to the sample(s) tested and such sample(s) are retained for 90 days only.

除非另有說明，此報告結果僅對測試之樣品負責，同時此樣品僅保留90天。本報告未經本公司書面許可，不可部份複製。

This document is issued by the Company subject to its General Conditions of Service printed overleaf, available on request or accessible at [www.sgs.com/terms\\_and\\_conditions.htm](http://www.sgs.com/terms_and_conditions.htm) and, for electronic format documents, subject to Terms and Conditions for Electronic Documents at [www.sgs.com/terms\\_e-document.htm](http://www.sgs.com/terms_e-document.htm). Attention is drawn to the limitation of liability, indemnification and jurisdiction issues defined therein. Any holder of this document is advised that information contained hereon reflects the Company's findings at the time of its intervention only and within the limits of Client's instructions, if any. The Company's sole responsibility is to its Client and this document does not exonerate parties to a transaction from exercising all their rights and obligations under the transaction documents. This document cannot be reproduced except in full, without prior written approval of the Company. Any unauthorized alteration, forgery or falsification of the content or appearance of this document is unlawful and offenders may be prosecuted to the fullest extent of the law.

SGS Taiwan Ltd.

No.134,WuKungRoad,NewTaipeiIndustrialPark,WukuDistrict,NewTaipeiCity,Taiwan24803/新北市五股區新北產業園區五工路 134 號

台灣檢驗科技股份有限公司

t (886-2) 2299-3279

f (886-2) 2298-0488

www.tw.sgs.com

Member of SGS Group

### FREQUENCY ERROR vs. VOLTAGE

Reference Frequency: WCDMA IV Mid Channel 1732.6 MHz				
Limit: +/- 2.5 ppm				
Power Supply	Environment	Frequency	Delta (Hz)	Limit (Hz)
Vdc	Temperature (°C)	(MHz)		
4.43	20	1732.599949	-50.99999998	4331
3.85	20	1732.59998	-19.99999995	4331
3.27	20	1732.599945	-54.99999997	4331
3 (End point)	20	1732.599977	-22.99999983	4331

### FREQUENCY ERROR vs. TEMPERATURE

Reference Frequency: WCDMA IV Mid Channel 1732.6 MHz				
Limit: +/- 2.5 ppm				
Power Supply	Environment	Frequency	Delta (Hz)	Limit (Hz)
Vdc	Temperature (°C)	(MHz)		
3.85	50	1732.599901	-98.99999986	4331
3.85	40	1732.59995	-49.99999987	4331
3.85	30	1732.59995	-49.99999987	4331
3.85	20	1732.59998	-19.99999995	4331
3.85	10	1732.59992	-79.9999998	4331
3.85	0	1732.59992	-79.9999998	4331
3.85	-10	1732.59993	-69.99999982	4331
3.85	-20	1732.59993	-69.99999982	4331
3.85	-30	1732.59993	-69.99999982	4331

Unless otherwise stated the results shown in this test report refer only to the sample(s) tested and such sample(s) are retained for 90 days only.

除非另有說明，此報告結果僅對測試之樣品負責，同時此樣品僅保留90天。本報告未經本公司書面許可，不可部份複製。

This document is issued by the Company subject to its General Conditions of Service printed overleaf, available on request or accessible at [www.sgs.com/terms\\_and\\_conditions.htm](http://www.sgs.com/terms_and_conditions.htm) and, for electronic format documents, subject to Terms and Conditions for Electronic Documents at [www.sgs.com/terms\\_e-document.htm](http://www.sgs.com/terms_e-document.htm). Attention is drawn to the limitation of liability, indemnification and jurisdiction issues defined therein. Any holder of this document is advised that information contained hereon reflects the Company's findings at the time of its intervention only and within the limits of Client's instructions, if any. The Company's sole responsibility is to its Client and this document does not exonerate parties to a transaction from exercising all their rights and obligations under the transaction documents. This document cannot be reproduced except in full, without prior written approval of the Company. Any unauthorized alteration, forgery or falsification of the content or appearance of this document is unlawful and offenders may be prosecuted to the fullest extent of the law.

SGS Taiwan Ltd.

No.134,WuKungRoad,NewTaipeiIndustrialPark,WukuDistrict,NewTaipeiCity,Taiwan24803/新北市五股區新北產業園區五工路 134 號

台灣檢驗科技股份有限公司

t (886-2) 2299-3279

f (886-2) 2298-0488

www.tw.sgs.com

Member of SGS Group



Reference Freq.:		LTE B2 Mid Channel		1880 MHz	20M QPSK CH 18900
Power Supply Vdc	Temp. (°C)	Freq. (MHz)	Delta (Hz)	Limit = +/- 2.5 ppm (Hz)	
<b>Freq. ERROR vs. VOLTAGE</b>					
4.43	25	1879.999980	-19.99999995	4700	
3.85	25	1880.000015	15.00000008	4700	
3.27	25	1880.000018	17.99999995	4700	
3 (End Point)	25	1879.999995	-5.000000101	4700	
<b>Freq. ERROR vs. Temp.</b>					
3.85	-30	1879.999984	-15.99999996	4700	
3.85	-20	1880.000002	1.999999995	4700	
3.85	-10	1880.000018	17.99999995	4700	
3.85	0	1879.999994	-5.999999985	4700	
3.85	10	1879.999997	-3.000000106	4700	
3.85	20	1880.000014	13.99999996	4700	
3.85	30	1880.000008	7.99999998	4700	
3.85	40	1879.999991	-9.000000091	4700	
3.85	50	1880.000006	5.999999985	4700	

Unless otherwise stated the results shown in this test report refer only to the sample(s) tested and such sample(s) are retained for 90 days only.

除非另有說明，此報告結果僅對測試之樣品負責，同時此樣品僅保留90天。本報告未經本公司書面許可，不可部份複製。

This document is issued by the Company subject to its General Conditions of Service printed overleaf, available on request or accessible at [www.sgs.com/terms\\_and\\_conditions.htm](http://www.sgs.com/terms_and_conditions.htm) and, for electronic format documents, subject to Terms and Conditions for Electronic Documents at [www.sgs.com/terms\\_e-document.htm](http://www.sgs.com/terms_e-document.htm). Attention is drawn to the limitation of liability, indemnification and jurisdiction issues defined therein. Any holder of this document is advised that information contained hereon reflects the Company's findings at the time of its intervention only and within the limits of Client's instructions, if any. The Company's sole responsibility is to its Client and this document does not exonerate parties to a transaction from exercising all their rights and obligations under the transaction documents. This document cannot be reproduced except in full, without prior written approval of the Company. Any unauthorized alteration, forgery or falsification of the content or appearance of this document is unlawful and offenders may be prosecuted to the fullest extent of the law.

SGS Taiwan Ltd.

No.134,WuKungRoad,NewTaipeiIndustrialPark,WukuDistrict,NewTaipeiCity,Taiwan24803/新北市五股區新北產業園區五工路 134 號

台灣檢驗科技股份有限公司

t (886-2) 2299-3279

f (886-2) 2298-0488

[www.tw.sgs.com](http://www.tw.sgs.com)

Member of SGS Group

Reference Freq.:		LTE B4 Mid Channel		1732.5	MHz 20M QPSK CH 20175
Power Supply Vdc	Temp. (°C)	Freq. (MHz)	Delta (Hz)	Limit = +/- 2.5 ppm (Hz)	
<b>Freq. ERROR vs. VOLTAGE</b>					
4.43	25	1732.499982	-18	4331	
3.85	25	1732.499988	-12	4331	
3.27	25	1732.500011	11	4331	
3 (End Point)	25	1732.500005	5	4331	
<b>Freq. ERROR vs. Temp.</b>					
3.85	-30	1732.499994	-6	4331	
3.85	-20	1732.500002	2	4331	
3.85	-10	1732.499997	-3	4331	
3.85	0	1732.499999	-1	4331	
3.85	10	1732.500017	17	4331	
3.85	20	1732.499995	-5	4331	
3.85	30	1732.500006	6	4331	
3.85	40	1732.499991	-9	4331	
3.85	50	1732.499992	-8	4331	

Unless otherwise stated the results shown in this test report refer only to the sample(s) tested and such sample(s) are retained for 90 days only.

除非另有說明，此報告結果僅對測試之樣品負責，同時此樣品僅保留90天。本報告未經本公司書面許可，不可部份複製。

This document is issued by the Company subject to its General Conditions of Service printed overleaf, available on request or accessible at [www.sgs.com/terms\\_and\\_conditions.htm](http://www.sgs.com/terms_and_conditions.htm) and, for electronic format documents, subject to Terms and Conditions for Electronic Documents at [www.sgs.com/terms\\_e-document.htm](http://www.sgs.com/terms_e-document.htm). Attention is drawn to the limitation of liability, indemnification and jurisdiction issues defined therein. Any holder of this document is advised that information contained hereon reflects the Company's findings at the time of its intervention only and within the limits of Client's instructions, if any. The Company's sole responsibility is to its Client and this document does not exonerate parties to a transaction from exercising all their rights and obligations under the transaction documents. This document cannot be reproduced except in full, without prior written approval of the Company. Any unauthorized alteration, forgery or falsification of the content or appearance of this document is unlawful and offenders may be prosecuted to the fullest extent of the law.

SGS Taiwan Ltd.

No.134,WuKungRoad,NewTaipeiIndustrialPark,WukuDistrict,NewTaipeiCity,Taiwan24803/新北市五股區新北產業園區五工路 134 號

台灣檢驗科技股份有限公司

t (886-2) 2299-3279

f (886-2) 2298-0488

[www.tw.sgs.com](http://www.tw.sgs.com)

Member of SGS Group

Reference Freq.: LTE B12 Mid Channel 707.5 MHz 10M QPSK CH 23095				
Power Supply Vdc	Temp. (°C)	Freq. (MHz)	Delta (Hz)	Limit = +/- 2.5 ppm (Hz)
<b>Freq. ERROR vs. VOLTAGE</b>				
4.43	25	707.500011	10.99999997	1769
3.85	25	707.500013	12.99999997	1769
3.27	25	707.499995	-4.999999987	1769
3 (End Point)	25	707.499982	-17.99999995	1769
<b>Freq. ERROR vs. Temp.</b>				
3.85	-30	707.499984	-15.99999996	1769
3.85	-20	707.499990	-9.999999975	1769
3.85	-10	707.500017	16.99999996	1769
3.85	0	707.500008	7.99999998	1769
3.85	10	707.499994	-5.999999985	1769
3.85	20	707.500009	8.999999977	1769
3.85	30	707.499989	-10.99999997	1769
3.85	40	707.499987	-12.99999997	1769
3.85	50	707.500019	18.99999995	1769

Unless otherwise stated the results shown in this test report refer only to the sample(s) tested and such sample(s) are retained for 90 days only.

除非另有說明，此報告結果僅對測試之樣品負責，同時此樣品僅保留90天。本報告未經本公司書面許可，不可部份複製。

This document is issued by the Company subject to its General Conditions of Service printed overleaf, available on request or accessible at [www.sgs.com/terms\\_and\\_conditions.htm](http://www.sgs.com/terms_and_conditions.htm) and, for electronic format documents, subject to Terms and Conditions for Electronic Documents at [www.sgs.com/terms\\_e-document.htm](http://www.sgs.com/terms_e-document.htm). Attention is drawn to the limitation of liability, indemnification and jurisdiction issues defined therein. Any holder of this document is advised that information contained hereon reflects the Company's findings at the time of its intervention only and within the limits of Client's instructions, if any. The Company's sole responsibility is to its Client and this document does not exonerate parties to a transaction from exercising all their rights and obligations under the transaction documents. This document cannot be reproduced except in full, without prior written approval of the Company. Any unauthorized alteration, forgery or falsification of the content or appearance of this document is unlawful and offenders may be prosecuted to the fullest extent of the law.

SGS Taiwan Ltd.

No.134,WuKungRoad,NewTaipeiIndustrialPark,WukuDistrict,NewTaipeiCity,Taiwan24803/新北市五股區新北產業園區五工路 134 號

台灣檢驗科技股份有限公司

t (886-2) 2299-3279

f (886-2) 2298-0488

[www.tw.sgs.com](http://www.tw.sgs.com)

Member of SGS Group

Reference Freq.:		LTE B17 Mid Channel		710 MHz	10M QPSK CH 23790
Power Supply Vdc	Temp. (°C)	Freq. (MHz)	Delta (Hz)	Limit = +/- 2.5 ppm (Hz)	
<b>Freq. ERROR vs. VOLTAGE</b>					
4.43	25	710.000010	10	1775	
3.85	25	709.999992	-8	1775	
3.27	25	710.000015	15	1775	
3 (End Point)	25	710.000017	17	1775	
<b>Freq. ERROR vs. Temp.</b>					
3.85	-30	709.999997	-3	1775	
3.85	-20	709.999982	-18	1775	
3.85	-10	709.999998	-2	1775	
3.85	0	710.000006	6	1775	
3.85	10	710.000013	13	1775	
3.85	20	710.000005	5	1775	
3.85	30	709.999993	-7	1775	
3.85	40	710.000002	2	1775	
3.85	50	709.999988	-12	1775	

**Note: The battery is rated 3.85V dc.**

Unless otherwise stated the results shown in this test report refer only to the sample(s) tested and such sample(s) are retained for 90 days only.

除非另有說明，此報告結果僅對測試之樣品負責，同時此樣品僅保留90天。本報告未經本公司書面許可，不可部份複製。

This document is issued by the Company subject to its General Conditions of Service printed overleaf, available on request or accessible at [www.sgs.com/terms\\_and\\_conditions.htm](http://www.sgs.com/terms_and_conditions.htm) and, for electronic format documents, subject to Terms and Conditions for Electronic Documents at [www.sgs.com/terms\\_e-document.htm](http://www.sgs.com/terms_e-document.htm). Attention is drawn to the limitation of liability, indemnification and jurisdiction issues defined therein. Any holder of this document is advised that information contained hereon reflects the Company's findings at the time of its intervention only and within the limits of Client's instructions, if any. The Company's sole responsibility is to its Client and this document does not exonerate parties to a transaction from exercising all their rights and obligations under the transaction documents. This document cannot be reproduced except in full, without prior written approval of the Company. Any unauthorized alteration, forgery or falsification of the content or appearance of this document is unlawful and offenders may be prosecuted to the fullest extent of the law.

SGS Taiwan Ltd.

No.134,WuKungRoad,NewTaipeiIndustrialPark,WukuDistrict,NewTaipeiCity,Taiwan24803/新北市五股區新北產業園區五工路 134 號

台灣檢驗科技股份有限公司

t (886-2) 2299-3279

f (886-2) 2298-0488

[www.tw.sgs.com](http://www.tw.sgs.com)

Member of SGS Group

## 12. PEAK TO AVERAGE RATIO

### 12.1. Standard Applicable

The peak-to-average ratio (PAR) of the transmission may not exceed 13dB.

### 12.2. Test SET-UP

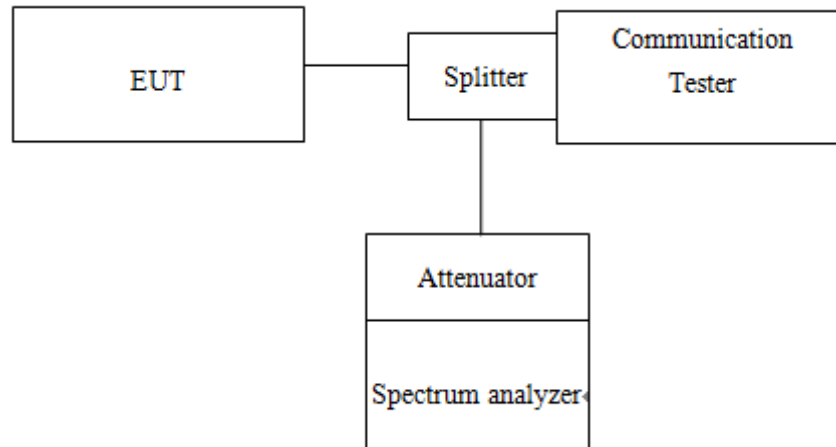

### 12.3. Measurement Procedure

1. KDB 971168 D01 is employed as the following procedure is proper adjusted accordingly:
2. Set resolution/measurement bandwidth  $\geq$  signal's occupied bandwidth; & internal =1ms
3. Set the number of counts to a value that stabilizes the measured CCDF curve.

### 12.4. Measurement Equipment Used

EQUIPMENT TYPE	MFR	MODEL NUMBER	SERIAL NUMBER	LAST CAL.	CAL DUE.
EXA Spectrum Analyzer	Agilent	N9010A	MY57120290	2018/02/14	2019/02/13
Radio Communication Analyzer	Anritsu	MT8815B	6200711454	2018/04/05	2019/04/04
DC Power Supply	Anritsu	E3640A	MY40000811	2017/12/18	2018/12/17
Attenuator	Mini-Circuit	BW-S10W2+	2	2018/01/02	2019/01/01
DC Block	Mini-Circuits	BLK-18-S+	1	2018/01/02	2019/01/01
Splitter	RF-LAMBDA	RFLT2W1G18G	11-JSPF412-018	2018/01/02	2019/01/01
Coaxial Cables	N/A	WK CE Cable	N/A	2018/01/02	2019/01/01

Unless otherwise stated the results shown in this test report refer only to the sample(s) tested and such sample(s) are retained for 90 days only.

除非另有說明，此報告結果僅對測試之樣品負責，同時此樣品僅保留90天。本報告未經本公司書面許可，不可部份複製。

This document is issued by the Company subject to its General Conditions of Service printed overleaf, available on request or accessible at [www.sgs.com/terms\\_and\\_conditions.htm](http://www.sgs.com/terms_and_conditions.htm) and, for electronic format documents, subject to Terms and Conditions for Electronic Documents at [www.sgs.com/terms\\_e-document.htm](http://www.sgs.com/terms_e-document.htm). Attention is drawn to the limitation of liability, indemnification and jurisdiction issues defined therein. Any holder of this document is advised that information contained hereon reflects the Company's findings at the time of its intervention only and within the limits of Client's instructions, if any. The Company's sole responsibility is to its Client and this document does not exonerate parties to a transaction from exercising all their rights and obligations under the transaction documents. This document cannot be reproduced except in full, without prior written approval of the Company. Any unauthorized alteration, forgery or falsification of the content or appearance of this document is unlawful and offenders may be prosecuted to the fullest extent of the law.

## 12.5. Measurement Result

### Tabular Results:

Freq. (MHz)	CH	Peak-to-Average Ratio (dB)	
		GSM 850	GPRS 850
824.2	128	9.74	11.55
836.6	190	8.63	10.53
848.8	251	8.66	10.28

Freq. (MHz)	CH	Peak-to-Average Ratio (dB)	
		GSM 1900	GPRS 1900
1850.2	512	9.98	9.71
1880	661	10.01	9.82
1909.8	810	10.17	10.15

Freq. (MHz)	CH	Peak-to-Average Ratio (dB)		
		WCDMA II	HSDPA II	HSUPA II
1852.4	9262	2.96	2.99	3.24
1880	9400	2.99	3.04	2.99
1907.6	9538	3.12	3.10	3.14

Freq. (MHz)	CH	Peak-to-Average Ratio (dB)		
		WCDMA IV	HSDPA IV	HSUPA IV
1712.4	1312	3.13	3.19	3.21
1732.6	1413	3.11	3.12	3.15
1752.6	1513	3.31	3.57	3.28

Unless otherwise stated the results shown in this test report refer only to the sample(s) tested and such sample(s) are retained for 90 days only.

除非另有說明，此報告結果僅對測試之樣品負責，同時此樣品僅保留90天。本報告未經本公司書面許可，不可部份複製。

This document is issued by the Company subject to its General Conditions of Service printed overleaf, available on request or accessible at [www.sgs.com/terms\\_and\\_conditions.htm](http://www.sgs.com/terms_and_conditions.htm) and, for electronic format documents, subject to Terms and Conditions for Electronic Documents at [www.sgs.com/terms\\_e-document.htm](http://www.sgs.com/terms_e-document.htm). Attention is drawn to the limitation of liability, indemnification and jurisdiction issues defined therein. Any holder of this document is advised that information contained hereon reflects the Company's findings at the time of its intervention only and within the limits of Client's instructions, if any. The Company's sole responsibility is to its Client and this document does not exonerate parties to a transaction from exercising all their rights and obligations under the transaction documents. This document cannot be reproduced except in full, without prior written approval of the Company. Any unauthorized alteration, forgery or falsification of the content or appearance of this document is unlawful and offenders may be prosecuted to the fullest extent of the law.

LTE BAND 2							
Channel bandwidth: 1.4MHz				Channel bandwidth: 3MHz			
Freq. (MHz)	CH	PAPR (dB)		Freq. (MHz)	CH	PAPR (dB)	
		64QAM	Limit			64QAM	Limit
1850.7	18607	6.62	13	1851.5	18615	6.31	13
1880.0	18900	6.83	13	1880.0	18900	6.68	13
1909.3	19193	6.38	13	1908.5	19185	6.61	13

LTE BAND 2							
Channel bandwidth: 5MHz				Channel bandwidth: 10MHz			
Freq. (MHz)	CH	PAPR (dB)		Freq. (MHz)	CH	PAPR (dB)	
		64QAM	Limit			64QAM	Limit
1852.5	18625	6.53	13	1855.0	18650	6.55	13
1880.0	18900	6.75	13	1880.0	18900	6.54	13
1907.5	19175	6.57	13	1905.0	19150	6.52	13

LTE BAND 2							
Channel bandwidth: 15MHz				Channel bandwidth: 20MHz			
Freq. (MHz)	CH	PAPR (dB)		Freq. (MHz)	CH	PAPR (dB)	
		64QAM	Limit			64QAM	Limit
1857.5	18675	6.44	13	1860.0	18700	6.82	13
1880.0	18900	6.36	13	1880.0	18900	6.76	13
1902.5	19125	6.29	13	1900.0	19100	6.86	13

Unless otherwise stated the results shown in this test report refer only to the sample(s) tested and such sample(s) are retained for 90 days only.

除非另有說明，此報告結果僅對測試之樣品負責，同時此樣品僅保留90天。本報告未經本公司書面許可，不可部份複製。

This document is issued by the Company subject to its General Conditions of Service printed overleaf, available on request or accessible at [www.sgs.com/terms\\_and\\_conditions.htm](http://www.sgs.com/terms_and_conditions.htm) and, for electronic format documents, subject to Terms and Conditions for Electronic Documents at [www.sgs.com/terms\\_e-document.htm](http://www.sgs.com/terms_e-document.htm). Attention is drawn to the limitation of liability, indemnification and jurisdiction issues defined therein. Any holder of this document is advised that information contained hereon reflects the Company's findings at the time of its intervention only and within the limits of Client's instructions, if any. The Company's sole responsibility is to its Client and this document does not exonerate parties to a transaction from exercising all their rights and obligations under the transaction documents. This document cannot be reproduced except in full, without prior written approval of the Company. Any unauthorized alteration, forgery or falsification of the content or appearance of this document is unlawful and offenders may be prosecuted to the fullest extent of the law.

LTE BAND 4							
Channel bandwidth: 1.4MHz				Channel bandwidth: 3MHz			
Freq. (MHz)	CH	PAPR (dB)		Freq. (MHz)	CH	PAPR (dB)	
		64QAM	Limit			64QAM	Limit
1710.7	19957	6.75	13	1711.5	19965	6.51	13
1732.5	20175	6.85	13	1732.5	20175	6.63	13
1754.3	20393	6.70	13	1753.5	20385	6.61	13

LTE BAND 4							
Channel bandwidth: 5MHz				Channel bandwidth: 10MHz			
Freq. (MHz)	CH	PAPR (dB)		Freq. (MHz)	CH	PAPR (dB)	
		64QAM	Limit			64QAM	Limit
1712.5	19957	6.63	13	1715.0	20000	6.54	13
1732.5	20175	6.57	13	1732.5	20175	6.07	13
1752.5	20375	6.70	13	1750.0	20350	6.07	13

LTE BAND 4							
Channel bandwidth: 15MHz				Channel bandwidth: 20MHz			
Freq. (MHz)	CH	PAPR (dB)		Freq. (MHz)	CH	PAPR (dB)	
		64QAM	Limit			64QAM	Limit
1717.5	20025	6.18	13	1720.0	20050	6.74	13
1732.5	20175	6.17	13	1732.5	20175	6.88	13
1747.5	20325	6.25	13	1745.0	20300	6.95	13

Unless otherwise stated the results shown in this test report refer only to the sample(s) tested and such sample(s) are retained for 90 days only.

除非另有說明，此報告結果僅對測試之樣品負責，同時此樣品僅保留90天。本報告未經本公司書面許可，不可部份複製。

This document is issued by the Company subject to its General Conditions of Service printed overleaf, available on request or accessible at [www.sgs.com/terms\\_and\\_conditions.htm](http://www.sgs.com/terms_and_conditions.htm) and, for electronic format documents, subject to Terms and Conditions for Electronic Documents at [www.sgs.com/terms\\_e-document.htm](http://www.sgs.com/terms_e-document.htm). Attention is drawn to the limitation of liability, indemnification and jurisdiction issues defined therein. Any holder of this document is advised that information contained hereon reflects the Company's findings at the time of its intervention only and within the limits of Client's instructions, if any. The Company's sole responsibility is to its Client and this document does not exonerate parties to a transaction from exercising all their rights and obligations under the transaction documents. This document cannot be reproduced except in full, without prior written approval of the Company. Any unauthorized alteration, forgery or falsification of the content or appearance of this document is unlawful and offenders may be prosecuted to the fullest extent of the law.



LTE BAND 12							
Channel bandwidth: 1.4MHz				Channel bandwidth: 3MHz			
Freq. (MHz)	CH	PAPR (dB)		Freq. (MHz)	CH	PAPR (dB)	
		64QAM	Limit			64QAM	Limit
699.7	23017	6.90	13	700.5	23025	6.65	13
707.5	23095	6.73	13	707.5	23095	6.58	13
715.3	23173	6.70	13	714.5	23165	6.59	13

LTE BAND 12							
Channel bandwidth: 5MHz				Channel bandwidth: 10MHz			
Freq. (MHz)	CH	PAPR (dB)		Freq. (MHz)	CH	PAPR (dB)	
		64QAM	Limit			64QAM	Limit
701.5	23035	6.44	13	704.0	23060	6.07	13
707.5	23095	6.48	13	707.5	23095	6.57	13
713.5	23155	6.54	13	711.0	23130	6.60	13

LTE BAND 17							
Channel bandwidth: 5MHz				Channel bandwidth: 10MHz			
Freq. (MHz)	CH	PAPR (dB)		Freq. (MHz)	CH	PAPR (dB)	
		64QAM	Limit			64QAM	Limit
706.5	23755	6.64	13	709.0	23780	6.51	13
710.0	23790	6.57	13	710.0	23790	6.60	13
713.5	23825	6.54	13	711.0	23800	6.49	13

## Measurement Results:

Please refer to next page

Unless otherwise stated the results shown in this test report refer only to the sample(s) tested and such sample(s) are retained for 90 days only.

除非另有說明，此報告結果僅對測試之樣品負責，同時此樣品僅保留90天。本報告未經本公司書面許可，不可部份複製。

This document is issued by the Company subject to its General Conditions of Service printed overleaf, available on request or accessible at [www.sgs.com/terms\\_and\\_conditions.htm](http://www.sgs.com/terms_and_conditions.htm) and, for electronic format documents, subject to Terms and Conditions for Electronic Documents at [www.sgs.com/terms\\_e-document.htm](http://www.sgs.com/terms_e-document.htm). Attention is drawn to the limitation of liability, indemnification and jurisdiction issues defined therein. Any holder of this document is advised that information contained hereon reflects the Company's findings at the time of its intervention only and within the limits of Client's instructions, if any. The Company's sole responsibility is to its Client and this document does not exonerate parties to a transaction from exercising all their rights and obligations under the transaction documents. This document cannot be reproduced except in full, without prior written approval of the Company. Any unauthorized alteration, forgery or falsification of the content or appearance of this document is unlawful and offenders may be prosecuted to the fullest extent of the law.

SGS Taiwan Ltd.

No.134,WuKungRoad,NewTaipeiIndustrialPark,WukuDistrict,NewTaipeiCity,Taiwan24803/新北市五股區新北產業園區五工路 134 號

台灣檢驗科技股份有限公司

t (886-2) 2299-3279

f (886-2) 2298-0488

www.tw.sgs.com

Member of SGS Group

**GSM\_850MHz\_LowCH128-824.2**

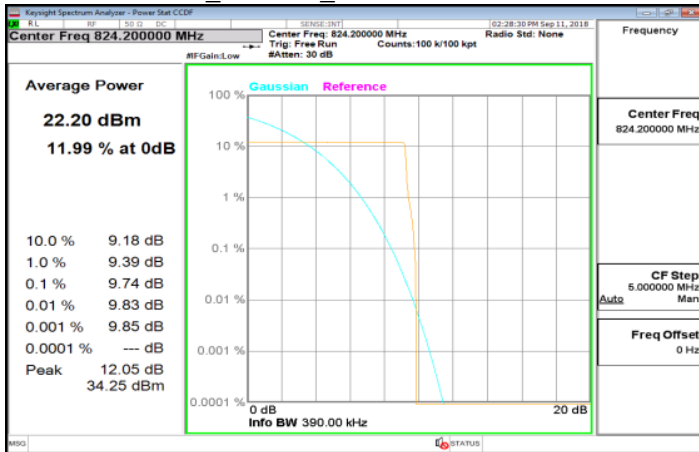

**GSM\_1900MHz\_LowCH512-1850.2**

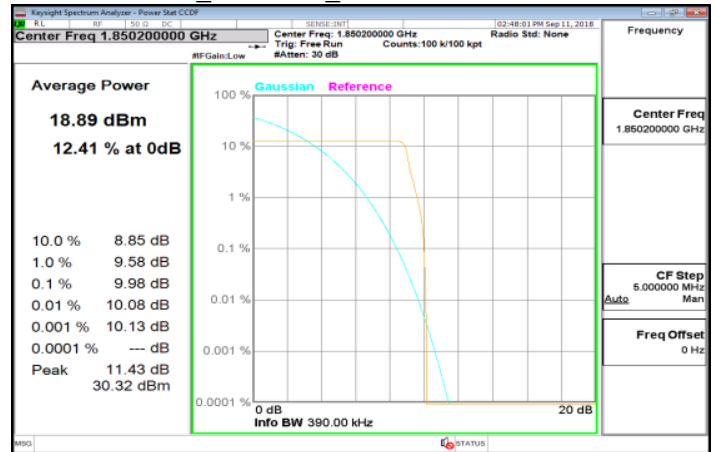

**GSM\_850MHz\_MidCH190-836.6**

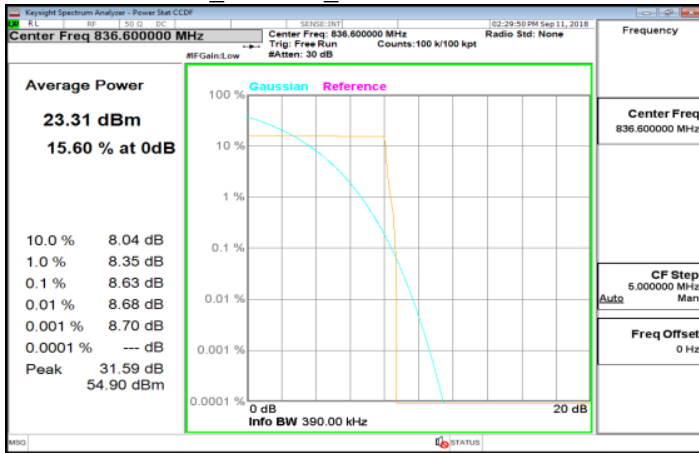

**GSM\_1900MHz\_MidCH661-1880**

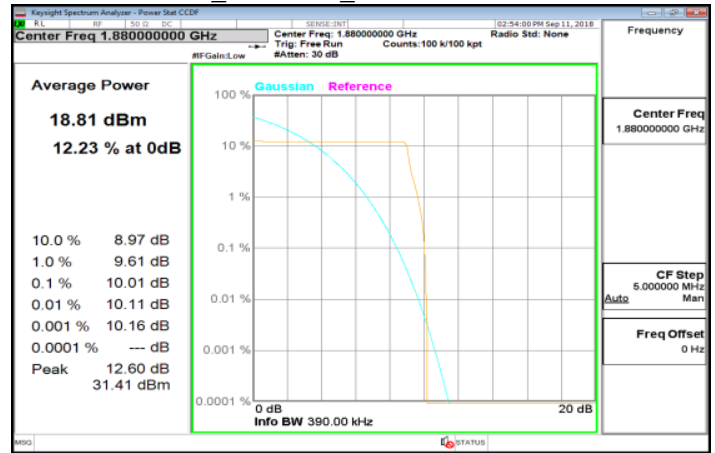

**GSM\_850MHz\_HighCH251-848.8**

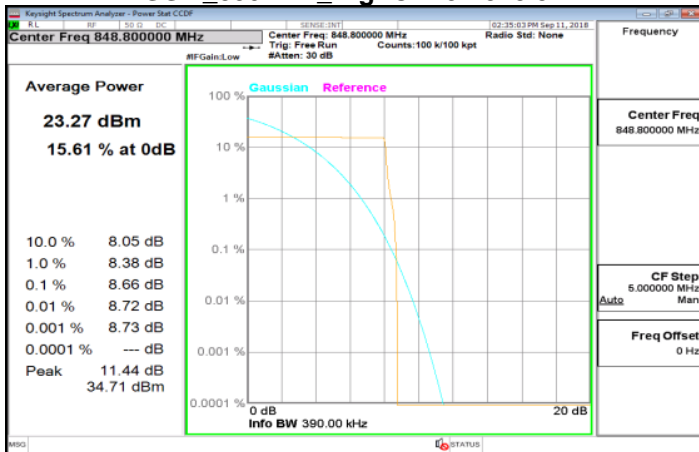

**GSM\_1900MHz\_HighCH810-1909.8**

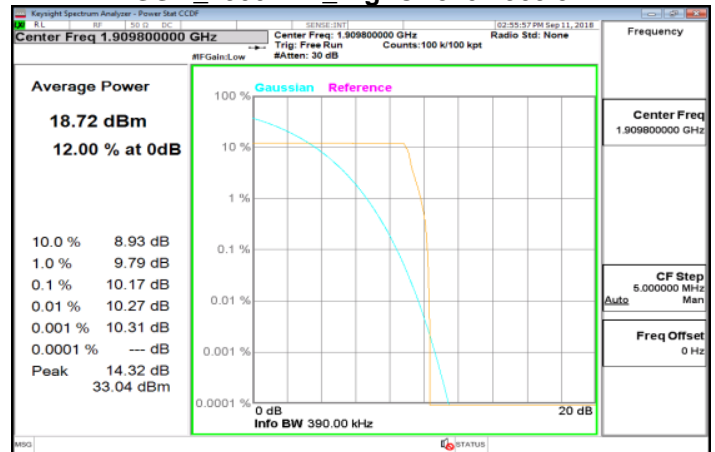

Unless otherwise stated the results shown in this test report refer only to the sample(s) tested and such sample(s) are retained for 90 days only.

除非另有說明，此報告結果僅對測試之樣品負責，同時此樣品僅保留90天。本報告未經本公司書面許可，不可部份複製。

This document is issued by the Company subject to its General Conditions of Service printed overleaf, available on request or accessible at [www.sgs.com/terms\\_and\\_conditions.htm](http://www.sgs.com/terms_and_conditions.htm) and, for electronic format documents, subject to Terms and Conditions for Electronic Documents at [www.sgs.com/terms\\_e-document.htm](http://www.sgs.com/terms_e-document.htm). Attention is drawn to the limitation of liability, indemnification and jurisdiction issues defined therein. Any holder of this document is advised that information contained hereon reflects the Company's findings at the time of its intervention only and within the limits of Client's instructions, if any. The Company's sole responsibility is to its Client and this document does not exonerate parties to a transaction from exercising all their rights and obligations under the transaction documents. This document cannot be reproduced except in full, without prior written approval of the Company. Any unauthorized alteration, forgery or falsification of the content or appearance of this document is unlawful and offenders may be prosecuted to the fullest extent of the law.

SGS Taiwan Ltd.

No. 134, WuKungRoad, NewTaipeiIndustrialPark, WuKuDistrict, NewTaipeiCity, Taiwan24803/新北市五股區新北產業園區五工路 134 號

台灣檢驗科技股份有限公司

t (886-2) 2299-3279

f (886-2) 2298-0488

www.tw.sgs.com

Member of SGS Group

**GPRS\_850MHz\_LowCH128-824.2**

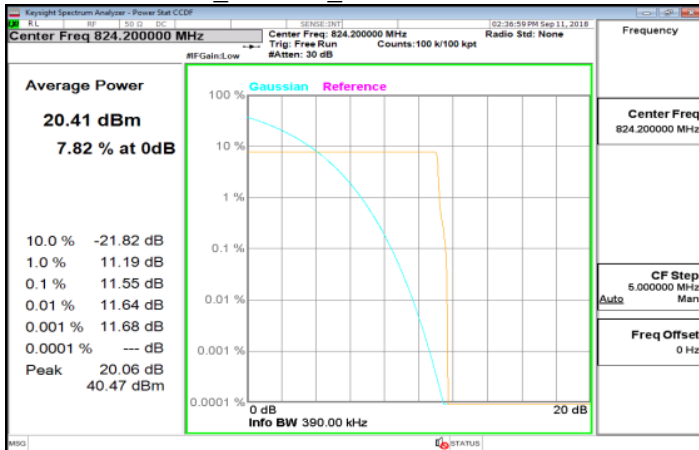

**GPRS\_1900MHz\_LowCH512-1850.2**

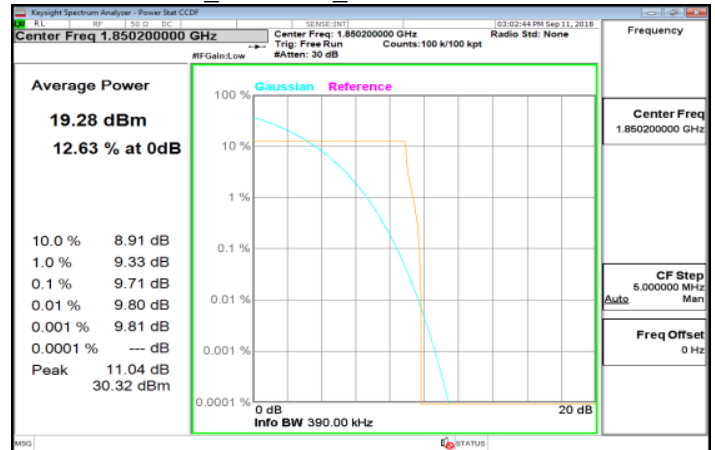

**GPRS\_850MHz\_MidCH190-836.6**



**GPRS\_1900MHz\_MidCH661-1880**

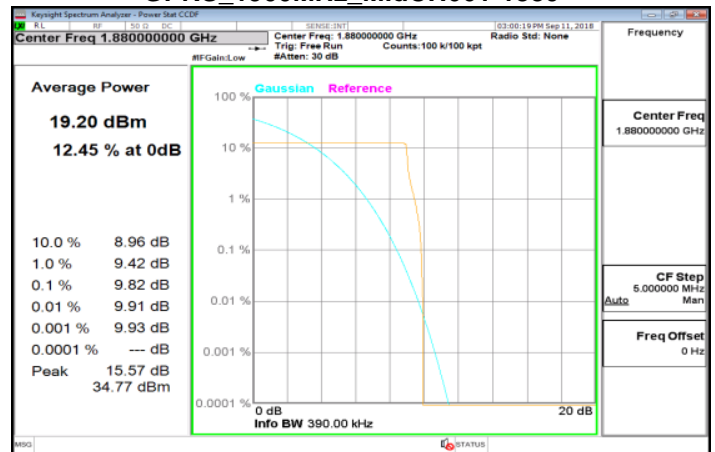

**GPRS\_850MHz\_HighCH251-848.8**

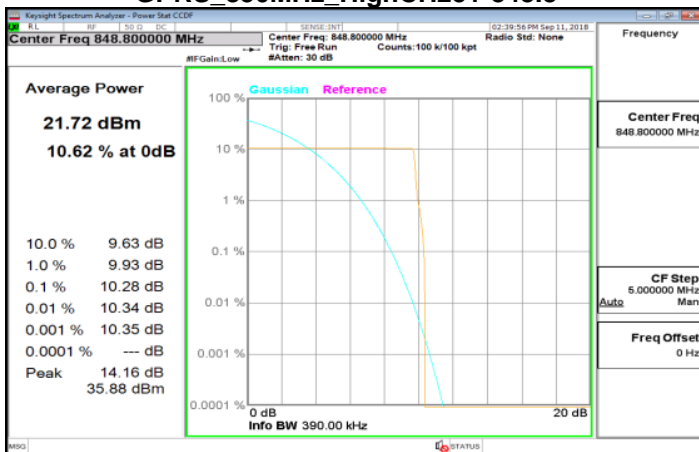

**GPRS\_1900MHz\_HighCH810-1909.8**

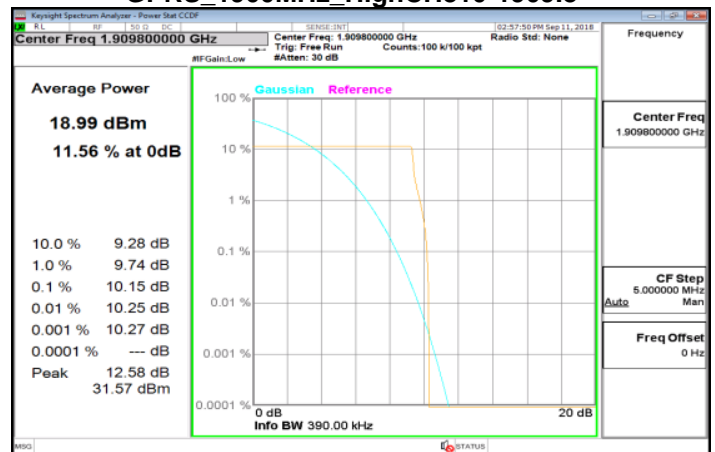

Unless otherwise stated the results shown in this test report refer only to the sample(s) tested and such sample(s) are retained for 90 days only.

除非另有說明，此報告結果僅對測試之樣品負責，同時此樣品僅保留90天。本報告未經本公司書面許可，不可部份複製。

This document is issued by the Company subject to its General Conditions of Service printed overleaf, available on request or accessible at [www.sgs.com/terms\\_and\\_conditions.htm](http://www.sgs.com/terms_and_conditions.htm) and, for electronic format documents, subject to Terms and Conditions for Electronic Documents at [www.sgs.com/terms\\_e-document.htm](http://www.sgs.com/terms_e-document.htm). Attention is drawn to the limitation of liability, indemnification and jurisdiction issues defined therein. Any holder of this document is advised that information contained hereon reflects the Company's findings at the time of its intervention only and within the limits of Client's instructions, if any. The Company's sole responsibility is to its Client and this document does not exonerate parties to a transaction from exercising all their rights and obligations under the transaction documents. This document cannot be reproduced except in full, without prior written approval of the Company. Any unauthorized alteration, forgery or falsification of the content or appearance of this document is unlawful and offenders may be prosecuted to the fullest extent of the law.

**WCDMA\_B2\_LowCH9262-1852.4**

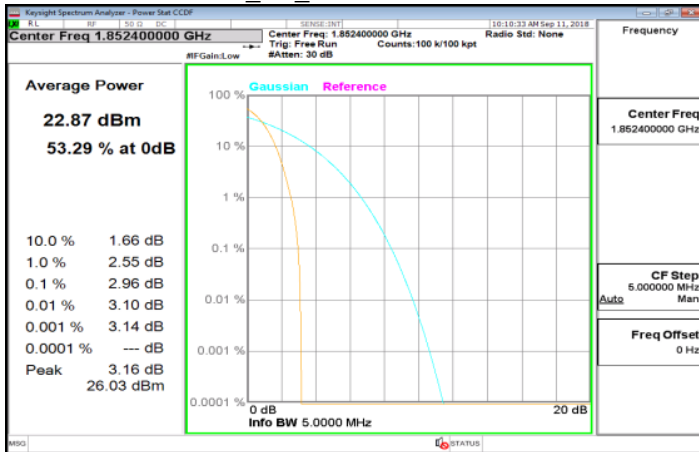

**HSDPA\_B2\_LowCH9262-1852.4**

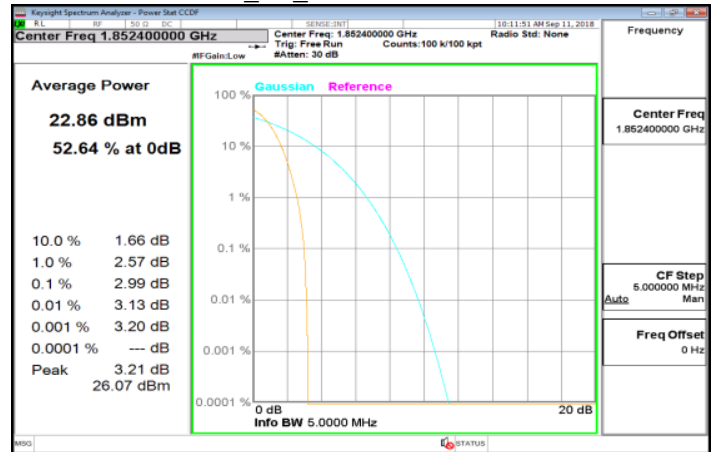

**WCDMA\_B2\_MidCH9400-1880**

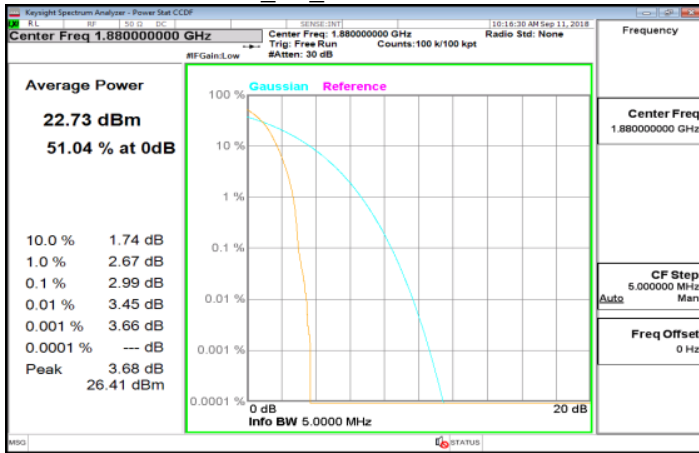

**HSDPA\_B2\_MidCH9400-1880**

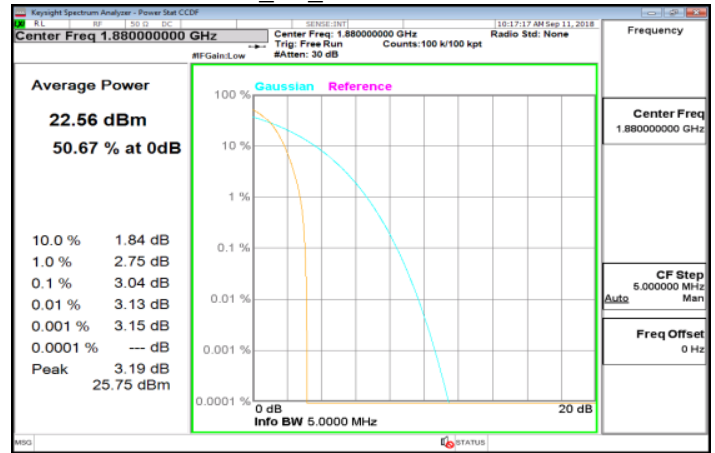

**WCDMA\_B2\_HighCH9538-1907.6**

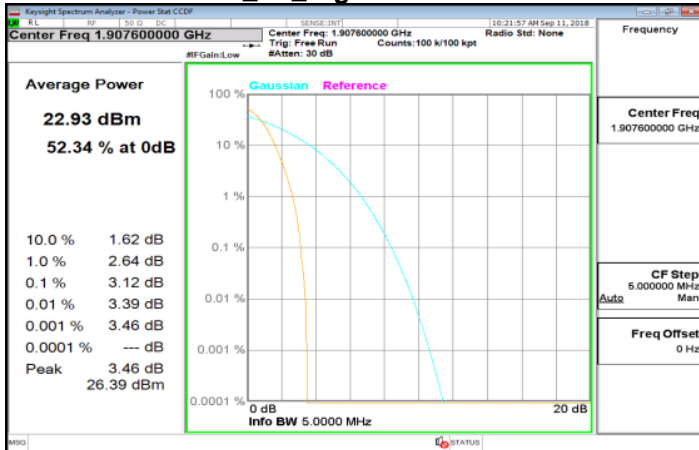

**HSDPA\_B2\_HighCH9538-1907.6**

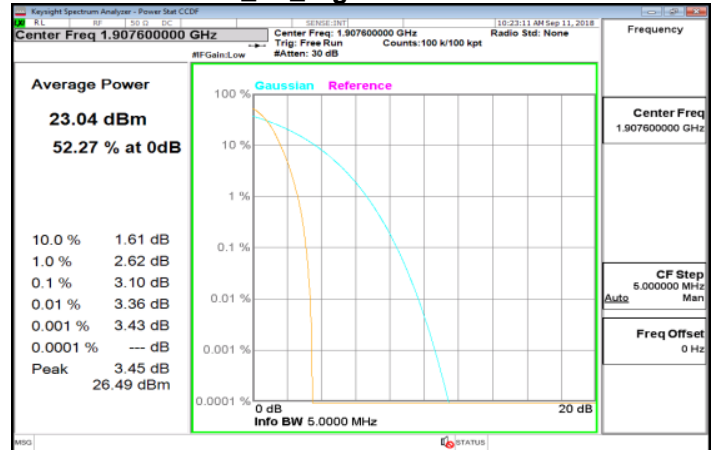

Unless otherwise stated the results shown in this test report refer only to the sample(s) tested and such sample(s) are retained for 90 days only.

除非另有說明，此報告結果僅對測試之樣品負責，同時此樣品僅保留90天。本報告未經本公司書面許可，不可部份複製。

This document is issued by the Company subject to its General Conditions of Service printed overleaf, available on request or accessible at [www.sgs.com/terms\\_and\\_conditions.htm](http://www.sgs.com/terms_and_conditions.htm) and, for electronic format documents, subject to Terms and Conditions for Electronic Documents at [www.sgs.com/terms\\_e-document.htm](http://www.sgs.com/terms_e-document.htm). Attention is drawn to the limitation of liability, indemnification and jurisdiction issues defined therein. Any holder of this document is advised that information contained hereon reflects the Company's findings at the time of its intervention only and within the limits of Client's instructions, if any. The Company's sole responsibility is to its Client and this document does not exonerate parties to a transaction from exercising all their rights and obligations under the transaction documents. This document cannot be reproduced except in full, without prior written approval of the Company. Any unauthorized alteration, forgery or falsification of the content or appearance of this document is unlawful and offenders may be prosecuted to the fullest extent of the law.

**HSUPA\_B2\_LowCH9262-1852.4**

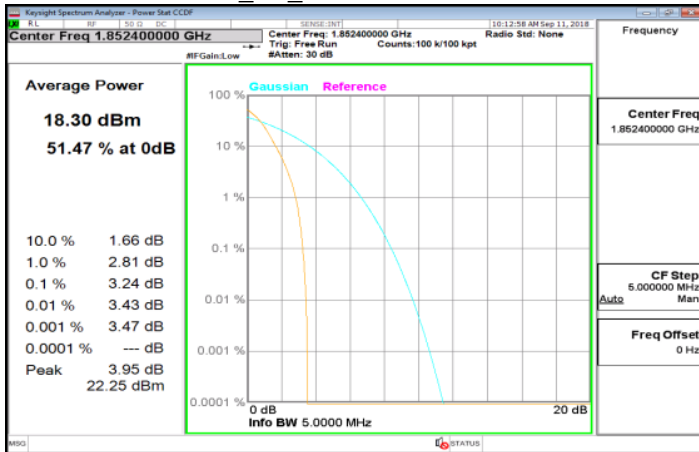

**WCDMA\_B4\_LowCH1312-1712.4**

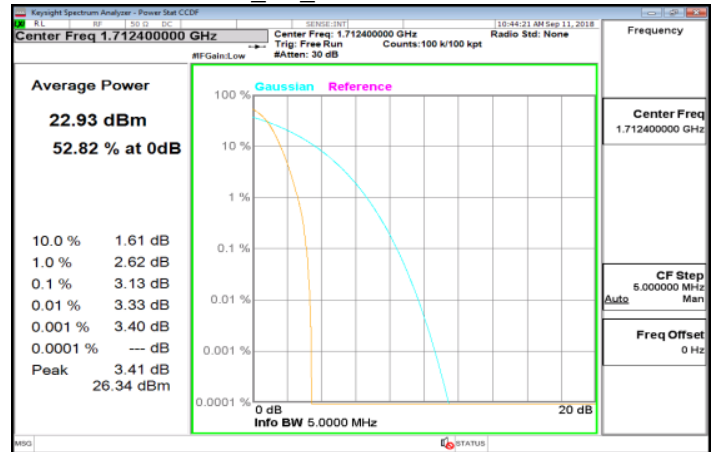

**HSUPA\_B2\_MidCH9400-1880**

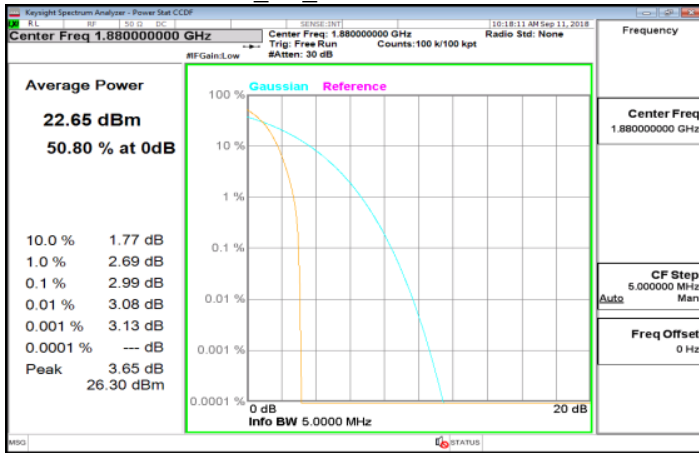

**WCDMA\_B4\_MidCH1413-1732.6**

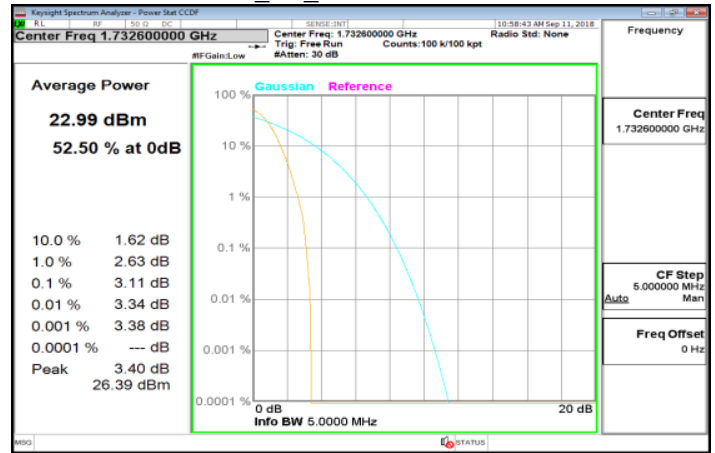

**HSUPA\_B2\_HighCH9538-1907.6**

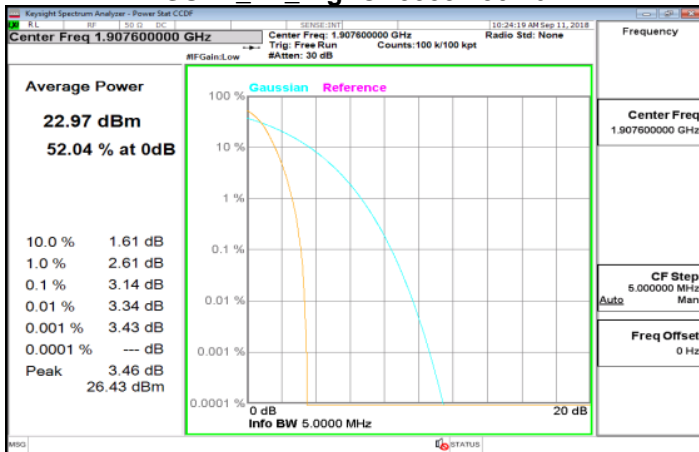

**WCDMA\_B4\_HighCH1513-1752.6**

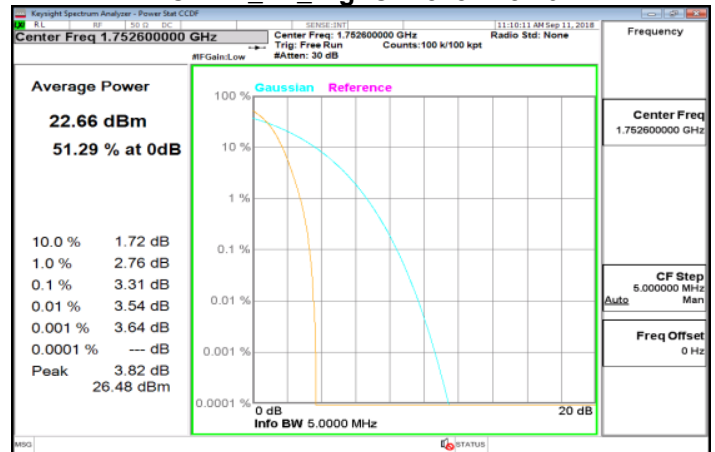

Unless otherwise stated the results shown in this test report refer only to the sample(s) tested and such sample(s) are retained for 90 days only.

除非另有說明，此報告結果僅對測試之樣品負責，同時此樣品僅保留90天。本報告未經本公司書面許可，不可部份複製。

This document is issued by the Company subject to its General Conditions of Service printed overleaf, available on request or accessible at [www.sgs.com/terms\\_and\\_conditions.htm](http://www.sgs.com/terms_and_conditions.htm) and, for electronic format documents, subject to Terms and Conditions for Electronic Documents at [www.sgs.com/terms\\_e-document.htm](http://www.sgs.com/terms_e-document.htm). Attention is drawn to the limitation of liability, indemnification and jurisdiction issues defined therein. Any holder of this document is advised that information contained hereon reflects the Company's findings at the time of its intervention only and within the limits of Client's instructions, if any. The Company's sole responsibility is to its Client and this document does not exonerate parties to a transaction from exercising all their rights and obligations under the transaction documents. This document cannot be reproduced except in full, without prior written approval of the Company. Any unauthorized alteration, forgery or falsification of the content or appearance of this document is unlawful and offenders may be prosecuted to the fullest extent of the law.

### HSDPA\_B4\_LowCH1312-1712.4

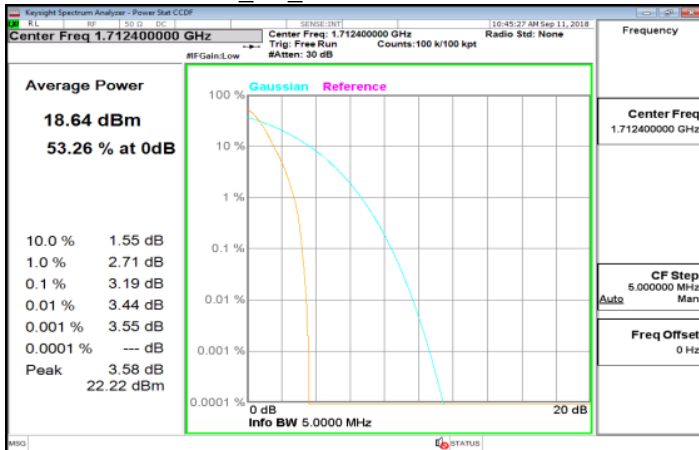

### HSUPA\_B4\_LowCH1312-1712.4

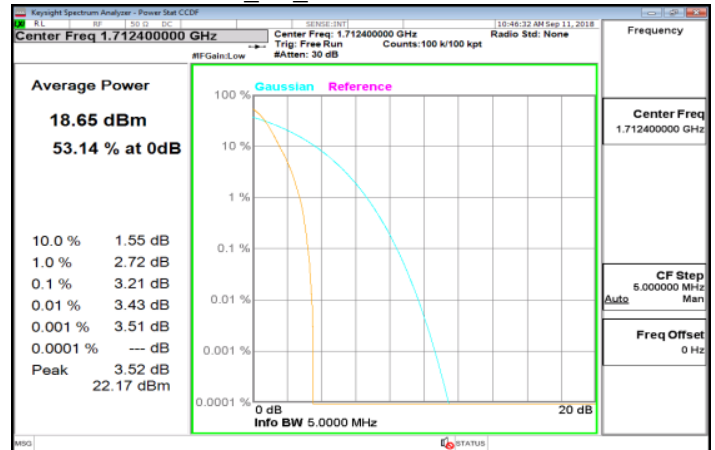

### HSDPA\_B4\_MidCH1413-1732.6

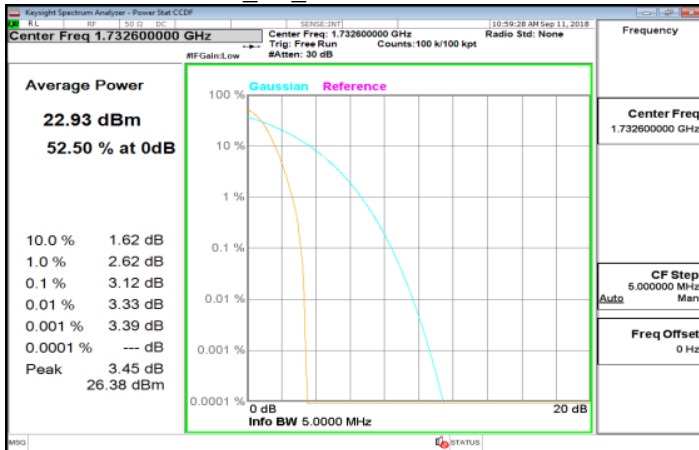

### HSUPA\_B4\_MidCH1413-1732.6

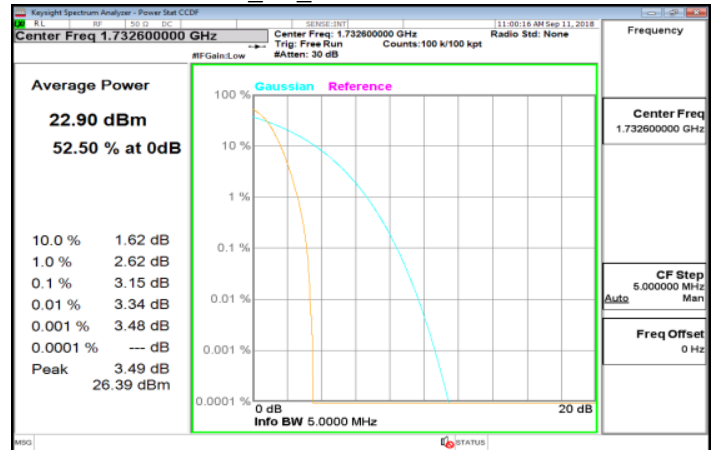

### HSDPA\_B4\_HighCH1513-1752.6

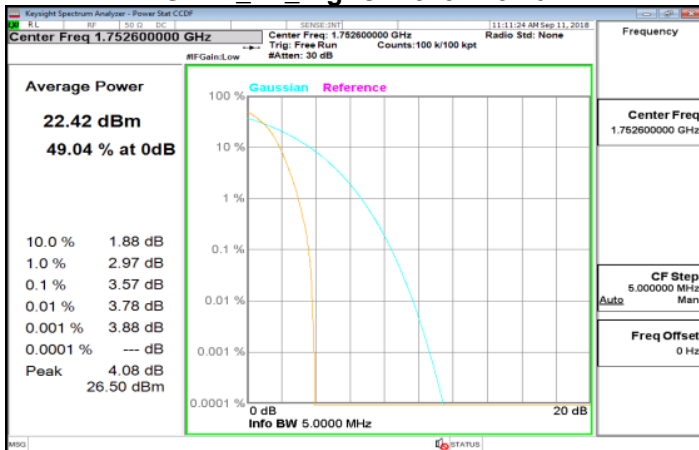

### HSUPA\_B4\_HighCH1513-1752.6

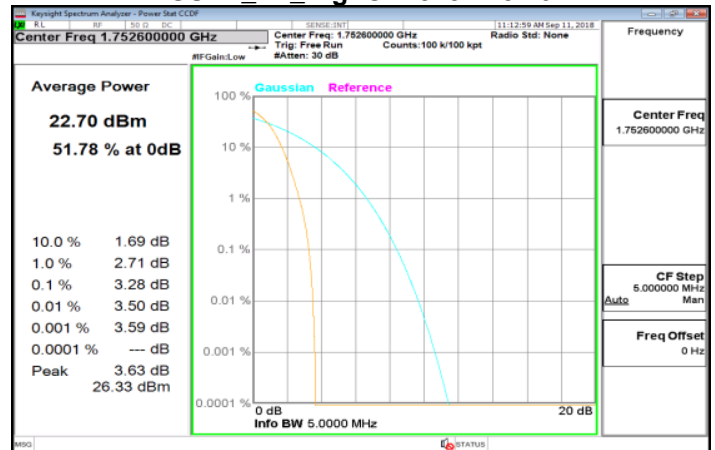

Unless otherwise stated the results shown in this test report refer only to the sample(s) tested and such sample(s) are retained for 90 days only.

除非另有說明，此報告結果僅對測試之樣品負責，同時此樣品僅保留90天。本報告未經本公司書面許可，不可部份複製。

This document is issued by the Company subject to its General Conditions of Service printed overleaf, available on request or accessible at [www.sgs.com/terms\\_and\\_conditions.htm](http://www.sgs.com/terms_and_conditions.htm) and, for electronic format documents, subject to Terms and Conditions for Electronic Documents at [www.sgs.com/terms\\_e-document.htm](http://www.sgs.com/terms_e-document.htm). Attention is drawn to the limitation of liability, indemnification and jurisdiction issues defined therein. Any holder of this document is advised that information contained hereon reflects the Company's findings at the time of its intervention only and within the limits of Client's instructions, if any. The Company's sole responsibility is to its Client and this document does not exonerate parties to a transaction from exercising all their rights and obligations under the transaction documents. This document cannot be reproduced except in full, without prior written approval of the Company. Any unauthorized alteration, forgery or falsification of the content or appearance of this document is unlawful and offenders may be prosecuted to the fullest extent of the law.

LTE\_Band2\_1\_4MHz\_16QAM\_6\_0\_LowCH18607-1850.7

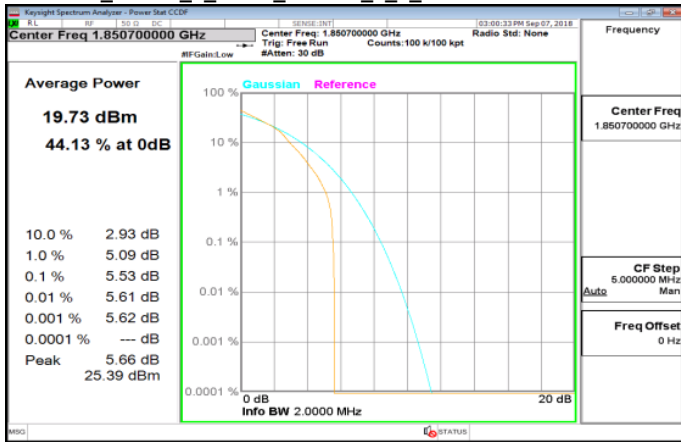

LTE\_Band2\_1\_4MHz\_64QAM\_6\_0\_MidCH18900-1880

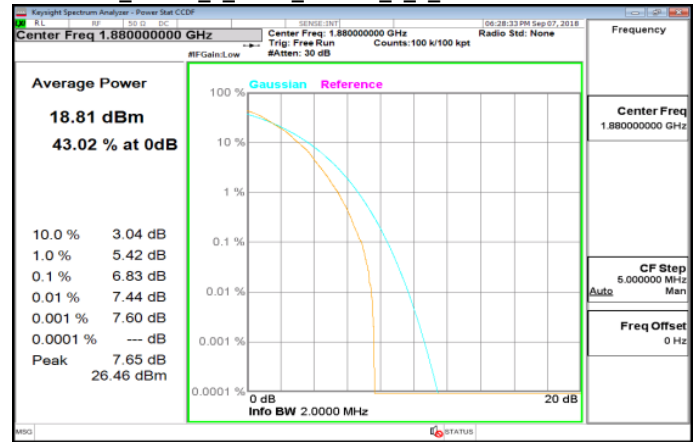

LTE\_Band2\_1\_4MHz\_64QAM\_6\_0\_LowCH18607-1850.7

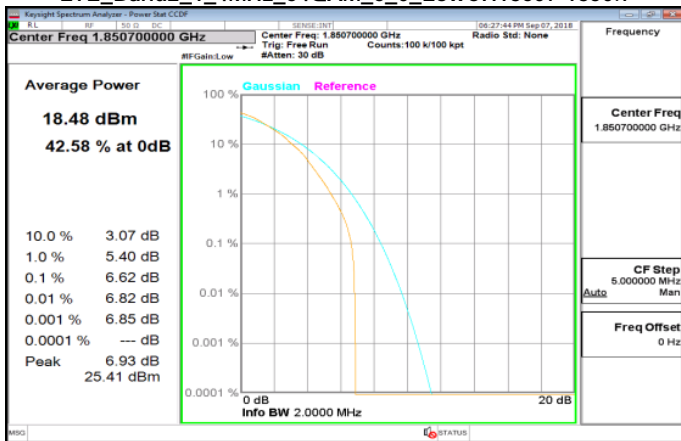

LTE\_Band2\_1\_4MHz\_16QAM\_6\_0\_HighCH19193-1909.3

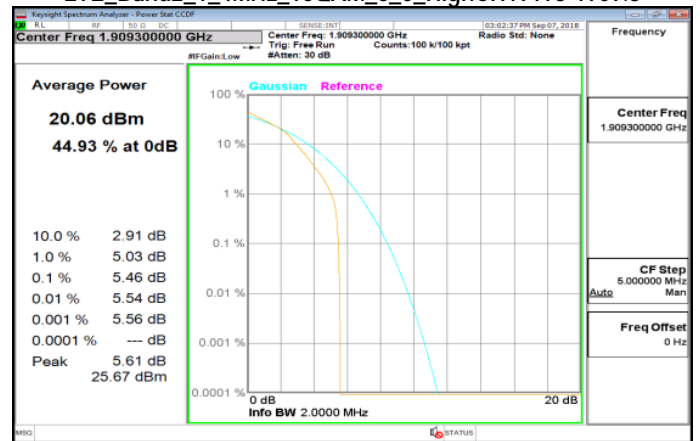

LTE\_Band2\_1\_4MHz\_16QAM\_6\_0\_MidCH18900-1880

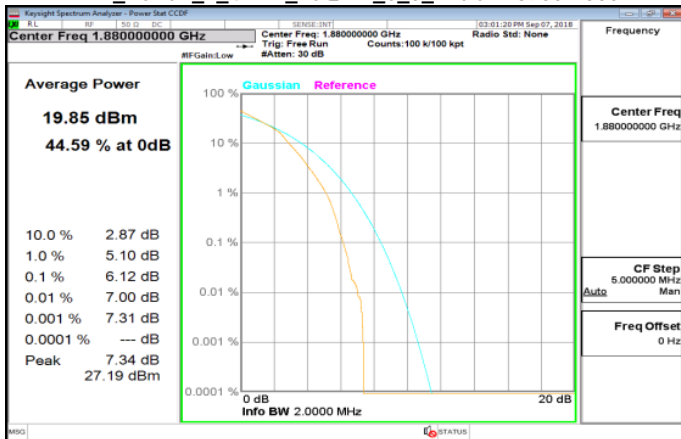

LTE\_Band2\_1\_4MHz\_64QAM\_6\_0\_HighCH19193-1909.3

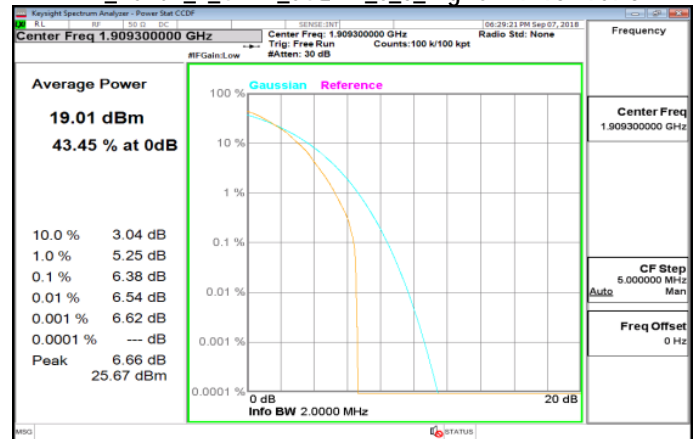

Unless otherwise stated the results shown in this test report refer only to the sample(s) tested and such sample(s) are retained for 90 days only.

除非另有說明，此報告結果僅對測試之樣品負責，同時此樣品僅保留90天。本報告未經本公司書面許可，不可部份複製。

This document is issued by the Company subject to its General Conditions of Service printed overleaf, available on request or accessible at [www.sgs.com/terms\\_and\\_conditions.htm](http://www.sgs.com/terms_and_conditions.htm) and, for electronic format documents, subject to Terms and Conditions for Electronic Documents at [www.sgs.com/terms\\_e-document.htm](http://www.sgs.com/terms_e-document.htm). Attention is drawn to the limitation of liability, indemnification and jurisdiction issues defined therein. Any holder of this document is advised that information contained hereon reflects the Company's findings at the time of its intervention only and within the limits of Client's instructions, if any. The Company's sole responsibility is to its Client and this document does not exonerate parties to a transaction from exercising all their rights and obligations under the transaction documents. This document cannot be reproduced except in full, without prior written approval of the Company. Any unauthorized alteration, forgery or falsification of the content or appearance of this document is unlawful and offenders may be prosecuted to the fullest extent of the law.

SGS Taiwan Ltd.

No. 134, WuKungRoad, NewTaipeiIndustrialPark, WukuDistrict, NewTaipeiCity, Taiwan24803/新北市五股區新北產業園區五工路 134 號

台灣檢驗科技股份有限公司

t (886-2) 2299-3279

f (886-2) 2298-0488

www.tw.sgs.com

Member of SGS Group

LTE\_Band2\_3MHz\_16QAM\_15\_0\_LowCH18615-1851.5

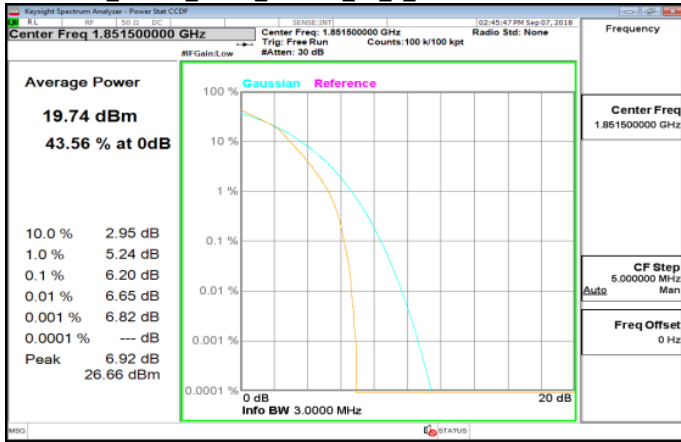

LTE\_Band2\_3MHz\_64QAM\_15\_0\_MidCH18900-1880

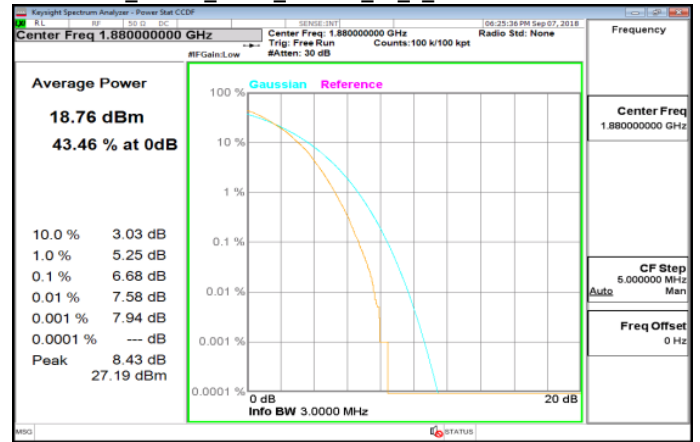

LTE\_Band2\_3MHz\_64QAM\_15\_0\_LowCH18615-1851.5

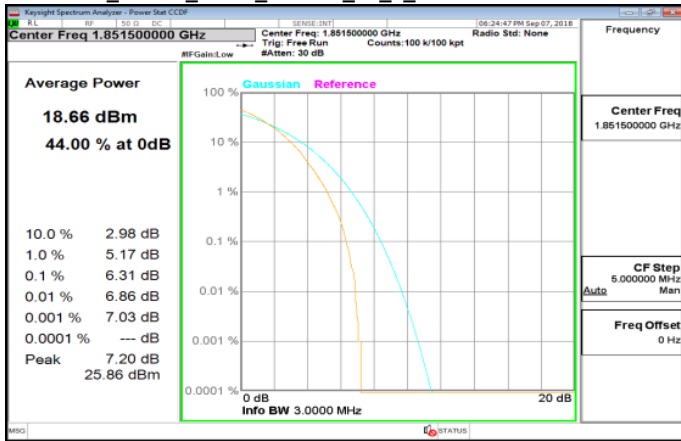

LTE\_Band2\_3MHz\_16QAM\_15\_0\_HighCH19185-1908.5

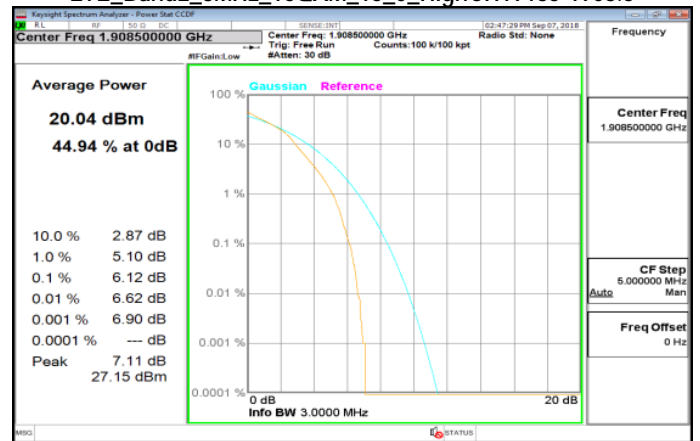

LTE\_Band2\_3MHz\_16QAM\_15\_0\_MidCH18900-1880

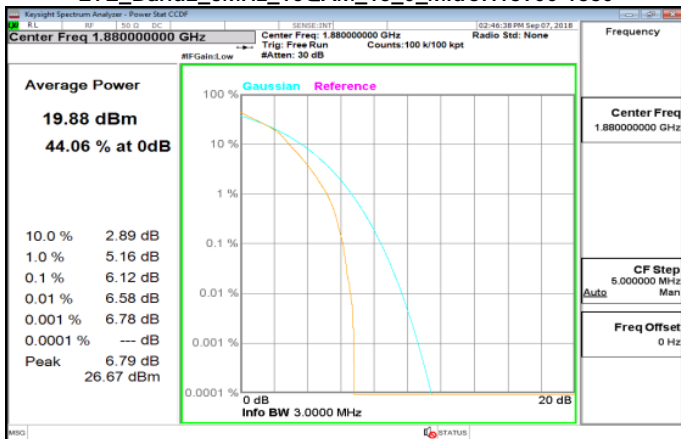

LTE\_Band2\_3MHz\_64QAM\_15\_0\_HighCH19185-1908.5

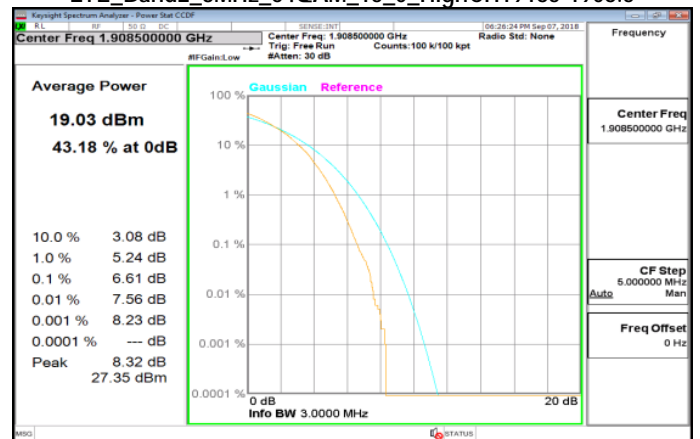

Unless otherwise stated the results shown in this test report refer only to the sample(s) tested and such sample(s) are retained for 90 days only.

除非另有說明，此報告結果僅對測試之樣品負責，同時此樣品僅保留90天。本報告未經本公司書面許可，不可部份複製。

This document is issued by the Company subject to its General Conditions of Service printed overleaf, available on request or accessible at [www.sgs.com/terms\\_and\\_conditions.htm](http://www.sgs.com/terms_and_conditions.htm) and, for electronic format documents, subject to Terms and Conditions for Electronic Documents at [www.sgs.com/terms\\_e-document.htm](http://www.sgs.com/terms_e-document.htm). Attention is drawn to the limitation of liability, indemnification and jurisdiction issues defined therein. Any holder of this document is advised that information contained hereon reflects the Company's findings at the time of its intervention only and within the limits of Client's instructions, if any. The Company's sole responsibility is to its Client and this document does not exonerate parties to a transaction from exercising all their rights and obligations under the transaction documents. This document cannot be reproduced except in full, without prior written approval of the Company. Any unauthorized alteration, forgery or falsification of the content or appearance of this document is unlawful and offenders may be prosecuted to the fullest extent of the law.

SGS Taiwan Ltd.

No. 134, WuKungRoad, NewTaipeiIndustrialPark, WukuDistrict, NewTaipeiCity, Taiwan24803/新北市五股區新北產業園區五工路 134 號

台灣檢驗科技股份有限公司

t (886-2) 2299-3279

f (886-2) 2298-0488

www.tw.sgs.com

Member of SGS Group



LTE\_Band2\_5MHz\_16QAM\_25\_0\_LowCH18625-1852.5

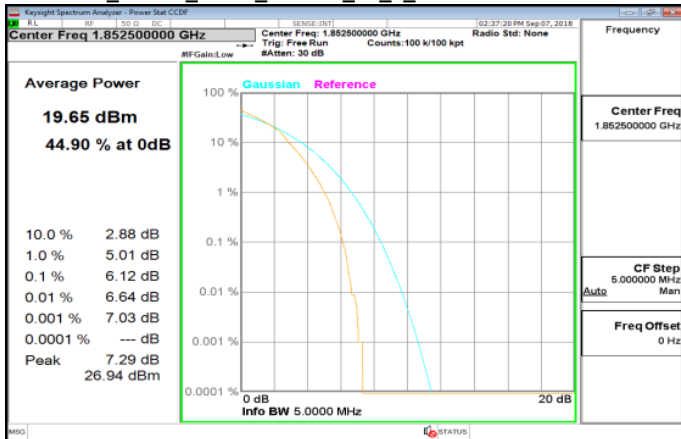

LTE\_Band2\_5MHz\_64QAM\_25\_0\_MidCH18900-1880

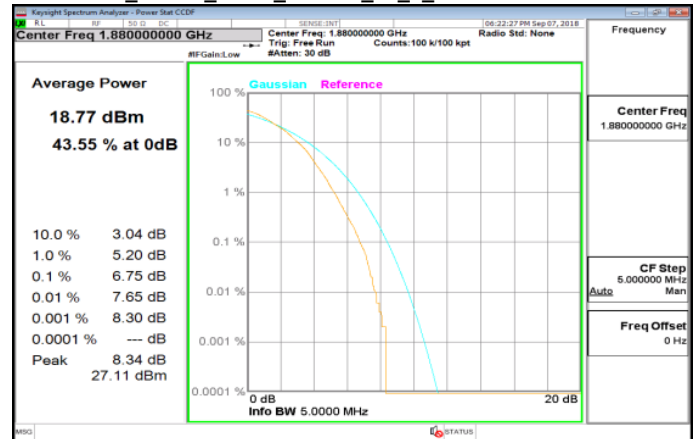

LTE\_Band2\_5MHz\_64QAM\_25\_0\_LowCH18625-1852.5

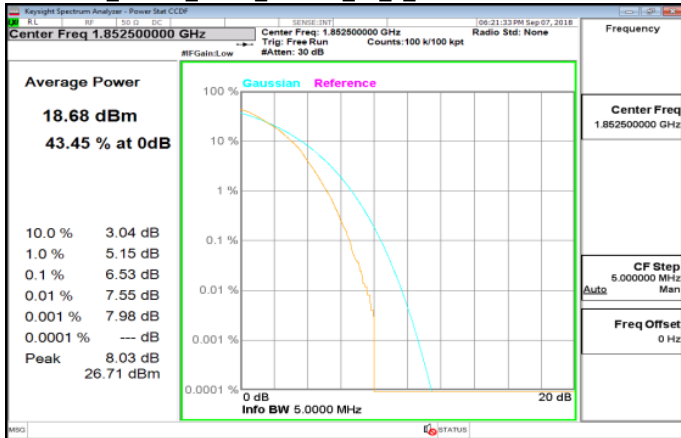

LTE\_Band2\_5MHz\_16QAM\_25\_0\_HighCH19175-1907.5

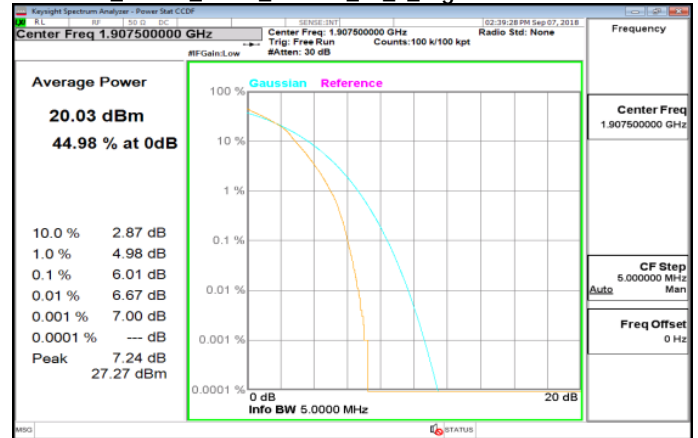

LTE\_Band2\_5MHz\_16QAM\_25\_0\_MidCH18900-1880

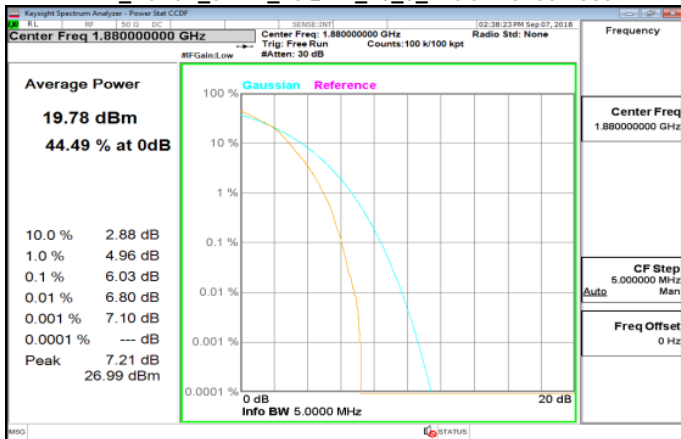

LTE\_Band2\_5MHz\_64QAM\_25\_0\_HighCH19175-1907.5

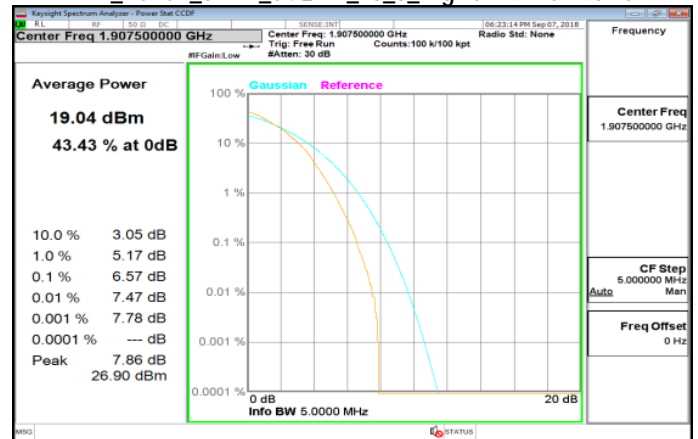

Unless otherwise stated the results shown in this test report refer only to the sample(s) tested and such sample(s) are retained for 90 days only.

除非另有說明，此報告結果僅對測試之樣品負責，同時此樣品僅保留90天。本報告未經本公司書面許可，不可部份複製。

This document is issued by the Company subject to its General Conditions of Service printed overleaf, available on request or accessible at [www.sgs.com/terms\\_and\\_conditions.htm](http://www.sgs.com/terms_and_conditions.htm) and, for electronic format documents, subject to Terms and Conditions for Electronic Documents at [www.sgs.com/terms\\_e-document.htm](http://www.sgs.com/terms_e-document.htm). Attention is drawn to the limitation of liability, indemnification and jurisdiction issues defined therein. Any holder of this document is advised that information contained hereon reflects the Company's findings at the time of its intervention only and within the limits of Client's instructions, if any. The Company's sole responsibility is to its Client and this document does not exonerate parties to a transaction from exercising all their rights and obligations under the transaction documents. This document cannot be reproduced except in full, without prior written approval of the Company. Any unauthorized alteration, forgery or falsification of the content or appearance of this document is unlawful and offenders may be prosecuted to the fullest extent of the law.

LTE\_Band2\_10MHz\_16QAM\_50\_0\_LowCH18650-1855

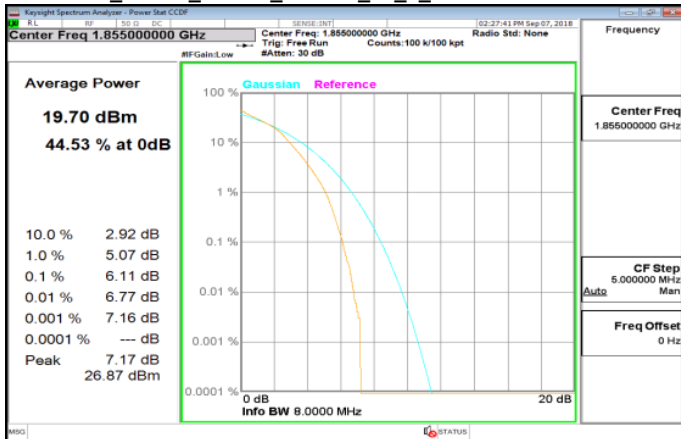

LTE\_Band2\_10MHz\_64QAM\_50\_0\_MidCH18900-1880

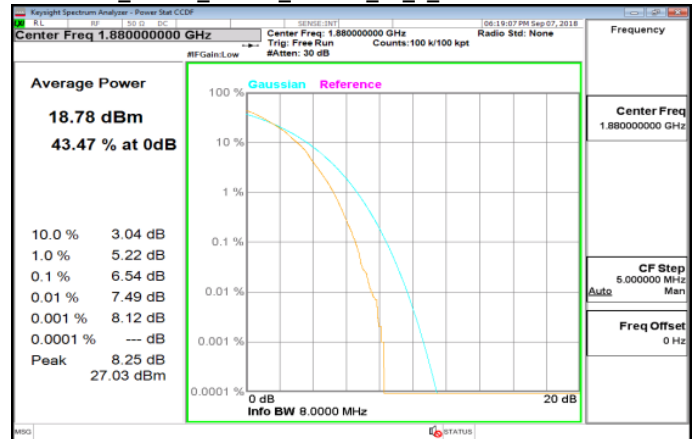

LTE\_Band2\_10MHz\_64QAM\_50\_0\_LowCH18650-1855

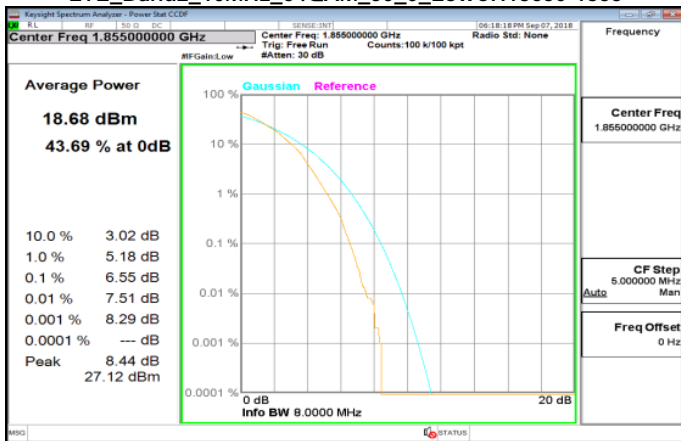

LTE\_Band2\_10MHz\_16QAM\_50\_0\_HighCH19150-1905

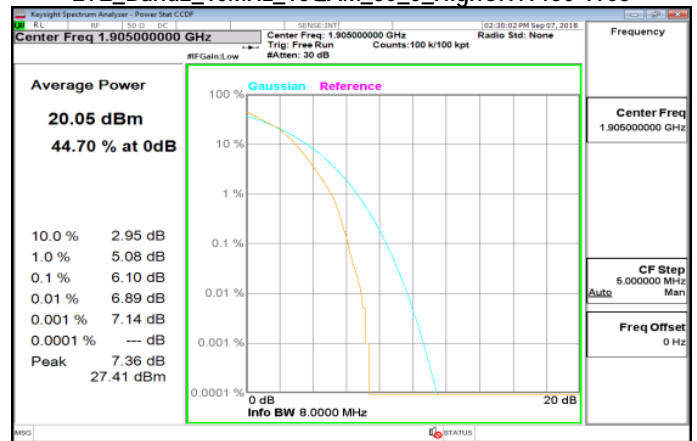

LTE\_Band2\_10MHz\_16QAM\_50\_0\_MidCH18900-1880

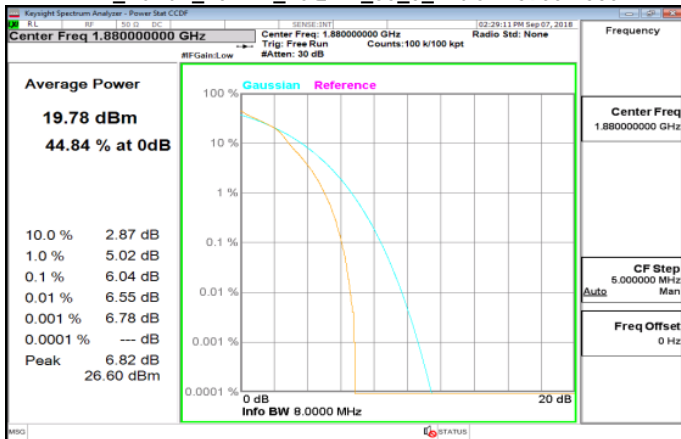

LTE\_Band2\_10MHz\_64QAM\_50\_0\_HighCH19150-1905

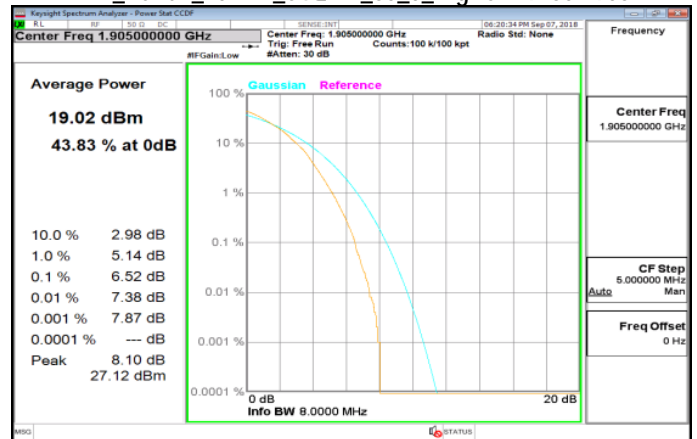

Unless otherwise stated the results shown in this test report refer only to the sample(s) tested and such sample(s) are retained for 90 days only.

除非另有說明，此報告結果僅對測試之樣品負責，同時此樣品僅保留90天。本報告未經本公司書面許可，不可部份複製。

This document is issued by the Company subject to its General Conditions of Service printed overleaf, available on request or accessible at [www.sgs.com/terms\\_and\\_conditions.htm](http://www.sgs.com/terms_and_conditions.htm) and, for electronic format documents, subject to Terms and Conditions for Electronic Documents at [www.sgs.com/terms\\_e-document.htm](http://www.sgs.com/terms_e-document.htm). Attention is drawn to the limitation of liability, indemnification and jurisdiction issues defined therein. Any holder of this document is advised that information contained hereon reflects the Company's findings at the time of its intervention only and within the limits of Client's instructions, if any. The Company's sole responsibility is to its Client and this document does not exonerate parties to a transaction from exercising all their rights and obligations under the transaction documents. This document cannot be reproduced except in full, without prior written approval of the Company. Any unauthorized alteration, forgery or falsification of the content or appearance of this document is unlawful and offenders may be prosecuted to the fullest extent of the law.

LTE\_Band2\_15MHz\_16QAM\_75\_0\_LowCH18675-1857.5

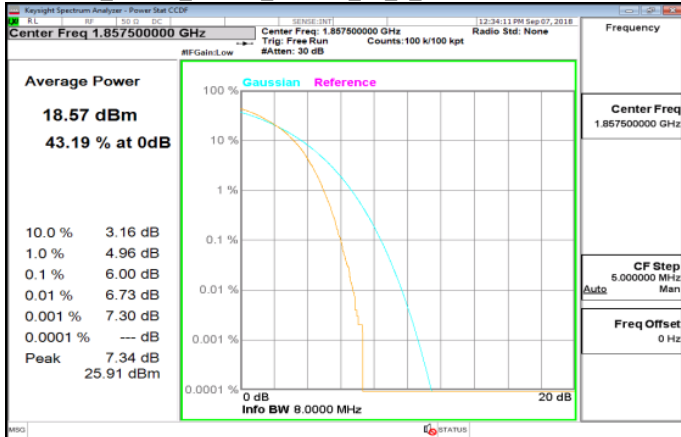

LTE\_Band2\_15MHz\_64QAM\_75\_0\_MidCH18900-1880

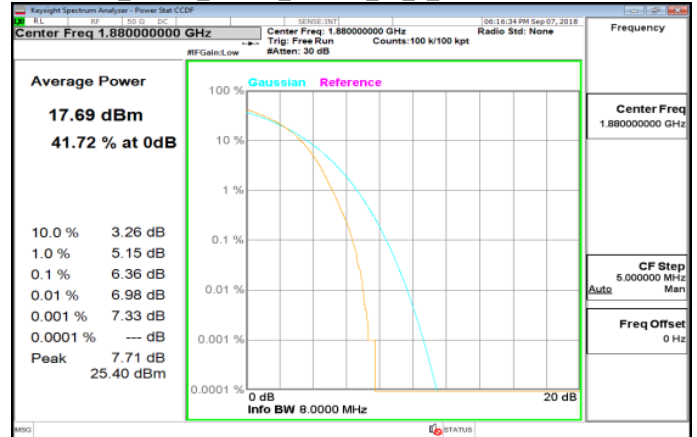

LTE\_Band2\_15MHz\_64QAM\_75\_0\_LowCH18675-1857.5

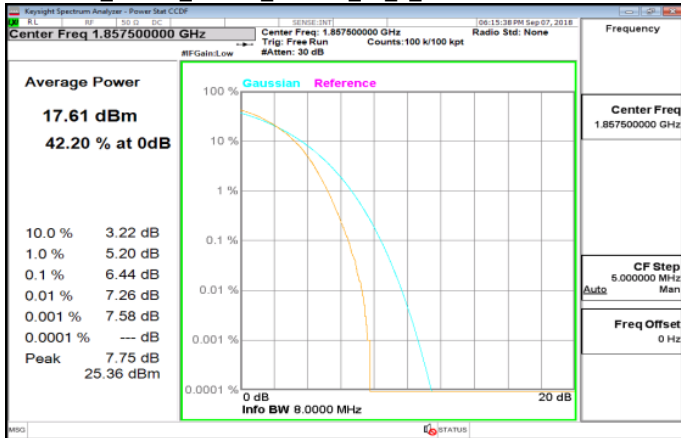

LTE\_Band2\_15MHz\_16QAM\_75\_0\_HighCH19125-1902.5

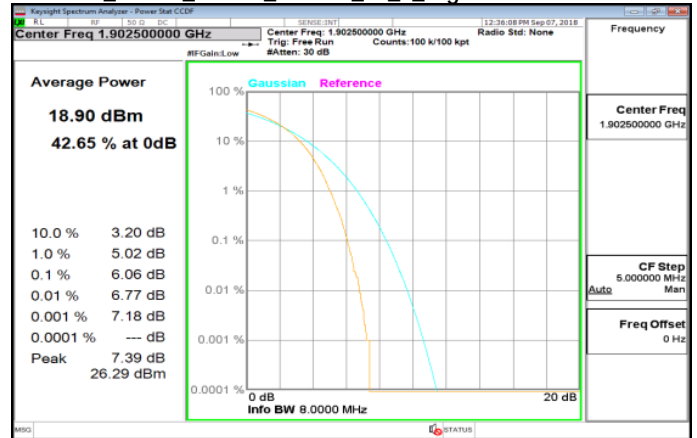

LTE\_Band2\_15MHz\_16QAM\_75\_0\_MidCH18900-1880

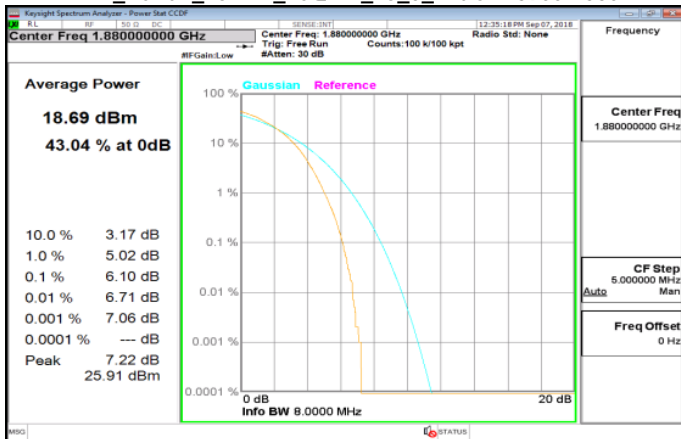

LTE\_Band2\_15MHz\_64QAM\_75\_0\_HighCH19125-1902.5

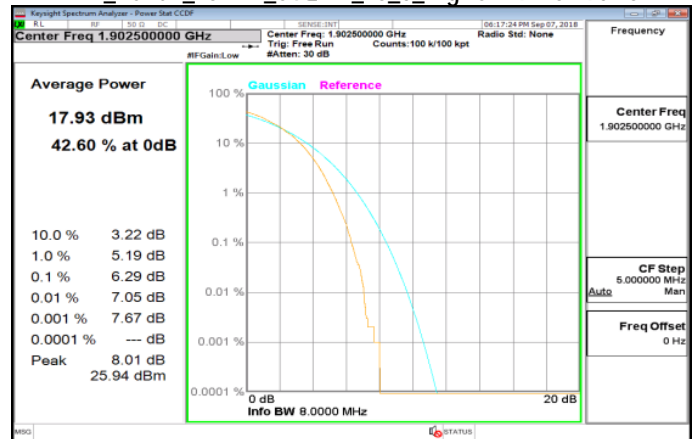

Unless otherwise stated the results shown in this test report refer only to the sample(s) tested and such sample(s) are retained for 90 days only.

除非另有說明，此報告結果僅對測試之樣品負責，同時此樣品僅保留90天。本報告未經本公司書面許可，不可部份複製。

This document is issued by the Company subject to its General Conditions of Service printed overleaf, available on request or accessible at [www.sgs.com/terms\\_and\\_conditions.htm](http://www.sgs.com/terms_and_conditions.htm) and, for electronic format documents, subject to Terms and Conditions for Electronic Documents at [www.sgs.com/terms\\_e-document.htm](http://www.sgs.com/terms_e-document.htm). Attention is drawn to the limitation of liability, indemnification and jurisdiction issues defined therein. Any holder of this document is advised that information contained hereon reflects the Company's findings at the time of its intervention only and within the limits of Client's instructions, if any. The Company's sole responsibility is to its Client and this document does not exonerate parties to a transaction from exercising all their rights and obligations under the transaction documents. This document cannot be reproduced except in full, without prior written approval of the Company. Any unauthorized alteration, forgery or falsification of the content or appearance of this document is unlawful and offenders may be prosecuted to the fullest extent of the law.

LTE\_Band2\_20MHz\_16QAM\_100\_0\_LowCH18700-1860

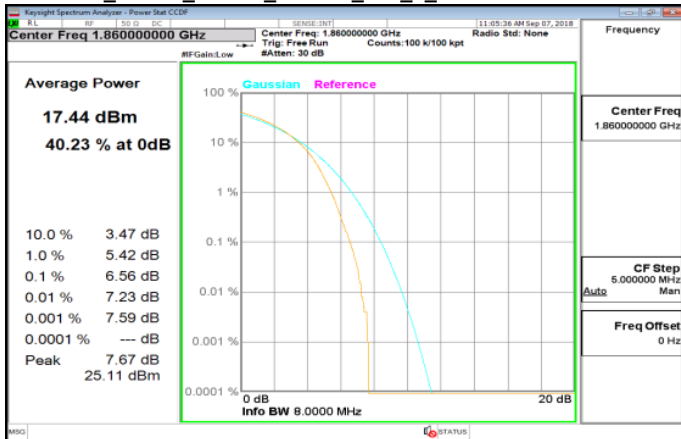

LTE\_Band2\_20MHz\_64QAM\_100\_0\_MidCH18900-1880

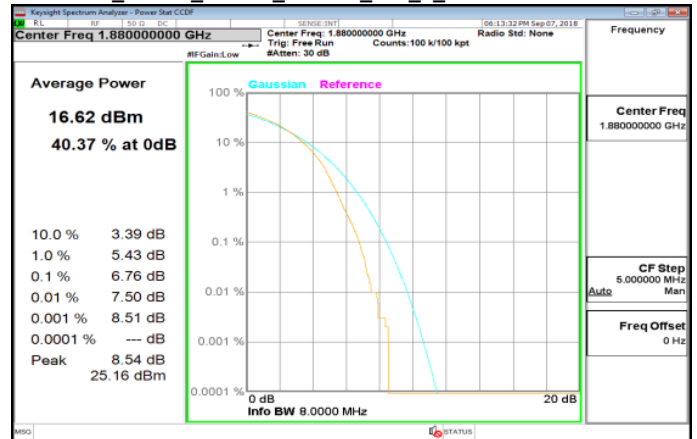

LTE\_Band2\_20MHz\_64QAM\_100\_0\_LowCH18700-1860

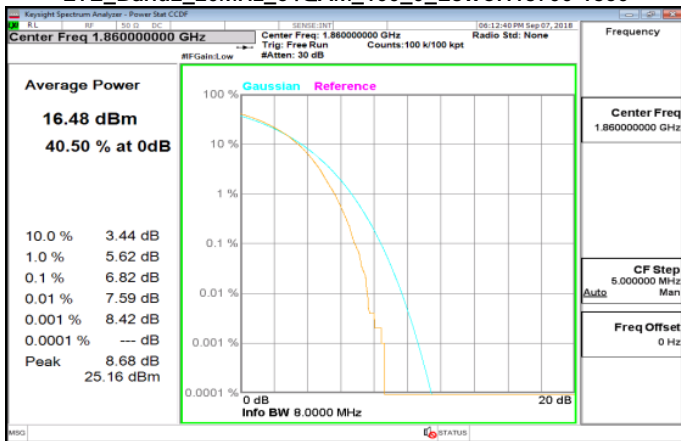

LTE\_Band2\_20MHz\_16QAM\_100\_0\_HighCH19100-1900

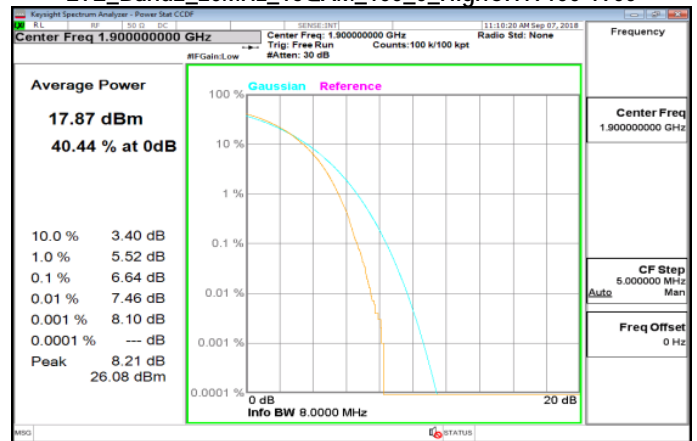

LTE\_Band2\_20MHz\_16QAM\_100\_0\_MidCH18900-1880

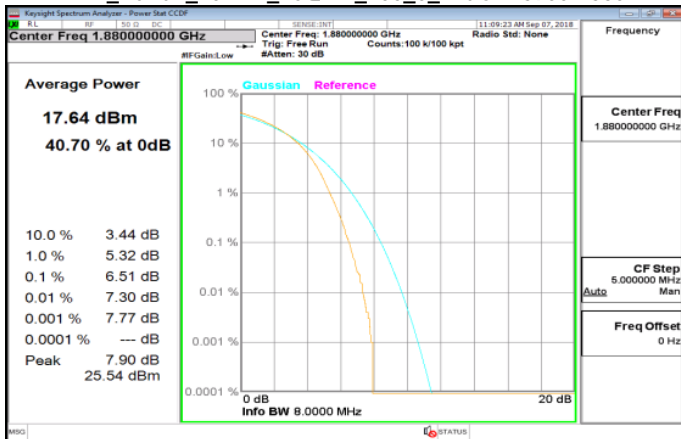

LTE\_Band2\_20MHz\_64QAM\_100\_0\_HighCH19100-1900

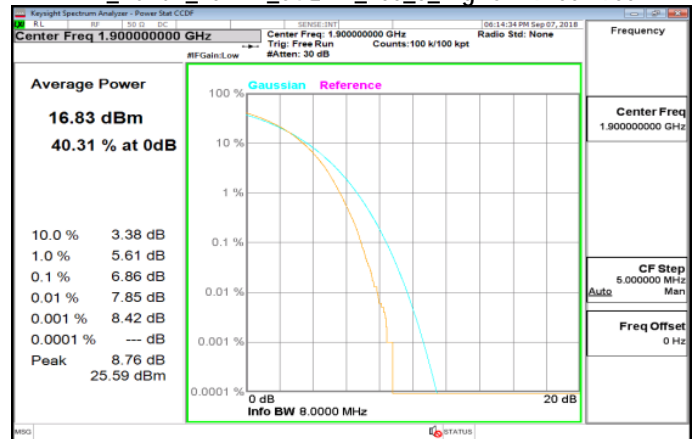

Unless otherwise stated the results shown in this test report refer only to the sample(s) tested and such sample(s) are retained for 90 days only.

除非另有說明，此報告結果僅對測試之樣品負責，同時此樣品僅保留90天。本報告未經本公司書面許可，不可部份複製。

This document is issued by the Company subject to its General Conditions of Service printed overleaf, available on request or accessible at [www.sgs.com/terms\\_and\\_conditions.htm](http://www.sgs.com/terms_and_conditions.htm) and, for electronic format documents, subject to Terms and Conditions for Electronic Documents at [www.sgs.com/terms\\_e-document.htm](http://www.sgs.com/terms_e-document.htm). Attention is drawn to the limitation of liability, indemnification and jurisdiction issues defined therein. Any holder of this document is advised that information contained hereon reflects the Company's findings at the time of its intervention only and within the limits of Client's instructions, if any. The Company's sole responsibility is to its Client and this document does not exonerate parties to a transaction from exercising all their rights and obligations under the transaction documents. This document cannot be reproduced except in full, without prior written approval of the Company. Any unauthorized alteration, forgery or falsification of the content or appearance of this document is unlawful and offenders may be prosecuted to the fullest extent of the law.