



ELECTROMAGNETIC EMISSIONS COMPLIANCE REPORT
INTENTIONAL RADIATOR CERTIFICATION TO
FCC PART 22 SUBPART H, PART 24 SUBPART E and PART 27 SUBPART
C REQUIREMENT

OF

Product Name: Smart Phone
FCC ID: APYHRO00254
Report No.: ER/2017/C0073
Issue Date: Dec. 27, 2017
FCC Rule Part: 2 , 22H & 24E & 27BH
Prepared for: Sharp Corporation, IoT Communication B.U.
2-13-1, Hachihonmatsu-lida, Higashi-hiroshima-shi, Hiroshima 739-0192, Japan
Manufacturer: Sharp Corporation
1 Takumi-cho, Sakai-ku, Sakai-Shi, Osaka 590-8522, Japan
Prepared by: SGS Taiwan Ltd.
Electronics & Communication Laboratory
No.134, Wu Kung Road, New Taipei Industrial Park, Wuku District, New Taipei City, Taiwan 24803

  Testing Laboratory 0513	<p>Note: This report shall not be reproduced except in full, without the written approval of SGS Taiwan Ltd. This document may be altered or revised by SGS Taiwan Ltd. personnel only, and shall be noted in the revision section of the document.</p>
---	--

Unless otherwise stated the results shown in this test report refer only to the sample(s) tested and such sample(s) are retained for 90 days only.

除非另有說明，此報告結果僅對測試之樣品負責，同時此樣品僅保留90天。本報告未經本公司書面許可，不可部份複製。

This document is issued by the Company subject to its General Conditions of Service printed overleaf, available on request or accessible at www.sgs.com/terms_and_conditions.htm and, for electronic format documents, subject to Terms and Conditions for Electronic Documents at www.sgs.com/terms_e-document.htm. Attention is drawn to the limitation of liability, indemnification and jurisdiction issues defined therein. Any holder of this document is advised that information contained hereon reflects the Company's findings at the time of its intervention only and within the limits of Client's instructions, if any. The Company's sole responsibility is to its Client and this document does not exonerate parties to a transaction from exercising all their rights and obligations under the transaction documents. This document cannot be reproduced except in full, without prior written approval of the Company. Any unauthorized alteration, forgery or falsification of the content or appearance of this document is unlawful and offenders may be prosecuted to the fullest extent of the law.

SGS Taiwan Ltd.

No.134,WuKungRoad,NewTaipeiIndustrialPark,WukuDistrict,NewTaipeiCity,Taiwan24803/新北市五股區新北產業園區五工路 134 號

台灣檢驗科技股份有限公司

t (886-2) 2299-3279

f (886-2) 2298-0488

www.tw.sgs.com

Member of SGS Group

VERIFICATION OF COMPLIANCE

Applicant: Sharp Corporation, IoT Communication B.U.
2-13-1, Hachihonmatsu-lida, Higashi-hiroshima-shi, Hiroshima
739-0192, Japan

Manufacturer: Sharp Corporation
1 Takumi-cho, Sakai-ku, Sakai-Shi, Osaka 590-8522, Japan

Product Name: Smart Phone

FCC ID: APYHRO00254

File Number: ER/2017/C0073

Date of test: Dec. 12, 2017 ~ Dec. 21, 2017

Date of EUT Received: Dec. 12, 2017

We hereby certify that:

The above equipment was tested by SGS Taiwan Ltd. Electronics & Communication Laboratory. The test data, data evaluation, test procedures, and equipment configurations shown in this report were made in accordance with the procedures given in ANSI/TIA-603-E-2016 and the energy emitted by the sample EUT tested as described in this report is in compliance with conducted and radiated emission limits.

The test results of this report relate only to the tested sample identified in this report.

Test By:

Marcus Tseng

Date:

Dec. 27, 2017

Marcus Tseng / Engineer

Prepared By:

Tiffany Kao

Date:

Dec. 27, 2017

Tiffany Kao / Clerk

Approved By:

Jim Chang

Date:

Dec. 27, 2017

Jim Chang / Asst. Manager

Unless otherwise stated the results shown in this test report refer only to the sample(s) tested and such sample(s) are retained for 90 days only.

除非另有說明，此報告結果僅對測試之樣品負責，同時此樣品僅保留90天。本報告未經本公司書面許可，不可部份複製。

This document is issued by the Company subject to its General Conditions of Service printed overleaf, available on request or accessible at www.sgs.com/terms_and_conditions.htm and, for electronic format documents, subject to Terms and Conditions for Electronic Documents at www.sgs.com/terms_e-document.htm. Attention is drawn to the limitation of liability, indemnification and jurisdiction issues defined therein. Any holder of this document is advised that information contained hereon reflects the Company's findings at the time of its intervention only and within the limits of Client's instructions, if any. The Company's sole responsibility is to its Client and this document does not exonerate parties to a transaction from exercising all their rights and obligations under the transaction documents. This document cannot be reproduced except in full, without prior written approval of the Company. Any unauthorized alteration, forgery or falsification of the content or appearance of this document is unlawful and offenders may be prosecuted to the fullest extent of the law.

Revision History

Report Number	Revision	Description	Issue Date
ER/2017/C0073	Rev.00	Initial creation of document	Dec. 27, 2017

Unless otherwise stated the results shown in this test report refer only to the sample(s) tested and such sample(s) are retained for 90 days only.

除非另有說明，此報告結果僅對測試之樣品負責，同時此樣品僅保留90天。本報告未經本公司書面許可，不可部份複製。

This document is issued by the Company subject to its General Conditions of Service printed overleaf, available on request or accessible at www.sgs.com/terms_and_conditions.htm and, for electronic format documents, subject to Terms and Conditions for Electronic Documents at www.sgs.com/terms_e-document.htm. Attention is drawn to the limitation of liability, indemnification and jurisdiction issues defined therein. Any holder of this document is advised that information contained hereon reflects the Company's findings at the time of its intervention only and within the limits of Client's instructions, if any. The Company's sole responsibility is to its Client and this document does not exonerate parties to a transaction from exercising all their rights and obligations under the transaction documents. This document cannot be reproduced except in full, without prior written approval of the Company. Any unauthorized alteration, forgery or falsification of the content or appearance of this document is unlawful and offenders may be prosecuted to the fullest extent of the law.

SGS Taiwan Ltd.

No.134,WuKungRoad,NewTaipeiIndustrialPark,WukuDistrict,NewTaipeiCity,Taiwan24803/新北市五股區新北產業園區五工路 134 號

台灣檢驗科技股份有限公司

t (886-2) 2299-3279

f (886-2) 2298-0488

www.tw.sgs.com

Member of SGS Group

Contents

1. GENERAL PRODUCT INFORMATION	5
2. SYSTEM TEST CONFIGURATION	9
3. SUMMARY OF TEST RESULTS	13
4. DESCRIPTION OF TEST MODES	14
5. MEASUREMENT UNCERTAINTY	19
6. RF CONDUCTED OUTPUT POWER MEASUREMENT	20
7. EFFECTIVE RADIATED POWER AND EQUIVALENT ISOTROPIC RADIATED POWER MEASUREMENT	29
8. OCCUPIED BANDWIDTH MEASUREMENT	46
9. OUT OF BAND EMISSION AT ANTENNA TERMINALS	65
10. FIELD STRENGTH OF SPURIOUS RADIATION MEASUREMENT	95
11. FREQUENCY STABILITY MEASUREMENT	136
12. PEAK TO AVERAGE RATIO	144

Unless otherwise stated the results shown in this test report refer only to the sample(s) tested and such sample(s) are retained for 90 days only.

除非另有說明，此報告結果僅對測試之樣品負責，同時此樣品僅保留90天。本報告未經本公司書面許可，不可部份複製。

This document is issued by the Company subject to its General Conditions of Service printed overleaf, available on request or accessible at www.sgs.com/terms_and_conditions.htm and, for electronic format documents, subject to Terms and Conditions for Electronic Documents at www.sgs.com/terms_e-document.htm. Attention is drawn to the limitation of liability, indemnification and jurisdiction issues defined therein. Any holder of this document is advised that information contained hereon reflects the Company's findings at the time of its intervention only and within the limits of Client's instructions, if any. The Company's sole responsibility is to its Client and this document does not exonerate parties to a transaction from exercising all their rights and obligations under the transaction documents. This document cannot be reproduced except in full, without prior written approval of the Company. Any unauthorized alteration, forgery or falsification of the content or appearance of this document is unlawful and offenders may be prosecuted to the fullest extent of the law.

SGS Taiwan Ltd.

No.134, WuKungRoad, NewTaipeiIndustrialPark, WukuDistrict, NewTaipeiCity, Taiwan24803/新北市五股區新北產業園區五工路 134 號

台灣檢驗科技股份有限公司

t (886-2) 2299-3279

f (886-2) 2298-0488

www.tw.sgs.com

Member of SGS Group

1. GENERAL PRODUCT INFORMATION

1.1. Product Description

General:

Product Name:	Smart Phone	
Hardware Version:	DVT	
Software Version:	A809G	
Power Supply:	3.85V from Rechargeable Li-ion Battery	
	Battery:	Model No.: UBATIA283AFN2, Supplier: SCUD(FUJIAN) Electronics Co., Ltd.

GSM / WCDMA / LTE:

Cellular Phone Standards Frequency Range and Power	Operating Frequency		Rated Power
		GSM/GPRS 850	824.2 MHz– 848.8 MHz
	GSM/GPRS 1900	1850.2MHz – 1909.8MHz	29.5dBm
	WCDMA/HSUPA/HSDPA Band V	826.4MHz - 846.6MHz	23.5dBm
	LTE-Band 5 (1.4MHz)	824.7MHz – 848.3MHz	23dBm
	LTE-Band 5 (3MHz)	825.5MHz – 847.5MHz	23dBm
	LTE-Band 5 (5MHz)	826.5MHz – 846.5MHz	23dBm
	LTE-Band 5 (10MHz)	829.0MHz – 844.0MHz	23dBm
	LTE-Band 12 (1.4MHz)	699.7MHz– 715.3MHz	23dBm
	LTE-Band 12 (3MHz)	700.5MHz – 714.5MHz	23dBm
	LTE-Band 12 (5MHz)	701.5MHz – 713.5MHz	23dBm
	LTE-Band 12 (10MHz)	704.0MHz – 711.0MHz	23dBm
	LTE-Band 17 (5MHz)	706.5MHz – 713.5MHz	23dBm
	LTE-Band 17 (10MHz)	709.0MHz –711.0MHz	23dBm
IMEI:	00440116131596 00440116131620		

Unless otherwise stated the results shown in this test report refer only to the sample(s) tested and such sample(s) are retained for 90 days only.

除非另有說明，此報告結果僅對測試之樣品負責，同時此樣品僅保留90天。本報告未經本公司書面許可，不可部份複製。

This document is issued by the Company subject to its General Conditions of Service printed overleaf, available on request or accessible at www.sgs.com/terms_and_conditions.htm and, for electronic format documents, subject to Terms and Conditions for Electronic Documents at www.sgs.com/terms_e-document.htm. Attention is drawn to the limitation of liability, indemnification and jurisdiction issues defined therein. Any holder of this document is advised that information contained hereon reflects the Company's findings at the time of its intervention only and within the limits of Client's instructions, if any. The Company's sole responsibility is to its Client and this document does not exonerate parties to a transaction from exercising all their rights and obligations under the transaction documents. This document cannot be reproduced except in full, without prior written approval of the Company. Any unauthorized alteration, forgery or falsification of the content or appearance of this document is unlawful and offenders may be prosecuted to the fullest extent of the law.

SGS Taiwan Ltd.

No.134,WuKungRoad,NewTaipeiIndustrialPark,WukuDistrict,NewTaipeiCity,Taiwan24803/新北市五股區新北產業園區五工路 134 號

台灣檢驗科技股份有限公司

t (886-2) 2299-3279

f (886-2) 2298-0488

www.tw.sgs.com

Member of SGS Group

Type of Emission:

Frequency Band	Type of Emission:
GSM 850	242KGXW
GPRS 850	245KGXW
GSM 1900	244KGXW
GPRS 1900	244KGXW
WCDMA Band V	4M15F9W
HSDPA Band V	4M13F9W
HSUPA Band V	4M13F9W

LTE Band	BW (MHz)	Modulation	Type of Emission
LTE Band 5	1.4MHz	QPSK	1M10G7D
LTE Band 5	1.4MHz	16QAM	1M10W7D
LTE Band 5	3MHz	QPSK	2M70G7D
LTE Band 5	3MHz	16QAM	2M70W7D
LTE Band 5	5MHz	QPSK	4M51G7D
LTE Band 5	5MHz	16QAM	4M51W7D
LTE Band 5	10MHz	QPSK	8M98G7D
LTE Band 5	10MHz	16QAM	8M96W7D
LTE Band 12	1.4MHz	QPSK	1M10G7D
LTE Band 12	1.4MHz	16QAM	1M10W7D
LTE Band 12	3MHz	QPSK	2M70G7D
LTE Band 12	3MHz	16QAM	2M70W7D
LTE Band 12	5MHz	QPSK	4M51G7D
LTE Band 12	5MHz	16QAM	4M51W7D
LTE Band 12	10MHz	QPSK	9M00G7D
LTE Band 12	10MHz	16QAM	8M96W7D
LTE Band 17	5MHz	QPSK	4M51G7D
LTE Band 17	5MHz	16QAM	4M51W7D
LTE Band 17	10MHz	QPSK	9M00G7D
LTE Band 17	10MHz	16QAM	8M96W7D

Unless otherwise stated the results shown in this test report refer only to the sample(s) tested and such sample(s) are retained for 90 days only.

除非另有說明，此報告結果僅對測試之樣品負責，同時此樣品僅保留90天。本報告未經本公司書面許可，不可部份複製。

This document is issued by the Company subject to its General Conditions of Service printed overleaf, available on request or accessible at www.sgs.com/terms_and_conditions.htm and, for electronic format documents, subject to Terms and Conditions for Electronic Documents at www.sgs.com/terms_e-document.htm. Attention is drawn to the limitation of liability, indemnification and jurisdiction issues defined therein. Any holder of this document is advised that information contained hereon reflects the Company's findings at the time of its intervention only and within the limits of Client's instructions, if any. The Company's sole responsibility is to its Client and this document does not exonerate parties to a transaction from exercising all their rights and obligations under the transaction documents. This document cannot be reproduced except in full, without prior written approval of the Company. Any unauthorized alteration, forgery or falsification of the content or appearance of this document is unlawful and offenders may be prosecuted to the fullest extent of the law.

SGS Taiwan Ltd.

No.134,WuKungRoad,NewTaipeiIndustrialPark,WukuDistrict,NewTaipeiCity,Taiwan24803/新北市五股區新北產業園區五工路 134 號

台灣檢驗科技股份有限公司

t (886-2) 2299-3279

f (886-2) 2298-0488

www.tw.sgs.com

Member of SGS Group

Max ERP/EIRP Power Measurement Result:

	dBm		W
GSM 850	21.10	ERP	0.129
GPRS 850	21.93	ERP	0.156
GSM 1900	18.81	EIRP	0.076
GPRS 1900	20.00	EIRP	0.100
WCDMA Band V	15.41	ERP	0.035
HSDPA Band V	15.59	ERP	0.036
HSUPA Band V	14.93	ERP	0.031
LTE-Band 5 (Bandwidth 1.4MHz) QPSK	15.93	ERP	0.039
LTE-Band 5 (Bandwidth 1.4MHz) 16QAM	15.52	ERP	0.036
LTE-Band 5 (Bandwidth 3MHz) QPSK	16.76	ERP	0.047
LTE-Band 5 (Bandwidth 3MHz) 16QAM	16.00	ERP	0.040
LTE-Band 5 (Bandwidth 5MHz) QPSK	15.81	ERP	0.038
LTE-Band 5 (Bandwidth 5MHz) 16QAM	15.27	ERP	0.034
LTE-Band 5 (Bandwidth 10MHz) QPSK	16.59	ERP	0.046
LTE-Band 5 (Bandwidth 10MHz) 16QAM	15.30	ERP	0.034
LTE-Band 12 (Bandwidth 1.4MHz) QPSK	8.48	ERP	0.007
LTE-Band 12 (Bandwidth 1.4MHz) 16QAM	7.73	ERP	0.006
LTE-Band 12 (Bandwidth 3MHz) QPSK	8.35	ERP	0.007
LTE-Band 12 (Bandwidth 3MHz) 16QAM	7.92	ERP	0.006
LTE-Band 12 (Bandwidth 5MHz) QPSK	8.38	ERP	0.007
LTE-Band 12 (Bandwidth 5MHz) 16QAM	7.79	ERP	0.006
LTE-Band 12 (Bandwidth 10MHz) QPSK	7.64	ERP	0.006
LTE-Band 12 (Bandwidth 10MHz) 16QAM	7.63	ERP	0.006
LTE-Band 17 (Bandwidth 5MHz) QPSK	8.19	ERP	0.007
LTE-Band 17 (Bandwidth 5MHz) 16QAM	7.82	ERP	0.006
LTE-Band 17 (Bandwidth 10MHz) QPSK	8.25	ERP	0.007
LTE-Band 17 (Bandwidth 10MHz) 16QAM	8.06	ERP	0.006

Unless otherwise stated the results shown in this test report refer only to the sample(s) tested and such sample(s) are retained for 90 days only.

除非另有說明，此報告結果僅對測試之樣品負責，同時此樣品僅保留90天。本報告未經本公司書面許可，不可部份複製。

This document is issued by the Company subject to its General Conditions of Service printed overleaf, available on request or accessible at www.sgs.com/terms_and_conditions.htm and, for electronic format documents, subject to Terms and Conditions for Electronic Documents at www.sgs.com/terms_e-document.htm. Attention is drawn to the limitation of liability, indemnification and jurisdiction issues defined therein. Any holder of this document is advised that information contained hereon reflects the Company's findings at the time of its intervention only and within the limits of Client's instructions, if any. The Company's sole responsibility is to its Client and this document does not exonerate parties to a transaction from exercising all their rights and obligations under the transaction documents. This document cannot be reproduced except in full, without prior written approval of the Company. Any unauthorized alteration, forgery or falsification of the content or appearance of this document is unlawful and offenders may be prosecuted to the fullest extent of the law.

1.2. Test Methodology of Applied Standards

FCC 47 CFR Part 2, 22, 24, 27

ANSI / TIA / EIA 603-D-2010

KDB 971168 D01 v03 Power Meas license Digital System

KDB941225 D01 v03r01 of the Output power Procedure of (SAR Measurement Procedures for 3G Devices, WCDMA / HSPA) was used for EUT and Base station setting.

TS 151 010-1 is used to set, and measure the output power.

1. Note: All test items have been performed and record as per the above standards.

1.3. Test Facility

SGS Taiwan Ltd. Electronics & Communication Laboratory No.134, Wu Kung Road, New Taipei Industrial Park, Wuku District, New Taipei City, Taiwan. (TAF code 0513)

FCC Registration Numbers are: 509634 / TW0001

1.4. Special Accessories

No special accessories were used during testing.

1.5. Equipment Modifications

There were no modifications incorporated into the EUT.

Unless otherwise stated the results shown in this test report refer only to the sample(s) tested and such sample(s) are retained for 90 days only.

除非另有說明，此報告結果僅對測試之樣品負責，同時此樣品僅保留90天。本報告未經本公司書面許可，不可部份複製。

This document is issued by the Company subject to its General Conditions of Service printed overleaf, available on request or accessible at www.sgs.com/terms_and_conditions.htm and, for electronic format documents, subject to Terms and Conditions for Electronic Documents at www.sgs.com/terms_e-document.htm. Attention is drawn to the limitation of liability, indemnification and jurisdiction issues defined therein. Any holder of this document is advised that information contained hereon reflects the Company's findings at the time of its intervention only and within the limits of Client's instructions, if any. The Company's sole responsibility is to its Client and this document does not exonerate parties to a transaction from exercising all their rights and obligations under the transaction documents. This document cannot be reproduced except in full, without prior written approval of the Company. Any unauthorized alteration, forgery or falsification of the content or appearance of this document is unlawful and offenders may be prosecuted to the fullest extent of the law.

SGS Taiwan Ltd.

No.134,WuKungRoad,NewTaipeiIndustrialPark,WukuDistrict,NewTaipeiCity,Taiwan24803/新北市五股區新北產業園區五工路 134 號

台灣檢驗科技股份有限公司

t (886-2) 2299-3279

f (886-2) 2298-0488

www.tw.sgs.com

Member of SGS Group

2. SYSTEM TEST CONFIGURATION

2.1. EUT Configuration

The EUT configuration for testing is installed on RF field strength measurement to meet the Commissions requirement and operating in a manner which intends to maximize its emission characteristics in a continuous normal application.

2.2. EUT Exercise

The EUT (Transmitter) was operated in the continuous transmission mode employed with the simulator of the Base Station that fixates at test default channels to fix the Tx frequency which was for the purpose of the measurements.

2.3. Test Procedure

2.3.1 Conducted Measurement at Antenna Port

According to measurement procured ANSI/TIA-603-E-2016, the EUT is placed on a turn table which is 0.8 m above ground plane. A low loss of RF cable was used to connect the antenna port of EUT to measurement equipment.

2.3.2 Radiated Emissions (ERP/EIRP)

According to measurement procured ANSI/TIA-603-E-2016, The EUT is a placed on as turn table which is 0.8 m above ground plane. The turn table shall rotate 360 degrees to determine the position of maximum emission level. EUT is set 3m away from the receiving antenna which varied from 1m to 4m to find out the highest emission. And also, each emission was to be maximized by changing the polarization of receiving antenna both Horizontal and Vertical. In order to find out the max. emission, the relative positions of this transmitter (EUT) was rotated through three orthogonal axes and measurement procedures for electric field radiated emissions above 1 GHz the EUT measurement is to be made "while keeping the antenna in the 'cone of radiation' from that area and pointed at the area both in azimuth and elevation, with polarization oriented for maximum response." is still within the 3dB illumination BW of the measurement antenna according to the requirements in Section 8 and 13.

Unless otherwise stated the results shown in this test report refer only to the sample(s) tested and such sample(s) are retained for 90 days only.

除非另有說明，此報告結果僅對測試之樣品負責，同時此樣品僅保留90天。本報告未經本公司書面許可，不可部份複製。

This document is issued by the Company subject to its General Conditions of Service printed overleaf, available on request or accessible at www.sgs.com/terms_and_conditions.htm and, for electronic format documents, subject to Terms and Conditions for Electronic Documents at www.sgs.com/terms_e-document.htm. Attention is drawn to the limitation of liability, indemnification and jurisdiction issues defined therein. Any holder of this document is advised that information contained hereon reflects the Company's findings at the time of its intervention only and within the limits of Client's instructions, if any. The Company's sole responsibility is to its Client and this document does not exonerate parties to a transaction from exercising all their rights and obligations under the transaction documents. This document cannot be reproduced except in full, without prior written approval of the Company. Any unauthorized alteration, forgery or falsification of the content or appearance of this document is unlawful and offenders may be prosecuted to the fullest extent of the law.

SGS Taiwan Ltd.

台灣檢驗科技股份有限公司

No.134,WuKungRoad,NewTaipeiIndustrialPark,WukuDistrict,NewTaipeiCity,Taiwan24803/新北市五股區新北產業園區五工路134號

t (886-2) 2299-3279

f (886-2) 2298-0488

www.tw.sgs.com

Member of SGS Group

2.4. Measurement Results Explanation Example

For all conducted test items:

The offset level is set in the spectrum analyzer to compensate the RF cable loss and attenuation factor between EUT conducted port and spectrum analyzer. With the offset compensation, the spectrum analyzer reading level is exactly EUT RF output level.

Note:

Offset = RF cable loss (dB)+ attenuation factor(dB) =4.6+10=14.6(dB)

2.5. Final Amplifier Voltage and Current Information:

Test Mode	DC voltage (V)	DC current (mA)
GSM 850	3.85Vdc	320
GSM1900	3.85Vdc	221
GPRS 850	3.85Vdc	325
GPRS 1900	3.85Vdc	233
WCDMA B5	3.85Vdc	325
HSUPA B5	3.85Vdc	341
HSDPA B5	3.85Vdc	349

Unless otherwise stated the results shown in this test report refer only to the sample(s) tested and such sample(s) are retained for 90 days only.

除非另有說明，此報告結果僅對測試之樣品負責，同時此樣品僅保留90天。本報告未經本公司書面許可，不可部份複製。

This document is issued by the Company subject to its General Conditions of Service printed overleaf, available on request or accessible at www.sgs.com/terms_and_conditions.htm and, for electronic format documents, subject to Terms and Conditions for Electronic Documents at www.sgs.com/terms_e-document.htm. Attention is drawn to the limitation of liability, indemnification and jurisdiction issues defined therein. Any holder of this document is advised that information contained hereon reflects the Company's findings at the time of its intervention only and within the limits of Client's instructions, if any. The Company's sole responsibility is to its Client and this document does not exonerate parties to a transaction from exercising all their rights and obligations under the transaction documents. This document cannot be reproduced except in full, without prior written approval of the Company. Any unauthorized alteration, forgery or falsification of the content or appearance of this document is unlawful and offenders may be prosecuted to the fullest extent of the law.

SGS Taiwan Ltd.

No.134,WuKungRoad,NewTaipeiIndustrialPark,WukuDistrict,NewTaipeiCity,Taiwan24803/新北市五股區新北產業園區五工路 134 號

台灣檢驗科技股份有限公司

t (886-2) 2299-3279

f (886-2) 2298-0488

www.tw.sgs.com

Member of SGS Group

Test Mode	DC voltage (V)	DC current (mA)
LTE Band 5_1.4M QPSK	3.85Vdc	581
LTE Band 5_1.4M 16QAM	3.85Vdc	655
LTE Band 5_3M QPSK	3.85Vdc	712
LTE Band 5_3M 16QAM	3.85Vdc	652
LTE Band 5_5M QPSK	3.85Vdc	755
LTE Band 5_5M 16QAM	3.85Vdc	633
LTE Band 5_10M QPSK	3.85Vdc	720
LTE Band 5_10M 16QAM	3.85Vdc	613

Test Mode	DC voltage (V)	DC current (mA)
LTE Band 12_1.4M QPSK	3.85Vdc	432
LTE Band 12_1.4M 16QAM	3.85Vdc	421
LTE Band 12_3M QPSK	3.85Vdc	453
LTE Band 12_3M 16QAM	3.85Vdc	422
LTE Band 12_5M QPSK	3.85Vdc	450
LTE Band 12_5M 16QAM	3.85Vdc	435
LTE Band 12_10M QPSK	3.85Vdc	455
LTE Band 12_10M 16QAM	3.85Vdc	440

Test Mode	DC voltage (V)	DC current (mA)
LTE Band 17_5M QPSK	3.85 Vdc	415
LTE Band 17_5M 16QAM	3.85 Vdc	426
LTE Band 17_10M QPSK	3.85 Vdc	433
LTE Band 17_10M 16QAM	3.85 Vdc	411

Unless otherwise stated the results shown in this test report refer only to the sample(s) tested and such sample(s) are retained for 90 days only.

除非另有說明，此報告結果僅對測試之樣品負責，同時此樣品僅保留90天。本報告未經本公司書面許可，不可部份複製。

This document is issued by the Company subject to its General Conditions of Service printed overleaf, available on request or accessible at www.sgs.com/terms_and_conditions.htm and, for electronic format documents, subject to Terms and Conditions for Electronic Documents at www.sgs.com/terms_e-document.htm. Attention is drawn to the limitation of liability, indemnification and jurisdiction issues defined therein. Any holder of this document is advised that information contained hereon reflects the Company's findings at the time of its intervention only and within the limits of Client's instructions, if any. The Company's sole responsibility is to its Client and this document does not exonerate parties to a transaction from exercising all their rights and obligations under the transaction documents. This document cannot be reproduced except in full, without prior written approval of the Company. Any unauthorized alteration, forgery or falsification of the content or appearance of this document is unlawful and offenders may be prosecuted to the fullest extent of the law.

SGS Taiwan Ltd.

No.134,WuKungRoad,NewTaipeiIndustrialPark,WukuDistrict,NewTaipeiCity,Taiwan24803/新北市五股區新北產業園區五工路 134 號

台灣檢驗科技股份有限公司

t (886-2) 2299-3279

f (886-2) 2298-0488

www.tw.sgs.com

Member of SGS Group

2.6. Configuration of Tested System

Fig. 2-1 Configuration of Tested System (Fixed Channel-Conducted)

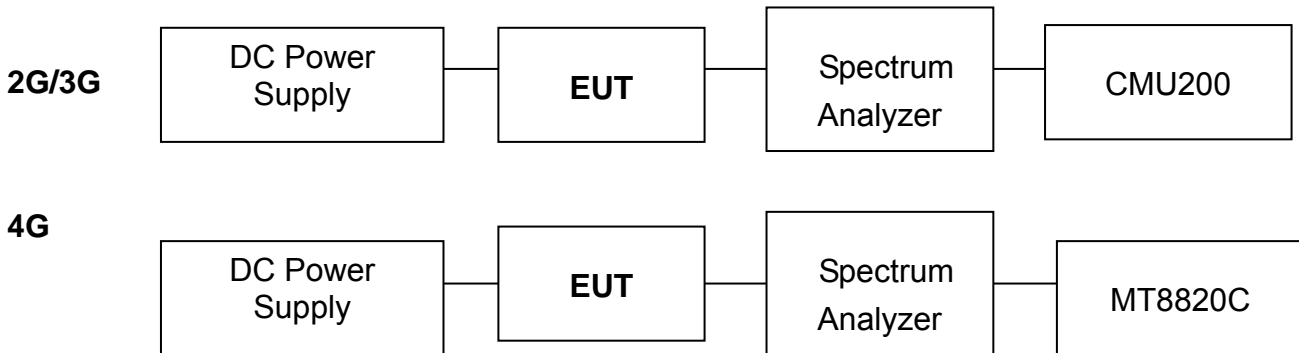

Fig. 2-2 Configuration of Tested System (Fixed Channel-Radiated)

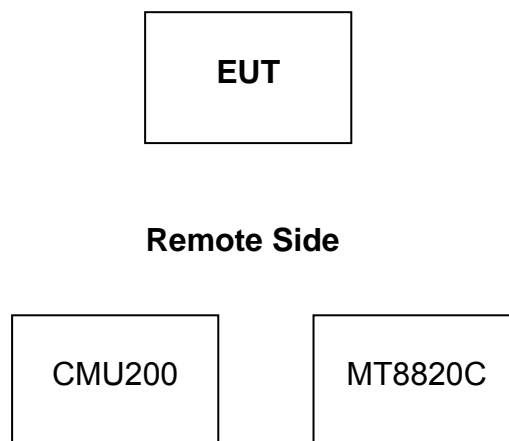

Table 2-1 Equipment Used in

Item	Equipment	Mfr/Brand	Model/Type No.	Series No.	Data Cable	Power Cord
1.	Universal Radio Communication Tester	R&S	CMU200	102189	shielded	Un-shielded
2.	Universal Radio Communication Tester	Anritsu	MT8820C	6200307563	shielded	Un-shielded
3.	DC Power Supply	HP	E3640A	KR93300208	N/A	Unshielded

Unless otherwise stated the results shown in this test report refer only to the sample(s) tested and such sample(s) are retained for 90 days only.

除非另有說明，此報告結果僅對測試之樣品負責，同時此樣品僅保留90天。本報告未經本公司書面許可，不可部份複製。

This document is issued by the Company subject to its General Conditions of Service printed overleaf, available on request or accessible at www.sgs.com/terms_and_conditions.htm and, for electronic format documents, subject to Terms and Conditions for Electronic Documents at www.sgs.com/terms_e-document.htm. Attention is drawn to the limitation of liability, indemnification and jurisdiction issues defined therein. Any holder of this document is advised that information contained hereon reflects the Company's findings at the time of its intervention only and within the limits of Client's instructions, if any. The Company's sole responsibility is to its Client and this document does not exonerate parties to a transaction from exercising all their rights and obligations under the transaction documents. This document cannot be reproduced except in full, without prior written approval of the Company. Any unauthorized alteration, forgery or falsification of the content or appearance of this document is unlawful and offenders may be prosecuted to the fullest extent of the law.

3. SUMMARY OF TEST RESULTS

FCC Rules	Description Of Test	Result
§2.1046(a)	RF Power Output	Compliant
§2.1046(a) §22.913(a)(5) §24.232(c) §27.50(h)(2) §27.50(c)(10)	ERP/ EIRP measurement	Compliant
§2.1049(h)	99% & 26dB Occupied Bandwidth	Compliant
§2.1051 §22.917(a) §24.238(a) §27.53(g) §27.53(h)(3) §27.53(m)(4)	Out of Band Emissions at Antenna Terminals and Band Edge / Emission mask requirements	Compliant
§2.1053 §22.917(a) §24.238(a) §27.53(g) §27.53(h)(3) §27.53(m)(4)	Field Strength of Spurious Radiation	Compliant
§24.232(d) §27.53(d) (5)	Peak to Average Ratio	Compliant
§2.1055(a)(1) §22.355 §24.235 §27.54	Frequency Stability	Compliant

Unless otherwise stated the results shown in this test report refer only to the sample(s) tested and such sample(s) are retained for 90 days only.

除非另有說明，此報告結果僅對測試之樣品負責，同時此樣品僅保留90天。本報告未經本公司書面許可，不可部份複製。

This document is issued by the Company subject to its General Conditions of Service printed overleaf, available on request or accessible at www.sgs.com/terms_and_conditions.htm and, for electronic format documents, subject to Terms and Conditions for Electronic Documents at www.sgs.com/terms_e-document.htm. Attention is drawn to the limitation of liability, indemnification and jurisdiction issues defined therein. Any holder of this document is advised that information contained hereon reflects the Company's findings at the time of its intervention only and within the limits of Client's instructions, if any. The Company's sole responsibility is to its Client and this document does not exonerate parties to a transaction from exercising all their rights and obligations under the transaction documents. This document cannot be reproduced except in full, without prior written approval of the Company. Any unauthorized alteration, forgery or falsification of the content or appearance of this document is unlawful and offenders may be prosecuted to the fullest extent of the law.

SGS Taiwan Ltd.

No.134,WuKungRoad,NewTaipeiIndustrialPark,WukuDistrict,NewTaipeiCity,Taiwan24803/新北市五股區新北產業園區五工路 134 號

台灣檢驗科技股份有限公司

t (886-2) 2299-3279

f (886-2) 2298-0488

www.tw.sgs.com

Member of SGS Group

4. DESCRIPTION OF TEST MODES

4.1. The Worst Test Modes and Channel Details

1. The EUT has been tested under operating condition.
2. Pre-Scan has been conducted to determine the worst-case mode from all possible combinations between available modulations, data rates, X(E1)Y(E2)Z(H) axis and antenna ports. The worst case was found as listed below. Following channel(s) was (were) selected for the final test as listed below:

BAND	ERP/EIRP	RADIATED EMISSION and Wireless charging Cover
GSM/GPRS 850	H-plan	H-plan
GSM/GPRS 1900	H-plan	H-plan
WCDMA/HSPA Band V	H-plan	H-plan
LTE Band 5	H-plan	H-plan
LTE Band 12	H-plan	H-plan
LTE Band 17	H-plan	H-plan

Unless otherwise stated the results shown in this test report refer only to the sample(s) tested and such sample(s) are retained for 90 days only.

除非另有說明，此報告結果僅對測試之樣品負責，同時此樣品僅保留90天。本報告未經本公司書面許可，不可部份複製。

This document is issued by the Company subject to its General Conditions of Service printed overleaf, available on request or accessible at www.sgs.com/terms_and_conditions.htm and, for electronic format documents, subject to Terms and Conditions for Electronic Documents at www.sgs.com/terms_e-document.htm. Attention is drawn to the limitation of liability, indemnification and jurisdiction issues defined therein. Any holder of this document is advised that information contained hereon reflects the Company's findings at the time of its intervention only and within the limits of Client's instructions, if any. The Company's sole responsibility is to its Client and this document does not exonerate parties to a transaction from exercising all their rights and obligations under the transaction documents. This document cannot be reproduced except in full, without prior written approval of the Company. Any unauthorized alteration, forgery or falsification of the content or appearance of this document is unlawful and offenders may be prosecuted to the fullest extent of the law.

SGS Taiwan Ltd.

No.134,WuKungRoad,NewTaipeiIndustrialPark,WukuDistrict,NewTaipeiCity,Taiwan24803/新北市五股區新北產業園區五工路 134 號

台灣檢驗科技股份有限公司

t (886-2) 2299-3279

f (886-2) 2298-0488

www.tw.sgs.com

Member of SGS Group

GSM/GPRS/EDGE MODE

TEST ITEM	AVAILABLE CHANNEL	TESTED CHANNEL	MODE
ERP	128 to 251	128, 190, 251	GSM/GPRS 850
EIRP	512 to 810	512, 661, 810	GSM/GPRS 1900
FREQUENCY STABILITY	128 to 251 512 to 810	190 661	GPRS 850 GPRS 1900
OCCUPIED BANDWIDTH	128 to 251 512 to 810	190 661	GSM/GPRS 850 GSM/GPRS 1900
PEAK TO AVERAGE RATIO	128 to 251 512 to 810	128, 190, 251 512, 661, 810	GSM/GPRS 850 GSM/GPRS 1900
BAND EDGE	128 to 251 512 to 810	128, 251 512, 810	GSM/GPRS 850 GSM/GPRS 1900
CONDCUDED EMISSION	128 to 251 512 to 810	128, 190, 251 512, 661, 810	GSM/GPRS 850 GSM/GPRS 1900
RADIATED EMISSION	128 to 251 512 to 810	128, 190, 251 512, 661, 810	GPRS 850 GPRS 1900

WCDMA/HSPA MODE

TEST ITEM	AVAILABLE CHANNEL	TESTED CHANNEL	MODE
ERP	4132 to 4233	4132, 4183, 4233	WCDMA/HSPA Band V
FREQUENCY STABILITY	9262 to 9538	9400	WCDMA Band V
OCCUPIED BANDWIDTH	9262 to 9538	9262, 9400, 9583	WCDMA/HSPA Band V
PEAK TO AVERAGE RATIO	9262 to 9538	9262, 9400, 9583	WCDMA/HSPA Band V
BAND EDGE	9262 to 9538	9262, 9583	WCDMA Band V
CONDCUDED EMISSION	9262 to 9538	9262, 9400, 9583	WCDMA Band V
RADIATED EMISSION	9262 to 9538	9262, 9400, 9583	WCDMA Band V

Unless otherwise stated the results shown in this test report refer only to the sample(s) tested and such sample(s) are retained for 90 days only.

除非另有說明，此報告結果僅對測試之樣品負責，同時此樣品僅保留90天。本報告未經本公司書面許可，不可部份複製。

This document is issued by the Company subject to its General Conditions of Service printed overleaf, available on request or accessible at www.sgs.com/terms_and_conditions.htm and, for electronic format documents, subject to Terms and Conditions for Electronic Documents at www.sgs.com/terms_e-document.htm. Attention is drawn to the limitation of liability, indemnification and jurisdiction issues defined therein. Any holder of this document is advised that information contained hereon reflects the Company's findings at the time of its intervention only and within the limits of Client's instructions, if any. The Company's sole responsibility is to its Client and this document does not exonerate parties to a transaction from exercising all their rights and obligations under the transaction documents. This document cannot be reproduced except in full, without prior written approval of the Company. Any unauthorized alteration, forgery or falsification of the content or appearance of this document is unlawful and offenders may be prosecuted to the fullest extent of the law.

SGS Taiwan Ltd.

No.134,WuKungRoad,NewTaipeiIndustrialPark,WukuDistrict,NewTaipeiCity,Taiwan24803/新北市五股區新北產業園區五工路 134 號

台灣檢驗科技股份有限公司

t (886-2) 2299-3279

f (886-2) 2298-0488

www.tw.sgs.com

Member of SGS Group

LTE Band 5 MODE

TEST ITEM	AVAILABLE CHANNEL	TESTED CHANNEL	CHANNEL BANDWIDTH	MODULATION	MODE
ERP	20470 to 20643	20470, 20525, 20643	1.4MHz	QPSK, 16QAM	1 RB/ 0,5 RB Offest
	20415 to 20635	20415, 20525, 20635	3MHz	QPSK, 16QAM	1 RB/ 0,14 RB Offest
	20425 to 20625	20425, 20525, 20625	5MHz	QPSK, 16QAM	1 RB/ 0,24 RB Offest
	20450 to 20600	20450, 20525, 20600	10MHz	QPSK, 16QAM	1 RB/ 0,49 RB Offest
FREQUENCY STABILITY	20450 to 20600	20525	10MHz	QPSK,	Full RB
OCCUPIED BANDWIDTH	20470 to 20643	20470, 20525, 20643	1.4MHz	QPSK, 16QAM	Full RB
	20415 to 20635	20415, 20525, 20635	3MHz	QPSK, 16QAM	Full RB
	20425 to 20625	20425, 20525, 20625	5MHz	QPSK, 16QAM	Full RB
	20450 to 20600	20450, 20525, 20600	10MHz	QPSK, 16QAM	Full RB
PEAK TO AVERAGE RATIO	20470 to 20643	20470, 20525, 20643	1.4MHz	16QAM	Full RB
	20415 to 20635	20415, 20525, 20635	3MHz	16QAM	Full RB
	20425 to 20625	20425, 20525, 20625	5MHz	16QAM	Full RB
	20450 to 20600	20450, 20525, 20600	10MHz	16QAM	Full RB
BAND EDGE	20470 to 20643	20470, 20643	1.4MHz	QPSK,	1 RB/ 0,5 RB Offes Full RB
	20415 to 20635	20415, 20635	3MHz	QPSK,	1 RB/ 0,14 RB Offest Full RB
	20425 to 20625	20425, 20625	5MHz	QPSK,	1 RB/ 0,24 RB Offest Full RB
	20450 to 20600	20450, 20600	10MHz	QPSK,	1 RB/ 0,49 RB Offest Full RB
CONDCUDED EMISSION	20470 to 20643	20470, 20525, 20643	1.4MHz	QPSK,	1 RB, 0 RB Offest
	20415 to 20635	20415, 20525, 20635	3MHz	QPSK,	1 RB, 0 RB Offest
	20425 to 20625	20425, 20525, 20625	5MHz	QPSK,	1 RB, 0 RB Offest
	20450 to 20600	20450, 20525, 20600	10MHz	QPSK,	1 RB, 0 RB Offest
RADIATED EMISSION	20415 to 20635	20415, 20525, 20635	3MHz	QPSK	1 RB/ 0 RB Offest

Unless otherwise stated the results shown in this test report refer only to the sample(s) tested and such sample(s) are retained for 90 days only.

除非另有說明，此報告結果僅對測試之樣品負責，同時此樣品僅保留90天。本報告未經本公司書面許可，不可部份複製。

This document is issued by the Company subject to its General Conditions of Service printed overleaf, available on request or accessible at www.sgs.com/terms_and_conditions.htm and, for electronic format documents, subject to Terms and Conditions for Electronic Documents at www.sgs.com/terms_e-document.htm. Attention is drawn to the limitation of liability, indemnification and jurisdiction issues defined therein. Any holder of this document is advised that information contained hereon reflects the Company's findings at the time of its intervention only and within the limits of Client's instructions, if any. The Company's sole responsibility is to its Client and this document does not exonerate parties to a transaction from exercising all their rights and obligations under the transaction documents. This document cannot be reproduced except in full, without prior written approval of the Company. Any unauthorized alteration, forgery or falsification of the content or appearance of this document is unlawful and offenders may be prosecuted to the fullest extent of the law.

SGS Taiwan Ltd.

No.134,WuKungRoad,NewTaipeiIndustrialPark,WukuDistrict,NewTaipeiCity,Taiwan24803/新北市五股區新北產業園區五工路 134 號

台灣檢驗科技股份有限公司

t (886-2) 2299-3279

f (886-2) 2298-0488

www.tw.sgs.com

Member of SGS Group

LTE Band 12 MODE

TEST ITEM	AVAILABLE CHANNEL	TESTED CHANNEL	CHANNEL BANDWIDTH	MODULATION	MODE
ERP	23017 to 23173	23017, 23095, 23173	1.4MHz	QPSK, 16QAM	1 RB/ 0,5 RB Offest
	23025 to 23165	23025, 23095, 23165	3MHz	QPSK, 16QAM	1 RB/ 0,14 RB Offest
	23035 to 23155	23035, 23095, 23155	5MHz	QPSK, 16QAM	1 RB/ 0,24 RB Offest
	23060 to 23130	23060, 23095, 23130	10MHz	QPSK, 16QAM	1 RB/ 0,49 RB Offest
FREQUENCY STABILITY	23060 to 23130	23095	10MHz	QPSK,	Full RB
OCCUPIED BANDWIDTH	23017 to 23173	23017, 23095, 23173	1.4MHz	QPSK, 16QAM	Full RB
	23025 to 23165	23025, 23095, 23165	3MHz	QPSK, 16QAM	Full RB
	23035 to 23155	23035, 23095, 23155	5MHz	QPSK, 16QAM	Full RB
	23060 to 23130	23060, 23095, 23130	10MHz	QPSK, 16QAM	Full RB
PEAK TO AVERAGE RATIO	23017 to 23173	23017, 23095, 23173	1.4MHz	16QAM	Full RB
	23025 to 23165	23025, 23095, 23165	3MHz	16QAM	Full RB
	23035 to 23155	23035, 23095, 23155	5MHz	16QAM	Full RB
	23060 to 23130	23060, 23095, 23130	10MHz	16QAM	Full RB
BAND EDGE	23017 to 23173	23017, 23095, 23173	1.4MHz	QPSK,	1 RB/ 0,5 RB Offes Full RB
	23025 to 23165	23025, 23095, 23165	3MHz	QPSK,	1 RB/ 0,14 RB Offest Full RB
	23035 to 23155	23035, 23095, 23155	5MHz	QPSK,	1 RB/ 0,24 RB Offest Full RB
	23060 to 23130	23060, 23095, 23130	10MHz	QPSK,	1 RB/ 0,49 RB Offest Full RB
CONDCUDED EMISSION	23017 to 23173	23017, 23095, 23173	1.4MHz	QPSK,	1 RB, 0 RB Offest
	23025 to 23165	23025, 23095, 23165	3MHz	QPSK,	1 RB, 0 RB Offest
	23035 to 23155	23035, 23095, 23155	5MHz	QPSK,	1 RB, 0 RB Offest
	23060 to 23130	23060, 23095, 23130	10MHz	QPSK,	1 RB, 0 RB Offest
RADIATED EMISSION	23017 to 23173	23017, 23095, 23173	1.4MHz	QPSK	1 RB, 0 RB Offest

Unless otherwise stated the results shown in this test report refer only to the sample(s) tested and such sample(s) are retained for 90 days only.

除非另有說明，此報告結果僅對測試之樣品負責，同時此樣品僅保留90天。本報告未經本公司書面許可，不可部份複製。

This document is issued by the Company subject to its General Conditions of Service printed overleaf, available on request or accessible at www.sgs.com/terms_and_conditions.htm and, for electronic format documents, subject to Terms and Conditions for Electronic Documents at www.sgs.com/terms_e-document.htm. Attention is drawn to the limitation of liability, indemnification and jurisdiction issues defined therein. Any holder of this document is advised that information contained hereon reflects the Company's findings at the time of its intervention only and within the limits of Client's instructions, if any. The Company's sole responsibility is to its Client and this document does not exonerate parties to a transaction from exercising all their rights and obligations under the transaction documents. This document cannot be reproduced except in full, without prior written approval of the Company. Any unauthorized alteration, forgery or falsification of the content or appearance of this document is unlawful and offenders may be prosecuted to the fullest extent of the law.

SGS Taiwan Ltd.

No.134,WuKungRoad,NewTaipeiIndustrialPark,WukuDistrict,NewTaipeiCity,Taiwan24803/新北市五股區新北產業園區五工路 134 號

台灣檢驗科技股份有限公司

t (886-2) 2299-3279

f (886-2) 2298-0488

www.tw.sgs.com

Member of SGS Group

LTE Band 17 MODE

TEST ITEM	AVAILABLE CHANNEL	TESTED CHANNEL	CHANNEL BANDWIDTH	MODULATION	MODE
ERP	23755 to 23825	23755, 23790, 23825	5MHz	QPSK, 16QAM	1 RB/ 0,24 RB Offest
	23780 to 23800	23780, 23790, 23800	10MHz	QPSK, 16QAM	1 RB/ 0,49 RB Offest
FREQUENCY STABILITY	23780 to 23800	23790	10MHz	QPSK,	Full RB
OCCUPIED BANDWIDTH	23755 to 23825	23755, 23790, 23825	5MHz	QPSK, 16QAM	Full RB
	23780 to 23800	23780, 23790, 23800	10MHz	QPSK, 16QAM	Full RB
PEAK TO AVERAGE RATIO	23755 to 23825	23755, 23790, 23825	5MHz	16QAM	Full RB
	23780 to 23800	23780, 23790, 23800	10MHz	16QAM	Full RB
BAND EDGE	23755 to 23825	23755, 23825	5MHz	QPSK,	1 RB/ 0,24 RB Offest Full RB
	23780 to 23800	23780, 23800	10MHz	QPSK,	1 RB/ 0,49 RB Offest Full RB
CONDCUDED EMISSION	23755 to 23825	23755, 23790, 23825	5MHz	QPSK,	1 RB, 0 RB Offest
	23780 to 23800	23780, 23790, 23800	10MHz	QPSK,	1 RB, 0 RB Offest
RADIATED EMISSION	23780 to 23800	23790	10MHz	QPSK	1 RB, 49 RB Offest

Unless otherwise stated the results shown in this test report refer only to the sample(s) tested and such sample(s) are retained for 90 days only.

除非另有說明，此報告結果僅對測試之樣品負責，同時此樣品僅保留90天。本報告未經本公司書面許可，不可部份複製。

This document is issued by the Company subject to its General Conditions of Service printed overleaf, available on request or accessible at www.sgs.com/terms_and_conditions.htm and, for electronic format documents, subject to Terms and Conditions for Electronic Documents at www.sgs.com/terms_e-document.htm. Attention is drawn to the limitation of liability, indemnification and jurisdiction issues defined therein. Any holder of this document is advised that information contained hereon reflects the Company's findings at the time of its intervention only and within the limits of Client's instructions, if any. The Company's sole responsibility is to its Client and this document does not exonerate parties to a transaction from exercising all their rights and obligations under the transaction documents. This document cannot be reproduced except in full, without prior written approval of the Company. Any unauthorized alteration, forgery or falsification of the content or appearance of this document is unlawful and offenders may be prosecuted to the fullest extent of the law.

SGS Taiwan Ltd.

No.134,WuKungRoad,NewTaipeiIndustrialPark,WukuDistrict,NewTaipeiCity,Taiwan24803/新北市五股區新北產業園區五工路 134 號

台灣檢驗科技股份有限公司

t (886-2) 2299-3279

f (886-2) 2298-0488

www.tw.sgs.com

Member of SGS Group

5. MEASUREMENT UNCERTAINTY

Test Items	Uncertainty
RF Power Output	+/- 1.10 dB
ERP/ EIRP measurement	Vertical Polarization = +/- 4.74dB Horizontal Polarization = +/- 4.62dB
99% Occupied Bandwidth	+/- 5.19 Hz
Out of Band Emissions at Antenna Terminals and Band Edge	+/- 0.70 dB
Peak to Average Ratio	+/- 0.70 dB
Frequency Stability vs. Temperature	+/- 5.19 Hz
Frequency Stability vs. Voltage	+/- 5.19 Hz
Temperature	+/- 0.65 °C
Humidity	+/- 4.6 %
DC / AC Power Source	DC= +/- 0.13%, AC= +/- 0.2%

Radiated Spurious Emission:

Measurement uncertainty (Polarization : Vertical)	9kHz – 30MHz: +/- 2.87 dB
	30MHz - 180MHz: +/- 3.37dB
	180MHz -417MHz: +/- 3.19dB
	0.417GHz-1GHz: +/- 3.19dB
	1GHz - 18GHz: +/- 4.04dB
	18GHz - 40GHz: +/- 4.04dB

Measurement uncertainty (Polarization : Horizontal)	9kHz – 30MHz: +/- 2.87 dB
	30MHz - 167MHz: +/- 4.22dB
	167MHz -500MHz: +/- 3.44dB
	0.5GHz-1GHz: +/- 3.39dB
	1GHz - 18GHz: +/- 4.08dB
	18GHz - 40GHz: +/- 4.08dB

This uncertainty represents an expanded uncertainty expressed at approximately the 95% confidence level using a coverage factor of k=2.

Unless otherwise stated the results shown in this test report refer only to the sample(s) tested and such sample(s) are retained for 90 days only.

除非另有說明，此報告結果僅對測試之樣品負責，同時此樣品僅保留90天。本報告未經本公司書面許可，不可部份複製。

This document is issued by the Company subject to its General Conditions of Service printed overleaf, available on request or accessible at www.sgs.com/terms_and_conditions.htm and, for electronic format documents, subject to Terms and Conditions for Electronic Documents at www.sgs.com/terms_e-document.htm. Attention is drawn to the limitation of liability, indemnification and jurisdiction issues defined therein. Any holder of this document is advised that information contained hereon reflects the Company's findings at the time of its intervention only and within the limits of Client's instructions, if any. The Company's sole responsibility is to its Client and this document does not exonerate parties to a transaction from exercising all their rights and obligations under the transaction documents. This document cannot be reproduced except in full, without prior written approval of the Company. Any unauthorized alteration, forgery or falsification of the content or appearance of this document is unlawful and offenders may be prosecuted to the fullest extent of the law.

6. RF CONDUCTED OUTPUT POWER MEASUREMENT

6.1. Standard Applicable

A base station simulator was used to establish communication with the EUT. Its parameters were set to transmit the maximum power on the EUT. The measured power in the radio frequency on the transmitter output terminals.

6.2. Test Set-up

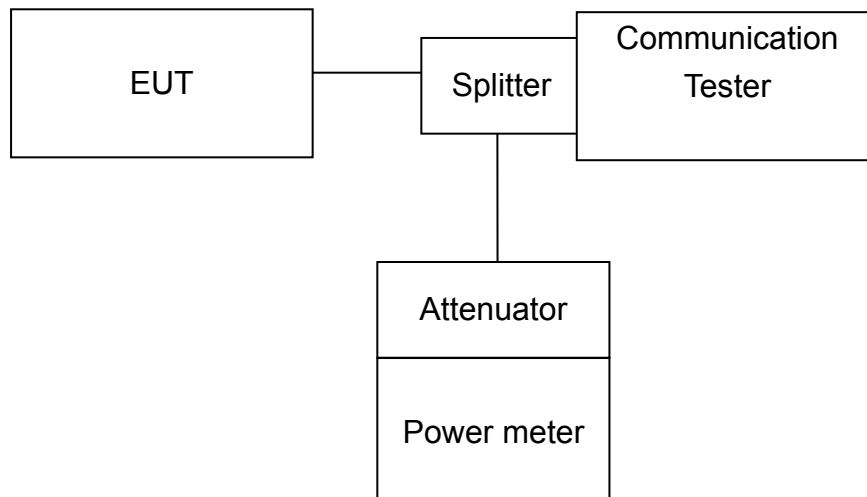

Note: Measurement setup for testing on Antenna connector

6.3. Measurement Procedure

The transmitter output was connected to a calibrated attenuator, the other end of which was connected to a power meter. Transmitter output was read off the power meter in dBm. The power output at the transmitter antenna port was determined by adding the value of the attenuator to the power meter reading. TS 151 010-1 is reference to conduct the test measurement of output power.

The Procedure of KDB941225 (SAR Measurement Procedures for 3G devices, (WCDMA/HSPA) was used for EUT and Base station setting. RMC 12.2kps is used for this testing, and KDB 971168 D01 Power Meas License Digital System as the supplemental test methodology to adjust the proper setting obtaining the measurement results

Unless otherwise stated the results shown in this test report refer only to the sample(s) tested and such sample(s) are retained for 90 days only.

除非另有說明，此報告結果僅對測試之樣品負責，同時此樣品僅保留90天。本報告未經本公司書面許可，不可部份複製。

This document is issued by the Company subject to its General Conditions of Service printed overleaf, available on request or accessible at www.sgs.com/terms_and_conditions.htm and, for electronic format documents, subject to Terms and Conditions for Electronic Documents at www.sgs.com/terms_e-document.htm. Attention is drawn to the limitation of liability, indemnification and jurisdiction issues defined therein. Any holder of this document is advised that information contained hereon reflects the Company's findings at the time of its intervention only and within the limits of Client's instructions, if any. The Company's sole responsibility is to its Client and this document does not exonerate parties to a transaction from exercising all their rights and obligations under the transaction documents. This document cannot be reproduced except in full, without prior written approval of the Company. Any unauthorized alteration, forgery or falsification of the content or appearance of this document is unlawful and offenders may be prosecuted to the fullest extent of the law.

SGS Taiwan Ltd.

No.134,WuKungRoad,NewTaipeiIndustrialPark,WukuDistrict,NewTaipeiCity,Taiwan24803/新北市五股區新北產業園區五工路 134 號

台灣檢驗科技股份有限公司

t (886-2) 2299-3279

f (886-2) 2298-0488

www.tw.sgs.com

Member of SGS Group

6.4. Measurement Equipment Used

Conducted Emission (measured at antenna port) Test Site					
EQUIPMENT TYPE	MFR	MODEL NUMBER	SERIAL NUMBER	LAST CAL.	CAL DUE.
Power Meter	Anritsu	ML2495A	1005007	12/15/2017	12/14/2018
Power Sensor	Anritsu	MA2411B	917032	12/15/2017	12/14/2018
EXA Spectrum Analyzer	Agilent	N9030A	MY53120760	03/21/2017	03/20/2018
DC Block	Mini-Circuits	BLK-18-S+	1	01/05/2017	01/04/2018
Coaxial Cable	HU-BER+SUHNER	SUCOFLEX 102	23670/2	01/05/2017	01/04/2018
Attenuator	Mini-Circuit	BW-S10W2+	2	01/05/2017	01/04/2018
Splitter	Agilent	11636B	N/A	01/05/2017	01/04/2018
DC Power Supply	Agilent	E3640A	MY52410006	11/21/2017	11/20/2018
Temperature Chamber	TERCHY	MHG-120LF	911009	05/19/2017	05/18/2018
Radio Communication Analyzer	R&S	CMU200	102189	02/11/2017	02/10/2018
Radio Communication Analyzer	Anritsu	MT8820C	6201465317	01/03/2017	01/02/2018

Unless otherwise stated the results shown in this test report refer only to the sample(s) tested and such sample(s) are retained for 90 days only.

除非另有說明，此報告結果僅對測試之樣品負責，同時此樣品僅保留90天。本報告未經本公司書面許可，不可部份複製。

This document is issued by the Company subject to its General Conditions of Service printed overleaf, available on request or accessible at www.sgs.com/terms_and_conditions.htm and, for electronic format documents, subject to Terms and Conditions for Electronic Documents at www.sgs.com/terms_e-document.htm. Attention is drawn to the limitation of liability, indemnification and jurisdiction issues defined therein. Any holder of this document is advised that information contained hereon reflects the Company's findings at the time of its intervention only and within the limits of Client's instructions, if any. The Company's sole responsibility is to its Client and this document does not exonerate parties to a transaction from exercising all their rights and obligations under the transaction documents. This document cannot be reproduced except in full, without prior written approval of the Company. Any unauthorized alteration, forgery or falsification of the content or appearance of this document is unlawful and offenders may be prosecuted to the fullest extent of the law.

SGS Taiwan Ltd.

No.134,WuKungRoad,NewTaipeiIndustrialPark,WukuDistrict,NewTaipeiCity,Taiwan24803/新北市五股區新北產業園區五工路 134 號

台灣檢驗科技股份有限公司

t (886-2) 2299-3279

f (886-2) 2298-0488

www.tw.sgs.com

Member of SGS Group

6.5. Measurement Result

RF Conducted Output Power

GSM/GPRS/EDGE (GMSK; 8-PSK) Result:

EUT Mode	Frequency (MHz)	CH	Average Burst Power (1DN 1UP) Class 8 (dBm)
GSM 850	824.2	128	32.35
	836.6	190	32.31
	848.8	251	32.38
GSM 1900	1850.2	512	29.59
	1880.0	661	29.80
	1909.8	810	29.61

EUT Mode	Frequency (MHz)	CH	Average Burst Power (1DN 1UP) Class 8 (dBm)	Average Burst Power (1DN 2UP) Class 10 (dBm)	Average Burst Power (1DN 3UP) Class 12 (dBm)	Average Burst Power (1DN 4UP) Class 12 (dBm)
GPRS 850	824.2	128	32.35	29.78	28.31	27.27
	836.6	190	32.31	29.91	28.33	27.12
	848.8	251	32.38	30.05	28.28	27.29
GPRS 1900	1850.2	512	29.59	27.19	25.22	24.28
	1880.0	661	29.80	27.03	25.32	24.21
	1909.8	810	29.61	27.33	25.35	24.37

Unless otherwise stated the results shown in this test report refer only to the sample(s) tested and such sample(s) are retained for 90 days only.

除非另有說明，此報告結果僅對測試之樣品負責，同時此樣品僅保留90天。本報告未經本公司書面許可，不可部份複製。

This document is issued by the Company subject to its General Conditions of Service printed overleaf, available on request or accessible at www.sgs.com/terms_and_conditions.htm and, for electronic format documents, subject to Terms and Conditions for Electronic Documents at www.sgs.com/terms_e-document.htm. Attention is drawn to the limitation of liability, indemnification and jurisdiction issues defined therein. Any holder of this document is advised that information contained hereon reflects the Company's findings at the time of its intervention only and within the limits of Client's instructions, if any. The Company's sole responsibility is to its Client and this document does not exonerate parties to a transaction from exercising all their rights and obligations under the transaction documents. This document cannot be reproduced except in full, without prior written approval of the Company. Any unauthorized alteration, forgery or falsification of the content or appearance of this document is unlawful and offenders may be prosecuted to the fullest extent of the law.

SGS Taiwan Ltd.

No.134,WuKungRoad,NewTaipeiIndustrialPark,WukuDistrict,NewTaipeiCity,Taiwan24803/新北市五股區新北產業園區五工路 134 號

台灣檢驗科技股份有限公司

t (886-2) 2299-3279

f (886-2) 2298-0488

www.tw.sgs.com

Member of SGS Group

WCDMA MODE:

The following tests were completed according to the test requirements outlined in section 5.2 of the 3GPP TS34.121-1 V8.4.0 specification. The EUT supports power Class 3, which has a nominal maximum output power of 24 dBm (+1.7/-3.7). RMC 12.2kps is used for this testing.

Results:

EUT Mode		WCDMA Band V	HSDPA Band V	HSUPA Band V
Frequency (MHz)	CH	Avg. Power (dBm)	Avg. Power (dBm)	Avg. Power (dBm)
826.4	4132	23.53	23.45	23.42
836.6	4183	22.45	22.36	22.50
846.6	4233	22.38	22.34	22.48

Unless otherwise stated the results shown in this test report refer only to the sample(s) tested and such sample(s) are retained for 90 days only.

除非另有說明，此報告結果僅對測試之樣品負責，同時此樣品僅保留90天。本報告未經本公司書面許可，不可部份複製。

This document is issued by the Company subject to its General Conditions of Service printed overleaf, available on request or accessible at www.sgs.com/terms_and_conditions.htm and, for electronic format documents, subject to Terms and Conditions for Electronic Documents at www.sgs.com/terms_e-document.htm. Attention is drawn to the limitation of liability, indemnification and jurisdiction issues defined therein. Any holder of this document is advised that information contained hereon reflects the Company's findings at the time of its intervention only and within the limits of Client's instructions, if any. The Company's sole responsibility is to its Client and this document does not exonerate parties to a transaction from exercising all their rights and obligations under the transaction documents. This document cannot be reproduced except in full, without prior written approval of the Company. Any unauthorized alteration, forgery or falsification of the content or appearance of this document is unlawful and offenders may be prosecuted to the fullest extent of the law.

SGS Taiwan Ltd.

No.134,WuKungRoad,NewTaipeiIndustrialPark,WukuDistrict,NewTaipeiCity,Taiwan24803/新北市五股區新北產業園區五工路 134 號

台灣檢驗科技股份有限公司

t (886-2) 2299-3279

f (886-2) 2298-0488

www.tw.sgs.com

Member of SGS Group

LTE Result:
LTE Band 5

LTE Band 5_Uplink frequency band : 824 to 849 MHz								
BW (MHz)	RB Size	RB Offset	Conducted power(dBm)					
			QPSK			16QAM		
			Channel l (Low) 20407	Channel l (Mid) 20525	Channel l (High) 20643	Channel l (Low) 20407	Channel l (Mid) 20525	Channel l (High) 20643
1.4	1	0	22.94	22.99	22.80	21.58	21.52	21.55
	1	5	22.96	23.19	22.91	21.31	22.07	21.21
	3	2	23.08	23.14	22.99	21.80	21.94	21.75
	6	0	22.07	22.18	21.96	20.89	20.95	20.87

LTE Band 5_Uplink frequency band : 824 to 849 MHz								
BW (MHz)	RB Size	RB Offset	Conducted power(dBm)					
			QPSK			16QAM		
			Channel (Low) 20415	Channel (Mid) 20525	Channel (High) 20635	Channel (Low) 20415	Channel (Mid) 20525	Channel (High) 20635
3	1	0	23.03	23.18	22.84	21.68	21.70	21.35
	1	14	23.04	23.05	23.08	22.29	21.74	21.90
	8	4	22.23	22.29	22.18	21.23	21.27	20.95
	15	0	22.31	22.26	22.10	20.83	21.10	21.04

LTE Band 5_Uplink frequency band : 824 to 849 MHz								
BW (MHz)	RB Size	RB Offset	Conducted power(dBm)					
			QPSK			16QAM		
			Channel l (Low) 20425	Channel l (Mid) 20525	Channel l (High) 20625	Channel l (Low) 20425	Channel l (Mid) 20525	Channel l (High) 20625
5	1	0	22.95	22.70	22.76	21.80	22.00	21.66
	1	24	23.12	22.69	22.86	22.08	22.16	21.27
	12	6	22.27	22.22	22.11	21.13	21.08	20.89
	25	0	22.22	22.21	22.25	21.23	21.28	21.01

LTE Band 5_Uplink frequency band : 824 to 849 MHz								
BW (MHz)	RB Size	RB Offset	Conducted power(dBm)					
			QPSK			16QAM		
			Channel (Low) 20450	Channel (Mid) 20525	Channel (High) 20600	Channel (Low) 20450	Channel (Mid) 20525	Channel (High) 20600
10	1	0	22.84	22.80	23.03	21.94	21.88	21.32
	1	49	22.90	22.88	22.89	21.75	21.48	21.90
	25	12	22.38	22.28	22.27	21.46	21.25	21.04
	50	0	22.38	22.21	22.33	21.28	21.30	21.23

LTE Band 12

LTE Band 12_Uplink frequency band : 699 to 716 MHz								
BW (MHz)	RB Size	RB Offset	Conducted power(dBm)					
			QPSK			16QAM		
			Channel l (Low) 20775	Channel l (Mid) 21100	Channel l (High) 21425	Channel l (Low) 20775	Channel l (Mid) 21100	Channel l (High) 21425
1.4	1	0	22.91	22.90	22.66	21.84	21.45	21.96
	1	5	23.03	22.99	22.54	21.94	21.68	21.77
	3	2	23.20	23.14	22.84	22.02	21.83	21.89
	6	0	22.15	22.13	21.95	20.89	20.99	20.89

LTE Band 12_Uplink frequency band : 699 to 716 MHz								
BW (MHz)	RB Size	RB Offset	Conducted power(dBm)					
			QPSK			16QAM		
			Channel (Low) 20800	Channel (Mid) 21100	Channel (High) 21400	Channel (Low) 20800	Channel (Mid) 21100	Channel (High) 21400
3	1	0	22.83	22.86	22.99	21.96	22.03	21.55
	1	14	22.73	22.98	23.07	21.86	21.80	22.01
	8	4	22.27	22.19	21.91	21.42	20.93	21.14
	15	0	22.20	22.22	22.00	21.33	21.46	20.99

LTE Band 12_Uplink frequency band : 699 to 716 MHz								
BW (MHz)	RB Size	RB Offset	Conducted power(dBm)					
			QPSK			16QAM		
			Channel l (Low) 20825	Channel l (Mid) 21100	Channel l (High) 21375	Channel l (Low) 20825	Channel l (Mid) 21100	Channel l (High) 21375
5	1	0	22.96	22.73	22.80	21.38	21.46	21.44
	1	24	22.95	22.79	22.94	22.32	21.43	21.93
	12	6	22.17	22.22	22.19	21.20	21.34	21.11
	25	0	22.13	22.17	22.02	21.30	21.31	21.04

LTE Band 12_Uplink frequency band : 699 to 716 MHz								
BW (MHz)	RB Size	RB Offset	Conducted power(dBm)					
			QPSK			16QAM		
			Channel (Low) 20850	Channel (Mid) 21100	Channel (High) 21350	Channel (Low) 20850	Channel (Mid) 21100	Channel (High) 21350
10	1	0	22.69	22.58	22.73	21.39	21.46	21.42
	1	49	22.93	22.83	22.77	21.27	21.64	21.49
	25	12	22.09	22.15	22.19	21.06	21.13	21.05
	50	0	22.20	22.22	22.15	21.10	21.25	21.28

Unless otherwise stated the results shown in this test report refer only to the sample(s) tested and such sample(s) are retained for 90 days only.

除非另有說明，此報告結果僅對測試之樣品負責，同時此樣品僅保留90天。本報告未經本公司書面許可，不可部份複製。

This document is issued by the Company subject to its General Conditions of Service printed overleaf, available on request or accessible at www.sgs.com/terms_and_conditions.htm and, for electronic format documents, subject to Terms and Conditions for Electronic Documents at www.sgs.com/terms_e-document.htm. Attention is drawn to the limitation of liability, indemnification and jurisdiction issues defined therein. Any holder of this document is advised that information contained hereon reflects the Company's findings at the time of its intervention only and within the limits of Client's instructions, if any. The Company's sole responsibility is to its Client and this document does not exonerate parties to a transaction from exercising all their rights and obligations under the transaction documents. This document cannot be reproduced except in full, without prior written approval of the Company. Any unauthorized alteration, forgery or falsification of the content or appearance of this document is unlawful and offenders may be prosecuted to the fullest extent of the law.

SGS Taiwan Ltd.

No.134,WuKungRoad,NewTaipeiIndustrialPark,WukuDistrict,NewTaipeiCity,Taiwan24803/新北市五股區新北產業園區五工路 134 號

台灣檢驗科技股份有限公司

t (886-2) 2299-3279

f (886-2) 2298-0488

www.tw.sgs.com

Member of SGS Group

LTE Band 17

LTE Band 17_Uplink frequency band : 704 to 716 MHz								
BW (MHz)	RB Size	RB Offset	Conducted power(dBm)					
			QPSK			16QAM		
			Channel I (Low) 37775	Channel I (Mid) 38000	Channel I (High) 38225	Channel I (Low) 37775	Channel I (Mid) 38000	Channel I (High) 38225
5	1	0	22.85	22.98	22.63	21.57	21.73	21.64
	1	24	22.92	23.13	22.99	21.29	21.80	22.20
	12	6	22.19	22.21	22.00	21.20	21.18	21.10
	25	0	22.17	22.22	21.99	21.21	21.16	20.95

LTE Band 17_Uplink frequency band : 704 to 716 MHz								
BW (MHz)	RB Size	RB Offset	Conducted power(dBm)					
			QPSK			16QAM		
			Channel (Low) 37800	Channel (Mid) 38000	Channel (High) 38200	Channel (Low) 37800	Channel (Mid) 38000	Channel (High) 38200
10	1	0	22.88	22.76	22.77	21.90	21.43	21.64
	1	49	23.14	23.05	22.92	21.94	21.75	21.37
	25	12	22.20	22.20	22.13	21.22	21.15	21.20
	50	0	22.17	22.20	22.17	21.29	21.19	21.17

Unless otherwise stated the results shown in this test report refer only to the sample(s) tested and such sample(s) are retained for 90 days only.

除非另有說明，此報告結果僅對測試之樣品負責，同時此樣品僅保留90天。本報告未經本公司書面許可，不可部份複製。

This document is issued by the Company subject to its General Conditions of Service printed overleaf, available on request or accessible at www.sgs.com/terms_and_conditions.htm and, for electronic format documents, subject to Terms and Conditions for Electronic Documents at www.sgs.com/terms_e-document.htm. Attention is drawn to the limitation of liability, indemnification and jurisdiction issues defined therein. Any holder of this document is advised that information contained hereon reflects the Company's findings at the time of its intervention only and within the limits of Client's instructions, if any. The Company's sole responsibility is to its Client and this document does not exonerate parties to a transaction from exercising all their rights and obligations under the transaction documents. This document cannot be reproduced except in full, without prior written approval of the Company. Any unauthorized alteration, forgery or falsification of the content or appearance of this document is unlawful and offenders may be prosecuted to the fullest extent of the law.

SGS Taiwan Ltd.

No.134,WuKungRoad,NewTaipeiIndustrialPark,WukuDistrict,NewTaipeiCity,Taiwan24803/新北市五股區新北產業園區五工路 134 號

台灣檢驗科技股份有限公司

t (886-2) 2299-3279

f (886-2) 2298-0488

www.tw.sgs.com

Member of SGS Group

HSDPA Release 6 MODE:

The following 4 Sub-Tests were completed according to the test requirements outlined in section 5.2A of the 3GPP TS34.121-1 V8.4.0 specification. All TX RMS power requirements for Power Class 3 were met according to table 5.2AA.5 and 5.2B.5 All UE channels and power ratio's are set according to table C10.1.4 & C11.1.3 in the 3GPP TS34.121-1 V8.4.0. RMC 12.2kps is used for this testing.

HSDPA SUB-TEST Setting

Table C.10.1.4: β values for transmitter characteristics tests with HS-DPCCH(FOR HSDPA)

Sub-test	β_c	β_d	β_d (SF)	β_c/β_d	β_{HS} (Note 1, Note 2)	CM (dB) (Note 3)	MPR (dB) (Note 3)	RMC (Kbps)
1	2/15	15/15	64	2/15	4/15	0.0	0.0	12.2
2	12/15 (Note 4)	15/15 (Note 4)	64	12/15 (Note 4)	24/15	1.0	0.0	12.2
3	15/15	8/15	64	15/8	30/15	1.5	0.5	12.2
4	15/15	4/15	64	15/4	30/15	1.5	0.5	12.2

Note: The recommended HSDPA MPRs are implemented as per following sub-tests.

Results:

Mode	Sub-test	Avg. Power (dBm) Channel			Power Class 3 Lim- itation (dBm)	Comments
		4132	4183	4233		
HSDPA (B5)	1	22.45	22.36	22.50	20.3dBm – 25.7dBm	Pass
	2	22.37	22.34	22.48	20.3dBm – 25.7dBm	Pass
	3	22.33	22.33	22.42	19.8dBm – 25.7dBm	Pass
	4	22.32	22.33	22.42	19.8dBm – 25.7dBm	Pass

Unless otherwise stated the results shown in this test report refer only to the sample(s) tested and such sample(s) are retained for 90 days only.

除非另有說明，此報告結果僅對測試之樣品負責，同時此樣品僅保留90天。本報告未經本公司書面許可，不可部份複製。

This document is issued by the Company subject to its General Conditions of Service printed overleaf, available on request or accessible at www.sgs.com/terms_and_conditions.htm and, for electronic format documents, subject to Terms and Conditions for Electronic Documents at www.sgs.com/terms_e-document.htm. Attention is drawn to the limitation of liability, indemnification and jurisdiction issues defined therein. Any holder of this document is advised that information contained hereon reflects the Company's findings at the time of its intervention only and within the limits of Client's instructions, if any. The Company's sole responsibility is to its Client and this document does not exonerate parties to a transaction from exercising all their rights and obligations under the transaction documents. This document cannot be reproduced except in full, without prior written approval of the Company. Any unauthorized alteration, forgery or falsification of the content or appearance of this document is unlawful and offenders may be prosecuted to the fullest extent of the law.

HSPA (HSDPA & HSUPA) Release 6 MODE

The following 5 Sub-Tests were completed according to the test requirements outlined in section 5.2A of the 3GPP TS34.121-1 V8.4.0 specification. All TX RMS power requirements for Power Class 3 were met according to table 5.2AA.5 and 5.2B.5 All UE channels and power ratio's are set according to table C11.1.3 in the 3GPP TS34.121-1 V8.4.0. RMC 12.2kps is used for this testing

HSPA SUB-TEST Setting

Table C.11.1.3: β values for transmitter characteristics tests with HS-DPCCH and E-DCH(FOR HSUPA)

Sub-test	β_c	β_d	β_d (SF)	β_c/β_d	β_{HS}	β_{ec}	β_{ed}	β_{ed} (SF)	β_{ed} (Code s)	CM (dB)	MPR (dB)	AG Index	E-TFCI	RMC (Kbps)
1	11/15 (Note 3)	15/15 (Note 3)	64	11/15 (Note 3)	22/15	209/225	1309/225	4	1	1.0	0.0	20	75	12.2
2	6/15	15/15	64	6/15	12/15	12/15	94/75	4	1	3.0	2.0	12	67	12.2
3	15/15	9/15	64	15/9	30/15	30/15	$\beta_{ed1}: 47/15$ $\beta_{ed2}: 47/15$	4 4	2	2.0	1.0	15	92	12.2
4	2/15	15/15	64	2/15	4/15	2/15	56/75	4	1	3.0	2.0	17	71	12.2
5	15/15 (Note 4)	15/15 (Note 4)	64	15/15 (Note 4)	30/15	24/15	134/15	4	1	1.0	0.0	21	81	12.2

Note: The recommended HSUPA MPRs are implemented as per following sub-tests.

Results:

Mode	Sub-test	Avg. Power (dBm) Channel			Power Class 3 Limitation (dBm)	Comments
		4132	4183	4233		
HSUPA(B5)	1	22.38	22.34	22.48	18.8dBm – 25.7dBm	Pass
	2	21.84	21.87	21.92	16.8dBm – 25.7dBm	Pass
	3	21.78	21.84	21.84	17.8dBm – 25.7dBm	Pass
	4	21.85	21.88	21.93	16.8dBm – 25.7dBm	Pass
	5	22.43	22.35	22.50	18.8dBm – 25.7dBm	Pass

Unless otherwise stated the results shown in this test report refer only to the sample(s) tested and such sample(s) are retained for 90 days only.

除非另有說明，此報告結果僅對測試之樣品負責，同時此樣品僅保留90天。本報告未經本公司書面許可，不可部份複製。

This document is issued by the Company subject to its General Conditions of Service printed overleaf, available on request or accessible at www.sgs.com/terms_and_conditions.htm and, for electronic format documents, subject to Terms and Conditions for Electronic Documents at www.sgs.com/terms_e-document.htm. Attention is drawn to the limitation of liability, indemnification and jurisdiction issues defined therein. Any holder of this document is advised that information contained hereon reflects the Company's findings at the time of its intervention only and within the limits of Client's instructions, if any. The Company's sole responsibility is to its Client and this document does not exonerate parties to a transaction from exercising all their rights and obligations under the transaction documents. This document cannot be reproduced except in full, without prior written approval of the Company. Any unauthorized alteration, forgery or falsification of the content or appearance of this document is unlawful and offenders may be prosecuted to the fullest extent of the law.

Minimum Communications Power Measurement

PCS 1900 band

PCL	0	1	2	3	4	5	6	7	8
Output power (dBm)	29.12	28.4	25.3	23.4	22.1	19.2	17.2	15.2	13

PCL	9	10	11	12	13	14	15
Output power (dBm)	11.1	9.8	7.5	4.3	2.4	1.5	0.1

Note: The EUT output power was controlled by simulator. Set Communication Tester [MT8820C](#) PCL as above, and get the mobile phone output power reading.

WCDMA/HSDPA/HSUPA band V

The EUT output power was controlled by simulator. Set Communication Tester [MT8820C](#) function key "UE Power Control" and enter max rated power 24dBm. The EUT is going to be set to max output power to 24dBm. Then record the read (see page 15 for measurement data). The min. power was measures by a function key "minimum power" then record the read. It is -52.3dBm. The power variation can be 0.1dB step by setting.

Unless otherwise stated the results shown in this test report refer only to the sample(s) tested and such sample(s) are retained for 90 days only.

除非另有說明，此報告結果僅對測試之樣品負責，同時此樣品僅保留90天。本報告未經本公司書面許可，不可部份複製。

This document is issued by the Company subject to its General Conditions of Service printed overleaf, available on request or accessible at www.sgs.com/terms_and_conditions.htm and, for electronic format documents, subject to Terms and Conditions for Electronic Documents at www.sgs.com/terms_e-document.htm. Attention is drawn to the limitation of liability, indemnification and jurisdiction issues defined therein. Any holder of this document is advised that information contained hereon reflects the Company's findings at the time of its intervention only and within the limits of Client's instructions, if any. The Company's sole responsibility is to its Client and this document does not exonerate parties to a transaction from exercising all their rights and obligations under the transaction documents. This document cannot be reproduced except in full, without prior written approval of the Company. Any unauthorized alteration, forgery or falsification of the content or appearance of this document is unlawful and offenders may be prosecuted to the fullest extent of the law.

SGS Taiwan Ltd.

No.134,WuKungRoad,NewTaipeiIndustrialPark,WukuDistrict,NewTaipeiCity,Taiwan24803/新北市五股區新北產業園區五工路 134 號

台灣檢驗科技股份有限公司

t (886-2) 2299-3279

f (886-2) 2298-0488

www.tw.sgs.com

Member of SGS Group

7. EFFECTIVE RADIATED POWER AND EQUIVALENT ISOTROPIC RADIATED POWER MEASUREMENT

7.1. Standard Applicable

According to FCC §2.1046

FCC 22.913(a) Mobile station is limited to 7W ERP.

FCC 24.232(c) Mobile and portable stations are limited to 2 W EIRP.

FCC 27, 50(h)(2) Mobile and other user stations. Mobile stations are limited to 2 W EIRP

FCC 27, 50(C)(10) Portable stations (hand-held devices) are limited to 3 W EIRP

7.2. Test SET-UP

(A) Radiated Power Test Set-Up, Frequency Below 1000MHz

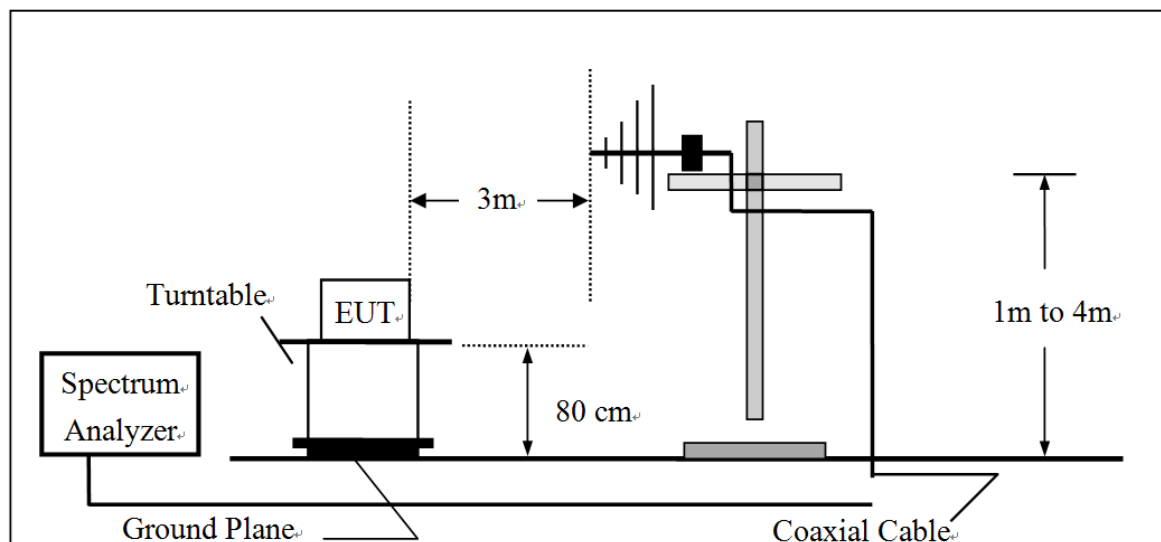

Unless otherwise stated the results shown in this test report refer only to the sample(s) tested and such sample(s) are retained for 90 days only.

除非另有說明，此報告結果僅對測試之樣品負責，同時此樣品僅保留90天。本報告未經本公司書面許可，不可部份複製。

This document is issued by the Company subject to its General Conditions of Service printed overleaf, available on request or accessible at www.sgs.com/terms_and_conditions.htm and, for electronic format documents, subject to Terms and Conditions for Electronic Documents at www.sgs.com/terms_e-document.htm. Attention is drawn to the limitation of liability, indemnification and jurisdiction issues defined therein. Any holder of this document is advised that information contained hereon reflects the Company's findings at the time of its intervention only and within the limits of Client's instructions, if any. The Company's sole responsibility is to its Client and this document does not exonerate parties to a transaction from exercising all their rights and obligations under the transaction documents. This document cannot be reproduced except in full, without prior written approval of the Company. Any unauthorized alteration, forgery or falsification of the content or appearance of this document is unlawful and offenders may be prosecuted to the fullest extent of the law.

(B) Radiated Power Test Set-UP Frequency Over 1 GHz

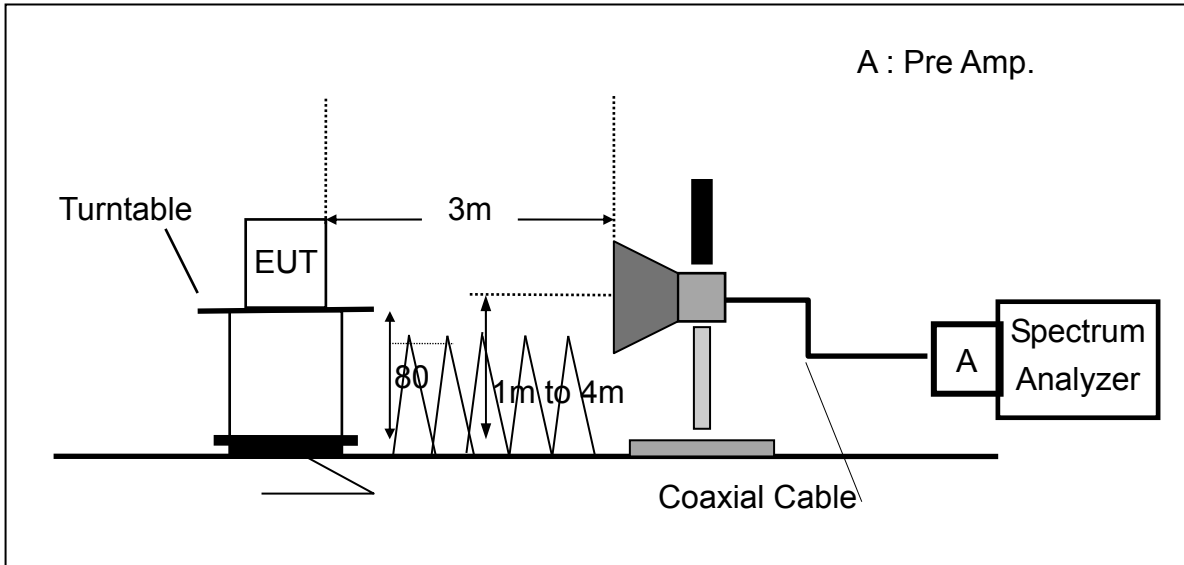

(C) Substituted Method Test Set-UP

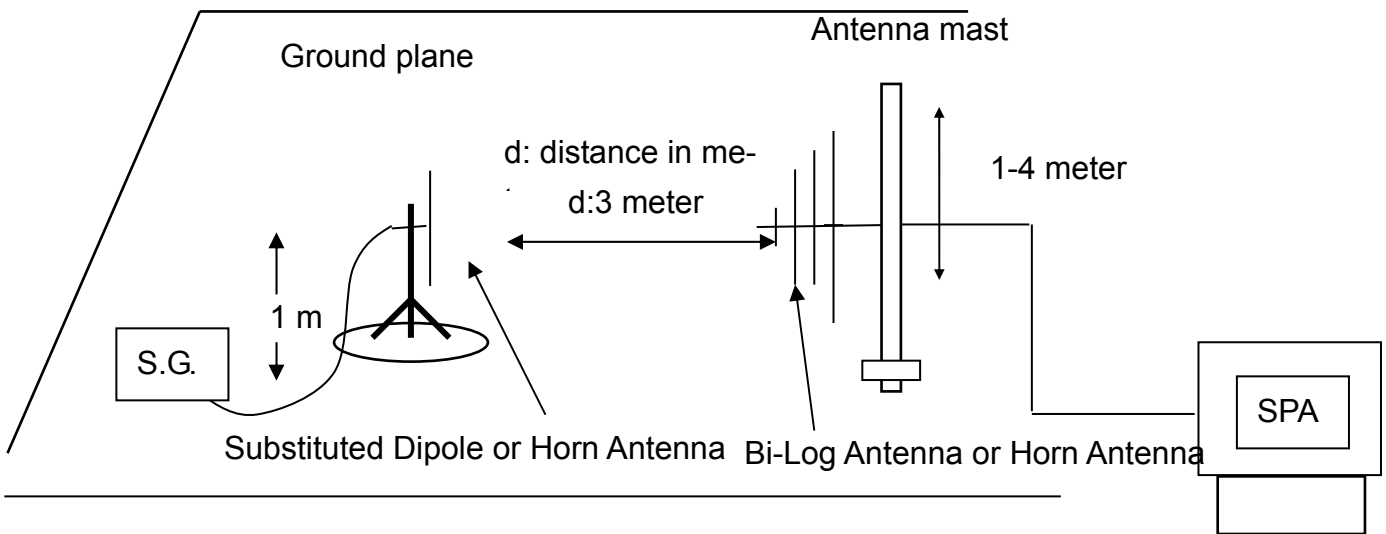

Unless otherwise stated the results shown in this test report refer only to the sample(s) tested and such sample(s) are retained for 90 days only.

除非另有說明，此報告結果僅對測試之樣品負責，同時此樣品僅保留90天。本報告未經本公司書面許可，不可部份複製。

This document is issued by the Company subject to its General Conditions of Service printed overleaf, available on request or accessible at www.sgs.com/terms_and_conditions.htm and, for electronic format documents, subject to Terms and Conditions for Electronic Documents at www.sgs.com/terms_e-document.htm. Attention is drawn to the limitation of liability, indemnification and jurisdiction issues defined therein. Any holder of this document is advised that information contained hereon reflects the Company's findings at the time of its intervention only and within the limits of Client's instructions, if any. The Company's sole responsibility is to its Client and this document does not exonerate parties to a transaction from exercising all their rights and obligations under the transaction documents. This document cannot be reproduced except in full, without prior written approval of the Company. Any unauthorized alteration, forgery or falsification of the content or appearance of this document is unlawful and offenders may be prosecuted to the fullest extent of the law.

7.3. Measurement Procedure

1. The testing follows the Measurement Procedure of FCC KDB 971168 D01
2. The EUT was placed on a non-conductive turntable using a non-conductive support. The radiated emission at the fundamental frequency was measured at 3 m with a test antenna and EMI spectrum analyzer.
3. During the measurement, the EUT was communication with the station. The highest emission was recorded with the rotation of the turntable and the lowering of the test antenna from 4m to 1m. The reading was recorded and the field strength (E in dBuV/m) was calculated
4. The testing follows the Measurement Procedure of FCC KDB 971168 D01
5. The substitution horn antenna is substituted for EUT at the same position and signals generator export the CW signal to the substitution antenna via a tx cable. Rotated the Turn Table and moved receiving antenna to find the maximum radiation power. Adjust output power level of S.G to get a Value of spectrum reading equal to "Read Value" of step b. Record the power level of S.G.
6. $ERP = S.G. \text{ output (dBm)} + \text{Antenna Gain (dBd)} - \text{Cable Loss (dB)}$
7. $ERP = S.G. \text{ output (dBm)} + \text{Antenna Gain (dBd)} - \text{Cable Loss (dB)}$
8. Spectrum setting:
 - (1) Detector = Peak, marker the highest value of the detector by maximum hold, set RBW wide enough to capture the entire signal of emission, and $VBW > = 3 \times RBW$.
 - (2) KDB 971168 D01 is adopted, and the procedure as lists under item 4, Measurement of the Average Power over the Fundamental Signal Bandwidth, is followed to set correspondingly for the acquisition of proper measurement data.
Set frequency = nominal signal center frequency;
Set span = 2 X occupied BW;
Set RBW \approx 1~5% of the span, not to exceed 1 MHz
Set VBW = 3 x RBW;
Select average power (RMS) detector
Set sweep time and number of measurement points to achieve a minimum of 1 millisecond/pt integration time (ex. Point = 601points, then sweep time = $601 \times 10^{-3} = 6s$).

Activate trace averaging routine over a minimum of 10 sweeps;

Activate marker/span pair and set span = signal or channel bandwidth;

Activate the band/interval power marker function;

Record the band power level;

Record adjusted value as the average signal power level. Then activate the occupied bandwidth measurement function.

The proper adjustment due to limitation of spectrum capability is given compensated to spectrum with conversion factor of $10 \times \log(TBW/RBW)$, where TBW is the transmission of UE exceeding the maximum BW UE can extends, and RBW is the resolution BW in UE.

Unless otherwise stated the results shown in this test report refer only to the sample(s) tested and such sample(s) are retained for 90 days only.

除非另有說明，此報告結果僅對測試之樣品負責，同時此樣品僅保留90天。本報告未經本公司書面許可，不可部份複製。

This document is issued by the Company subject to its General Conditions of Service printed overleaf, available on request or accessible at www.sgs.com/terms_and_conditions.htm and, for electronic format documents, subject to Terms and Conditions for Electronic Documents at www.sgs.com/terms_e-document.htm. Attention is drawn to the limitation of liability, indemnification and jurisdiction issues defined therein. Any holder of this document is advised that information contained hereon reflects the Company's findings at the time of its intervention only and within the limits of Client's instructions, if any. The Company's sole responsibility is to its Client and this document does not exonerate parties to a transaction from exercising all their rights and obligations under the transaction documents. This document cannot be reproduced except in full, without prior written approval of the Company. Any unauthorized alteration, forgery or falsification of the content or appearance of this document is unlawful and offenders may be prosecuted to the fullest extent of the law.

7.4. Measurement Equipment Used

ERP, EIRP MEASUREMENT EQUIPMENT List 966 Chamber					
EQUIPMENT TYPE	MFR	MODEL NUMBER	SERIAL NUMBER	LAST CAL.	CAL DUE.
EMI Test Receiver	R&S	ESCI7	100760	05/11/2017	05/10/2018
Spectrum Analyzer	Agilent	E4446A	MY51100003	04/25/2017	04/24/2018
Loop Antenna	ETS-Lindgren	6502	148045	09/20/2017	09/19/2018
Bilog Antenna	SCHWAZBECK	VULB9168	378	12/19/2017	12/18/2018
Horn Antenna	Schwarzbeck	BBHA9120D	1441	08/04/2017	08/03/2018
Pre-Amplifier	Agilent	8447D	2944A07676	01/03/2017	01/02/2018
Pre-Amplifier	EMC Instruments Corp.	EMC0126530	980038	01/03/2017	01/02/2018
Turn Table	HD	DT420	N/A	N.C.R	N.C.R
Antenna Tower	ChamPro	AM-BS-4500-B	060776-ABS	N.C.R	N.C.R
Controller	ChamPro	EM1000	60776	N.C.R	N.C.R
Low Loss Cable	Huber Suhner	966_RX	9	01/05/2017	01/04/2018
3m Site NSA	SGS	966 chamber	N/A	07/01/2017	06/30/2018
Low Loss Cable	Huber Suhner	966 TX	1	01/05/2017	01/04/2018
Horn Antenna	Schwarzbeck	BBHA9170	184	12/12/2017	12/11/2018
Pre-Amplifier	EMC Instruments Corp.	EMC184045	980135	01/05/2017	01/04/2018
Radio Communication Analyzer	R&S	CMU200	102189	02/11/2017	02/10/2018
Radio Communication Analyer	Anritsu	MT8820C	6201465317	01/03/2017	01/02/2018

Unless otherwise stated the results shown in this test report refer only to the sample(s) tested and such sample(s) are retained for 90 days only.

除非另有說明，此報告結果僅對測試之樣品負責，同時此樣品僅保留90天。本報告未經本公司書面許可，不可部份複製。

This document is issued by the Company subject to its General Conditions of Service printed overleaf, available on request or accessible at www.sgs.com/terms_and_conditions.htm and, for electronic format documents, subject to Terms and Conditions for Electronic Documents at www.sgs.com/terms_e-document.htm. Attention is drawn to the limitation of liability, indemnification and jurisdiction issues defined therein. Any holder of this document is advised that information contained hereon reflects the Company's findings at the time of its intervention only and within the limits of Client's instructions, if any. The Company's sole responsibility is to its Client and this document does not exonerate parties to a transaction from exercising all their rights and obligations under the transaction documents. This document cannot be reproduced except in full, without prior written approval of the Company. Any unauthorized alteration, forgery or falsification of the content or appearance of this document is unlawful and offenders may be prosecuted to the fullest extent of the law.

SGS Taiwan Ltd.

No.134,WuKungRoad,NewTaipeiIndustrialPark,WukuDistrict,NewTaipeiCity,Taiwan24803/新北市五股區新北產業園區五工路 134 號

台灣檢驗科技股份有限公司

t (886-2) 2299-3279

f (886-2) 2298-0488

www.tw.sgs.com

Member of SGS Group

7.5. Measurement Result: (Peak) –using option of peak measurement

EUT			Measurement					
Operation Band	Fundamental Frequency	CH	Antenna Pol.	S.G. Output	Antenna Gain	Cable Loss	ERP	Limit
	MHz		V/H	dBm	dBd	dB	dBm	dBm
GSM 850	824.2	128	V	20.36	3.31	-2.92	20.75	38.45
			H	18.97	3.31	-2.92	19.36	38.45
	836.6	190	V	20.77	3.29	-2.96	21.10	38.45
			H	17.59	3.29	-2.96	17.92	38.45
	848.8	251	V	18.31	3.27	-3.00	18.58	38.45
			H	16.96	3.27	-3.00	17.23	38.45
GPRS 850	824.2	128	V	21.44	3.31	-2.92	21.83	38.45
			H	20.26	3.31	-2.92	20.65	38.45
	836.6	190	V	21.60	3.29	-2.96	21.93	38.45
			H	19.36	3.29	-2.96	19.69	38.45
	848.8	251	V	20.07	3.27	-3.00	20.34	38.45
			H	18.93	3.27	-3.00	19.20	38.45

Remark: The RBW,VBW of SPA for frequency RBW=300 KHz, VBW=1MHz

Unless otherwise stated the results shown in this test report refer only to the sample(s) tested and such sample(s) are retained for 90 days only.

除非另有說明，此報告結果僅對測試之樣品負責，同時此樣品僅保留90天。本報告未經本公司書面許可，不可部份複製。

This document is issued by the Company subject to its General Conditions of Service printed overleaf, available on request or accessible at www.sgs.com/terms_and_conditions.htm and, for electronic format documents, subject to Terms and Conditions for Electronic Documents at www.sgs.com/terms_e-document.htm. Attention is drawn to the limitation of liability, indemnification and jurisdiction issues defined therein. Any holder of this document is advised that information contained hereon reflects the Company's findings at the time of its intervention only and within the limits of Client's instructions, if any. The Company's sole responsibility is to its Client and this document does not exonerate parties to a transaction from exercising all their rights and obligations under the transaction documents. This document cannot be reproduced except in full, without prior written approval of the Company. Any unauthorized alteration, forgery or falsification of the content or appearance of this document is unlawful and offenders may be prosecuted to the fullest extent of the law.

SGS Taiwan Ltd.

No.134,WuKungRoad,NewTaipeiIndustrialPark,WukuDistrict,NewTaipeiCity,Taiwan24803/新北市五股區新北產業園區五工路 134 號

台灣檢驗科技股份有限公司

t (886-2) 2299-3279

f (886-2) 2298-0488

www.tw.sgs.com

Member of SGS Group

EUT			Measurement					
Operation Band	Fundamental Frequency	CH	Antenna Pol.	S.G. Output	Antenna Gain	Cable Loss	ERP	Limit
	MHz		V/H	dBm	dBd	dB	dBm	dBm
GSM 1900	1850.2	512	V	12.97	9.94	-4.46	18.45	33.00
			H	10.79	9.94	-4.46	16.27	33.00
	1880.0	661	V	13.29	10.03	-4.51	18.81	33.00
			H	8.68	10.03	-4.51	14.20	33.00
	1909.8	810	V	12.45	10.13	-4.55	18.03	33.00
			H	13.12	10.13	-4.55	18.70	33.00
GPRS 1900	1850.2	512	V	14.52	9.94	-4.46	20.00	33.00
			H	13.97	9.94	-4.46	19.45	33.00
	1880.0	661	V	13.66	10.03	-4.51	19.18	33.00
			H	10.90	10.03	-4.51	16.42	33.00
	1909.8	810	V	12.82	10.13	-4.55	18.40	33.00
			H	13.46	10.13	-4.55	19.04	33.00

Remark: The RBW,VBW of SPA for frequency RBW=300 KHz, VBW=1MHz

Unless otherwise stated the results shown in this test report refer only to the sample(s) tested and such sample(s) are retained for 90 days only.

除非另有說明，此報告結果僅對測試之樣品負責，同時此樣品僅保留90天。本報告未經本公司書面許可，不可部份複製。

This document is issued by the Company subject to its General Conditions of Service printed overleaf, available on request or accessible at www.sgs.com/terms_and_conditions.htm and, for electronic format documents, subject to Terms and Conditions for Electronic Documents at www.sgs.com/terms_e-document.htm. Attention is drawn to the limitation of liability, indemnification and jurisdiction issues defined therein. Any holder of this document is advised that information contained hereon reflects the Company's findings at the time of its intervention only and within the limits of Client's instructions, if any. The Company's sole responsibility is to its Client and this document does not exonerate parties to a transaction from exercising all their rights and obligations under the transaction documents. This document cannot be reproduced except in full, without prior written approval of the Company. Any unauthorized alteration, forgery or falsification of the content or appearance of this document is unlawful and offenders may be prosecuted to the fullest extent of the law.

SGS Taiwan Ltd.

No.134,WuKungRoad,NewTaipeiIndustrialPark,WukuDistrict,NewTaipeiCity,Taiwan24803/新北市五股區新北產業園區五工路 134 號

台灣檢驗科技股份有限公司

t (886-2) 2299-3279

f (886-2) 2298-0488

www.tw.sgs.com

Member of SGS Group

EUT			Measurement					
Operation Band	Fundamental Frequency	CH	Antenna Pol.	S.G. Output	Antenna Gain	Cable Loss	ERP	Limit
	MHz		V/H	dBm	dBd	dB	dBm	dBm
WCDMA Band V	826.4	4132	V	15.04	3.30	-2.93	15.41	38.45
			H	13.94	3.30	-2.93	14.31	38.45
	836.6	4183	V	12.09	3.29	-2.96	12.42	38.45
			H	12.76	3.29	-2.96	13.09	38.45
	846.6	4233	V	11.94	3.27	-3.00	12.21	38.45
			H	11.39	3.27	-2.99	11.67	38.45
HSDPA Band V	826.4	4132	V	15.22	3.30	-2.93	15.59	38.45
			H	13.91	3.30	-2.93	14.28	38.45
	836.6	4183	V	11.90	3.29	-2.96	12.23	38.45
			H	11.35	3.29	-2.96	11.68	38.45
	846.6	4233	V	12.36	3.28	-2.99	12.65	38.45
			H	11.12	3.27	-3.00	11.39	38.45
HSUPA Band V	826.4	4132	V	14.56	3.30	-2.93	14.93	38.45
			H	12.55	3.30	-2.93	12.92	38.45
	836.6	4183	V	11.84	3.29	-2.96	12.17	38.45
			H	11.66	3.29	-2.97	11.98	38.45
	846.6	4233	V	11.14	3.27	-3.00	11.41	38.45
			H	10.50	3.27	-2.99	10.78	38.45

Remark: The RBW,VBW of SPA for frequency RBW=5 MHz, VBW=8 MHz

Unless otherwise stated the results shown in this test report refer only to the sample(s) tested and such sample(s) are retained for 90 days only.

除非另有說明，此報告結果僅對測試之樣品負責，同時此樣品僅保留90天。本報告未經本公司書面許可，不可部份複製。

This document is issued by the Company subject to its General Conditions of Service printed overleaf, available on request or accessible at www.sgs.com/terms_and_conditions.htm and, for electronic format documents, subject to Terms and Conditions for Electronic Documents at www.sgs.com/terms_e-document.htm. Attention is drawn to the limitation of liability, indemnification and jurisdiction issues defined therein. Any holder of this document is advised that information contained hereon reflects the Company's findings at the time of its intervention only and within the limits of Client's instructions, if any. The Company's sole responsibility is to its Client and this document does not exonerate parties to a transaction from exercising all their rights and obligations under the transaction documents. This document cannot be reproduced except in full, without prior written approval of the Company. Any unauthorized alteration, forgery or falsification of the content or appearance of this document is unlawful and offenders may be prosecuted to the fullest extent of the law.

SGS Taiwan Ltd.

No.134,WuKungRoad,NewTaipeiIndustrialPark,WukuDistrict,NewTaipeiCity,Taiwan24803/新北市五股區新北產業園區五工路 134 號

台灣檢驗科技股份有限公司

t (886-2) 2299-3279

f (886-2) 2298-0488

www.tw.sgs.com

Member of SGS Group

EUT			Measurement					
Operation Band	Fundamental Frequency MHz	CH	Antenna Pol. V/H	S.G. Output dBm	Antenna Gain dBi	Cable Loss dB	EIRP dBm	Limit dBm
BAND 5 BW: 1.4M QPSK RB: 1,0	824.7	20407	V	15.56	3.30	-2.93	15.93	38.45
			H	13.42	3.30	-2.93	13.79	38.45
	836.5	20525	V	15.29	3.29	-2.96	15.62	38.45
			H	11.30	3.29	-2.96	11.63	38.45
	848.3	20643	V	12.73	3.27	-3.00	13.00	38.45
			H	8.82	3.27	-2.99	9.10	38.45
BAND 5 BW: 1.4M QPSK RB: 1,5	824.7	20407	V	15.43	3.31	-2.92	15.82	38.45
			H	12.94	3.30	-2.93	13.31	38.45
	836.5	20525	V	14.55	3.29	-2.96	14.88	38.45
			H	11.59	3.29	-2.96	11.92	38.45
	848.3	20643	V	12.36	3.27	-3.00	12.63	38.45
			H	8.41	3.27	-3.00	8.68	38.45
BAND 5 BW: 1.4M 16QAM RB: 1,0	824.7	20407	V	15.15	3.30	-2.93	15.52	38.45
			H	12.05	3.30	-2.93	12.42	38.45
	836.5	20525	V	12.90	3.29	-2.96	13.23	38.45
			H	9.89	3.29	-2.96	10.22	38.45
	848.3	20643	V	11.79	3.27	-3.00	12.06	38.45
			H	7.97	3.27	-2.99	8.25	38.45
BAND 5 BW: 1.4M 16QAM RB: 1,5	824.7	20407	V	14.70	3.31	-2.92	15.09	38.45
			H	11.77	3.30	-2.93	12.14	38.45
	836.5	20525	V	13.15	3.29	-2.96	13.48	38.45
			H	10.16	3.29	-2.96	10.49	38.45
	848.3	20643	V	12.31	3.27	-3.00	12.58	38.45
			H	8.86	3.27	-3.00	9.13	38.45

The RBW,VBW of SPA for frequency RBW= 8MHz , VBW= 8MHz

Unless otherwise stated the results shown in this test report refer only to the sample(s) tested and such sample(s) are retained for 90 days only.

除非另有說明，此報告結果僅對測試之樣品負責，同時此樣品僅保留90天。本報告未經本公司書面許可，不可部份複製。

This document is issued by the Company subject to its General Conditions of Service printed overleaf, available on request or accessible at www.sgs.com/terms_and_conditions.htm and, for electronic format documents, subject to Terms and Conditions for Electronic Documents at www.sgs.com/terms_e-document.htm. Attention is drawn to the limitation of liability, indemnification and jurisdiction issues defined therein. Any holder of this document is advised that information contained hereon reflects the Company's findings at the time of its intervention only and within the limits of Client's instructions, if any. The Company's sole responsibility is to its Client and this document does not exonerate parties to a transaction from exercising all their rights and obligations under the transaction documents. This document cannot be reproduced except in full, without prior written approval of the Company. Any unauthorized alteration, forgery or falsification of the content or appearance of this document is unlawful and offenders may be prosecuted to the fullest extent of the law.

SGS Taiwan Ltd.

No.134,WuKungRoad,NewTaipeiIndustrialPark,WukuDistrict,NewTaipeiCity,Taiwan24803/新北市五股區新北產業園區五工路 134 號

台灣檢驗科技股份有限公司

t (886-2) 2299-3279

f (886-2) 2298-0488

www.tw.sgs.com

Member of SGS Group

EUT			Measurement					
Operation Band	Fundamental Frequency MHz	CH	Antenna Pol. V/H	S.G. Output dBm	Antenna Gain dBi	Cable Loss dB	EIRP dBm	Limit dBm
BAND 5 BW: 3M QPSK RB: 1,0	825.5	20415	V	16.39	3.30	-2.93	16.76	38.45
			H	13.36	3.30	-2.93	13.73	38.45
	836.5	20525	V	14.63	3.29	-2.95	14.97	38.45
			H	11.57	3.29	-2.95	11.91	38.45
	847.5	20635	V	11.28	3.28	-2.99	11.57	38.45
			H	8.98	3.28	-2.99	9.27	38.45
BAND 5 BW: 3M QPSK RB: 1,14	825.5	20415	V	15.52	3.30	-2.93	15.89	38.45
			H	13.58	3.30	-2.93	13.95	38.45
	836.5	20525	V	14.21	3.29	-2.96	14.54	38.45
			H	11.12	3.29	-2.96	11.45	38.45
	847.5	20635	V	11.92	3.27	-3.00	12.19	38.45
			H	8.96	3.27	-3.00	9.23	38.45
BAND 5 BW: 3M 16QAM RB: 1,0	825.5	20415	V	15.63	3.30	-2.93	16.00	38.45
			H	13.08	3.30	-2.93	13.45	38.45
	836.5	20525	V	13.17	3.29	-2.95	13.51	38.45
			H	10.54	3.29	-2.95	10.88	38.45
	847.5	20635	V	11.70	3.28	-2.99	11.99	38.45
			H	8.80	3.28	-2.99	9.09	38.45
BAND 5 BW: 3M 16QAM RB: 1,14	825.5	20415	V	14.85	3.30	-2.93	15.22	38.45
			H	12.69	3.30	-2.93	13.06	38.45
	836.5	20525	V	12.74	3.29	-2.96	13.07	38.45
			H	10.30	3.29	-2.96	10.63	38.45
	847.5	20635	V	11.24	3.27	-3.00	11.51	38.45
			H	9.06	3.27	-3.00	9.33	38.45

The RBW,VBW of SPA for frequency RBW= 8MHz , VBW= 8MHz

Unless otherwise stated the results shown in this test report refer only to the sample(s) tested and such sample(s) are retained for 90 days only.

除非另有說明，此報告結果僅對測試之樣品負責，同時此樣品僅保留90天。本報告未經本公司書面許可，不可部份複製。

This document is issued by the Company subject to its General Conditions of Service printed overleaf, available on request or accessible at www.sgs.com/terms_and_conditions.htm and, for electronic format documents, subject to Terms and Conditions for Electronic Documents at www.sgs.com/terms_e-document.htm. Attention is drawn to the limitation of liability, indemnification and jurisdiction issues defined therein. Any holder of this document is advised that information contained hereon reflects the Company's findings at the time of its intervention only and within the limits of Client's instructions, if any. The Company's sole responsibility is to its Client and this document does not exonerate parties to a transaction from exercising all their rights and obligations under the transaction documents. This document cannot be reproduced except in full, without prior written approval of the Company. Any unauthorized alteration, forgery or falsification of the content or appearance of this document is unlawful and offenders may be prosecuted to the fullest extent of the law.

SGS Taiwan Ltd.

No.134,WuKungRoad,NewTaipeiIndustrialPark,WukuDistrict,NewTaipeiCity,Taiwan24803/新北市五股區新北產業園區五工路 134 號

台灣檢驗科技股份有限公司

t (886-2) 2299-3279

f (886-2) 2298-0488

www.tw.sgs.com

Member of SGS Group

EUT			Measurement					
Operation Band	Fundamental Frequency MHz	CH	Antenna Pol. V/H	S.G. Output dBm	Antenna Gain dBi	Cable Loss dB	EIRP dBm	Limit dBm
BAND 5 BW: 5M QPSK RB: 1,0	826.5	20425	V	15.44	3.30	-2.93	15.81	38.45
			H	13.56	3.30	-2.93	13.93	38.45
	836.5	20525	V	14.38	3.29	-2.95	14.72	38.45
			H	11.93	3.29	-2.95	12.27	38.45
	846.5	20625	V	11.54	3.28	-2.98	11.84	38.45
			H	8.90	3.28	-2.98	9.20	38.45
BAND 5 BW: 5M QPSK RB: 1,24	826.5	20425	V	15.16	3.30	-2.93	15.53	38.45
			H	12.14	3.30	-2.93	12.51	38.45
	836.5	20525	V	13.28	3.29	-2.96	13.61	38.45
			H	11.21	3.29	-2.96	11.54	38.45
	846.5	20625	V	11.70	3.27	-3.00	11.97	38.45
			H	9.38	3.27	-3.00	9.65	38.45
BAND 5 BW: 5M 16QAM RB: 1,0	826.5	20425	V	14.90	3.30	-2.93	15.27	38.45
			H	12.25	3.30	-2.93	12.62	38.45
	836.5	20525	V	13.07	3.29	-2.95	13.41	38.45
			H	10.26	3.29	-2.95	10.60	38.45
	846.5	20625	V	11.07	3.28	-2.98	11.37	38.45
			H	8.85	3.28	-2.98	9.15	38.45
BAND 5 BW: 5M 16QAM RB: 1,24	826.5	20425	V	14.87	3.30	-2.93	15.24	38.45
			H	12.32	3.30	-2.93	12.69	38.45
	836.5	20525	V	12.51	3.29	-2.97	12.83	38.45
			H	10.16	3.29	-2.97	10.48	38.45
	846.5	20625	V	11.75	3.27	-3.00	12.02	38.45
			H	8.57	3.27	-3.00	8.84	38.45

The RBW,VBW of SPA for frequency RBW= 8MHz , VBW= 8MHz

Unless otherwise stated the results shown in this test report refer only to the sample(s) tested and such sample(s) are retained for 90 days only.

除非另有說明，此報告結果僅對測試之樣品負責，同時此樣品僅保留90天。本報告未經本公司書面許可，不可部份複製。

This document is issued by the Company subject to its General Conditions of Service printed overleaf, available on request or accessible at www.sgs.com/terms_and_conditions.htm and, for electronic format documents, subject to Terms and Conditions for Electronic Documents at www.sgs.com/terms_e-document.htm. Attention is drawn to the limitation of liability, indemnification and jurisdiction issues defined therein. Any holder of this document is advised that information contained hereon reflects the Company's findings at the time of its intervention only and within the limits of Client's instructions, if any. The Company's sole responsibility is to its Client and this document does not exonerate parties to a transaction from exercising all their rights and obligations under the transaction documents. This document cannot be reproduced except in full, without prior written approval of the Company. Any unauthorized alteration, forgery or falsification of the content or appearance of this document is unlawful and offenders may be prosecuted to the fullest extent of the law.

SGS Taiwan Ltd.

No.134,WuKungRoad,NewTaipeiIndustrialPark,WukuDistrict,NewTaipeiCity,Taiwan24803/新北市五股區新北產業園區五工路 134 號

台灣檢驗科技股份有限公司

t (886-2) 2299-3279

f (886-2) 2298-0488

www.tw.sgs.com

Member of SGS Group

EUT			Measurement					
Operation Band	Fundamental Frequency MHz	CH	Antenna Pol. V/H	S.G. Output dBm	Antenna Gain dBi	Cable Loss dB	EIRP dBm	Limit dBm
BAND 5 BW: 10M QPSK RB: 1,0	829.0	20450	V	16.22	3.30	-2.93	16.59	38.45
			H	13.25	3.30	-2.93	13.62	38.45
	836.5	20525	V	13.86	3.30	-2.94	14.22	38.45
			H	11.58	3.30	-2.94	11.94	38.45
	844.0	20600	V	12.86	3.29	-2.97	13.18	38.45
			H	10.46	3.28	-2.98	10.76	38.45
BAND 5 BW: 10M QPSK RB: 1,49	829.0	20450	V	13.81	3.29	-2.95	14.15	38.45
			H	11.67	3.29	-2.95	12.01	38.45
	836.5	20525	V	12.94	3.28	-2.97	13.25	38.45
			H	10.82	3.28	-2.98	11.12	38.45
	844.0	20600	V	12.35	3.27	-3.00	12.62	38.45
			H	8.96	3.27	-3.00	9.23	38.45
BAND 5 BW: 10M 16QAM RB: 1,0	829.0	20450	V	14.93	3.30	-2.93	15.30	38.45
			H	12.59	3.30	-2.93	12.96	38.45
	836.5	20525	V	13.47	3.30	-2.94	13.83	38.45
			H	11.30	3.30	-2.94	11.66	38.45
	844.0	20600	V	12.67	3.29	-2.97	12.99	38.45
			H	10.01	3.28	-2.98	10.31	38.45
BAND 5 BW: 10M 16QAM RB: 1,49	829.0	20450	V	13.23	3.29	-2.95	13.57	38.45
			H	10.92	3.29	-2.95	11.26	38.45
	836.5	20525	V	12.01	3.28	-2.97	12.32	38.45
			H	9.43	3.28	-2.98	9.73	38.45
	844.0	20600	V	12.12	3.27	-3.00	12.39	38.45
			H	8.69	3.27	-3.00	8.96	38.45

The RBW,VBW of SPA for frequency RBW= 8MHz , VBW= 8MHz

Unless otherwise stated the results shown in this test report refer only to the sample(s) tested and such sample(s) are retained for 90 days only.

除非另有說明，此報告結果僅對測試之樣品負責，同時此樣品僅保留90天。本報告未經本公司書面許可，不可部份複製。

This document is issued by the Company subject to its General Conditions of Service printed overleaf, available on request or accessible at www.sgs.com/terms_and_conditions.htm and, for electronic format documents, subject to Terms and Conditions for Electronic Documents at www.sgs.com/terms_e-document.htm. Attention is drawn to the limitation of liability, indemnification and jurisdiction issues defined therein. Any holder of this document is advised that information contained hereon reflects the Company's findings at the time of its intervention only and within the limits of Client's instructions, if any. The Company's sole responsibility is to its Client and this document does not exonerate parties to a transaction from exercising all their rights and obligations under the transaction documents. This document cannot be reproduced except in full, without prior written approval of the Company. Any unauthorized alteration, forgery or falsification of the content or appearance of this document is unlawful and offenders may be prosecuted to the fullest extent of the law.

SGS Taiwan Ltd.

No.134,WuKungRoad,NewTaipeiIndustrialPark,WukuDistrict,NewTaipeiCity,Taiwan24803/新北市五股區新北產業園區五工路 134 號

台灣檢驗科技股份有限公司

t (886-2) 2299-3279

f (886-2) 2298-0488

www.tw.sgs.com

Member of SGS Group

EUT			Measurement					
Operation Band	Fundamental Frequency MHz	CH	Antenna Pol. V/H	S.G. Output dBm	Antenna Gain dBi	Cable Loss dB	EIRP dBm	Limit dBm
BAND 12 BW: 1.4M QPSK RB: 1,0	699.7	23017	V	6.17	3.08	-2.96	6.29	34.77
			H	-1.80	3.08	-2.96	-1.68	34.77
	707.5	23095	V	7.61	3.09	-3.04	7.66	34.77
			H	0.24	3.09	-3.04	0.29	34.77
	715.3	23173	V	8.43	3.11	-3.06	8.48	34.77
			H	1.62	3.11	-3.06	1.67	34.77
BAND 12 BW: 1.4M QPSK RB: 1,5	699.7	23017	V	6.52	3.08	-2.96	6.64	34.77
			H	-1.33	3.08	-2.96	-1.21	34.77
	707.5	23095	V	6.44	3.09	-3.04	6.49	34.77
			H	-0.14	3.09	-3.04	-0.09	34.77
	715.3	23173	V	7.20	3.11	-3.06	7.25	34.77
			H	1.05	3.11	-3.06	1.10	34.77
BAND 12 BW: 1.4M 16QAM RB: 1,0	699.7	23017	V	5.65	3.08	-2.96	5.77	34.77
			H	-1.83	3.08	-2.96	-1.71	34.77
	707.5	23095	V	7.43	3.09	-3.04	7.48	34.77
			H	0.18	3.09	-3.04	0.23	34.77
	715.3	23173	V	7.68	3.11	-3.06	7.73	34.77
			H	1.52	3.11	-3.06	1.57	34.77
BAND 12 BW: 1.4M 16QAM RB: 1,5	699.7	23017	V	6.70	3.08	-2.96	6.82	34.77
			H	-1.25	3.08	-2.96	-1.13	34.77
	707.5	23095	V	6.62	3.09	-3.04	6.67	34.77
			H	-0.65	3.09	-3.04	-0.60	34.77
	715.3	23173	V	6.74	3.11	-3.06	6.79	34.77
			H	0.71	3.11	-3.06	0.76	34.77

The RBW,VBW of SPA for frequency RBW= 8MHz , VBW= 8MHz

Unless otherwise stated the results shown in this test report refer only to the sample(s) tested and such sample(s) are retained for 90 days only.

除非另有說明，此報告結果僅對測試之樣品負責，同時此樣品僅保留90天。本報告未經本公司書面許可，不可部份複製。

This document is issued by the Company subject to its General Conditions of Service printed overleaf, available on request or accessible at www.sgs.com/terms_and_conditions.htm and, for electronic format documents, subject to Terms and Conditions for Electronic Documents at www.sgs.com/terms_e-document.htm. Attention is drawn to the limitation of liability, indemnification and jurisdiction issues defined therein. Any holder of this document is advised that information contained hereon reflects the Company's findings at the time of its intervention only and within the limits of Client's instructions, if any. The Company's sole responsibility is to its Client and this document does not exonerate parties to a transaction from exercising all their rights and obligations under the transaction documents. This document cannot be reproduced except in full, without prior written approval of the Company. Any unauthorized alteration, forgery or falsification of the content or appearance of this document is unlawful and offenders may be prosecuted to the fullest extent of the law.

SGS Taiwan Ltd.

No.134,WuKungRoad,NewTaipeiIndustrialPark,WukuDistrict,NewTaipeiCity,Taiwan24803/新北市五股區新北產業園區五工路 134 號

台灣檢驗科技股份有限公司

t (886-2) 2299-3279

f (886-2) 2298-0488

www.tw.sgs.com

Member of SGS Group

EUT			Measurement					
Operation Band	Fundamental Frequency MHz	CH	Antenna Pol. V/H	S.G. Output dBm	Antenna Gain dBi	Cable Loss dB	EIRP dBm	Limit dBm
BAND 12 BW: 3M QPSK RB: 1,0	700.5	23025	V	5.93	3.08	-2.96	6.05	34.77
			H	-2.24	3.08	-2.96	-2.12	34.77
	707.5	23095	V	7.37	3.09	-3.04	7.42	34.77
			H	0.96	3.09	-3.03	1.02	34.77
	714.5	23165	V	7.31	3.11	-3.06	7.36	34.77
			H	1.65	3.11	-3.06	1.70	34.77
BAND 12 BW: 3M QPSK RB: 1,14	700.5	23025	V	8.25	3.08	-2.98	8.35	34.77
			H	-0.06	3.08	-2.98	0.04	34.77
	707.5	23095	V	6.27	3.10	-3.04	6.33	34.77
			H	-0.71	3.10	-3.04	-0.65	34.77
	714.5	23165	V	6.31	3.11	-3.06	6.36	34.77
			H	1.15	3.11	-3.06	1.20	34.77
BAND 12 BW: 3M 16QAM RB: 1,0	700.5	23025	V	5.37	3.08	-2.96	5.49	34.77
			H	-2.14	3.08	-2.96	-2.02	34.77
	707.5	23095	V	7.86	3.09	-3.03	7.92	34.77
			H	0.34	3.09	-3.04	0.39	34.77
	714.5	23165	V	6.71	3.11	-3.06	6.76	34.77
			H	1.53	3.11	-3.06	1.58	34.77
BAND 12 BW: 3M 16QAM RB: 1,14	700.5	23025	V	7.61	3.08	-2.97	7.72	34.77
			H	0.28	3.08	-2.98	0.38	34.77
	707.5	23095	V	6.27	3.10	-3.04	6.33	34.77
			H	-0.83	3.10	-3.04	-0.77	34.77
	714.5	23165	V	6.54	3.11	-3.06	6.59	34.77
			H	1.61	3.11	-3.06	1.66	34.77

The RBW,VBW of SPA for frequency RBW= 8MHz , VBW= 8MHz

Unless otherwise stated the results shown in this test report refer only to the sample(s) tested and such sample(s) are retained for 90 days only.

除非另有說明，此報告結果僅對測試之樣品負責，同時此樣品僅保留90天。本報告未經本公司書面許可，不可部份複製。

This document is issued by the Company subject to its General Conditions of Service printed overleaf, available on request or accessible at www.sgs.com/terms_and_conditions.htm and, for electronic format documents, subject to Terms and Conditions for Electronic Documents at www.sgs.com/terms_e-document.htm. Attention is drawn to the limitation of liability, indemnification and jurisdiction issues defined therein. Any holder of this document is advised that information contained hereon reflects the Company's findings at the time of its intervention only and within the limits of Client's instructions, if any. The Company's sole responsibility is to its Client and this document does not exonerate parties to a transaction from exercising all their rights and obligations under the transaction documents. This document cannot be reproduced except in full, without prior written approval of the Company. Any unauthorized alteration, forgery or falsification of the content or appearance of this document is unlawful and offenders may be prosecuted to the fullest extent of the law.

SGS Taiwan Ltd.

No.134,WuKungRoad,NewTaipeiIndustrialPark,WukuDistrict,NewTaipeiCity,Taiwan24803/新北市五股區新北產業園區五工路134號

台灣檢驗科技股份有限公司

t (886-2) 2299-3279

f (886-2) 2298-0488

www.tw.sgs.com

Member of SGS Group

EUT			Measurement					
Operation Band	Fundamental Frequency MHz	CH	Antenna Pol. V/H	S.G. Output dBm	Antenna Gain dBi	Cable Loss dB	EIRP dBm	Limit dBm
BAND 12 BW: 5M QPSK RB: 1,0	701.5	23035	V	5.42	3.08	-2.96	5.54	34.77
			H	-1.70	3.08	-2.96	-1.58	34.77
	707.5	23095	V	8.32	3.09	-3.03	8.38	34.77
			H	0.35	3.09	-3.03	0.41	34.77
	713.5	23155	V	5.85	3.10	-3.05	5.90	34.77
			H	0.20	3.10	-3.05	0.25	34.77
BAND 12 BW: 5M QPSK RB: 1,24	701.5	23035	V	7.63	3.09	-3.01	7.71	34.77
			H	0.81	3.09	-3.01	0.89	34.77
	707.5	23095	V	6.06	3.10	-3.04	6.12	34.77
			H	-0.97	3.10	-3.05	-0.92	34.77
	713.5	23155	V	6.59	3.11	-3.06	6.64	34.77
			H	1.72	3.11	-3.06	1.77	34.77
BAND 12 BW: 5M 16QAM RB: 1,0	701.5	23035	V	5.32	3.08	-2.96	5.44	34.77
			H	-2.63	3.08	-2.96	-2.51	34.77
	707.5	23095	V	7.52	3.09	-3.03	7.58	34.77
			H	-0.41	3.09	-3.03	-0.35	34.77
	713.5	23155	V	5.91	3.10	-3.05	5.96	34.77
			H	-0.79	3.10	-3.05	-0.74	34.77
BAND 12 BW: 5M 16QAM RB: 1,24	701.5	23035	V	7.71	3.09	-3.01	7.79	34.77
			H	0.03	3.09	-3.01	0.11	34.77
	707.5	23095	V	5.71	3.10	-3.05	5.76	34.77
			H	-1.21	3.10	-3.04	-1.15	34.77
	713.5	23155	V	6.48	3.11	-3.06	6.53	34.77
			H	1.39	3.11	-3.06	1.44	34.77

The RBW,VBW of SPA for frequency RBW= 8MHz , VBW= 8MHz

Unless otherwise stated the results shown in this test report refer only to the sample(s) tested and such sample(s) are retained for 90 days only.

除非另有說明，此報告結果僅對測試之樣品負責，同時此樣品僅保留90天。本報告未經本公司書面許可，不可部份複製。

This document is issued by the Company subject to its General Conditions of Service printed overleaf, available on request or accessible at www.sgs.com/terms_and_conditions.htm and, for electronic format documents, subject to Terms and Conditions for Electronic Documents at www.sgs.com/terms_e-document.htm. Attention is drawn to the limitation of liability, indemnification and jurisdiction issues defined therein. Any holder of this document is advised that information contained hereon reflects the Company's findings at the time of its intervention only and within the limits of Client's instructions, if any. The Company's sole responsibility is to its Client and this document does not exonerate parties to a transaction from exercising all their rights and obligations under the transaction documents. This document cannot be reproduced except in full, without prior written approval of the Company. Any unauthorized alteration, forgery or falsification of the content or appearance of this document is unlawful and offenders may be prosecuted to the fullest extent of the law.

SGS Taiwan Ltd.

No.134,WuKungRoad,NewTaipeiIndustrialPark,WukuDistrict,NewTaipeiCity,Taiwan24803/新北市五股區新北產業園區五工路 134 號

台灣檢驗科技股份有限公司

t (886-2) 2299-3279

f (886-2) 2298-0488

www.tw.sgs.com

Member of SGS Group

EUT			Measurement					
Operation Band	Fundamental Frequency MHz	CH	Antenna Pol. V/H	S.G. Output dBm	Antenna Gain dBi	Cable Loss dB	EIRP dBm	Limit dBm
BAND 12 BW: 10M QPSK RB: 1,0	704.0	23060	V	6.44	3.08	-2.96	6.56	34.77
			H	-2.01	3.08	-2.96	-1.89	34.77
	707.5	23095	V	7.02	3.08	-3.00	7.10	34.77
			H	0.55	3.08	-3.00	0.63	34.77
	711.0	23130	V	7.18	3.09	-3.04	7.23	34.77
			H	0.75	3.09	-3.04	0.80	34.77
BAND 12 BW: 10M QPSK RB: 1,49	704.0	23060	V	6.11	3.10	-3.04	6.17	34.77
			H	-0.11	3.10	-3.04	-0.05	34.77
	707.5	23095	V	6.16	3.10	-3.05	6.21	34.77
			H	-0.30	3.10	-3.05	-0.25	34.77
	711.0	23130	V	7.59	3.11	-3.06	7.64	34.77
			H	1.79	3.11	-3.06	1.84	34.77
BAND 12 BW: 10M 16QAM RB: 1,0	704.0	23060	V	6.01	3.08	-2.96	6.13	34.77
			H	-2.35	3.08	-2.96	-2.23	34.77
	707.5	23095	V	7.55	3.08	-3.00	7.63	34.77
			H	-0.22	3.08	-3.00	-0.14	34.77
	711.0	23130	V	7.17	3.09	-3.04	7.22	34.77
			H	0.45	3.09	-3.04	0.50	34.77
BAND 12 BW: 10M 16QAM RB: 1,49	704.0	23060	V	6.26	3.10	-3.04	6.32	34.77
			H	-0.64	3.10	-3.04	-0.58	34.77
	707.5	23095	V	6.01	3.10	-3.05	6.06	34.77
			H	0.12	3.10	-3.05	0.17	34.77
	711.0	23130	V	7.00	3.11	-3.06	7.05	34.77
			H	1.52	3.11	-3.06	1.57	34.77

The RBW,VBW of SPA for frequency RBW= 8MHz , VBW= 8MHz

Unless otherwise stated the results shown in this test report refer only to the sample(s) tested and such sample(s) are retained for 90 days only.

除非另有說明，此報告結果僅對測試之樣品負責，同時此樣品僅保留90天。本報告未經本公司書面許可，不可部份複製。

This document is issued by the Company subject to its General Conditions of Service printed overleaf, available on request or accessible at www.sgs.com/terms_and_conditions.htm and, for electronic format documents, subject to Terms and Conditions for Electronic Documents at www.sgs.com/terms_e-document.htm. Attention is drawn to the limitation of liability, indemnification and jurisdiction issues defined therein. Any holder of this document is advised that information contained hereon reflects the Company's findings at the time of its intervention only and within the limits of Client's instructions, if any. The Company's sole responsibility is to its Client and this document does not exonerate parties to a transaction from exercising all their rights and obligations under the transaction documents. This document cannot be reproduced except in full, without prior written approval of the Company. Any unauthorized alteration, forgery or falsification of the content or appearance of this document is unlawful and offenders may be prosecuted to the fullest extent of the law.

SGS Taiwan Ltd.

No.134,WuKungRoad,NewTaipeiIndustrialPark,WukuDistrict,NewTaipeiCity,Taiwan24803/新北市五股區新北產業園區五工路 134 號

台灣檢驗科技股份有限公司

t (886-2) 2299-3279

f (886-2) 2298-0488

www.tw.sgs.com

Member of SGS Group

EUT			Measurement					
Operation Band	Fundamental Frequency MHz	CH	Antenna Pol. V/H	S.G. Output dBm	Antenna Gain dBi	Cable Loss dB	EIRP dBm	Limit dBm
BAND 17 BW: 5M QPSK RB: 1,0	706.5	23755	V	8.14	3.09	-3.04	8.19	34.77
			H	1.67	3.09	-3.04	1.72	34.77
	710.0	23790	V	6.81	3.09	-3.04	6.86	34.77
			H	0.67	3.09	-3.04	0.72	34.77
	713.5	23825	V	7.11	3.10	-3.05	7.16	34.77
			H	0.73	3.10	-3.05	0.78	34.77
BAND 17 BW: 5M QPSK RB: 1,24	706.5	23755	V	6.22	3.10	-3.04	6.28	34.77
			H	0.69	3.10	-3.04	0.75	34.77
	710.0	23790	V	6.83	3.10	-3.05	6.88	34.77
			H	1.13	3.10	-3.05	1.18	34.77
	713.5	23825	V	7.39	3.11	-3.06	7.44	34.77
			H	1.14	3.11	-3.06	1.19	34.77
BAND 17 BW: 5M 16QAM RB: 1,0	706.5	23755	V	7.09	3.09	-3.04	7.14	34.77
			H	0.96	3.09	-3.04	1.01	34.77
	710.0	23790	V	6.37	3.09	-3.04	6.42	34.77
			H	0.65	3.09	-3.04	0.70	34.77
	713.5	23825	V	5.98	3.10	-3.05	6.03	34.77
			H	0.06	3.10	-3.05	0.11	34.77
BAND 17 BW: 5M 16QAM RB: 1,24	706.5	23755	V	5.78	3.10	-3.04	5.84	34.77
			H	0.21	3.10	-3.04	0.27	34.77
	710.0	23790	V	6.57	3.10	-3.05	6.62	34.77
			H	0.04	3.10	-3.05	0.09	34.77
	713.5	23825	V	7.77	3.11	-3.06	7.82	34.77
			H	1.23	3.11	-3.06	1.28	34.77

The RBW,VBW of SPA for frequency RBW= 8MHz , VBW= 8MHz

Unless otherwise stated the results shown in this test report refer only to the sample(s) tested and such sample(s) are retained for 90 days only.

除非另有說明，此報告結果僅對測試之樣品負責，同時此樣品僅保留90天。本報告未經本公司書面許可，不可部份複製。

This document is issued by the Company subject to its General Conditions of Service printed overleaf, available on request or accessible at www.sgs.com/terms_and_conditions.htm and, for electronic format documents, subject to Terms and Conditions for Electronic Documents at www.sgs.com/terms_e-document.htm. Attention is drawn to the limitation of liability, indemnification and jurisdiction issues defined therein. Any holder of this document is advised that information contained hereon reflects the Company's findings at the time of its intervention only and within the limits of Client's instructions, if any. The Company's sole responsibility is to its Client and this document does not exonerate parties to a transaction from exercising all their rights and obligations under the transaction documents. This document cannot be reproduced except in full, without prior written approval of the Company. Any unauthorized alteration, forgery or falsification of the content or appearance of this document is unlawful and offenders may be prosecuted to the fullest extent of the law.

SGS Taiwan Ltd.

No.134,WuKungRoad,NewTaipeiIndustrialPark,WukuDistrict,NewTaipeiCity,Taiwan24803/新北市五股區新北產業園區五工路 134 號

台灣檢驗科技股份有限公司

t (886-2) 2299-3279

f (886-2) 2298-0488

www.tw.sgs.com

Member of SGS Group

EUT			Measurement					
Operation Band	Fundamental Frequency MHz	CH	Antenna Pol. V/H	S.G. Output dBm	Antenna Gain dBi	Cable Loss dB	EIRP dBm	Limit dBm
BAND 17 BW: 10M QPSK RB: 1,0	709.0	23780	V	6.74	3.09	-3.03	6.80	34.77
			H	1.81	3.09	-3.03	1.87	34.77
	710.0	23790	V	7.88	3.09	-3.03	7.94	34.77
			H	1.89	3.09	-3.03	1.95	34.77
	711.0	23800	V	7.46	3.09	-3.04	7.51	34.77
			H	1.52	3.09	-3.04	1.57	34.77
BAND 17 BW: 10M QPSK RB: 1,49	709.0	23780	V	8.20	3.11	-3.06	8.25	34.77
			H	1.51	3.11	-3.06	1.56	34.77
	710.0	23790	V	8.03	3.11	-3.06	8.08	34.77
			H	1.50	3.11	-3.06	1.55	34.77
	711.0	23800	V	8.18	3.11	-3.06	8.23	34.77
			H	1.70	3.11	-3.06	1.75	34.77
BAND 17 BW: 10M 16QAM RB: 1,0	709.0	23780	V	7.06	3.09	-3.03	7.12	34.77
			H	0.68	3.09	-3.03	0.74	34.77
	710.0	23790	V	7.66	3.09	-3.03	7.72	34.77
			H	2.11	3.09	-3.03	2.17	34.77
	711.0	23800	V	7.10	3.09	-3.04	7.15	34.77
			H	1.66	3.09	-3.04	1.71	34.77
BAND 17 BW: 10M 16QAM RB: 1,49	709.0	23780	V	8.01	3.11	-3.06	8.06	34.77
			H	1.25	3.11	-3.06	1.30	34.77
	710.0	23790	V	7.57	3.11	-3.06	7.62	34.77
			H	1.62	3.11	-3.06	1.67	34.77
	711.0	23800	V	6.93	3.11	-3.06	6.98	34.77
			H	1.48	3.11	-3.06	1.53	34.77

The RBW,VBW of SPA for frequency RBW= 8MHz , VBW= 8MHz

Unless otherwise stated the results shown in this test report refer only to the sample(s) tested and such sample(s) are retained for 90 days only.

除非另有說明，此報告結果僅對測試之樣品負責，同時此樣品僅保留90天。本報告未經本公司書面許可，不可部份複製。

This document is issued by the Company subject to its General Conditions of Service printed overleaf, available on request or accessible at www.sgs.com/terms_and_conditions.htm and, for electronic format documents, subject to Terms and Conditions for Electronic Documents at www.sgs.com/terms_e-document.htm. Attention is drawn to the limitation of liability, indemnification and jurisdiction issues defined therein. Any holder of this document is advised that information contained hereon reflects the Company's findings at the time of its intervention only and within the limits of Client's instructions, if any. The Company's sole responsibility is to its Client and this document does not exonerate parties to a transaction from exercising all their rights and obligations under the transaction documents. This document cannot be reproduced except in full, without prior written approval of the Company. Any unauthorized alteration, forgery or falsification of the content or appearance of this document is unlawful and offenders may be prosecuted to the fullest extent of the law.

SGS Taiwan Ltd.

No.134,WuKungRoad,NewTaipeiIndustrialPark,WukuDistrict,NewTaipeiCity,Taiwan24803/新北市五股區新北產業園區五工路 134 號

台灣檢驗科技股份有限公司

t (886-2) 2299-3279

f (886-2) 2298-0488

www.tw.sgs.com

Member of SGS Group

8. OCCUPIED BANDWIDTH MEASUREMENT

8.1. Standard Applicable

The occupied bandwidth is the frequency bandwidth such that, below its lower and above its upper frequency limits, the mean powers radiated are each equal to 0.5 percent of the total mean power.

8.2. Test Set-up

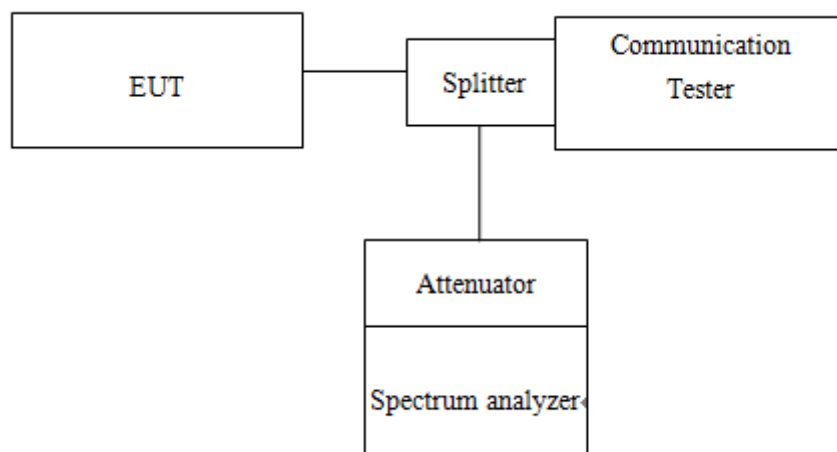

8.3. Measurement Procedure

99% & 26dB Bandwidth with detector peak

The EUT's output RF connector was connected with a short cable to the spectrum analyzer, RBW was set to about 1% of emission BW, VBW= 3 times RBW, -26dBc display line was placed on the screen (or 26dB bandwidth), the occupied bandwidth is the delta frequency between the two points where the display line intersects the signal trace. Then set RBW to 99% bandwidth, RBW= 1%, VBW= 3 RBW, with span > 2 * Signal BW, set % Power = 99%.

Unless otherwise stated the results shown in this test report refer only to the sample(s) tested and such sample(s) are retained for 90 days only.

除非另有說明，此報告結果僅對測試之樣品負責，同時此樣品僅保留90天。本報告未經本公司書面許可，不可部份複製。

This document is issued by the Company subject to its General Conditions of Service printed overleaf, available on request or accessible at www.sgs.com/terms_and_conditions.htm and, for electronic format documents, subject to Terms and Conditions for Electronic Documents at www.sgs.com/terms_e-document.htm. Attention is drawn to the limitation of liability, indemnification and jurisdiction issues defined therein. Any holder of this document is advised that information contained hereon reflects the Company's findings at the time of its intervention only and within the limits of Client's instructions, if any. The Company's sole responsibility is to its Client and this document does not exonerate parties to a transaction from exercising all their rights and obligations under the transaction documents. This document cannot be reproduced except in full, without prior written approval of the Company. Any unauthorized alteration, forgery or falsification of the content or appearance of this document is unlawful and offenders may be prosecuted to the fullest extent of the law.

8.4. Measurement Equipment Used

Conducted Emission (measured at antenna port) Test Site					
EQUIPMENT TYPE	MFR	MODEL NUMBER	SERIAL NUMBER	LAST CAL.	CAL DUE.
Power Meter	Anritsu	ML2495A	1005007	12/15/2017	12/14/2018
Power Sensor	Anritsu	MA2411B	917032	12/15/2017	12/14/2018
EXA Spectrum Analyzer	Agilent	N9030A	MY53120760	03/21/2017	03/20/2018
DC Block	Mini-Circuits	BLK-18-S+	1	01/05/2017	01/04/2018
Coaxial Cable	HUBER+SUHNER	SUCOFLEX 102	23670/2	01/05/2017	01/04/2018
Attenuator	Mini-Circuit	BW-S10W2+	2	01/05/2017	01/04/2018
Splitter	Agilent	11636B	N/A	01/05/2017	01/04/2018
DC Power Supply	Agilent	E3640A	MY52410006	10/26/2017	10/27/2018
Temperature Chamber	TERCHY	MHG-120LF	911009	05/19/2017	05/18/2018
Radio Communication Analyzer	R&S	CMU200	102189	02/11/2017	02/10/2018
Radio Communication Analyzer	Anritsu	MT8820C	6201465317	01/03/2017	01/02/2018

Unless otherwise stated the results shown in this test report refer only to the sample(s) tested and such sample(s) are retained for 90 days only.

除非另有說明，此報告結果僅對測試之樣品負責，同時此樣品僅保留90天。本報告未經本公司書面許可，不可部份複製。

This document is issued by the Company subject to its General Conditions of Service printed overleaf, available on request or accessible at www.sgs.com/terms_and_conditions.htm and, for electronic format documents, subject to Terms and Conditions for Electronic Documents at www.sgs.com/terms_e-document.htm. Attention is drawn to the limitation of liability, indemnification and jurisdiction issues defined therein. Any holder of this document is advised that information contained hereon reflects the Company's findings at the time of its intervention only and within the limits of Client's instructions, if any. The Company's sole responsibility is to its Client and this document does not exonerate parties to a transaction from exercising all their rights and obligations under the transaction documents. This document cannot be reproduced except in full, without prior written approval of the Company. Any unauthorized alteration, forgery or falsification of the content or appearance of this document is unlawful and offenders may be prosecuted to the fullest extent of the law.

SGS Taiwan Ltd.

No.134,WuKungRoad,NewTaipeiIndustrialPark,WukuDistrict,NewTaipeiCity,Taiwan24803/新北市五股區新北產業園區五工路 134 號

台灣檢驗科技股份有限公司

t (886-2) 2299-3279

f (886-2) 2298-0488

www.tw.sgs.com

Member of SGS Group

8.5. Measurement Result

Freq. (MHz)	CH	99% BW (MHz)	99% BW (MHz)	26 dB BW (MHz)	26 dB BW (MHz)
		GSM 850	GPRS 850	GSM 850	GPRS 850
824.2	128	0.24028	0.24091	0.3028	0.3170
836.6	190	0.24163	0.23548	0.3100	0.3045
848.8	251	0.23947	0.24540	0.3012	0.3204

Freq. (MHz)	CH	99% BW (MHz)	99% BW (MHz)	26 dB BW (MHz)	26 dB BW (MHz)
		GSM 1900	GPRS 1900	GSM 1900	GPRS 1900
1850.2	512	0.24437	0.24262	0.3173	0.3123
1880.0	661	0.24246	0.24353	0.3152	0.3094
1909.8	810	0.24406	0.23896	0.3048	0.3084

Freq. (MHz)	CH	99% BW (MHz)	99% BW (MHz)	99% BW (MHz)	26 dB BW (MHz)	26 dB BW (MHz)	26 dB BW (MHz)
		WCDMA V	HSDPA V	HSUPA V	WCDMA V	HSDPA V	HSUPA V
826.40	4132	4.1313	4.1058	4.1274	5.0960	4.6970	4.6690
836.60	4183	4.1471	4.1213	4.1237	5.0900	4.6760	4.6830
846.60	4233	4.1393	4.1333	4.1313	4.9780	4.7110	4.6870

Unless otherwise stated the results shown in this test report refer only to the sample(s) tested and such sample(s) are retained for 90 days only.

除非另有說明，此報告結果僅對測試之樣品負責，同時此樣品僅保留90天。本報告未經本公司書面許可，不可部份複製。

This document is issued by the Company subject to its General Conditions of Service printed overleaf, available on request or accessible at www.sgs.com/terms_and_conditions.htm and, for electronic format documents, subject to Terms and Conditions for Electronic Documents at www.sgs.com/terms_e-document.htm. Attention is drawn to the limitation of liability, indemnification and jurisdiction issues defined therein. Any holder of this document is advised that information contained hereon reflects the Company's findings at the time of its intervention only and within the limits of Client's instructions, if any. The Company's sole responsibility is to its Client and this document does not exonerate parties to a transaction from exercising all their rights and obligations under the transaction documents. This document cannot be reproduced except in full, without prior written approval of the Company. Any unauthorized alteration, forgery or falsification of the content or appearance of this document is unlawful and offenders may be prosecuted to the fullest extent of the law.

LTE BAND 5 Channel bandwidth: 1.4MHz					
Freq. (MHz)	CH	99% BW (MHz)	99% BW (MHz)	26 dB BW (MHz)	26 dB BW (MHz)
		QPSK	16QAM	QPSK	16QAM
824.7	20407	1.0963	1.1007	1.283	1.296
836.5	20525	1.0951	1.0998	1.277	1.304
848.3	20643	1.0849	1.0991	1.289	1.285

LTE BAND 5 Channel bandwidth: 3MHz					
Freq. (MHz)	CH	99% BW (MHz)	99% BW (MHz)	26 dB BW (MHz)	26 dB BW (MHz)
		QPSK	16QAM	QPSK	16QAM
825.5	20415	2.7030	2.7048	2.988	2.998
836.5	20525	2.6975	2.7004	2.991	2.999
847.5	20635	2.7012	2.7013	2.997	2.994

LTE BAND 5 Channel bandwidth: 5MHz					
Freq. (MHz)	CH	99% BW (MHz)	99% BW (MHz)	26 dB BW (MHz)	26 dB BW (MHz)
		QPSK	16QAM	QPSK	16QAM
826.5	20425	4.5066	4.4958	5.012	5.050
836.5	20525	4.4979	4.5100	4.995	4.968
846.5	20625	4.4992	4.5035	5.023	5.017

LTE BAND 5 Channel bandwidth: 10MHz					
Freq. (MHz)	CH	99% BW (MHz)	99% BW (MHz)	26 dB BW (MHz)	26 dB BW (MHz)
		QPSK	16QAM	QPSK	16QAM
829.0	20450	8.9753	8.9563	9.842	9.803
836.5	20525	8.9755	8.9332	9.845	9.771
844.0	20600	8.9564	8.9481	9.784	9.801

LTE BAND 12 Channel bandwidth: 1.4MHz					
Freq. (MHz)	CH	99% BW (MHz)	99% BW (MHz)	26 dB BW (MHz)	26 dB BW (MHz)
		QPSK	16QAM	QPSK	16QAM
699.7	23017	1.0970	1.1008	1.288	1.285
707.5	23095	1.0979	1.1004	1.293	1.275
715.3	23173	1.0959	1.1025	1.287	1.283

LTE BAND 12 Channel bandwidth: 3MHz					
Freq. (MHz)	CH	99% BW (MHz)	99% BW (MHz)	26 dB BW (MHz)	26 dB BW (MHz)
		QPSK	16QAM	QPSK	16QAM
700.5	23025	2.6996	2.6988	2.947	2.989
707.5	23095	2.7017	2.7022	2.983	2.991
714.5	23165	2.6974	2.7017	2.965	2.994

LTE BAND 12 Channel bandwidth: 5MHz					
Freq. (MHz)	CH	99% BW (MHz)	99% BW (MHz)	26 dB BW (MHz)	26 dB BW (MHz)
		QPSK	16QAM	QPSK	16QAM
701.5	23035	4.5023	4.5027	4.996	5.005
707.5	23095	4.5028	4.5086	5.019	5.048
713.5	23155	4.5122	4.5093	5.038	4.999

LTE BAND 12 Channel bandwidth: 10MHz					
Freq. (MHz)	CH	99% BW (MHz)	99% BW (MHz)	26 dB BW (MHz)	26 dB BW (MHz)
		QPSK	16QAM	QPSK	16QAM
704.0	23060	8.9735	8.9469	9.874	9.785
707.5	23095	8.9757	8.9475	9.809	9.708
711.0	23130	9.0016	8.9568	9.827	9.784

Unless otherwise stated the results shown in this test report refer only to the sample(s) tested and such sample(s) are retained for 90 days only.

除非另有說明，此報告結果僅對測試之樣品負責，同時此樣品僅保留90天。本報告未經本公司書面許可，不可部份複製。

This document is issued by the Company subject to its General Conditions of Service printed overleaf, available on request or accessible at www.sgs.com/terms_and_conditions.htm and, for electronic format documents, subject to Terms and Conditions for Electronic Documents at www.sgs.com/terms_e-document.htm. Attention is drawn to the limitation of liability, indemnification and jurisdiction issues defined therein. Any holder of this document is advised that information contained hereon reflects the Company's findings at the time of its intervention only and within the limits of Client's instructions, if any. The Company's sole responsibility is to its Client and this document does not exonerate parties to a transaction from exercising all their rights and obligations under the transaction documents. This document cannot be reproduced except in full, without prior written approval of the Company. Any unauthorized alteration, forgery or falsification of the content or appearance of this document is unlawful and offenders may be prosecuted to the fullest extent of the law.

SGS Taiwan Ltd.

No.134,WuKungRoad,NewTaipeiIndustrialPark,WukuDistrict,NewTaipeiCity,Taiwan24803/新北市五股區新北產業園區五工路 134 號

台灣檢驗科技股份有限公司

t (886-2) 2299-3279

f (886-2) 2298-0488

www.tw.sgs.com

Member of SGS Group

LTE BAND 17 Channel bandwidth: 5MHz					
Freq. (MHz)	CH	99% BW (MHz)	99% BW (MHz)	26 dB BW (MHz)	26 dB BW (MHz)
		QPSK	16QAM	QPSK	16QAM
706.5	23755	4.4976	4.5064	4.999	4.964
710.0	23790	4.4994	4.5102	5.007	4.966
713.5	23825	4.5065	4.5084	5.008	5.005

LTE BAND 17 Channel bandwidth: 10MHz					
Freq. (MHz)	CH	99% BW (MHz)	99% BW (MHz)	26 dB BW (MHz)	26 dB BW (MHz)
		QPSK	16QAM	QPSK	16QAM
709.0	23780	8.9963	8.9528	9.833	9.780
710.0	23790	8.9706	8.9460	9.863	9.784
711.0	23780	8.9768	8.9624	9.824	9.801

Unless otherwise stated the results shown in this test report refer only to the sample(s) tested and such sample(s) are retained for 90 days only.

除非另有說明，此報告結果僅對測試之樣品負責，同時此樣品僅保留90天。本報告未經本公司書面許可，不可部份複製。

This document is issued by the Company subject to its General Conditions of Service printed overleaf, available on request or accessible at www.sgs.com/terms_and_conditions.htm and, for electronic format documents, subject to Terms and Conditions for Electronic Documents at www.sgs.com/terms_e-document.htm. Attention is drawn to the limitation of liability, indemnification and jurisdiction issues defined therein. Any holder of this document is advised that information contained hereon reflects the Company's findings at the time of its intervention only and within the limits of Client's instructions, if any. The Company's sole responsibility is to its Client and this document does not exonerate parties to a transaction from exercising all their rights and obligations under the transaction documents. This document cannot be reproduced except in full, without prior written approval of the Company. Any unauthorized alteration, forgery or falsification of the content or appearance of this document is unlawful and offenders may be prosecuted to the fullest extent of the law.

SGS Taiwan Ltd.

No.134,WuKungRoad,NewTaipeiIndustrialPark,WukuDistrict,NewTaipeiCity,Taiwan24803/新北市五股區新北產業園區五工路 134 號

台灣檢驗科技股份有限公司

t (886-2) 2299-3279

f (886-2) 2298-0488

www.tw.sgs.com

Member of SGS Group

GSM_850MHz_LowCH128-824.2

GPRS_850MHz_LowCH128-824.2

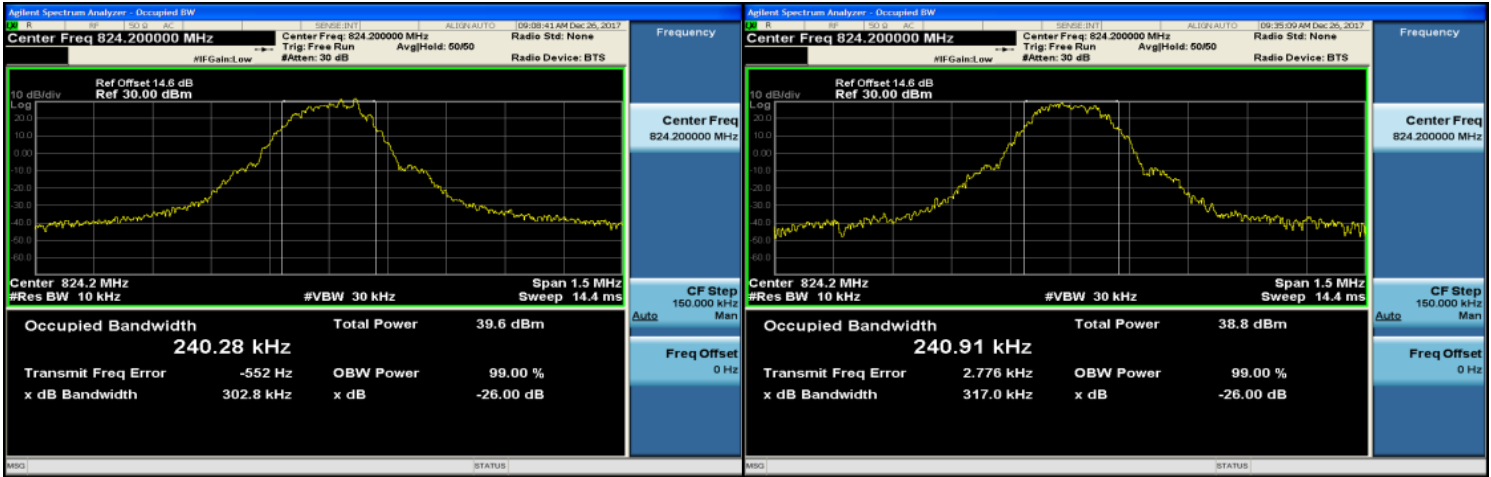

GSM_850MHz_MidCH190-836.6

GPRS_850MHz_MidCH190-836.6

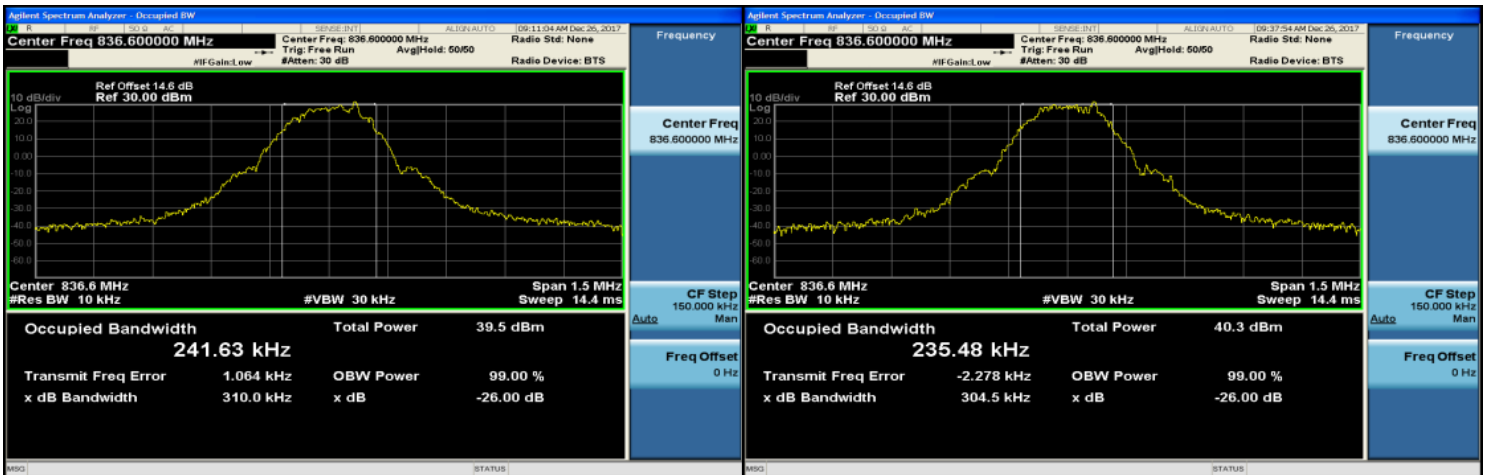

GSM_850MHz_HighCH251-848.8

GPRS_850MHz_HighCH251-848.8

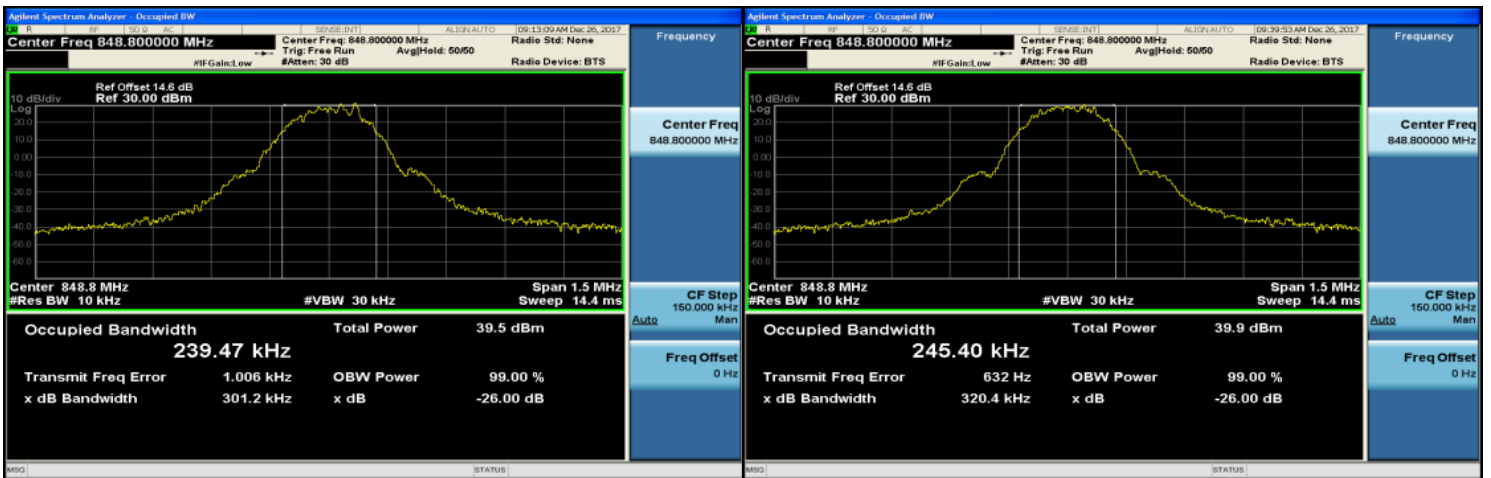

Unless otherwise stated the results shown in this test report refer only to the sample(s) tested and such sample(s) are retained for 90 days only.

除非另有說明，此報告結果僅對測試之樣品負責，同時此樣品僅保留90天。本報告未經本公司書面許可，不可部份複製。

This document is issued by the Company subject to its General Conditions of Service printed overleaf, available on request or accessible at www.sgs.com/terms_and_conditions.htm and, for electronic format documents, subject to Terms and Conditions for Electronic Documents at www.sgs.com/terms_e-document.htm. Attention is drawn to the limitation of liability, indemnification and jurisdiction issues defined therein. Any holder of this document is advised that information contained hereon reflects the Company's findings at the time of its intervention only and within the limits of Client's instructions, if any. The Company's sole responsibility is to its Client and this document does not exonerate parties to a transaction from exercising all their rights and obligations under the transaction documents. This document cannot be reproduced except in full, without prior written approval of the Company. Any unauthorized alteration, forgery or falsification of the content or appearance of this document is unlawful and offenders may be prosecuted to the fullest extent of the law.

SGS Taiwan Ltd.

No. 134, WuKungRoad, New Taipei Industrial Park, Wuku District, New Taipei City, Taiwan 24803/新北市五股區新北產業園區五工路 134 號

台灣檢驗科技股份有限公司

t (886-2) 2299-3279

f (886-2) 2298-0488

www.tw.sgs.com

Member of SGS Group

GSM_1900MHz_LowCH512-1850.2

GPRS_1900MHz_LowCH512-1850.2

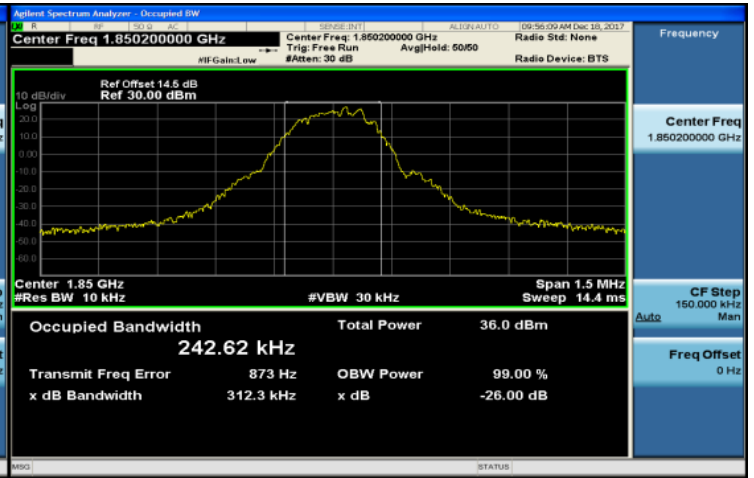
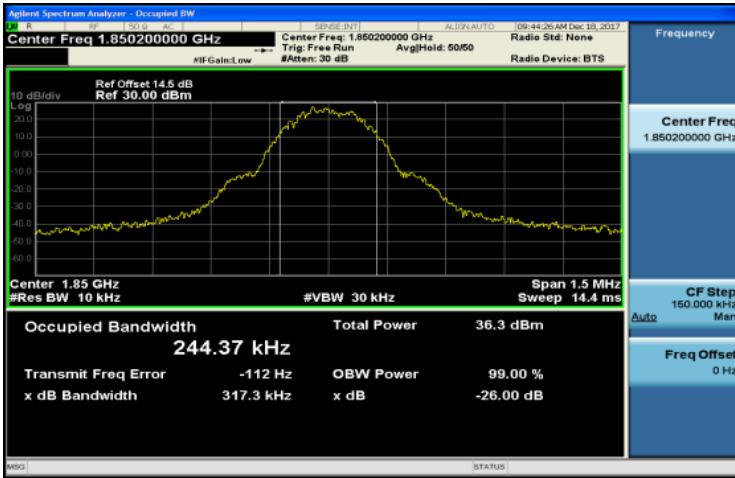

GSM_1900MHz_MidCH661-1880

GPRS_1900MHz_MidCH661-1880

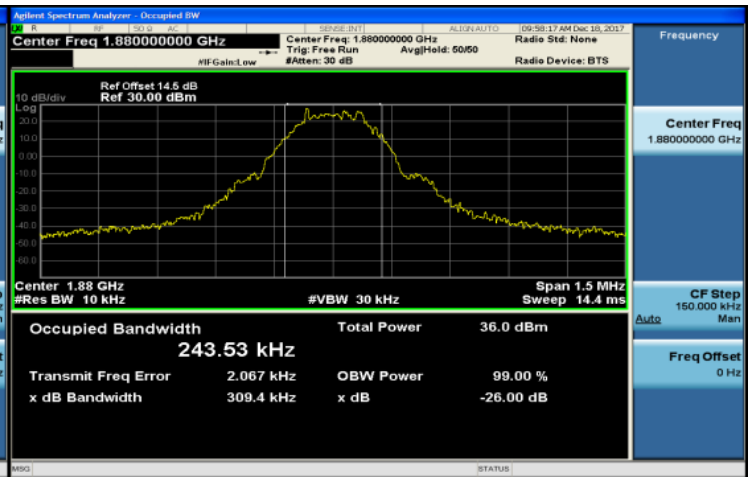
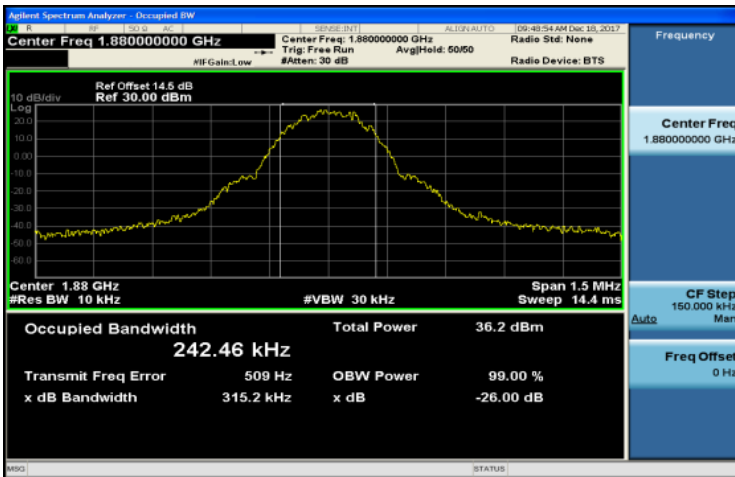

GPRS_1900MHz_HighCH810-1909.8

GPRS_1900MHz_HighCH810-1909.8

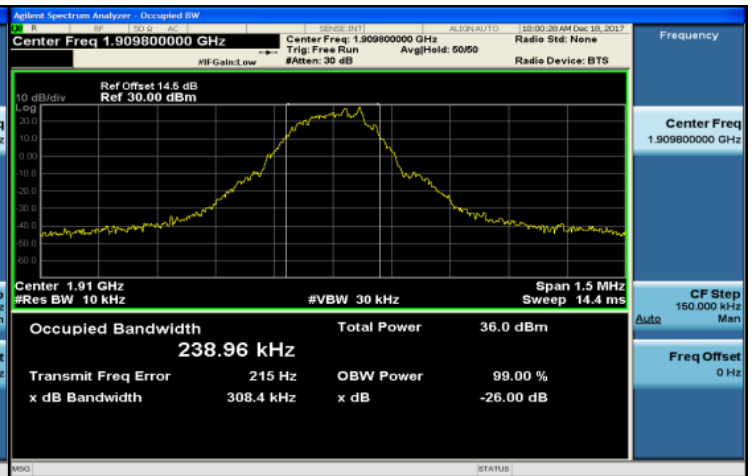
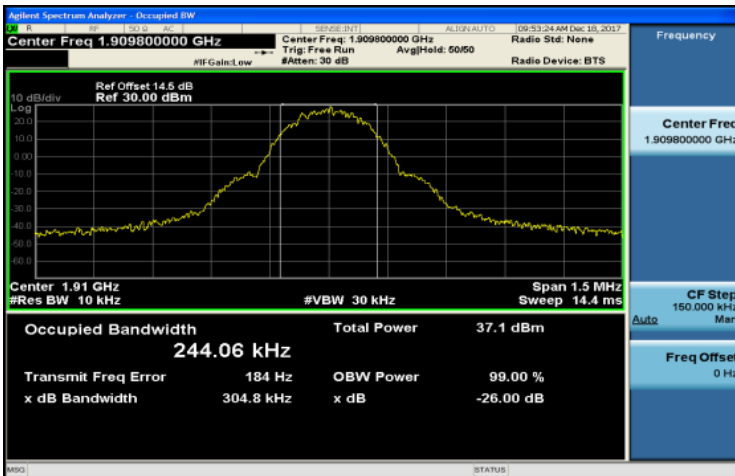

Unless otherwise stated the results shown in this test report refer only to the sample(s) tested and such sample(s) are retained for 90 days only.

除非另有說明，此報告結果僅對測試之樣品負責，同時此樣品僅保留90天。本報告未經本公司書面許可，不可部份複製。

This document is issued by the Company subject to its General Conditions of Service printed overleaf, available on request or accessible at www.sgs.com/terms_and_conditions.htm and, for electronic format documents, subject to Terms and Conditions for Electronic Documents at www.sgs.com/terms_e-document.htm. Attention is drawn to the limitation of liability, indemnification and jurisdiction issues defined therein. Any holder of this document is advised that information contained hereon reflects the Company's findings at the time of its intervention only and within the limits of Client's instructions, if any. The Company's sole responsibility is to its Client and this document does not exonerate parties to a transaction from exercising all their rights and obligations under the transaction documents. This document cannot be reproduced except in full, without prior written approval of the Company. Any unauthorized alteration, forgery or falsification of the content or appearance of this document is unlawful and offenders may be prosecuted to the fullest extent of the law.

WCDMA_B5_LowCH4132-826.4

HSDPA_B5_LowCH4132-826.4

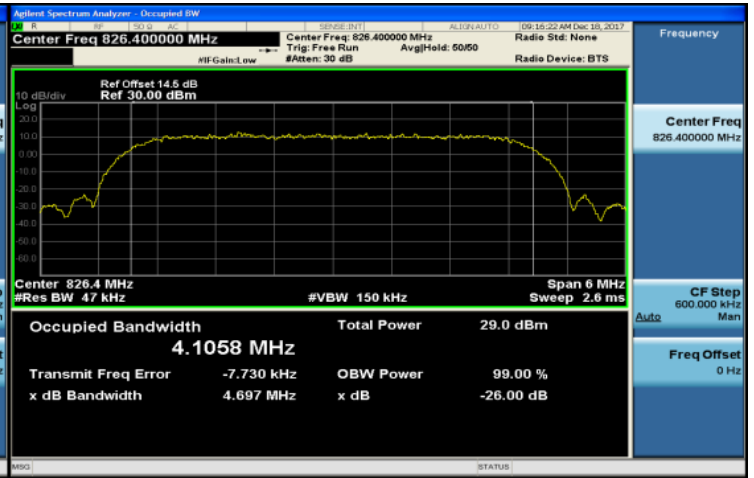
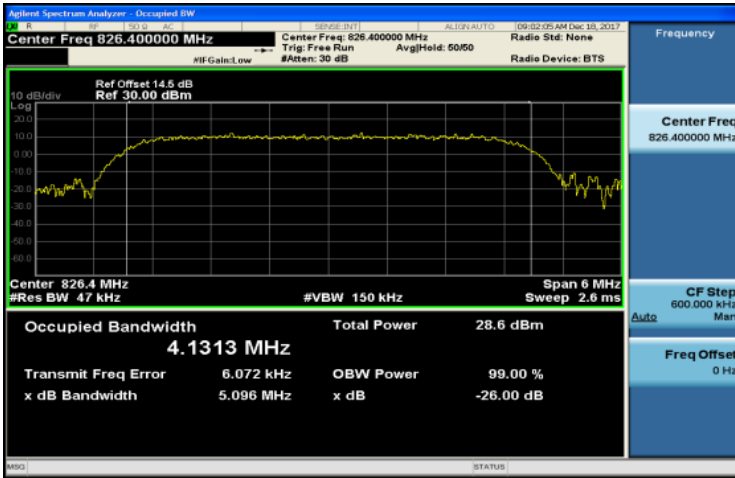

WCDMA_B5_MidCH4183-836.6

HSDPA_B5_MidCH4183-836.6

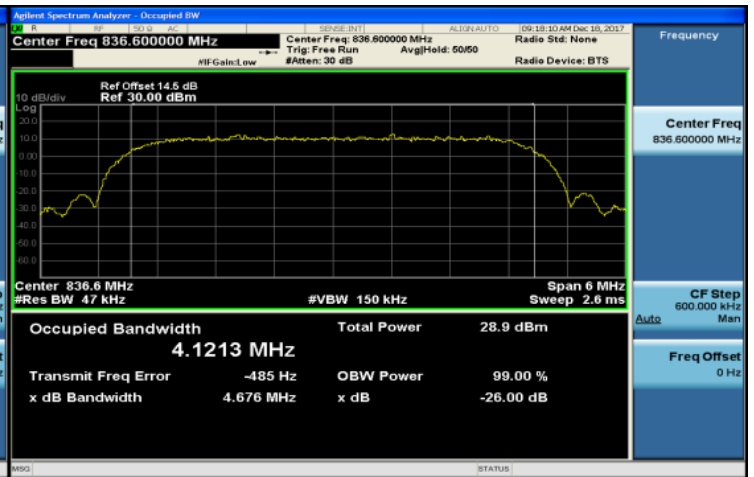
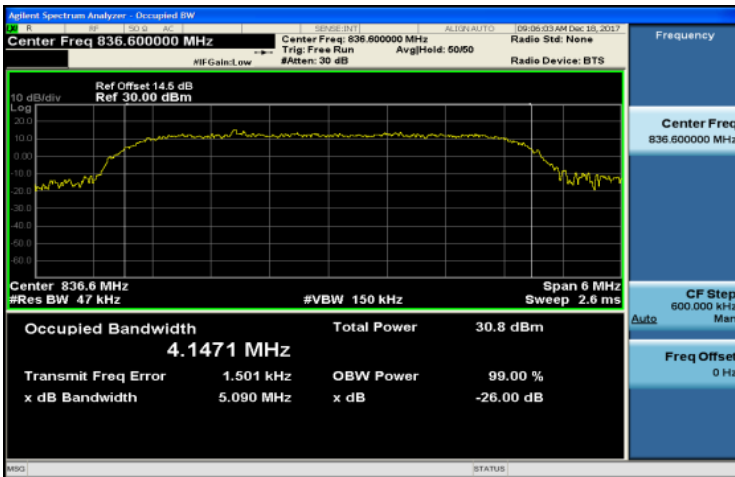

WCDMA_B5_HighCH4233-846.6

HSDPA_B5_HighCH4233-846.6

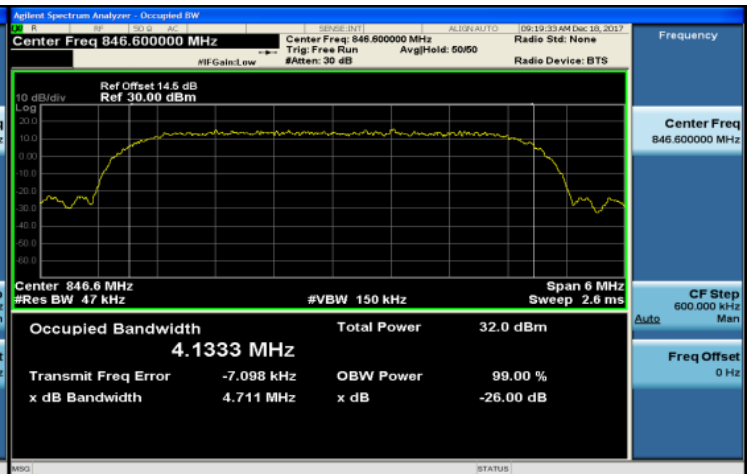
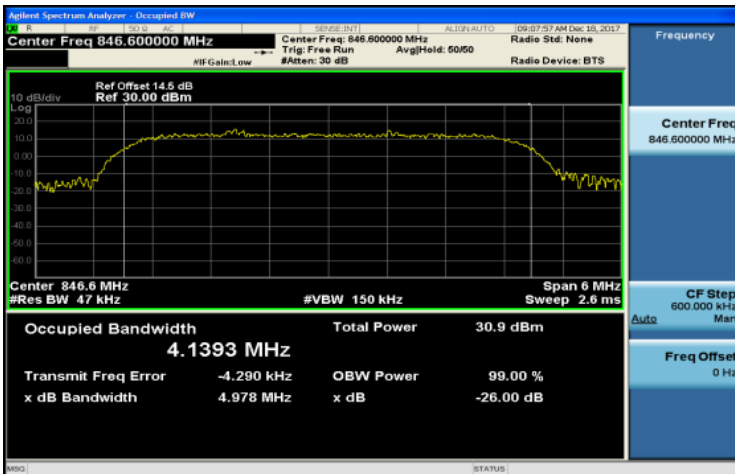

Unless otherwise stated the results shown in this test report refer only to the sample(s) tested and such sample(s) are retained for 90 days only.

除非另有說明，此報告結果僅對測試之樣品負責，同時此樣品僅保留90天。本報告未經本公司書面許可，不可部份複製。

This document is issued by the Company subject to its General Conditions of Service printed overleaf, available on request or accessible at www.sgs.com/terms_and_conditions.htm and, for electronic format documents, subject to Terms and Conditions for Electronic Documents at www.sgs.com/terms_e-document.htm. Attention is drawn to the limitation of liability, indemnification and jurisdiction issues defined therein. Any holder of this document is advised that information contained hereon reflects the Company's findings at the time of its intervention only and within the limits of Client's instructions, if any. The Company's sole responsibility is to its Client and this document does not exonerate parties to a transaction from exercising all their rights and obligations under the transaction documents. This document cannot be reproduced except in full, without prior written approval of the Company. Any unauthorized alteration, forgery or falsification of the content or appearance of this document is unlawful and offenders may be prosecuted to the fullest extent of the law.

HSUPA_B5_LowCH4132-826.4

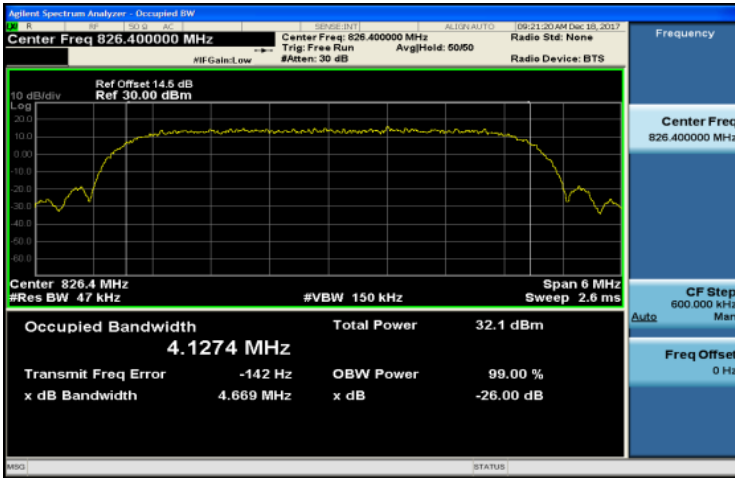

HSUPA_B5_MidCH4183-836.6



HSUPA_B5_HighCH4233-846.6

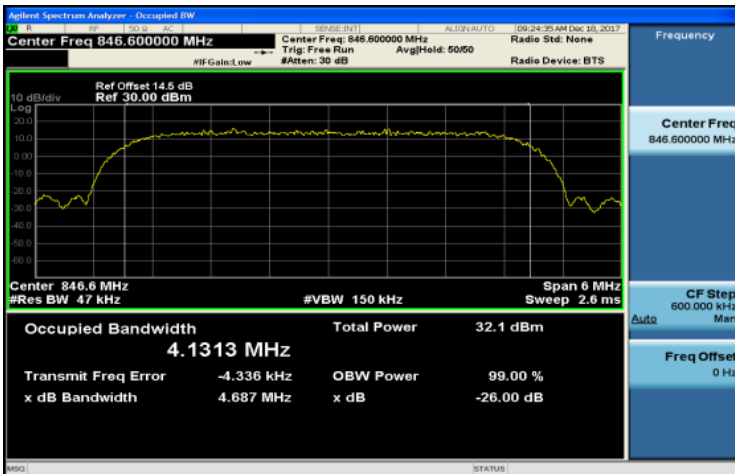

Unless otherwise stated the results shown in this test report refer only to the sample(s) tested and such sample(s) are retained for 90 days only.

除非另有說明，此報告結果僅對測試之樣品負責，同時此樣品僅保留90天。本報告未經本公司書面許可，不可部份複製。

This document is issued by the Company subject to its General Conditions of Service printed overleaf, available on request or accessible at www.sgs.com/terms_and_conditions.htm and, for electronic format documents, subject to Terms and Conditions for Electronic Documents at www.sgs.com/terms_e-document.htm. Attention is drawn to the limitation of liability, indemnification and jurisdiction issues defined therein. Any holder of this document is advised that information contained hereon reflects the Company's findings at the time of its intervention only and within the limits of Client's instructions, if any. The Company's sole responsibility is to its Client and this document does not exonerate parties to a transaction from exercising all their rights and obligations under the transaction documents. This document cannot be reproduced except in full, without prior written approval of the Company. Any unauthorized alteration, forgery or falsification of the content or appearance of this document is unlawful and offenders may be prosecuted to the fullest extent of the law.

Band5 1.4MHz_QPSK 6 0_LowCH20407-824.7

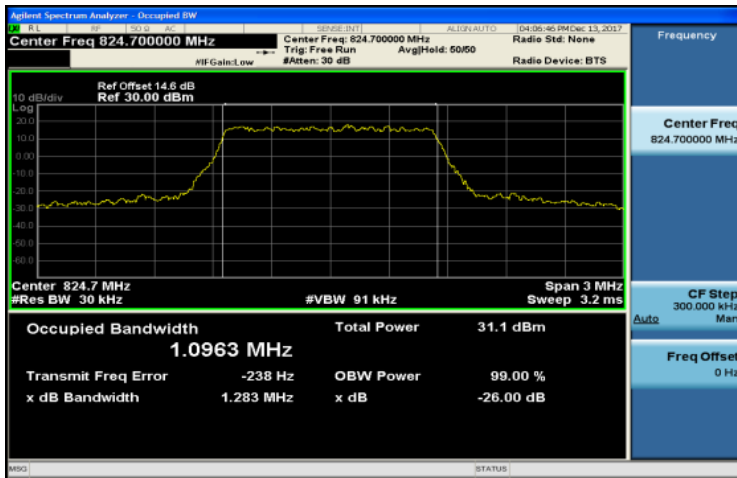

Band5 1.4MHz_16-QAM 6 0_LowCH20407-824.7

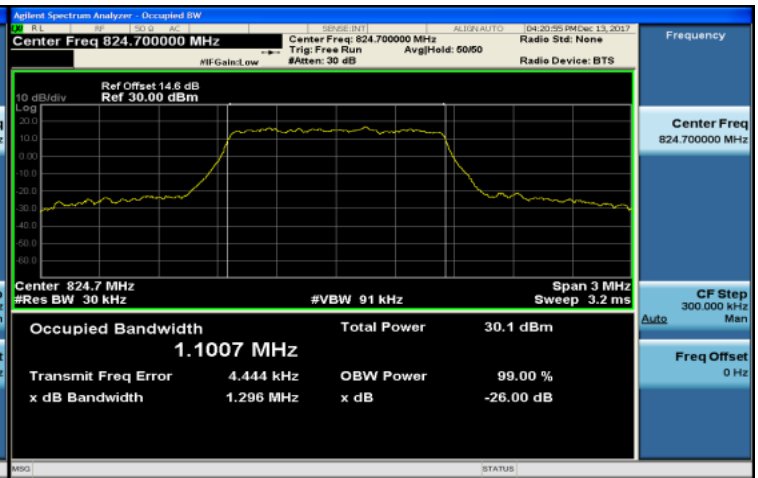

Band5 1.4MHz_QPSK 6 0_MidCH20525-836.5

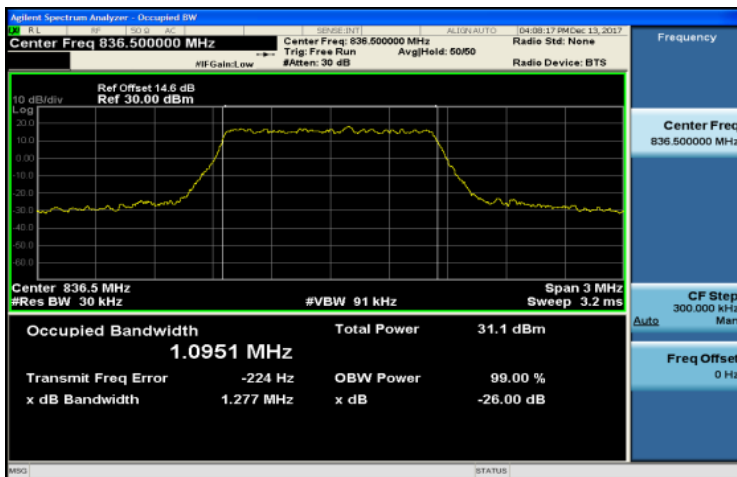

Band5 1.4MHz_16-QAM 6 0_MidCH20525-836.5

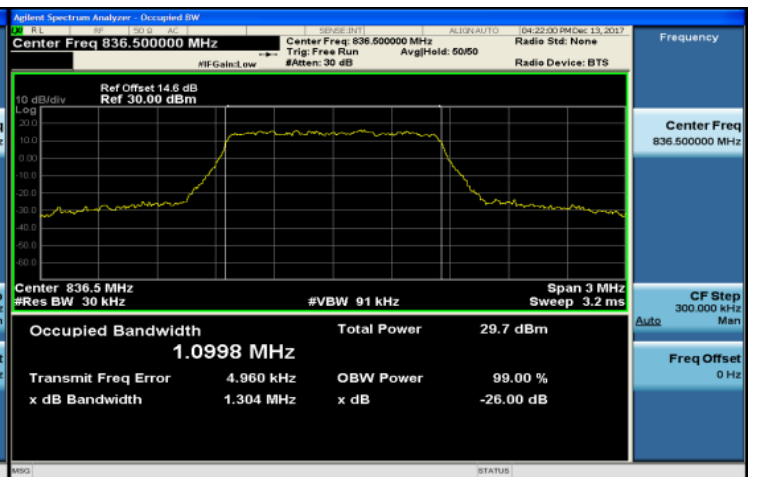

Band5 1.4MHz_QPSK 6 0_HighCH20643-848.3

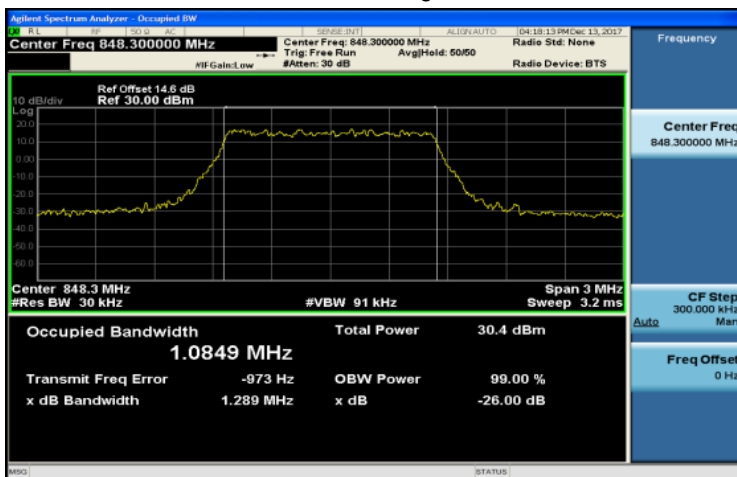

Band5 1.4MHz_16-QAM 6 0_HighCH20643-848.3

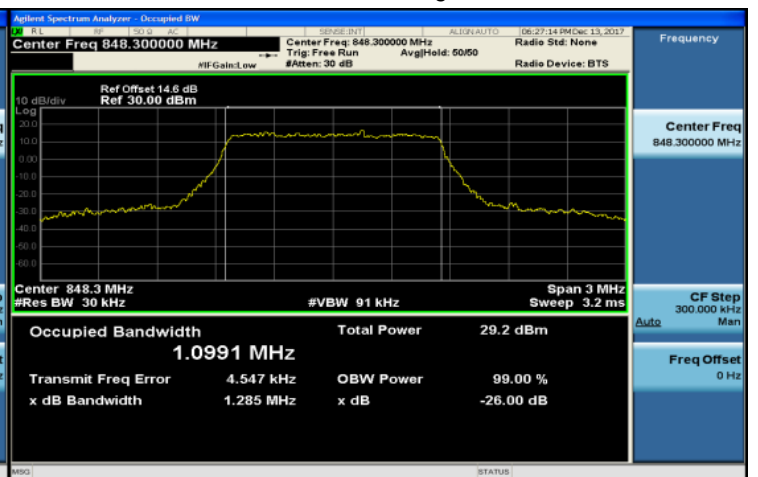

Unless otherwise stated the results shown in this test report refer only to the sample(s) tested and such sample(s) are retained for 90 days only.

除非另有說明，此報告結果僅對測試之樣品負責，同時此樣品僅保留90天。本報告未經本公司書面許可，不可部份複製。

This document is issued by the Company subject to its General Conditions of Service printed overleaf, available on request or accessible at www.sgs.com/terms_and_conditions.htm and, for electronic format documents, subject to Terms and Conditions for Electronic Documents at www.sgs.com/terms_e-document.htm. Attention is drawn to the limitation of liability, indemnification and jurisdiction issues defined therein. Any holder of this document is advised that information contained hereon reflects the Company's findings at the time of its intervention only and within the limits of Client's instructions, if any. The Company's sole responsibility is to its Client and this document does not exonerate parties to a transaction from exercising all their rights and obligations under the transaction documents. This document cannot be reproduced except in full, without prior written approval of the Company. Any unauthorized alteration, forgery or falsification of the content or appearance of this document is unlawful and offenders may be prosecuted to the fullest extent of the law.

Band5 3MHz_QPSK 15 0_LowCH20415-825.5

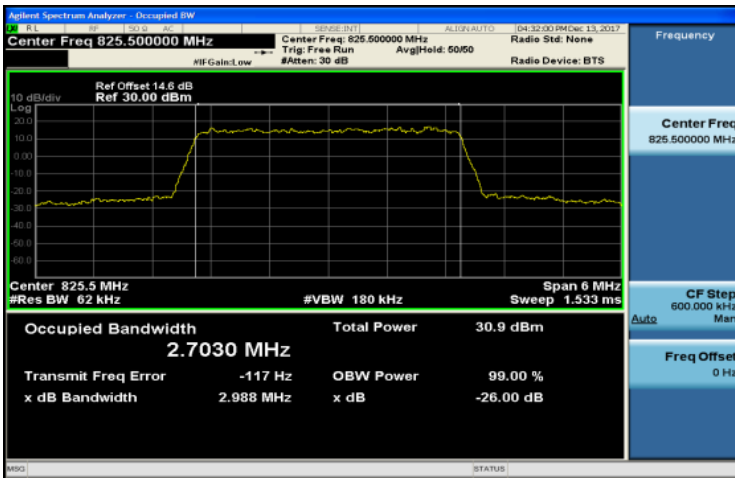

Band5 3MHz_16-QAM 15 0_LowCH20415-825.5

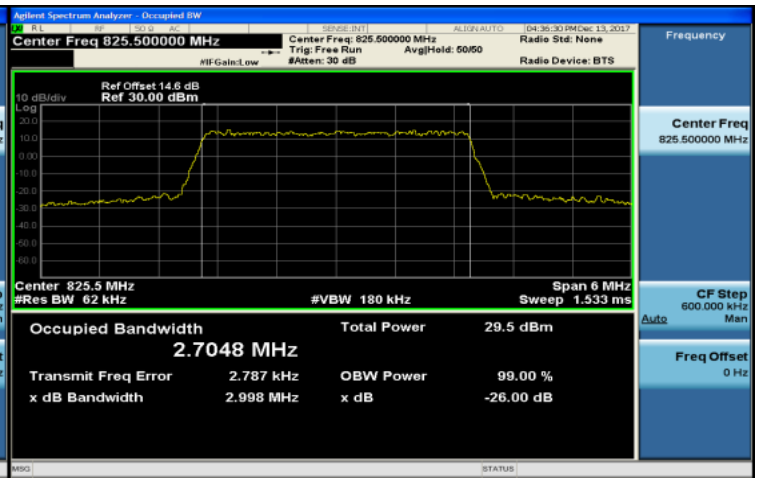

Band5 3MHz_QPSK 15 0_MidCH20525-836.5

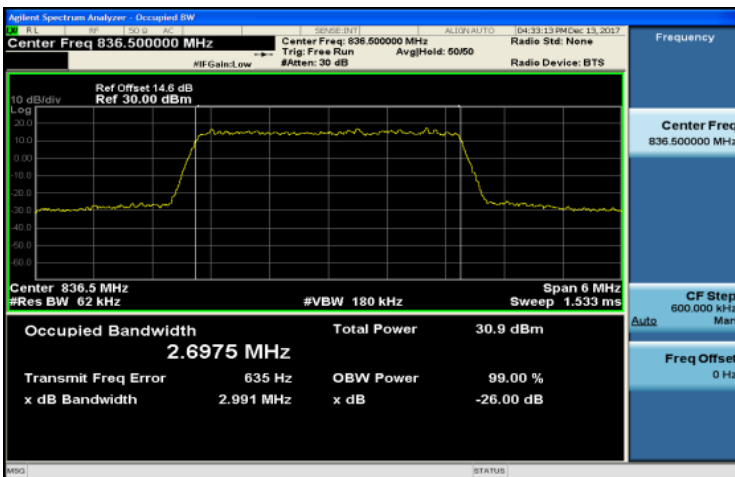

Band5 3MHz_16-QAM 15 0_MidCH20525-836.5

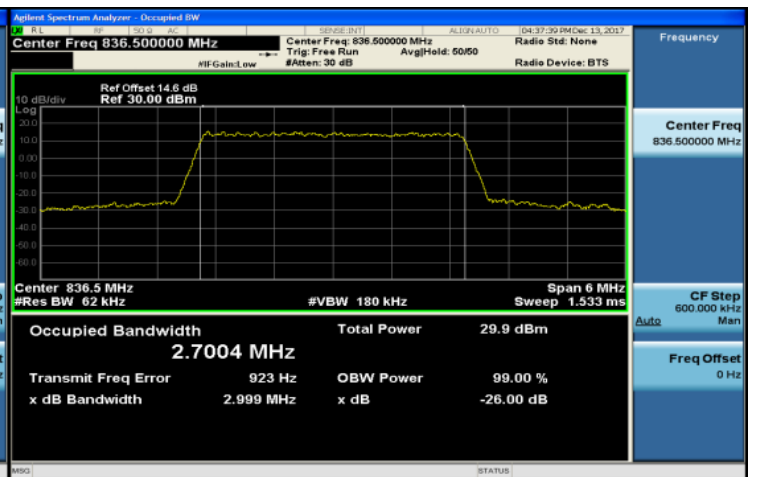

Band5 3MHz_QPSK 15 0_HighCH20635-847.5

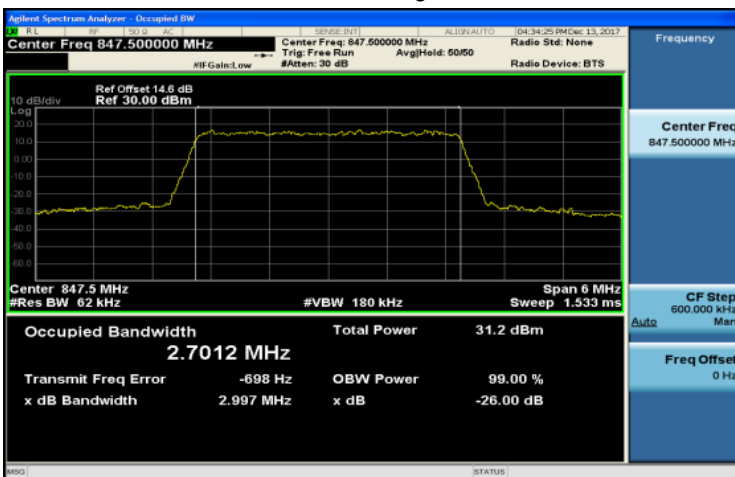

Band5 3MHz_16-QAM 15 0_HighCH20635-847.5

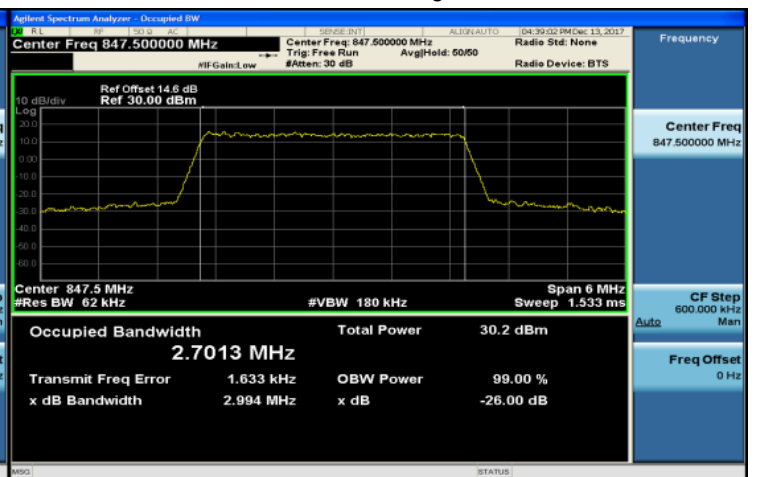

Unless otherwise stated the results shown in this test report refer only to the sample(s) tested and such sample(s) are retained for 90 days only.

除非另有說明，此報告結果僅對測試之樣品負責，同時此樣品僅保留90天。本報告未經本公司書面許可，不可部份複製。

This document is issued by the Company subject to its General Conditions of Service printed overleaf, available on request or accessible at www.sgs.com/terms_and_conditions.htm and, for electronic format documents, subject to Terms and Conditions for Electronic Documents at www.sgs.com/terms_e-document.htm. Attention is drawn to the limitation of liability, indemnification and jurisdiction issues defined therein. Any holder of this document is advised that information contained hereon reflects the Company's findings at the time of its intervention only and within the limits of Client's instructions, if any. The Company's sole responsibility is to its Client and this document does not exonerate parties to a transaction from exercising all their rights and obligations under the transaction documents. This document cannot be reproduced except in full, without prior written approval of the Company. Any unauthorized alteration, forgery or falsification of the content or appearance of this document is unlawful and offenders may be prosecuted to the fullest extent of the law.

Band5 5MHz_QPSK 25 0_LowCH20425-826.5

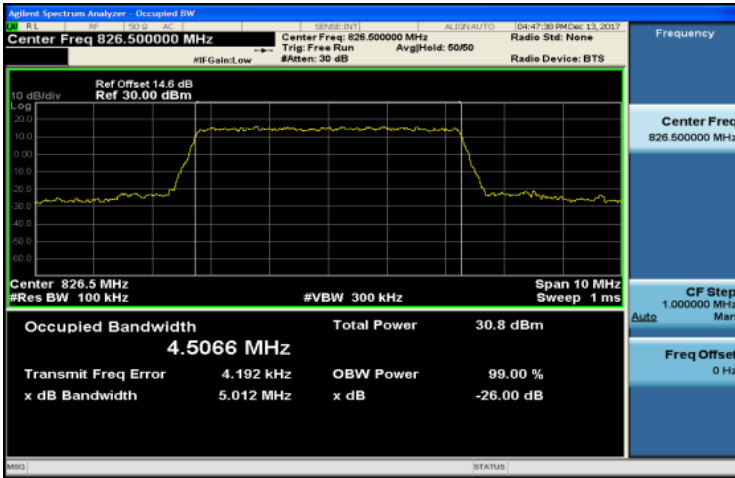

Band5 5MHz_16-QAM 25 0_LowCH20425-826.5

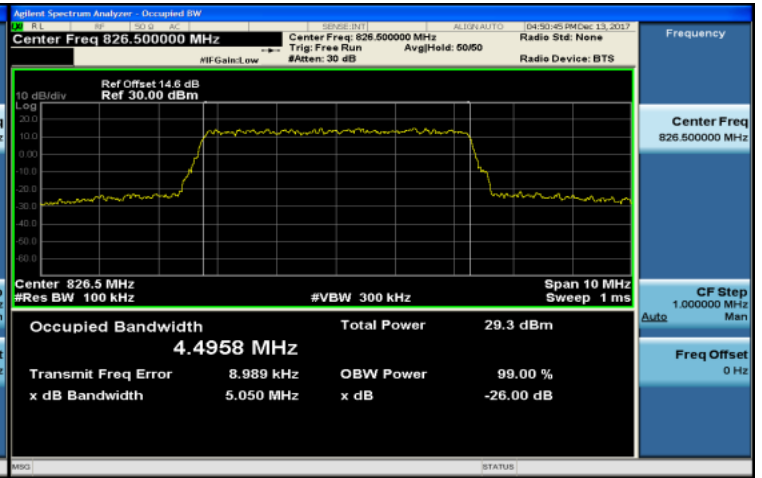

Band5 5MHz_QPSK 25 0_MidCH20525-836.5

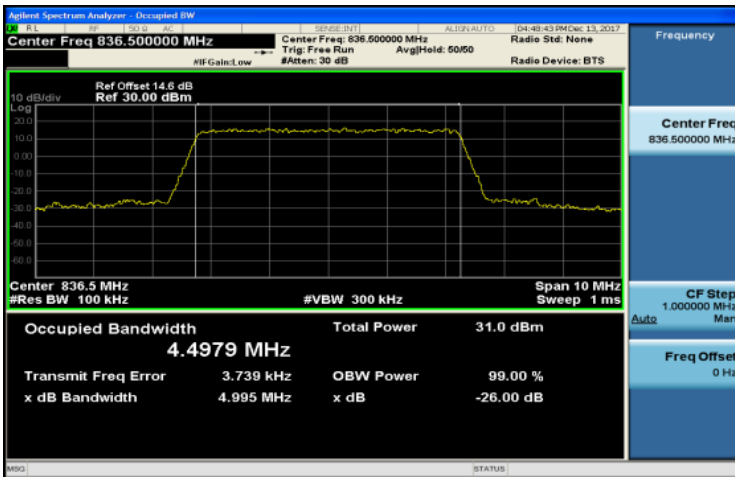

Band5 5MHz_16-QAM 25 0_MidCH20525-836.5

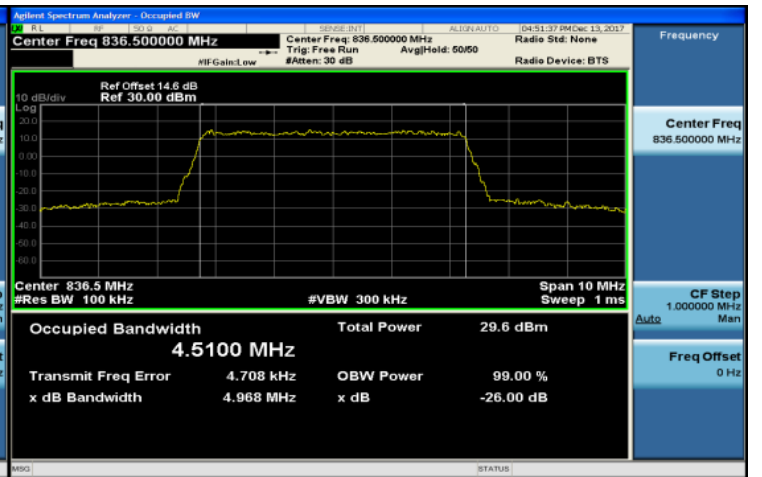

Band5 5MHz_QPSK 25 0_HighCH20625-846.5

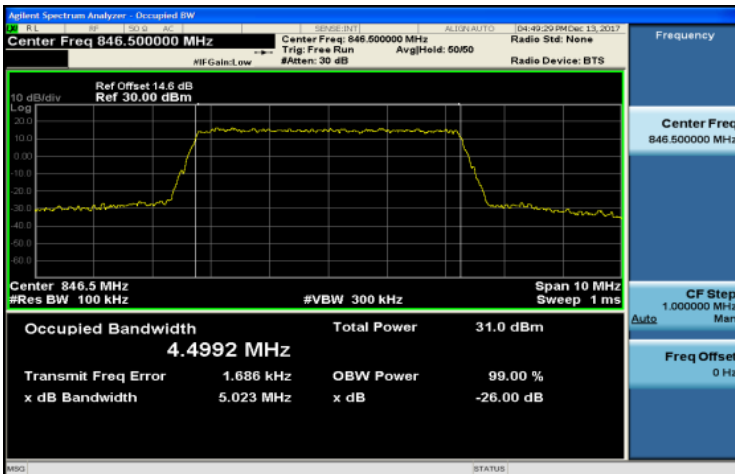

Band5 5MHz_16-QAM 25 0_HighCH20625-846.5

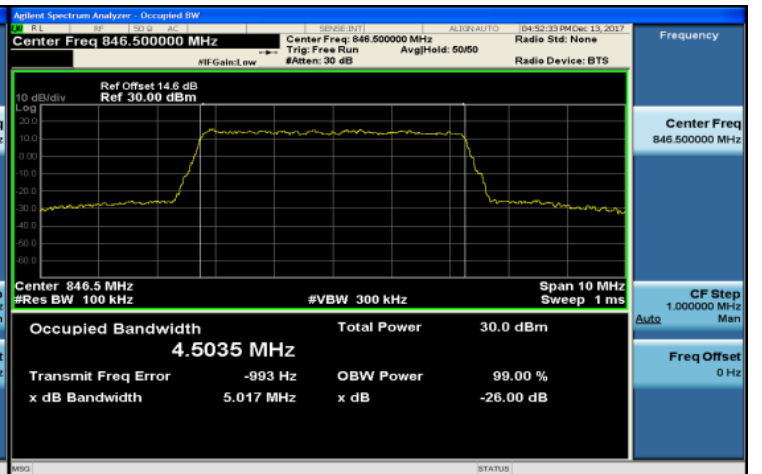

Unless otherwise stated the results shown in this test report refer only to the sample(s) tested and such sample(s) are retained for 90 days only.

除非另有說明，此報告結果僅對測試之樣品負責，同時此樣品僅保留90天。本報告未經本公司書面許可，不可部份複製。

This document is issued by the Company subject to its General Conditions of Service printed overleaf, available on request or accessible at www.sgs.com/terms_and_conditions.htm and, for electronic format documents, subject to Terms and Conditions for Electronic Documents at www.sgs.com/terms_e-document.htm. Attention is drawn to the limitation of liability, indemnification and jurisdiction issues defined therein. Any holder of this document is advised that information contained hereon reflects the Company's findings at the time of its intervention only and within the limits of Client's instructions, if any. The Company's sole responsibility is to its Client and this document does not exonerate parties to a transaction from exercising all their rights and obligations under the transaction documents. This document cannot be reproduced except in full, without prior written approval of the Company. Any unauthorized alteration, forgery or falsification of the content or appearance of this document is unlawful and offenders may be prosecuted to the fullest extent of the law.

Band5 10MHz_QPSK 50 0_LowCH20450-829

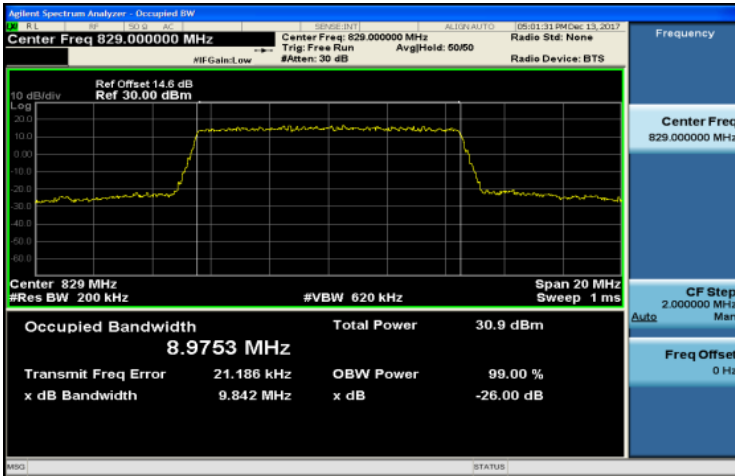

Band5 10MHz_16-QAM 50 0_LowCH20450-829

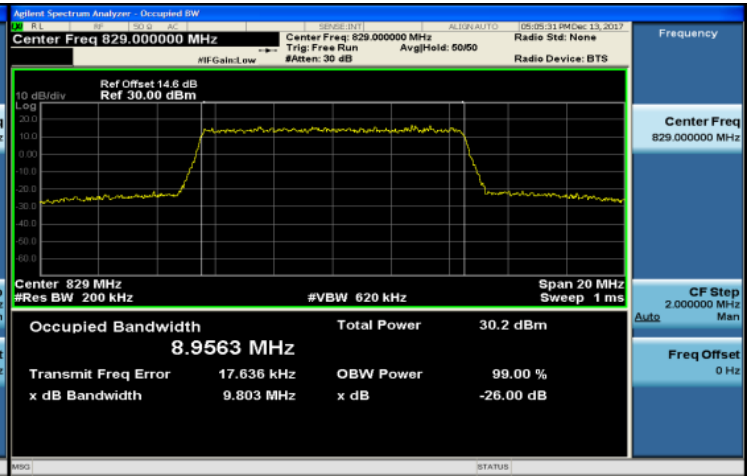

Band5 10MHz_QPSK 50 0_MidCH20525-836.5

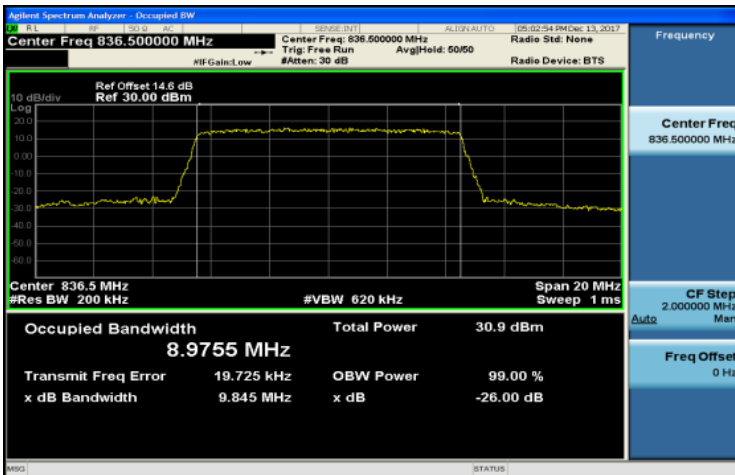

Band5 10MHz_16-QAM 50 0_MidCH20525-836.5

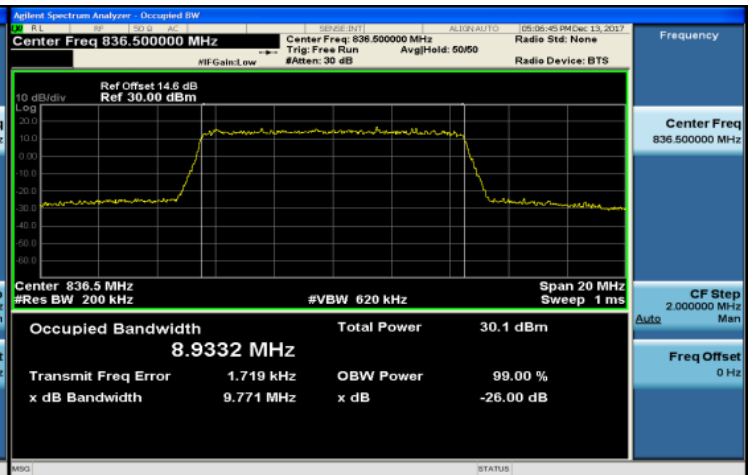

Band5 10MHz_QPSK 50 0_HighCH20600-844

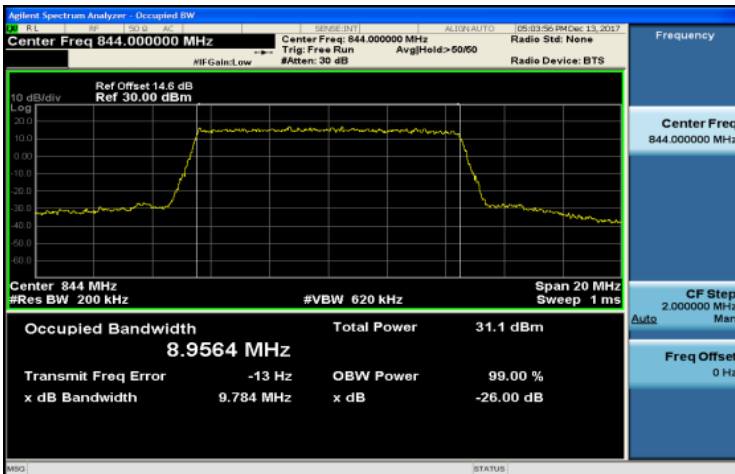

Band5 10MHz_16-QAM 50 0_HighCH20600-844

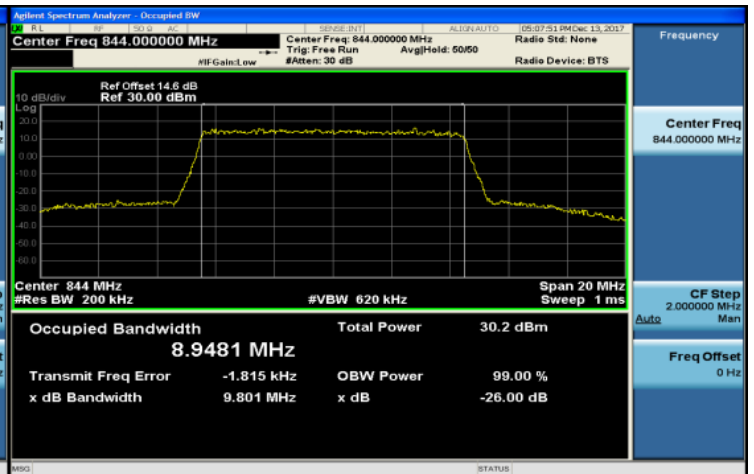

Unless otherwise stated the results shown in this test report refer only to the sample(s) tested and such sample(s) are retained for 90 days only.

除非另有說明，此報告結果僅對測試之樣品負責，同時此樣品僅保留90天。本報告未經本公司書面許可，不可部份複製。

This document is issued by the Company subject to its General Conditions of Service printed overleaf, available on request or accessible at www.sgs.com/terms_and_conditions.htm and, for electronic format documents, subject to Terms and Conditions for Electronic Documents at www.sgs.com/terms_e-document.htm. Attention is drawn to the limitation of liability, indemnification and jurisdiction issues defined therein. Any holder of this document is advised that information contained hereon reflects the Company's findings at the time of its intervention only and within the limits of Client's instructions, if any. The Company's sole responsibility is to its Client and this document does not exonerate parties to a transaction from exercising all their rights and obligations under the transaction documents. This document cannot be reproduced except in full, without prior written approval of the Company. Any unauthorized alteration, forgery or falsification of the content or appearance of this document is unlawful and offenders may be prosecuted to the fullest extent of the law.

Band12_1_4MHz_QPSK_6_0_LowCH23017-699.7

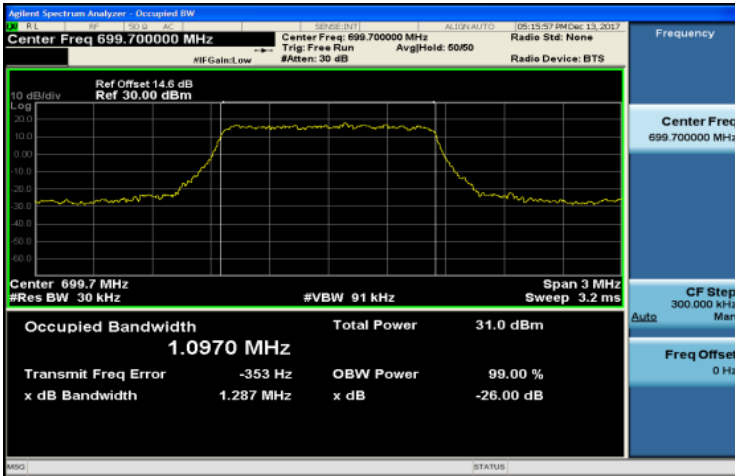

Band12_1_4MHz_16QAM_6_0_LowCH23017-699.7

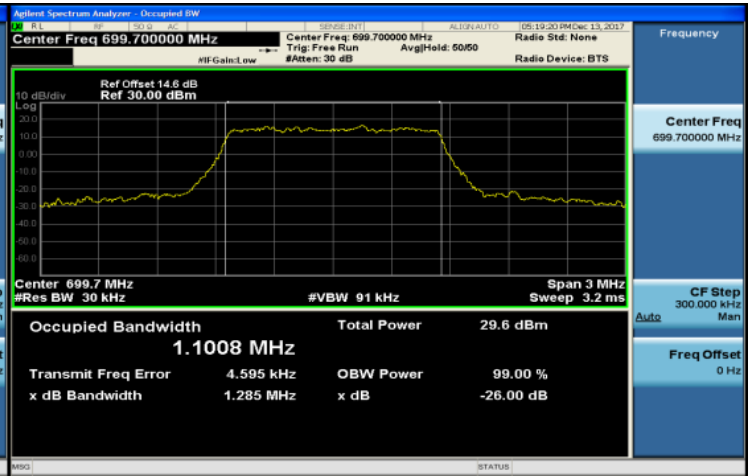

Band12_1_4MHz_QPSK_6_0_MidCH23095-707.5

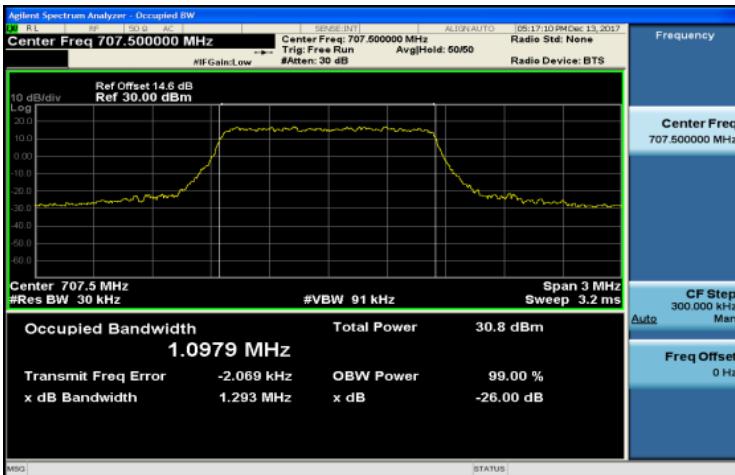

Band12_1_4MHz_16QAM_6_0_MidCH23095-707.5

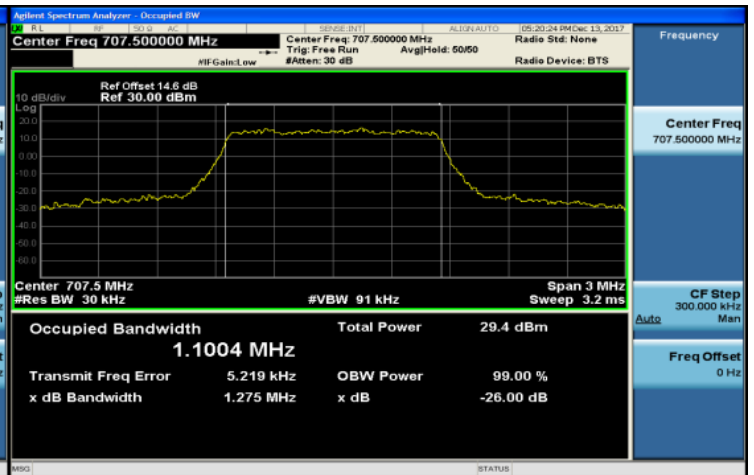

Band12_1_4MHz_QPSK_6_0_HighCH23173-715.3

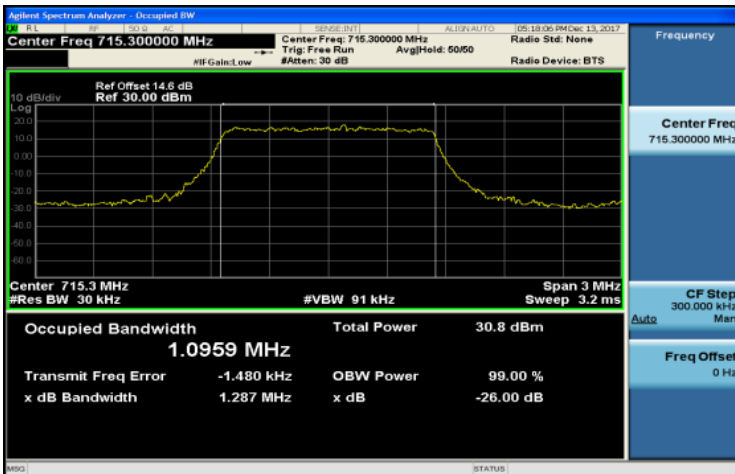

Band12_1_4MHz_16QAM_6_0_HighCH23173-715.3

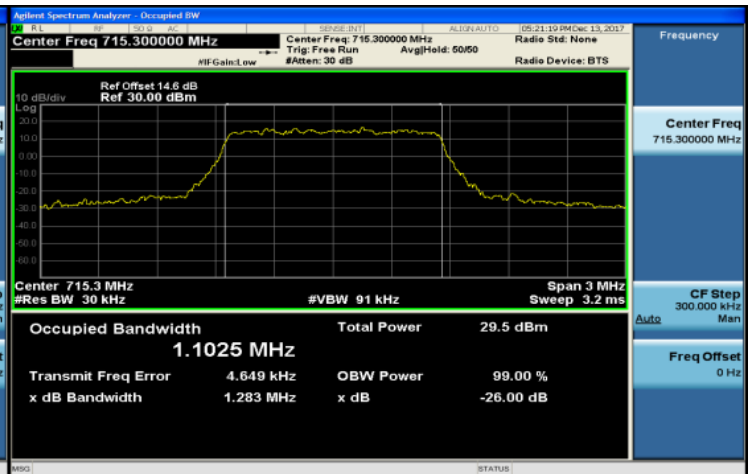

Unless otherwise stated the results shown in this test report refer only to the sample(s) tested and such sample(s) are retained for 90 days only.

除非另有說明，此報告結果僅對測試之樣品負責，同時此樣品僅保留90天。本報告未經本公司書面許可，不可部份複製。

This document is issued by the Company subject to its General Conditions of Service printed overleaf, available on request or accessible at www.sgs.com/terms_and_conditions.htm and, for electronic format documents, subject to Terms and Conditions for Electronic Documents at www.sgs.com/terms_e-document.htm. Attention is drawn to the limitation of liability, indemnification and jurisdiction issues defined therein. Any holder of this document is advised that information contained hereon reflects the Company's findings at the time of its intervention only and within the limits of Client's instructions, if any. The Company's sole responsibility is to its Client and this document does not exonerate parties to a transaction from exercising all their rights and obligations under the transaction documents. This document cannot be reproduced except in full, without prior written approval of the Company. Any unauthorized alteration, forgery or falsification of the content or appearance of this document is unlawful and offenders may be prosecuted to the fullest extent of the law.

Band12_3MHz_QPSK_15_0_LowCH23025-700.5

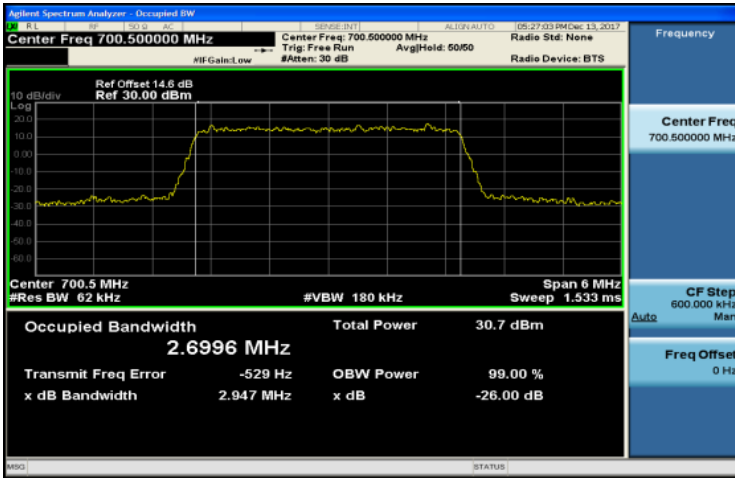

Band12_3MHz_16QAM_15_0_LowCH23025-700.5

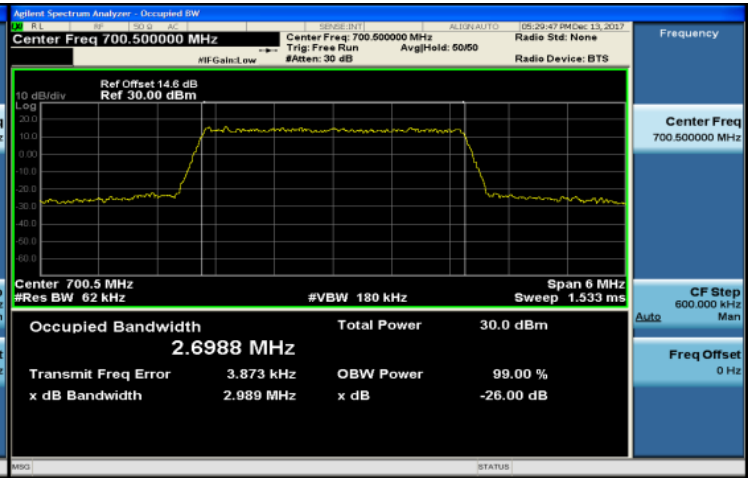

Band12_3MHz_QPSK_15_0_MidCH23095-707.5

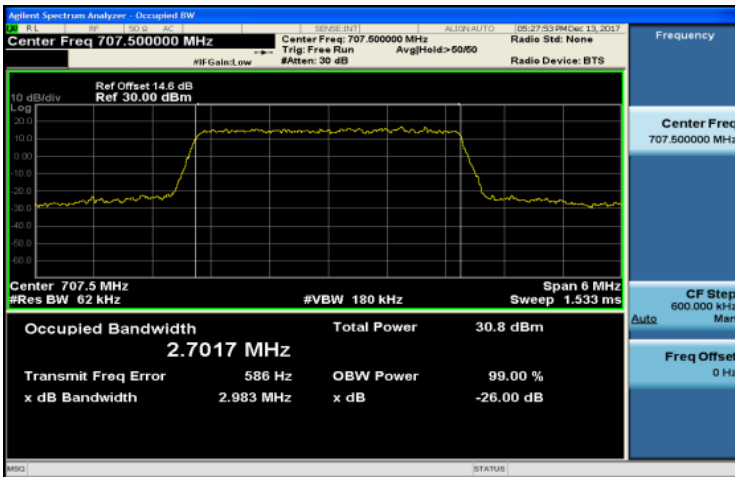

Band12_3MHz_16QAM_15_0_MidCH23095-707.5

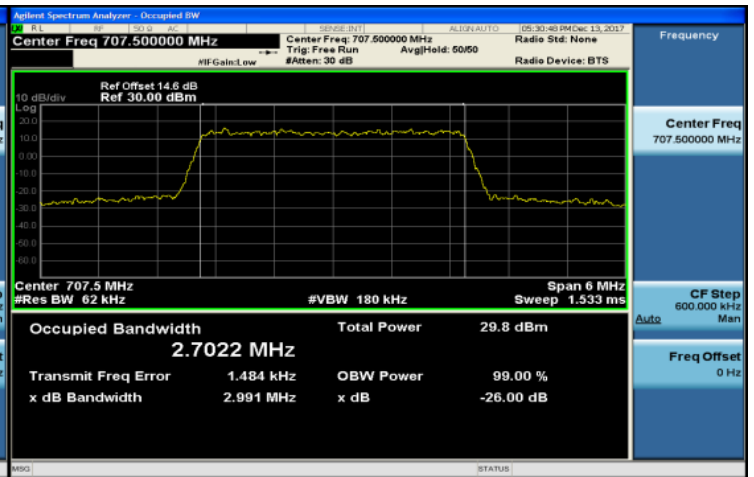

Band12_3MHz_QPSK_15_0_HighCH23165-714.5

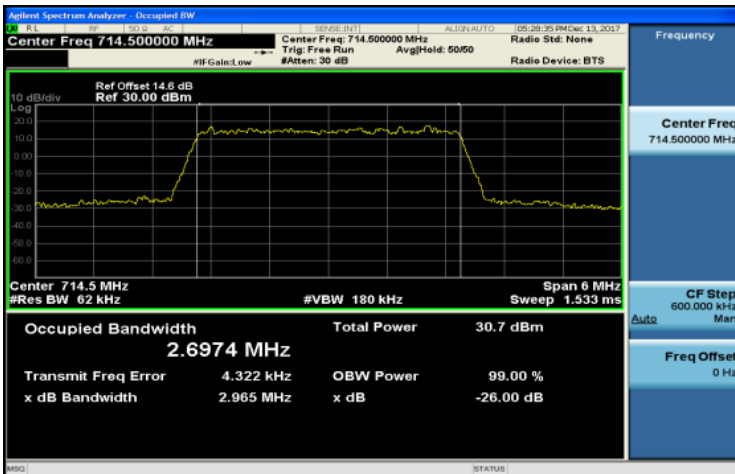

Band12_3MHz_16QAM_15_0_HighCH23165-714.5

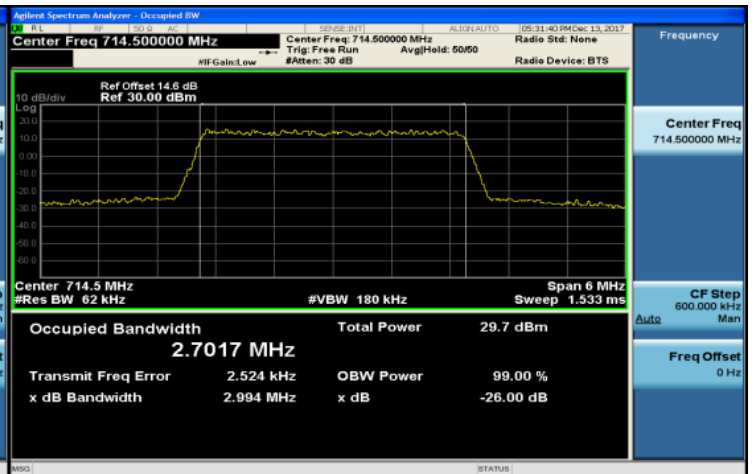

Unless otherwise stated the results shown in this test report refer only to the sample(s) tested and such sample(s) are retained for 90 days only.

除非另有說明，此報告結果僅對測試之樣品負責，同時此樣品僅保留90天。本報告未經本公司書面許可，不可部份複製。

This document is issued by the Company subject to its General Conditions of Service printed overleaf, available on request or accessible at www.sgs.com/terms_and_conditions.htm and, for electronic format documents, subject to Terms and Conditions for Electronic Documents at www.sgs.com/terms_e-document.htm. Attention is drawn to the limitation of liability, indemnification and jurisdiction issues defined therein. Any holder of this document is advised that information contained hereon reflects the Company's findings at the time of its intervention only and within the limits of Client's instructions, if any. The Company's sole responsibility is to its Client and this document does not exonerate parties to a transaction from exercising all their rights and obligations under the transaction documents. This document cannot be reproduced except in full, without prior written approval of the Company. Any unauthorized alteration, forgery or falsification of the content or appearance of this document is unlawful and offenders may be prosecuted to the fullest extent of the law.

Band12_5MHz_QPSK_25_0_LowCH23035-701.5

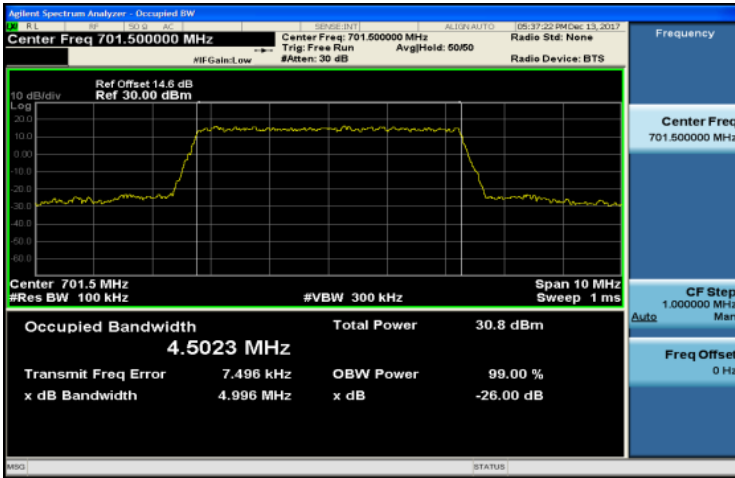

Band12_5MHz_16QAM_25_0_LowCH23035-701.5

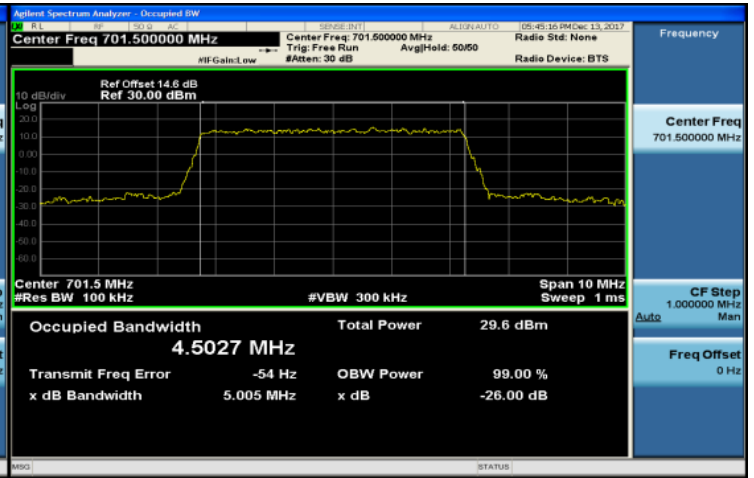

Band12_5MHz_QPSK_25_0_MidCH23095-707.5

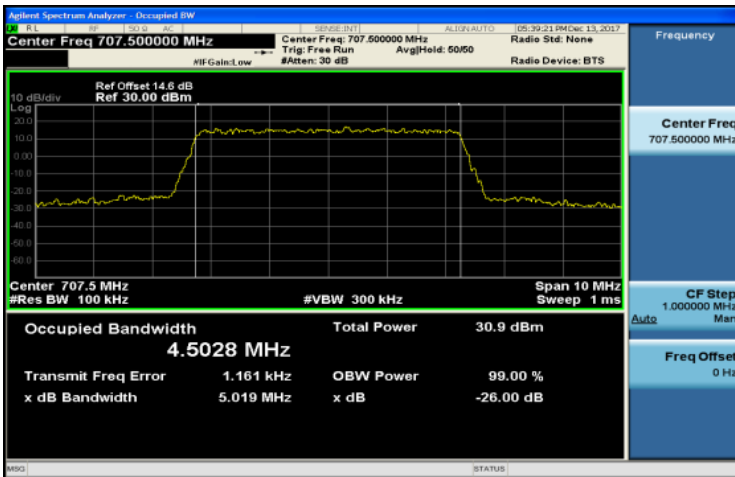

Band12_5MHz_16QAM_25_0_MidCH23095-707.5

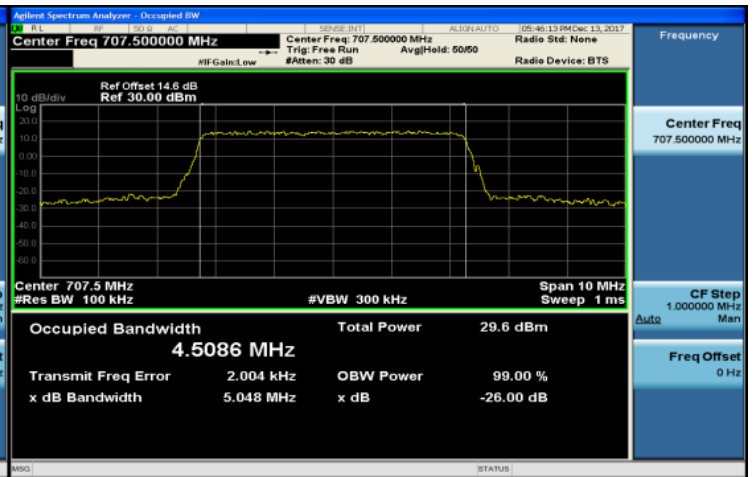

Band12_5MHz_QPSK_25_0_HighCH23155-713.5

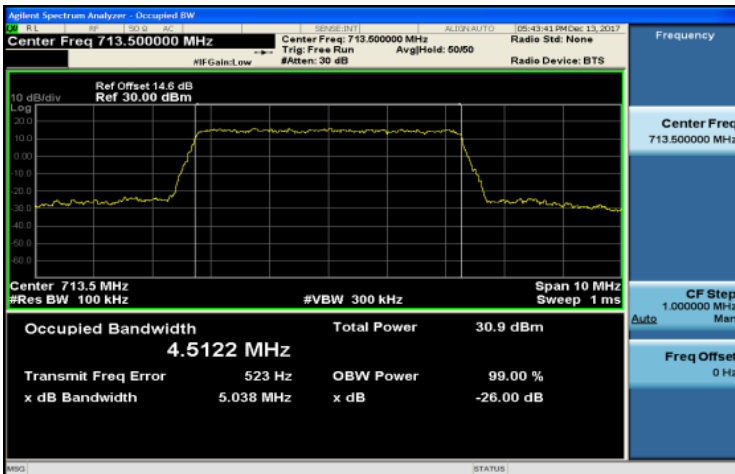

Band12_5MHz_16QAM_25_0_HighCH23155-713.5

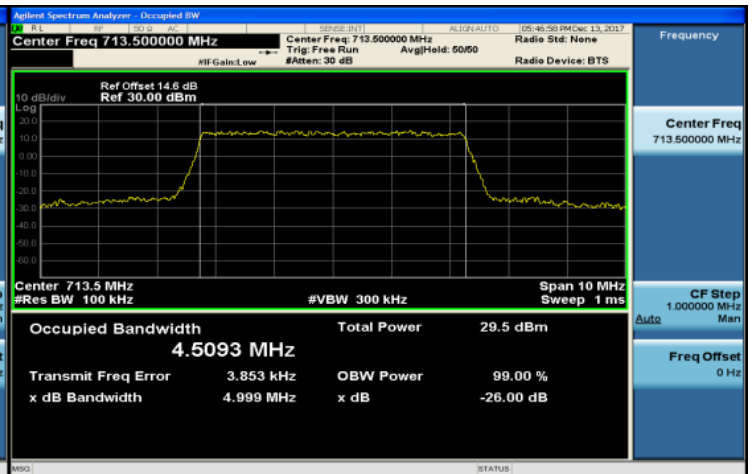

Unless otherwise stated the results shown in this test report refer only to the sample(s) tested and such sample(s) are retained for 90 days only.

除非另有說明，此報告結果僅對測試之樣品負責，同時此樣品僅保留90天。本報告未經本公司書面許可，不可部份複製。

This document is issued by the Company subject to its General Conditions of Service printed overleaf, available on request or accessible at www.sgs.com/terms_and_conditions.htm and, for electronic format documents, subject to Terms and Conditions for Electronic Documents at www.sgs.com/terms_e-document.htm. Attention is drawn to the limitation of liability, indemnification and jurisdiction issues defined therein. Any holder of this document is advised that information contained hereon reflects the Company's findings at the time of its intervention only and within the limits of Client's instructions, if any. The Company's sole responsibility is to its Client and this document does not exonerate parties to a transaction from exercising all their rights and obligations under the transaction documents. This document cannot be reproduced except in full, without prior written approval of the Company. Any unauthorized alteration, forgery or falsification of the content or appearance of this document is unlawful and offenders may be prosecuted to the fullest extent of the law.

Band12_10MHz_OPSK_50_0_LowCH23060-704

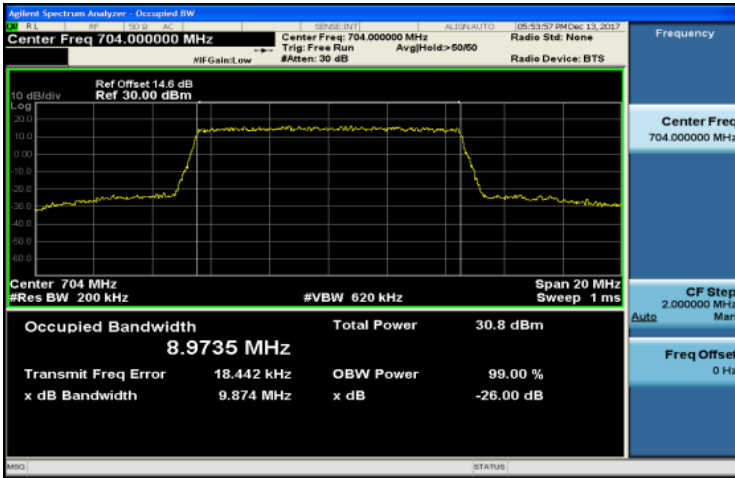

Band12_10MHz_16QAM_50_0_LowCH23060-704

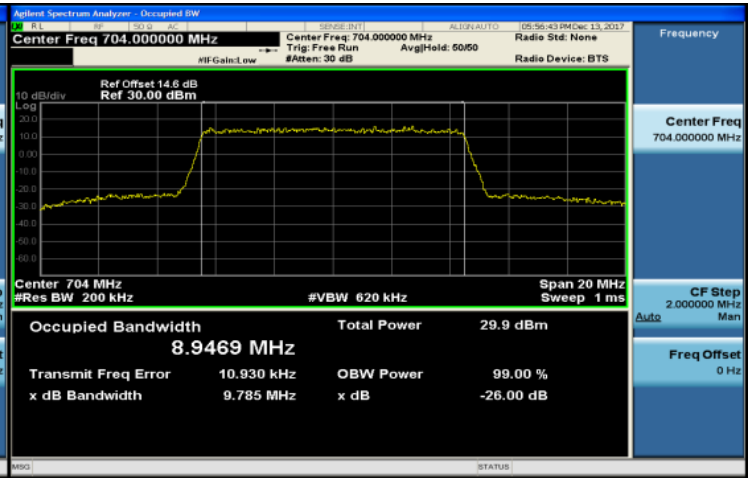

Band12_10MHz_OPSK_50_0_MidCH23095-707.5

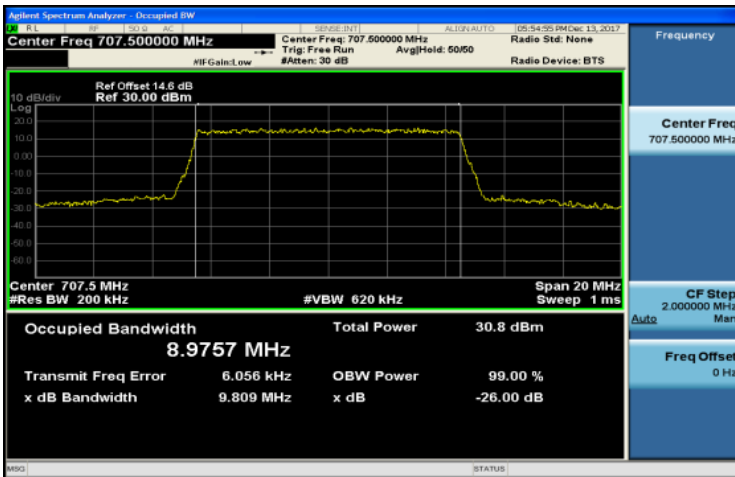

Band12_10MHz_16QAM_50_0_MidCH23095-707.5

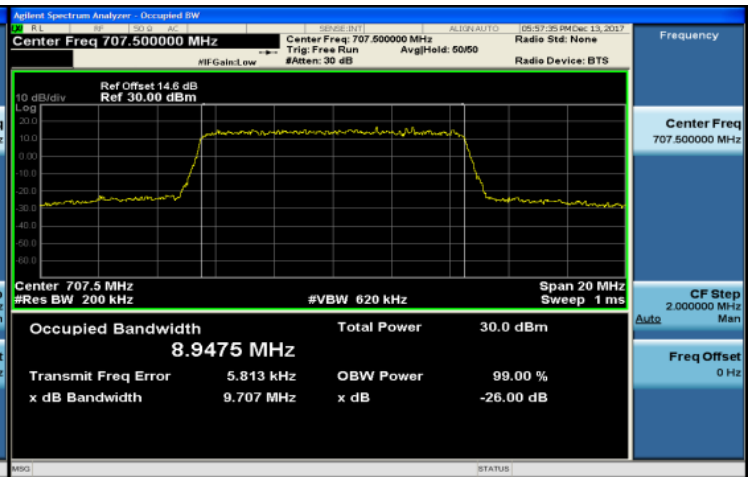

Band12_10MHz_OPSK_50_0_HighCH23130-711

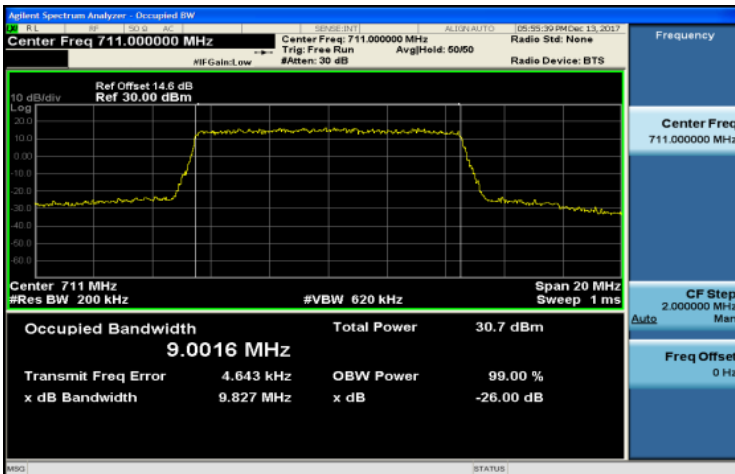

Band12_10MHz_16QAM_50_0_HighCH23130-711

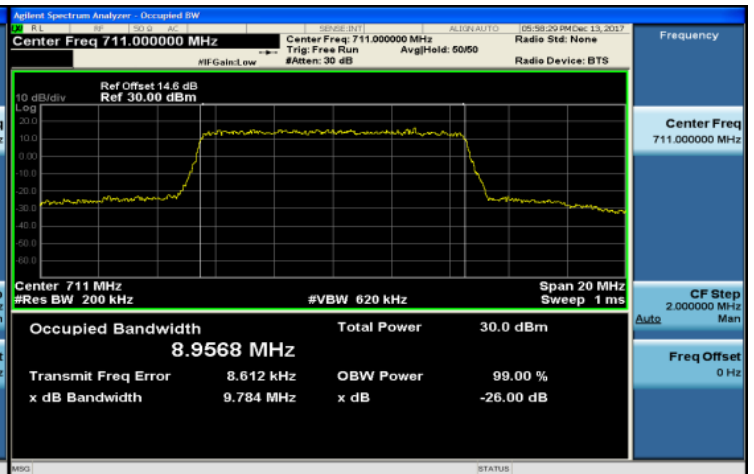

Unless otherwise stated the results shown in this test report refer only to the sample(s) tested and such sample(s) are retained for 90 days only.

除非另有說明，此報告結果僅對測試之樣品負責，同時此樣品僅保留90天。本報告未經本公司書面許可，不可部份複製。

This document is issued by the Company subject to its General Conditions of Service printed overleaf, available on request or accessible at www.sgs.com/terms_and_conditions.htm and, for electronic format documents, subject to Terms and Conditions for Electronic Documents at www.sgs.com/terms_e-document.htm. Attention is drawn to the limitation of liability, indemnification and jurisdiction issues defined therein. Any holder of this document is advised that information contained hereon reflects the Company's findings at the time of its intervention only and within the limits of Client's instructions, if any. The Company's sole responsibility is to its Client and this document does not exonerate parties to a transaction from exercising all their rights and obligations under the transaction documents. This document cannot be reproduced except in full, without prior written approval of the Company. Any unauthorized alteration, forgery or falsification of the content or appearance of this document is unlawful and offenders may be prosecuted to the fullest extent of the law.

Band17_5MHz_QPSK_25_0_LowCH23755-706.5

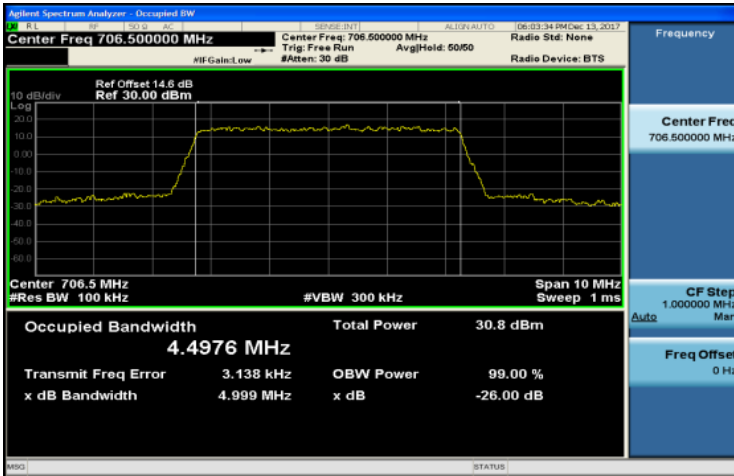

Band17_5MHz_16QAM_25_0_LowCH23755-706.5

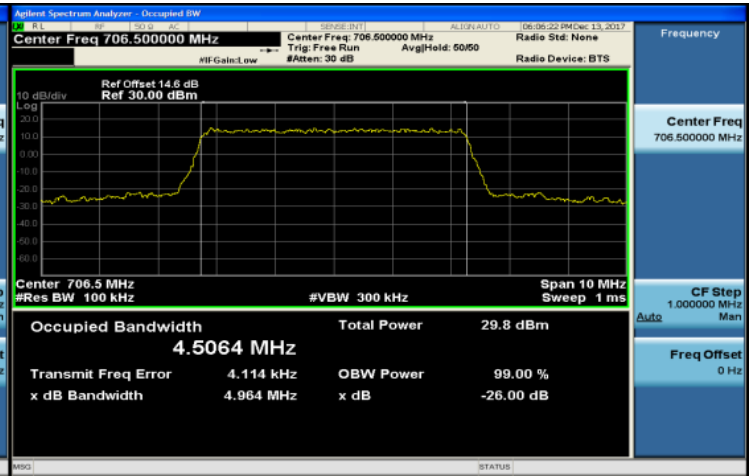

Band17_5MHz_QPSK_25_0_MidCH23790-710

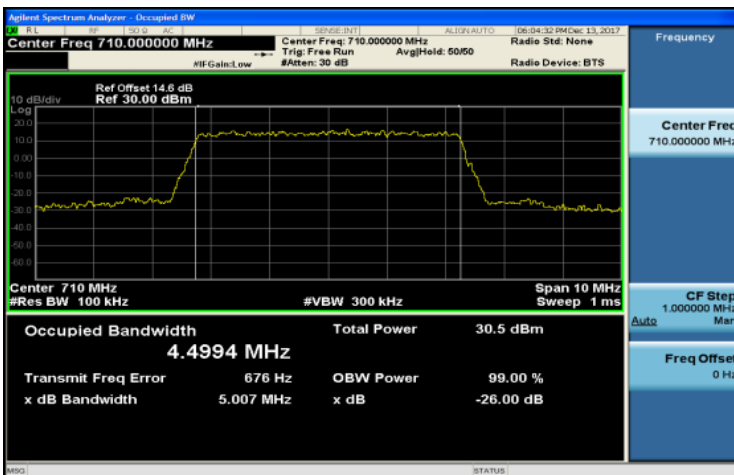

Band17_5MHz_16QAM_25_0_MidCH23790-710

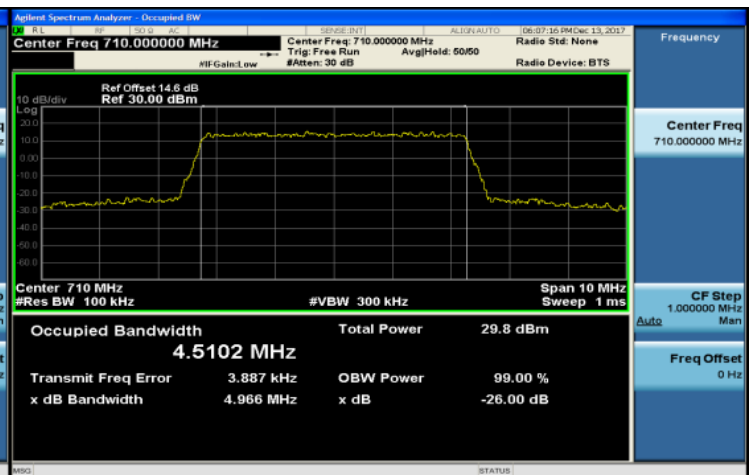

Band17_5MHz_QPSK_25_0_HighCH23825-713.5

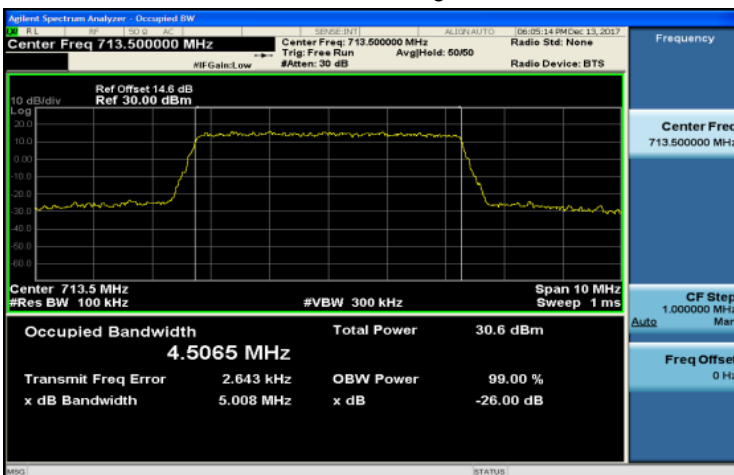

Band17_5MHz_16QAM_25_0_HighCH23825-713.5

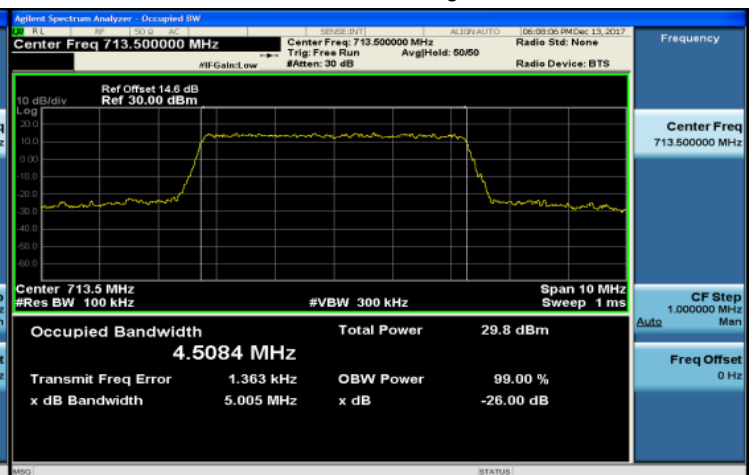

Unless otherwise stated the results shown in this test report refer only to the sample(s) tested and such sample(s) are retained for 90 days only.

除非另有說明，此報告結果僅對測試之樣品負責，同時此樣品僅保留90天。本報告未經本公司書面許可，不可部份複製。

This document is issued by the Company subject to its General Conditions of Service printed overleaf, available on request or accessible at www.sgs.com/terms_and_conditions.htm and, for electronic format documents, subject to Terms and Conditions for Electronic Documents at www.sgs.com/terms_e-document.htm. Attention is drawn to the limitation of liability, indemnification and jurisdiction issues defined therein. Any holder of this document is advised that information contained hereon reflects the Company's findings at the time of its intervention only and within the limits of Client's instructions, if any. The Company's sole responsibility is to its Client and this document does not exonerate parties to a transaction from exercising all their rights and obligations under the transaction documents. This document cannot be reproduced except in full, without prior written approval of the Company. Any unauthorized alteration, forgery or falsification of the content or appearance of this document is unlawful and offenders may be prosecuted to the fullest extent of the law.

Band17_10MHz_QPSK_50_0_LowCH23780-709

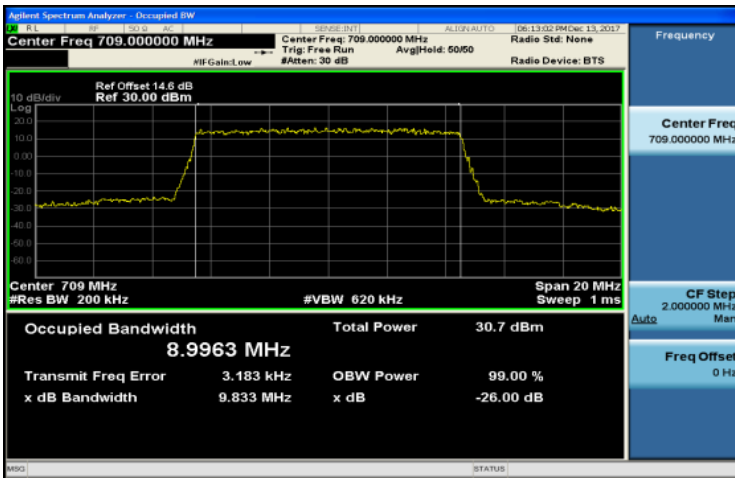

Band17_10MHz_16QAM_50_0_LowCH23780-709

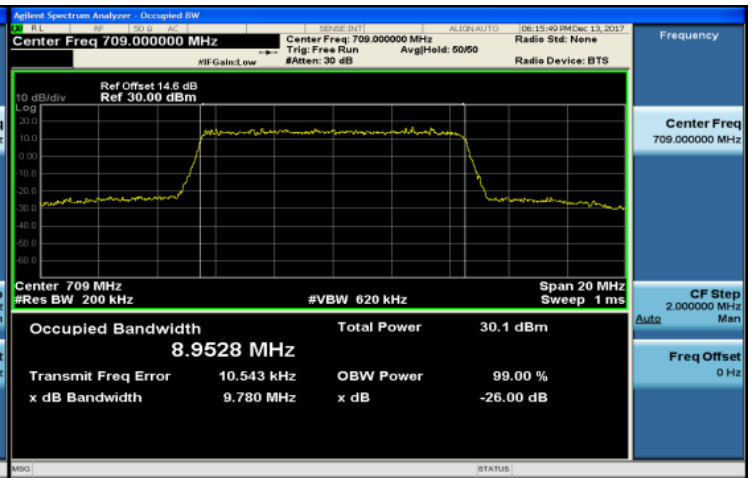

Band17_10MHz_QPSK_50_0_MidCH23790-710

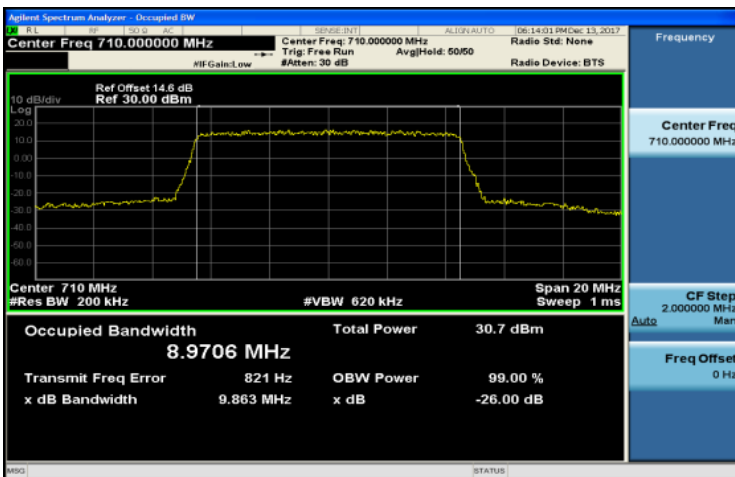

Band17_10MHz_16QAM_50_0_MidCH23790-710

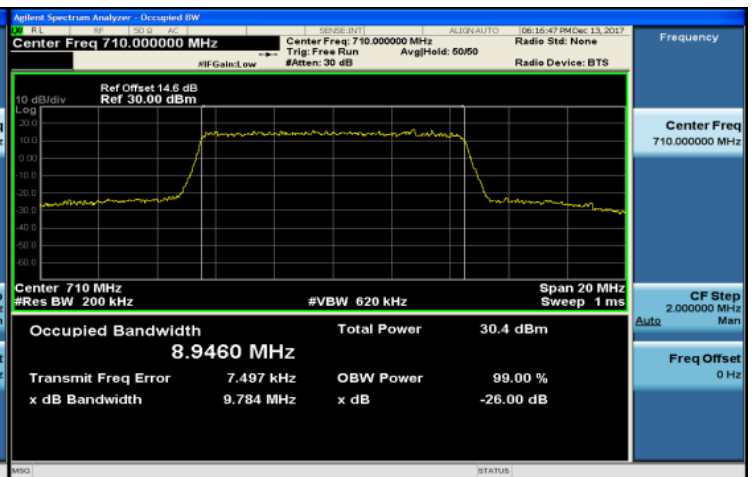

Band17_10MHz_QPSK_50_0_HighCH23800-711

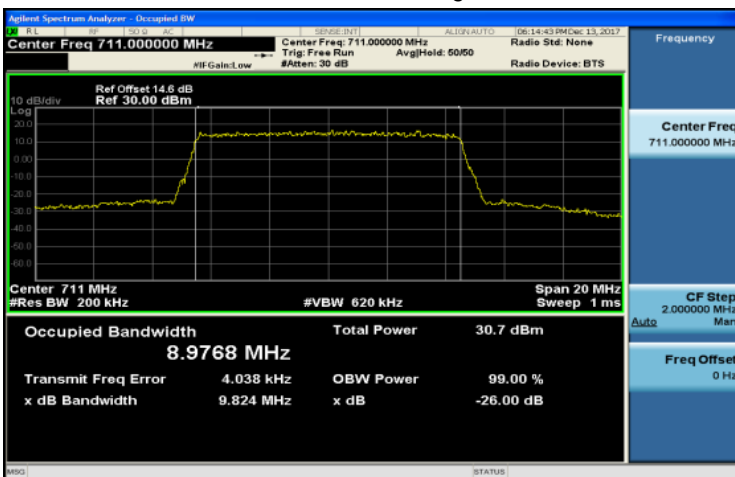

Band17_10MHz_16QAM_50_0_HighCH23800-711

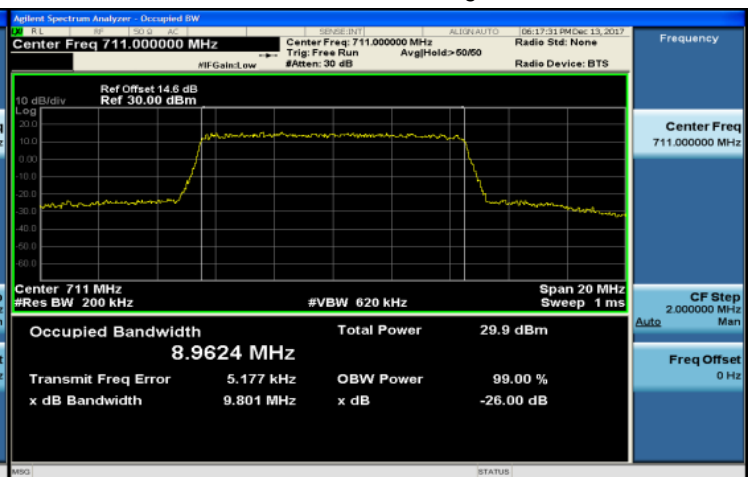

Unless otherwise stated the results shown in this test report refer only to the sample(s) tested and such sample(s) are retained for 90 days only.

除非另有說明，此報告結果僅對測試之樣品負責，同時此樣品僅保留90天。本報告未經本公司書面許可，不可部份複製。

This document is issued by the Company subject to its General Conditions of Service printed overleaf, available on request or accessible at www.sgs.com/terms_and_conditions.htm and, for electronic format documents, subject to Terms and Conditions for Electronic Documents at www.sgs.com/terms_e-document.htm. Attention is drawn to the limitation of liability, indemnification and jurisdiction issues defined therein. Any holder of this document is advised that information contained hereon reflects the Company's findings at the time of its intervention only and within the limits of Client's instructions, if any. The Company's sole responsibility is to its Client and this document does not exonerate parties to a transaction from exercising all their rights and obligations under the transaction documents. This document cannot be reproduced except in full, without prior written approval of the Company. Any unauthorized alteration, forgery or falsification of the content or appearance of this document is unlawful and offenders may be prosecuted to the fullest extent of the law.

9. OUT OF BAND EMISSION AT ANTENNA TERMINALS

9.1. Standard Applicable

FCC §22.917(a), §24.238(a), §27.53(h), *Out of band emissions*. The power of any emission outside of the authorized operating frequency ranges must be attenuated below the transmitting power (P) by a factor of at least $43 + 10 \log(P)$ dB.

FCC §27.53(g)

Compliance with this provision is based on the use of measurement instrumentation employing a resolution bandwidth of 100 kilohertz or greater. However, in the 100 kilohertz bands immediately outside and adjacent to a licensee's frequency block, a resolution bandwidth of at least 30 kHz may be employed.

FCC §27.53(h) (3)

Compliance with this provision is based on the use of measurement instrumentation employing a resolution bandwidth of 1 megahertz or greater. However, in the 1 megahertz bands immediately outside and adjacent to the licensee's frequency block, a resolution bandwidth of at least one percent of the emission bandwidth of the fundamental emission of the transmitter may be employed. The emission bandwidth is defined as the width of the signal between two points, one below the carrier center frequency and one above the carrier center frequency, outside of which all emissions are attenuated at least 26 dB below the transmitter power.

Unless otherwise stated the results shown in this test report refer only to the sample(s) tested and such sample(s) are retained for 90 days only.

除非另有說明，此報告結果僅對測試之樣品負責，同時此樣品僅保留90天。本報告未經本公司書面許可，不可部份複製。

This document is issued by the Company subject to its General Conditions of Service printed overleaf, available on request or accessible at www.sgs.com/terms_and_conditions.htm and, for electronic format documents, subject to Terms and Conditions for Electronic Documents at www.sgs.com/terms_e-document.htm. Attention is drawn to the limitation of liability, indemnification and jurisdiction issues defined therein. Any holder of this document is advised that information contained hereon reflects the Company's findings at the time of its intervention only and within the limits of Client's instructions, if any. The Company's sole responsibility is to its Client and this document does not exonerate parties to a transaction from exercising all their rights and obligations under the transaction documents. This document cannot be reproduced except in full, without prior written approval of the Company. Any unauthorized alteration, forgery or falsification of the content or appearance of this document is unlawful and offenders may be prosecuted to the fullest extent of the law.

SGS Taiwan Ltd.

台灣檢驗科技股份有限公司

No.134,WuKungRoad,NewTaipeiIndustrialPark,WukuDistrict,NewTaipeiCity,Taiwan24803/新北市五股區新北產業園區五工路 134 號

t (886-2) 2299-3279

f (886-2) 2298-0488

www.tw.sgs.com

Member of SGS Group

FCC §27.53(m) (4)

For mobile digital stations, the attenuation factor shall be not less than $40 + 10 \log (P)$ dB on all frequencies between the channel edge and 5 megahertz from the channel edge, $43 + 10 \log (P)$ dB on all frequencies between 5 megahertz and X megahertz from the channel edge, and $55 + 10 \log (P)$ dB on all frequencies more than X megahertz from the channel edge, where X is the greater of 6 megahertz or the actual emission bandwidth as defined in paragraph (m)(6) of this section. In addition, the attenuation factor shall not be less than $43 + 10 \log (P)$ dB on all frequencies between 2490.5 MHz and 2496 MHz and $55 + 10 \log (P)$ dB at or below 2490.5 MHz. Mobile Satellite Service licensees operating on frequencies below 2495 MHz may also submit a documented interference complaint against BRS licensees operating on channel BRS Channel 1 on the same terms and conditions as adjacent channel BRS or EBS licensees.

Measurement procedure. Compliance with these rules is based on the use of measurement instrumentation employing a resolution bandwidth of 1 megahertz or greater. However, in the 1 MHz bands immediately outside and adjacent to the frequency block a resolution bandwidth of at least one percent of the emission bandwidth of the fundamental emission of the transmitter may be employed; for mobile digital stations, in the 1 megahertz bands immediately outside and adjacent to the frequency block a resolution bandwidth of at least two percent may be employed, except when the 1 megahertz band is 2495-2496 MHz, in which case a resolution bandwidth of at least one percent may be employed. A narrower resolution bandwidth is permitted in all cases to improve measurement accuracy provided the measured power is integrated over the full required measurement bandwidth (i.e. 1 megahertz or 1 percent of emission bandwidth, as specified; or 1 megahertz or 2 percent for mobile digital stations, except in the band 2495-2496 MHz). The emission bandwidth is defined as the width of the signal between two points, one below the carrier center frequency and one above the carrier center frequency, outside of which all emissions are attenuated at least 26 dB below the transmitter power. With respect to television operations, measurements must be made of the separate visual and aural operating powers at sufficiently frequent intervals to ensure compliance with the rules.

Unless otherwise stated the results shown in this test report refer only to the sample(s) tested and such sample(s) are retained for 90 days only.

除非另有說明，此報告結果僅對測試之樣品負責，同時此樣品僅保留90天。本報告未經本公司書面許可，不可部份複製。

This document is issued by the Company subject to its General Conditions of Service printed overleaf, available on request or accessible at www.sgs.com/terms_and_conditions.htm and, for electronic format documents, subject to Terms and Conditions for Electronic Documents at www.sgs.com/terms_e-document.htm. Attention is drawn to the limitation of liability, indemnification and jurisdiction issues defined therein. Any holder of this document is advised that information contained hereon reflects the Company's findings at the time of its intervention only and within the limits of Client's instructions, if any. The Company's sole responsibility is to its Client and this document does not exonerate parties to a transaction from exercising all their rights and obligations under the transaction documents. This document cannot be reproduced except in full, without prior written approval of the Company. Any unauthorized alteration, forgery or falsification of the content or appearance of this document is unlawful and offenders may be prosecuted to the fullest extent of the law.

SGS Taiwan Ltd.

台灣檢驗科技股份有限公司

No.134,WuKungRoad,NewTaipeiIndustrialPark,WukuDistrict,NewTaipeiCity,Taiwan24803/新北市五股區新北產業園區五工路 134 號

t (886-2) 2299-3279

f (886-2) 2298-0488

www.tw.sgs.com

Member of SGS Group

9.2. Test SET-UP

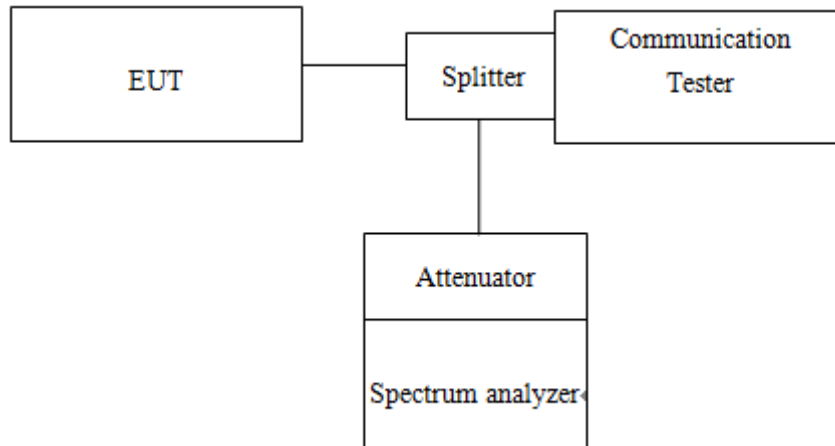

9.3. Measurement Procedure

Conducted Emission

The RF output of the transceiver was connected to a spectrum analyzer through appropriate attenuation. The resolution bandwidth of the spectrum analyzer was set at 1MHz, sufficient scans were taken to show the out of band Emissions if any up to 10th harmonic.

1. To connect Antenna Port of EUT to Spectrum.
2. Set RBW = 1MHz & VBW = 1MHz on Spectrum.
3. Allow trace to fully stabilize
4. Repeat above procedures until all default test channel measured were complete.

Band Edge

1. To connect Antenna Port of EUT to Spectrum.
2. The band edge of low and high channels for the highest RF powers was measured. Setting RBW \geq 1% EBW.
3. Allow trace to fully stabilize
4. Repeat above procedures until all default test channel measured were complete.

Unless otherwise stated the results shown in this test report refer only to the sample(s) tested and such sample(s) are retained for 90 days only.

除非另有說明，此報告結果僅對測試之樣品負責，同時此樣品僅保留90天。本報告未經本公司書面許可，不可部份複製。

This document is issued by the Company subject to its General Conditions of Service printed overleaf, available on request or accessible at www.sgs.com/terms_and_conditions.htm and, for electronic format documents, subject to Terms and Conditions for Electronic Documents at www.sgs.com/terms_e-document.htm. Attention is drawn to the limitation of liability, indemnification and jurisdiction issues defined therein. Any holder of this document is advised that information contained hereon reflects the Company's findings at the time of its intervention only and within the limits of Client's instructions, if any. The Company's sole responsibility is to its Client and this document does not exonerate parties to a transaction from exercising all their rights and obligations under the transaction documents. This document cannot be reproduced except in full, without prior written approval of the Company. Any unauthorized alteration, forgery or falsification of the content or appearance of this document is unlawful and offenders may be prosecuted to the fullest extent of the law.

9.4. Measurement Equipment Used

Conducted Emission (measured at antenna port) Test Site					
EQUIPMENT TYPE	MFR	MODEL NUMBER	SERIAL NUMBER	LAST CAL.	CAL DUE.
Power Meter	Anritsu	ML2495A	1005007	12/15/2017	12/14/2018
Power Sensor	Anritsu	MA2411B	917032	12/15/2017	12/14/2018
EXA Spectrum Analyzer	Agilent	N9030A	MY53120760	03/21/2017	03/20/2018
DC Block	Mini-Circuits	BLK-18-S+	1	01/05/2017	01/04/2018
Coaxial Cable	HU-BER+SUHNER	SUCOFLEX 102	23670/2	01/05/2017	01/04/2018
Attenuator	Mini-Circuit	BW-S10W2+	2	01/05/2017	01/04/2018
Splitter	Agilent	11636B	N/A	01/05/2017	01/04/2018
DC Power Supply	Agilent	E3640A	MY52410006	10/26/2017	10/27/2018
Temperature Chamber	TERCHY	MHG-120LF	911009	05/19/2017	05/18/2018
Radio Communication Analyzer	R&S	CMU200	102189	02/11/2017	02/10/2018
Radio Communication Analyer	Anritsu	MT8820C	6201465317	01/03/2017	01/02/2018

9.5. Measurement Result:

Refer to next pages.

NOTE: The occurrence of the spike on the conducted emission is the signal of the fundamental emission.

Unless otherwise stated the results shown in this test report refer only to the sample(s) tested and such sample(s) are retained for 90 days only.

除非另有說明，此報告結果僅對測試之樣品負責，同時此樣品僅保留90天。本報告未經本公司書面許可，不可部份複製。

This document is issued by the Company subject to its General Conditions of Service printed overleaf, available on request or accessible at www.sgs.com/terms_and_conditions.htm and, for electronic format documents, subject to Terms and Conditions for Electronic Documents at www.sgs.com/terms_e-document.htm. Attention is drawn to the limitation of liability, indemnification and jurisdiction issues defined therein. Any holder of this document is advised that information contained hereon reflects the Company's findings at the time of its intervention only and within the limits of Client's instructions, if any. The Company's sole responsibility is to its Client and this document does not exonerate parties to a transaction from exercising all their rights and obligations under the transaction documents. This document cannot be reproduced except in full, without prior written approval of the Company. Any unauthorized alteration, forgery or falsification of the content or appearance of this document is unlawful and offenders may be prosecuted to the fullest extent of the law.

SGS Taiwan Ltd.

No.134,WuKungRoad,NewTaipeiIndustrialPark,WukuDistrict,NewTaipeiCity,Taiwan24803/新北市五股區新北產業園區五工路 134 號

台灣檢驗科技股份有限公司

t (886-2) 2299-3279

f (886-2) 2298-0488

www.tw.sgs.com

Member of SGS Group

30MHz~3GHz_GSM_850MHz_LowCH128-824.2



3GHz~10GHz_GSM_850MHz_MidCH190-836.6

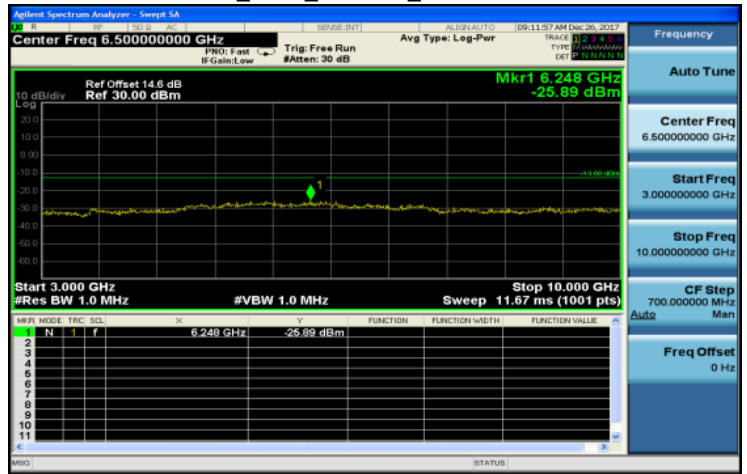

3GHz~10GHz_GSM_850MHz_LowCH128-824.2

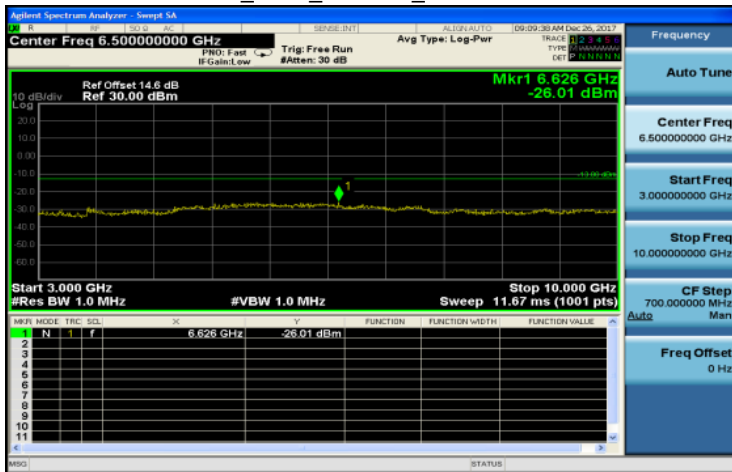

30MHz~3GHz_GSM_850MHz_HighCH251-848.8

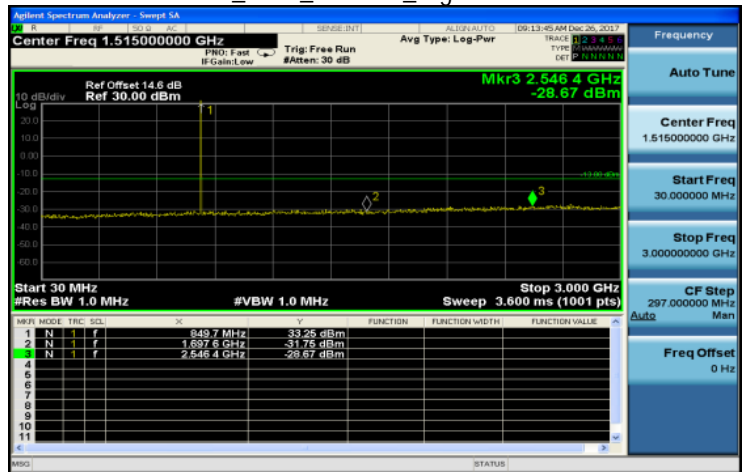

30MHz~3GHz_GSM_850MHz_MidCH190-836.6



3GHz~10GHz_GSM_850MHz_HighCH251-848.8

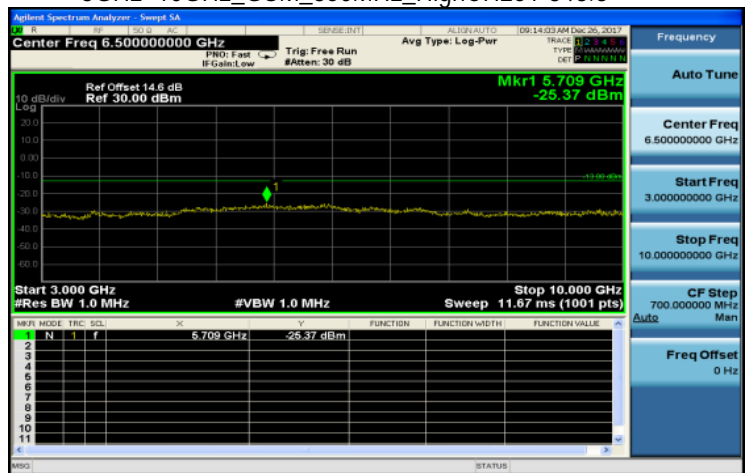

Unless otherwise stated the results shown in this test report refer only to the sample(s) tested and such sample(s) are retained for 90 days only.

除非另有說明，此報告結果僅對測試之樣品負責，同時此樣品僅保留90天。本報告未經本公司書面許可，不可部份複製。

This document is issued by the Company subject to its General Conditions of Service printed overleaf, available on request or accessible at www.sgs.com/terms_and_conditions.htm and, for electronic format documents, subject to Terms and Conditions for Electronic Documents at www.sgs.com/terms_e-document.htm. Attention is drawn to the limitation of liability, indemnification and jurisdiction issues defined therein. Any holder of this document is advised that information contained hereon reflects the Company's findings at the time of its intervention only and within the limits of Client's instructions, if any. The Company's sole responsibility is to its Client and this document does not exonerate parties to a transaction from exercising all their rights and obligations under the transaction documents. This document cannot be reproduced except in full, without prior written approval of the Company. Any unauthorized alteration, forgery or falsification of the content or appearance of this document is unlawful and offenders may be prosecuted to the fullest extent of the law.

30MHz~3GHz_GPRS_850MHz_LowCH128-824.2



3GHz~10GHz_GPRS_850MHz_MidCH190-836.6

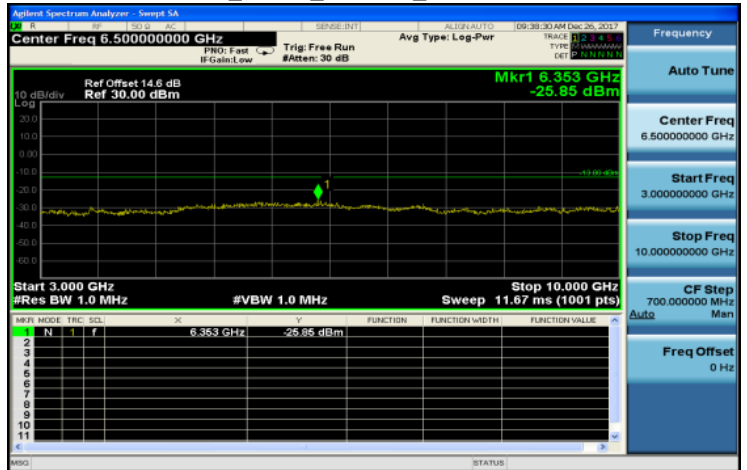

3GHz~10GHz_GPRS_850MHz_LowCH128-824.2

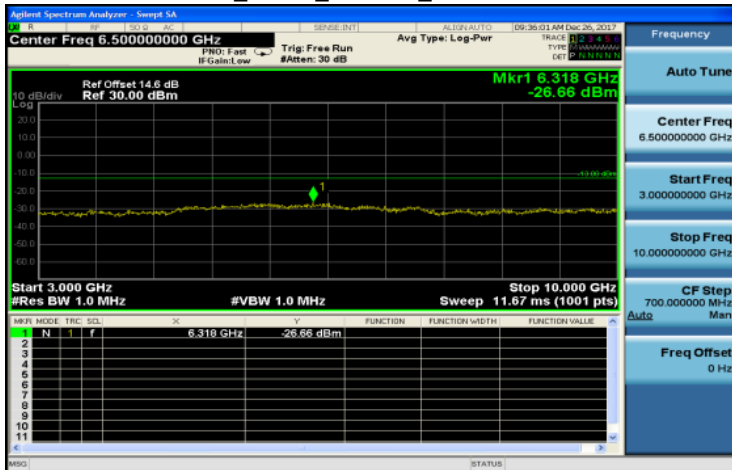

30MHz~3GHz_GPRS_850MHz_HighCH251-848.8

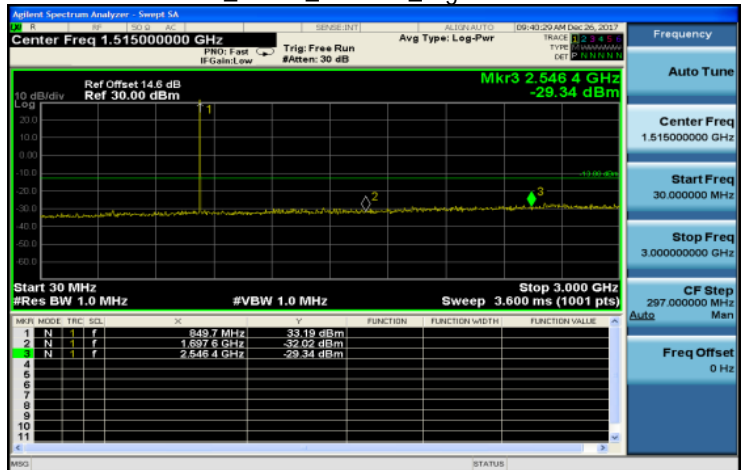

30MHz~3GHz_GPRS_850MHz_MidCH190-836.6



3GHz~10GHz_GPRS_850MHz_HighCH251-848.8

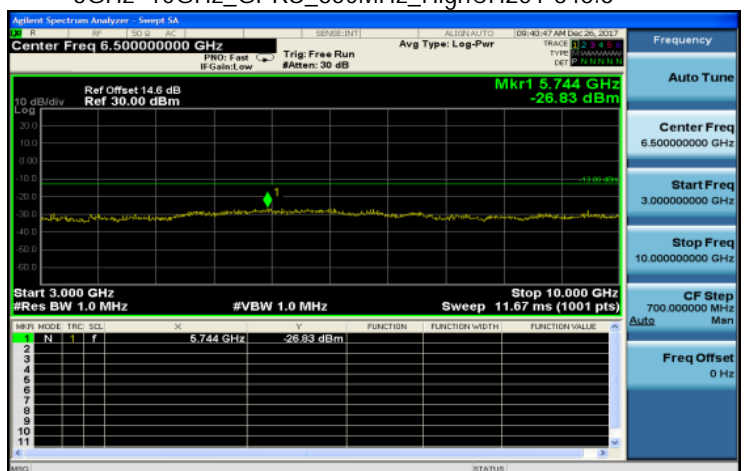

Unless otherwise stated the results shown in this test report refer only to the sample(s) tested and such sample(s) are retained for 90 days only.

除非另有說明，此報告結果僅對測試之樣品負責，同時此樣品僅保留90天。本報告未經本公司書面許可，不可部份複製。

This document is issued by the Company subject to its General Conditions of Service printed overleaf, available on request or accessible at www.sgs.com/terms_and_conditions.htm and, for electronic format documents, subject to Terms and Conditions for Electronic Documents at www.sgs.com/terms_e-document.htm. Attention is drawn to the limitation of liability, indemnification and jurisdiction issues defined therein. Any holder of this document is advised that information contained hereon reflects the Company's findings at the time of its intervention only and within the limits of Client's instructions, if any. The Company's sole responsibility is to its Client and this document does not exonerate parties to a transaction from exercising all their rights and obligations under the transaction documents. This document cannot be reproduced except in full, without prior written approval of the Company. Any unauthorized alteration, forgery or falsification of the content or appearance of this document is unlawful and offenders may be prosecuted to the fullest extent of the law.

30MHz-3GHz_GSM_1900MHz_LowCH512-1850.2

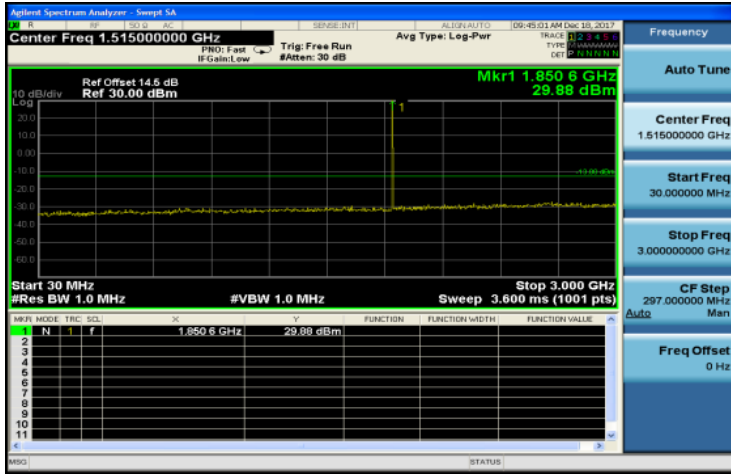

3GHz-10GHz_GSM_1900MHz_MidCH661-1880

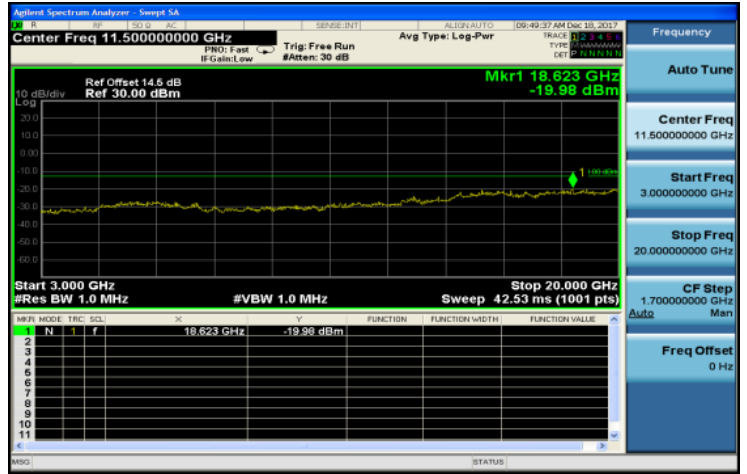

3GHz-10GHz_GSM_1900MHz_LowCH512-1850.2

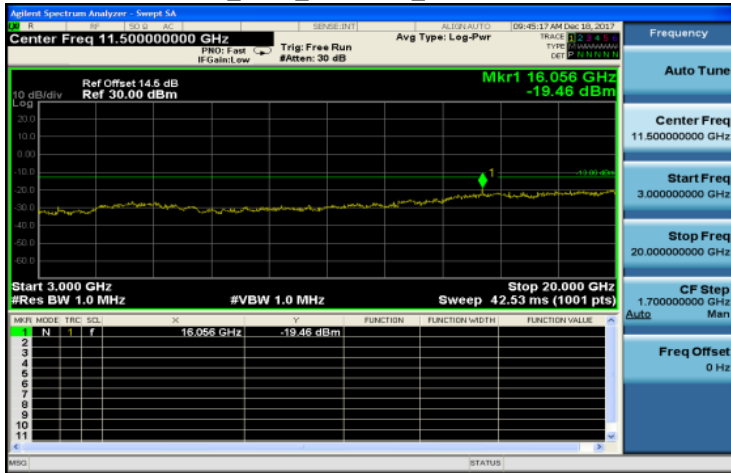

30MHz-3GHz_GSM_1900MHz_HighCH810-1909.8

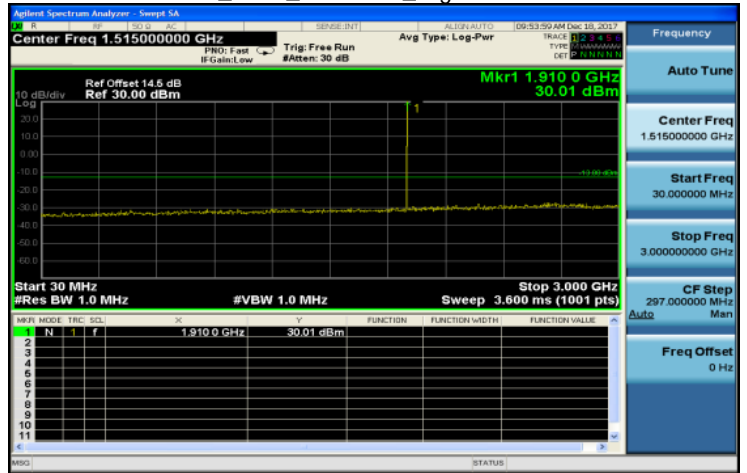

30MHz-3GHz_GSM_1900MHz_MidCH661-1880

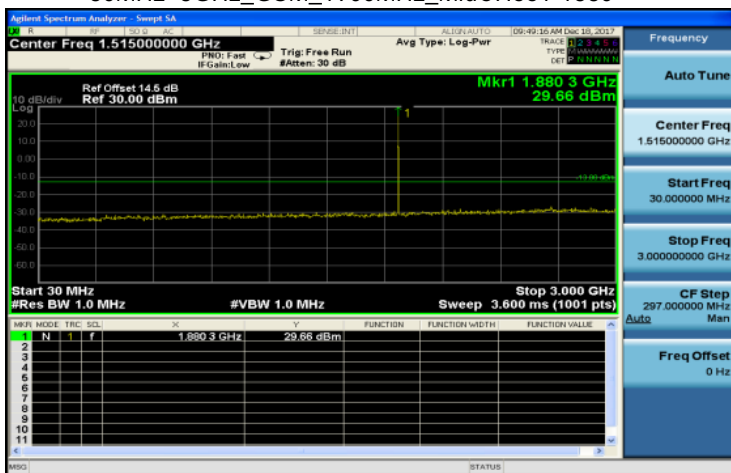

3GHz-10GHz_GSM_1900MHz_HighCH810-1909.8

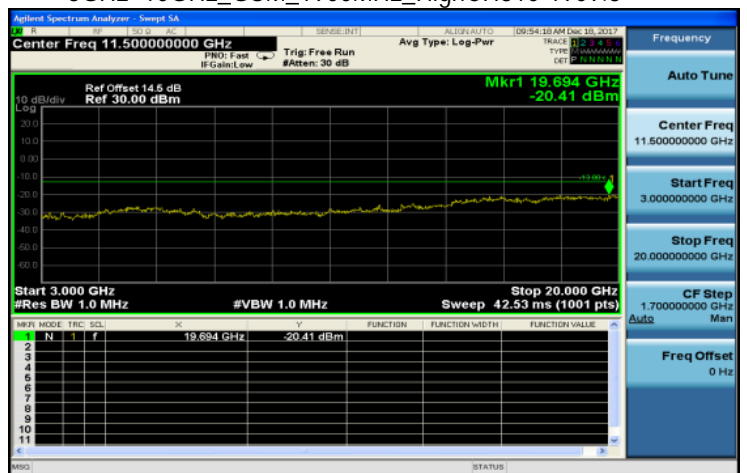

Unless otherwise stated the results shown in this test report refer only to the sample(s) tested and such sample(s) are retained for 90 days only.

除非另有說明，此報告結果僅對測試之樣品負責，同時此樣品僅保留90天。本報告未經本公司書面許可，不可部份複製。

This document is issued by the Company subject to its General Conditions of Service printed overleaf, available on request or accessible at www.sgs.com/terms_and_conditions.htm and, for electronic format documents, subject to Terms and Conditions for Electronic Documents at www.sgs.com/terms_e-document.htm. Attention is drawn to the limitation of liability, indemnification and jurisdiction issues defined therein. Any holder of this document is advised that information contained hereon reflects the Company's findings at the time of its intervention only and within the limits of Client's instructions, if any. The Company's sole responsibility is to its Client and this document does not exonerate parties to a transaction from exercising all their rights and obligations under the transaction documents. This document cannot be reproduced except in full, without prior written approval of the Company. Any unauthorized alteration, forgery or falsification of the content or appearance of this document is unlawful and offenders may be prosecuted to the fullest extent of the law.

30MHz~3GHz_GPRS_1900MHz_LowCH512-1850.2

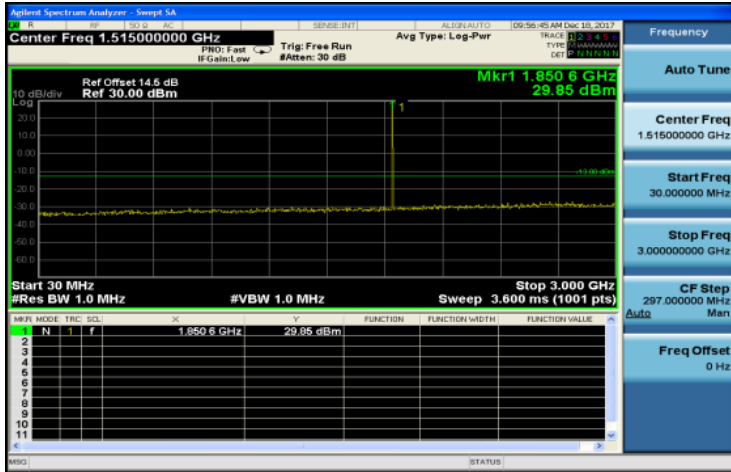

3GHz~10GHz_GPRS_1900MHz_MidCH661-1880

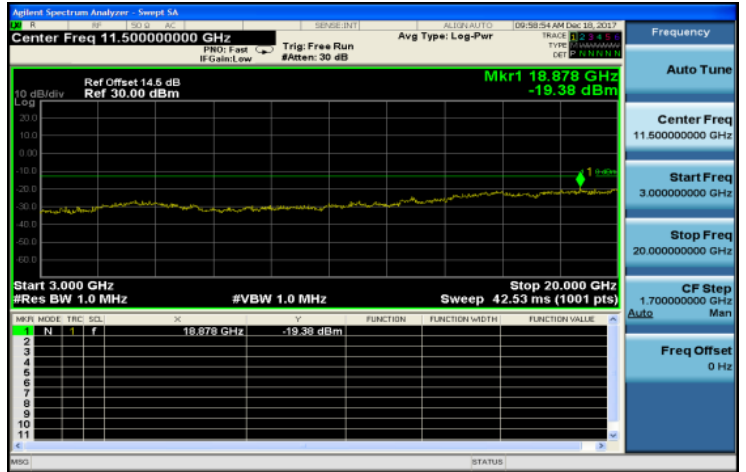

3GHz~10GHz_GPRS_1900MHz_LowCH512-1850.2



30MHz~3GHz_GPRS_1900MHz_HighCH810-1909.8

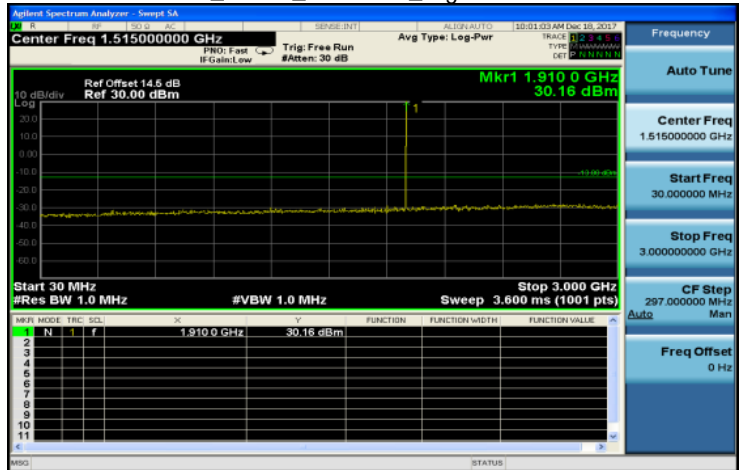

30MHz~3GHz_GPRS_1900MHz_MidCH661-1880

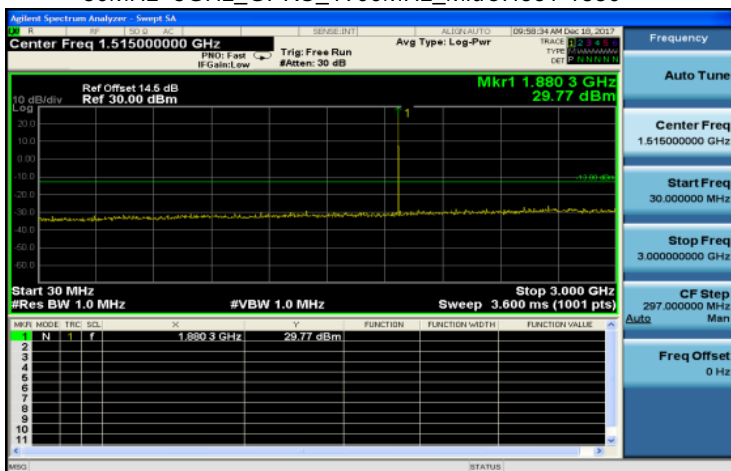

3GHz~10GHz_GPRS_1900MHz_HighCH810-1909.8

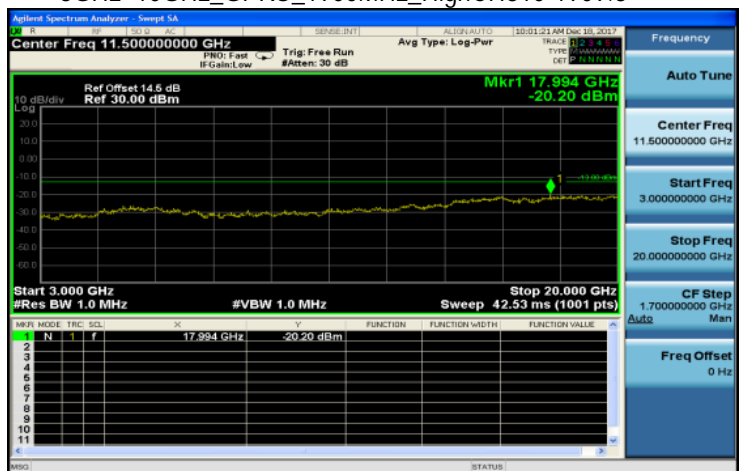

Unless otherwise stated the results shown in this test report refer only to the sample(s) tested and such sample(s) are retained for 90 days only.

除非另有說明，此報告結果僅對測試之樣品負責，同時此樣品僅保留90天。本報告未經本公司書面許可，不可部份複製。

This document is issued by the Company subject to its General Conditions of Service printed overleaf, available on request or accessible at www.sgs.com/terms_and_conditions.htm and, for electronic format documents, subject to Terms and Conditions for Electronic Documents at www.sgs.com/terms_e-document.htm. Attention is drawn to the limitation of liability, indemnification and jurisdiction issues defined therein. Any holder of this document is advised that information contained hereon reflects the Company's findings at the time of its intervention only and within the limits of Client's instructions, if any. The Company's sole responsibility is to its Client and this document does not exonerate parties to a transaction from exercising all their rights and obligations under the transaction documents. This document cannot be reproduced except in full, without prior written approval of the Company. Any unauthorized alteration, forgery or falsification of the content or appearance of this document is unlawful and offenders may be prosecuted to the fullest extent of the law.

SGS Taiwan Ltd.

No. 134, WuKungRoad, NewTaipeiIndustrialPark, WuKuDistrict, NewTaipeiCity, Taiwan24803/新北市五股區新北產業園區五工路 134 號

台灣檢驗科技股份有限公司

t (886-2) 2299-3279

f (886-2) 2298-0488

www.tw.sgs.com

Member of SGS Group