

ELECTROMAGNETIC EMISSIONS COMPLIANCE REPORT
INTENTIONAL RADIATOR CERTIFICATION TO
FCC PART 24 SUBPART E SUBPART C REQUIREMENT

OF

Product Name: Smart Phone

FCC ID: APYHRO00253

Report No.: ER/2017/A0042



Issue Date: Nov. 08, 2017

FCC Rule Part: §2 , 24E

Prepared for: Sharp Corporation, IoT Communication B.U.
2-13-1, Hachihonmatsu-lida, Higashi-hiroshima-shi, Hiroshima 739-0192, Japan

Manufacturer: Sharp Corporation
1 Takumi-cho, Sakai-ku, Sakai-Shi, Osaka 590-8522, Japan
SGS Taiwan Ltd.
Electronics & Communication Laboratory

Prepared by: No.134, Wu Kung Road, New Taipei Industrial Park, Wuku District, New Taipei City, Taiwan 24803

		<p>Note: This report shall not be reproduced except in full, without the written approval of SGS Taiwan Ltd. This document may be altered or revised by SGS Taiwan Ltd. personnel only, and shall be noted in the revision section of the document.</p>
---	---	--

Unless otherwise stated the results shown in this test report refer only to the sample(s) tested and such sample(s) are retained for 90 days only.

除非另有說明，此報告結果僅對測試之樣品負責，同時此樣品僅保留90天。本報告未經本公司書面許可，不可部份複製。

This document is issued by the Company subject to its General Conditions of Service printed overleaf, available on request or accessible at www.sgs.com/terms_and_conditions.htm and, for electronic format documents, subject to Terms and Conditions for Electronic Documents at www.sgs.com/terms_e-document.htm. Attention is drawn to the limitation of liability, indemnification and jurisdiction issues defined therein. Any holder of this document is advised that information contained hereon reflects the Company's findings at the time of its intervention only and within the limits of Client's instructions, if any. The Company's sole responsibility is to its Client and this document does not exonerate parties to a transaction from exercising all their rights and obligations under the transaction documents. This document cannot be reproduced except in full, without prior written approval of the Company. Any unauthorized alteration, forgery or falsification of the content or appearance of this document is unlawful and offenders may be prosecuted to the fullest extent of the law.

SGS Taiwan Ltd.

No.134,WuKungRoad,NewTaipeiIndustrialPark,WukuDistrict,NewTaipeiCity,Taiwan24803/新北市五股區新北產業園區五工路 134 號

台灣檢驗科技股份有限公司

t (886-2) 2299-3279

f (886-2) 2298-0488

www.tw.sgs.com

Member of SGS Group

VERIFICATION OF COMPLIANCE

Applicant: Sharp Corporation, IoT Communication B.U.
2-13-1, Hachihonmatsu-lida, Higashi-hiroshima-shi, Hiroshima
739-0192, Japan

Manufacturer: Sharp Corporation
1 Takumi-cho, Sakai-ku, Sakai-Shi, Osaka 590-8522, Japan

Product Name: Smart Phone

FCC ID: APYHRO00253

File Number: ER/2017/A0042

Date of test: Aug. 14, 2017 ~ Sep. 04, 2017,
Oct 18, 2017 ~ Oct. 20, 2017 (for WCDMA B2/ LTE B2)

Date of EUT Received: Aug. 14, 2017

We hereby certify that:

The above equipment was tested by SGS Taiwan Ltd. Electronics & Communication Laboratory. The test data, data evaluation, test procedures, and equipment configurations shown in this report were made in accordance with the procedures given in ANSI C63.26-2015 and the energy emitted by the sample EUT tested as described in this report is in compliance with conducted and radiated emission limits.

The test results of this report relate only to the tested sample identified in this report.

Test By:

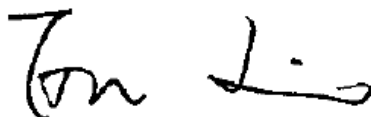

Date:

Nov. 08, 2017

Tin Lin / Engineer

Prepared By:

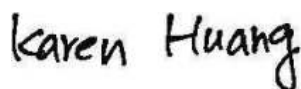

Date:

Nov. 08, 2017

Karen Huang / Clerk

Approved By:



Date:

Nov. 08, 2017

Jim Chang / Asst. Manager

Unless otherwise stated the results shown in this test report refer only to the sample(s) tested and such sample(s) are retained for 90 days only.

除非另有說明，此報告結果僅對測試之樣品負責，同時此樣品僅保留90天。本報告未經本公司書面許可，不可部份複製。

This document is issued by the Company subject to its General Conditions of Service printed overleaf, available on request or accessible at www.sgs.com/terms_and_conditions.htm and, for electronic format documents, subject to Terms and Conditions for Electronic Documents at www.sgs.com/terms_e-document.htm. Attention is drawn to the limitation of liability, indemnification and jurisdiction issues defined therein. Any holder of this document is advised that information contained hereon reflects the Company's findings at the time of its intervention only and within the limits of Client's instructions, if any. The Company's sole responsibility is to its Client and this document does not exonerate parties to a transaction from exercising all their rights and obligations under the transaction documents. This document cannot be reproduced except in full, without prior written approval of the Company. Any unauthorized alteration, forgery or falsification of the content or appearance of this document is unlawful and offenders may be prosecuted to the fullest extent of the law.

Revision History

Report Number	Revision	Description	Issue Date
ER/2017/A0042	Rev.00	Initial creation of document	Nov. 08, 2017

Unless otherwise stated the results shown in this test report refer only to the sample(s) tested and such sample(s) are retained for 90 days only.

除非另有說明，此報告結果僅對測試之樣品負責，同時此樣品僅保留90天。本報告未經本公司書面許可，不可部份複製。

This document is issued by the Company subject to its General Conditions of Service printed overleaf, available on request or accessible at www.sgs.com/terms_and_conditions.htm and, for electronic format documents, subject to Terms and Conditions for Electronic Documents at www.sgs.com/terms_e-document.htm. Attention is drawn to the limitation of liability, indemnification and jurisdiction issues defined therein. Any holder of this document is advised that information contained hereon reflects the Company's findings at the time of its intervention only and within the limits of Client's instructions, if any. The Company's sole responsibility is to its Client and this document does not exonerate parties to a transaction from exercising all their rights and obligations under the transaction documents. This document cannot be reproduced except in full, without prior written approval of the Company. Any unauthorized alteration, forgery or falsification of the content or appearance of this document is unlawful and offenders may be prosecuted to the fullest extent of the law.

SGS Taiwan Ltd.

No.134,WuKungRoad,NewTaipeiIndustrialPark,WukuDistrict,NewTaipeiCity,Taiwan24803/新北市五股區新北產業園區五工路 134 號

台灣檢驗科技股份有限公司

t (886-2) 2299-3279

f (886-2) 2298-0488

www.tw.sgs.com

Member of SGS Group

Contents

1	GENERAL PRODUCT INFORMATION	5
2	SYSTEM TEST CONFIGURATION	9
3	SUMMARY OF TEST RESULTS.....	13
4	DESCRIPTION OF TEST MODES	14
5	MEASUREMENT UNCERTAINTY	17
6	RF CONDUCTED OUTPUT POWER MEASUREMENT	18
7	EFFECTIVE RADIATED POWER AND EQUIVALENT ISOTROPIC RADIATED POWER MEASUREMENT	26
8	OCCUPIED BANDWIDTH MEASUREMENT.....	38
9	OUT OF BAND EMISSION AT ANTENNA TERMINALS.....	51
10	FIELD STRENGTH OF SPURIOUS RADIATION MEASUREMENT	69
11	FREQUENCY STABILITY MEASUREMENT	91
12	PEAK TO AVERAGE RATIO.....	96

Unless otherwise stated the results shown in this test report refer only to the sample(s) tested and such sample(s) are retained for 90 days only.

除非另有說明，此報告結果僅對測試之樣品負責，同時此樣品僅保留90天。本報告未經本公司書面許可，不可部份複製。

This document is issued by the Company subject to its General Conditions of Service printed overleaf, available on request or accessible at www.sgs.com/terms_and_conditions.htm and, for electronic format documents, subject to Terms and Conditions for Electronic Documents at www.sgs.com/terms_e-document.htm. Attention is drawn to the limitation of liability, indemnification and jurisdiction issues defined therein. Any holder of this document is advised that information contained hereon reflects the Company's findings at the time of its intervention only and within the limits of Client's instructions, if any. The Company's sole responsibility is to its Client and this document does not exonerate parties to a transaction from exercising all their rights and obligations under the transaction documents. This document cannot be reproduced except in full, without prior written approval of the Company. Any unauthorized alteration, forgery or falsification of the content or appearance of this document is unlawful and offenders may be prosecuted to the fullest extent of the law.

SGS Taiwan Ltd.

No.134,WuKungRoad,NewTaipeiIndustrialPark,WukuDistrict,NewTaipeiCity,Taiwan24803/新北市五股區新北產業園區五工路 134 號

台灣檢驗科技股份有限公司

t (886-2) 2299-3279

f (886-2) 2298-0488

www.tw.sgs.com

Member of SGS Group

1 GENERAL PRODUCT INFORMATION

1.1 Product Description

General:

Product Name:	Smart Phone	
Hardware Version:	PVT	
Software Version:	A920A	
Power Supply:	3.85V from Rechargeable Li-ion Battery	
	Battery:	Model No.: UBATIA283AFN2, Supplier: SCUD(FUJIAN) Electronics Co., Ltd.

GSM / WCDMA / LTE:

Cellular Phone Standards Frequency Range and Power	Operating Frequency		Rated Power
	GSM/GPRS 1900	1850.2MHz – 1909.8MHz	29.5dBm
	WCDMA/HSUPA/HSDPA/ HSPA+ Band II	1852.4MHz – 1907.6MHz	23.5dBm
	LTE-Band 2 (1.4MHz)	1850.7MHz– 1909.3MHz	23dBm
	LTE-Band 2 (3MHz)	1851.5MHz – 1908.5MHz	23dBm
	LTE-Band 2 (5MHz)	1852.5MHz – 1907.5MHz	23dBm
	LTE-Band 2 (10MHz)	1855.0MHz – 1905.0MHz	23dBm
	LTE-Band 2 (15MHz)	1857.5MHz – 1902.5MHz	23dBm
	LTE-Band 2 (20MHz)	1860.0MHz – 1900.0MHz	23dBm
IMEI:	0044-0111-6272-267 0044-0111-6271-889		

Unless otherwise stated the results shown in this test report refer only to the sample(s) tested and such sample(s) are retained for 90 days only.

除非另有說明，此報告結果僅對測試之樣品負責，同時此樣品僅保留90天。本報告未經本公司書面許可，不可部份複製。

This document is issued by the Company subject to its General Conditions of Service printed overleaf, available on request or accessible at www.sgs.com/terms_and_conditions.htm and, for electronic format documents, subject to Terms and Conditions for Electronic Documents at www.sgs.com/terms_e-document.htm. Attention is drawn to the limitation of liability, indemnification and jurisdiction issues defined therein. Any holder of this document is advised that information contained hereon reflects the Company's findings at the time of its intervention only and within the limits of Client's instructions, if any. The Company's sole responsibility is to its Client and this document does not exonerate parties to a transaction from exercising all their rights and obligations under the transaction documents. This document cannot be reproduced except in full, without prior written approval of the Company. Any unauthorized alteration, forgery or falsification of the content or appearance of this document is unlawful and offenders may be prosecuted to the fullest extent of the law.

SGS Taiwan Ltd.

No.134,WuKungRoad,NewTaipeiIndustrialPark,WukuDistrict,NewTaipeiCity,Taiwan24803/新北市五股區新北產業園區五工路 134 號

台灣檢驗科技股份有限公司

t (886-2) 2299-3279

f (886-2) 2298-0488

www.tw.sgs.com

Member of SGS Group

Type of Emission:

Frequency Band	Type of Emission:
GSM 1900	245KGXW
GPRS 1900	245KGXW
WCDMA Band II	4M12F9W
HSDPA Band II	4M13F9W
HSUPA Band II	4M12F9W

LTE Band	BW (MHz)	Modulation	Type of Emission
LTE Band 2	1.4MHz	QPSK	1M10G7D
LTE Band 2	1.4MHz	16QAM	1M10W7D
LTE Band 2	3MHz	QPSK	2M70G7D
LTE Band 2	3MHz	16QAM	2M70W7D
LTE Band 2	5MHz	QPSK	4M50G7D
LTE Band 2	5MHz	16QAM	4M51W7D
LTE Band 2	10MHz	QPSK	9M00G7D
LTE Band 2	10MHz	16QAM	8M95W7D
LTE Band 2	15MHz	QPSK	13M5G7D
LTE Band 2	15MHz	16QAM	13M4W7D
LTE Band 2	20MHz	QPSK	17M9G7D
LTE Band 2	20MHz	16QAM	17M9W7D

Unless otherwise stated the results shown in this test report refer only to the sample(s) tested and such sample(s) are retained for 90 days only.

除非另有說明，此報告結果僅對測試之樣品負責，同時此樣品僅保留90天。本報告未經本公司書面許可，不可部份複製。

This document is issued by the Company subject to its General Conditions of Service printed overleaf, available on request or accessible at www.sgs.com/terms_and_conditions.htm and, for electronic format documents, subject to Terms and Conditions for Electronic Documents at www.sgs.com/terms_e-document.htm. Attention is drawn to the limitation of liability, indemnification and jurisdiction issues defined therein. Any holder of this document is advised that information contained hereon reflects the Company's findings at the time of its intervention only and within the limits of Client's instructions, if any. The Company's sole responsibility is to its Client and this document does not exonerate parties to a transaction from exercising all their rights and obligations under the transaction documents. This document cannot be reproduced except in full, without prior written approval of the Company. Any unauthorized alteration, forgery or falsification of the content or appearance of this document is unlawful and offenders may be prosecuted to the fullest extent of the law.

SGS Taiwan Ltd.

No.134,WuKungRoad,NewTaipeiIndustrialPark,WukuDistrict,NewTaipeiCity,Taiwan24803/新北市五股區新北產業園區五工路 134 號

台灣檢驗科技股份有限公司

t (886-2) 2299-3279

f (886-2) 2298-0488

www.tw.sgs.com

Member of SGS Group

Max ERP/EIRP Power Measurement Result:

	dBm		W
GSM 1900	22.44	EIRP	0.175
GPRS 1900	26.29	EIRP	0.426
WCDMA Band II	18.53	EIRP	0.071
HSDPA Band II	19.42	EIRP	0.087
HSUPA Band II	19.23	EIRP	0.084
LTE-Band 2 (Bandwidth 1.4MHz) QPSK	23.68	EIRP	0.233
LTE-Band 2 (Bandwidth 1.4MHz) 16QAM	23.38	EIRP	0.218
LTE-Band 2 (Bandwidth 3MHz) QPSK	23.90	EIRP	0.245
LTE-Band 2 (Bandwidth 3MHz) 16QAM	23.59	EIRP	0.229
LTE-Band 2 (Bandwidth 5MHz) QPSK	23.80	EIRP	0.240
LTE-Band 2 (Bandwidth 5MHz) 16QAM	23.28	EIRP	0.213
LTE-Band 2 (Bandwidth 10MHz) QPSK	23.71	EIRP	0.235
LTE-Band 2 (Bandwidth 10MHz) 16QAM	23.25	EIRP	0.211
LTE-Band 2 (Bandwidth 15MHz) QPSK	23.56	EIRP	0.227
LTE-Band 2 (Bandwidth 15MHz) 16QAM	23.54	EIRP	0.226
LTE-Band 2 (Bandwidth 20MHz) QPSK	23.27	EIRP	0.212
LTE-Band 2 (Bandwidth 20MHz) 16QAM	22.86	EIRP	0.193

Unless otherwise stated the results shown in this test report refer only to the sample(s) tested and such sample(s) are retained for 90 days only.

除非另有說明，此報告結果僅對測試之樣品負責，同時此樣品僅保留90天。本報告未經本公司書面許可，不可部份複製。

This document is issued by the Company subject to its General Conditions of Service printed overleaf, available on request or accessible at www.sgs.com/terms_and_conditions.htm and, for electronic format documents, subject to Terms and Conditions for Electronic Documents at www.sgs.com/terms_e-document.htm. Attention is drawn to the limitation of liability, indemnification and jurisdiction issues defined therein. Any holder of this document is advised that information contained hereon reflects the Company's findings at the time of its intervention only and within the limits of Client's instructions, if any. The Company's sole responsibility is to its Client and this document does not exonerate parties to a transaction from exercising all their rights and obligations under the transaction documents. This document cannot be reproduced except in full, without prior written approval of the Company. Any unauthorized alteration, forgery or falsification of the content or appearance of this document is unlawful and offenders may be prosecuted to the fullest extent of the law.

SGS Taiwan Ltd.

No.134,WuKungRoad,NewTaipeiIndustrialPark,WukuDistrict,NewTaipeiCity,Taiwan24803/新北市五股區新北產業園區五工路 134 號

台灣檢驗科技股份有限公司

t (886-2) 2299-3279

f (886-2) 2298-0488

www.tw.sgs.com

Member of SGS Group

1.2 Test Methodology of Applied Standards

FCC 47 CFR Part 2, 24

ANSI/TIA-603-E-2016

KDB971168 D01 v02r02 Power Meas license Digital System

KDB941225 D01 v03r01 of the Output power Procedure of (SAR Measurement Procedures for 3G Devices, WCDMA / HSPA) was used for EUT and Base station setting.

TS 151 010-1 is used to set, and measure the output power.

Note: All test items have been performed and record as per the above standards.

1.3 Test Facility

SGS Taiwan Ltd. Electronics & Communication Laboratory No.134, Wu Kung Road, New Taipei Industrial Park, Wuku District, New Taipei City, Taiwan. (TAF code 0513)

FCC Registration Number and Designation number are: 509634 / TW0001

1.4 Special Accessories

No special accessories were used during testing.

1.5 Equipment Modifications

There were no modifications incorporated into the EUT.

1.6 Referencing test data across separate equipment authorization

The test data in PCE test report (ER/2017/80084) under original FCC ID: APYHRO00251 are **partially** referred for the FCC ID: APYHRO00253 in this test report, the test data to be referred include:

GSM/GPRS 1900 (1850.2 MHz~1909.8MHz)

Unless otherwise stated the results shown in this test report refer only to the sample(s) tested and such sample(s) are retained for 90 days only.

除非另有說明，此報告結果僅對測試之樣品負責，同時此樣品僅保留90天。本報告未經本公司書面許可，不可部份複製。

This document is issued by the Company subject to its General Conditions of Service printed overleaf, available on request or accessible at www.sgs.com/terms_and_conditions.htm and, for electronic format documents, subject to Terms and Conditions for Electronic Documents at www.sgs.com/terms_e-document.htm. Attention is drawn to the limitation of liability, indemnification and jurisdiction issues defined therein. Any holder of this document is advised that information contained hereon reflects the Company's findings at the time of its intervention only and within the limits of Client's instructions, if any. The Company's sole responsibility is to its Client and this document does not exonerate parties to a transaction from exercising all their rights and obligations under the transaction documents. This document cannot be reproduced except in full, without prior written approval of the Company. Any unauthorized alteration, forgery or falsification of the content or appearance of this document is unlawful and offenders may be prosecuted to the fullest extent of the law.

SGS Taiwan Ltd.

No.134,WuKungRoad,NewTaipeiIndustrialPark,WukuDistrict,NewTaipeiCity,Taiwan24803/新北市五股區新北產業園區五工路 134 號

台灣檢驗科技股份有限公司

t (886-2) 2299-3279

f (886-2) 2298-0488

www.tw.sgs.com

Member of SGS Group

2 SYSTEM TEST CONFIGURATION

2.1 EUT Configuration

The EUT configuration for testing is installed on RF field strength measurement to meet the Commissions requirement and operating in a manner which intends to maximize its emission characteristics in a continuous normal application.

2.2 EUT Exercise

The EUT (Transmitter) was operated in the continuous transmission mode employed with the simulator of the Base Station that fixates at test default channels to fix the Tx frequency which was for the purpose of the measurements.

2.3 Test Procedure

2.3.1 Conducted Measurement at Antenna Port

According to measurement procured ANSI C63.26-2015, the EUT is placed on a turn table which is 0.8 m above ground plane. A low loss of RF cable was used to connect the antenna port of EUT to measurement equipment.

2.3.2 Radiated Emissions (ERP/EIRP)

According to measurement procured ANSI C63.26-2015, The EUT is a placed on as turn table, for emission measurements below 1 GHz is 0.8 m above ground plane, for emission measurements above 1 GHz, the table height shall be 1.5 m. The turn table shall rotate 360 degrees to determine the position of maximum emission level. EUT is set 3m away from the receiving antenna which varied from 1m to 4m to find out the highest emission. And also, each emission was to be maximized by changing the polarization of receiving antenna both Horizontal and Vertical. In order to find out the max. emission, the relative positions of this hand-held transmitter (EUT) was rotated through three orthogonal axes and measurement procedures for electric field radiated emissions above 1 GHz the EUT measurement is to be made “while keeping the antenna in the ‘cone of radiation’ from that area and pointed at the area both in azimuth and elevation, with polarization oriented for maximum response.” is still within the 3dB illumination BW of the measurement antenna according to the requirements in Section 8 and 13.

Unless otherwise stated the results shown in this test report refer only to the sample(s) tested and such sample(s) are retained for 90 days only.

除非另有說明，此報告結果僅對測試之樣品負責，同時此樣品僅保留90天。本報告未經本公司書面許可，不可部份複製。

This document is issued by the Company subject to its General Conditions of Service printed overleaf, available on request or accessible at www.sgs.com/terms_and_conditions.htm and, for electronic format documents, subject to Terms and Conditions for Electronic Documents at www.sgs.com/terms_e-document.htm. Attention is drawn to the limitation of liability, indemnification and jurisdiction issues defined therein. Any holder of this document is advised that information contained hereon reflects the Company's findings at the time of its intervention only and within the limits of Client's instructions, if any. The Company's sole responsibility is to its Client and this document does not exonerate parties to a transaction from exercising all their rights and obligations under the transaction documents. This document cannot be reproduced except in full, without prior written approval of the Company. Any unauthorized alteration, forgery or falsification of the content or appearance of this document is unlawful and offenders may be prosecuted to the fullest extent of the law.

2.4 Measurement Results Explanation Example

For all conducted test items:

The offset level is set in the spectrum analyzer to compensate the RF cable loss and attenuation factor between EUT conducted port and spectrum analyzer. With the offset compensation, the spectrum analyzer reading level is exactly EUT RF output level.

Note:

Offset = RF cable loss (dB)+ attenuation factor(dB) =3.6+10=13.6(dB) (for GSM/GPRS)

Offset = RF cable loss (dB)+ attenuation factor(dB) =4.4+10=14.4(dB) (for WCDMA/LTE)

2.5 Final Amplifier Voltage and Current Information:

Test Mode	DC voltage (V)	DC current (mA)
GSM1900	3.85	213
GPRS 1900	3.85	243
WCDMA B2	3.85	621
HSDPA B2	3.85	594
HSUPA B2	3.85	634

Unless otherwise stated the results shown in this test report refer only to the sample(s) tested and such sample(s) are retained for 90 days only.

除非另有說明，此報告結果僅對測試之樣品負責，同時此樣品僅保留90天。本報告未經本公司書面許可，不可部份複製。

This document is issued by the Company subject to its General Conditions of Service printed overleaf, available on request or accessible at www.sgs.com/terms_and_conditions.htm and, for electronic format documents, subject to Terms and Conditions for Electronic Documents at www.sgs.com/terms_e-document.htm. Attention is drawn to the limitation of liability, indemnification and jurisdiction issues defined therein. Any holder of this document is advised that information contained hereon reflects the Company's findings at the time of its intervention only and within the limits of Client's instructions, if any. The Company's sole responsibility is to its Client and this document does not exonerate parties to a transaction from exercising all their rights and obligations under the transaction documents. This document cannot be reproduced except in full, without prior written approval of the Company. Any unauthorized alteration, forgery or falsification of the content or appearance of this document is unlawful and offenders may be prosecuted to the fullest extent of the law.

SGS Taiwan Ltd.

No.134,WuKungRoad,NewTaipeiIndustrialPark,WukuDistrict,NewTaipeiCity,Taiwan24803/新北市五股區新北產業園區五工路 134 號

台灣檢驗科技股份有限公司

t (886-2) 2299-3279

f (886-2) 2298-0488

www.tw.sgs.com

Member of SGS Group

Test Mode	DC voltage (V)	DC current (mA)
LTE Band 2_1.4M QPSK	3.85	712
LTE Band 2_1.4M 16QAM	3.85	734
LTE Band 2_3M QPSK	3.85	725
LTE Band 2_3M 16QAM	3.85	722
LTE Band 2_5M QPSK	3.85	721
LTE Band 2_5M 16QAM	3.85	735
LTE Band 2_10M QPSK	3.85	764
LTE Band 2_10M 16QAM	3.85	778
LTE Band 2_15M QPSK	3.85	719
LTE Band 2_15M 16QAM	3.85	746
LTE Band 2_20M QPSK	3.85	744
LTE Band 2_20M 16QAM	3.85	752

Unless otherwise stated the results shown in this test report refer only to the sample(s) tested and such sample(s) are retained for 90 days only.

除非另有說明，此報告結果僅對測試之樣品負責，同時此樣品僅保留90天。本報告未經本公司書面許可，不可部份複製。

This document is issued by the Company subject to its General Conditions of Service printed overleaf, available on request or accessible at www.sgs.com/terms_and_conditions.htm and, for electronic format documents, subject to Terms and Conditions for Electronic Documents at www.sgs.com/terms_e-document.htm. Attention is drawn to the limitation of liability, indemnification and jurisdiction issues defined therein. Any holder of this document is advised that information contained hereon reflects the Company's findings at the time of its intervention only and within the limits of Client's instructions, if any. The Company's sole responsibility is to its Client and this document does not exonerate parties to a transaction from exercising all their rights and obligations under the transaction documents. This document cannot be reproduced except in full, without prior written approval of the Company. Any unauthorized alteration, forgery or falsification of the content or appearance of this document is unlawful and offenders may be prosecuted to the fullest extent of the law.

SGS Taiwan Ltd.

No.134,WuKungRoad,NewTaipeiIndustrialPark,WukuDistrict,NewTaipeiCity,Taiwan24803/新北市五股區新北產業園區五工路 134 號

台灣檢驗科技股份有限公司

t (886-2) 2299-3279

f (886-2) 2298-0488

www.tw.sgs.com

Member of SGS Group

2.6 Configuration of Tested System

Fig. 2-1 Configuration of Tested System (Fixed Channel-Conducted)

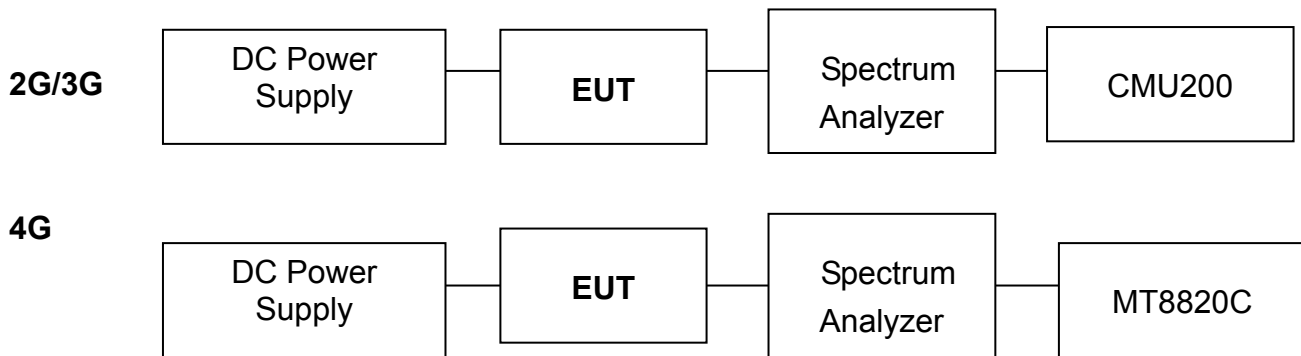

Fig. 2-2 Configuration of Tested System (Fixed Channel-Radiated)

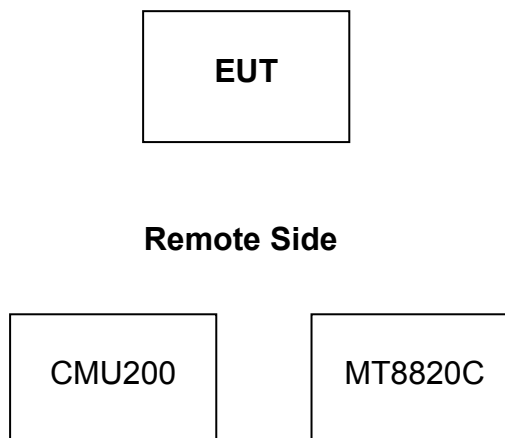

Table 2-1 Equipment Used in

Item	Equipment	Mfr/Brand	Model/Type No.	Series No.	Data Cable	Power Cord
1.	Universal Radio Communication Tester	R&S	CMU200	102189	shielded	Un-shielded
2.	Universal Radio Communication Tester	Anritsu	MT8820C	6200307563	shielded	Un-shielded
3.	DC Power Supply	HP	E3640A	KR93300208	N/A	Unshielded

Unless otherwise stated the results shown in this test report refer only to the sample(s) tested and such sample(s) are retained for 90 days only.

除非另有說明，此報告結果僅對測試之樣品負責，同時此樣品僅保留90天。本報告未經本公司書面許可，不可部份複製。

This document is issued by the Company subject to its General Conditions of Service printed overleaf, available on request or accessible at www.sgs.com/terms_and_conditions.htm and, for electronic format documents, subject to Terms and Conditions for Electronic Documents at www.sgs.com/terms_e-document.htm. Attention is drawn to the limitation of liability, indemnification and jurisdiction issues defined therein. Any holder of this document is advised that information contained hereon reflects the Company's findings at the time of its intervention only and within the limits of Client's instructions, if any. The Company's sole responsibility is to its Client and this document does not exonerate parties to a transaction from exercising all their rights and obligations under the transaction documents. This document cannot be reproduced except in full, without prior written approval of the Company. Any unauthorized alteration, forgery or falsification of the content or appearance of this document is unlawful and offenders may be prosecuted to the fullest extent of the law.

3 SUMMARY OF TEST RESULTS

FCC Rules	Description Of Test	Result
§2.1046(a)	RF Power Output	Compliant
§2.1046(a) §24.232(c)	ERP/ EIRP measurement	Compliant
§2.1049(h)	99% & 26dB Occupied Bandwidth	Compliant
§2.1051 §24.238(a)	Out of Band Emissions at Antenna Terminals and Band Edge / Emission mask requirements	Compliant
§2.1053 §24.238(a)	Field Strength of Spurious Radiation	Compliant
§24.232(d)	Peak to Average Ratio	Compliant
§2.1055(a)(1) §24.235	Frequency Stability	Compliant

Unless otherwise stated the results shown in this test report refer only to the sample(s) tested and such sample(s) are retained for 90 days only.

除非另有說明，此報告結果僅對測試之樣品負責，同時此樣品僅保留90天。本報告未經本公司書面許可，不可部份複製。

This document is issued by the Company subject to its General Conditions of Service printed overleaf, available on request or accessible at www.sgs.com/terms_and_conditions.htm and, for electronic format documents, subject to Terms and Conditions for Electronic Documents at www.sgs.com/terms_e-document.htm. Attention is drawn to the limitation of liability, indemnification and jurisdiction issues defined therein. Any holder of this document is advised that information contained hereon reflects the Company's findings at the time of its intervention only and within the limits of Client's instructions, if any. The Company's sole responsibility is to its Client and this document does not exonerate parties to a transaction from exercising all their rights and obligations under the transaction documents. This document cannot be reproduced except in full, without prior written approval of the Company. Any unauthorized alteration, forgery or falsification of the content or appearance of this document is unlawful and offenders may be prosecuted to the fullest extent of the law.

SGS Taiwan Ltd.

No.134,WuKungRoad,NewTaipeiIndustrialPark,WukuDistrict,NewTaipeiCity,Taiwan24803/新北市五股區新北產業園區五工路 134 號

台灣檢驗科技股份有限公司

t (886-2) 2299-3279

f (886-2) 2298-0488

www.tw.sgs.com

Member of SGS Group

4 DESCRIPTION OF TEST MODES

4.1 The Worst Test Modes and Channel Details

1. The EUT has been tested under operating condition.
2. Pre-Scan has been conducted to determine the worst-case mode from all possible combinations between available modulations, data rates, X(E1)Y(E2)Z(H) axis and antenna ports. The worst case was found as listed below. Following channel(s) was (were) selected for the final test as listed below:

BAND	ERP/EIRP	RADIATED EMISSION and Wireless charging Cover
GSM/GPRS 1900	H-plan	H-plan
WCDMA/HSPA Band II	H-plan	H-plan
LTE Band 2	H-plan	H-plan

Unless otherwise stated the results shown in this test report refer only to the sample(s) tested and such sample(s) are retained for 90 days only.

除非另有說明，此報告結果僅對測試之樣品負責，同時此樣品僅保留90天。本報告未經本公司書面許可，不可部份複製。

This document is issued by the Company subject to its General Conditions of Service printed overleaf, available on request or accessible at www.sgs.com/terms_and_conditions.htm and, for electronic format documents, subject to Terms and Conditions for Electronic Documents at www.sgs.com/terms_e-document.htm. Attention is drawn to the limitation of liability, indemnification and jurisdiction issues defined therein. Any holder of this document is advised that information contained hereon reflects the Company's findings at the time of its intervention only and within the limits of Client's instructions, if any. The Company's sole responsibility is to its Client and this document does not exonerate parties to a transaction from exercising all their rights and obligations under the transaction documents. This document cannot be reproduced except in full, without prior written approval of the Company. Any unauthorized alteration, forgery or falsification of the content or appearance of this document is unlawful and offenders may be prosecuted to the fullest extent of the law.

SGS Taiwan Ltd.

No.134,WuKungRoad,NewTaipeiIndustrialPark,WukuDistrict,NewTaipeiCity,Taiwan24803/新北市五股區新北產業園區五工路 134 號

台灣檢驗科技股份有限公司

t (886-2) 2299-3279

f (886-2) 2298-0488

www.tw.sgs.com

Member of SGS Group

GSM/GPRS/EDGE MODE

TEST ITEM	AVAILABLE CHANNEL	TESTED CHANNEL	MODE
EIRP	512 to 810	512, 661, 810	GSM/GPRS 1900
FREQUENCY STABILITY	512 to 810	661	GPRS 1900
OCCUPIED BANDWIDTH	512 to 810	661	GSM/GPRS 1900
PEAK TO AVERAGE RATIO	512 to 810	512, 661, 810	GSM/GPRS 1900
BAND EDGE	512 to 810	512, 810	GSM/GPRS 1900
CONDCUDED EMISSION	512 to 810	512, 661, 810	GSM/GPRS 1900
RADIATED EMISSION	512 to 810	512, 661, 810	GPRS 1900

WCDMA/HSPA MODE

TEST ITEM	AVAILABLE CHANNEL	TESTED CHANNEL	MODE
EIRP	4132 to 4233	4132, 4183, 4233	WCDMA/HSPA Band II
FREQUENCY STABILITY	4132 to 4233	4183	WCDMA/HSPA Band II
OCCUPIED BANDWIDTH	4132 to 4233	4132, 4183, 4233	WCDMA/HSPA Band II
PEAK TO AVERAGE RATIO	4132 to 4233	4132, 4183, 4233	WCDMA/HSPA Band II
BAND EDGE	4132 to 4233	4132, 4233	WCDMA/HSPA Band II
CONDCUDED EMISSION	4132 to 4233	4132, 4183, 4233	WCDMA/HSPA Band II
RADIATED EMISSION	4132 to 4233	4132, 4183, 4233	WCDMA/HSPA Band II

Unless otherwise stated the results shown in this test report refer only to the sample(s) tested and such sample(s) are retained for 90 days only.

除非另有說明，此報告結果僅對測試之樣品負責，同時此樣品僅保留90天。本報告未經本公司書面許可，不可部份複製。

This document is issued by the Company subject to its General Conditions of Service printed overleaf, available on request or accessible at www.sgs.com/terms_and_conditions.htm and, for electronic format documents, subject to Terms and Conditions for Electronic Documents at www.sgs.com/terms_e-document.htm. Attention is drawn to the limitation of liability, indemnification and jurisdiction issues defined therein. Any holder of this document is advised that information contained hereon reflects the Company's findings at the time of its intervention only and within the limits of Client's instructions, if any. The Company's sole responsibility is to its Client and this document does not exonerate parties to a transaction from exercising all their rights and obligations under the transaction documents. This document cannot be reproduced except in full, without prior written approval of the Company. Any unauthorized alteration, forgery or falsification of the content or appearance of this document is unlawful and offenders may be prosecuted to the fullest extent of the law.

SGS Taiwan Ltd.

No.134,WuKungRoad,NewTaipeiIndustrialPark,WukuDistrict,NewTaipeiCity,Taiwan24803/新北市五股區新北產業園區五工路 134 號

台灣檢驗科技股份有限公司

t (886-2) 2299-3279

f (886-2) 2298-0488

www.tw.sgs.com

Member of SGS Group

LTE Band 2 MODE

TEST ITEM	AVAILABLE CHANNEL	TESTED CHANNEL	CHANNEL BANDWIDTH	MODULATION	MODE
EIRP	18607 to 19193	18607, 18900, 19193	1.4MHz	QPSK, 16QAM	1 RB/ 0,5 RB Offest
	18615 to 19185	18615, 18900, 19185	3MHz	QPSK, 16QAM	1 RB/ 0,14 RB Offest
	18625 to 19175	18625, 18900, 19175	5MHz	QPSK, 16QAM	1 RB/ 0,24 RB Offest
	18650 to 19150	18650, 18900, 19150	10MHz	QPSK, 16QAM	1 RB/ 0,49 RB Offest
	18675 to 19125	18675, 18900, 19125	15MHz	QPSK, 16QAM	1 RB/ 0,74 RB Offest
	18700 to 19100	18700, 18900, 19100	20MHz	QPSK, 16QAM	1 RB/ 0,99 RB Offest
FREQUENCY STABILITY	18650 to 19150	18900	10MHz	QPSK,	Full RB
OCCUPIED BANDWIDTH	18607 to 19193	18607, 18900, 19193	1.4MHz	QPSK, 16QAM	Full RB
	18615 to 19185	18615, 18900, 19185	3MHz	QPSK, 16QAM	Full RB
	18625 to 19175	18625, 18900, 19175	5MHz	QPSK, 16QAM	Full RB
	18650 to 19150	18650, 18900, 19150	10MHz	QPSK, 16QAM	Full RB
	18675 to 19125	18675, 18900, 19125	15MHz	QPSK, 16QAM	Full RB
	18700 to 19100	18700, 18900, 19100	20MHz	QPSK, 16QAM	Full RB
PEAK TO AVERAGE RATIO	18607 to 19193	18607, 18900, 19193	1.4MHz	16QAM	Full RB
	18615 to 19185	18615, 18900, 19185	3MHz	16QAM	Full RB
	18625 to 19175	18625, 18900, 19175	5MHz	16QAM	Full RB
	18650 to 19150	18650, 18900, 19150	10MHz	16QAM	Full RB
	18675 to 19125	18675, 18900, 19125	15MHz	16QAM	Full RB
	18700 to 19100	18700, 18900, 19100	20MHz	16QAM	Full RB
BAND EDGE	18607 to 19193	18607, 19193	1.4MHz	QPSK,	1 RB/ 0,5 RB Offes Full RB
	18615 to 19185	18615, 19185	3MHz	QPSK,	1 RB/ 0,14 RB Offest Full RB
	18625 to 19175	18625, 19175	5MHz	QPSK,	1 RB/ 0,24 RB Offest Full RB
	18650 to 19150	18650, 19150	10MHz	QPSK,	1 RB/ 0,49 RB Offest Full RB
	18675 to 19125	18675, 19125	15MHz	QPSK,	1 RB/ 0,74 RB Offest Full RB
	18700 to 19100	18700, 19100	20MHz	QPSK,	1 RB/ 0,99 RB Offest Full RB
CONDCUDED EMISSION	18607 to 19193	18607, 18900, 19193	1.4MHz	QPSK,	1 RB, 0 RB Offest
	18615 to 19185	18615, 18900, 19185	3MHz	QPSK,	1 RB, 0 RB Offest
	18625 to 19175	18625, 18900, 19175	5MHz	QPSK,	1 RB, 0 RB Offest
	18650 to 19150	18650, 18900, 19150	10MHz	QPSK,	1 RB, 0 RB Offest
	18675 to 19125	18675, 18900, 19125	15MHz	QPSK,	1 RB, 0 RB Offest
	18700 to 19100	18700, 18900, 19100	20MHz	QPSK,	1 RB, 0 RB Offest
RADIATED EMISSION	18625 to 19175	18625, 18900, 19175	5MHz	QPSK	1 RB, 0 RB Offest

Unless otherwise stated the results shown in this test report refer only to the sample(s) tested and such sample(s) are retained for 90 days only.

除非另有說明，此報告結果僅對測試之樣品負責，同時此樣品僅保留90天。本報告未經本公司書面許可，不可部份複製。

This document is issued by the Company subject to its General Conditions of Service printed overleaf, available on request or accessible at www.sgs.com/terms_and_conditions.htm and, for electronic format documents, subject to Terms and Conditions for Electronic Documents at www.sgs.com/terms_e-document.htm. Attention is drawn to the limitation of liability, indemnification and jurisdiction issues defined therein. Any holder of this document is advised that information contained hereon reflects the Company's findings at the time of its intervention only and within the limits of Client's instructions, if any. The Company's sole responsibility is to its Client and this document does not exonerate parties to a transaction from exercising all their rights and obligations under the transaction documents. This document cannot be reproduced except in full, without prior written approval of the Company. Any unauthorized alteration, forgery or falsification of the content or appearance of this document is unlawful and offenders may be prosecuted to the fullest extent of the law.

SGS Taiwan Ltd.

No.134,WuKungRoad,NewTaipeiIndustrialPark,WukuDistrict,NewTaipeiCity,Taiwan24803/新北市五股區新北產業園區五工路 134 號

台灣檢驗科技股份有限公司

t (886-2) 2299-3279

f (886-2) 2298-0488

www.tw.sgs.com

Member of SGS Group

5 MEASUREMENT UNCERTAINTY

Test Items	Uncertainty
RF Power Output	+/- 1.10 dB
ERP/ EIRP measurement	Vertical Polarization = +/- 4.74dB Horizontal Polarization = +/- 4.62dB
99% Occupied Bandwidth	+/- 5.19 Hz
Out of Band Emissions at Antenna Terminals and Band Edge	+/- 0.70 dB
Peak to Average Ratio	+/- 0.70 dB
Frequency Stability vs. Temperature	+/- 5.19 Hz
Frequency Stability vs. Voltage	+/- 5.19 Hz
Temperature	+/- 0.65 °C
Humidity	+/- 4.6 %
DC / AC Power Source	DC= +/- 0.13%, AC= +/- 0.2%

Radiated Spurious Emission:

Measurement uncertainty (Polarization : Vertical)	9kHz – 30MHz: +/- 2.87 dB
	30MHz - 180MHz: +/- 3.37dB
	180MHz -417MHz: +/- 3.19dB
	0.417GHz-1GHz: +/- 3.19dB
	1GHz - 18GHz: +/- 4.04dB
	18GHz - 40GHz: +/- 4.04dB

Measurement uncertainty (Polarization : Horizontal)	9kHz – 30MHz: +/- 2.87 dB
	30MHz - 167MHz: +/- 4.22dB
	167MHz -500MHz: +/- 3.44dB
	0.5GHz-1GHz: +/- 3.39dB
	1GHz - 18GHz: +/- 4.08dB
	18GHz - 40GHz: +/- 4.08dB

This uncertainty represents an expanded uncertainty expressed at approximately the 95% confidence level using a coverage factor of k=2.

Unless otherwise stated the results shown in this test report refer only to the sample(s) tested and such sample(s) are retained for 90 days only.

除非另有說明，此報告結果僅對測試之樣品負責，同時此樣品僅保留90天。本報告未經本公司書面許可，不可部份複製。

This document is issued by the Company subject to its General Conditions of Service printed overleaf, available on request or accessible at www.sgs.com/terms_and_conditions.htm and, for electronic format documents, subject to Terms and Conditions for Electronic Documents at www.sgs.com/terms_e-document.htm. Attention is drawn to the limitation of liability, indemnification and jurisdiction issues defined therein. Any holder of this document is advised that information contained hereon reflects the Company's findings at the time of its intervention only and within the limits of Client's instructions, if any. The Company's sole responsibility is to its Client and this document does not exonerate parties to a transaction from exercising all their rights and obligations under the transaction documents. This document cannot be reproduced except in full, without prior written approval of the Company. Any unauthorized alteration, forgery or falsification of the content or appearance of this document is unlawful and offenders may be prosecuted to the fullest extent of the law.

6 RF CONDUCTED OUTPUT POWER MEASUREMENT

6.1 Standard Applicable

A base station simulator was used to establish communication with the EUT. Its parameters were set to transmit the maximum power on the EUT. The measured power in the radio frequency on the transmitter output terminals.

6.2 Test Set-up

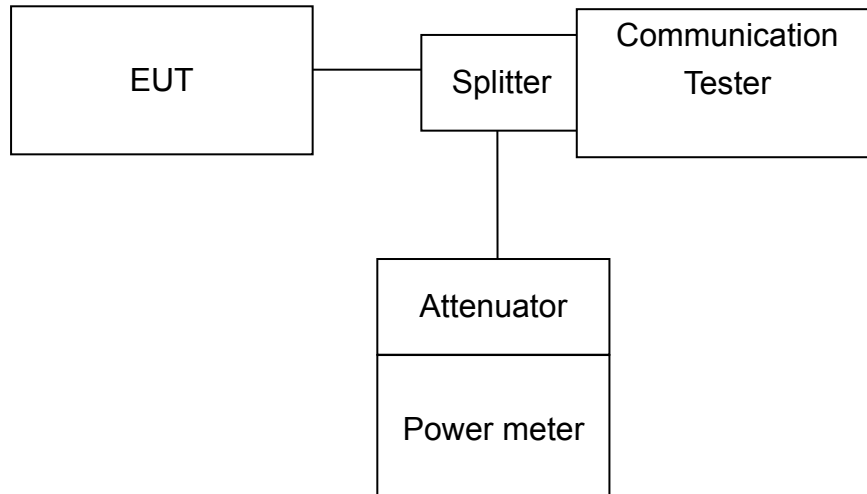

Note: Measurement setup for testing on Antenna connector

6.3 Measurement Procedure

The transmitter output was connected to a calibrated attenuator, the other end of which was connected to a power meter. Transmitter output was read off the power meter in dBm. The power output at the transmitter antenna port was determined by adding the value of the attenuator to the power meter reading. TS 151 010-1 is reference to conduct the test measurement of output power.

The Procedure of KDB941225 (SAR Measurement Procedures for 3G devices, (WCDMA/HSPA) was used for EUT and Base station setting. RMC 12.2kps is used for this testing, and KDB 971168 D01 Power Meas License Digital System as the supplemental test methodology to adjust the proper setting obtaining the measurement results

Unless otherwise stated the results shown in this test report refer only to the sample(s) tested and such sample(s) are retained for 90 days only.

除非另有說明，此報告結果僅對測試之樣品負責，同時此樣品僅保留90天。本報告未經本公司書面許可，不可部份複製。

This document is issued by the Company subject to its General Conditions of Service printed overleaf, available on request or accessible at www.sgs.com/terms_and_conditions.htm and, for electronic format documents, subject to Terms and Conditions for Electronic Documents at www.sgs.com/terms_e-document.htm. Attention is drawn to the limitation of liability, indemnification and jurisdiction issues defined therein. Any holder of this document is advised that information contained hereon reflects the Company's findings at the time of its intervention only and within the limits of Client's instructions, if any. The Company's sole responsibility is to its Client and this document does not exonerate parties to a transaction from exercising all their rights and obligations under the transaction documents. This document cannot be reproduced except in full, without prior written approval of the Company. Any unauthorized alteration, forgery or falsification of the content or appearance of this document is unlawful and offenders may be prosecuted to the fullest extent of the law.

6.4 Measurement Equipment Used

Conducted Emission (measured at antenna port) Test Site					
EQUIPMENT TYPE	MFR	MODEL NUMBER	SERIAL NUMBER	LAST CAL.	CAL DUE.
Power Meter	Anritsu	ML2495A	1005007	12/15/2016	12/14/2017
Power Sensor	Anritsu	MA2411B	917032	12/15/2016	12/14/2017
EXA Spectrum Analyzer	Agilent	N9030A	MY53120760	03/21/2017	03/20/2018
DC Block	Mini-Circuits	BLK-18-S+	1	01/05/2017	01/04/2018
Coaxial Cable	HUBER+SUHNER	SUCOFLEX 102	23670/2	01/05/2017	01/04/2018
Attenuator	Mini-Circuit	BW-S10W2+	2	01/05/2017	01/04/2018
Splitter	Agilent	11636B	N/A	01/05/2017	01/04/2018
DC Power Supply	Agilent	E3640A	MY52410006	11/21/2016	11/20/2017
Temperature Chamber	TERCHY	MHG-120LF	911009	05/19/2017	05/18/2018
Radio Communication Analyzer	R&S	CMU200	102189	02/11/2017	02/10/2018
Radio Communication Analyzer	Anritsu	MT8820C	6201465317	01/03/2017	01/02/2018

Unless otherwise stated the results shown in this test report refer only to the sample(s) tested and such sample(s) are retained for 90 days only.

除非另有說明，此報告結果僅對測試之樣品負責，同時此樣品僅保留90天。本報告未經本公司書面許可，不可部份複製。

This document is issued by the Company subject to its General Conditions of Service printed overleaf, available on request or accessible at www.sgs.com/terms_and_conditions.htm and, for electronic format documents, subject to Terms and Conditions for Electronic Documents at www.sgs.com/terms_e-document.htm. Attention is drawn to the limitation of liability, indemnification and jurisdiction issues defined therein. Any holder of this document is advised that information contained hereon reflects the Company's findings at the time of its intervention only and within the limits of Client's instructions, if any. The Company's sole responsibility is to its Client and this document does not exonerate parties to a transaction from exercising all their rights and obligations under the transaction documents. This document cannot be reproduced except in full, without prior written approval of the Company. Any unauthorized alteration, forgery or falsification of the content or appearance of this document is unlawful and offenders may be prosecuted to the fullest extent of the law.

SGS Taiwan Ltd.

No. 134, WuKungRoad, NewTaipeiIndustrialPark, WukuDistrict, New Taipei City, Taiwan 24803/新北市五股區新北產業園區五工路 134 號

台灣檢驗科技股份有限公司

t (886-2) 2299-3279

f (886-2) 2298-0488

www.tw.sgs.com

Member of SGS Group

6.5 Measurement Result

RF Conducted Output Power

GSM/GPRS/EDGE (GMSK; 8-PSK) Result:

EUT Mode	Frequency (MHz)	CH	Average Burst Power (1DN 1UP) Class 8 (dBm)
GSM 1900	1850.2	512	29.54
	1880.0	661	29.52
	1909.8	810	29.45

EUT Mode	Frequency (MHz)	CH	Average Burst Power (1DN 1UP) Class 8 (dBm)	Average Burst Power (1DN 2UP) Class 10 (dBm)	Average Burst Power (1DN 3UP) Class 12 (dBm)	Average Burst Power (1DN 4UP) Class 12 (dBm)
GPRS 1900	1850.2	512	29.54	27.19	25.52	24.5
	1880.0	661	29.52	27.14	25.45	24.42
	1909.8	810	29.45	27.17	25.46	24.41

Unless otherwise stated the results shown in this test report refer only to the sample(s) tested and such sample(s) are retained for 90 days only.

除非另有說明，此報告結果僅對測試之樣品負責，同時此樣品僅保留90天。本報告未經本公司書面許可，不可部份複製。

This document is issued by the Company subject to its General Conditions of Service printed overleaf, available on request or accessible at www.sgs.com/terms_and_conditions.htm and, for electronic format documents, subject to Terms and Conditions for Electronic Documents at www.sgs.com/terms_e-document.htm. Attention is drawn to the limitation of liability, indemnification and jurisdiction issues defined therein. Any holder of this document is advised that information contained hereon reflects the Company's findings at the time of its intervention only and within the limits of Client's instructions, if any. The Company's sole responsibility is to its Client and this document does not exonerate parties to a transaction from exercising all their rights and obligations under the transaction documents. This document cannot be reproduced except in full, without prior written approval of the Company. Any unauthorized alteration, forgery or falsification of the content or appearance of this document is unlawful and offenders may be prosecuted to the fullest extent of the law.

SGS Taiwan Ltd.

No.134,WuKungRoad,NewTaipeiIndustrialPark,WukuDistrict,NewTaipeiCity,Taiwan24803/新北市五股區新北產業園區五工路 134 號

台灣檢驗科技股份有限公司

t (886-2) 2299-3279

f (886-2) 2298-0488

www.tw.sgs.com

Member of SGS Group

WCDMA MODE:

The following tests were completed according to the test requirements outlined in section 5.2 of the 3GPP TS34.121-1 V8.4.0 specification. The EUT supports power Class 3, which has a nominal maximum output power of 24 dBm (+1.7/-3.7). RMC 12.2kps is used for this testing.

Results:

WCDMA MODE:

BNAD II	Avg. Power (dBm)		
	Channel		
	9262	9400	9538
WCDMA	23.06	23.14	23.36
HSDPA	22.40	22.40	22.57
HSUPA	21.84	21.89	22.08

Unless otherwise stated the results shown in this test report refer only to the sample(s) tested and such sample(s) are retained for 90 days only.

除非另有說明，此報告結果僅對測試之樣品負責，同時此樣品僅保留90天。本報告未經本公司書面許可，不可部份複製。

This document is issued by the Company subject to its General Conditions of Service printed overleaf, available on request or accessible at www.sgs.com/terms_and_conditions.htm and, for electronic format documents, subject to Terms and Conditions for Electronic Documents at www.sgs.com/terms_e-document.htm. Attention is drawn to the limitation of liability, indemnification and jurisdiction issues defined therein. Any holder of this document is advised that information contained hereon reflects the Company's findings at the time of its intervention only and within the limits of Client's instructions, if any. The Company's sole responsibility is to its Client and this document does not exonerate parties to a transaction from exercising all their rights and obligations under the transaction documents. This document cannot be reproduced except in full, without prior written approval of the Company. Any unauthorized alteration, forgery or falsification of the content or appearance of this document is unlawful and offenders may be prosecuted to the fullest extent of the law.

SGS Taiwan Ltd.

No.134,WuKungRoad,NewTaipeiIndustrialPark,WukuDistrict,NewTaipeiCity,Taiwan24803/新北市五股區新北產業園區五工路 134 號

台灣檢驗科技股份有限公司

t (886-2) 2299-3279

f (886-2) 2298-0488

www.tw.sgs.com

Member of SGS Group

LTE Result:
LTE Band 2

LTE Band 2 Uplink frequency band : 1850 to 1910 MHz								
BW (MHz)	RB Size	RB Offset	Conducted power(dBm)					
			QPSK			16QAM		
			Channel (Low)	Channel (Mid)	Channel (High)	Channel (Low)	Channel (Mid)	Channel (High)
1.4	1	0	22.76	22.42	22.86	21.64	21.37	21.58
	1	5	22.58	22.60	22.83	21.70	21.52	21.40
	3	2	22.12	22.10	22.37	21.47	21.67	21.72
	6	0	21.60	21.60	21.90	20.58	20.48	20.59

LTE Band 2 Uplink frequency band : 1850 to 1910 MHz								
BW (MHz)	RB Size	RB Offset	Conducted power(dBm)					
			QPSK			16QAM		
			Channel (Low)	Channel (Mid)	Channel (High)	Channel (Low)	Channel (Mid)	Channel (High)
3	1	0	22.49	22.33	22.69	21.76	21.25	21.57
	1	14	22.48	22.68	22.55	21.39	20.81	21.26
	8	4	21.62	21.64	21.78	20.61	20.80	20.93
	15	0	21.59	21.70	21.84	20.47	20.64	20.68

LTE Band 2 Uplink frequency band : 1850 to 1910 MHz								
BW (MHz)	RB Size	RB Offset	Conducted power(dBm)					
			QPSK			16QAM		
			Channel (Low)	Channel (Mid)	Channel (High)	Channel (Low)	Channel (Mid)	Channel (High)
5	1	0	22.30	22.34	22.73	20.82	21.95	21.71
	1	24	22.26	22.30	22.66	21.21	21.74	21.03
	12	6	21.72	21.84	21.87	20.67	20.58	20.66
	25	0	21.64	21.66	21.87	20.72	20.57	20.96

LTE Band 2 Uplink frequency band : 1850 to 1910 MHz								
BW (MHz)	RB Size	RB Offset	Conducted power(dBm)					
			QPSK			16QAM		
			Channel (Low)	Channel (Mid)	Channel (High)	Channel (Low)	Channel (Mid)	Channel (High)
10	1	0	22.45	22.52	22.48	21.32	21.15	21.35
	1	49	22.45	22.44	22.71	21.04	21.39	21.40
	25	12	21.62	21.70	21.81	20.81	21.06	20.81
	50	0	21.69	21.75	21.82	20.86	20.84	20.90

LTE Band 2 Uplink frequency band : 1850 to 1910 MHz								
BW (MHz)	RB Size	RB Offset	Conducted power(dBm)					
			QPSK			16QAM		
			Channel (Low)	Channel (Mid)	Channel (High)	Channel (Low)	Channel (Mid)	Channel (High)
15	1	0	22.48	22.44	22.56	20.78	21.26	21.25
	1	74	22.69	22.63	22.81	21.17	20.97	22.13
	36	19	21.70	21.71	21.77	20.79	20.88	20.82
	75	0	21.63	21.71	21.84	20.81	20.86	21.03

LTE Band 2 Uplink frequency band : 1850 to 1910 MHz								
BW (MHz)	RB Size	RB Offset	Conducted power(dBm)					
			QPSK			16QAM		
			Channel (Low)	Channel (Mid)	Channel (High)	Channel (Low)	Channel (Mid)	Channel (High)
20	1	0	22.40	22.48	22.55	21.63	21.05	21.24
	1	99	22.38	22.21	22.64	21.57	20.80	21.71
	50	25	21.71	21.72	21.81	20.77	20.75	20.90
	100	0	21.80	21.67	21.79	20.83	20.79	20.97

Unless otherwise stated the results shown in this test report refer only to the sample(s) tested and such sample(s) are retained for 90 days only.

除非另有說明，此報告結果僅對測試之樣品負責，同時此樣品僅保留90天。本報告未經本公司書面許可，不可部份複製。

This document is issued by the Company subject to its General Conditions of Service printed overleaf, available on request or accessible at www.sgs.com/terms_and_conditions.htm and, for electronic format documents, subject to Terms and Conditions for Electronic Documents at www.sgs.com/terms_e-document.htm. Attention is drawn to the limitation of liability, indemnification and jurisdiction issues defined therein. Any holder of this document is advised that information contained hereon reflects the Company's findings at the time of its intervention only and within the limits of Client's instructions, if any. The Company's sole responsibility is to its Client and this document does not exonerate parties to a transaction from exercising all their rights and obligations under the transaction documents. This document cannot be reproduced except in full, without prior written approval of the Company. Any unauthorized alteration, forgery or falsification of the content or appearance of this document is unlawful and offenders may be prosecuted to the fullest extent of the law.

HSDPA Release 6 MODE:

The following 4 Sub-Tests were completed according to the test requirements outlined in section 5.2A of the 3GPP TS34.121-1 V8.4.0 specification. All TX RMS power requirements for Power Class 3 were met according to table 5.2AA.5 and 5.2B.5 All UE channels and power ratio's are set according to table C10.1.4 & C11.1.3 in the 3GPP TS34.121-1 V8.4.0. RMC 12.2kps is used for this testing.

HSDPA SUB-TEST Setting

Table C.10.1.4: β values for transmitter characteristics tests with HS-DPCCH(FOR HSDPA)

Sub-test	β_c	β_d	β_d (SF)	β_c/β_d	β_{HS} (Note 1, Note 2)	CM (dB) (Note 3)	MPR (dB) (Note 3)	RMC (Kbps)
1	2/15	15/15	64	2/15	4/15	0.0	0.0	12.2
2	12/15 (Note 4)	15/15 (Note 4)	64	12/15 (Note 4)	24/15	1.0	0.0	12.2
3	15/15	8/15	64	15/8	30/15	1.5	0.5	12.2
4	15/15	4/15	64	15/4	30/15	1.5	0.5	12.2

Note: The recommended HSDPA MPRs are implemented as per following sub-tests.

Results:

Mode	Sub test	Avg. Power (dBm) Channel			Power Class 3 Limitation (dBm)	Comments
		9262	9400	9538		
HSDPA II	1	22.4	22.4	22.57	20.3dBm – 25.7dBm	Pass
	2	21.83	21.78	22.07	20.3dBm – 25.7dBm	Pass
	3	21.82	21.77	22.06	19.8dBm – 25.7dBm	Pass
	4	21.81	21.76	21.94	19.8dBm – 25.7dBm	Pass

Unless otherwise stated the results shown in this test report refer only to the sample(s) tested and such sample(s) are retained for 90 days only.

除非另有說明，此報告結果僅對測試之樣品負責，同時此樣品僅保留90天。本報告未經本公司書面許可，不可部份複製。

This document is issued by the Company subject to its General Conditions of Service printed overleaf, available on request or accessible at www.sgs.com/terms_and_conditions.htm and, for electronic format documents, subject to Terms and Conditions for Electronic Documents at www.sgs.com/terms_e-document.htm. Attention is drawn to the limitation of liability, indemnification and jurisdiction issues defined therein. Any holder of this document is advised that information contained hereon reflects the Company's findings at the time of its intervention only and within the limits of Client's instructions, if any. The Company's sole responsibility is to its Client and this document does not exonerate parties to a transaction from exercising all their rights and obligations under the transaction documents. This document cannot be reproduced except in full, without prior written approval of the Company. Any unauthorized alteration, forgery or falsification of the content or appearance of this document is unlawful and offenders may be prosecuted to the fullest extent of the law.

HSPA (HSDPA & HSUPA) Release 6 MODE

The following 5 Sub-Tests were completed according to the test requirements outlined in section 5.2A of the 3GPP TS34.121-1 V8.4.0 specification. All TX RMS power requirements for Power Class 3 were met according to table 5.2AA.5 and 5.2B.5 All UE channels and power ratio's are set according to table C11.1.3 in the 3GPP TS34.121-1 V8.4.0. RMC 12.2kps is used for this testing

HSPA SUB-TEST Setting

Table C.11.1.3: β values for transmitter characteristics tests with HS-DPCCH and E-DCH(FOR HSUPA)

Sub-test	β_c	β_d	β_d (SF)	β_c/β_d	β_{HS}	β_{ec}	β_{ed}	β_{ed} (SF)	β_{ed} (Code s)	CM (dB)	MPR (dB)	AG Index	E-TFCI	RMC (Kbps)
1	11/15 (Note 3)	15/15 (Note 3)	64	11/15 (Note 3)	22/15	209/225	1309/225	4	1	1.0	0.0	20	75	12.2
2	6/15	15/15	64	6/15	12/15	12/15	94/75	4	1	3.0	2.0	12	67	12.2
3	15/15	9/15	64	15/9	30/15	30/15	$\beta_{ed1}: 47/15$ $\beta_{ed2}: 47/15$	4 4	2	2.0	1.0	15	92	12.2
4	2/15	15/15	64	2/15	4/15	2/15	56/75	4	1	3.0	2.0	17	71	12.2
5	15/15 (Note 4)	15/15 (Note 4)	64	15/15 (Note 4)	30/15	24/15	134/15	4	1	1.0	0.0	21	81	12.2

Note: The recommended HSUPA MPRs are implemented as per following sub-tests.

Results:

Mode	Sub test	Avg. Power (dBm) Channel			Power Class 3 Limitation (dBm)	Comments
		9262	9400	9538		
HSUPA II	1	21.84	21.89	22.08	18.8dBm – 25.7dBm	Pass
	2	21.13	21.18	21.19	16.8dBm – 25.7dBm	Pass
	3	20.92	20.88	21.09	17.8dBm – 25.7dBm	Pass
	4	21.33	21.32	21.31	16.8dBm – 25.7dBm	Pass
	5	21.89	22.06	22.5	18.8dBm – 25.7dBm	Pass

Unless otherwise stated the results shown in this test report refer only to the sample(s) tested and such sample(s) are retained for 90 days only.

除非另有說明，此報告結果僅對測試之樣品負責，同時此樣品僅保留90天。本報告未經本公司書面許可，不可部份複製。

This document is issued by the Company subject to its General Conditions of Service printed overleaf, available on request or accessible at www.sgs.com/terms_and_conditions.htm and, for electronic format documents, subject to Terms and Conditions for Electronic Documents at www.sgs.com/terms_e-document.htm. Attention is drawn to the limitation of liability, indemnification and jurisdiction issues defined therein. Any holder of this document is advised that information contained hereon reflects the Company's findings at the time of its intervention only and within the limits of Client's instructions, if any. The Company's sole responsibility is to its Client and this document does not exonerate parties to a transaction from exercising all their rights and obligations under the transaction documents. This document cannot be reproduced except in full, without prior written approval of the Company. Any unauthorized alteration, forgery or falsification of the content or appearance of this document is unlawful and offenders may be prosecuted to the fullest extent of the law.

Minimum Communications Power Measurement

PCS 1900 band

PCL	0	1	2	3	4	5	6	7	8
Output power (dBm)	29.54	28.7	25.9	23.7	22.4	19.6	17.4	15.6	13.3

PCL	9	10	11	12	13	14	15
Output power (dBm)	10.9	9.4	7.3	4.5	2.7	1.5	-0.1

Note: The EUT output power was controlled by simulator. Set Communication Tester [MT8820C](#) PCL as above, and get the mobile phone output power reading.

WCDMA/HSDPA/HSUPA band V

The EUT output power was controlled by simulator. Set Communication Tester [MT8820C](#) function key "UE Power Control" and enter max rated power 24dBm. The EUT is going to be set to max output power to 24dBm. Then record the read (see page 15 for measurement data). The min. power was measures by a function key "minimum power" then record the read. It is -52.3dBm. The power variation can be 0.1dB step by setting.

Unless otherwise stated the results shown in this test report refer only to the sample(s) tested and such sample(s) are retained for 90 days only.

除非另有說明，此報告結果僅對測試之樣品負責，同時此樣品僅保留90天。本報告未經本公司書面許可，不可部份複製。

This document is issued by the Company subject to its General Conditions of Service printed overleaf, available on request or accessible at www.sgs.com/terms_and_conditions.htm and, for electronic format documents, subject to Terms and Conditions for Electronic Documents at www.sgs.com/terms_e-document.htm. Attention is drawn to the limitation of liability, indemnification and jurisdiction issues defined therein. Any holder of this document is advised that information contained hereon reflects the Company's findings at the time of its intervention only and within the limits of Client's instructions, if any. The Company's sole responsibility is to its Client and this document does not exonerate parties to a transaction from exercising all their rights and obligations under the transaction documents. This document cannot be reproduced except in full, without prior written approval of the Company. Any unauthorized alteration, forgery or falsification of the content or appearance of this document is unlawful and offenders may be prosecuted to the fullest extent of the law.

SGS Taiwan Ltd.

No.134,WuKungRoad,NewTaipeiIndustrialPark,WukuDistrict,NewTaipeiCity,Taiwan24803/新北市五股區新北產業園區五工路 134 號

台灣檢驗科技股份有限公司

t (886-2) 2299-3279

f (886-2) 2298-0488

www.tw.sgs.com

Member of SGS Group

7 EFFECTIVE RADIATED POWER AND EQUIVALENT ISOTROPIC RADIATED POWER MEASUREMENT

7.1 Standard Applicable

According to FCC §2.1046

FCC 24.232(c) Mobile and portable stations are limited to 2 W EIRP.

7.2 Test SET-UP

(A) Radiated Power Test Set-Up, Frequency Below 1000MHz

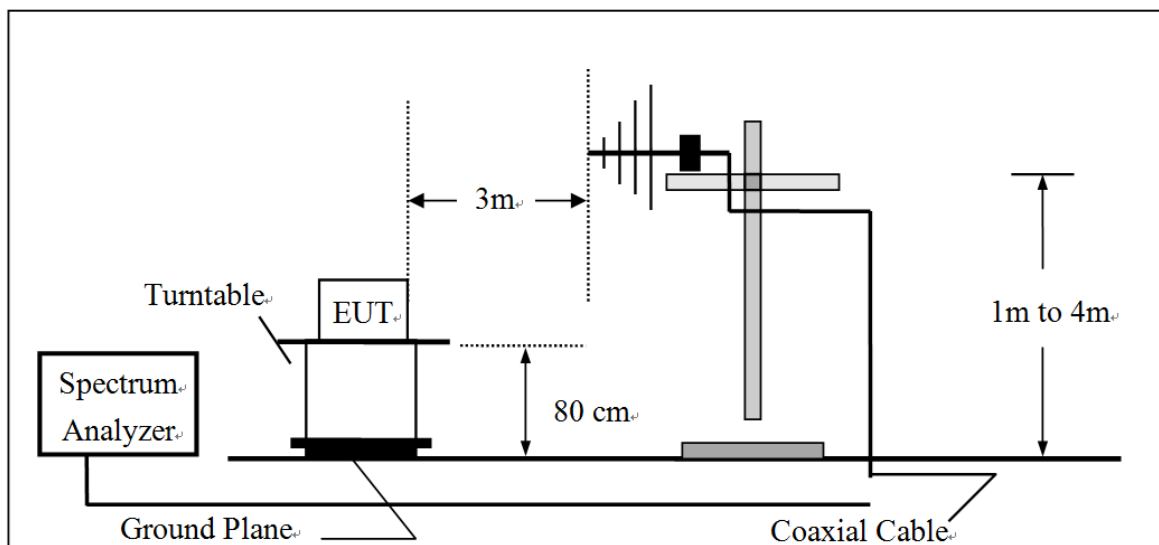

Unless otherwise stated the results shown in this test report refer only to the sample(s) tested and such sample(s) are retained for 90 days only.

除非另有說明，此報告結果僅對測試之樣品負責，同時此樣品僅保留90天。本報告未經本公司書面許可，不可部份複製。

This document is issued by the Company subject to its General Conditions of Service printed overleaf, available on request or accessible at www.sgs.com/terms_and_conditions.htm and, for electronic format documents, subject to Terms and Conditions for Electronic Documents at www.sgs.com/terms_e-document.htm. Attention is drawn to the limitation of liability, indemnification and jurisdiction issues defined therein. Any holder of this document is advised that information contained hereon reflects the Company's findings at the time of its intervention only and within the limits of Client's instructions, if any. The Company's sole responsibility is to its Client and this document does not exonerate parties to a transaction from exercising all their rights and obligations under the transaction documents. This document cannot be reproduced except in full, without prior written approval of the Company. Any unauthorized alteration, forgery or falsification of the content or appearance of this document is unlawful and offenders may be prosecuted to the fullest extent of the law.

(B) Radiated Power Test Set-UP Frequency Over 1 GHz

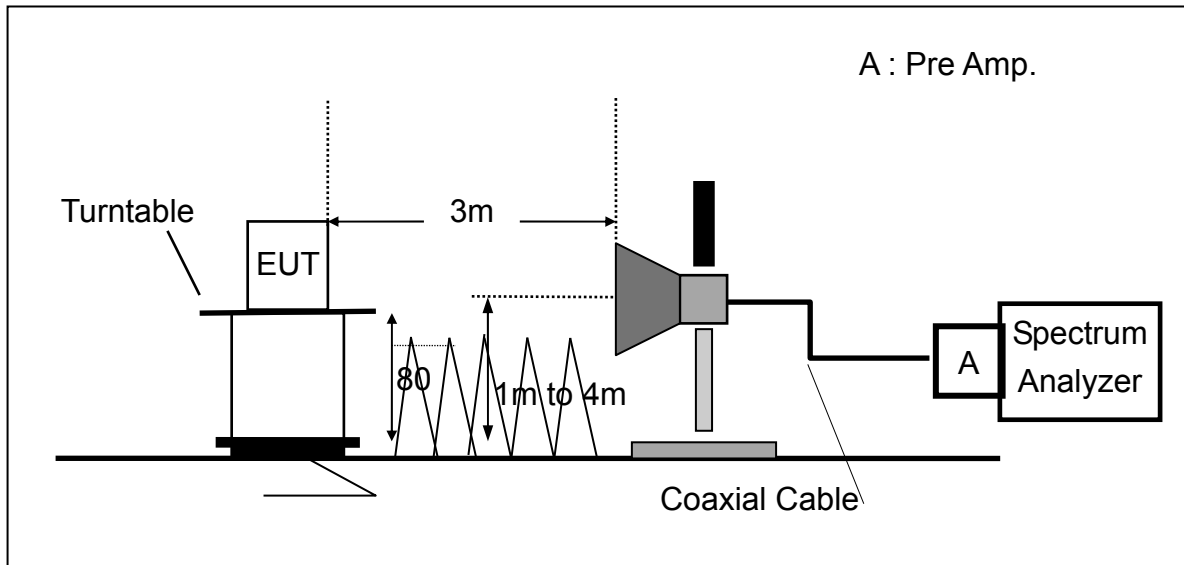

(C) Substituted Method Test Set-UP

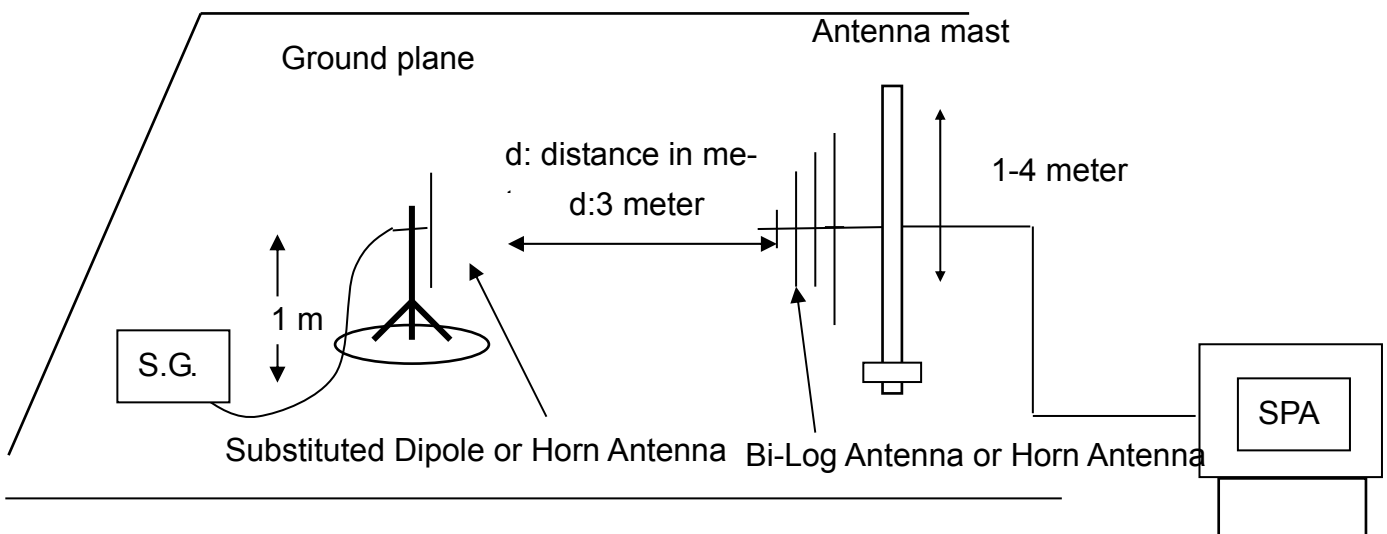

Unless otherwise stated the results shown in this test report refer only to the sample(s) tested and such sample(s) are retained for 90 days only.

除非另有說明，此報告結果僅對測試之樣品負責，同時此樣品僅保留90天。本報告未經本公司書面許可，不可部份複製。

This document is issued by the Company subject to its General Conditions of Service printed overleaf, available on request or accessible at www.sgs.com/terms_and_conditions.htm and, for electronic format documents, subject to Terms and Conditions for Electronic Documents at www.sgs.com/terms_e-document.htm. Attention is drawn to the limitation of liability, indemnification and jurisdiction issues defined therein. Any holder of this document is advised that information contained hereon reflects the Company's findings at the time of its intervention only and within the limits of Client's instructions, if any. The Company's sole responsibility is to its Client and this document does not exonerate parties to a transaction from exercising all their rights and obligations under the transaction documents. This document cannot be reproduced except in full, without prior written approval of the Company. Any unauthorized alteration, forgery or falsification of the content or appearance of this document is unlawful and offenders may be prosecuted to the fullest extent of the law.

7.3 Measurement Procedure

1. The testing follows the Measurement Procedure of FCC KDB 971168 D01
2. The EUT was placed on a non-conductive turntable using a non-conductive support. The radiated emission at the fundamental frequency was measured at 3 m with a test antenna and EMI spectrum analyzer.
3. During the measurement, the EUT was communication with the station. The highest emission was recorded with the rotation of the turntable and the lowering of the test antenna from 4m to 1m. The reading was recorded and the field strength (E in dBuV/m) was calculated
4. The testing follows the Measurement Procedure of FCC KDB 971168 D01
5. The substitution horn antenna is substituted for EUT at the same position and signals generator export the CW signal to the substitution antenna via a tx cable. Rotated the Turn Table and moved receiving antenna to find the maximum radiation power. Adjust output power level of S.G to get a Value of spectrum reading equal to "Read Value" of step b. Record the power level of S.G.
6. $ERP = S.G. \text{ output (dBm)} + \text{Antenna Gain (dBd)} - \text{Cable Loss (dB)}$
7. $ERP = S.G. \text{ output (dBm)} + \text{Antenna Gain (dBd)} - \text{Cable Loss (dB)}$
8. Spectrum setting:
 - (1) Detector = Peak, marker the highest value of the detector by maximum hold, set RBW wide enough to capture the entire signal of emission, and $VBW > = 3 \times RBW$.
 - (2) KDB 971168 D01 is adopted, and the procedure as lists under item 4, Measurement of the Average Power over the Fundamental Signal Bandwidth, is followed to set correspondingly for the acquisition of proper measurement data.
Set frequency = nominal signal center frequency;
Set span = 2 X occupied BW;
Set RBW \approx 1~5% of the span, not to exceed 1 MHz
Set VBW = 3 x RBW;
Select average power (RMS) detector
Set sweep time and number of measurement points to achieve a minimum of 1 millisecond/pt integration time (ex. Point = 601points, then sweep time = $601 \times 10^{-3} = 6s$).

Activate trace averaging routine over a minimum of 10 sweeps;

Activate marker/span pair and set span = signal or channel bandwidth;

Activate the band/interval power marker function;

Record the band power level;

Record adjusted value as the average signal power level. Then activate the occupied bandwidth measurement function.

The proper adjustment due to limitation of spectrum capability is given compensated to spectrum with conversion factor of $10 \times \log(TBW/RBW)$, where TBW is the transmission of UE exceeding the maximum BW UE can extends, and RBW is the resolution BW in UE.

Unless otherwise stated the results shown in this test report refer only to the sample(s) tested and such sample(s) are retained for 90 days only.

除非另有說明，此報告結果僅對測試之樣品負責，同時此樣品僅保留90天。本報告未經本公司書面許可，不可部份複製。

This document is issued by the Company subject to its General Conditions of Service printed overleaf, available on request or accessible at www.sgs.com/terms_and_conditions.htm and, for electronic format documents, subject to Terms and Conditions for Electronic Documents at www.sgs.com/terms_e-document.htm. Attention is drawn to the limitation of liability, indemnification and jurisdiction issues defined therein. Any holder of this document is advised that information contained hereon reflects the Company's findings at the time of its intervention only and within the limits of Client's instructions, if any. The Company's sole responsibility is to its Client and this document does not exonerate parties to a transaction from exercising all their rights and obligations under the transaction documents. This document cannot be reproduced except in full, without prior written approval of the Company. Any unauthorized alteration, forgery or falsification of the content or appearance of this document is unlawful and offenders may be prosecuted to the fullest extent of the law.

7.4 Measurement Equipment Used

ERP, EIRP MEASUREMENT EQUIPMENT List 966 Chamber					
EQUIPMENT TYPE	MFR	MODEL NUMBER	SERIAL NUMBER	LAST CAL.	CAL DUE.
EMI Test Receiver	R&S	ESC17	100760	05/11/2017	05/10/2018
Spectrum Analyzer	Agilent	E4446A	MY51100003	04/25/2017	04/24/2018
Loop Antenna	ETS-Lindgren	6502	148045	09/20/2016	09/19/2017
Bilog Antenna	SCHWAZBECK	VULB9168	378	12/19/2016	12/18/2017
Horn Antenna	Schwarzbeck	BBHA9120D	1441	08/04/2017	08/03/2018
Pre-Amplifier	Agilent	8447D	2944A07676	01/03/2017	01/02/2018
Pre-Amplifier	EMC Instruments Corp.	EMC0126530	980038	01/03/2017	01/02/2018
Turn Table	HD	DT420	N/A	N.C.R	N.C.R
Antenna Tower	ChamPro	AM-BS-4500-B	060776-ABS	N.C.R	N.C.R
Controller	ChamPro	EM1000	60776	N.C.R	N.C.R
Low Loss Cable	Huber Suhner	966_RX	9	01/05/2017	01/04/2018
3m Site NSA	SGS	966 chamber	N/A	07/01/2017	06/30/2018
Low Loss Cable	Huber Suhner	966 TX	1	01/05/2017	01/04/2018
Horn Antenna	Schwarzbeck	BBHA9170	184	12/12/2016	12/11/2017
Pre-Amplifier	EMC Instruments Corp.	EMC184045	980135	01/05/2017	01/04/2018
EMI Test Receiver	R&S	ESC17	100760	05/11/2017	05/10/2018
Radio Communication Analyzer	R&S	CMU200	102189	02/11/2017	02/10/2018
Radio Communication Analyzer	Anritsu	MT8820C	6201465317	01/03/2017	01/02/2018

Remark: Please note that the duration to conduct the test took place in the mean time when the calibration for several equipments is due, and therefore extra tables of equipment calibration is constructed to indicate the calibration work is still maintained.

EQUIPMENT TYPE	MFR	MODEL NUMBER	SERIAL NUMBER	LAST CAL.	CAL DUE.
Loop Antenna	ETS-Lindgren	6502	148045	09/20/2017	09/19/2018

Unless otherwise stated the results shown in this test report refer only to the sample(s) tested and such sample(s) are retained for 90 days only.

除非另有說明，此報告結果僅對測試之樣品負責，同時此樣品僅保留90天。本報告未經本公司書面許可，不可部份複製。

This document is issued by the Company subject to its General Conditions of Service printed overleaf, available on request or accessible at www.sgs.com/terms_and_conditions.htm and, for electronic format documents, subject to Terms and Conditions for Electronic Documents at www.sgs.com/terms_e-document.htm. Attention is drawn to the limitation of liability, indemnification and jurisdiction issues defined therein. Any holder of this document is advised that information contained hereon reflects the Company's findings at the time of its intervention only and within the limits of Client's instructions, if any. The Company's sole responsibility is to its Client and this document does not exonerate parties to a transaction from exercising all their rights and obligations under the transaction documents. This document cannot be reproduced except in full, without prior written approval of the Company. Any unauthorized alteration, forgery or falsification of the content or appearance of this document is unlawful and offenders may be prosecuted to the fullest extent of the law.

SGS Taiwan Ltd.

No.134,WuKungRoad,NewTaipeiIndustrialPark,WukuDistrict,NewTaipeiCity,Taiwan24803/新北市五股區新北產業園區五工路 134 號

台灣檢驗科技股份有限公司

t (886-2) 2299-3279

f (886-2) 2298-0488

www.tw.sgs.com

Member of SGS Group

7.5 Measurement Result: (Peak) –using option of peak measurement

EUT			Measurement					
Operation Band	Fundamental Frequency	CH	Antenna Pol.	S.G. Output	Antenna Gain	Cable Loss	ERP	Limit
	MHz		V/H	dBm	dBd	dB	dBm	dBm
GSM 1900	1850.2	512	V	12.97	9.94	-4.46	18.45	33.00
			H	15.92	9.94	-4.46	21.40	33.00
	1880.0	661	V	14.44	10.03	-4.51	19.97	33.00
			H	16.58	10.03	-4.51	22.10	33.00
	1909.8	810	V	14.07	10.13	-4.55	19.65	33.00
			H	16.86	10.13	-4.55	22.44	33.00
GPRS 1900	1850.2	512	V	15.86	9.94	-4.46	21.34	33.00
			H	20.81	9.94	-4.46	26.29	33.00
	1880.0	661	V	17.93	10.03	-4.51	23.45	33.00
			H	20.70	10.03	-4.51	26.22	33.00
	1909.8	810	V	17.75	10.13	-4.55	23.33	33.00
			H	20.20	10.13	-4.55	25.78	33.00

Remark: The RBW,VBW of SPA for frequency RBW=300 KHz, VBW=1MHz

Unless otherwise stated the results shown in this test report refer only to the sample(s) tested and such sample(s) are retained for 90 days only.

除非另有說明，此報告結果僅對測試之樣品負責，同時此樣品僅保留90天。本報告未經本公司書面許可，不可部份複製。

This document is issued by the Company subject to its General Conditions of Service printed overleaf, available on request or accessible at www.sgs.com/terms_and_conditions.htm and, for electronic format documents, subject to Terms and Conditions for Electronic Documents at www.sgs.com/terms_e-document.htm. Attention is drawn to the limitation of liability, indemnification and jurisdiction issues defined therein. Any holder of this document is advised that information contained hereon reflects the Company's findings at the time of its intervention only and within the limits of Client's instructions, if any. The Company's sole responsibility is to its Client and this document does not exonerate parties to a transaction from exercising all their rights and obligations under the transaction documents. This document cannot be reproduced except in full, without prior written approval of the Company. Any unauthorized alteration, forgery or falsification of the content or appearance of this document is unlawful and offenders may be prosecuted to the fullest extent of the law.

SGS Taiwan Ltd.

No.134,WuKungRoad,NewTaipeiIndustrialPark,WukuDistrict,NewTaipeiCity,Taiwan24803/新北市五股區新北產業園區五工路 134 號

台灣檢驗科技股份有限公司

t (886-2) 2299-3279

f (886-2) 2298-0488

www.tw.sgs.com

Member of SGS Group

EUT			Measurement					
Operation Band	Fundamental Frequency	CH	Antenna Pol.	S.G. Output	Antenna Gain	Cable Loss	EIRP	Limit
	MHz		V/H	dBm	dBd	dB	dBm	dBm
WCDMA Band II	1852.4	9262	V	12.97	9.94	-4.46	18.45	33.00
			H	11.30	9.94	-4.46	16.78	33.00
	1880.0	9400	V	12.52	10.03	-4.51	18.04	33.00
			H	8.25	10.03	-4.51	13.77	33.00
	1907.6	9538	V	12.41	10.13	-4.55	17.99	33.00
			H	12.95	10.13	-4.55	18.53	33.00
HSDPA Band II	1852.4	9262	V	13.80	9.94	-4.46	19.28	33.00
			H	13.22	9.94	-4.46	18.70	33.00
	1880.0	9400	V	13.90	10.03	-4.51	19.42	33.00
			H	11.28	10.03	-4.51	16.80	33.00
	1907.6	9538	V	13.26	10.13	-4.55	18.84	33.00
			H	13.79	10.13	-4.55	19.37	33.00
HSUPA Band II	1852.4	9262	V	13.75	9.94	-4.46	19.23	33.00
			H	12.63	9.94	-4.46	18.11	33.00
	1880.0	9400	V	13.46	10.03	-4.51	18.98	33.00
			H	10.11	10.03	-4.51	15.63	33.00
	1907.6	9538	V	13.20	10.13	-4.55	18.78	33.00
			H	13.57	10.13	-4.55	19.15	33.00

Remark: The RBW,VBW of SPA for frequency RBW=5 MHz, VBW=8 MHz

Unless otherwise stated the results shown in this test report refer only to the sample(s) tested and such sample(s) are retained for 90 days only.

除非另有說明，此報告結果僅對測試之樣品負責，同時此樣品僅保留90天。本報告未經本公司書面許可，不可部份複製。

This document is issued by the Company subject to its General Conditions of Service printed overleaf, available on request or accessible at www.sgs.com/terms_and_conditions.htm and, for electronic format documents, subject to Terms and Conditions for Electronic Documents at www.sgs.com/terms_e-document.htm. Attention is drawn to the limitation of liability, indemnification and jurisdiction issues defined therein. Any holder of this document is advised that information contained hereon reflects the Company's findings at the time of its intervention only and within the limits of Client's instructions, if any. The Company's sole responsibility is to its Client and this document does not exonerate parties to a transaction from exercising all their rights and obligations under the transaction documents. This document cannot be reproduced except in full, without prior written approval of the Company. Any unauthorized alteration, forgery or falsification of the content or appearance of this document is unlawful and offenders may be prosecuted to the fullest extent of the law.

EUT			Measurement					
Operation Band	Fundamental Frequency MHz	CH	Antenna Pol. V/H	S.G. Output dBm	Antenna Gain dBi	Cable Loss dB	EIRP dBm	Limit dBm
BAND 2 BW: 1.4M QPSK RB: 1,0	1850.7	18607	V	17.89	9.94	-4.46	23.37	33.01
			H	17.18	9.95	-4.46	22.66	33.01
	1880.0	18900	V	17.83	10.03	-4.51	23.35	33.01
			H	18.15	10.03	-4.51	23.68	33.01
	1909.3	19193	V	15.43	10.12	-4.55	21.00	33.01
			H	16.57	10.12	-4.55	22.14	33.01
BAND 2 BW: 1.4M QPSK RB: 1,5	1850.7	18607	V	18.02	9.94	-4.46	23.49	33.01
			H	17.36	9.94	-4.46	22.84	33.01
	1880.0	18900	V	17.82	10.03	-4.51	23.35	33.01
			H	18.09	10.03	-4.51	23.61	33.01
	1909.3	19193	V	15.47	10.12	-4.55	21.04	33.01
			H	16.36	10.12	-4.55	21.93	33.01
BAND 2 BW: 1.4M 16QAM RB: 1,0	1850.7	18607	V	17.46	9.95	-4.46	22.94	33.01
			H	16.88	9.94	-4.46	22.37	33.01
	1880.0	18900	V	17.40	10.03	-4.51	22.92	33.01
			H	17.86	10.03	-4.51	23.38	33.01
	1909.3	19193	V	15.08	10.12	-4.55	20.65	33.01
			H	16.04	10.12	-4.55	21.62	33.01
BAND 2 BW: 1.4M 16QAM RB: 1,5	1850.7	18607	V	17.71	9.94	-4.46	23.19	33.01
			H	17.00	9.94	-4.46	22.48	33.01
	1880.0	18900	V	17.39	10.03	-4.51	22.92	33.01
			H	17.77	10.03	-4.51	23.29	33.01
	1909.3	19193	V	15.20	10.12	-4.55	20.77	33.01
			H	16.13	10.12	-4.55	21.71	33.01

The RBW,VBW of SPA for frequency RBW= 8MHz , VBW= 8MHz

Unless otherwise stated the results shown in this test report refer only to the sample(s) tested and such sample(s) are retained for 90 days only.

除非另有說明，此報告結果僅對測試之樣品負責，同時此樣品僅保留90天。本報告未經本公司書面許可，不可部份複製。

This document is issued by the Company subject to its General Conditions of Service printed overleaf, available on request or accessible at www.sgs.com/terms_and_conditions.htm and, for electronic format documents, subject to Terms and Conditions for Electronic Documents at www.sgs.com/terms_e-document.htm. Attention is drawn to the limitation of liability, indemnification and jurisdiction issues defined therein. Any holder of this document is advised that information contained hereon reflects the Company's findings at the time of its intervention only and within the limits of Client's instructions, if any. The Company's sole responsibility is to its Client and this document does not exonerate parties to a transaction from exercising all their rights and obligations under the transaction documents. This document cannot be reproduced except in full, without prior written approval of the Company. Any unauthorized alteration, forgery or falsification of the content or appearance of this document is unlawful and offenders may be prosecuted to the fullest extent of the law.

SGS Taiwan Ltd.

No.134,WuKungRoad,NewTaipeiIndustrialPark,WukuDistrict,NewTaipeiCity,Taiwan24803/新北市五股區新北產業園區五工路 134 號

台灣檢驗科技股份有限公司

t (886-2) 2299-3279

f (886-2) 2298-0488

www.tw.sgs.com

Member of SGS Group

EUT			Measurement					
Operation Band	Fundamental Frequency MHz	CH	Antenna Pol. V/H	S.G. Output dBm	Antenna Gain dBi	Cable Loss dB	EIRP dBm	Limit dBm
BAND 2 BW: 3M QPSK RB: 1,0	1851.5	18615	V	18.18	9.94	-4.46	23.66	33.01
			H	17.29	9.95	-4.46	22.77	33.01
	1880.0	18900	V	17.75	10.03	-4.50	23.27	33.01
			H	17.87	10.03	-4.50	23.39	33.01
	1908.5	19185	V	15.48	10.11	-4.55	21.05	33.01
			H	16.39	10.11	-4.55	21.96	33.01
BAND 2 BW: 3M QPSK RB: 1,14	1851.5	18615	V	18.42	9.94	-4.46	23.90	33.01
			H	17.25	9.94	-4.46	22.73	33.01
	1880.0	18900	V	17.96	10.03	-4.51	23.49	33.01
			H	17.95	10.03	-4.51	23.48	33.01
	1908.5	19185	V	15.55	10.12	-4.55	21.12	33.01
			H	16.22	10.12	-4.55	21.79	33.01
BAND 2 BW: 3M 16QAM RB: 1,0	1851.5	18615	V	18.08	9.95	-4.46	23.56	33.01
			H	16.55	9.95	-4.46	22.04	33.01
	1880.0	18900	V	17.32	10.03	-4.50	22.84	33.01
			H	17.42	10.03	-4.50	22.94	33.01
	1908.5	19185	V	14.94	10.11	-4.55	20.51	33.01
			H	15.92	10.11	-4.55	21.49	33.01
BAND 2 BW: 3M 16QAM RB: 1,14	1851.5	18615	V	18.11	9.94	-4.46	23.59	33.01
			H	16.63	9.94	-4.46	22.11	33.01
	1880.0	18900	V	17.34	10.03	-4.51	22.87	33.01
			H	17.58	10.03	-4.51	23.11	33.01
	1908.5	19185	V	15.17	10.12	-4.55	20.75	33.01
			H	15.92	10.12	-4.55	21.49	33.01

The RBW,VBW of SPA for frequency RBW= 8MHz , VBW= 8MHz

Unless otherwise stated the results shown in this test report refer only to the sample(s) tested and such sample(s) are retained for 90 days only.

除非另有說明，此報告結果僅對測試之樣品負責，同時此樣品僅保留90天。本報告未經本公司書面許可，不可部份複製。

This document is issued by the Company subject to its General Conditions of Service printed overleaf, available on request or accessible at www.sgs.com/terms_and_conditions.htm and, for electronic format documents, subject to Terms and Conditions for Electronic Documents at www.sgs.com/terms_e-document.htm. Attention is drawn to the limitation of liability, indemnification and jurisdiction issues defined therein. Any holder of this document is advised that information contained hereon reflects the Company's findings at the time of its intervention only and within the limits of Client's instructions, if any. The Company's sole responsibility is to its Client and this document does not exonerate parties to a transaction from exercising all their rights and obligations under the transaction documents. This document cannot be reproduced except in full, without prior written approval of the Company. Any unauthorized alteration, forgery or falsification of the content or appearance of this document is unlawful and offenders may be prosecuted to the fullest extent of the law.

SGS Taiwan Ltd.

No.134,WuKungRoad,NewTaipeiIndustrialPark,WukuDistrict,NewTaipeiCity,Taiwan24803/新北市五股區新北產業園區五工路 134 號

台灣檢驗科技股份有限公司

t (886-2) 2299-3279

f (886-2) 2298-0488

www.tw.sgs.com

Member of SGS Group

EUT			Measurement					
Operation Band	Fundamental Frequency MHz	CH	Antenna Pol. V/H	S.G. Output dBm	Antenna Gain dBi	Cable Loss dB	EIRP dBm	Limit dBm
BAND 2 BW: 5M QPSK RB: 1,0	1852.5	18625	V	18.02	9.95	-4.46	23.50	33.01
			H	16.86	9.95	-4.46	22.34	33.01
	1880.0	18900	V	17.63	10.02	-4.50	23.15	33.01
			H	17.74	10.02	-4.50	23.26	33.01
	1907.5	19175	V	15.29	10.11	-4.54	20.86	33.01
			H	16.51	10.11	-4.54	22.08	33.01
BAND 2 BW: 5M QPSK RB: 1,24	1852.5	18625	V	18.32	9.95	-4.46	23.80	33.01
			H	16.99	9.95	-4.47	22.48	33.01
	1880.0	18900	V	17.75	10.04	-4.51	23.28	33.01
			H	17.74	10.04	-4.51	23.27	33.01
	1907.5	19175	V	15.42	10.12	-4.55	21.00	33.01
			H	16.15	10.12	-4.55	21.72	33.01
BAND 2 BW: 5M 16QAM RB: 1,0	1852.5	18625	V	17.41	9.95	-4.46	22.89	33.01
			H	16.26	9.95	-4.46	21.75	33.01
	1880.0	18900	V	17.17	10.02	-4.50	22.69	33.01
			H	17.76	10.02	-4.50	23.28	33.01
	1907.5	19175	V	15.00	10.11	-4.54	20.57	33.01
			H	16.17	10.11	-4.54	21.74	33.01
BAND 2 BW: 5M 16QAM RB: 1,24	1852.5	18625	V	17.65	9.95	-4.46	23.14	33.01
			H	16.44	9.95	-4.47	21.93	33.01
	1880.0	18900	V	17.25	10.04	-4.51	22.78	33.01
			H	17.35	10.04	-4.51	22.88	33.01
	1907.5	19175	V	14.97	10.12	-4.55	20.54	33.01
			H	15.80	10.12	-4.55	21.38	33.01

The RBW,VBW of SPA for frequency RBW= 8MHz , VBW= 8MHz

Unless otherwise stated the results shown in this test report refer only to the sample(s) tested and such sample(s) are retained for 90 days only.

除非另有說明，此報告結果僅對測試之樣品負責，同時此樣品僅保留90天。本報告未經本公司書面許可，不可部份複製。

This document is issued by the Company subject to its General Conditions of Service printed overleaf, available on request or accessible at www.sgs.com/terms_and_conditions.htm and, for electronic format documents, subject to Terms and Conditions for Electronic Documents at www.sgs.com/terms_e-document.htm. Attention is drawn to the limitation of liability, indemnification and jurisdiction issues defined therein. Any holder of this document is advised that information contained hereon reflects the Company's findings at the time of its intervention only and within the limits of Client's instructions, if any. The Company's sole responsibility is to its Client and this document does not exonerate parties to a transaction from exercising all their rights and obligations under the transaction documents. This document cannot be reproduced except in full, without prior written approval of the Company. Any unauthorized alteration, forgery or falsification of the content or appearance of this document is unlawful and offenders may be prosecuted to the fullest extent of the law.

SGS Taiwan Ltd.

No.134,WuKungRoad,NewTaipeiIndustrialPark,WukuDistrict,NewTaipeiCity,Taiwan24803/新北市五股區新北產業園區五工路 134 號

台灣檢驗科技股份有限公司

t (886-2) 2299-3279

f (886-2) 2298-0488

www.tw.sgs.com

Member of SGS Group

EUT			Measurement					
Operation Band	Fundamental Frequency MHz	CH	Antenna Pol. V/H	S.G. Output dBm	Antenna Gain dBi	Cable Loss dB	EIRP dBm	Limit dBm
BAND 2 BW: 10M QPSK RB: 1,0	1855.0	18650	V	18.05	9.94	-4.46	23.52	33.01
			H	16.58	9.94	-4.46	22.06	33.01
	1880.0	18900	V	17.56	10.02	-4.50	23.07	33.01
			H	17.51	10.02	-4.50	23.03	33.01
	1905.0	19150	V	16.31	10.09	-4.54	21.87	33.01
			H	17.06	10.09	-4.54	22.61	33.01
BAND 2 BW: 10M QPSK RB: 1,49	1855.0	18650	V	18.22	9.96	-4.47	23.71	33.01
			H	16.83	9.96	-4.47	22.32	33.01
	1880.0	18900	V	17.51	10.04	-4.51	23.04	33.01
			H	17.32	10.04	-4.51	22.85	33.01
	1905.0	19150	V	15.23	10.12	-4.55	20.80	33.01
			H	15.78	10.12	-4.55	21.36	33.01
BAND 2 BW: 10M 16QAM RB: 1,0	1855.0	18650	V	17.44	9.94	-4.46	22.92	33.01
			H	16.72	9.95	-4.46	22.20	33.01
	1880.0	18900	V	16.85	10.02	-4.50	22.36	33.01
			H	17.21	10.02	-4.50	22.72	33.01
	1905.0	19150	V	15.84	10.09	-4.54	21.39	33.01
			H	16.65	10.09	-4.54	22.21	33.01
BAND 2 BW: 10M 16QAM RB: 1,49	1855.0	18650	V	17.75	9.96	-4.47	23.25	33.01
			H	16.40	9.96	-4.47	21.89	33.01
	1880.0	18900	V	16.88	10.04	-4.51	22.41	33.01
			H	16.67	10.04	-4.51	22.20	33.01
	1905.0	19150	V	14.91	10.12	-4.55	20.48	33.01
			H	15.51	10.12	-4.55	21.08	33.01

The RBW,VBW of SPA for frequency RBW= 8MHz , VBW= 8MHz

Unless otherwise stated the results shown in this test report refer only to the sample(s) tested and such sample(s) are retained for 90 days only.

除非另有說明，此報告結果僅對測試之樣品負責，同時此樣品僅保留90天。本報告未經本公司書面許可，不可部份複製。

This document is issued by the Company subject to its General Conditions of Service printed overleaf, available on request or accessible at www.sgs.com/terms_and_conditions.htm and, for electronic format documents, subject to Terms and Conditions for Electronic Documents at www.sgs.com/terms_e-document.htm. Attention is drawn to the limitation of liability, indemnification and jurisdiction issues defined therein. Any holder of this document is advised that information contained hereon reflects the Company's findings at the time of its intervention only and within the limits of Client's instructions, if any. The Company's sole responsibility is to its Client and this document does not exonerate parties to a transaction from exercising all their rights and obligations under the transaction documents. This document cannot be reproduced except in full, without prior written approval of the Company. Any unauthorized alteration, forgery or falsification of the content or appearance of this document is unlawful and offenders may be prosecuted to the fullest extent of the law.

SGS Taiwan Ltd.

No.134,WuKungRoad,NewTaipeiIndustrialPark,WukuDistrict,NewTaipeiCity,Taiwan24803/新北市五股區新北產業園區五工路 134 號

台灣檢驗科技股份有限公司

t (886-2) 2299-3279

f (886-2) 2298-0488

www.tw.sgs.com

Member of SGS Group

EUT			Measurement					
Operation Band	Fundamental Frequency MHz	CH	Antenna Pol. V/H	S.G. Output dBm	Antenna Gain dBi	Cable Loss dB	EIRP dBm	Limit dBm
BAND 2 BW: 15M QPSK RB: 1,0	1857.5	18675	V	17.85	9.94	-4.46	23.33	33.01
			H	16.61	9.94	-4.46	22.09	33.01
	1880.0	18900	V	17.50	10.01	-4.50	23.01	33.01
			H	17.47	10.01	-4.50	22.98	33.01
	1902.5	19125	V	17.04	10.08	-4.53	22.58	33.01
			H	17.48	10.08	-4.53	23.03	33.01
BAND 2 BW: 15M QPSK RB: 1,74	1857.5	18675	V	18.06	9.98	-4.48	23.56	33.01
			H	17.15	9.98	-4.48	22.65	33.01
	1880.0	18900	V	17.39	10.05	-4.52	22.92	33.01
			H	17.35	10.05	-4.52	22.88	33.01
	1902.5	19125	V	15.31	10.12	-4.55	20.88	33.01
			H	15.77	10.12	-4.55	21.35	33.01
BAND 2 BW: 15M 16QAM RB: 1,0	1857.5	18675	V	17.87	9.94	-4.46	23.34	33.01
			H	16.09	9.94	-4.46	21.57	33.01
	1880.0	18900	V	16.83	10.01	-4.50	22.35	33.01
			H	17.03	10.01	-4.49	22.55	33.01
	1902.5	19125	V	16.33	10.08	-4.53	21.88	33.01
			H	16.85	10.08	-4.53	22.40	33.01
BAND 2 BW: 15M 16QAM RB: 1,74	1857.5	18675	V	18.04	9.98	-4.48	23.54	33.01
			H	16.56	9.98	-4.48	22.06	33.01
	1880.0	18900	V	16.75	10.05	-4.52	22.28	33.01
			H	16.64	10.05	-4.52	22.17	33.01
	1902.5	19125	V	14.87	10.12	-4.55	20.44	33.01
			H	15.44	10.12	-4.55	21.01	33.01

The RBW,VBW of SPA for frequency RBW= 8MHz , VBW= 8MHz

Unless otherwise stated the results shown in this test report refer only to the sample(s) tested and such sample(s) are retained for 90 days only.

除非另有說明，此報告結果僅對測試之樣品負責，同時此樣品僅保留90天。本報告未經本公司書面許可，不可部份複製。

This document is issued by the Company subject to its General Conditions of Service printed overleaf, available on request or accessible at www.sgs.com/terms_and_conditions.htm and, for electronic format documents, subject to Terms and Conditions for Electronic Documents at www.sgs.com/terms_e-document.htm. Attention is drawn to the limitation of liability, indemnification and jurisdiction issues defined therein. Any holder of this document is advised that information contained hereon reflects the Company's findings at the time of its intervention only and within the limits of Client's instructions, if any. The Company's sole responsibility is to its Client and this document does not exonerate parties to a transaction from exercising all their rights and obligations under the transaction documents. This document cannot be reproduced except in full, without prior written approval of the Company. Any unauthorized alteration, forgery or falsification of the content or appearance of this document is unlawful and offenders may be prosecuted to the fullest extent of the law.

SGS Taiwan Ltd.

No.134,WuKungRoad,NewTaipeiIndustrialPark,WukuDistrict,NewTaipeiCity,Taiwan24803/新北市五股區新北產業園區五工路 134 號

台灣檢驗科技股份有限公司

t (886-2) 2299-3279

f (886-2) 2298-0488

www.tw.sgs.com

Member of SGS Group

EUT			Measurement					
Operation Band	Fundamental Frequency MHz	CH	Antenna Pol. V/H	S.G. Output dBm	Antenna Gain dBi	Cable Loss dB	EIRP dBm	Limit dBm
BAND 2 BW: 20M QPSK RB: 1,0	1860.0	18700	V	17.78	9.95	-4.46	23.27	33.01
			H	16.43	9.95	-4.46	21.92	33.01
	1880.0	18900	V	17.60	10.00	-4.49	23.11	33.01
			H	17.24	10.00	-4.49	22.75	33.01
	1900.0	19100	V	16.92	10.07	-4.52	22.47	33.01
			H	17.31	10.07	-4.52	22.85	33.01
BAND 2 BW: 20M QPSK RB: 1,99	1860.0	18700	V	17.70	9.99	-4.49	23.21	33.01
			H	17.23	9.99	-4.49	22.74	33.01
	1880.0	18900	V	17.16	10.06	-4.52	22.70	33.01
			H	17.19	10.06	-4.52	22.72	33.01
	1900.0	19100	V	15.10	10.12	-4.55	20.67	33.01
			H	15.79	10.12	-4.55	21.37	33.01
BAND 2 BW: 20M 16QAM RB: 1,0	1860.0	18700	V	17.37	9.95	-4.46	22.86	33.01
			H	15.87	9.95	-4.46	21.35	33.01
	1880.0	18900	V	16.87	10.00	-4.49	22.38	33.01
			H	16.72	10.00	-4.49	22.23	33.01
	1900.0	19100	V	16.28	10.07	-4.52	21.82	33.01
			H	17.20	10.07	-4.52	22.74	33.01
BAND 2 BW: 20M 16QAM RB: 1,99	1860.0	18700	V	17.14	9.99	-4.49	22.64	33.01
			H	16.36	9.99	-4.49	21.87	33.01
	1880.0	18900	V	16.53	10.06	-4.52	22.06	33.01
			H	16.53	10.06	-4.52	22.07	33.01
	1900.0	19100	V	14.87	10.12	-4.55	20.44	33.01
			H	15.37	10.12	-4.55	20.95	33.01

The RBW,VBW of SPA for frequency RBW= 8MHz , VBW= 8MHz

Unless otherwise stated the results shown in this test report refer only to the sample(s) tested and such sample(s) are retained for 90 days only.

除非另有說明，此報告結果僅對測試之樣品負責，同時此樣品僅保留90天。本報告未經本公司書面許可，不可部份複製。

This document is issued by the Company subject to its General Conditions of Service printed overleaf, available on request or accessible at www.sgs.com/terms_and_conditions.htm and, for electronic format documents, subject to Terms and Conditions for Electronic Documents at www.sgs.com/terms_e-document.htm. Attention is drawn to the limitation of liability, indemnification and jurisdiction issues defined therein. Any holder of this document is advised that information contained hereon reflects the Company's findings at the time of its intervention only and within the limits of Client's instructions, if any. The Company's sole responsibility is to its Client and this document does not exonerate parties to a transaction from exercising all their rights and obligations under the transaction documents. This document cannot be reproduced except in full, without prior written approval of the Company. Any unauthorized alteration, forgery or falsification of the content or appearance of this document is unlawful and offenders may be prosecuted to the fullest extent of the law.

SGS Taiwan Ltd.

No.134,WuKungRoad,NewTaipeiIndustrialPark,WukuDistrict,NewTaipeiCity,Taiwan24803/新北市五股區新北產業園區五工路 134 號

台灣檢驗科技股份有限公司

t (886-2) 2299-3279

f (886-2) 2298-0488

www.tw.sgs.com

Member of SGS Group

8 OCCUPIED BANDWIDTH MEASUREMENT

8.1 Standard Applicable

The occupied bandwidth is the frequency bandwidth such that, below its lower and above its upper frequency limits, the mean powers radiated are each equal to 0.5 percent of the total mean power.

8.2 Test Set-up

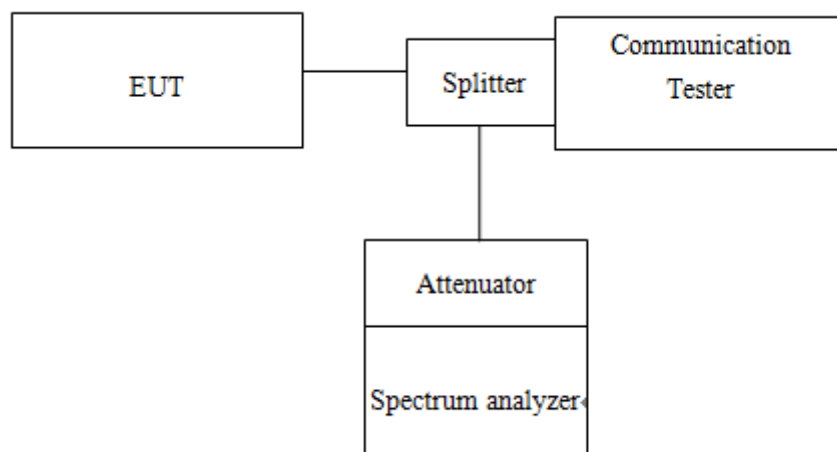

8.3 Measurement Procedure

99% & 26dB Bandwidth with detector peak

The EUT's output RF connector was connected with a short cable to the spectrum analyzer, RBW was set to about 1% of emission BW, VBW= 3 times RBW, -26dBc display line was placed on the screen (or 26dB bandwidth), the occupied bandwidth is the delta frequency between the two points where the display line intersects the signal trace. Then set RBW to 99% bandwidth, RBW= 1%, VBW= 3 RBW, with span > 2 * Signal BW, set % Power = 99%.

Unless otherwise stated the results shown in this test report refer only to the sample(s) tested and such sample(s) are retained for 90 days only.

除非另有說明，此報告結果僅對測試之樣品負責，同時此樣品僅保留90天。本報告未經本公司書面許可，不可部份複製。

This document is issued by the Company subject to its General Conditions of Service printed overleaf, available on request or accessible at www.sgs.com/terms_and_conditions.htm and, for electronic format documents, subject to Terms and Conditions for Electronic Documents at www.sgs.com/terms_e-document.htm. Attention is drawn to the limitation of liability, indemnification and jurisdiction issues defined therein. Any holder of this document is advised that information contained hereon reflects the Company's findings at the time of its intervention only and within the limits of Client's instructions, if any. The Company's sole responsibility is to its Client and this document does not exonerate parties to a transaction from exercising all their rights and obligations under the transaction documents. This document cannot be reproduced except in full, without prior written approval of the Company. Any unauthorized alteration, forgery or falsification of the content or appearance of this document is unlawful and offenders may be prosecuted to the fullest extent of the law.

8.4 Measurement Equipment Used

Conducted Emission (measured at antenna port) Test Site					
EQUIPMENT TYPE	MFR	MODEL NUMBER	SERIAL NUMBER	LAST CAL.	CAL DUE.
Power Meter	Anritsu	ML2495A	1005007	12/15/2016	12/14/2017
Power Sensor	Anritsu	MA2411B	917032	12/15/2016	12/14/2017
EXA Spectrum Analyzer	Agilent	N9030A	MY53120760	03/21/2017	03/20/2018
DC Block	Mini-Circuits	BLK-18-S+	1	01/05/2017	01/04/2018
Coaxial Cable	HU-BER+SUHNER	SUCOFLEX 102	23670/2	01/05/2017	01/04/2018
Attenuator	Mini-Circuit	BW-S10W2+	2	01/05/2017	01/04/2018
Splitter	Agilent	11636B	N/A	01/05/2017	01/04/2018
DC Power Supply	Agilent	E3640A	MY52410006	11/21/2016	11/20/2017
Temperature Chamber	TERCHY	MHG-120LF	911009	05/19/2017	05/18/2018
Radio Communication Analyzer	R&S	CMU200	102189	02/11/2017	02/10/2018
Radio Communication Analyzer	Anritsu	MT8820C	6201465317	01/03/2017	01/02/2018

Unless otherwise stated the results shown in this test report refer only to the sample(s) tested and such sample(s) are retained for 90 days only.

除非另有說明，此報告結果僅對測試之樣品負責，同時此樣品僅保留90天。本報告未經本公司書面許可，不可部份複製。

This document is issued by the Company subject to its General Conditions of Service printed overleaf, available on request or accessible at www.sgs.com/terms_and_conditions.htm and, for electronic format documents, subject to Terms and Conditions for Electronic Documents at www.sgs.com/terms_e-document.htm. Attention is drawn to the limitation of liability, indemnification and jurisdiction issues defined therein. Any holder of this document is advised that information contained hereon reflects the Company's findings at the time of its intervention only and within the limits of Client's instructions, if any. The Company's sole responsibility is to its Client and this document does not exonerate parties to a transaction from exercising all their rights and obligations under the transaction documents. This document cannot be reproduced except in full, without prior written approval of the Company. Any unauthorized alteration, forgery or falsification of the content or appearance of this document is unlawful and offenders may be prosecuted to the fullest extent of the law.

SGS Taiwan Ltd.

No. 134, WuKungRoad, NewTaipeiIndustrialPark, WukuDistrict, New Taipei City, Taiwan 24803/新北市五股區新北產業園區五工路 134 號

台灣檢驗科技股份有限公司

t (886-2) 2299-3279

f (886-2) 2298-0488

www.tw.sgs.com

Member of SGS Group

8.5 Measurement Result

Freq. (MHz)	CH	99% BW (MHz)	99% BW (MHz)	26 dB BW (MHz)	26 dB BW (MHz)
		GSM 1900	GPRS 1900	GSM 1900	GPRS 1900
1850.2	512	0.24539	0.24489	0.3032	0.3165
1880.0	661	0.24213	0.24443	0.3065	0.3192
1909.8	810	0.24485	0.24515	0.3099	0.3162

Freq. (MHz)	CH	99% BW (MHz)	99% BW (MHz)	99% BW (MHz)	26 dB BW (MHz)	26 dB BW (MHz)	26 dB BW (MHz)
		WCDMA II	HSDPA II	HSUPA II	WCDMA II	HSDPA II	HSUPA II
1850.20	9262	4.1230	4.1261	4.1245	4.6820	4.6620	4.6880
1880.00	9400	4.1188	4.1081	4.1198	4.6760	6.6830	4.6600
1909.80	9538	4.1224	4.1227	4.1136	4.6820	4.6830	4.6640

Unless otherwise stated the results shown in this test report refer only to the sample(s) tested and such sample(s) are retained for 90 days only.

除非另有說明，此報告結果僅對測試之樣品負責，同時此樣品僅保留90天。本報告未經本公司書面許可，不可部份複製。

This document is issued by the Company subject to its General Conditions of Service printed overleaf, available on request or accessible at www.sgs.com/terms_and_conditions.htm and, for electronic format documents, subject to Terms and Conditions for Electronic Documents at www.sgs.com/terms_e-document.htm. Attention is drawn to the limitation of liability, indemnification and jurisdiction issues defined therein. Any holder of this document is advised that information contained hereon reflects the Company's findings at the time of its intervention only and within the limits of Client's instructions, if any. The Company's sole responsibility is to its Client and this document does not exonerate parties to a transaction from exercising all their rights and obligations under the transaction documents. This document cannot be reproduced except in full, without prior written approval of the Company. Any unauthorized alteration, forgery or falsification of the content or appearance of this document is unlawful and offenders may be prosecuted to the fullest extent of the law.

LTE BAND 2 Channel bandwidth: 1.4MHz					
Freq. (MHz)	CH	99% BW (MHz)	99% BW (MHz)	26 dB BW (MHz)	26 dB BW (MHz)
		QPSK	16QAM	QPSK	16QAM
1850.7	18607	1.0979	1.1013	1.2900	1.3228
1880.0	18900	1.0976	1.1006	1.2859	1.2994
1909.3	19193	1.0982	1.0995	1.2864	1.3000

LTE BAND 2 Channel bandwidth: 3MHz					
Freq. (MHz)	CH	99% BW (MHz)	99% BW (MHz)	26 dB BW (MHz)	26 dB BW (MHz)
		QPSK	16QAM	QPSK	16QAM
1851.5	18615	2.6986	2.7032	2.9910	3.0030
1880.0	18900	2.7004	2.7023	2.9847	3.0007
1908.5	19185	2.6994	2.6975	3.0053	2.9955

LTE BAND 2 Channel bandwidth: 5MHz					
Freq. (MHz)	CH	99% BW (MHz)	99% BW (MHz)	26 dB BW (MHz)	26 dB BW (MHz)
		QPSK	16QAM	QPSK	16QAM
1852.5	18625	4.5042	4.5061	5.0329	5.0177
1880.0	18900	4.5040	4.5071	5.0209	4.9912
1907.5	19175	4.5019	4.5078	5.0247	5.0459

LTE BAND 2 Channel bandwidth: 10MHz					
Freq. (MHz)	CH	99% BW (MHz)	99% BW (MHz)	26 dB BW (MHz)	26 dB BW (MHz)
		QPSK	16QAM	QPSK	16QAM
1855.0	18650	9.0046	8.9455	9.8866	9.7837
1880.0	18900	8.9883	8.9453	9.8834	9.8175
1905.0	19150	8.9957	8.9304	9.8911	9.7941

LTE BAND 2 Channel bandwidth: 15MHz					
Freq. (MHz)	CH	99% BW (MHz)	99% BW (MHz)	26 dB BW (MHz)	26 dB BW (MHz)
		QPSK	16QAM	QPSK	16QAM
1857.5	18675	13.4530	13.4360	14.6780	14.7380
1880.0	18900	13.4410	13.4270	14.6050	14.7090
1902.5	19125	13.4160	13.4220	14.6520	14.6820

LTE BAND 2 Channel bandwidth: 20MHz					
Freq. (MHz)	CH	99% BW (MHz)	99% BW (MHz)	26 dB BW (MHz)	26 dB BW (MHz)
		QPSK	16QAM	QPSK	16QAM
1860.0	18700	17.8780	17.9350	19.4000	19.4100
1880.0	18900	17.8920	17.8690	19.4280	19.3880
1900.0	19100	17.8730	17.9270	19.3890	19.4420

Unless otherwise stated the results shown in this test report refer only to the sample(s) tested and such sample(s) are retained for 90 days only.

除非另有說明，此報告結果僅對測試之樣品負責，同時此樣品僅保留90天。本報告未經本公司書面許可，不可部份複製。

This document is issued by the Company subject to its General Conditions of Service printed overleaf, available on request or accessible at www.sgs.com/terms_and_conditions.htm and, for electronic format documents, subject to Terms and Conditions for Electronic Documents at www.sgs.com/terms_e-document.htm. Attention is drawn to the limitation of liability, indemnification and jurisdiction issues defined therein. Any holder of this document is advised that information contained hereon reflects the Company's findings at the time of its intervention only and within the limits of Client's instructions, if any. The Company's sole responsibility is to its Client and this document does not exonerate parties to a transaction from exercising all their rights and obligations under the transaction documents. This document cannot be reproduced except in full, without prior written approval of the Company. Any unauthorized alteration, forgery or falsification of the content or appearance of this document is unlawful and offenders may be prosecuted to the fullest extent of the law.

GSM_1900MHz_LowCH512-1850.2

GPRS_1900MHz_LowCH512-1850.2

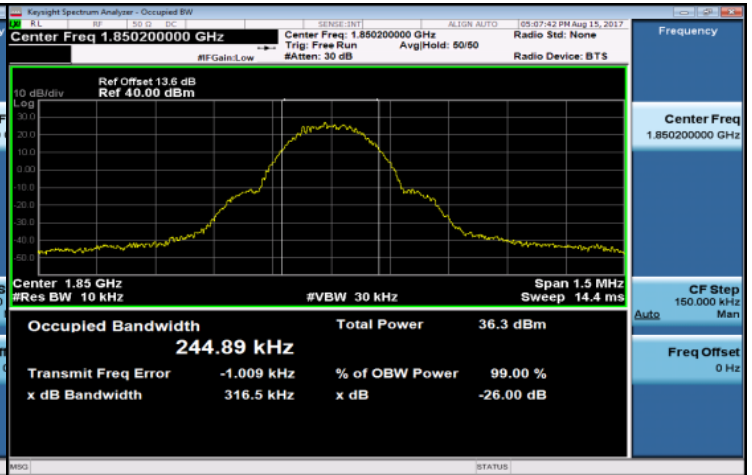
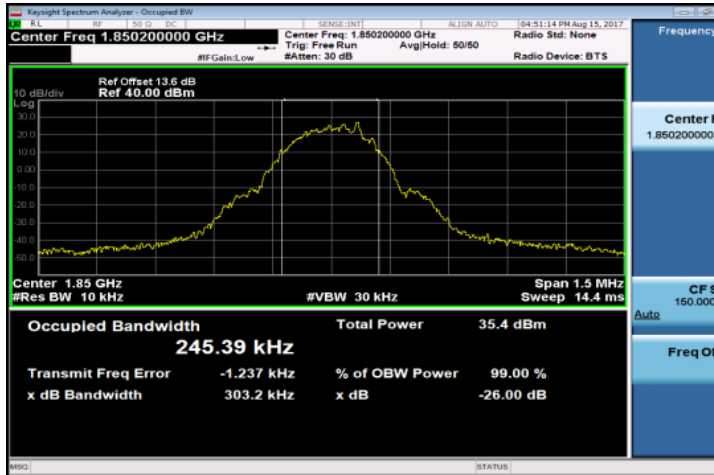

GSM_1900MHz_MidCH661-1880

GPRS_1900MHz_MidCH661-1880

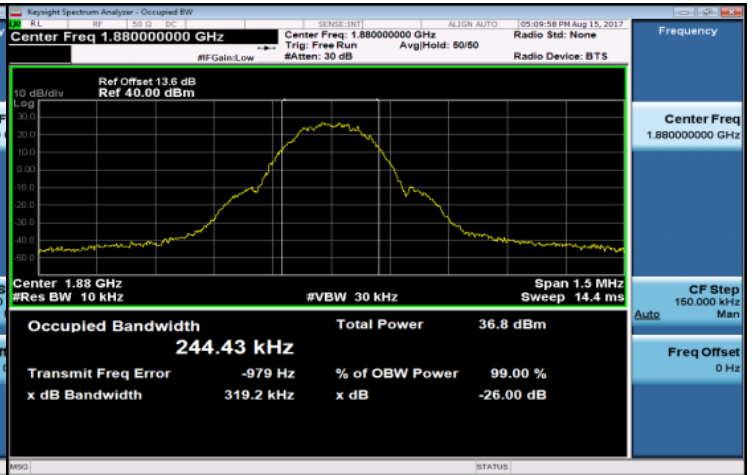
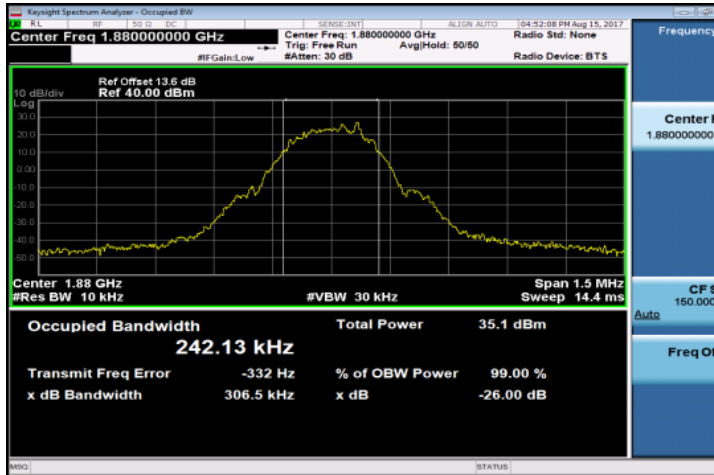

GPRS_1900MHz_HighCH810-1909.8

GPRS_1900MHz_HighCH810-1909.8

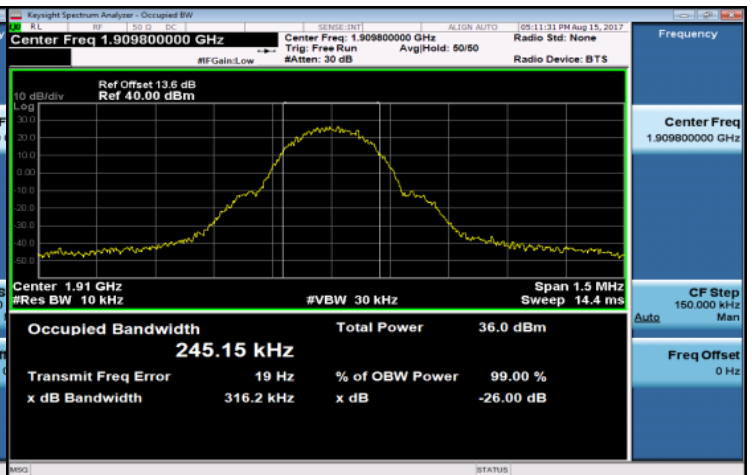
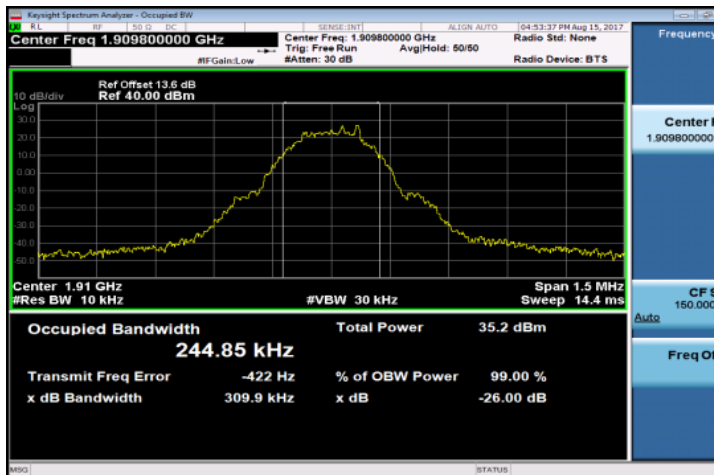

Unless otherwise stated the results shown in this test report refer only to the sample(s) tested and such sample(s) are retained for 90 days only.

除非另有說明，此報告結果僅對測試之樣品負責，同時此樣品僅保留90天。本報告未經本公司書面許可，不可部份複製。

This document is issued by the Company subject to its General Conditions of Service printed overleaf, available on request or accessible at www.sgs.com/terms_and_conditions.htm and, for electronic format documents, subject to Terms and Conditions for Electronic Documents at www.sgs.com/terms_e-document.htm. Attention is drawn to the limitation of liability, indemnification and jurisdiction issues defined therein. Any holder of this document is advised that information contained hereon reflects the Company's findings at the time of its intervention only and within the limits of Client's instructions, if any. The Company's sole responsibility is to its Client and this document does not exonerate parties to a transaction from exercising all their rights and obligations under the transaction documents. This document cannot be reproduced except in full, without prior written approval of the Company. Any unauthorized alteration, forgery or falsification of the content or appearance of this document is unlawful and offenders may be prosecuted to the fullest extent of the law.

SGS Taiwan Ltd.

No. 134, Wukung Road, New Taipei Industrial Park, Wuku District, New Taipei City, Taiwan 24803/新北市五股區新北產業園區五工路 134 號

台灣檢驗科技股份有限公司

t (886-2) 2299-3279

f (886-2) 2298-0488

www.tw.sgs.com

Member of SGS Group

WCDMA_B2_LowCH9262-1852.4

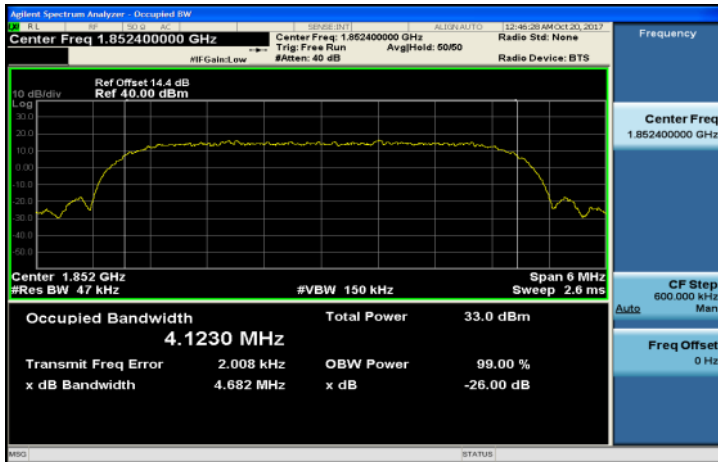

HSDPA_B2_LowCH9262-1852.4

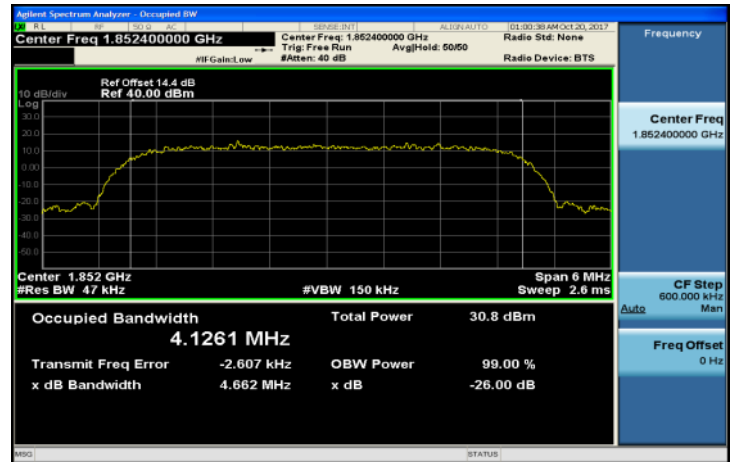

WCDMA_B2_MidCH9400-1880

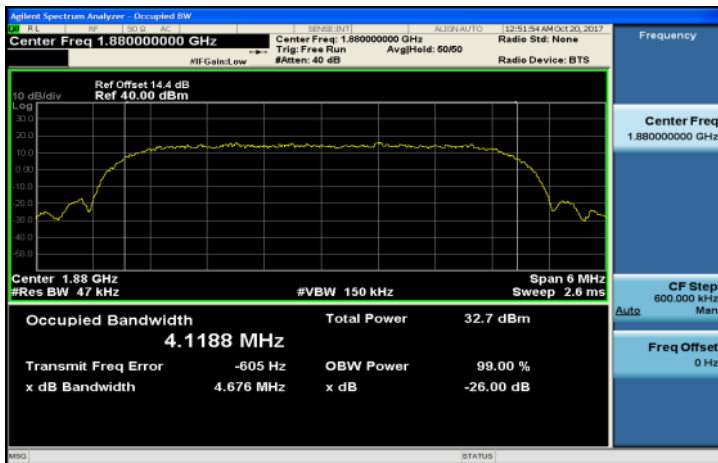

HSDPA_B2_MidCH9400-1880

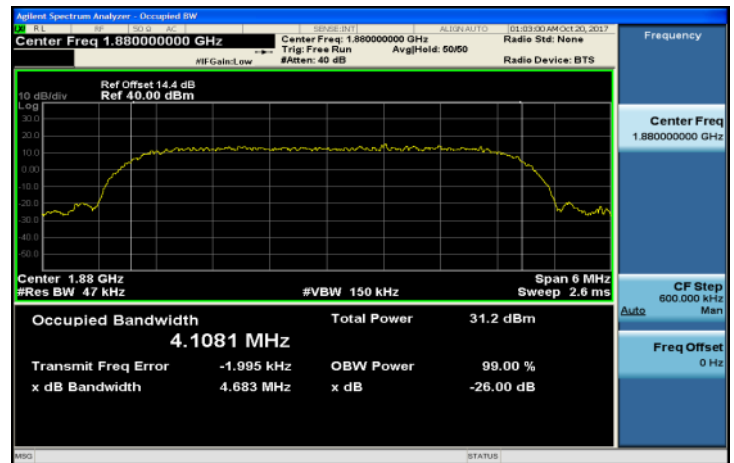

WCDMA_B2_HighCH9538-1907.6

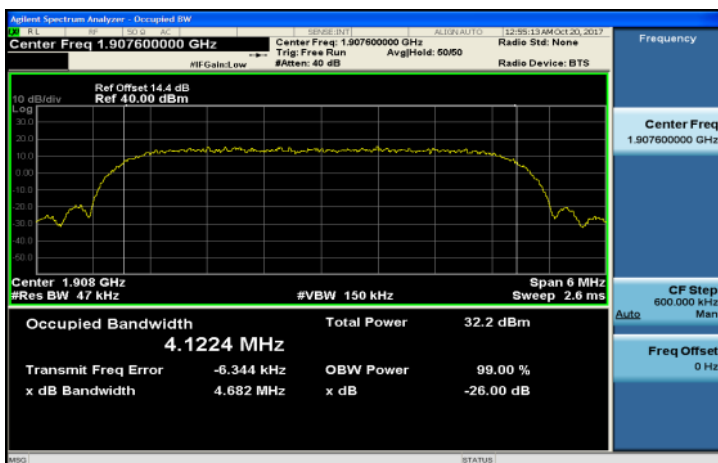

HSDPA_B2_HighCH9538-1907.6

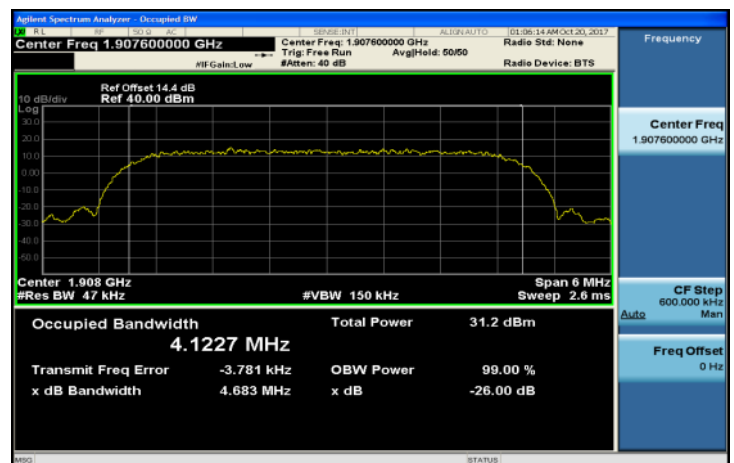

Unless otherwise stated the results shown in this test report refer only to the sample(s) tested and such sample(s) are retained for 90 days only.

除非另有說明，此報告結果僅對測試之樣品負責，同時此樣品僅保留90天。本報告未經本公司書面許可，不可部份複製。

This document is issued by the Company subject to its General Conditions of Service printed overleaf, available on request or accessible at www.sgs.com/terms_and_conditions.htm and, for electronic format documents, subject to Terms and Conditions for Electronic Documents at www.sgs.com/terms_e-document.htm. Attention is drawn to the limitation of liability, indemnification and jurisdiction issues defined therein. Any holder of this document is advised that information contained hereon reflects the Company's findings at the time of its intervention only and within the limits of Client's instructions, if any. The Company's sole responsibility is to its Client and this document does not exonerate parties to a transaction from exercising all their rights and obligations under the transaction documents. This document cannot be reproduced except in full, without prior written approval of the Company. Any unauthorized alteration, forgery or falsification of the content or appearance of this document is unlawful and offenders may be prosecuted to the fullest extent of the law.

SGS Taiwan Ltd.

No. 134, WuKungRoad, NewTaipeiIndustrialPark, WukuDistrict, NewTaipeiCity, Taiwan24803/新北市五股區新北產業園區五工路 134 號

台灣檢驗科技股份有限公司

t (886-2) 2299-3279

f (886-2) 2298-0488

www.tw.sgs.com

Member of SGS Group

HSUPA_B2_LowCH9262-1852.4

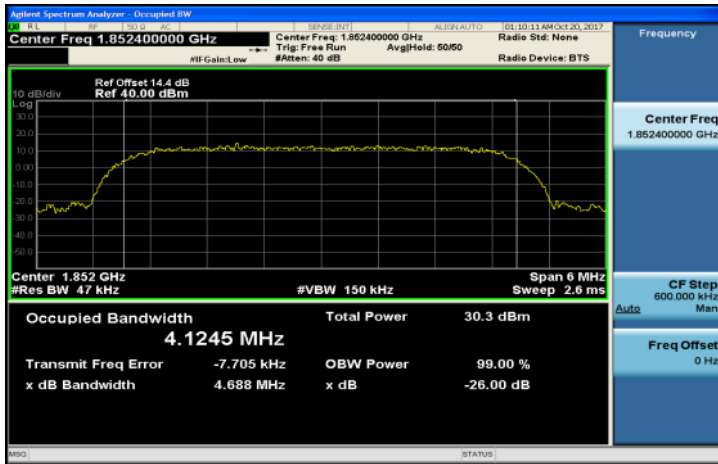

Band2_1_4MHz_QPSK_6_0_LowCH18607-1850.7

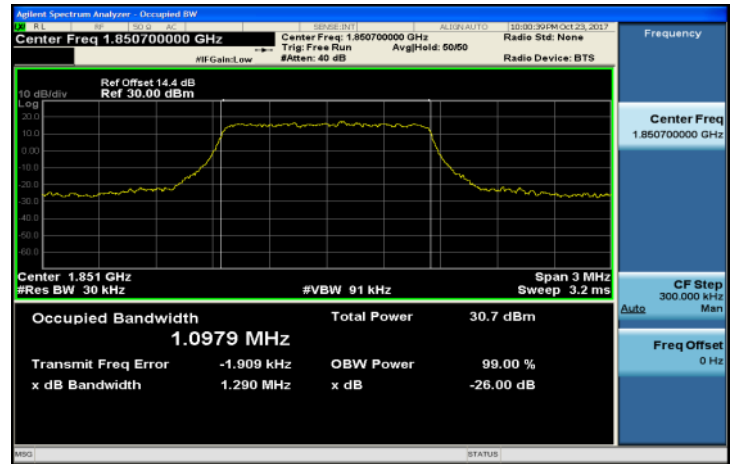

HSUPA_B2_MidCH9400-1880

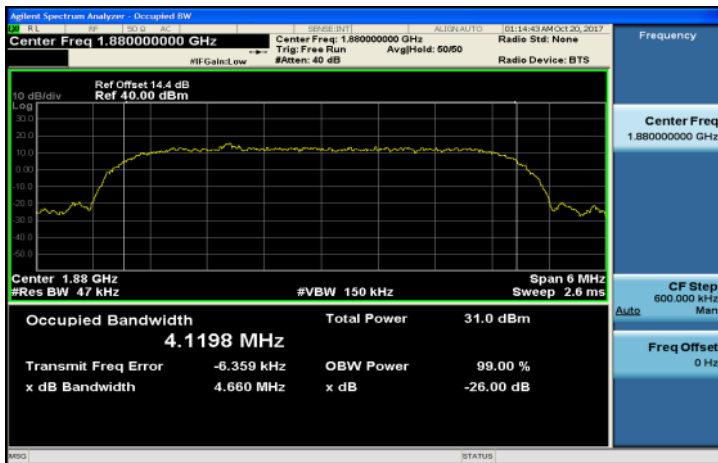

Band2_1_4MHz_QPSK_6_0_MidCH18900-1880

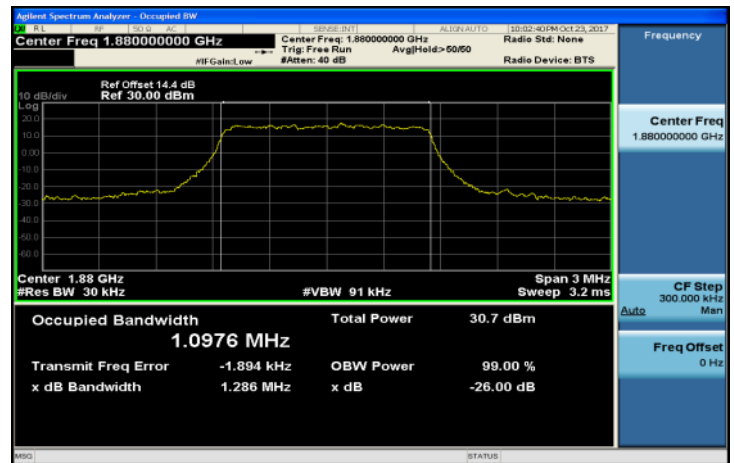

HSUPA_B2_HighCH9538-1907.6

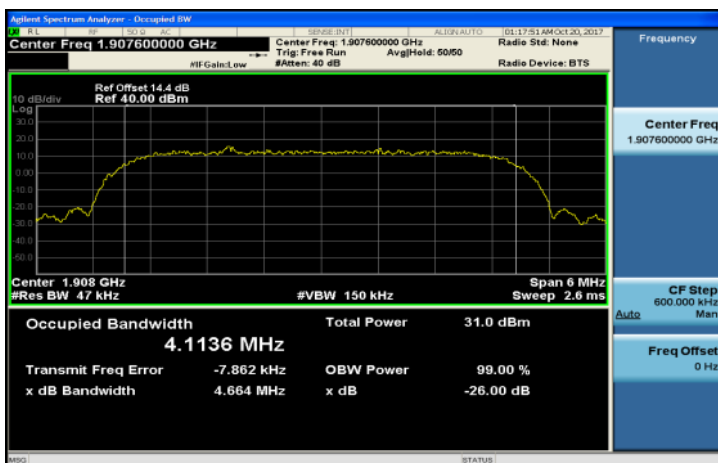

Band2_1_4MHz_QPSK_6_0_HighCH19193-1909.3

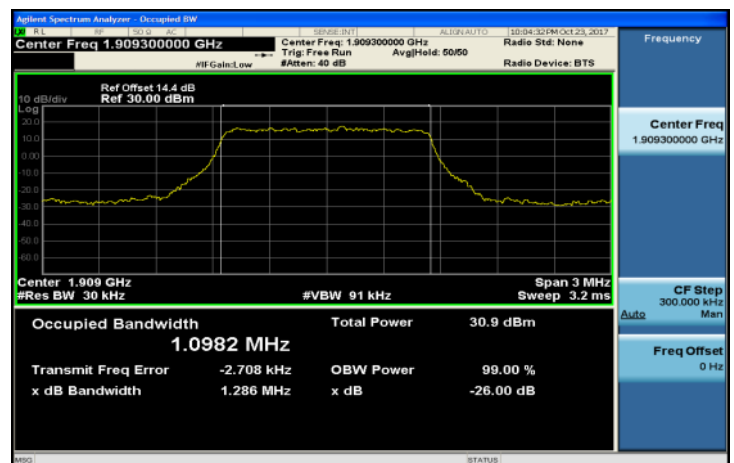

Unless otherwise stated the results shown in this test report refer only to the sample(s) tested and such sample(s) are retained for 90 days only.

除非另有說明，此報告結果僅對測試之樣品負責，同時此樣品僅保留90天。本報告未經本公司書面許可，不可部份複製。

This document is issued by the Company subject to its General Conditions of Service printed overleaf, available on request or accessible at www.sgs.com/terms_and_conditions.htm and, for electronic format documents, subject to Terms and Conditions for Electronic Documents at www.sgs.com/terms_e-document.htm. Attention is drawn to the limitation of liability, indemnification and jurisdiction issues defined therein. Any holder of this document is advised that information contained hereon reflects the Company's findings at the time of its intervention only and within the limits of Client's instructions, if any. The Company's sole responsibility is to its Client and this document does not exonerate parties to a transaction from exercising all their rights and obligations under the transaction documents. This document cannot be reproduced except in full, without prior written approval of the Company. Any unauthorized alteration, forgery or falsification of the content or appearance of this document is unlawful and offenders may be prosecuted to the fullest extent of the law.

SGS Taiwan Ltd.

No. 134, WuKungRoad, NewTaipeiIndustrialPark, WukuDistrict, NewTaipeiCity, Taiwan24803/新北市五股區新北產業園區五工路 134 號

台灣檢驗科技股份有限公司

t (886-2) 2299-3279

f (886-2) 2298-0488

www.tw.sgs.com

Member of SGS Group

Band2_1_4MHz_16QAM_6_0_LowCH18607-1850.7

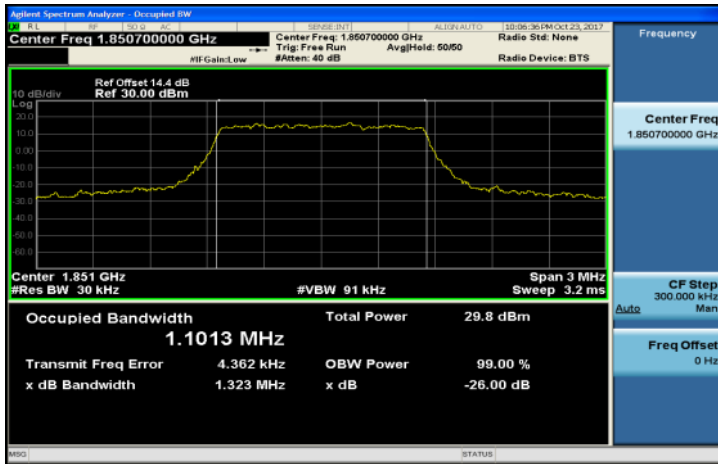

Band2_3MHz_QPSK_15_0_LowCH18615-1851.5

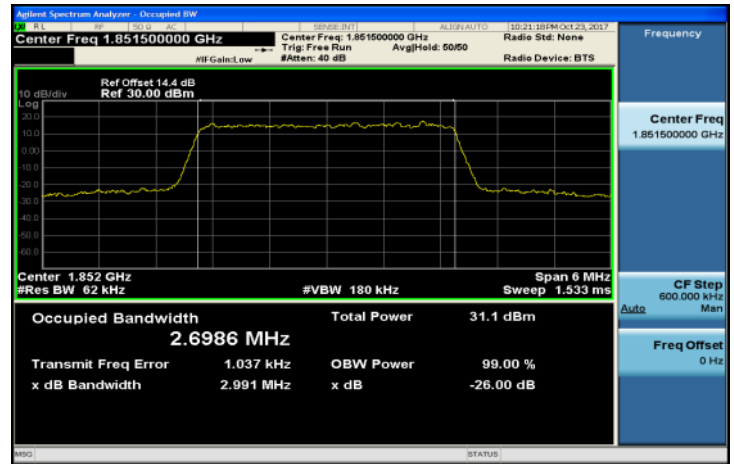

Band2_1_4MHz_16QAM_6_0_MidCH18900-1880

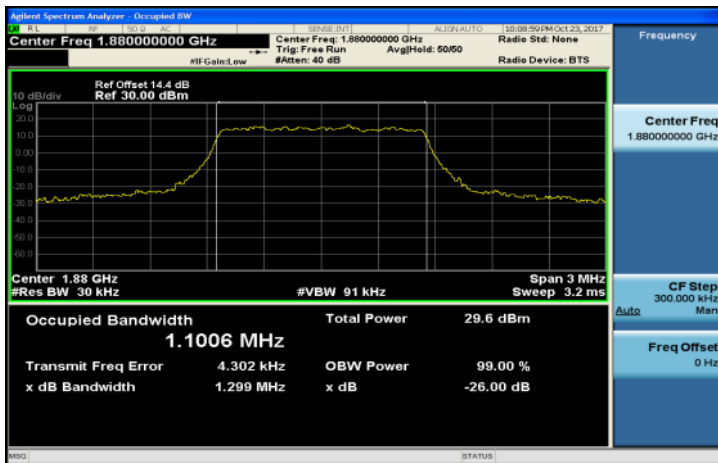

Band2_3MHz_QPSK_15_0_MidCH18900-1880

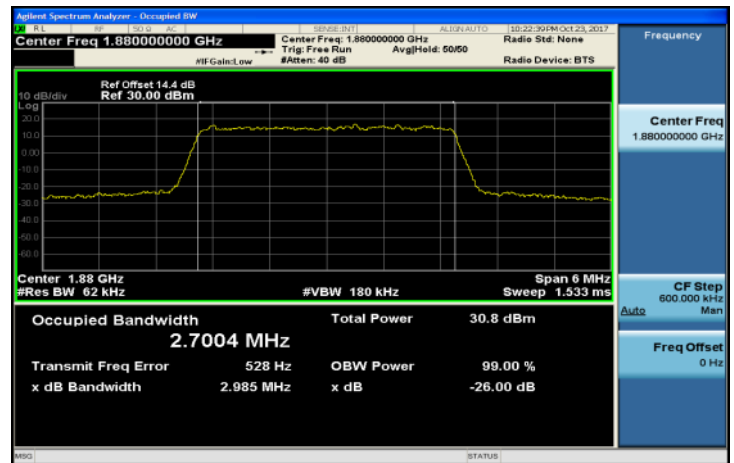

Band2_1_4MHz_16QAM_6_0_HighCH19193-1909.3

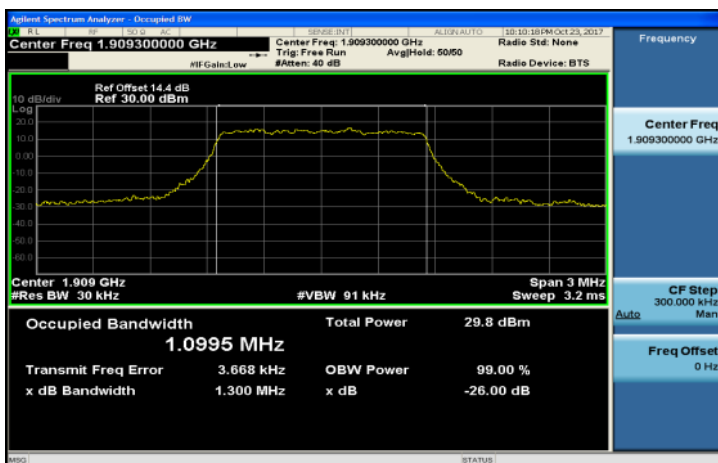

Band2_3MHz_QPSK_15_0_HighCH19185-1908.5

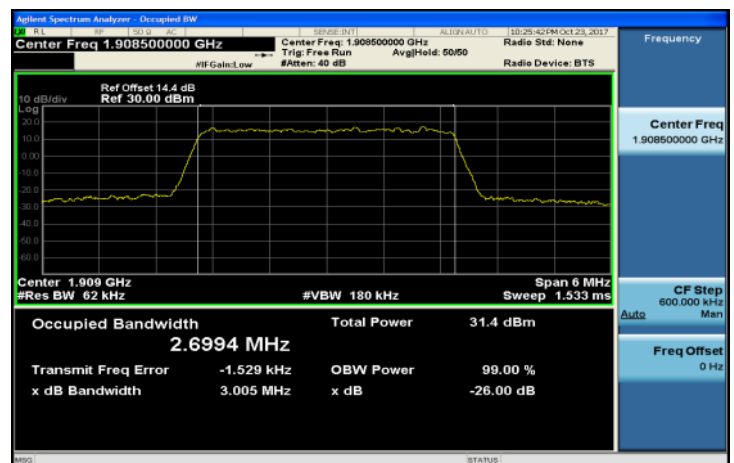

Unless otherwise stated the results shown in this test report refer only to the sample(s) tested and such sample(s) are retained for 90 days only.

除非另有說明，此報告結果僅對測試之樣品負責，同時此樣品僅保留90天。本報告未經本公司書面許可，不可部份複製。

This document is issued by the Company subject to its General Conditions of Service printed overleaf, available on request or accessible at www.sgs.com/terms_and_conditions.htm and, for electronic format documents, subject to Terms and Conditions for Electronic Documents at www.sgs.com/terms_e-document.htm. Attention is drawn to the limitation of liability, indemnification and jurisdiction issues defined therein. Any holder of this document is advised that information contained hereon reflects the Company's findings at the time of its intervention only and within the limits of Client's instructions, if any. The Company's sole responsibility is to its Client and this document does not exonerate parties to a transaction from exercising all their rights and obligations under the transaction documents. This document cannot be reproduced except in full, without prior written approval of the Company. Any unauthorized alteration, forgery or falsification of the content or appearance of this document is unlawful and offenders may be prosecuted to the fullest extent of the law.

SGS Taiwan Ltd.

No. 134, WuKungRoad, NewTaipeiIndustrialPark, WuKuDistrict, NewTaipeiCity, Taiwan24803/新北市五股區新北產業園區五工路 134 號

台灣檢驗科技股份有限公司

t (886-2) 2299-3279

f (886-2) 2298-0488

www.tw.sgs.com

Member of SGS Group

Band2_3MHz_16QAM_15_0_LowCH18615-1851.5

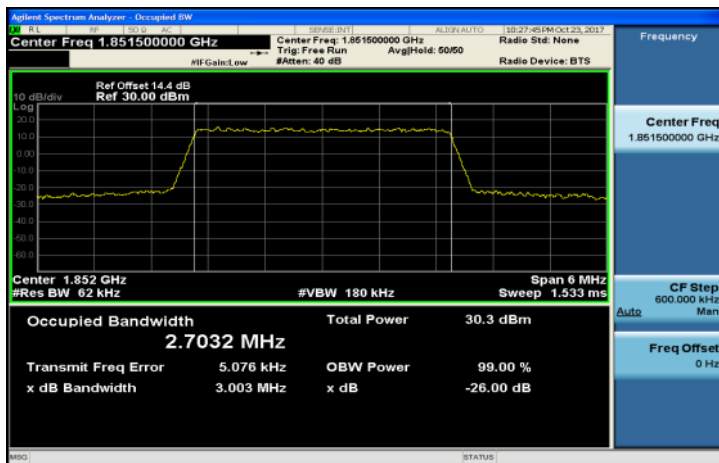

Band2_5MHz_QPSK_25_0_LowCH18625-1852.5

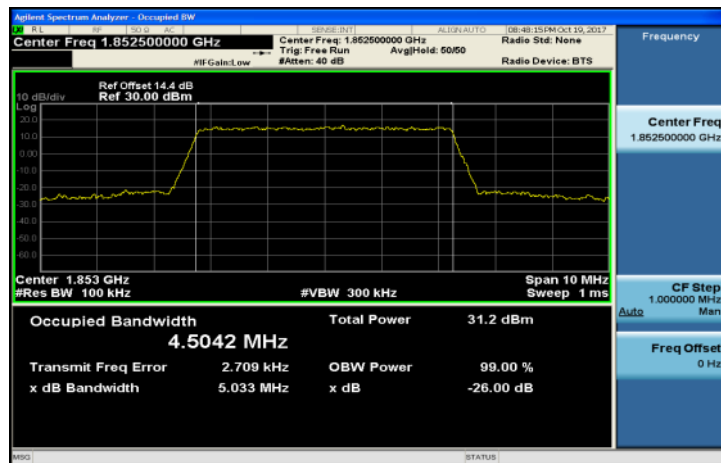

Band2_3MHz_16QAM_15_0_MidCH18900-1880

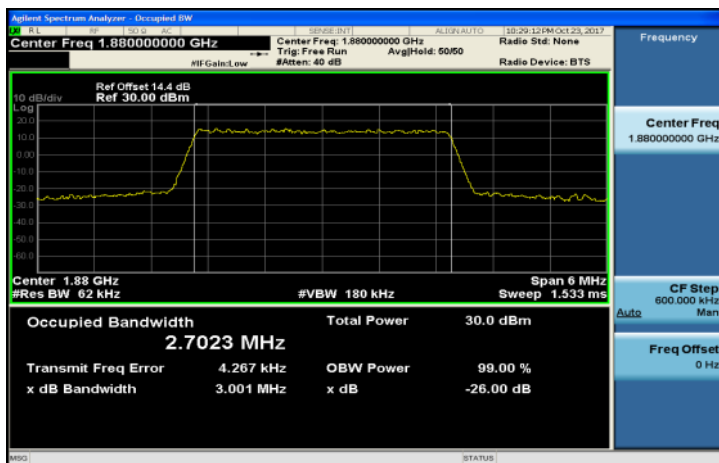

Band2_5MHz_QPSK_25_0_MidCH18900-1880

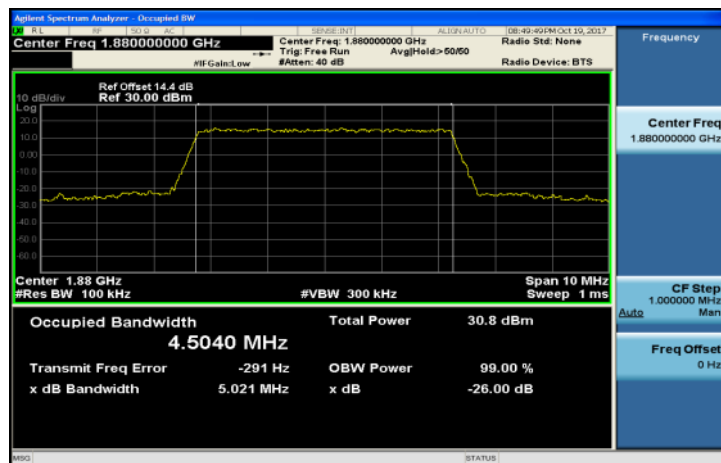

Band2_3MHz_16QAM_15_0_HighCH19185-1908.5

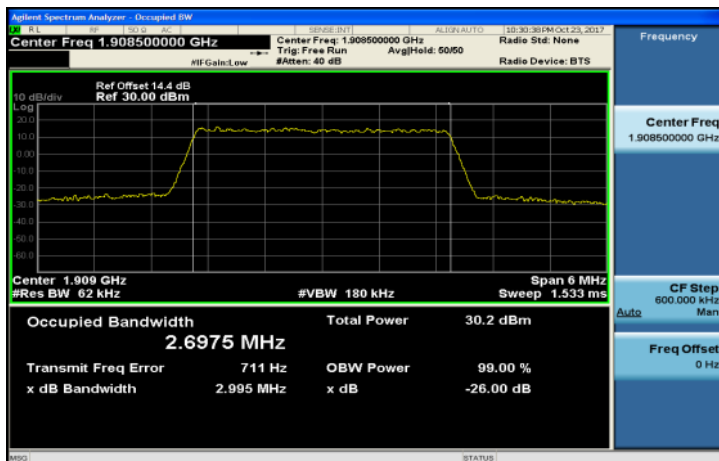

Band2_5MHz_QPSK_25_0_HighCH19175-1907.5

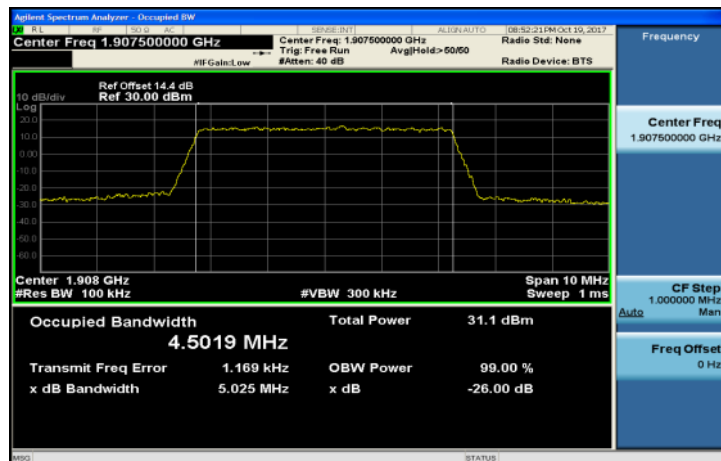

Unless otherwise stated the results shown in this test report refer only to the sample(s) tested and such sample(s) are retained for 90 days only.

除非另有說明，此報告結果僅對測試之樣品負責，同時此樣品僅保留90天。本報告未經本公司書面許可，不可部份複製。

This document is issued by the Company subject to its General Conditions of Service printed overleaf, available on request or accessible at www.sgs.com/terms_and_conditions.htm and, for electronic format documents, subject to Terms and Conditions for Electronic Documents at www.sgs.com/terms_e-document.htm. Attention is drawn to the limitation of liability, indemnification and jurisdiction issues defined therein. Any holder of this document is advised that information contained herein reflects the Company's findings at the time of its intervention only and within the limits of Client's instructions, if any. The Company's sole responsibility is to its Client and this document does not exonerate parties to a transaction from exercising all their rights and obligations under the transaction documents. This document cannot be reproduced except in full, without prior written approval of the Company. Any unauthorized alteration, forgery or falsification of the content or appearance of this document is unlawful and offenders may be prosecuted to the fullest extent of the law.

SGS Taiwan Ltd.

No. 134, WuKung Road, New Taipei Industrial Park, WuKung District, New Taipei City, Taiwan 24803 / 新北市五股區新北產業園區五工路 134 號

台灣檢驗科技股份有限公司

t (886-2) 2299-3279

f (886-2) 2298-0488

www.tw.sgs.com

Member of SGS Group

Band2_5MHz_16QAM_25_0_LowCH18625-1852.5

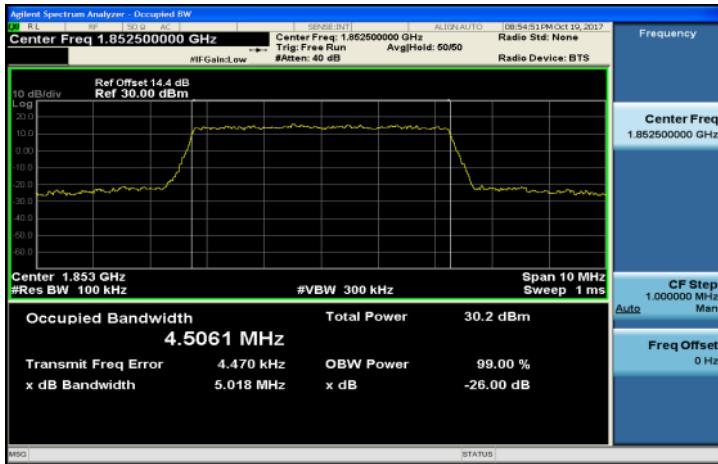

Band2_10MHz_QPSK_50_0_LowCH18650-1855

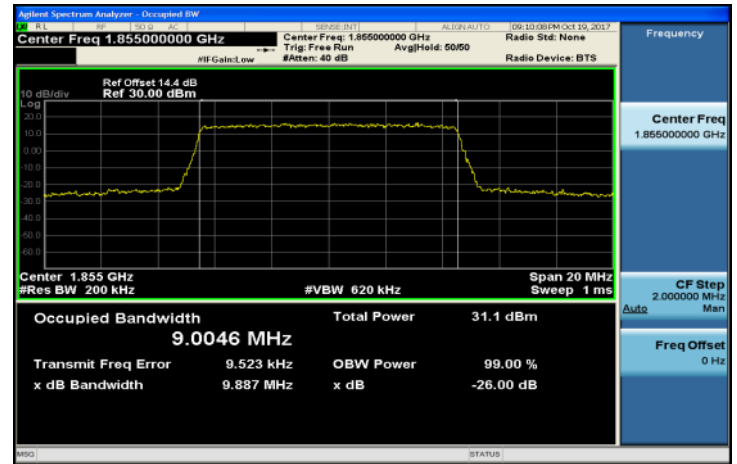

Band2_5MHz_16QAM_25_0_MidCH18900-1880

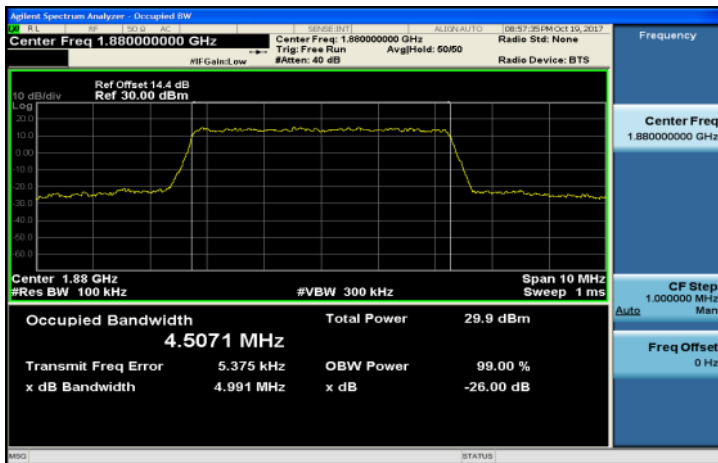

Band2_10MHz_QPSK_50_0_MidCH18900-1880

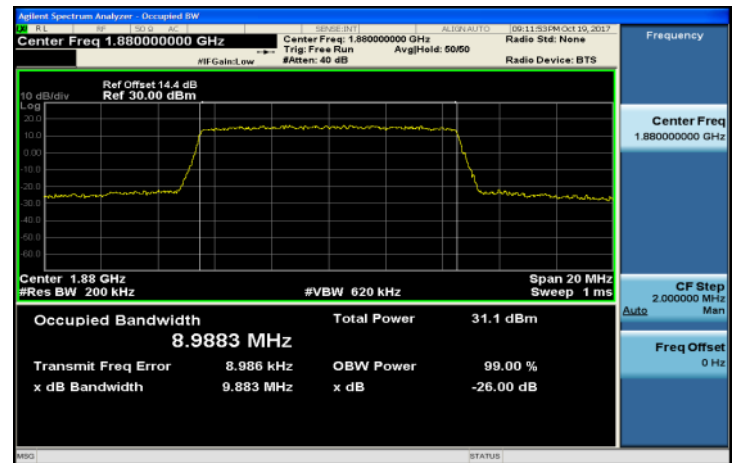

Band2_5MHz_16QAM_25_0_HighCH19175-1907.5

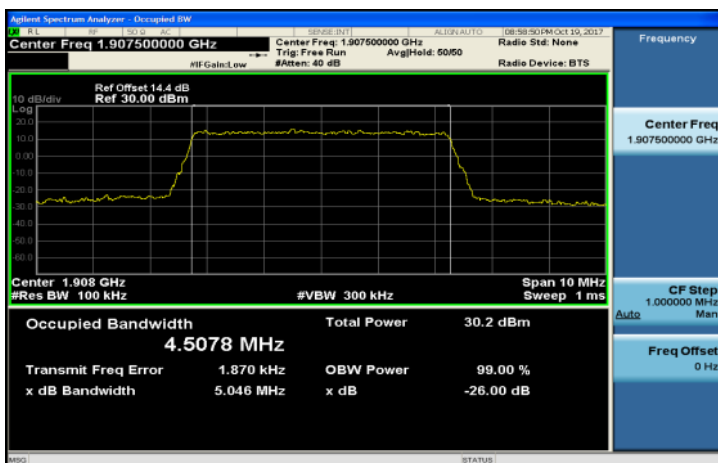

Band2_10MHz_QPSK_50_0_HighCH19150-1905

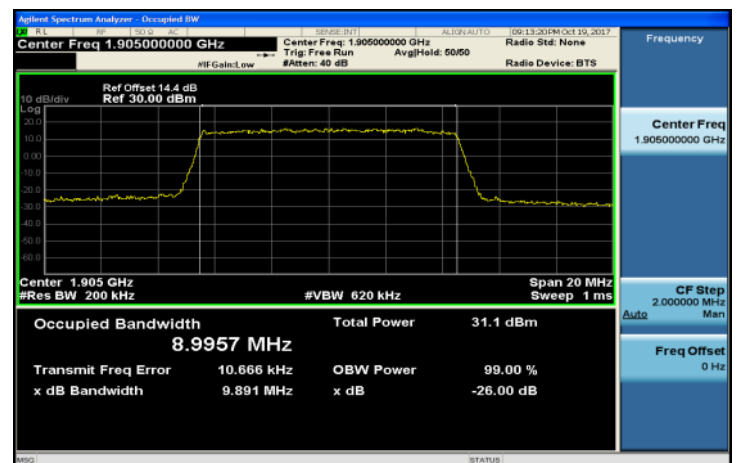

Unless otherwise stated the results shown in this test report refer only to the sample(s) tested and such sample(s) are retained for 90 days only.

除非另有說明，此報告結果僅對測試之樣品負責，同時此樣品僅保留90天。本報告未經本公司書面許可，不可部份複製。

This document is issued by the Company subject to its General Conditions of Service printed overleaf, available on request or accessible at www.sgs.com/terms_and_conditions.htm and, for electronic format documents, subject to Terms and Conditions for Electronic Documents at www.sgs.com/terms_e-document.htm. Attention is drawn to the limitation of liability, indemnification and jurisdiction issues defined therein. Any holder of this document is advised that information contained hereon reflects the Company's findings at the time of its intervention only and within the limits of Client's instructions, if any. The Company's sole responsibility is to its Client and this document does not exonerate parties to a transaction from exercising all their rights and obligations under the transaction documents. This document cannot be reproduced except in full, without prior written approval of the Company. Any unauthorized alteration, forgery or falsification of the content or appearance of this document is unlawful and offenders may be prosecuted to the fullest extent of the law.

SGS Taiwan Ltd.

No. 134, WuKungRoad, NewTaipeiIndustrialPark, WuKuDistrict, NewTaipeiCity, Taiwan24803/新北市五股區新北產業園區五工路 134 號

台灣檢驗科技股份有限公司

t (886-2) 2299-3279

f (886-2) 2298-0488

www.tw.sgs.com

Member of SGS Group

Band2_10MHz_16QAM_50_0_LowCH18650-1855

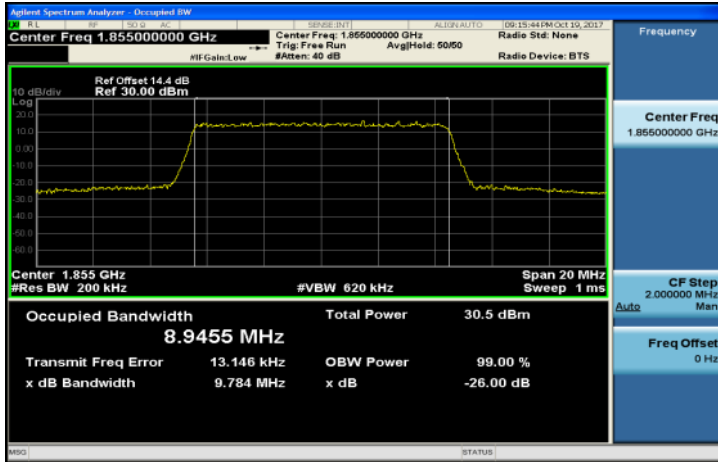

Band2_15MHz_QPSK_75_0_LowCH18675-1857.5

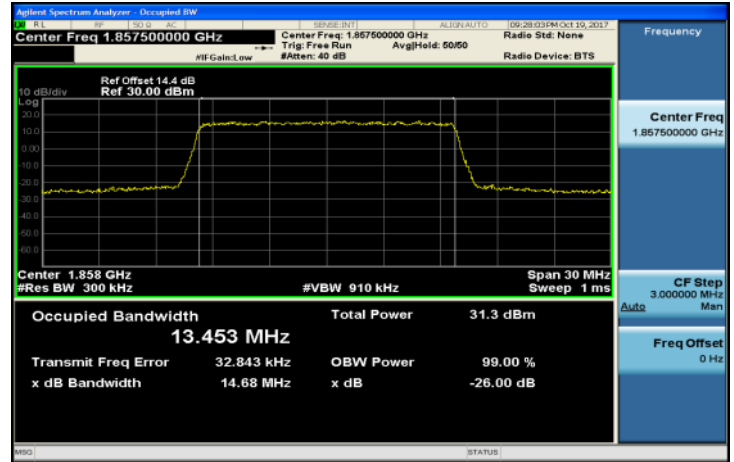

Band2_10MHz_16QAM_50_0_MidCH18900-1880

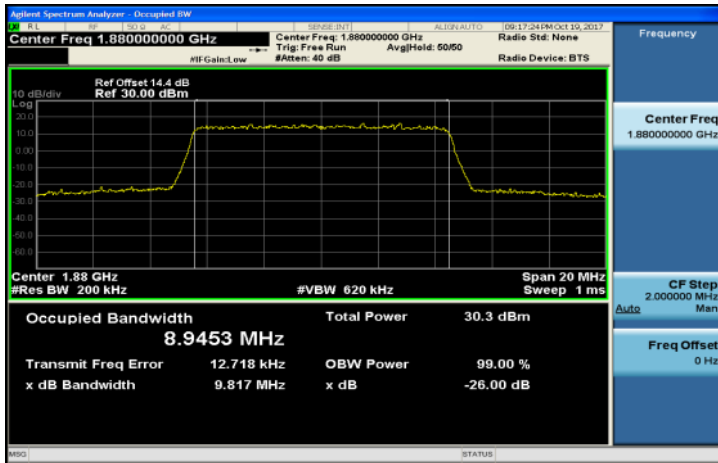

Band2_15MHz_QPSK_75_0_MidCH18900-1880

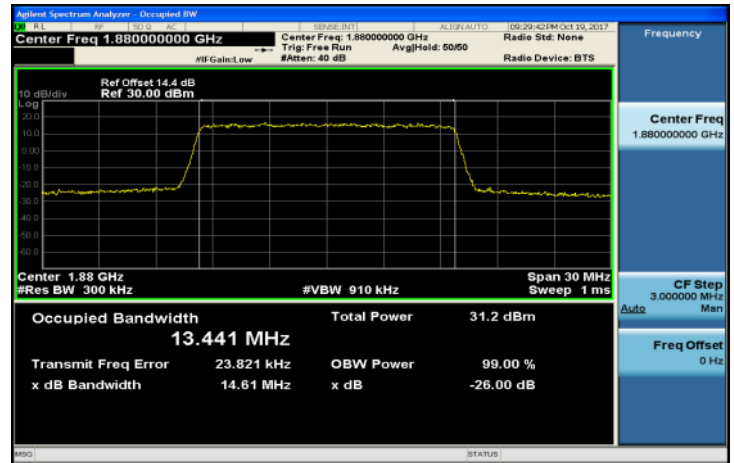

Band2_10MHz_16QAM_50_0_HighCH19150-1905

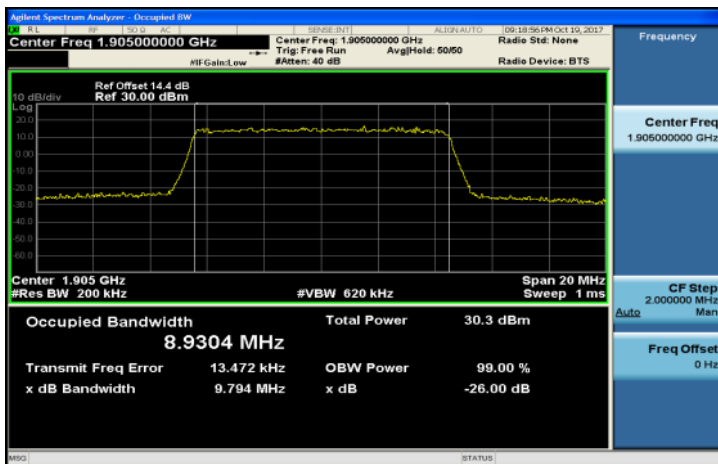

Band2_15MHz_QPSK_75_0_HighCH19125-1902.5

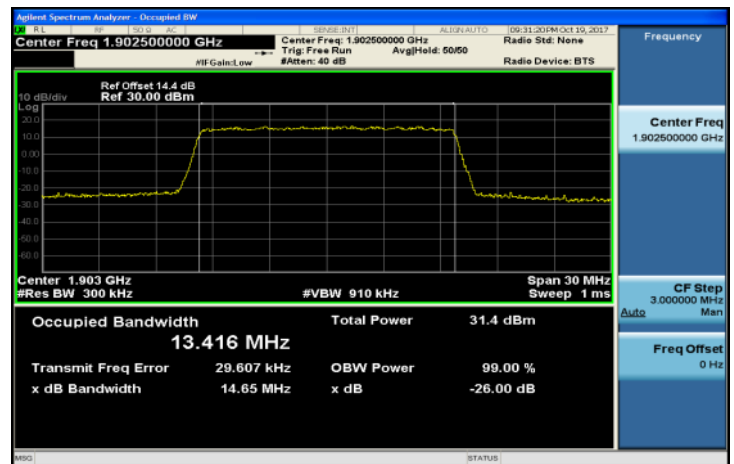

Unless otherwise stated the results shown in this test report refer only to the sample(s) tested and such sample(s) are retained for 90 days only.

除非另有說明，此報告結果僅對測試之樣品負責，同時此樣品僅保留90天。本報告未經本公司書面許可，不可部份複製。

This document is issued by the Company subject to its General Conditions of Service printed overleaf, available on request or accessible at www.sgs.com/terms_and_conditions.htm and, for electronic format documents, subject to Terms and Conditions for Electronic Documents at www.sgs.com/terms_e-document.htm. Attention is drawn to the limitation of liability, indemnification and jurisdiction issues defined therein. Any holder of this document is advised that information contained hereon reflects the Company's findings at the time of its intervention only and within the limits of Client's instructions, if any. The Company's sole responsibility is to its Client and this document does not exonerate parties to a transaction from exercising all their rights and obligations under the transaction documents. This document cannot be reproduced except in full, without prior written approval of the Company. Any unauthorized alteration, forgery or falsification of the content or appearance of this document is unlawful and offenders may be prosecuted to the fullest extent of the law.

Band2_15MHz_16QAM_75_0_LowCH18675-1857.5

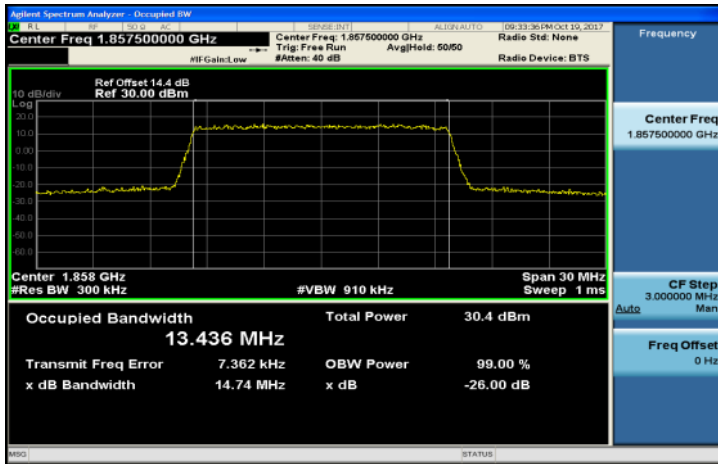

Band2_20MHz_QPSK_100_0_LowCH18700-1860

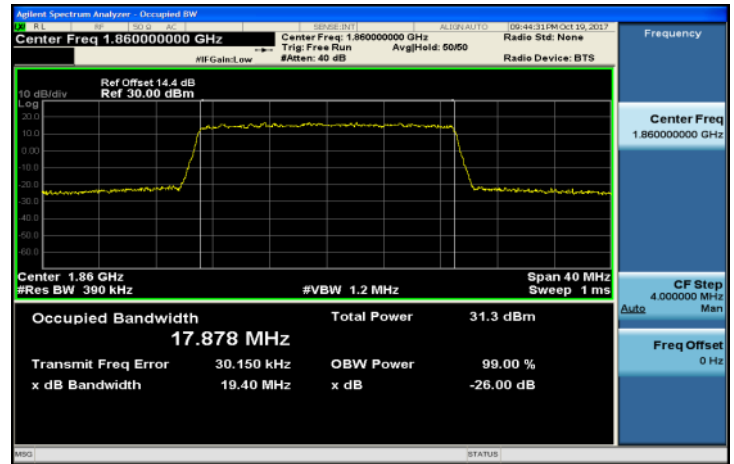

Band2_15MHz_16QAM_75_0_MidCH18900-1880

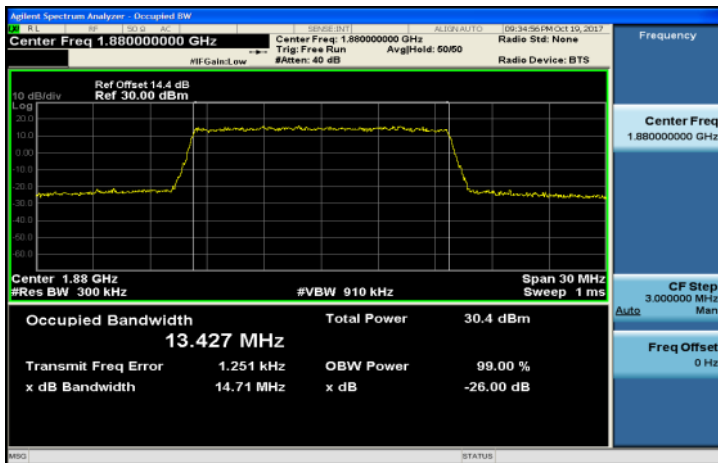

Band2_20MHz_QPSK_100_0_MidCH18900-1880

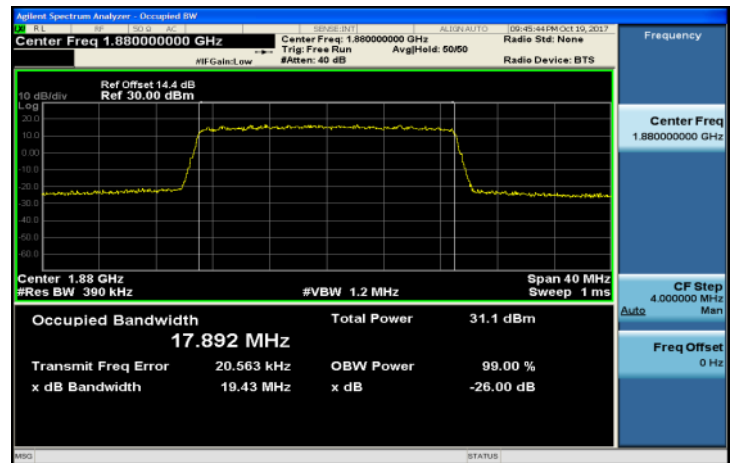

Band2_15MHz_16QAM_75_0_HighCH19125-1902.5

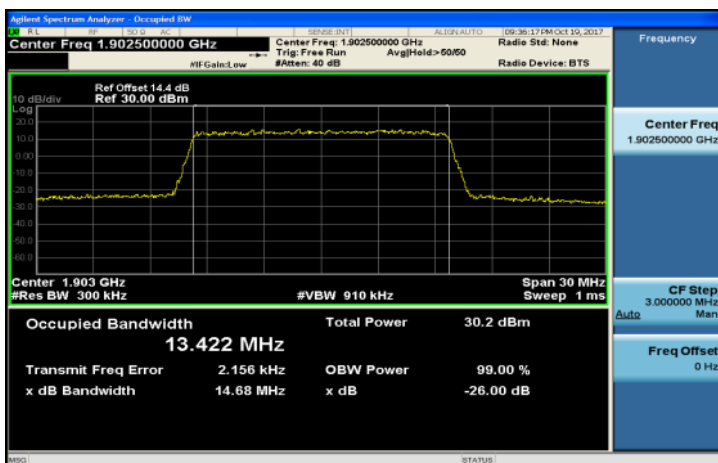

Band2_20MHz_QPSK_100_0_HighCH19100-1900

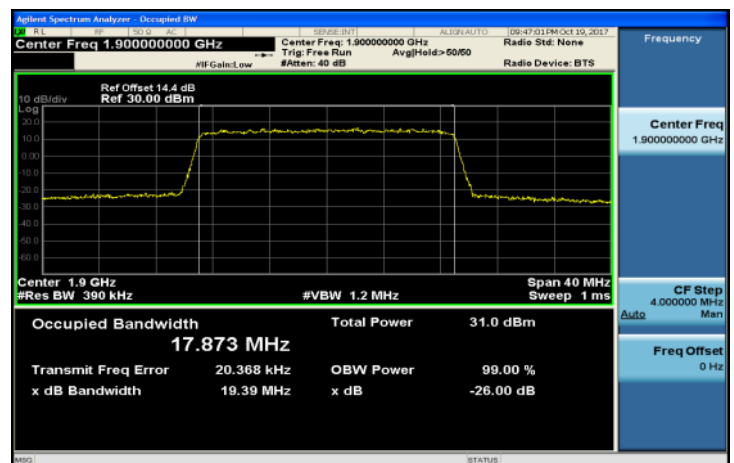

Unless otherwise stated the results shown in this test report refer only to the sample(s) tested and such sample(s) are retained for 90 days only.

除非另有說明，此報告結果僅對測試之樣品負責，同時此樣品僅保留90天。本報告未經本公司書面許可，不可部份複製。

This document is issued by the Company subject to its General Conditions of Service printed overleaf, available on request or accessible at www.sgs.com/terms_and_conditions.htm and, for electronic format documents, subject to Terms and Conditions for Electronic Documents at www.sgs.com/terms_e-document.htm. Attention is drawn to the limitation of liability, indemnification and jurisdiction issues defined therein. Any holder of this document is advised that information contained hereon reflects the Company's findings at the time of its intervention only and within the limits of Client's instructions, if any. The Company's sole responsibility is to its Client and this document does not exonerate parties to a transaction from exercising all their rights and obligations under the transaction documents. This document cannot be reproduced except in full, without prior written approval of the Company. Any unauthorized alteration, forgery or falsification of the content or appearance of this document is unlawful and offenders may be prosecuted to the fullest extent of the law.

Band2_20MHz_16QAM_100_0_LowCH18700-1860

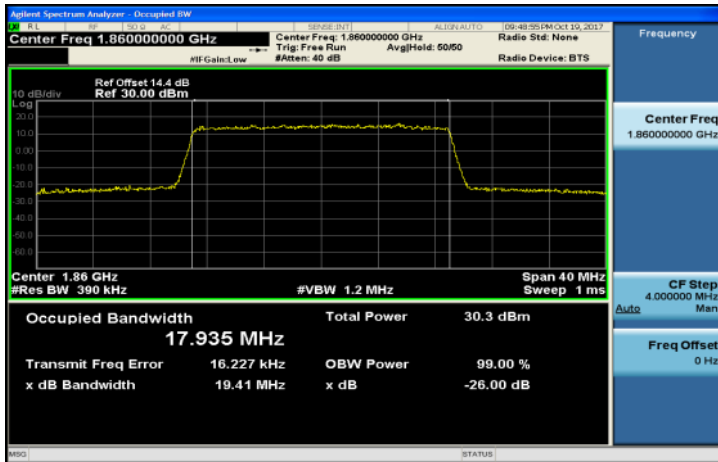

Band2_20MHz_16QAM_100_0_MidCH18900-1880

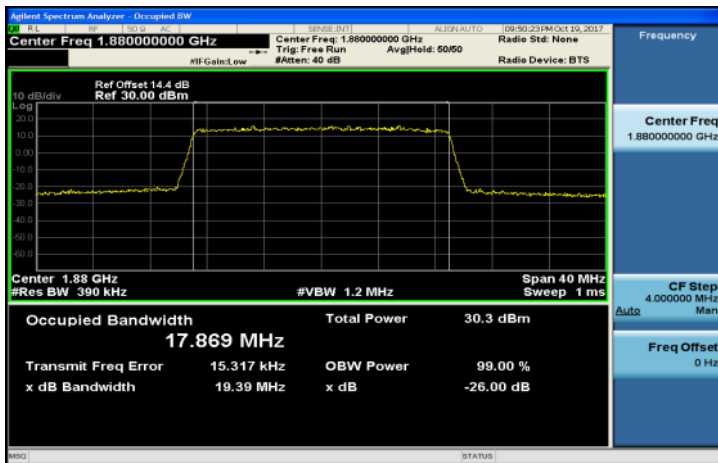

Band2_20MHz_16QAM_100_0_HighCH19100-1900

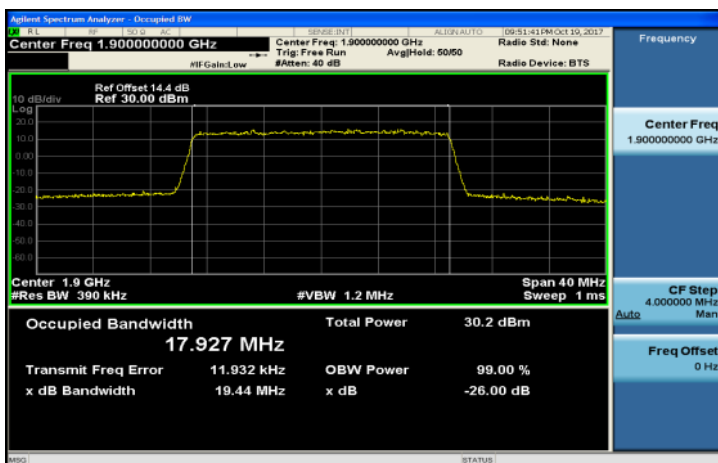

Unless otherwise stated the results shown in this test report refer only to the sample(s) tested and such sample(s) are retained for 90 days only.

除非另有說明，此報告結果僅對測試之樣品負責，同時此樣品僅保留90天。本報告未經本公司書面許可，不可部份複製。

This document is issued by the Company subject to its General Conditions of Service printed overleaf, available on request or accessible at www.sgs.com/terms_and_conditions.htm and, for electronic format documents, subject to Terms and Conditions for Electronic Documents at www.sgs.com/terms_e-document.htm. Attention is drawn to the limitation of liability, indemnification and jurisdiction issues defined therein. Any holder of this document is advised that information contained hereon reflects the Company's findings at the time of its intervention only and within the limits of Client's instructions, if any. The Company's sole responsibility is to its Client and this document does not exonerate parties to a transaction from exercising all their rights and obligations under the transaction documents. This document cannot be reproduced except in full, without prior written approval of the Company. Any unauthorized alteration, forgery or falsification of the content or appearance of this document is unlawful and offenders may be prosecuted to the fullest extent of the law.

9 OUT OF BAND EMISSION AT ANTENNA TERMINALS

9.1 Standard Applicable

FCC §24.238(a), *Out of band emissions*. The power of any emission outside of the authorized operating frequency ranges must be attenuated below the transmitting power (P) by a factor of at least $43 + 10 \log(P)$ dB.

9.2 Test SET-UP

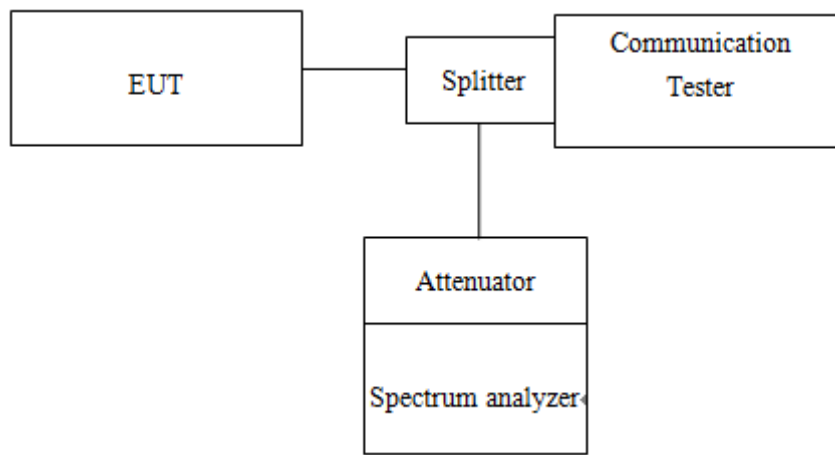

9.3 Measurement Procedure

Conducted Emission

The RF output of the transceiver was connected to a spectrum analyzer through appropriate attenuation. The resolution bandwidth of the spectrum analyzer was set at 1MHz, sufficient scans were taken to show the out of band Emissions if any up to 10th harmonic.

1. To connect Antenna Port of EUT to Spectrum.
2. Set RBW = 1MHz & VBW = 1MHz on Spectrum.
3. Allow trace to fully stabilize
4. Repeat above procedures until all default test channel measured were complete.

Band Edge

1. To connect Antenna Port of EUT to Spectrum.
2. The band edge of low and high channels for the highest RF powers was measured. Setting $RBW \geq 1\% EBW$.
3. Allow trace to fully stabilize
4. Repeat above procedures until all default test channel measured were complete.

Unless otherwise stated the results shown in this test report refer only to the sample(s) tested and such sample(s) are retained for 90 days only.

除非另有說明，此報告結果僅對測試之樣品負責，同時此樣品僅保留90天。本報告未經本公司書面許可，不可部份複製。

This document is issued by the Company subject to its General Conditions of Service printed overleaf, available on request or accessible at www.sgs.com/terms_and_conditions.htm and, for electronic format documents, subject to Terms and Conditions for Electronic Documents at www.sgs.com/terms_e-document.htm. Attention is drawn to the limitation of liability, indemnification and jurisdiction issues defined therein. Any holder of this document is advised that information contained hereon reflects the Company's findings at the time of its intervention only and within the limits of Client's instructions, if any. The Company's sole responsibility is to its Client and this document does not exonerate parties to a transaction from exercising all their rights and obligations under the transaction documents. This document cannot be reproduced except in full, without prior written approval of the Company. Any unauthorized alteration, forgery or falsification of the content or appearance of this document is unlawful and offenders may be prosecuted to the fullest extent of the law.

9.4 Measurement Equipment Used

Conducted Emission (measured at antenna port) Test Site					
EQUIPMENT TYPE	MFR	MODEL NUMBER	SERIAL NUMBER	LAST CAL.	CAL DUE.
Power Meter	Anritsu	ML2495A	1005007	12/15/2016	12/14/2017
Power Sensor	Anritsu	MA2411B	917032	12/15/2016	12/14/2017
EXA Spectrum Analyzer	Agilent	N9030A	MY53120760	03/21/2017	03/20/2018
DC Block	Mini-Circuits	BLK-18-S+	1	01/05/2017	01/04/2018
Coaxial Cable	HU-BER+SUHNER	SUCOFLEX 102	23670/2	01/05/2017	01/04/2018
Attenuator	Mini-Circuit	BW-S10W2+	2	01/05/2017	01/04/2018
Splitter	Agilent	11636B	N/A	01/05/2017	01/04/2018
DC Power Supply	Agilent	E3640A	MY52410006	11/21/2016	11/20/2017
Temperature Chamber	TERCHY	MHG-120LF	911009	05/19/2017	05/18/2018
Radio Communication Analyzer	R&S	CMU200	102189	02/11/2017	02/10/2018
Radio Communication Analyzer	Anritsu	MT8820C	6201465317	01/03/2017	01/02/2018

9.5 Measurement Result:

Refer to next pages.

NOTE: The occurrence of the spike on the conducted emission is the signal of the fundamental emission.

Unless otherwise stated the results shown in this test report refer only to the sample(s) tested and such sample(s) are retained for 90 days only.

除非另有說明，此報告結果僅對測試之樣品負責，同時此樣品僅保留90天。本報告未經本公司書面許可，不可部份複製。

This document is issued by the Company subject to its General Conditions of Service printed overleaf, available on request or accessible at www.sgs.com/terms_and_conditions.htm and, for electronic format documents, subject to Terms and Conditions for Electronic Documents at www.sgs.com/terms_e-document.htm. Attention is drawn to the limitation of liability, indemnification and jurisdiction issues defined therein. Any holder of this document is advised that information contained hereon reflects the Company's findings at the time of its intervention only and within the limits of Client's instructions, if any. The Company's sole responsibility is to its Client and this document does not exonerate parties to a transaction from exercising all their rights and obligations under the transaction documents. This document cannot be reproduced except in full, without prior written approval of the Company. Any unauthorized alteration, forgery or falsification of the content or appearance of this document is unlawful and offenders may be prosecuted to the fullest extent of the law.

SGS Taiwan Ltd.

No. 134, WuKungRoad, NewTaipeiIndustrialPark, WukuDistrict, New TaipeiCity, Taiwan24803/新北市五股區新北產業園區五工路 134 號

台灣檢驗科技股份有限公司

t (886-2) 2299-3279

f (886-2) 2298-0488

www.tw.sgs.com

Member of SGS Group

30MHz~3GHz_GSM_1900MHz_LowCH512-1850.2

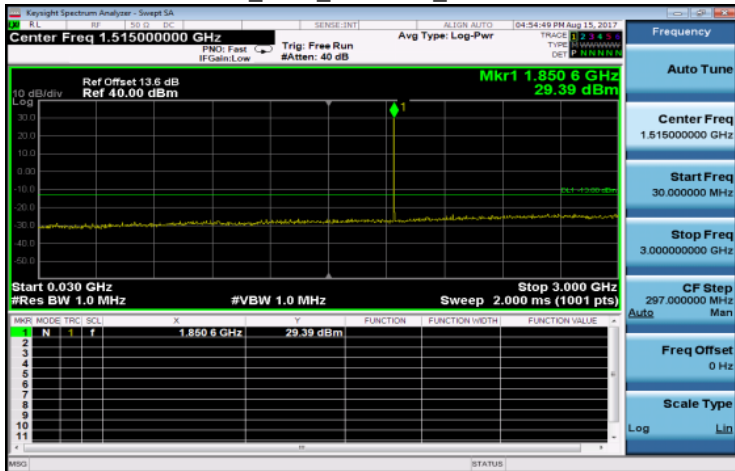

3GHz~10GHz_GSM_1900MHz_MidCH661-1880

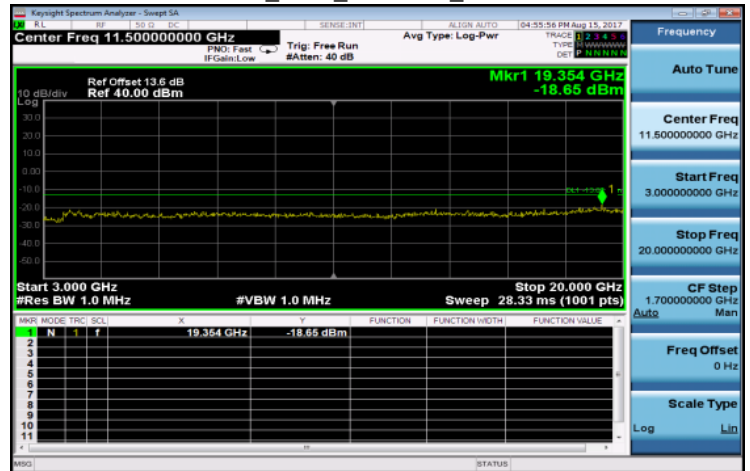

3GHz~10GHz_GSM_1900MHz_LowCH512-1850.2

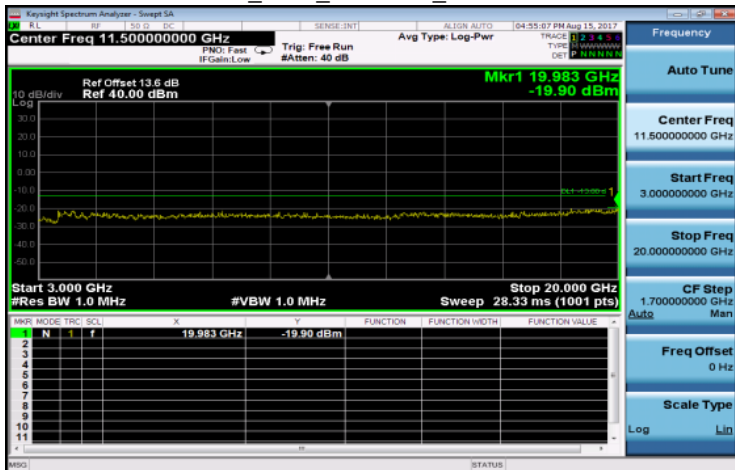

30MHz~3GHz_GSM_1900MHz_HighCH810-1909.8

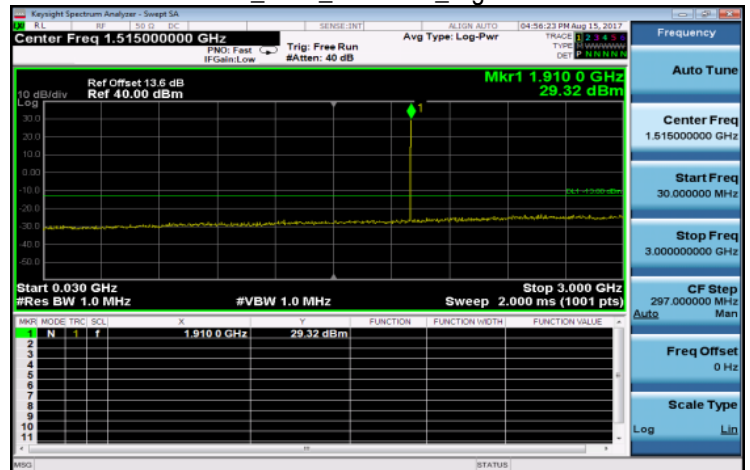

30MHz~3GHz_GSM_1900MHz_MidCH661-1880

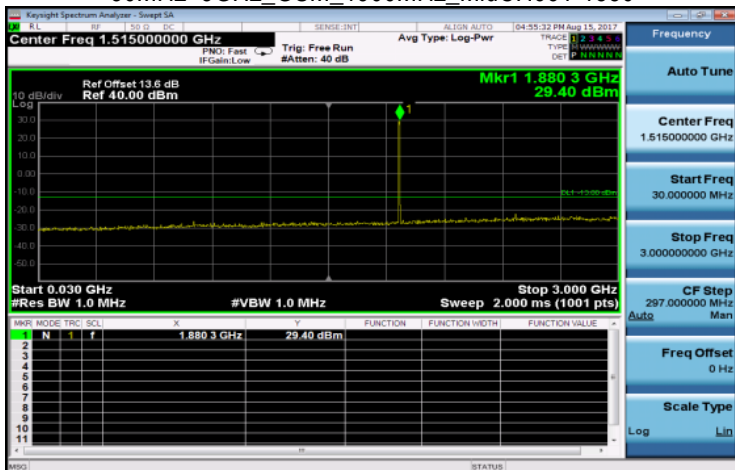

3GHz~10GHz_GSM_1900MHz_HighCH810-1909.8

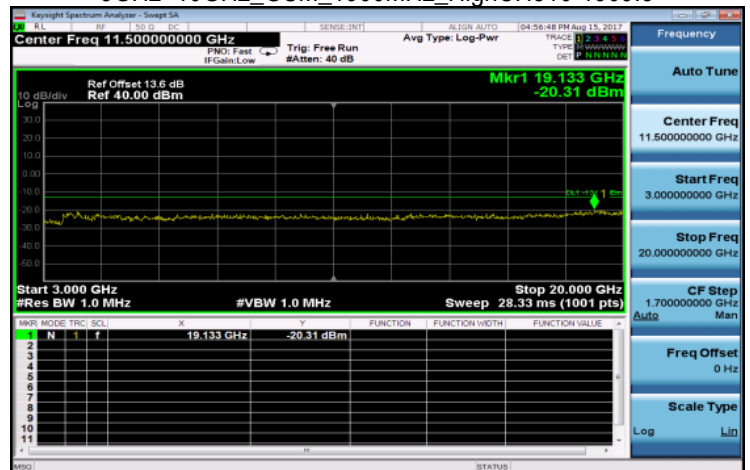

Unless otherwise stated the results shown in this test report refer only to the sample(s) tested and such sample(s) are retained for 90 days only.

除非另有說明，此報告結果僅對測試之樣品負責，同時此樣品僅保留90天。本報告未經本公司書面許可，不可部份複製。

This document is issued by the Company subject to its General Conditions of Service printed overleaf, available on request or accessible at www.sgs.com/terms_and_conditions.htm and, for electronic format documents, subject to Terms and Conditions for Electronic Documents at www.sgs.com/terms_e-document.htm. Attention is drawn to the limitation of liability, indemnification and jurisdiction issues defined therein. Any holder of this document is advised that information contained hereon reflects the Company's findings at the time of its intervention only and within the limits of Client's instructions, if any. The Company's sole responsibility is to its Client and this document does not exonerate parties to a transaction from exercising all their rights and obligations under the transaction documents. This document cannot be reproduced except in full, without prior written approval of the Company. Any unauthorized alteration, forgery or falsification of the content or appearance of this document is unlawful and offenders may be prosecuted to the fullest extent of the law.

SGS Taiwan Ltd.

No. 134, Wukung Road, New Taipei Industrial Park, Wuku District, New Taipei City, Taiwan 24803/新北市五股區新北產業園區五工路 134 號

台灣檢驗科技股份有限公司

t (886-2) 2299-3279

f (886-2) 2298-0488

www.tw.sgs.com

Member of SGS Group

30MHz~3GHz_GPRS_1900MHz_LowCH512-1850.2

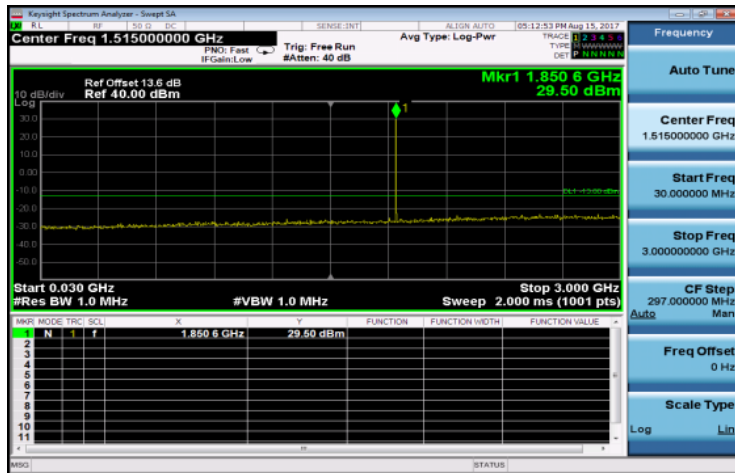

3GHz~10GHz_GPRS_1900MHz_MidCH661-1880

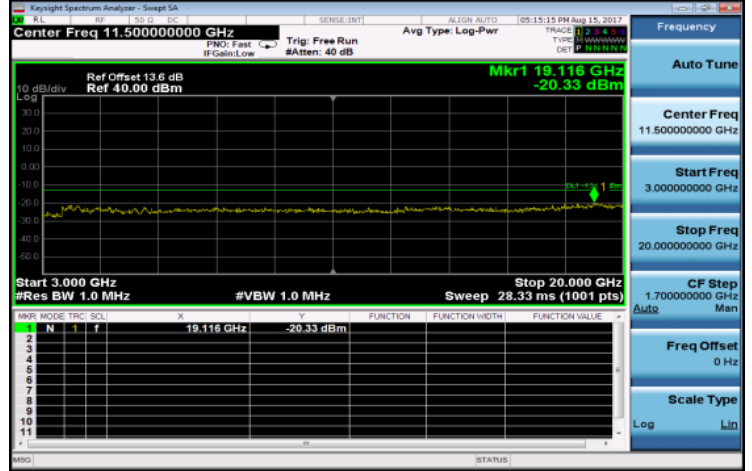

3GHz~10GHz_GPRS_1900MHz_LowCH512-1850.2

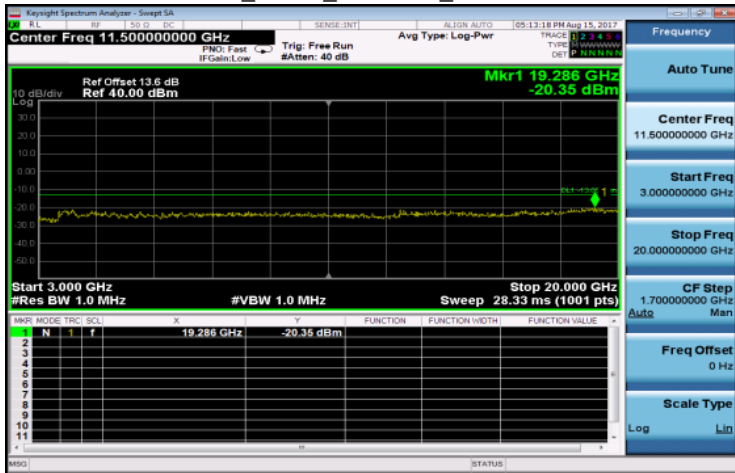

30MHz~3GHz_GPRS_1900MHz_HighCH810-1909.8

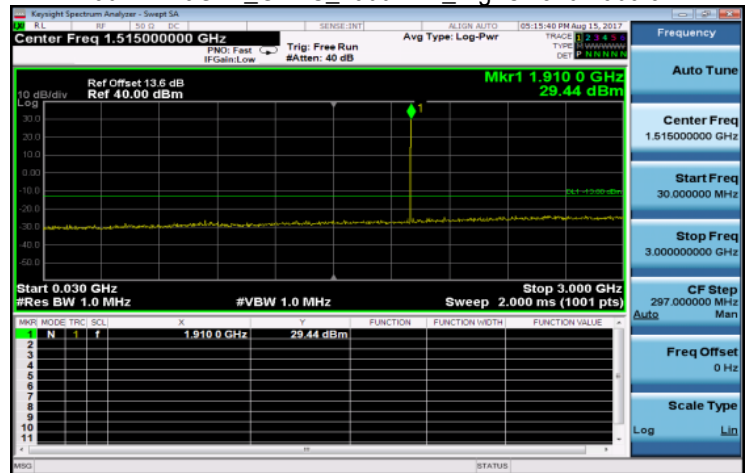

30MHz~3GHz_GPRS_1900MHz_MidCH661-1880

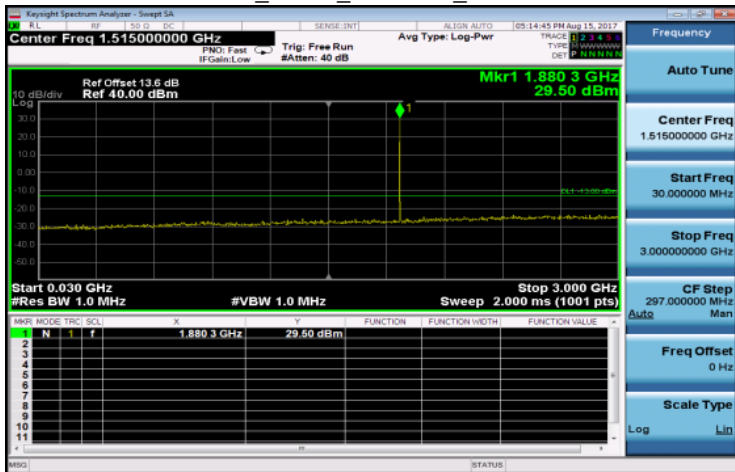

3GHz~10GHz_GPRS_1900MHz_HighCH810-1909.8

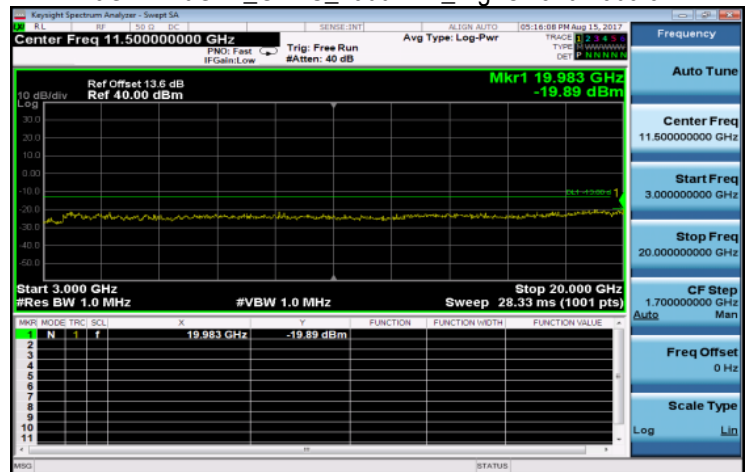

Unless otherwise stated the results shown in this test report refer only to the sample(s) tested and such sample(s) are retained for 90 days only.

除非另有說明，此報告結果僅對測試之樣品負責，同時此樣品僅保留90天。本報告未經本公司書面許可，不可部份複製。

This document is issued by the Company subject to its General Conditions of Service printed overleaf, available on request or accessible at www.sgs.com/terms_and_conditions.htm and, for electronic format documents, subject to Terms and Conditions for Electronic Documents at www.sgs.com/terms_e-document.htm. Attention is drawn to the limitation of liability, indemnification and jurisdiction issues defined therein. Any holder of this document is advised that information contained hereon reflects the Company's findings at the time of its intervention only and within the limits of Client's instructions, if any. The Company's sole responsibility is to its Client and this document does not exonerate parties to a transaction from exercising all their rights and obligations under the transaction documents. This document cannot be reproduced except in full, without prior written approval of the Company. Any unauthorized alteration, forgery or falsification of the content or appearance of this document is unlawful and offenders may be prosecuted to the fullest extent of the law.

30MHz~3GHz_WCDMA_B2_LowCH9262-1852.4

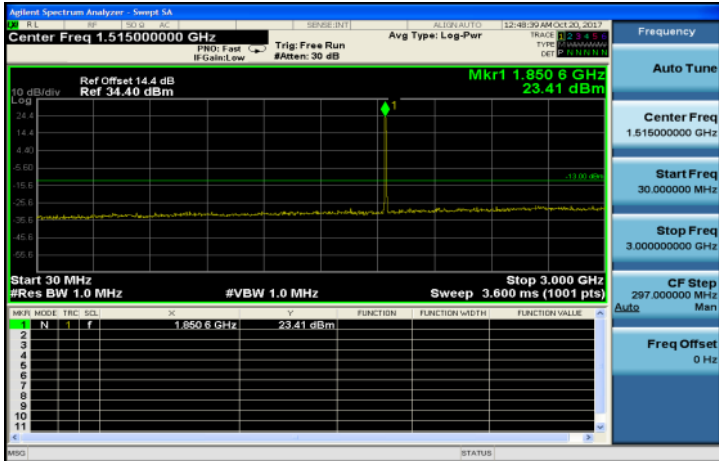

3GHz~10GHz_WCDMA_B2_MidCH9400-1880

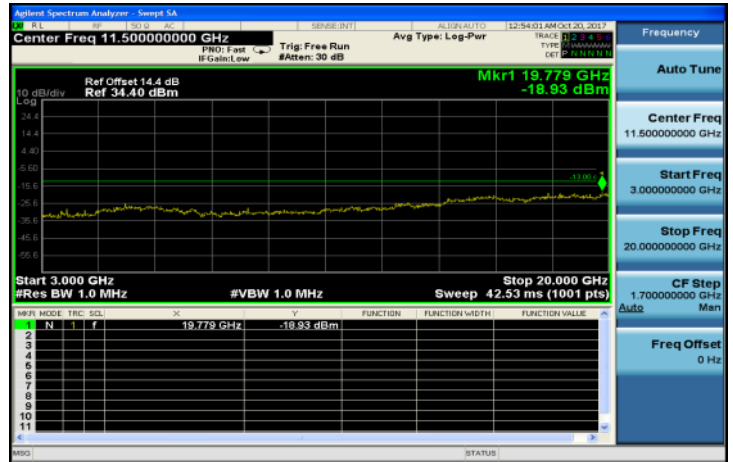

3GHz~10GHz_WCDMA_B2_LowCH9262-1852.4

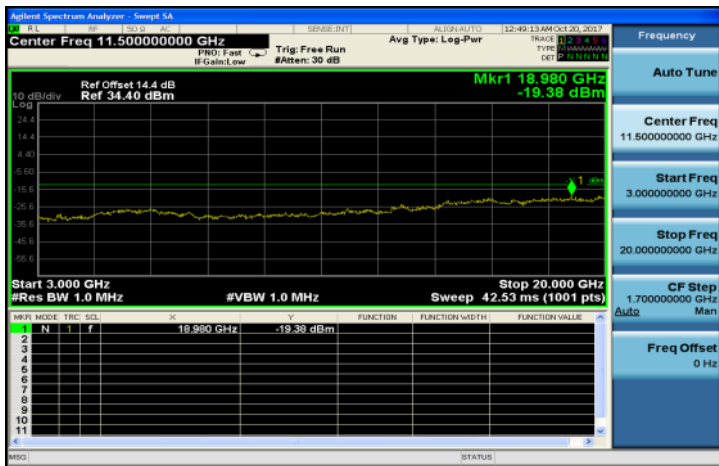

30MHz~3GHz_WCDMA_B2_HighCH9538-1907.6

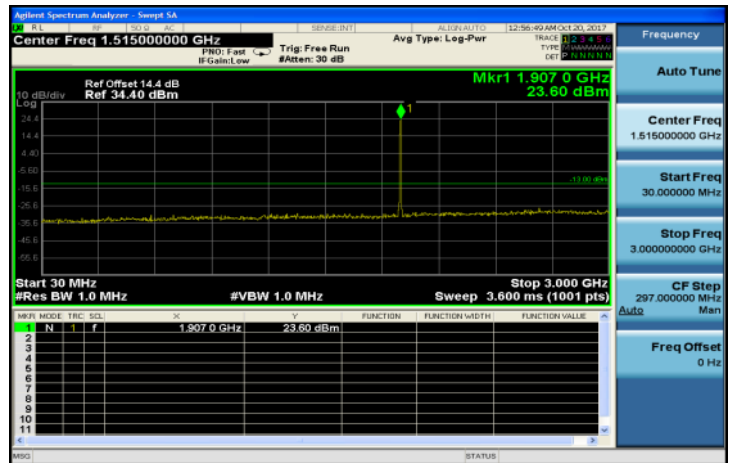

30MHz~3GHz_WCDMA_B2_MidCH9400-1880

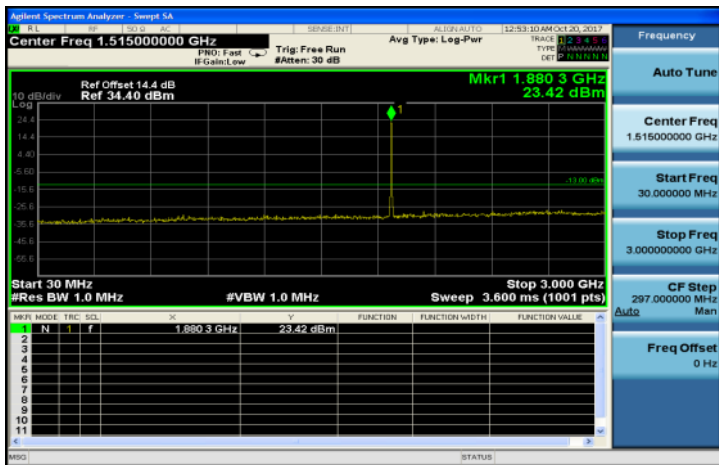

3GHz~10GHz_WCDMA_B2_HighCH9538-1907.6

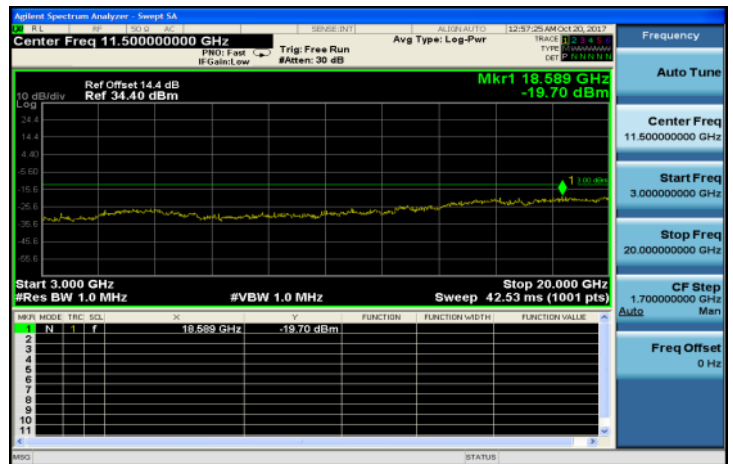

Unless otherwise stated the results shown in this test report refer only to the sample(s) tested and such sample(s) are retained for 90 days only.

除非另有說明，此報告結果僅對測試之樣品負責，同時此樣品僅保留90天。本報告未經本公司書面許可，不可部份複製。

This document is issued by the Company subject to its General Conditions of Service printed overleaf, available on request or accessible at www.sgs.com/terms_and_conditions.htm and, for electronic format documents, subject to Terms and Conditions for Electronic Documents at www.sgs.com/terms_e-document.htm. Attention is drawn to the limitation of liability, indemnification and jurisdiction issues defined therein. Any holder of this document is advised that information contained hereon reflects the Company's findings at the time of its intervention only and within the limits of Client's instructions, if any. The Company's sole responsibility is to its Client and this document does not exonerate parties to a transaction from exercising all their rights and obligations under the transaction documents. This document cannot be reproduced except in full, without prior written approval of the Company. Any unauthorized alteration, forgery or falsification of the content or appearance of this document is unlawful and offenders may be prosecuted to the fullest extent of the law.

30MHz~3GHz_HSDPA_B2_LowCH9262-1852.4

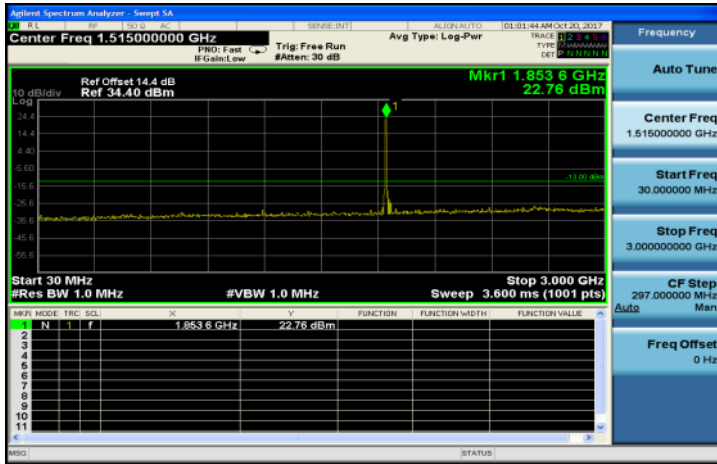

3GHz~10GHz_HSDPA_B2_MidCH9400-1880

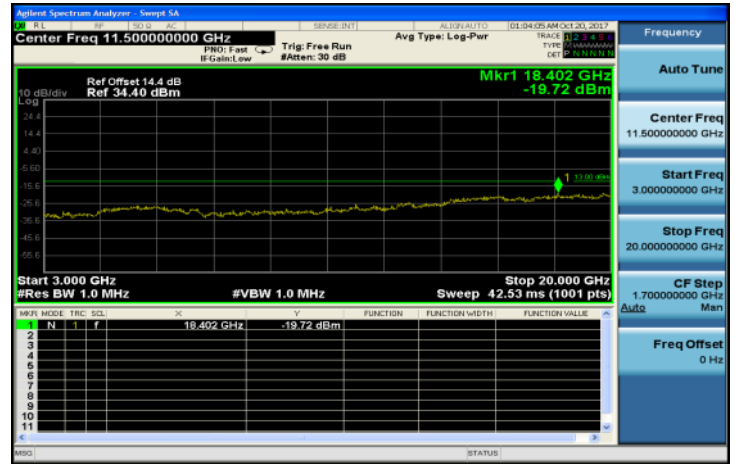

3GHz~10GHz_HSDPA_B2_LowCH9262-1852.4

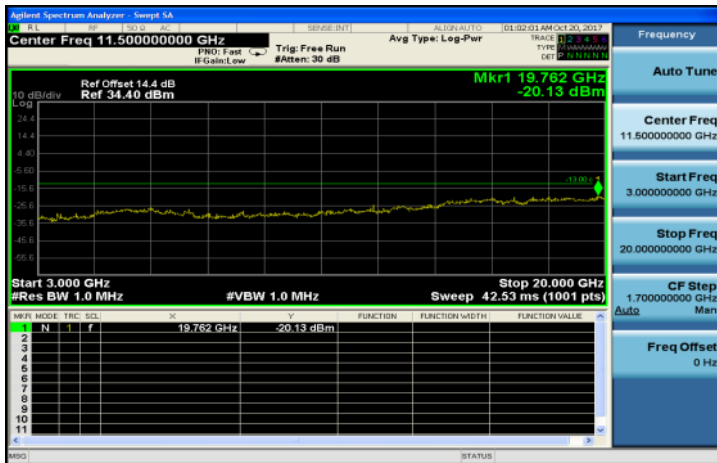

30MHz~3GHz_HSDPA_B2_HighCH9538-1907.6

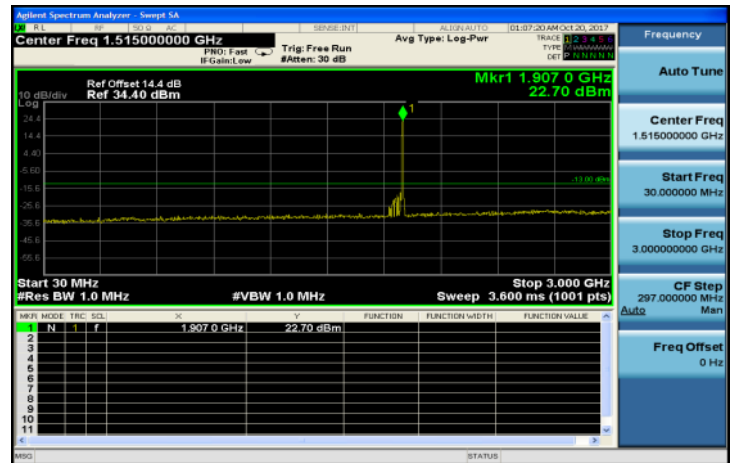

30MHz~3GHz_HSDPA_B2_MidCH9400-1880

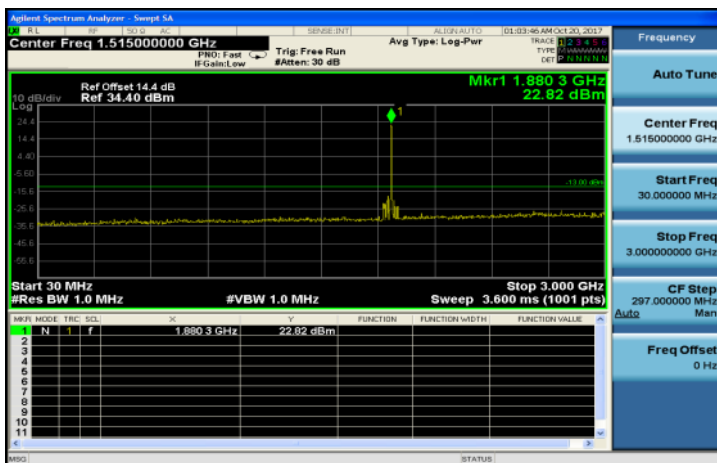

3GHz~10GHz_HSDPA_B2_HighCH9538-1907.6

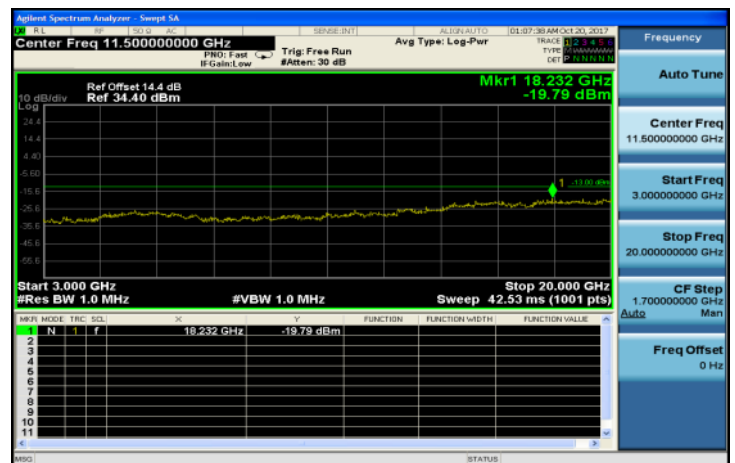

Unless otherwise stated the results shown in this test report refer only to the sample(s) tested and such sample(s) are retained for 90 days only.
除非另有說明，此報告結果僅對測試之樣品負責，同時此樣品僅保留90天。本報告未經本公司書面許可，不可部份複製。

This document is issued by the Company subject to its General Conditions of Service printed overleaf, available on request or accessible at www.sgs.com/terms_and_conditions.htm and, for electronic format documents, subject to Terms and Conditions for Electronic Documents at www.sgs.com/terms_e-document.htm. Attention is drawn to the limitation of liability, indemnification and jurisdiction issues defined therein. Any holder of this document is advised that information contained hereon reflects the Company's findings at the time of its intervention only and within the limits of Client's instructions, if any. The Company's sole responsibility is to its Client and this document does not exonerate parties to a transaction from exercising all their rights and obligations under the transaction documents. This document cannot be reproduced except in full, without prior written approval of the Company. Any unauthorized alteration, forgery or falsification of the content or appearance of this document is unlawful and offenders may be prosecuted to the fullest extent of the law.

30MHz~3GHz_HSUPA_B2_LowCH9262-1852.4

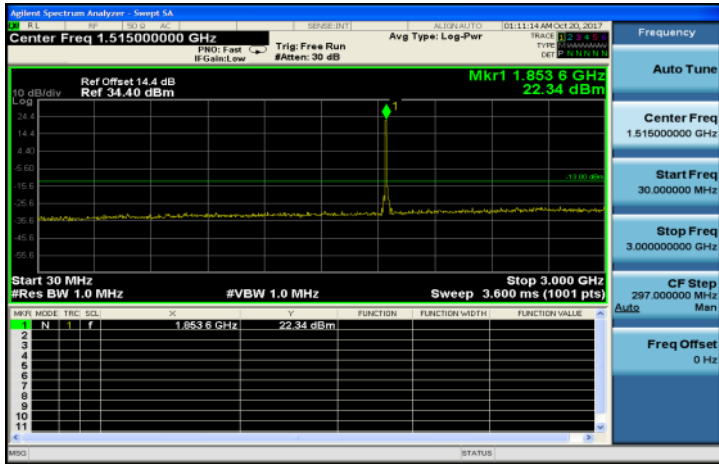

3GHz~10GHz_HSUPA_B2_MidCH9400-1880

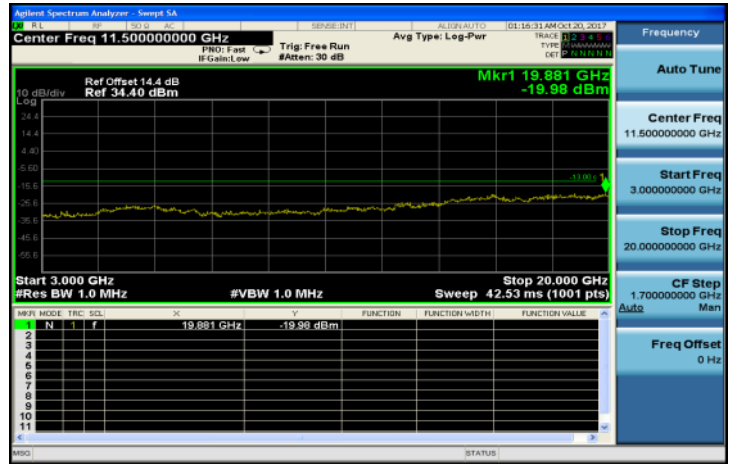

3GHz~10GHz_HSUPA_B2_LowCH9262-1852.4

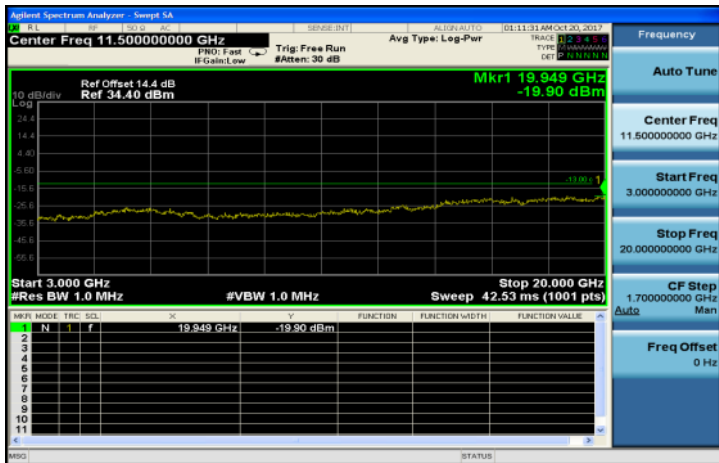

30MHz~3GHz_HSUPA_B2_HighCH9538-1907.6

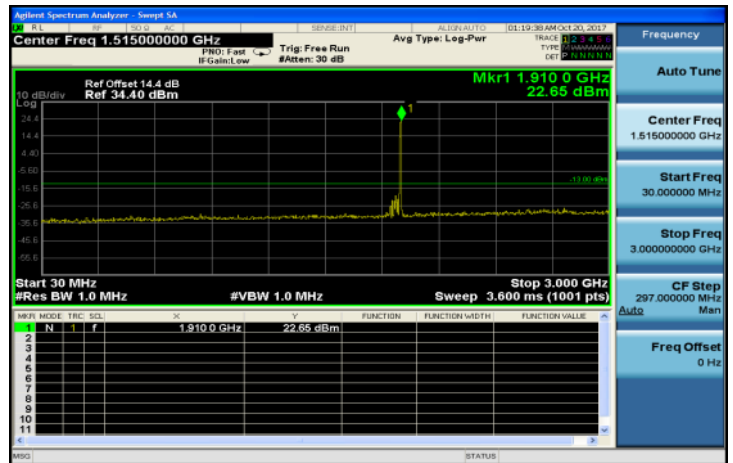

30MHz~3GHz_HSUPA_B2_MidCH9400-1880

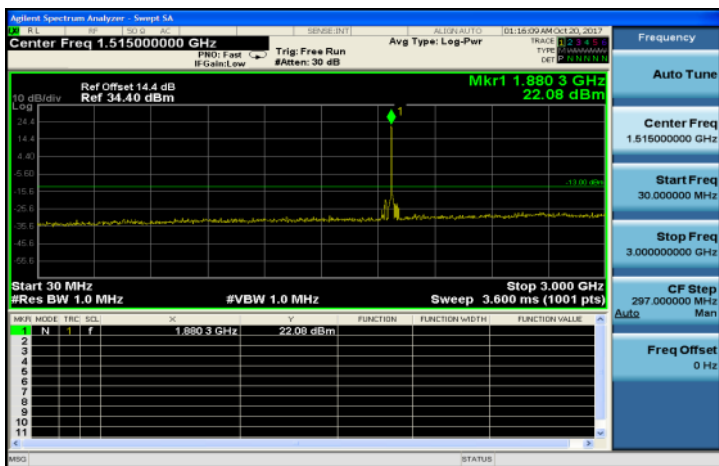

3GHz~10GHz_HSUPA_B2_HighCH9538-1907.6

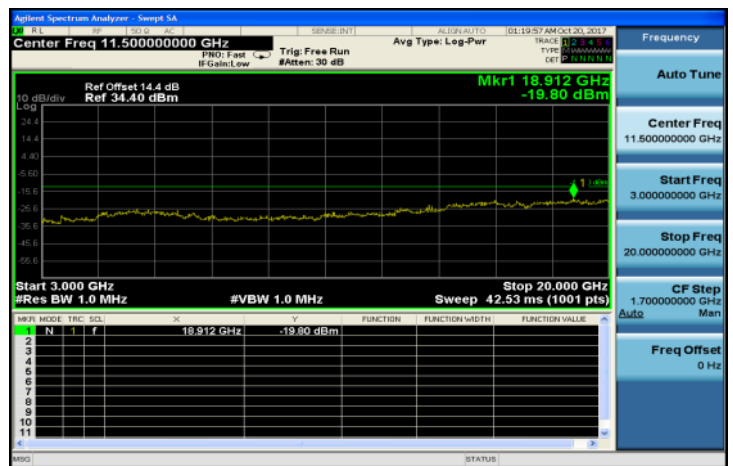

Unless otherwise stated the results shown in this test report refer only to the sample(s) tested and such sample(s) are retained for 90 days only.
除非另有說明，此報告結果僅對測試之樣品負責，同時此樣品僅保留90天。本報告未經本公司書面許可，不可部份複製。

This document is issued by the Company subject to its General Conditions of Service printed overleaf, available on request or accessible at www.sgs.com/terms_and_conditions.htm and, for electronic format documents, subject to Terms and Conditions for Electronic Documents at www.sgs.com/terms_e-document.htm. Attention is drawn to the limitation of liability, indemnification and jurisdiction issues defined therein. Any holder of this document is advised that information contained hereon reflects the Company's findings at the time of its intervention only and within the limits of Client's instructions, if any. The Company's sole responsibility is to its Client and this document does not exonerate parties to a transaction from exercising all their rights and obligations under the transaction documents. This document cannot be reproduced except in full, without prior written approval of the Company. Any unauthorized alteration, forgery or falsification of the content or appearance of this document is unlawful and offenders may be prosecuted to the fullest extent of the law.

30MHz~3GHz_Band2_1_4MHz_QPSK_1_0_LowCH18607-1850.7

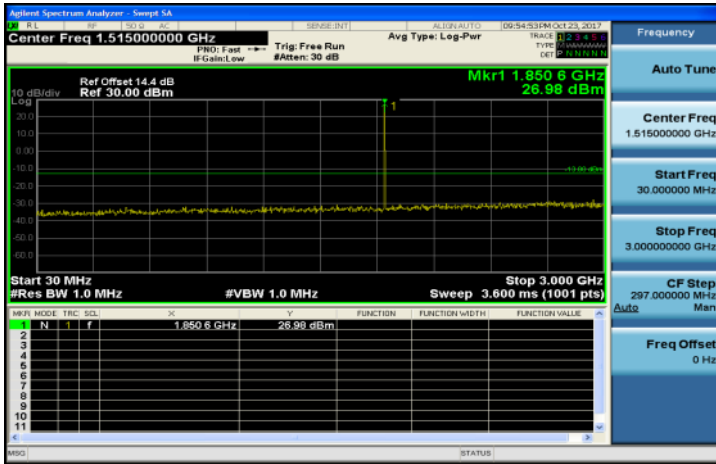

3GHz~10GHz_Band2_1_4MHz_QPSK_1_0_MidCH18900-1880



3GHz~10GHz_Band2_1_4MHz_QPSK_1_0_LowCH18607-1850.7

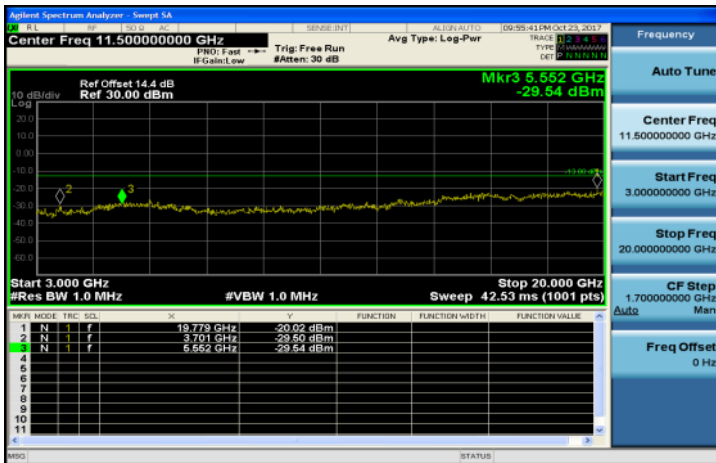

30MHz~3GHz_Band2_1_4MHz_QPSK_1_0_HighCH19193-1909.3

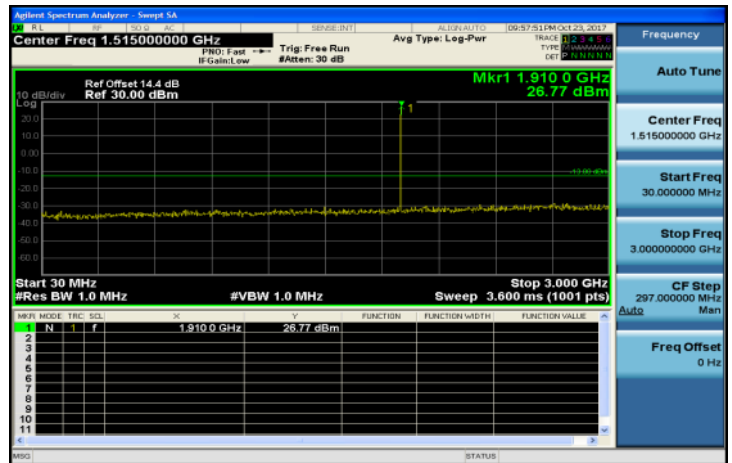

30MHz~3GHz_Band2_1_4MHz_QPSK_1_0_MidCH18900-1880

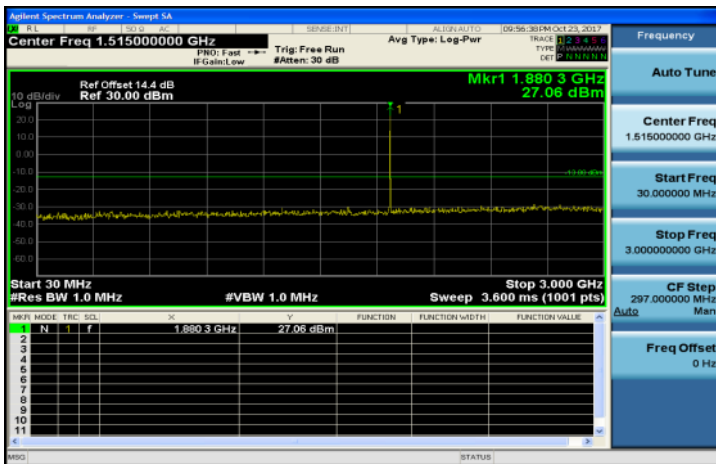

3GHz~10GHz_Band2_1_4MHz_QPSK_1_0_HighCH19193-1909.3

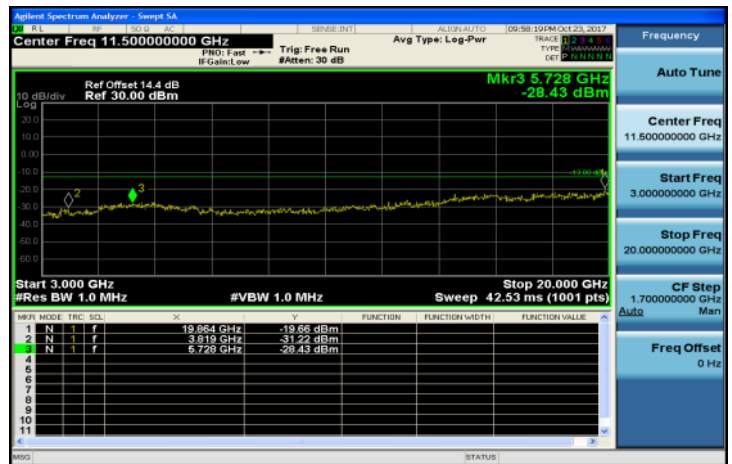

Unless otherwise stated the results shown in this test report refer only to the sample(s) tested and such sample(s) are retained for 90 days only.

除非另有說明，此報告結果僅對測試之樣品負責，同時此樣品僅保留90天。本報告未經本公司書面許可，不可部份複製。

This document is issued by the Company subject to its General Conditions of Service printed overleaf, available on request or accessible at www.sgs.com/terms_and_conditions.htm and, for electronic format documents, subject to Terms and Conditions for Electronic Documents at www.sgs.com/terms_e-document.htm. Attention is drawn to the limitation of liability, indemnification and jurisdiction issues defined therein. Any holder of this document is advised that information contained hereon reflects the Company's findings at the time of its intervention only and within the limits of Client's instructions, if any. The Company's sole responsibility is to its Client and this document does not exonerate parties to a transaction from exercising all their rights and obligations under the transaction documents. This document cannot be reproduced except in full, without prior written approval of the Company. Any unauthorized alteration, forgery or falsification of the content or appearance of this document is unlawful and offenders may be prosecuted to the fullest extent of the law.

30MHz~3GHz_Band2_3MHz_QPSK_1_0_LowCH18615-1851.5

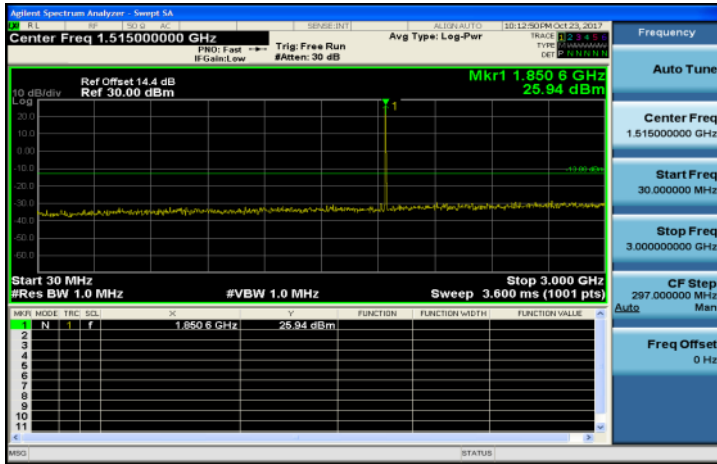

3GHz~10GHz_Band2_3MHz_QPSK_1_0_MidCH18900-1880

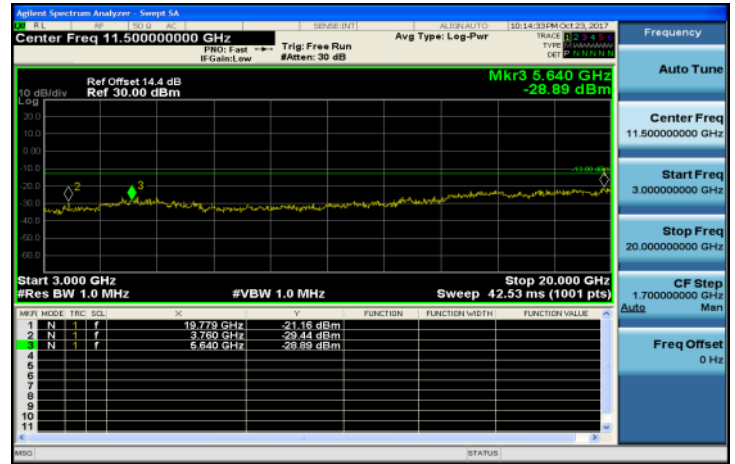

3GHz~10GHz_Band2_3MHz_QPSK_1_0_LowCH18615-1851.5

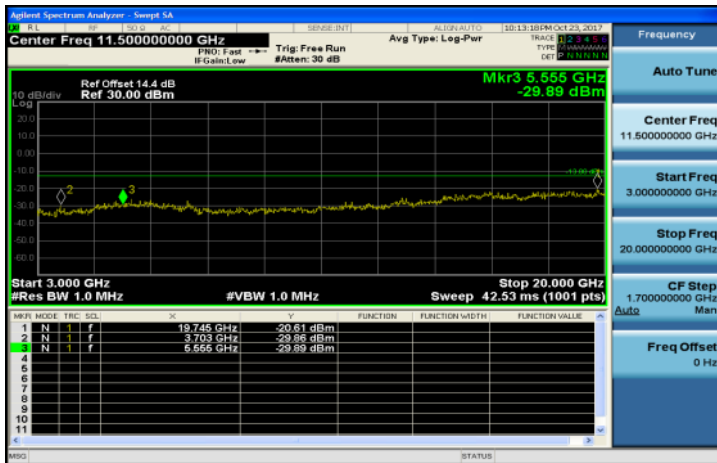

30MHz~3GHz_Band2_3MHz_QPSK_1_0_HighCH19185-1908.5

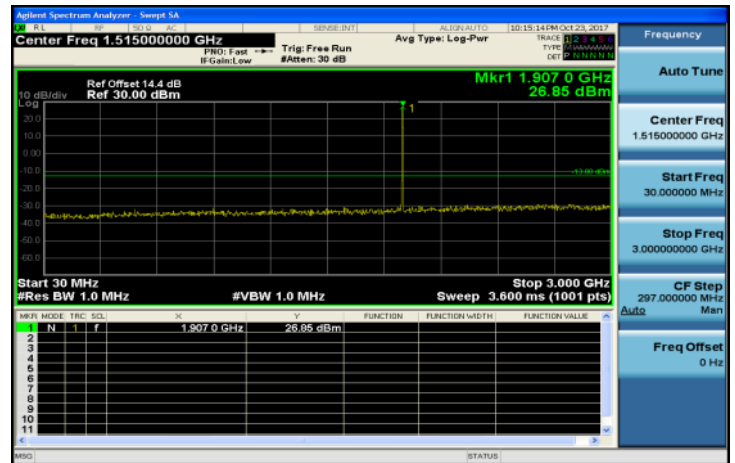

30MHz~3GHz_Band2_3MHz_QPSK_1_0_MidCH18900-1880

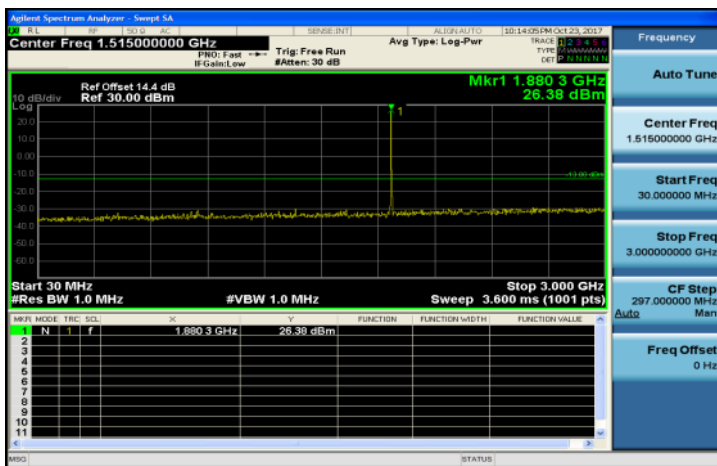

3GHz~10GHz_Band2_3MHz_QPSK_1_0_HighCH19185-1908.5

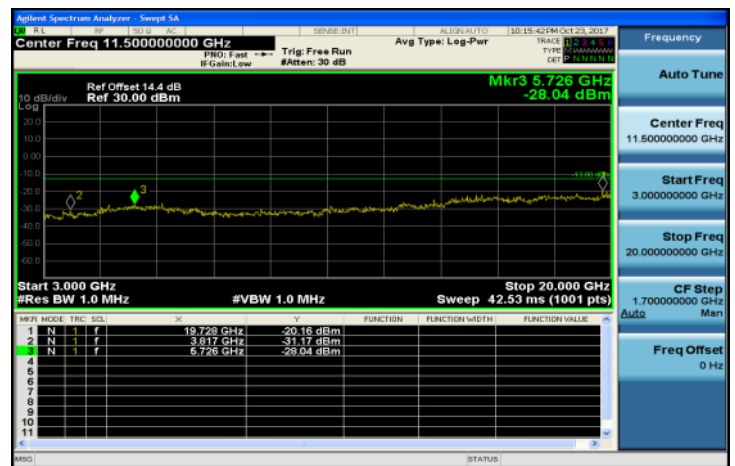

Unless otherwise stated the results shown in this test report refer only to the sample(s) tested and such sample(s) are retained for 90 days only.

除非另有說明，此報告結果僅對測試之樣品負責，同時此樣品僅保留90天。本報告未經本公司書面許可，不可部份複製。

This document is issued by the Company subject to its General Conditions of Service printed overleaf, available on request or accessible at www.sgs.com/terms_and_conditions.htm and, for electronic format documents, subject to Terms and Conditions for Electronic Documents at www.sgs.com/terms_e-document.htm. Attention is drawn to the limitation of liability, indemnification and jurisdiction issues defined therein. Any holder of this document is advised that information contained hereon reflects the Company's findings at the time of its intervention only and within the limits of Client's instructions, if any. The Company's sole responsibility is to its Client and this document does not exonerate parties to a transaction from exercising all their rights and obligations under the transaction documents. This document cannot be reproduced except in full, without prior written approval of the Company. Any unauthorized alteration, forgery or falsification of the content or appearance of this document is unlawful and offenders may be prosecuted to the fullest extent of the law.