

## TEST REPORT (SAR EVALUATION)

**Applicant** : Sharp Corporation, Communication Systems Division  
**Address** : 2-13-1, Iida, Hachihonmatsu, Higashi-Hiroshima City, Hiroshima,  
739-0192, Japan

**Products** : Cellular Phone  
**Model No.** : SH-01F  
**Serial No.** : 004401114935139  
**FCC ID** : APYHRO00197

**Test Standard** : FCC/OET Bulletin 65 Supplement C (Edition 01-01)

**Test Results** : **Passed**

**Date of Test** : September 8 ~ 16, 2013



A handwritten signature in black ink, appearing to read 'K. Shibata'.

Kousei Shibata  
Manager  
Japan Quality Assurance Organization  
KITA-KANSAI Testing Center  
SAITO EMC Branch  
7-3-10, Saito-asagi, Ibaraki-shi, Osaka 567-0085, Japan

- The measurement values stated in Test Report was made with traceable to National Institute of Advanced Industrial Science and Technology (AIST) of Japan, National Institute of Information and Communications Technology (NICT) of Japan , and Laboratory for EMF and Microwave Electronics at the Swiss Federal Institute of Technology (ETH) in Zürich, Switzerland.
- The applicable standard, testing condition and testing method which were used for the tests are based on the request of the applicant.
- The test results presented in this report relate only to the offered test sample.
- The contents of this test report cannot be used for the purposes, such as advertisement for consumers.
- This test report shall not be reproduced except in full without the written approval of JQA.
- VLAC does not approve, certify or warrant the product by this test report.

**TABLE OF CONTENTS**

	<b>Page</b>
1 Description of the Device Under Test (DUT).....	3
2 Summary of Test Results.....	4
3 Test Procedure.....	5
4 Test Location.....	5
5 Recognition of Test Laboratory.....	5
6 Measurement System Diagram.....	6
7 System Components.....	7
8 Measurement Process.....	12
9 Measurement Uncertainties.....	13
10 Test Arrangement.....	15
11 Tissue Verification.....	17
12 System Validation.....	21
13 RF Output Power Measurements.....	23
14 SAR Measurements.....	31
15 Test Setup Photographs.....	54
16 Test Instruments.....	59
17 Appendix.....	60

**1 Description of the Device Under Test (DUT)**

1. Manufacturer : Sharp Corporation, Communication Systems Division  
2-13-1, Iida, Hachihonmatsu, Higashi-Hiroshima City, Hiroshima,  
739-0192, Japan
2. Products : Cellular Phone
3. Model No. : SH-01F
4. Serial No. : 004401114935139
5. Product Type : Pre-production
6. Date of Manufacture : August, 2013
7. Transmitting Frequency : 826.4 MHz – 846.6 MHz (WCDMA Band V)  
824.2 MHz – 848.8 MHz (GSM 850)  
1850.2 MHz – 1909.8 MHz (PCS 1900)  
2402 MHz – 2480 MHz (Bluetooth)  
2412 MHz – 2462 MHz (WLAN 802.11b/g/n)  
5150 MHz – 5250 MHz (WLAN 802.11a/n/ac, W52)  
5250 MHz – 5350 MHz (WLAN 802.11a/n/ac, W53)  
5470 MHz – 5725 MHz (WLAN 802.11a/n/ac, W56)
8. Battery Option : Lithium-ion Battery Pack LIS1531SPPC(SY6) (3000mAh)
9. Power Rating : 4.0VDC
10. EUT Grounding : None
11. Device Category : Portable Device (§2.1093)
12. Exposure Category : General Population/Uncontrolled Exposure
13. FCC Rule Part(s) : 22(H), 24(E), 15.247, 15.407
14. EUT Authorization : Certification
15. Received Date of DUT : September 8, 2013

## 2 Summary of Test Results

Applied Standard : FCC/OET Bulletin 65 Supplement C (Edition 01-01)  
 Evaluating Compliance with FCC Guidelines for Human Exposure to Radio-frequency Electromagnetic Fields  
*Additional Information for Evaluating Compliance of Mobile and Portable Devices with FCC Limits for Human Exposure to Radiofrequency Emissions*

Band	Test Configuration	Reported 1 g SAR (W/kg)	Limit (W/kg)
WCDMA Band V	Head	<b>0.39</b>	<b>1.6</b>
	Body & Hotspot	<b>0.65</b>	
GSM 850	Head	<b>0.40</b>	
	Body & Hotspot	<b>0.68</b>	
PCS 1900	Head	<b>0.32</b>	
	Body & Hotspot	<b>0.45</b>	
WLAN 2.4 GHz	Head	<b>0.40</b>	
	Body & Hotspot	<b>0.18</b>	
WLAN 5.2 GHz	Head	<b>0.25</b>	
	Body	<b>0.22</b>	
WLAN 5.3 GHz	Head	<b>0.26</b>	
	Body	<b>0.19</b>	
WLAN 5.6 GHz	Head	<b>0.38</b>	
	Body	<b>0.24</b>	
Simultaneous transmission condition		<b>0.91</b>	

The test results are **passed** for exposure limits specified in ANSI/IEEE Std. C95.1-1991.

In the approval of test results,

- Determining compliance with the limits in this report was based on the results of the compliance measurement, not taking into account measurement instrumentation uncertainty.
- No deviations were employed from the applied standard.
- No modifications were conducted by JQA to achieve compliance to the limitations.

Reviewed by:

Tested by:



Shigeru Kinoshita  
 Deputy Manager  
 JQA KITA-KANSAI Testing Center  
 SAITO EMC Branch

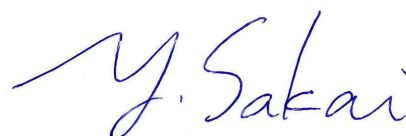

Yasuhisa Sakai  
 Deputy Manager  
 JQA KITA-KANSAI Testing Center  
 SAITO EMC Branch

### 3 Test Procedure

The tests documented in this report were performed in accordance with FCC/OET Bulletin 65 Supplement C (Edition 01-01), IEEE Std.1528–2003 and the following KDB Procedures.

- # 248227 D01 SAR meas for 802 11 a b g v01r02
- # 447498 D01 General RF Exposure Guidance v05r01
- # 648474 D04 SAR Handset SAR v01r01
- # 865664 D01 SAR Measurement 100 MHz to 6 GHz v01r01
- # 865664 D02 RF Exposure Reporting v01r01
- # 941225 D01 SAR test for 3G devices v02
- # 941225 D02 HSPA and 1x Advanced v02r02
- # 941225 D03 SAR Test Reduction GSM GPRS EDGE v01
- # 941225 D06 Hot Spot Mode SAR v01r01

### 4 Test Location

Japan Quality Assurance Organization (JQA)  
KITA-KANSAI Testing Center  
7-7, Ishimaru, 1-chome, Minoh-shi, Osaka, 562-0027, Japan  
SAITO EMC Branch  
7-3-10, Saito-asagi, Ibaraki-shi, Osaka 567-0085, Japan

### 5 Recognition of Test Laboratory

JQA KITA-KANSAI Testing Center SAITO EMC Branch is accredited under ISO/IEC 17025 by following accreditation bodies and the test facility is registered by the following bodies.

- VLAC Accreditation No. : VLAC-001-2 (Expiry date : March 30, 2014)
- VCCI Registration No. : A-0002 (Expiry date : March 30, 2014)
- IC Registration No. : 2079E-3, 2079E-4 (Expiry date : July 20, 2014)

Accredited as conformity assessment body for Japan electrical appliances and material law by METI.  
(Expiry date : February 22, 2016)

**6 Measurement System Diagram**

These measurements are performed using the DASY5 automated dosimetric assessment system (manufactured by Schmid & Partner Engineering AG (SPEAG) in Zürich, Switzerland). It consists of high precision robotics system, cell controller system, DASY5 measurement server, personal computer with DASY5 software, data acquisition electronic (DAE) circuit, the Electro-optical converter (EOC), near-field probe, and the twin SAM phantom containing the equivalent tissue. The robot is a six-axis industrial robot performing precise movements to position the probe to the location (points) of maximum electromagnetic field (EMF).

The Robot is connected to the cell controller to allow software manipulation of the robot. The DAE is connected to the EOC. The DAE performs the signal amplification, signal multiplexing, A/D conversion, offset measurements, mechanical surface detection, collision detection, etc. The EOC performs the conversion from the optical into digital electric signal of the DAE and transfers data to the DASY5 measurement server.

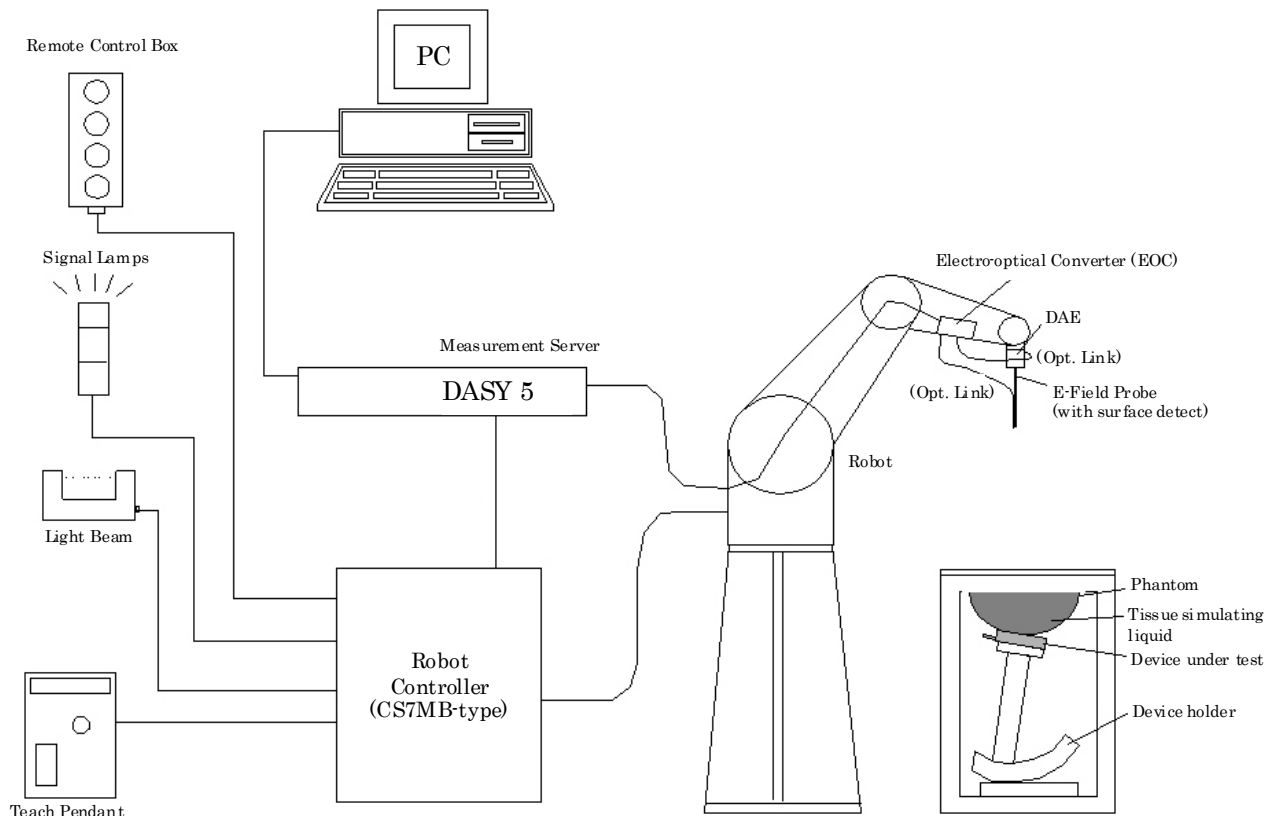

## 7 System Components

### 7.1 Probe Specification ET3DV6

Construction : Symmetrical design with triangular core  
Built-in optical fiber for surface detection system  
Built-in shielding against static changes  
PEEK enclosure material (resistant to organic solvents, e.g., DGBE)

Calibration : In air form 10 MHz to 2.3 GHz  
In head tissue simulating liquid (HSL) and muscle tissue simulating liquid  
835 MHz (accuracy  $\pm 12.0\%$ ;  $k=2$ )  
900 MHz (accuracy  $\pm 12.0\%$ ;  $k=2$ )  
1450 MHz (accuracy  $\pm 12.0\%$ ;  $k=2$ )  
1750 MHz (accuracy  $\pm 12.0\%$ ;  $k=2$ )  
1900 MHz (accuracy  $\pm 12.0\%$ ;  $k=2$ )  
1950 MHz (accuracy  $\pm 12.0\%$ ;  $k=2$ )



Frequency : 10 MHz to 2.3 GHz  
Linearity:  $\pm 0.2$  dB (30 MHz to 2.3 GHz)

Directivity :  $\pm 0.2$  dB in HSL (rotation around probe axis)  
 $\pm 0.4$  dB in HSL (rotation normal to probe axis)

Dynamic Range :  $5 \mu\text{W/g}$  to  $>100 \text{ mW/g}$ ; Linearity:  $\pm 0.2$  dB

Surface Detection :  $\pm 0.2$  mm repeatability in air and clear liquids over diffuse reflecting surfaces

Dimensions : Overall length 337 mm  
Tip length 16 mm  
Body diameter 12 mm  
Tip diameter 6.8 mm  
Distance from probe tip to dipole centers 2.7 mm

## 7.2 Probe Specification EX3DV4

Construction	: Symmetrical design with triangular core Built-in shielding against static charges PEEK enclosure material (resistant to organic solvents, e.g., DGBE)
Calibration	: In air from 10 MHz to 6 GHz In head tissue simulating liquid (HSL) and muscle tissue simulating liquid 2450 MHz (accuracy $\pm 12.0\%$ ; $k=2$ ) 2600 MHz (accuracy $\pm 12.0\%$ ; $k=2$ ) 5200 MHz (accuracy $\pm 13.1\%$ ; $k=2$ ) 5300 MHz (accuracy $\pm 13.1\%$ ; $k=2$ ) 5500 MHz (accuracy $\pm 13.1\%$ ; $k=2$ ) 5600 MHz (accuracy $\pm 13.1\%$ ; $k=2$ ) 5800 MHz (accuracy $\pm 13.1\%$ ; $k=2$ )
Frequency	: 10 MHz to 6 GHz Linearity: $\pm 0.2$ dB (30 MHz to 6 GHz)
Directivity	: $\pm 0.3$ dB in HSL (rotation around probe axis) $\pm 0.5$ dB in tissue material (rotation normal to probe axis)
Dynamic Range	: $10 \mu\text{W/g}$ to $>100 \text{ mW/g}$ ; Linearity: $\pm 0.2$ dB (noise: typically $< 1 \mu\text{W/g}$ )
Dimensions	: Overall length 337 mm Tip length 20 mm Body diameter 12 mm Tip diameter 2.5 mm Distance from probe tip to dipole centers 1 mm





### 7.3 Twin SAM Phantom

The shell corresponds to the specifications of the Specific Anthropomorphic Mannequin (SAM) phantom defined in IEEE 1528 and IEC 62209-1. It enables the dosimetric evaluation of left and right hand phone usage as well as body mounted usage at the flat phantom region. A cover prevents evaporation of the liquid. Reference markings on the phantom allow the complete setup of all predefined phantom positions and measurement grids by teaching three points with the robot.



Shell Thickness :  $2 \pm 0.2$  mm; Center ear point:  $6 \pm 0.2$  mm  
Filling Volume : Volume Approx. 25 liters  
Dimensions :  $810 \times 1000 \times 500$  mm (H  $\times$  L  $\times$  W)

### 7.4 ELI4 Flat Phantom

Phantom for compliance testing of handheld and body-mounted wireless devices in the frequency range of 30 MHz to 6 GHz. ELI is fully compatible with the IEC 62209-2 standard and all known tissue simulating liquids. ELI has been optimized regarding its performance and can be integrated into our standard phantom tables. A cover prevents evaporation of the liquid. Reference markings on the phantom allow installation of the complete setup, including all predefined phantom positions and measurement grids, by teaching three points. The phantom is compatible with all SPEAG dosimetric probes and dipoles.



Shell Thickness :  $2 \pm 0.2$  mm (sagging: <1%)  
Filling Volume : Volume Approx. 30 liters  
Dimensions : Major ellipse axis : 600 mm  
                  Minor axis : 400 mm

**7.5 Mounting Device for Transmitters**

In combination with the Twin SAM Phantom V4.0/V4.0c or ELI4, the Mounting Device enables the rotation of the mounted transmitter device in spherical coordinates. Rotation point is the ear opening point. Transmitter devices can be easily and accurately positioned according to IEC, IEEE, CENELEC, FCC or other specifications. The device holder can be locked for positioning at different phantom sections (left head, right head, flat point).



**7.6 Laptop Extensions Kit for Mounting Device**

Simple but effective and easy-to-use extension for Mounting Device that facilitates the testing of larger devices according to IEC 62209-2 (e.g., laptops, cameras, etc.) It is lightweight and fits easily on the upper part of the Mounting Device in place of the phone positioner. The extension is fully compatible with the Twin SAM, ELI4 and SAM v6.0 Phantoms.



**7.7 Typical Composition of Ingredients for Liquid Tissue**

The following tissue formulations are provided for reference only as some of the parameters have not been thoroughly verified. The composition of ingredients may be modified accordingly to achieve the desired target tissue parameters required for routine SAR evaluation.

Ingredients (% by weight)	Frequency (MHz)									
	450		835		915		1900		2450	
	Head	Body	Head	Body	Head	Body	Head	Body	Head	Body
Water	38.56	51.16	41.45	52.40	41.05	56.00	54.9	40.40	62.70	73.20
Salt (NaCl)	3.95	1.49	1.45	1.40	1.35	0.76	0.18	0.50	0.50	0.04
Sugar	56.32	46.78	56.00	45.00	56.50	41.76	0.00	58.00	0.00	0.00
HEC	0.98	0.52	1.00	1.00	1.00	1.21	0.00	1.00	0.00	0.00
Bactericide	0.19	0.04	0.10	0.10	0.10	0.27	0.00	0.10	0.00	0.00
Triton X-100	0.00	0.00	0.00	0.00	0.00	0.00	0.00	0.00	36.80	0.00
DGBE	0.00	0.00	0.00	0.00	0.00	0.00	44.92	0.00	0.00	26.70

- Salt : 99+% Pure Sodium Chloride      Sugar : 98+% Pure Sucrose
- Water : De-ionized, 16 MΩ<sup>+</sup> resistivity      HEC : Hydroxyethyl Cellulose
- DGBE : 99+% Di (ethylene glycol) butyl ether, [2-(2-butoxyethoxy)ethanol]
- Triton X-100 (ultra pure) : Polyethylene glycol mono [4-(1,1,3,3-tetramethylbutyl)phenyl]ether

**7.8 Composition of Ingredients for Liquid Tissue in the Range From 3 GHz to 6 GHz**

Item	Head Broad Band Tissue Simulation Liquids HBBL 3500-5800
Water	50 – 65 %
Mineral oil	10 – 30 %
Emulsifiers	8 – 25 %
Sodium salt	0 – 1.5 %
Safety relevant ingredients according to EU directives:	
EINECS-No 203-489-0	1.0 – 2.8 % 2-Methyl-pentane-2,4-diol (Hexylene Glycol):
CAS-No 107-41-5	(Xi irritant, R36/38 irritant for eyes and skin)

Item	Muscle Broad Band Tissue Simulation Liquids MBBL 3500-5800
Water	60 – 80 %
Esters, Emulsifiers, Inhibitors	20 – 40 %
Sodium salt	0 – 1.5 %
Safety relevant ingredients according to EU directives: none	
Safety relevant ingredients according to other directives:	
CAS-No 26399-02-0	10 – 28 % Oleic acid, alkylester

## 8 Measurement Process

### Step 1 : Power Reference Measurement

The power reference job measures the field at a specified reference position, at a selectable distance from the phantom surface. The reference position can be either the selected section's grid reference point or a user point in this section. The reference job projects the selected point onto the phantom surface, orients the probe perpendicularly to the surface, and approaches the surface using the selected detection method. The minimum distance of probe sensors to surface set to 4 mm for an ET3DV6 probe, or 2 mm for EX3DV4 probe. This distance cannot be smaller than the distance of sensor calibration points to probe tip as defined in the probe properties.

### Step 2 : Area Scan

The area scan is used as a fast scan in two dimensions to find the area of high field values, before doing a fine measurement around the hot spot. The sophisticated interpolation routines implemented in DASY software can find the maximum locations in relatively coarse grids. When an area scan has measured all reachable points, it computes the field maximal found in the scanned area, within a range of the global maximum. If only one zoom scan follows the area scan, then only the absolute maximum will be taken as reference. For cases where multiple maxima within 2 dB of the maximum SAR value are detected, the number of zoom scans has to be increased accordingly.

### Step 3 : Zoom Scan

Zoom scans are used to assess the peak spatial SAR values within a cubic averaging volume containing 1 g and 10 g of simulated tissue. The zoom scan measures points specified in standards within a cube whose base faces are centered on the maxima found in a preceding area scan job within the same procedure.

### Step 4 : Z Scan

The Z scan measures points along a vertical straight line. The line runs along the Z axis of a one-dimensional grid. In order to get a reasonable extrapolation, the extrapolated distance should not be larger than the step size in Z-direction.

### Step 5 : Power Drift Measurement

The power drift measurement measures the field at the same location as the most recent power reference measurement job within the same procedure, and with the same settings. The power drift measurement gives the field difference in dB from the reading conducted within the last power reference measurement. The power reference measurement and power drift measurement are for monitoring the power drift of the device under test in the batch process.

## 9 Measurement Uncertainties

### 9.1 300 MHz to 3 GHz

Uncertainty Component	Tol. (± %)	Prob. Dist.	Div.	$c_i$ (1g)	$c_i$ (10g)	Std. Unc. (± %)		$\nu_i$
						1g	10g	
<b>Measurement System</b>								
Probe calibration	6.0	N	1	1	1	6.0	6.0	∞
Axial isotropy	4.7	R	$\sqrt{3}$	0.7	0.7	1.9	1.9	∞
Hemispherical isotropy	9.6	R	$\sqrt{3}$	0.7	0.7	3.9	3.9	∞
Boundary effect	1.0	R	$\sqrt{3}$	1	1	0.6	0.6	∞
Linearity	4.7	R	$\sqrt{3}$	1	1	2.7	2.7	∞
System detection limits	1.0	R	$\sqrt{3}$	1	1	0.6	0.6	∞
Readout electronics	0.3	N	1	1	1	0.3	0.3	∞
Response time	0.8	R	$\sqrt{3}$	1	1	0.5	0.5	∞
Integration time	2.6	R	$\sqrt{3}$	1	1	1.5	1.5	∞
RF ambient conditions – noise	3.0	R	$\sqrt{3}$	1	1	1.7	1.7	∞
RF ambient conditions – reflections	3.0	R	$\sqrt{3}$	1	1	1.7	1.7	∞
Probe positioner mechanical tolerance	0.4	R	$\sqrt{3}$	1	1	0.2	0.2	∞
Probe positioning with respect to phantom shell	2.9	R	$\sqrt{3}$	1	1	1.7	1.7	∞
Extrapolation, interpolation and integration algorithms for max. SAR evaluation	1.0	R	$\sqrt{3}$	1	1	0.6	0.6	∞
<b>Test Sample Related</b>								
Test sample positioning	3.4	N	1	1	1	3.4	3.4	23
Device holder uncertainty	2.9	N	1	1	1	2.9	2.9	5
Output power variation – SAR drift measurement	5.0	R	$\sqrt{3}$	1	1	2.9	2.9	∞
<b>Phantom and Tissue Parameters</b>								
Phantom uncertainty	4.0	R	$\sqrt{3}$	1	1	2.3	2.3	∞
Liquid conductivity – deviation from target	5.0	R	$\sqrt{3}$	0.64	0.43	1.8	1.2	∞
Liquid Conductivity – measurement uncertainty	3.2	N	1	0.64	0.43	2.0	1.4	5
Liquid Permittivity – deviation from target	5.0	R	$\sqrt{3}$	0.6	0.49	1.7	1.4	∞
Liquid Permittivity – measurement uncertainty	3.0	N	1	0.6	0.49	1.8	1.5	5
<b>Combined Standard Uncertainty</b>			RSS			11.0	10.8	
<b>Expanded Uncertainty (95% Confidence Interval)</b>			k=2			<b>22.1</b>	<b>21.5</b>	
NOTES 1. Tol. : tolerance in influence quantity 2. Prob. Dist. : probability distributions 3. N, R : normal, rectangular 4. Div. : divisor used to obtain standard uncertainty 5. $c_i$ : sensitivity coefficient 6. Std. Unc. : standard uncertainty 7. Measurement uncertainties are according to IEEE Std. 1528 and IEC 62209-1.								

9.2 3 GHz to 6 GHz

Uncertainty Component	Tol. (± %)	Prob. Dist.	Div.	$c_i$ (1g)	$c_i$ (10g)	Std. Unc. (± %)		$v_i$
						1g	10g	
<b>Measurement System</b>								
Probe calibration	6.6	N	1	1	1	6.6	6.6	∞
Axial isotropy	4.7	R	$\sqrt{3}$	0.7	0.7	1.9	1.9	∞
Hemispherical isotropy	9.6	R	$\sqrt{3}$	0.7	0.7	3.9	3.9	∞
Boundary effect	2.0	R	$\sqrt{3}$	1	1	1.2	1.2	∞
Linearity	4.7	R	$\sqrt{3}$	1	1	2.7	2.7	∞
System detection limits	1.0	R	$\sqrt{3}$	1	1	0.6	0.6	∞
Readout electronics	0.3	N	1	1	1	0.3	0.3	∞
Response time	0.8	R	$\sqrt{3}$	1	1	0.5	0.5	∞
Integration time	2.6	R	$\sqrt{3}$	1	1	1.5	1.5	∞
RF ambient conditions – noise	3.0	R	$\sqrt{3}$	1	1	1.7	1.7	∞
RF ambient conditions – reflections	3.0	R	$\sqrt{3}$	1	1	1.7	1.7	∞
Probe positioner mechanical tolerance	0.8	R	$\sqrt{3}$	1	1	0.5	0.5	∞
Probe positioning with respect to phantom shell	6.7	R	$\sqrt{3}$	1	1	3.9	3.9	∞
Extrapolation, interpolation and integration algorithms for max. SAR evaluation	4.0	R	$\sqrt{3}$	1	1	2.3	2.3	∞
<b>Test Sample Related</b>								
Test sample positioning	3.4	N	1	1	1	3.4	3.4	23
Device holder uncertainty	2.9	N	1	1	1	2.9	2.9	5
Output power variation – SAR drift measurement	5.0	R	$\sqrt{3}$	1	1	2.9	2.9	∞
<b>Phantom and Tissue Parameters</b>								
Phantom uncertainty	4.0	R	$\sqrt{3}$	1	1	2.3	2.3	∞
Liquid conductivity – deviation from target	5.0	R	$\sqrt{3}$	0.64	0.43	1.8	1.2	∞
Liquid Conductivity – measurement uncertainty	3.2	N	1	0.64	0.43	2.0	1.4	5
Liquid Permittivity – deviation from target	5.0	R	$\sqrt{3}$	0.6	0.49	1.7	1.4	∞
Liquid Permittivity – measurement uncertainty	3.0	N	1	0.6	0.49	1.8	1.5	5
<b>Combined Standard Uncertainty</b>		RSS				12.1	11.9	
<b>Expanded Uncertainty (95% Confidence Interval)</b>		k=2				<b>24.3</b>	<b>23.7</b>	
NOTES 1. Tol. : tolerance in influence quantity 2. Prob. Dist. : probability distributions 3. N, R : normal, rectangular 4. Div. : divisor used to obtain standard uncertainty 5. $c_i$ : sensitivity coefficient 6. Std. Unc. : standard uncertainty 7. Measurement uncertainties are according to IEEE Std. 1528 and IEC 62209-1.								

**10 Test Arrangement**

**10.1 Head Exposure Conditions**

**10.1.1 Cheek-Touch Position**

1. Position the device with the vertical center line of the body of the device and the horizontal line crossing the center of the ear piece in a plane parallel to the sagittal plane of the phantom.
2. While maintaining the device in this plane, align the vertical center line with the reference plane containing the three ear and mouth reference points (M, RE and LE) and align the center of the ear piece with the line RE-LE.
3. Translate the mobile phone box towards the phantom with the ear piece aligned with the line RE-LE until the phone touches the ear.
4. While maintaining the device in the reference plane and maintaining the phone contact with the ear, move the bottom of the box until any point on the front side is in contact with the cheek of the phantom or until contact with the ear is lost.

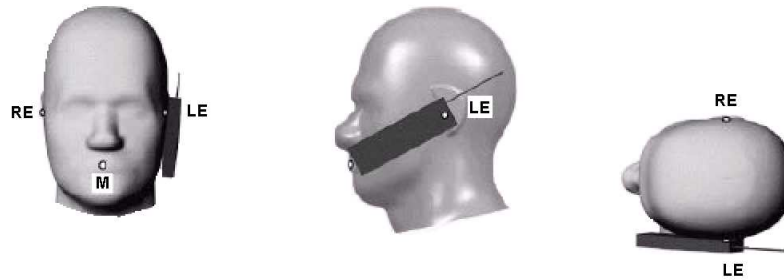
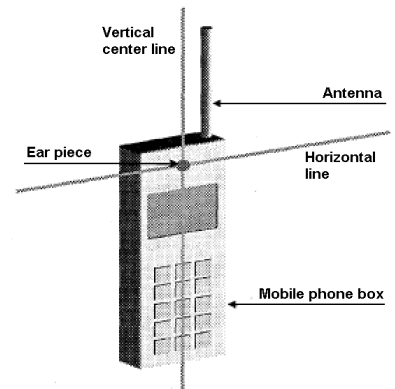

**10.1.2 Ear-Tilt Position**

1. Position the device in the "Cheek-Touch Position".
2. While maintaining the device in the reference plane and pivoting against the ear, move it outward away from the mouth by an angle of 15 degrees or until contact with the ear is lost.

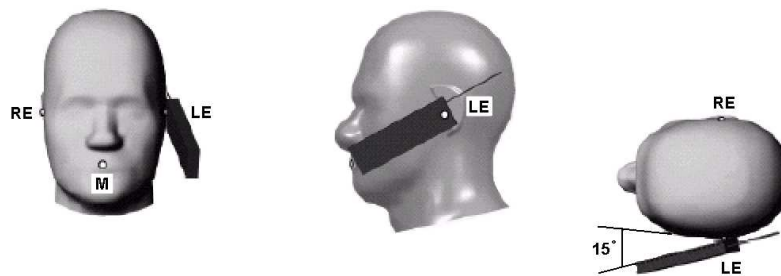

**10.2 Body-worn Accessory Exposure Conditions**

Body-worn operating configurations should be tested with the belt-clips and holsters attached to the device and positioned against a flat phantom in normal use configurations. Both the physical spacing to the body of the user as dictated by the accessory and the materials used in an accessory affect the SAR produced by the transmitting device. For purpose of determining test requirements, accessories may be divided into two categories: those that do not contain metallic components and those that do.

When multiple accessories that do not contain metallic components are supplied with the device, the device may be tested with only the accessory that dictates the closest spacing to the body. When multiple accessories that contain metallic components are supplied with the device, the device must be tested with each accessory that contains a unique metallic component. If multiple accessories share an identical metallic component (e.g., the same metallic belt-clip used with different holsters with no other metallic components), only the accessory that dictates the closest spacing to the body must be tested.

Body-worn accessories may not always be supplied or available as options for some devices that are intended to be authorized for body-worn use. A separation distance of 1.5 cm between the surface of the device and a flat phantom is recommended for testing body-worn SAR compliance under such circumstances. Other separation distances may be used, but they should not exceed 2.5 cm. In these cases, the device may use body-worn accessories that provide a separation distance greater than that tested for the device provided however that the accessory contains no metallic components.

When the reported SAR for a body-worn accessory, measured without a headset connected to the handset, is > 1.2 W/kg, the highest reported SAR configuration for that wireless mode and frequency band should be repeated for that body-worn accessory with a headset attached to the handset.

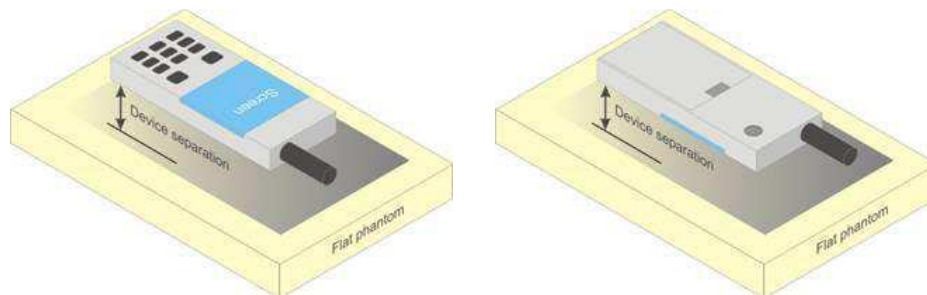

**10.3 Hotspot Mode Exposure Conditions**

For cell phones that support hotspot mode operations, with wireless router capabilities and various web browsing functions, the relevant hand and body exposure conditions are tested according to the hotspot SAR procedures in KDB 941225. A test separation distance of 10 mm is required between the phantom and all surfaces and edges with a transmitting antenna located within 25 mm from that surface or edge. When the form factor of a handset is smaller than 9 cm × 5 cm, a test separation distance of 5 mm (instead of 10 mm) is required for testing hotspot mode. When the separation distance required for body-worn accessory testing is larger than or equal to that tested for hotspot mode, in the same wireless mode and for the same surface of the phone, the hotspot mode SAR data may be used to support body-worn accessory SAR compliance for that particular configuration (surface).



**11 Tissue Verification**

**11.1 Tissue Verification Measurement Condition**

The tissue dielectric parameters must be measured before the tissue-equivalent medium is used in a series of SAR measurements. The parameters should be re-measured after each 3 – 4 days of use, or earlier if dielectric parameters can become out of tolerance; for example, when the parameters are marginal at the beginning of the measurement series.

The temperature of the tissue-equivalent medium used during measurement must be within 18°C to 25°C and within ± 2°C of the temperature when the tissue parameters are characterized.

It is verified by using the dielectric probe and the network analyzer.

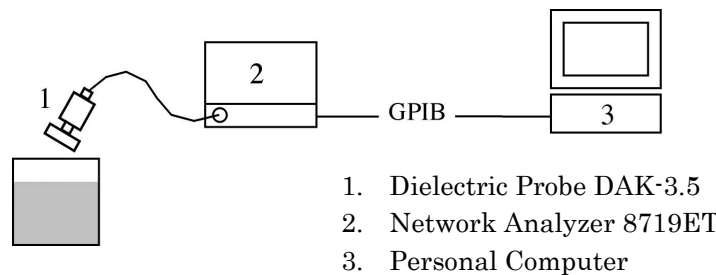

**11.2 Tissue Dielectric Properties**

The tissue dielectric properties are specified in FCC/OET Bulletin 65 Supplement C.

Target Frequency [MHz]	Head		Body	
	Permittivity ( $\epsilon_r$ )	Conductivity ( $\sigma$ )	Permittivity ( $\epsilon_r$ )	Conductivity ( $\sigma$ )
150	52.3	0.76	61.9	0.80
300	45.3	0.87	58.2	0.92
450	43.5	0.87	56.7	0.94
835	41.5	0.90	55.2	0.97
900	41.5	0.97	55.0	1.05
915	41.5	0.98	55.0	1.06
1450	40.5	1.20	54.0	1.30
1610	40.3	1.29	53.8	1.40
1800 – 2000	40.0	1.40	53.3	1.52
2450	39.2	1.80	52.7	1.95
3000	38.5	2.40	52.0	2.73
5800	35.3	5.27	48.2	6.00

For tissue dielectric properties at other frequencies within the range, a linear interpolation method shall be used.

### 11.3 Tissue Verification Results

Tissue dielectric parameters are measured at the low, middle and high frequency of each operating frequency range of the test device.

Date	Liquid	Frequency [MHz]	Parameters	Target	Measured	Deviation [%]	Limit [%]
9/8/2013	Body	820	Permittivity ( $\epsilon_r$ )	55.3	55.21	-0.16	$\pm 5$
			Conductivity ( $\sigma$ )	0.97	0.986	+1.65	$\pm 5$
		835	Permittivity ( $\epsilon_r$ )	55.2	55.06	-0.25	$\pm 5$
			Conductivity ( $\sigma$ )	0.97	1.001	+3.20	$\pm 5$
		850	Permittivity ( $\epsilon_r$ )	55.2	54.89	-0.56	$\pm 5$
			Conductivity ( $\sigma$ )	0.99	1.018	+2.83	$\pm 5$
9/9/2013	Head	820	Permittivity ( $\epsilon_r$ )	41.6	41.81	+0.50	$\pm 5$
			Conductivity ( $\sigma$ )	0.90	0.900	+0.00	$\pm 5$
		835	Permittivity ( $\epsilon_r$ )	41.5	41.43	-0.17	$\pm 5$
			Conductivity ( $\sigma$ )	0.90	0.914	+1.56	$\pm 5$
		850	Permittivity ( $\epsilon_r$ )	41.5	41.06	-1.06	$\pm 5$
			Conductivity ( $\sigma$ )	0.92	0.927	+0.76	$\pm 5$
9/10/2013	Head	1850	Permittivity ( $\epsilon_r$ )	40.0	39.98	-0.05	$\pm 5$
			Conductivity ( $\sigma$ )	1.40	1.374	-1.86	$\pm 5$
		1880	Permittivity ( $\epsilon_r$ )	40.0	39.93	-0.18	$\pm 5$
			Conductivity ( $\sigma$ )	1.40	1.407	+0.50	$\pm 5$
		1900	Permittivity ( $\epsilon_r$ )	40.0	39.85	-0.37	$\pm 5$
			Conductivity ( $\sigma$ )	1.40	1.425	+1.79	$\pm 5$
1910	Permittivity ( $\epsilon_r$ )	40.0	39.84	-0.40	$\pm 5$		
	Conductivity ( $\sigma$ )	1.40	1.437	+2.64	$\pm 5$		
9/11/2013	Body	1850	Permittivity ( $\epsilon_r$ )	53.3	52.64	-1.24	$\pm 5$
			Conductivity ( $\sigma$ )	1.52	1.492	-1.84	$\pm 5$
		1880	Permittivity ( $\epsilon_r$ )	53.3	52.63	-1.26	$\pm 5$
			Conductivity ( $\sigma$ )	1.52	1.525	+0.33	$\pm 5$
		1900	Permittivity ( $\epsilon_r$ )	53.3	52.59	-1.33	$\pm 5$
			Conductivity ( $\sigma$ )	1.52	1.543	+1.51	$\pm 5$
1910	Permittivity ( $\epsilon_r$ )	53.3	52.57	-1.37	$\pm 5$		
	Conductivity ( $\sigma$ )	1.52	1.551	+2.04	$\pm 5$		
9/12/2013	Body	5180	Permittivity ( $\epsilon_r$ )	49.0	47.43	-3.20	$\pm 5$
			Conductivity ( $\sigma$ )	5.28	5.410	+2.46	$\pm 5$
		5200	Permittivity ( $\epsilon_r$ )	49.0	47.39	-3.29	$\pm 5$
			Conductivity ( $\sigma$ )	5.30	5.436	+2.57	$\pm 5$
		5240	Permittivity ( $\epsilon_r$ )	49.0	47.34	-3.39	$\pm 5$
			Conductivity ( $\sigma$ )	5.35	5.483	+2.49	$\pm 5$

**Tissue Verification Results (continued)**

Date	Liquid	Frequency [MHz]	Parameters	Target	Measured	Deviation [%]	Limit [%]
9/12/2013	Body	5260	Permittivity ( $\epsilon_r$ )	48.9	47.31	-3.25	$\pm 5$
			Conductivity ( $\sigma$ )	5.37	5.517	+2.74	$\pm 5$
		5300	Permittivity ( $\epsilon_r$ )	48.9	47.23	-3.42	$\pm 5$
			Conductivity ( $\sigma$ )	5.42	5.557	+2.53	$\pm 5$
		5320	Permittivity ( $\epsilon_r$ )	48.9	47.19	-3.50	$\pm 5$
			Conductivity ( $\sigma$ )	5.44	5.583	+2.63	$\pm 5$
9/12/2013	Body	5500	Permittivity ( $\epsilon_r$ )	48.6	46.92	-3.46	$\pm 5$
			Conductivity ( $\sigma$ )	5.65	5.802	+2.69	$\pm 5$
		5600	Permittivity ( $\epsilon_r$ )	48.5	46.72	-3.67	$\pm 5$
			Conductivity ( $\sigma$ )	5.77	5.938	+2.91	$\pm 5$
		5700	Permittivity ( $\epsilon_r$ )	48.3	46.57	-3.58	$\pm 5$
			Conductivity ( $\sigma$ )	5.88	6.062	+3.10	$\pm 5$
9/14/2013	Head	5180	Permittivity ( $\epsilon_r$ )	36.0	35.37	-1.75	$\pm 5$
			Conductivity ( $\sigma$ )	4.63	4.561	-1.49	$\pm 5$
		5200	Permittivity ( $\epsilon_r$ )	36.0	35.35	-1.81	$\pm 5$
			Conductivity ( $\sigma$ )	4.66	4.587	-1.57	$\pm 5$
		5240	Permittivity ( $\epsilon_r$ )	35.9	35.28	-1.73	$\pm 5$
			Conductivity ( $\sigma$ )	4.70	4.628	-1.53	$\pm 5$
9/14/2013	Head	5260	Permittivity ( $\epsilon_r$ )	35.9	35.25	-1.81	$\pm 5$
			Conductivity ( $\sigma$ )	4.72	4.646	-1.57	$\pm 5$
		5300	Permittivity ( $\epsilon_r$ )	35.9	35.19	-1.98	$\pm 5$
			Conductivity ( $\sigma$ )	4.76	4.680	-1.68	$\pm 5$
		5320	Permittivity ( $\epsilon_r$ )	35.8	35.14	-1.84	$\pm 5$
			Conductivity ( $\sigma$ )	4.78	4.699	-1.69	$\pm 5$
9/15/2013	Head	5500	Permittivity ( $\epsilon_r$ )	35.6	34.90	-1.97	$\pm 5$
			Conductivity ( $\sigma$ )	4.96	4.869	-1.83	$\pm 5$
		5600	Permittivity ( $\epsilon_r$ )	35.5	34.72	-2.20	$\pm 5$
			Conductivity ( $\sigma$ )	5.07	4.969	-1.99	$\pm 5$
		5700	Permittivity ( $\epsilon_r$ )	35.4	34.59	-2.29	$\pm 5$
			Conductivity ( $\sigma$ )	5.17	5.068	-1.97	$\pm 5$
9/16/2013	Head	2410	Permittivity ( $\epsilon_r$ )	39.3	39.32	+0.05	$\pm 5$
			Conductivity ( $\sigma$ )	1.76	1.795	+1.99	$\pm 5$
		2435	Permittivity ( $\epsilon_r$ )	39.2	39.19	-0.03	$\pm 5$
			Conductivity ( $\sigma$ )	1.79	1.822	+1.79	$\pm 5$
		2450	Permittivity ( $\epsilon_r$ )	39.2	39.12	-0.20	$\pm 5$
			Conductivity ( $\sigma$ )	1.80	1.839	+2.17	$\pm 5$
		2475	Permittivity ( $\epsilon_r$ )	39.2	39.01	-0.48	$\pm 5$
			Conductivity ( $\sigma$ )	1.83	1.869	+2.13	$\pm 5$

**Tissue Verification Results (continued)**

Date	Liquid	Frequency [MHz]	Parameters	Target	Measured	Deviation [%]	Limit [%]
9/16/2013	Body	2410	Permittivity ( $\epsilon_r$ )	52.8	52.20	-1.14	$\pm 5$
			Conductivity ( $\sigma$ )	1.91	1.867	-2.25	$\pm 5$
		2435	Permittivity ( $\epsilon_r$ )	52.7	52.09	-1.16	$\pm 5$
			Conductivity ( $\sigma$ )	1.94	1.898	-2.16	$\pm 5$
		2450	Permittivity ( $\epsilon_r$ )	52.7	52.03	-1.27	$\pm 5$
			Conductivity ( $\sigma$ )	1.95	1.920	-1.54	$\pm 5$
		2475	Permittivity ( $\epsilon_r$ )	52.7	51.93	-1.46	$\pm 5$
			Conductivity ( $\sigma$ )	1.99	1.960	-1.51	$\pm 5$

**12 System Validation**

**12.1 System Validation Measurement Condition**

The power meter PM1 (including Attenuator) measures the forward power at the location of the validation dipole connector. The signal generator is adjusted for 250 mW at the dipole connector and the power meter PM2 is read at that level. After connecting the cable to the dipole, the signal generator is readjusted for the same reading at power meter PM2.

The dipole antenna is matched to be used near flat phantom filled with tissue simulating solution. A specific distance holder is used in the positioning of the antenna to ensure correct spacing between the phantom and the dipole.

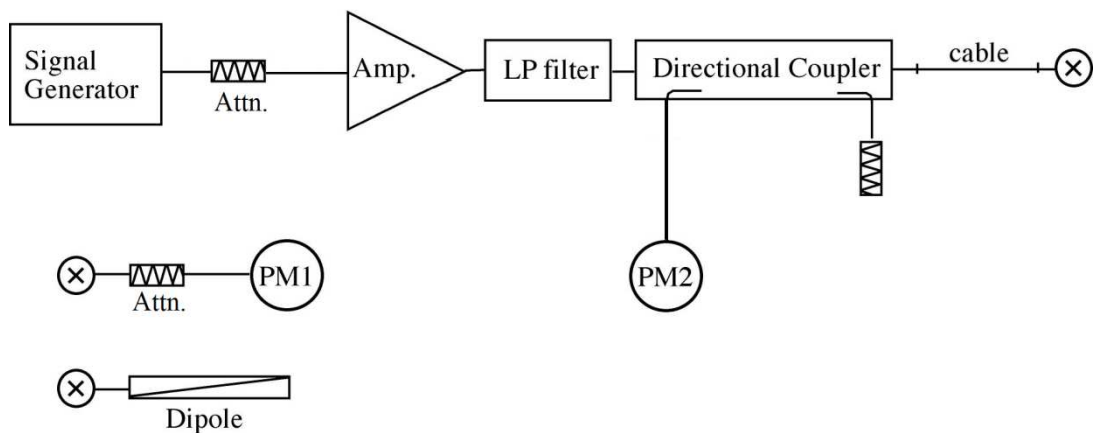

**12.2 Target SAR Values for System Validation**

The target SAR values can be obtained from the calibration certificate of system validation dipoles.

System Dipole		Cal. Date	Frequency [MHz]	Target SAR Values [W/kg]		
Type	Serial			1g/10g	Head	Body
D835V2	4d081	8/15/2013	835	1g	9.48	9.40
				10g	6.16	6.20
D1900V2	5d112	8/22/2013	1900	1g	40.6	41.1
				10g	21.3	21.8
D2450V2	714	11/7/2012	2450	1g	53.1	50.5
				10g	24.7	23.5
D5GHzV2	1039	5/22/2013	5200	1g	77.3	73.2
				10g	22.0	20.5
			5300	1g	80.2	74.3
				10g	23.0	20.9
			5600	1g	81.5	79.4
				10g	23.1	21.9

### 12.3 System Validation Results

The SAR measured with a system validation dipole, using the required tissue-equivalent medium at the test frequency, must be within 10 % of the manufacturer calibrated dipole SAR target.

Date	System Dipole		Liquid	Measured SAR [W/kg] (Normalized to 1 W)		Target	Deviation [%]	Limit [%]
	Type	Serial		1 g	10 g			
9/8/2013	D835V2	4d081	Body	1 g	9.36	9.40	-0.43	± 10
				10 g	6.16	6.20	-0.65	± 10
9/9/2013	D835V2	4d081	Head	1 g	9.56	9.48	+0.84	± 10
				10 g	6.24	6.16	+1.30	± 10
9/10/2013	D1900V2	5d112	Head	1 g	41.20	40.6	+1.48	± 10
				10 g	21.52	21.3	+1.03	± 10
9/11/2013	D1900V2	5d112	Body	1 g	43.60	41.1	+6.08	± 10
				10 g	22.88	21.8	+4.95	± 10
9/12/2013	D5GHzV2 (5.2GHz)	1039	Body	1 g	78.00	73.2	+6.56	± 10
				10 g	21.84	20.5	+6.54	± 10
9/12/2013	D5GHzV2 (5.3GHz)	1039	Body	1 g	81.20	74.3	+9.29	± 10
				10 g	22.44	20.9	+7.37	± 10
9/12/2013	D5GHzV2 (5.6GHz)	1039	Body	1 g	85.60	79.4	+7.81	± 10
				10 g	23.64	21.9	+7.95	± 10
9/14/2013	D5GHzV2 (5.2GHz)	1039	Head	1 g	80.40	77.3	+4.01	± 10
				10 g	22.84	22.0	+3.82	± 10
9/14/2013	D5GHzV2 (5.3GHz)	1039	Head	1 g	81.20	80.2	+1.25	± 10
				10 g	22.84	23.0	-0.70	± 10
9/15/2013	D5GHzV2 (5.6GHz)	1039	Head	1 g	86.80	81.5	+6.50	± 10
				10 g	24.40	23.1	+5.63	± 10
9/16/2013	D2450V2	714	Head	1 g	51.20	53.1	-3.58	± 10
				10 g	23.76	24.7	-3.81	± 10
9/16/2013	D2450V2	714	Body	1 g	50.00	50.5	-0.99	± 10
				10 g	23.48	23.5	-0.09	± 10

### 13 RF Output Power Measurements

#### 13.1 WCDMA Band V

The following tests were completed according to the test requirements outlined in section 5.2 of the 3GPP TS34.121-1 specification.

To setup the desire channel frequency and the maximum output power, a Radio Communication Tester “Anritsu, MT8820C” was used to program the DUT.

##### *3GPP Release 99 WCDMA Settings*

Settings	Release 99		
Loopback Mode	Mode 1	OFF	
Channel Coding	12.2k / 64k / 144k / 384kbps RMC	Voice AMR	
TPC Bit Pattern	All 1		
Power Tolerance (dB)	+1.7/-3.7		

##### *3GPP Release 8 HSDPA Settings*

Settings	Release 8 HSDPA			
Sub-test	1	2	3	4
Loopback Mode	Mode 1			
Channel Coding	Fixed Reference Channel (QPSK)			
TPC Algorithm	2			
TPC Bit Pattern	All 1			
Beta C	2	11	15	15
Beta D	15	15	8	4
MPR (dB)	0	0	0.5	0.5
Power Tolerance (dB)	+1.7/-3.7	+1.7/-3.7	+2.7/-3.7	+3.7/-3.7

##### *3GPP Release 8 HSPA Settings*

Settings	Release 8 HSPA				
Sub-test	1	2	3	4	5
Loopback Mode	Mode 1				
Channel Coding	E-DCH RF Test with TTI 10ms (QPSK)				
TPC Algorithm	2				1
TPC Bit Pattern	Inner Loop Power Control				All 1
Beta C	10	6	15	2	15
Beta D	15	15	9	15	0
Absolute Grant Value	20	12	15	17	12
MPR (dB)	0	2	1	2	0
Power Tolerance (dB)	+1.7/-6.7	+3.7/-5.2	+2.7/-5.2	+3.7/-5.2	+1.7/-3.7

**Conducted power measurement results**

Mode		Conducted Average Power (dBm)		
		4132 ch (826.4 MHz)	4182 ch (836.4 MHz)	4233 ch (846.6 MHz)
12.2 kbps RMC		23.35	23.06	23.26
64 kbps RMC		23.34	23.05	23.26
144 kbps RMC		23.35	23.06	23.26
384 kbps RMC		23.33	23.04	23.27
Voice AMR		23.34	23.06	23.25
R8 HSDPA	Sub-test 1	23.34	23.05	23.26
	Sub-test 2	23.34	23.05	23.24
	Sub-test 3	22.87	22.58	22.75
	Sub-test 4	22.87	22.57	22.73
R8 HSPA	Sub-test 1	23.34	23.05	23.25
	Sub-test 2	21.38	21.10	21.20
	Sub-test 3	22.40	22.25	22.37
	Sub-test 4	21.35	21.08	21.27
	Sub-test 5	23.35	23.05	23.26

Note(s):

1. KDB 941225 D01 – SAR in voice and data modes is measured using a 12.2 kbps RMC. SAR in voice AMR configurations and for other spreading codes are not required when the maximum average output of each channel is less than ¼ dB higher than that measured in 12.2 kbps RMC.
2. KDB 941225 D01 – Body SAR for HSPA (HSDPA/HSUPA) is not required when the maximum average output with HSPA active is less than ¼ dB higher than that measured without HSPA using 12.2 kbps RMC and the maximum SAR for 12.2 kbps RMC is ≤ 75% of the SAR limit.
3. KDB 941225 D01 – Head SAR for HSPA (VoIP applicable) is not required when the maximum average output with HSPA active is less than ¼ dB higher than that measured without HSPA using 12.2 kbps RMC.



### 13.2 GSM 850

To setup the desire channel frequency and the maximum output power, a Radio Communication Tester “Anritsu, MT8820C” was used to program the DUT.

#### *GSM/GPRS Settings*

Settings	Mode	Parameter
General Settings	Band Indicator	GSM 850
	Power Control Level	5 (33 dBm)
GPRS Specific Settings	Connection Type	Test Mode A
	Multi Slot Class	12 (4 down / 4 up / 5 sum)
	Coding Scheme	CS1 (GMSK)

#### *Conducted power measurement results*

Mode		Conducted Power (dBm)		
		128 ch (824.2 MHz)	189 ch (836.4 MHz)	251 ch (848.8 MHz)
GSM	Burst Avg.	32.57	32.42	32.51
	Frame Avg.	23.54	23.39	23.48
GPRS (1 slot)	Burst Avg.	32.57	32.42	32.51
	Frame Avg.	23.54	23.39	23.48
GPRS (2 slot)	Burst Avg.	30.35	30.20	30.28
	Frame Avg.	24.33	24.18	24.26
GPRS (3 slot)	Burst Avg.	28.71	28.53	28.59
	Frame Avg.	24.45	24.27	24.33
GPRS (4 slot)	Burst Avg.	27.56	27.60	27.53
	Frame Avg.	24.55	24.59	24.52

Note(s):

KDB 941225 D03 – The worst-case configuration for SAR testing is determined to be as follows.

1. Body : GPRS mode with 4 time slots, based on the output power above
2. Head : Same mode as Body SAR testing (VoIP applicable using GPRS multi-slot)

### 13.3 PCS 1900

To setup the desire channel frequency and the maximum output power, a Radio Communication Tester was used to program the DUT.

#### *GSM/GPRS Settings*

Settings	Mode	Parameter
General Settings	Band Indicator	PCS 1900
	Power Control Level	0 (30 dBm)
GPRS Specific Settings	Connection Type	Test Mode A
	Multi Slot Class	12 (4 down / 4 up / 5 sum)
	Coding Scheme	CS1 (GMSK)

#### *Conducted power measurement results*

Mode		Conducted Power (dBm)		
		512 ch (1850.2 MHz)	661 ch (1880.0 MHz)	810 ch (1909.8 MHz)
GSM	Burst Avg.	29.63	29.65	29.72
	Frame Avg.	20.60	20.62	20.69
GPRS (1 slot)	Burst Avg.	29.63	29.65	29.72
	Frame Avg.	20.60	20.62	20.69
GPRS (2 slot)	Burst Avg.	27.11	27.13	27.20
	Frame Avg.	21.09	21.11	21.18
GPRS (3 slot)	Burst Avg.	25.67	25.68	25.71
	Frame Avg.	21.41	21.42	21.45
GPRS (4 slot)	Burst Avg.	24.72	24.85	24.78
	Frame Avg.	21.71	21.84	21.77

Note(s):

KDB 941225 D03 – The worst-case configuration for SAR testing is determined to be as follows.

1. Body : GPRS mode with 4 time slots, based on the output power above
2. Head : Same mode as Body SAR testing (VoIP applicable using GPRS multi-slot)

### 13.4 WLAN 2.4 GHz

To setup the desire channel frequency and the maximum output power, RF test mode prepared by the manufacturer was used to program the DUT.

***Conducted power measurement results***

Band	Mode	Channel	Frequency (MHz)	Average Power (dBm)
2.4 GHz	802.11b	1	2412	13.02
		6	2437	12.86
		11	2462	12.83
	802.11g	1	2412	12.96
		6	2437	12.95
		11	2462	12.65
	802.11n [HT20]	1	2412	12.97
		6	2437	13.01
		11	2462	12.71

Note(s):

KDB 248227 D01 – SAR is not required for 802.11g/n channels when the maximum average output power is less than ¼ dB higher than that measured on the corresponding 802.11b channels.

### 13.5 WLAN 5 GHz

To setup the desire channel frequency and the maximum output power, RF test mode prepared by the manufacturer was used to program the DUT.

#### *Conducted power measurement results (W52)*

Band	Mode	Channel	Frequency (MHz)	Average Power (dBm)
5.2 GHz	802.11a	36	5180	9.69
		40	5200	9.44
		44	5220	9.29
		48	5240	9.71
	802.11n [HT20]	36	5180	9.52
		44	5220	9.43
		48	5240	9.71
	802.11n [HT40]	38	5190	8.98
		46	5230	9.06
	802.11ac [VHT80]	42	5210	9.02

Note(s):

KDB 248227 D01 – SAR is not required for 802.11n/ac channels when the maximum average output power is less than ¼ dB higher than that measured on the corresponding 802.11a channels.

#### *Conducted power measurement results (W53)*

Band	Mode	Channel	Frequency (MHz)	Average Power (dBm)
5.3 GHz	802.11a	52	5260	9.55
		56	5280	9.54
		60	5300	9.57
		64	5320	9.49
	802.11n [HT20]	52	5260	9.43
		60	5300	9.70
		64	5320	9.61
	802.11n [HT40]	54	5270	9.03
		62	5310	8.95
	802.11ac [VHT80]	58	5290	9.46

Note(s):

KDB 248227 D01 – SAR is not required for 802.11n/ac channels when the maximum average output power is less than ¼ dB higher than that measured on the corresponding 802.11a channels.

**Conducted power measurement results (W56)**

Band	Mode	Channel	Frequency (MHz)	Average Power (dBm)
5.6 GHz	802.11a	100	5500	9.54
		104	5520	9.67
		108	5540	9.76
		112	5560	9.62
		116	5580	9.89
		120	5600	Not supported
		124	5620	Not supported
		128	5640	Not supported
		132	5660	9.75
		136	5680	9.82
		140	5700	9.92
	802.11n [HT20]	100	5500	9.61
		116	5580	9.80
		140	5700	9.99
	802.11n [HT40]	102	5510	9.37
		110	5550	9.57
		134	5670	9.42
	802.11ac [VHT80]	106	5530	9.82

Note(s):

KDB 248227 D01 – SAR is not required for 802.11n/ac channels when the maximum average output power is less than ¼ dB higher than that measured on the corresponding 802.11a channels.

### 13.6 Bluetooth

For the Bluetooth operation, the client supplied a special driving program to program the DUT to continually transmit the specified maximum power.

Modulation type : Frequency Hopping Spread Spectrum (FHSS)  
 Transmitting Frequency : 2402 MHz (0 ch) – 2480 MHz (78 ch)  
 RF Output Power : Max. 4.0 dBm (Class 2)

### 13.7 Standalone SAR Test Exclusion Considerations (KDB 447498 D01)

The 1 g SAR test exclusion thresholds for 100 MHz to 6 GHz at *test separation distances*  $\leq 50$  mm are determined by:

$$[(\text{max. power of channel, including tune-up tolerance, mW}) / (\text{min. test separation distance, mm})] \cdot [\sqrt{f_{\text{(GHz)}}}] \leq 3.0, \text{ where}$$

- $f_{\text{(GHz)}}$  is the RF channel transmit frequency in GHz.
- Power and distance are rounded to the nearest mW and mm before calculation.
- The result is rounded to one decimal place for comparison.
- When the minimum test separation distance is  $< 5$  mm, a distance of 5 mm is applied.

Band	Frequency (MHz)	Max. Power		Test Position	Distance (mm)	Threshold	Test Exclusion
		(dBm)	(mW)				
WLAN 2.4 GHz	2462	15.0	32	Head	< 5	10.0	NO
				Body	10	5.0	NO
WLAN 5 GHz	5700	11.5	14	Head	< 5	6.7	NO
				Body	10	3.3	NO
Bluetooth	2480	4.0	3	Head	< 5	0.9	YES
				Body	10	0.5	YES

## 14 SAR Measurements

### 14.1 WCDMA Band V

#### 14.1.1 Head

R99 12.2kbps RMC – Duty Cycle 100%								
Test Position	Ch#	Freq. [MHz]	Power [dBm]		1 g SAR [W/kg]		Plot No.	Note
			Tune-up Limit	Meas.	Meas.	Scaled		
Left Touched	4132	826.4						1
	4182	836.4	24.2	23.06	0.290	<b>0.377</b>		
	4233	846.6						1
Left Tilted	4132	826.4						1
	4182	836.4	24.2	23.06	0.172	<b>0.224</b>		
	4233	846.6						1
Right Touched	4132	826.4						1
	4182	836.4	24.2	23.06	0.303	<b>0.394</b>	1	
	4233	846.6						1
Right Tilted	4132	826.4						1
	4182	836.4	24.2	23.06	0.154	<b>0.200</b>		
	4233	846.6						1

NOTE(S) :

- KDB 447498 D01 – Testing of other required channels within the operating mode of a frequency band is not required when the reported 1 g SAR for the mid-band or highest output power channel is:
  - ≤ 0.8 W/kg when the transmission band is ≤ 100 MHz
  - ≤ 0.6 W/kg when the transmission band is between 100 MHz and 200 MHz
  - ≤ 0.4 W/kg when the transmission band is ≥ 200 MHz

**14.1.2 Body w/ 1.0 cm (body-worn accessory & hotspot mode)**

R99 12.2kbps RMC – Duty Cycle 100%								
Test Position	Ch#	Freq. [MHz]	Power [dBm]		1 g SAR [W/kg]		Plot No.	Note
			Tune-up Limit	Meas.	Meas.	Scaled		
Top Edge	4132	826.4						3
	4182	836.4						3
	4233	846.6						3
Bottom Edge	4132	826.4						1
	4182	836.4	24.2	23.06	0.103	<b>0.134</b>		
	4233	846.6						1
Left Edge	4132	826.4						1
	4182	836.4	24.2	23.06	0.221	<b>0.287</b>		
	4233	846.6						1
Right Edge	4132	826.4						1
	4182	836.4	24.2	23.06	0.303	<b>0.394</b>		
	4233	846.6						1
Front Side	4132	826.4						1
	4182	836.4	24.2	23.06	0.404	<b>0.525</b>		
	4233	846.6						1
Rear Side	4132	826.4						1
	4182	836.4	24.2	23.06	0.500	<b>0.650</b>	2	
	4233	846.6						1

NOTE(S) :

- KDB 447498 D01 – Testing of other required channels within the operating mode of a frequency band is not required when the reported 1 g SAR for the mid-band or highest output power channel is:
  - ≤ 0.8 W/kg when the transmission band is ≤ 100 MHz
  - ≤ 0.6 W/kg when the transmission band is between 100 MHz and 200 MHz
  - ≤ 0.4 W/kg when the transmission band is ≥ 200 MHz
- KDB 648474 D04 – When the reported SAR for a body-worn accessory, measured without a headset connected to the handset, is > 1.2 W/kg, the highest reported SAR configuration for that wireless mode and frequency band is repeated for that body-worn accessory with a headset attached to the handset.
- KDB 941225 D06 – SAR is not required because the distance from the transmitting antenna to this surface (or edge) is greater than 2.5 cm.



## 14.2 GSM 850

### 14.2.1 Head

GPRS 4 slot (CS1) – Duty Cycle 48.0%								
Test Position	Ch#	Freq. [MHz]	Power [dBm]		1 g SAR [W/kg]		Plot No.	Note
			Tune-up Limit	Meas.	Meas.	Scaled		
Left Touched	128	824.2						1
	189	836.4	28.2	27.60	0.306	<b>0.351</b>		
	251	848.8						1
Left Tilted	128	824.2						1
	189	836.4	28.2	27.60	0.176	<b>0.202</b>		
	251	848.8						1
Right Touched	128	824.2						1
	189	836.4	28.2	27.60	0.344	<b>0.395</b>	3	
	251	848.8						1
Right Tilted	128	824.2						1
	189	836.4	28.2	27.60	0.160	<b>0.184</b>		
	251	848.8						1

NOTE(S) :

- KDB 447498 D01 – Testing of other required channels within the operating mode of a frequency band is not required when the reported 1 g SAR for the mid-band or highest output power channel is:
  - ≤ 0.8 W/kg when the transmission band is ≤ 100 MHz
  - ≤ 0.6 W/kg when the transmission band is between 100 MHz and 200 MHz
  - ≤ 0.4 W/kg when the transmission band is ≥ 200 MHz

**14.2.2 Body w/ 1.0 cm (body-worn accessory & hotspot mode)**

GPRS 4 slot (CS1) – Duty Cycle 48.0%								
Test Position	Ch#	Freq. [MHz]	Power [dBm]		1 g SAR [W/kg]		Plot No.	Note
			Tune-up Limit	Meas.	Meas.	Scaled		
Top Edge	128	824.2						3
	189	836.4						3
	251	848.8						3
Bottom Edge	128	824.2						1
	189	836.4	28.2	27.60	0.112	<b>0.129</b>		
	251	848.8						1
Left Edge	128	824.2						1
	189	836.4	28.2	27.60	0.241	<b>0.277</b>		
	251	848.8						1
Right Edge	128	824.2						1
	189	836.4	28.2	27.60	0.347	<b>0.398</b>		
	251	848.8						1
Front Side	128	824.2						1
	189	836.4	28.2	27.60	0.441	<b>0.506</b>		
	251	848.8						1
Rear Side	128	824.2						1
	189	836.4	28.2	27.60	0.589	<b>0.676</b>	4	
	251	848.8						1

NOTE(S) :

- KDB 447498 D01 – Testing of other required channels within the operating mode of a frequency band is not required when the reported 1 g SAR for the mid-band or highest output power channel is:
  - ≤ 0.8 W/kg when the transmission band is ≤ 100 MHz
  - ≤ 0.6 W/kg when the transmission band is between 100 MHz and 200 MHz
  - ≤ 0.4 W/kg when the transmission band is ≥ 200 MHz
- KDB 648474 D04 – When the reported SAR for a body-worn accessory, measured without a headset connected to the handset, is > 1.2 W/kg, the highest reported SAR configuration for that wireless mode and frequency band is repeated for that body-worn accessory with a headset attached to the handset.
- KDB 941225 D06 – SAR is not required because the distance from the transmitting antenna to this surface (or edge) is greater than 2.5 cm.

### 14.3 PCS 1900

#### 14.3.1 Head

GPRS 4 slot (CS1) – Duty Cycle 48.0%								
Test Position	Ch#	Freq. [MHz]	Power [dBm]		1 g SAR [W/kg]		Plot No.	Note
			Tune-up Limit	Meas.	Meas.	Scaled		
Left Touched	512	1850.2						1
	661	1880.0	25.4	24.85	0.279	<b>0.317</b>	5	
	810	1909.8						1
Left Tilted	512	1850.2						1
	661	1880.0	25.4	24.85	0.030	<b>0.034</b>		
	810	1909.8						1
Right Touched	512	1850.2						1
	661	1880.0	25.4	24.85	0.180	<b>0.204</b>		
	810	1909.8						1
Right Tilted	512	1850.2						1
	661	1880.0	25.4	24.85	0.029	<b>0.033</b>		
	810	1909.8						1

NOTE(S) :

- KDB 447498 D01 – Testing of other required channels within the operating mode of a frequency band is not required when the reported 1 g SAR for the mid-band or highest output power channel is:
  - ≤ 0.8 W/kg when the transmission band is ≤ 100 MHz
  - ≤ 0.6 W/kg when the transmission band is between 100 MHz and 200 MHz
  - ≤ 0.4 W/kg when the transmission band is ≥ 200 MHz

**14.3.2 Body w/ 1.0 cm (body-worn accessory & hotspot mode)**

GPRS 4 slot (CS1) – Duty Cycle 48.0%								
Test Position	Ch#	Freq. [MHz]	Power [dBm]		1 g SAR [W/kg]		Plot No.	Note
			Tune-up Limit	Meas.	Meas.	Scaled		
Top Edge	512	1850.2						3
	661	1880.0						3
	810	1909.8						3
Bottom Edge	512	1850.2						1
	661	1880.0	25.4	24.85	0.375	<b>0.426</b>		
	810	1909.8						1
Left Edge	512	1850.2						1
	661	1880.0	25.4	24.85	0.200	<b>0.227</b>		
	810	1909.8						1
Right Edge	512	1850.2						1
	661	1880.0	25.4	24.85	0.049	<b>0.056</b>		
	810	1909.8						1
Front Side	512	1850.2						1
	661	1880.0	25.4	24.85	0.296	<b>0.336</b>		
	810	1909.8						1
Rear Side	512	1850.2						1
	661	1880.0	25.4	24.85	0.397	<b>0.451</b>	6	
	810	1909.8						1

NOTE(S) :

- KDB 447498 D01 – Testing of other required channels within the operating mode of a frequency band is not required when the reported 1 g SAR for the mid-band or highest output power channel is:
  - ≤ 0.8 W/kg when the transmission band is ≤ 100 MHz
  - ≤ 0.6 W/kg when the transmission band is between 100 MHz and 200 MHz
  - ≤ 0.4 W/kg when the transmission band is ≥ 200 MHz
- KDB 648474 D04 – When the reported SAR for a body-worn accessory, measured without a headset connected to the handset, is > 1.2 W/kg, the highest reported SAR configuration for that wireless mode and frequency band is repeated for that body-worn accessory with a headset attached to the handset.
- KDB 941225 D06 – SAR is not required because the distance from the transmitting antenna to this surface (or edge) is greater than 2.5 cm.

## 14.4 WLAN 2.4 GHz

### 14.4.1 Head

802.11b (1 Mbps) – Duty Cycle 100%								
Test Position	Ch#	Freq. [MHz]	Power [dBm]		1 g SAR [W/kg]		Plot No.	Note
			Tune-up Limit	Meas.	Meas.	Scaled		
Left Touched	1	2412	15.0	13.02	0.082	<b>0.129</b>		
	6	2437						1
	11	2462						1
Left Tilted	1	2412	15.0	13.02	0.057	<b>0.090</b>		
	6	2437						1
	11	2462						1
Right Touched	1	2412	15.0	13.02	0.255	<b>0.402</b>	7	
	6	2437						1
	11	2462						1
Right Tilted	1	2412	15.0	13.02	0.102	<b>0.161</b>		
	6	2437						1
	11	2462						1

NOTE(S) :

- KDB 447498 D01 – Testing of other required channels within the operating mode of a frequency band is not required when the reported 1 g SAR for the mid-band or highest output power channel is:
  - ≤ 0.8 W/kg when the transmission band is ≤ 100 MHz
  - ≤ 0.6 W/kg when the transmission band is between 100 MHz and 200 MHz
  - ≤ 0.4 W/kg when the transmission band is ≥ 200 MHz

**14.4.2 Body w/ 1.0 cm (body-worn accessory & hotspot mode)**

802.11b (1 Mbps) – Duty Cycle 100%								
Test Position	Ch#	Freq. [MHz]	Power [dBm]		1 g SAR [W/kg]		Plot No.	Note
			Tune-up Limit	Meas.	Meas.	Scaled		
Top Edge	1	2412	15.0	13.02	0.009	<b>0.014</b>		
	6	2437						1
	11	2462						1
Bottom Edge	1	2412						3
	6	2437						3
	11	2462						3
Left Edge	1	2412	15.0	13.02	0.088	<b>0.139</b>		
	6	2437						1
	11	2462						1
Right Edge	1	2412						3
	6	2437						3
	11	2462						3
Front Side	1	2412	15.0	13.02	0.047	<b>0.074</b>		
	6	2437						1
	11	2462						1
Rear Side	1	2412	15.0	13.02	0.115	<b>0.181</b>	8	
	6	2437						1
	11	2462						1

NOTE(S) :

- KDB 447498 D01 – Testing of other required channels within the operating mode of a frequency band is not required when the reported 1 g SAR for the mid-band or highest output power channel is:
  - ≤ 0.8 W/kg when the transmission band is ≤ 100 MHz
  - ≤ 0.6 W/kg when the transmission band is between 100 MHz and 200 MHz
  - ≤ 0.4 W/kg when the transmission band is ≥ 200 MHz
- KDB 648474 D04 – When the reported SAR for a body-worn accessory, measured without a headset connected to the handset, is > 1.2 W/kg, the highest reported SAR configuration for that wireless mode and frequency band is repeated for that body-worn accessory with a headset attached to the handset.
- KDB 941225 D06 – SAR is not required because the distance from the transmitting antenna to this surface (or edge) is greater than 2.5 cm.

## 14.5 WLAN 5.2 GHz

### 14.5.1 Head

802.11a (6 Mbps) – Duty Cycle 100%								
Test Position	Ch#	Freq. [MHz]	Power [dBm]		1 g SAR [W/kg]		Plot No.	Note
			Tune-up Limit	Meas.	Meas.	Scaled		
Left Touched	36	5180						1
	48	5240	11.5	9.71	< 0.001	<b>&lt; 0.001</b>		
Left Tilted	36	5180						1
	48	5240	11.5	9.71	< 0.001	<b>&lt; 0.001</b>		
Right Touched	36	5180						1
	48	5240	11.5	9.71	0.167	<b>0.252</b>	9	
Right Tilted	36	5180						1
	48	5240	11.5	9.71	0.049	<b>0.074</b>		

NOTE(S) :

- KDB 447498 D01 – Testing of other required channels within the operating mode of a frequency band is not required when the reported 1 g SAR for the mid-band or highest output power channel is:
  - ≤ 0.8 W/kg when the transmission band is ≤ 100 MHz
  - ≤ 0.6 W/kg when the transmission band is between 100 MHz and 200 MHz
  - ≤ 0.4 W/kg when the transmission band is ≥ 200 MHz

### 14.5.2 Body w/ 1.0 cm (body-worn accessory mode)

802.11a (6 Mbps) – Duty Cycle 100%								
Test Position	Ch#	Freq. [MHz]	Power [dBm]		1 g SAR [W/kg]		Plot No.	Note
			Tune-up Limit	Meas.	Meas.	Scaled		
Front Side	36	5180						1
	48	5240	11.5	9.71	< 0.001	<b>&lt; 0.001</b>		
Rear Side	36	5180						1
	48	5240	11.5	9.71	0.143	<b>0.216</b>	10	

NOTE(S) :

- KDB 447498 D01 – Testing of other required channels within the operating mode of a frequency band is not required when the reported 1 g SAR for the mid-band or highest output power channel is:
  - ≤ 0.8 W/kg when the transmission band is ≤ 100 MHz
  - ≤ 0.6 W/kg when the transmission band is between 100 MHz and 200 MHz
  - ≤ 0.4 W/kg when the transmission band is ≥ 200 MHz
- KDB 648474 D04 – When the reported SAR for a body-worn accessory, measured without a headset connected to the handset, is > 1.2 W/kg, the highest reported SAR configuration for that wireless mode and frequency band is repeated for that body-worn accessory with a headset attached to the handset.

## 14.6 WLAN 5.3 GHz

### 14.6.1 Head

802.11a (6 Mbps) – Duty Cycle 100%								
Test Position	Ch#	Freq. [MHz]	Power [dBm]		1 g SAR [W/kg]		Plot No.	Note
			Tune-up Limit	Meas.	Meas.	Scaled		
Left Touched	52	5260						1
	60	5300	11.5	9.57	< 0.001	< 0.001		
Left Tilted	52	5260						1
	60	5300	11.5	9.57	< 0.001	< 0.001		
Right Touched	52	5260						1
	60	5300	11.5	9.57	0.168	0.262	11	
Right Tilted	52	5260						1
	60	5300	11.5	9.57	0.078	0.122		

NOTE(S) :

- KDB 447498 D01 – Testing of other required channels within the operating mode of a frequency band is not required when the reported 1 g SAR for the mid-band or highest output power channel is:
  - ≤ 0.8 W/kg when the transmission band is ≤ 100 MHz
  - ≤ 0.6 W/kg when the transmission band is between 100 MHz and 200 MHz
  - ≤ 0.4 W/kg when the transmission band is ≥ 200 MHz

### 14.6.2 Body w/ 1.0 cm (body-worn accessory mode)

802.11a (6 Mbps) – Duty Cycle 100%								
Test Position	Ch#	Freq. [MHz]	Power [dBm]		1 g SAR [W/kg]		Plot No.	Note
			Tune-up Limit	Meas.	Meas.	Scaled		
Front Side	52	5260						1
	60	5300	11.5	9.57	< 0.001	< 0.001		
Rear Side	52	5260						1
	60	5300	11.5	9.57	0.120	0.187	12	

NOTE(S) :

- KDB 447498 D01 – Testing of other required channels within the operating mode of a frequency band is not required when the reported 1 g SAR for the mid-band or highest output power channel is:
  - ≤ 0.8 W/kg when the transmission band is ≤ 100 MHz
  - ≤ 0.6 W/kg when the transmission band is between 100 MHz and 200 MHz
  - ≤ 0.4 W/kg when the transmission band is ≥ 200 MHz
- KDB 648474 D04 – When the reported SAR for a body-worn accessory, measured without a headset connected to the handset, is > 1.2 W/kg, the highest reported SAR configuration for that wireless mode and frequency band is repeated for that body-worn accessory with a headset attached to the handset.



## 14.7 WLAN 5.6 GHz

### 14.7.1 Head

802.11a (6 Mbps) – Duty Cycle 100%								
Test Position	Ch#	Freq. [MHz]	Power [dBm]		1 g SAR [W/kg]		Plot No.	Note
			Tune-up Limit	Meas.	Meas.	Scaled		
Left Touched	120	5520						1
	116	5580						1
	124	5620						2
	140	5700	11.5	9.92	0.048	<b>0.069</b>		
Left Tilted	120	5520						1
	116	5580						1
	124	5620						2
	140	5700	11.5	9.92	< 0.001	<b>&lt; 0.001</b>		
Right Touched	120	5520						1
	116	5580						1
	124	5620						2
	140	5700	11.5	9.92	0.263	<b>0.378</b>	13	
Right Tilted	120	5520						1
	116	5580						1
	124	5620						2
	140	5700	11.5	9.92	0.050	<b>0.072</b>		

NOTE(S) :

- KDB 447498 D01 – Testing of other required channels within the operating mode of a frequency band is not required when the reported 1 g SAR for the mid-band or highest output power channel is:
  - ≤ 0.8 W/kg when the transmission band is ≤ 100 MHz
  - ≤ 0.6 W/kg when the transmission band is between 100 MHz and 200 MHz
  - ≤ 0.4 W/kg when the transmission band is ≥ 200 MHz
- KDB 443999 D01 – Transmissions in the 5600 to 5650 MHz band are disabled.

**14.7.2 Body w/ 1.0 cm (body-worn accessory mode)**

802.11a (6 Mbps) – Duty Cycle 100%								
Test Position	Ch#	Freq. [MHz]	Power [dBm]		1 g SAR [W/kg]		Plot No.	Note
			Tune-up Limit	Meas.	Meas.	Scaled		
Front Side	120	5520						1
	116	5580						1
	124	5620						3
	140	5700	11.5	9.92	< 0.001	< 0.001		
Rear Side	120	5520						1
	116	5580						1
	124	5620						3
	140	5700	11.5	9.92	0.164	0.236	14	

NOTE(S) :

- KDB 447498 D01 – Testing of other required channels within the operating mode of a frequency band is not required when the reported 1 g SAR for the mid-band or highest output power channel is:
  - ≤ 0.8 W/kg when the transmission band is ≤ 100 MHz
  - ≤ 0.6 W/kg when the transmission band is between 100 MHz and 200 MHz
  - ≤ 0.4 W/kg when the transmission band is ≥ 200 MHz
- KDB 648474 D04 – When the reported SAR for a body-worn accessory, measured without a headset connected to the handset, is > 1.2 W/kg, the highest reported SAR configuration for that wireless mode and frequency band is repeated for that body-worn accessory with a headset attached to the handset.
- KDB 443999 D01 – Transmissions in the 5600 to 5650 MHz band are disabled.

## 14.8 Simultaneous Transmission SAR Analysis (KDB 447498 D01)

### 14.8.1 Simultaneous Transmission

WWAN can transmit simultaneously with WLAN/Bluetooth.

WLAN in 2.4 GHz and 5 GHz bands cannot transmit simultaneously with Bluetooth.

No.	Conditions	Head	Body	Hotspot
1	WCDMA Band V + WLAN 2.4 GHz	YES	YES	YES
2	GSM 850 + WLAN 2.4 GHz	YES	YES	YES
3	PCS 1900 + WLAN 2.4 GHz	YES	YES	YES
4	WCDMA Band V + WLAN 5 GHz	YES	YES	NO
5	GSM 850 + WLAN 5 GHz	YES	YES	NO
6	PCS 1900 + WLAN 5 GHz	YES	YES	NO
7	WCDMA Band V + Bluetooth	YES	YES	NO
8	GSM 850 + Bluetooth	YES	YES	NO
9	PCS 1900 + Bluetooth	YES	YES	NO

The device is capable of personal hotspot mode with WLAN in 2.4 GHz band.

However, the 5 GHz bands do not support hotspot mode.

### 14.8.2 Antenna Separation Distances

WWAN to WLAN/Bluetooth : 88.2 mm

### 14.8.3 Standalone SAR Estimation

When standalone SAR test exclusion applies to an antenna that transmits simultaneously with other antennas, the standalone SAR must be estimated according to following to determine simultaneous transmission SAR test exclusion:

$[(\text{max. power of channel, including tune-up tolerance, mW}) / (\text{min. test separation distance, mm})] \cdot$

$[\sqrt{f_{(\text{GHz})} / 7.5}] \text{ W/kg for 1 g SAR, test separation distances} \leq 50 \text{ mm}$

When the minimum test separation distance is < 5 mm, a distance of 5 mm is applied.

Band	Frequency (MHz)	Max. Power		Test Position	Distance (mm)	Estimated SAR (W/kg)
		(dBm)	(mW)			
Bluetooth	2480	4.0	3	Head	< 5	0.126
				Body	10	0.063

#### 14.8.4 Sum of the SAR for WWAN + WLAN 2.4 GHz

##### 14.8.4.1 Head

##### Sum of the SAR with Measured Values

Test Position	Highest 1 g SAR (W/kg)			Σ 1 g SAR (W/kg)
	WWAN		WLAN 2.4 GHz	
Left Touched	WCDMA Band V	0.377	0.129	<b>0.506</b>
	GSM 850	0.351	0.129	<b>0.480</b>
	PCS1900	0.317	0.129	<b>0.446</b>
Left Tilted	WCDMA Band V	0.224	0.090	<b>0.314</b>
	GSM 850	0.202	0.090	<b>0.292</b>
	PCS1900	0.034	0.090	<b>0.124</b>
Right Touched	WCDMA Band V	0.394	0.402	<b>0.796</b>
	GSM 850	0.395	0.402	<b>0.797</b>
	PCS1900	0.204	0.402	<b>0.606</b>
Right Tilted	WCDMA Band V	0.200	0.161	<b>0.361</b>
	GSM 850	0.184	0.161	<b>0.345</b>
	PCS1900	0.033	0.161	<b>0.194</b>

##### SAR to Peak Location Separation Ratio (SPLSR)

As the sum of the 1 g SAR is < 1.6 W/kg, SPLSR assessment is not required.

##### Conclusion:

Simultaneous transmission SAR measurement (Volume Scan) is not required because the sum of the 1 g SAR is < 1.6 W/kg.

**14.8.4.2 Body w/ 1.0 cm (body-worn accessory & hotspot mode)**

**Sum of the SAR with Measured Values**

Test Position	Highest 1 g SAR (W/kg)			$\Sigma$ 1 g SAR (W/kg)
	WWAN		WLAN 2.4 GHz	
Top Edge	WCDMA Band V	N/A	0.014	<b>N/A</b>
	GSM 850	N/A	0.014	<b>N/A</b>
	PCS1900	N/A	0.014	<b>N/A</b>
Bottom Edge	WCDMA Band V	0.134	N/A	<b>N/A</b>
	GSM 850	0.129	N/A	<b>N/A</b>
	PCS1900	0.426	N/A	<b>N/A</b>
Left Edge	WCDMA Band V	0.287	0.139	<b>0.426</b>
	GSM 850	0.277	0.139	<b>0.416</b>
	PCS1900	0.227	0.139	<b>0.366</b>
Right Edge	WCDMA Band V	0.394	N/A	<b>N/A</b>
	GSM 850	0.398	N/A	<b>N/A</b>
	PCS1900	0.056	N/A	<b>N/A</b>
Front Side	WCDMA Band V	0.525	0.074	<b>0.599</b>
	GSM 850	0.506	0.074	<b>0.580</b>
	PCS1900	0.336	0.074	<b>0.410</b>
Rear Side	WCDMA Band V	0.650	0.181	<b>0.831</b>
	GSM 850	0.676	0.181	<b>0.857</b>
	PCS1900	0.451	0.181	<b>0.632</b>

**SAR to Peak Location Separation Ratio (SPLSR)**

As the sum of the 1 g SAR is < 1.6 W/kg, SPLSR assessment is not required.

**Conclusion:**

Simultaneous transmission SAR measurement (Volume Scan) is not required because the sum of the 1 g SAR is < 1.6 W/kg.

### 14.8.5 Sum of the SAR for WWAN + WLAN 5.2 GHz

#### 14.8.5.1 Head

##### Sum of the SAR with Measured Values

Test Position	Highest 1 g SAR (W/kg)			Σ 1 g SAR (W/kg)
	WWAN		WLAN 5.2 GHz	
Left Touched	WCDMA Band V	0.377	0.000	<b>0.377</b>
	GSM 850	0.351	0.000	<b>0.351</b>
	PCS1900	0.317	0.000	<b>0.317</b>
Left Tilted	WCDMA Band V	0.224	0.000	<b>0.224</b>
	GSM 850	0.202	0.000	<b>0.202</b>
	PCS1900	0.034	0.000	<b>0.034</b>
Right Touched	WCDMA Band V	0.394	0.252	<b>0.646</b>
	GSM 850	0.395	0.252	<b>0.647</b>
	PCS1900	0.204	0.252	<b>0.456</b>
Right Tilted	WCDMA Band V	0.200	0.074	<b>0.274</b>
	GSM 850	0.184	0.074	<b>0.258</b>
	PCS1900	0.033	0.074	<b>0.107</b>

##### SAR to Peak Location Separation Ratio (SPLSR)

As the sum of the 1 g SAR is < 1.6 W/kg, SPLSR assessment is not required.

##### Conclusion:

Simultaneous transmission SAR measurement (Volume Scan) is not required because the sum of the 1 g SAR is < 1.6 W/kg.

**14.8.5.2 Body w/ 1.0 cm (body-worn accessory mode)**

**Sum of the SAR with Measured Values**

Test Position	Highest 1 g SAR (W/kg)			Σ 1 g SAR (W/kg)
	WWAN		WLAN 5.2 GHz	
Front Side	WCDMA Band V	0.525	0.000	<b>0.525</b>
	GSM 850	0.506	0.000	<b>0.506</b>
	PCS1900	0.336	0.000	<b>0.336</b>
Rear Side	WCDMA Band V	0.650	0.216	<b>0.866</b>
	GSM 850	0.676	0.216	<b>0.892</b>
	PCS1900	0.451	0.216	<b>0.667</b>

**SAR to Peak Location Separation Ratio (SPLSR)**

As the sum of the 1 g SAR is < 1.6 W/kg, SPLSR assessment is not required.

**Conclusion:**

Simultaneous transmission SAR measurement (Volume Scan) is not required because the sum of the 1 g SAR is < 1.6 W/kg.

### 14.8.6 Sum of the SAR for WWAN + WLAN 5.3 GHz

#### 14.8.6.1 Head

##### Sum of the SAR with Measured Values

Test Position	Highest 1 g SAR (W/kg)			Σ 1 g SAR (W/kg)
	WWAN		WLAN 5.3 GHz	
Left Touched	WCDMA Band V	0.377	0.000	<b>0.377</b>
	GSM 850	0.351	0.000	<b>0.351</b>
	PCS1900	0.317	0.000	<b>0.317</b>
Left Tilted	WCDMA Band V	0.224	0.000	<b>0.224</b>
	GSM 850	0.202	0.000	<b>0.202</b>
	PCS1900	0.034	0.000	<b>0.034</b>
Right Touched	WCDMA Band V	0.394	0.262	<b>0.656</b>
	GSM 850	0.395	0.262	<b>0.657</b>
	PCS1900	0.204	0.262	<b>0.466</b>
Right Tilted	WCDMA Band V	0.200	0.122	<b>0.322</b>
	GSM 850	0.184	0.122	<b>0.306</b>
	PCS1900	0.033	0.122	<b>0.155</b>

##### SAR to Peak Location Separation Ratio (SPLSR)

As the sum of the 1 g SAR is < 1.6 W/kg, SPLSR assessment is not required.

##### Conclusion:

Simultaneous transmission SAR measurement (Volume Scan) is not required because the sum of the 1 g SAR is < 1.6 W/kg.



**14.8.6.2 Body w/ 1.0 cm (body-worn accessory mode)**

**Sum of the SAR with Measured Values**

Test Position	Highest 1 g SAR (W/kg)			Σ 1 g SAR (W/kg)
	WWAN		WLAN 5.3 GHz	
Front Side	WCDMA Band V	0.525	0.000	<b>0.525</b>
	GSM 850	0.506	0.000	<b>0.506</b>
	PCS1900	0.336	0.000	<b>0.336</b>
Rear Side	WCDMA Band V	0.650	0.187	<b>0.837</b>
	GSM 850	0.676	0.187	<b>0.863</b>
	PCS1900	0.451	0.187	<b>0.638</b>

**SAR to Peak Location Separation Ratio (SPLSR)**

As the sum of the 1 g SAR is < 1.6 W/kg, SPLSR assessment is not required.

**Conclusion:**

Simultaneous transmission SAR measurement (Volume Scan) is not required because the sum of the 1 g SAR is < 1.6 W/kg.

### 14.8.7 Sum of the SAR for WWAN + WLAN 5.6 GHz

#### 14.8.7.1 Head

##### Sum of the SAR with Measured Values

Test Position	Highest 1 g SAR (W/kg)			Σ 1 g SAR (W/kg)
	WWAN		WLAN 5.6 GHz	
Left Touched	WCDMA Band V	0.377	0.069	<b>0.446</b>
	GSM 850	0.351	0.069	<b>0.420</b>
	PCS1900	0.317	0.069	<b>0.386</b>
Left Tilted	WCDMA Band V	0.224	0.000	<b>0.224</b>
	GSM 850	0.202	0.000	<b>0.202</b>
	PCS1900	0.034	0.000	<b>0.034</b>
Right Touched	WCDMA Band V	0.394	0.378	<b>0.772</b>
	GSM 850	0.395	0.378	<b>0.773</b>
	PCS1900	0.204	0.378	<b>0.582</b>
Right Tilted	WCDMA Band V	0.200	0.072	<b>0.272</b>
	GSM 850	0.184	0.072	<b>0.256</b>
	PCS1900	0.033	0.072	<b>0.105</b>

##### SAR to Peak Location Separation Ratio (SPLSR)

As the sum of the 1 g SAR is < 1.6 W/kg, SPLSR assessment is not required.

##### Conclusion:

Simultaneous transmission SAR measurement (Volume Scan) is not required because the sum of the 1 g SAR is < 1.6 W/kg.

**14.8.7.2 Body w/ 1.0 cm (body-worn accessory mode)**

**Sum of the SAR with Measured Values**

Test Position	Highest 1 g SAR (W/kg)			Σ 1 g SAR (W/kg)
	WWAN		WLAN 5.6 GHz	
Front Side	WCDMA Band V	0.525	0.000	<b>0.525</b>
	GSM 850	0.506	0.000	<b>0.506</b>
	PCS1900	0.336	0.000	<b>0.336</b>
Rear Side	WCDMA Band V	0.650	0.236	<b>0.886</b>
	GSM 850	0.676	0.236	<b>0.912</b>
	PCS1900	0.451	0.236	<b>0.687</b>

**SAR to Peak Location Separation Ratio (SPLSR)**

As the sum of the 1 g SAR is < 1.6 W/kg, SPLSR assessment is not required.

**Conclusion:**

Simultaneous transmission SAR measurement (Volume Scan) is not required because the sum of the 1 g SAR is < 1.6 W/kg.

### 14.8.8 Sum of the SAR for WWAN + Bluetooth

#### 14.8.8.1 Head

##### Sum of the SAR with Measured Values

Test Position	Highest 1 g SAR (W/kg)		Σ 1 g SAR (W/kg)	
	WWAN	Bluetooth		
Left Touched	WCDMA Band V	0.377	0.126	<b>0.503</b>
	GSM 850	0.351	0.126	<b>0.477</b>
	PCS1900	0.317	0.126	<b>0.443</b>
Left Tilted	WCDMA Band V	0.224	0.126	<b>0.350</b>
	GSM 850	0.202	0.126	<b>0.328</b>
	PCS1900	0.034	0.126	<b>0.160</b>
Right Touched	WCDMA Band V	0.394	0.126	<b>0.520</b>
	GSM 850	0.395	0.126	<b>0.521</b>
	PCS1900	0.204	0.126	<b>0.330</b>
Right Tilted	WCDMA Band V	0.200	0.126	<b>0.326</b>
	GSM 850	0.184	0.126	<b>0.310</b>
	PCS1900	0.033	0.126	<b>0.159</b>

##### SAR to Peak Location Separation Ratio (SPLSR)

As the sum of the 1 g SAR is < 1.6 W/kg, SPLSR assessment is not required.

##### Conclusion:

Simultaneous transmission SAR measurement (Volume Scan) is not required because the sum of the 1 g SAR is < 1.6 W/kg.

**14.8.8.2 Body w/ 1.0 cm (body-worn accessory mode)****Sum of the SAR with Measured Values**

Test Position	Highest 1 g SAR (W/kg)			$\Sigma$ 1 g SAR (W/kg)
	WWAN		Bluetooth	
Front Side	WCDMA Band V	0.525	0.063	<b>0.588</b>
	GSM 850	0.506	0.063	<b>0.569</b>
	PCS1900	0.336	0.063	<b>0.399</b>
Rear Side	WCDMA Band V	0.650	0.063	<b>0.713</b>
	GSM 850	0.676	0.063	<b>0.739</b>
	PCS1900	0.451	0.063	<b>0.514</b>

**SAR to Peak Location Separation Ratio (SPLSR)**

As the sum of the 1 g SAR is < 1.6 W/kg, SPLSR assessment is not required.

**Conclusion:**

Simultaneous transmission SAR measurement (Volume Scan) is not required because the sum of the 1 g SAR is < 1.6 W/kg.

## 16 Test Instruments

Type	Model	Manufacturer	ID No.	Last Cal.	Interval
E-Field Probe	EX3DV4 (SN 3540)	SPEAG	--	2013/8	1 Year
DAE	DAE4	SPEAG	S-3	2012/11	1 Year
DAE	DAE4 (SN 516)	SPEAG	--	2013/5	1 Year
Robot	RX60L	SPEAG	S-7	-----	N/A
Probe Alignment Unit	LB1RX60L	SPEAG	S-13	-----	N/A
Network Analyzer	8719ET	Agilent	B-53	2012/9	1 Year
Dielectric Probe	DAK-3.5	SPEAG	S-32	2013/7	1 Year
835MHz Dipole	D835V2	SPEAG	S-23	2013/8	1 Year
1900MHz Dipole	D1900V2	SPEAG	S-25	2013/8	1 Year
2450MHz Dipole	D2450V2	SPEAG	S-6	2012/11	1 Year
5GHz Dipole	D5GHzV2 (SN 1039)	SPEAG	--	2013/5	1 Year
Signal Generator	MG3681A	Anritsu	B-3	2013/9	1 Year
Signal Generator	N5181A	Agilent	B-4	2012/12	1 Year
Signal Generator	MG3710A	Anritsu	B-41	2013/9	1 Year
RF Power Amplifier	CGA020M602-2633R	R&K	A-51	-----	N/A
Directional Coupler	4226-20	Narda	D-87	-----	N/A
Radio Communication Analyzer	MT8820C	Anritsu	B-5	2013/2	1 Year
Power Meter	E4417A	Agilent	B-51	2013/6	1 Year
Power Sensor	E9323A	Agilent	B-59	2013/6	1 Year
Power Meter	N1911A	Agilent	B-63	2013/7	1 Year
Power Sensor	N1921A	Agilent	B-64	2013/7	1 Year
Attenuator	54A-10	Weinschel	D-28	2012/9	1 Year
Attenuator	2-20	Weinschel	D-36	2012/9	1 Year

**17 Appendix**

Refer to separated files for the following appendixes.

**Appendix 1 – System Performance Check Plots**

**Appendix 2 – Highest SAR Test Plots**

**Appendix 3 – Dosimetric E-Field Probe Calibration Data**

**Appendix 4 – System Validation Dipole Calibration Data**