

TEST REPORT

Applicant : Sharp Corporation, Communication Systems Division
Address : 2-13-1, Iida Hachihonmatsu, Higashi-Hiroshima City, Hiroshima,
739-0192, JAPAN

Products : Cellular Phone
Model No. : SH-01F
Serial No. : 004401114935196
004401114935162

FCC ID : APYHRO00197

Test Standard : CFR 47 FCC Rules and Regulations Part 22

Test Results : **Passed**

Date of Test : September 13 ~ 24, 2013



A handwritten signature in black ink, appearing to read 'K. Shibata', written over a horizontal line.

Kousei Shibata
Manager
Japan Quality Assurance Organization
KITA-KANSAI Testing Center
SAITO EMC Branch
7-3-10, Saito-asagi, Ibaraki-shi, Osaka 567-0085, Japan

- The measurement values stated in Test Report was made with traceable to National Institute of Advanced Industrial Science and Technology (AIST) of Japan and National Institute of Information and Communications Technology (NICT) of Japan.
- The applicable standard, testing condition and testing method which were used for the tests are based on the request of the applicant.
- The test results presented in this report relate only to the offered test sample.
- The contents of this test report cannot be used for the purposes, such as advertisement for consumers.
- This test report shall not be reproduced except in full without the written approval of JQA.
- VLAC does not approve, certify or warrant the product by this test report.

TABLE OF CONTENTS

	Page
1 Description of the Equipment Under Test.....	3
2 Summary of Test Results.....	4
3 Test Procedure.....	5
4 Test Location.....	5
5 Recognition of Test Laboratory.....	5
6 Details of the Equipment Under Test.....	6
7 Details of the Test Item.....	9

DEFINITIONS FOR ABBREVIATION AND SYMBOLS USED IN THIS TEST REPORT**EUT** : Equipment Under Test**EMC** : Electromagnetic Compatibility**AE** : Associated Equipment**EMI** : Electromagnetic Interference**N/A** : Not Applicable**EMS** : Electromagnetic Susceptibility**N/T** : Not Tested - indicates that the listed condition, standard or equipment is applicable for this report. - indicates that the listed condition, standard or equipment is not applicable for this report.

1 Description of the Equipment Under Test

1. Manufacturer : Sharp Corporation, Communication Systems Division
2-13-1, Iida Hachihonmatsu, Higashi-Hiroshima City, Hiroshima,
739-0192, JAPAN
2. Products : Cellular Phone
3. Model No. : SH-01F
4. Serial No. : 004401114935196
: 004401114935162
5. Product Type : Pre-production
6. Date of Manufacture : August, 2013
7. Power Rating : 4.0VDC (Lithium-ion Battery LIS1531SPPC(SY6) 3000mAh)
8. EUT Grounding : None
9. Transmitting Frequency : 824.2 MHz(128CH) – 848.8 MHz(251CH)
10. Receiving Frequency : 869.2 MHz(128CH) – 893.8 MHz(251CH)
11. Emission Designations : 245KGXW
12. Max. RF Output Power : 1.202W (ERP)
13. Category : GSM850
14. EUT Authorization : Certification
15. Received Date of EUT : September 11, 2013

16. Channel Plan

The carrier spacing is 200 kHz.

The carrier frequency is designated by the absolute frequency channel number (ARFCN).

The carrier frequency is expressed in the equation shown as follows:

$$\text{Transmitting Frequency (in MHz)} = 824.2 + 0.2 \times (n - 128)$$

where, n : channel number ($128 \leq n \leq 251$)

$$\text{Receiving Frequency (in MHz)} = 869.2 + 0.2 \times (n - 128)$$

where, n : channel number ($128 \leq n \leq 251$)

2 Summary of Test Results

Applied Standard : CFR 47 FCC Rules and Regulations Part 22
Subpart H – Cellular Radiotelephone Service

The EUT described in clause 1 was tested according to the applied standard shown above.
Details of the test configuration is shown in clause 6.

The conclusion for the test items of which are required by the applied standard is indicated under the test result.

- The test result was **passed** for the test requirements of the applied standard.
- The test result was **failed** for the test requirements of the applied standard.
- The test result was **not judged** the test requirements of the applied standard.

In the approval of test results,

- Determining compliance with the limits in this report was based on the results of the compliance measurement, not taking into account measurement instrumentation uncertainty.
- No deviations were employed from the applied standard.
- No modifications were conducted by JQA to achieve compliance to the limitations.

Reviewed by:

Tested by:



Shigeru Kinoshita
Deputy Manager
JQA KITA-KANSAI Testing Center
SAITO EMC Branch



Shigeru Osawa
Deputy Manager
JQA KITA-KANSAI Testing Center
SAITO EMC Branch

3 Test Procedure

Test Requirements : CFR 47 FCC Rules and Regulations Part 2
§2.1046, §2.1047, §2.1049, §2.1051, §2.1053, §2.1055 and §2.1057

Test Procedure : ANSI C63.4–2003, TIA/EIA–603-C-2004
FCC KDB 971168 D01 Licensed DTS Guidance v02r01, released June 7, 2013

4 Test Location

Japan Quality Assurance Organization (JQA)
KITA-KANSAI Testing Center
7-7, Ishimaru, 1-chome, Minoh-shi, Osaka, 562-0027, Japan
SAITO EMC Branch
7-3-10, Saito-asagi, Ibaraki-shi, Osaka 567-0085, Japan

5 Recognition of Test Laboratory

JQA KITA-KANSAI Testing Center SAITO EMC Branch is accredited under ISO/IEC 17025 by following accreditation bodies and the test facility is registered by the following bodies.

VLAC Accreditation No. : VLAC-001-2 (Expiry date : March 30, 2014)
VCCI Registration No. : A-0002 (Expiry date : March 30, 2014)
IC Registration No. : 2079E-3, 2079E-4 (Expiry date : July 20, 2014)

Accredited as conformity assessment body for Japan electrical appliances and material law by METI.
(Expiry date : February 22, 2016)

6 Details of the Equipment Under Test

6.1 Operating Condition

The test were carried under one modulation type shown as follows:

Modulation Burst Signal : DATA TSC 5 in accordance with GSM 05.02.

The Radiated Emission test were carried under 3 test configurations shown in clause 6.3.

In all tests, the fully charged battery is used for the EUT.

Detailed Transmitter portion:

Transmitter frequency : 824.2 MHz(128CH) – 848.8 MHz(251CH)

Local frequency : 3296.8 MHz(128CH) – 3395.2 MHz(251CH)

Detailed Receiver portion:

Receiver frequency : 869.2 MHz(128CH) – 893.8 MHz(251CH)

Local frequency : 3476.8 MHz(128CH) – 3575.2 MHz(251CH)

Other Clock Frequency

32.768 kHz, 19.2 MHz, 27 MHz, 27.12 MHz, 37.4 MHz

The EUT was rotated through three orthogonal axis (X, Y and Z axis) in radiated measurement.

The EUT with temporary antenna port was used in conducted measurement.

6.2 Test Configuration

The equipment under test (EUT) consists of :

	Item	Manufacturer	Model No.	Serial No.	FCC ID
A	Cellular Phone	Sharp	SH-01F	004401114 935196 *1) 004401114 935162 *2)	APYHRO00197
B	AC Adapter	Fujitsu Corporation	04	WFA	N/A
C	Stereo Handsfree	Sharp	SHLDL1	--	N/A

*1) Used for Field Strength of Spurious Emission

*2) Used for Antenna Conducted Emission and Frequency Stability

The auxiliary equipment used for testing :

None

Type of Cable:

No.	Description	Identification (Manu. etc.)	Connector Shielded	Cable Shielded	Ferrite Core	Length (m)
1	USB conversion cable	--	--	NO	YES	1.1
2	Handsfree Cable	--	--	NO	NO	1.5

6.3 Test Arrangement (Drawings)

a) Single Unit

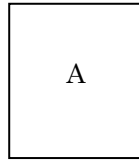

b) AC Adapter used

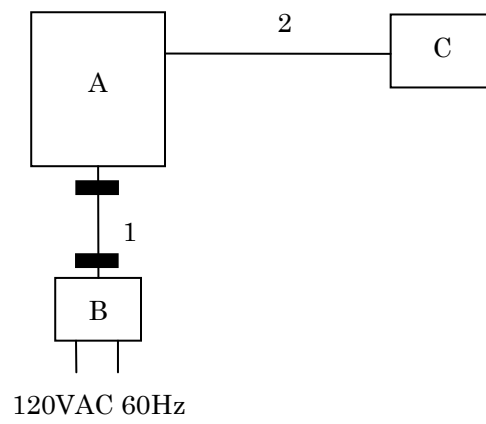

c) Handsfree used

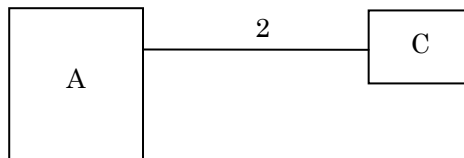
 : Ferrite Core

7 Details of the Test Item**7.1 RF Power Output (§2.1046)**

For the requirements, - Applicable - Tested. - Not tested by applicant request.]
 - Not Applicable

For the limits, - **Passed** - **Failed** - **Not judged**

7.1.1 Worst Point and Measurement Uncertainty

Transmitter Power is 1733.8 mW at 824.200 MHz

Uncertainty of Measurement Results at Amplitude +/-0.7 dB(2 σ)

Remarks : _____

7.1.2 Test Site

KITA-KANSAI Testing Center

Test site : SAITO - Anechoic chamber (A1) - Measurement room (M1)
 - Measurement room (M2) - Measurement room (M3)
 - Shielded room (S1) - Shielded room (S2)
 - Shielded room (S3) - Shielded room (S4)

7.1.3 Test Instruments

Type	Model	Manufacturer	ID No.	Last Cal.	Interval
Power Meter	N1911A	Agilent	B-63	2013/7	1 Year
Power Sensor	N1921A	Agilent	B-64	2013/7	1 Year
Attenuator	54A-10	Weinschel	D-28	2012/9	1 Year
RF Cable	SUCOFLEX102	SUHNER	C-52	2013/7	1 Year

7.1.4 Test Method and Test Setup (Diagrammatic illustration)

The Conducted RF Power Output was measured with a power meter, one 10dB attenuator and a short, low loss cable.

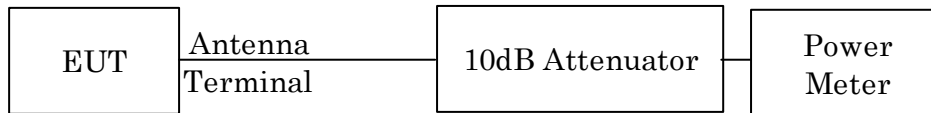

7.1.5 Test Data

(GSM850)

Test Date: September 13, 2013Temp.: 28 °C, Humi: 60 %

CH	Transmitting Frequency	Correction Factor	Meter Reading (Peak)	Results (Peak)	
	[MHz]			[dBm]	[mW]
128	824.200	9.97	22.42	32.39	1733.8
189	836.400	9.97	22.41	32.38	1729.8
251	848.800	9.97	22.40	32.37	1725.8

Calculated result at 824.200 MHz, as the maximum level point shown on underline:

Correction Factor	=	9.97	dB
+) Meter Reading	=	22.42	dBm
Result	=	32.39	dBm = 1733.8 mW

NOTE : The correction factor shows the attenuation pad loss including the short, low loss cable or adapter.

7.2 ERP / EIRP RF Power Output

For the requirements, - Applicable - Tested. - Not tested by applicant request.]
 - Not Applicable

For the limits, - Passed - Failed - Not judged

7.2.1 Worst Point and Measurement Uncertainty

Min. Limit Margin 7.7 dB at 824.200 MHz

Uncertainty of Measurement Results +/-1.4 dB(2σ)

Remarks : The maximum ERP is 1.202 W at 824.200 MHz.

7.2.2 Test Site

KITA-KANSAI Testing Center SAITO EMC Branch

- Anechoic chamber A1 - Anechoic chamber A2

7.2.3 Test Instruments

Type	Model	Manufacturer	ID No.	Last Cal.	Interval
Test Receiver	ESU26	Rohde & Schwarz	A-6	2013/4	1 Year
Signal Generator	E8257D	Agilent	B-39	2013/8	1 Year
Power Meter	N1911A	Agilent	B-63	2013/7	1 Year
Power Sensor	N1921A	Agilent	B-64	2013/7	1 Year
Attenuator(TX)	2-10	Weinschel	D-79	2012/11	1 Year
Log-periodic Antenna	UHALP9108-A1	Schwarzbeck	C-31	2013/5	1 Year
Dipole Antenna(TX)	KBA-611	Kyoritsu	C-20	2013/5	1 Year

7.2.4 Test Method and Test Setup (Diagrammatic illustration)

Step 1:

In order to obtain the maximum emission, the EUT was placed at the height 1.5 m on the non-conducted support and was varying at three orthogonal axes, at the distance 3 m from the receiving antenna and rotated around 360 degrees.

The receiving antenna height was varied from 1 m to 4 m.

The EUT on the table was placed to be maximum emission against at the receiving antenna polarized (vertical and horizontal).

Then the meter reading of the spectrum analyzer at the maximum emission was A dB(μ V).

Step 2:

The EUT was replaced to substitution antenna at the same polarized under the same condition as step 1.

The RF power was fed to the transmitting antenna through the RF amplifier from the signal generator.

In order to obtain the maximum emission level, the height of the receiving antenna was varied from 1 m to 4 m.

The level of maximum emission was A dB(μ V), same as the recorded level in the step 1.

Then the RF power into the substitution horn antenna was P (dBm).

The ERP/EIRP output power was calculated in the following equation.

$$\text{ERP (dBm)} = \text{P (dBm)} - \text{Balun loss of the tuned dipole antenna (dB)} + \text{Cable loss (dB)}$$

$$\text{EIRP (dBm)} = \text{P (dBm)} + \text{Gh (dBi)}$$

where, Gh (dBi) : Gain of the substitution horn antenna.

– Side View –

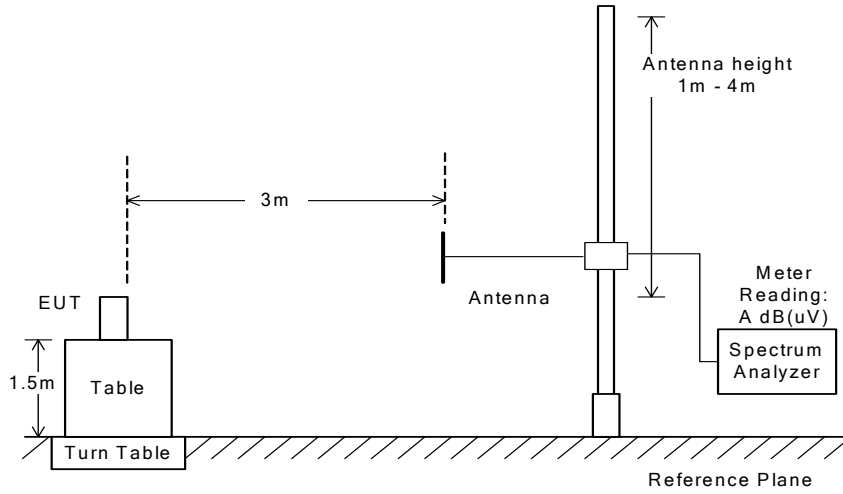

(a)EUT

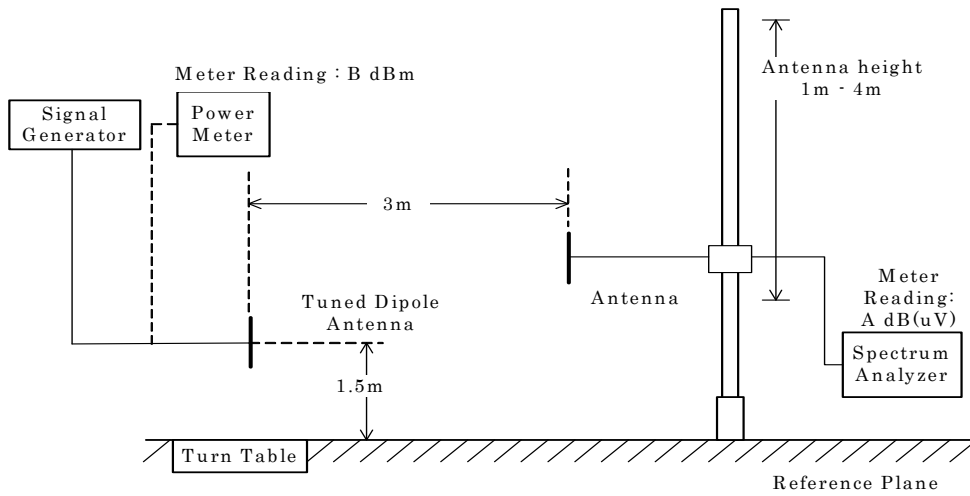

(b) Substitution Half-wave Dipole Antenna

7.2.5 Test Data

(GSM850)

Test Date: September 15, 2013

Temp.: 25 °C, Humi: 74 %

1. Measurement Results

CH	Transmitting Frequency [MHz]	Emission Measurement [dB(uV)]		Substitution Measurement [dB(uV)]		Supplied Power to Substitution Antenna [dBm]	Balun Loss of Substitution Antenna [dB]
		Hori. (Mh)	Vert. (Mv)	Hori. (Msh)	Vert. (Msv)		
128	824.200	104.5	103.1	67.2	66.5	- 5.0	1.5
189	836.400	103.2	102.0	66.8	66.0	- 5.0	1.5
251	848.800	103.7	101.6	66.6	65.4	- 5.0	1.6

2. Calculation Results

CH	Transmitting Frequency [MHz]	Peak ERP [dBm]		Maximum Peak ERP [W]	Limits [dBm]	Margin [dB]
		Hori. (ERPh)	Vert. (ERPv)			
128	824.200	30.8	30.1	1.202	38.5	+ 7.7
189	836.400	29.9	29.5	0.977	38.5	+ 8.6
251	848.800	30.6	29.7	1.148	38.5	+ 7.9

Calculated result at 824.200 MHz, as the worst point shown on underline:

Emission Measurement (Mh)	=	104.5 dB(uV)
Substitution Measurement (Msh)	=	-67.2 dB(uV)
Supplied Power to Substitution Antenna	=	-5.0 dBm
+) Balun Loss of Substitution Antenna	=	-1.5 dB
Result (ERPh)	=	30.8 dBm = 1.202 W

Minimum Margin: 38.5 - 30.8 = 7.7 (dB)

NOTE : Setting of measuring instrument(s) :

Detector Function	Resolution B.W.	V.B.W.	Sweep Time
Peak	5 MHz	5 MHz	AUTO

7.3 Modulation Characteristics (§2.1047)

For the requirements, - Applicable - Tested. - Not tested by applicant request.]
 - Not Applicable

For the limits, - Passed - Failed - Not judged

7.4 Occupied Bandwidth (§2.1049)

For the requirements, - Applicable - Tested. - Not tested by applicant request.]
 - Not Applicable

For the limits, - Passed - Failed - Not judged

7.4.1 Worst Point and Measurement Uncertainty

The 99% Bandwidth is 245.3 kHz at 836.400 MHz
The 26dB Bandwidth is 318.0 kHz at 824.200 MHz

Uncertainty of Measurement Results +/-0.9 %(2σ)

Remarks : _____

7.4.2 Test Site

KITA-KANSAI Testing Center

Test site : SAITO - Anechoic chamber (A1) - Measurement room (M1)
 - Measurement room (M2) - Measurement room (M3)
 - Shielded room (S1) - Shielded room (S2)
 - Shielded room (S3) - Shielded room (S4)

7.4.3 Test Instruments

Type	Model	Manufacturer	ID No.	Last Cal.	Interval
Spectrum Analyzer	E4446A	Agilent	A-39	2012/9	1 Year
Attenuator	54A-10	Weinschel	D-28	2012/9	1 Year
RF Cable	SUCOFLEX102	SUHNER	C-52	2013/7	1 Year

7.4.4 Test Method and Test Setup (Diagrammatic illustration)

The test system is shown as follows:

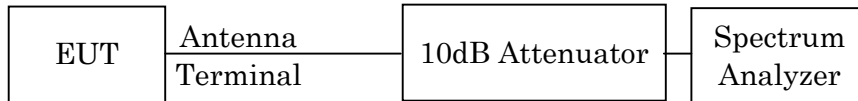

The setting of the spectrum analyzer are shown as follows:

Res. Bandwidth	10 kHz
Video Bandwidth	30 kHz
Span	1 MHz
Sweep Time	AUTO
Trace	Maxhold

7.4.5 Test Data

The resolution bandwidth was set to about 1% of emission bandwidth, -26dBc display line was placed on the screen (or 99% bandwidth), the occupied bandwidth is the delta frequency between the two points where the display line intersects the signal trace.

Test Date : September 13, 2013

Temp.:28°C, Humi:60%

Channel	Frequency (MHz)	99% Bandwidth (kHz)	-26dBc Bandwidth (kHz)
128	824.20	245.1	318.0
189	836.40	245.3	315.2
251	848.80	243.6	315.4

Low Channel

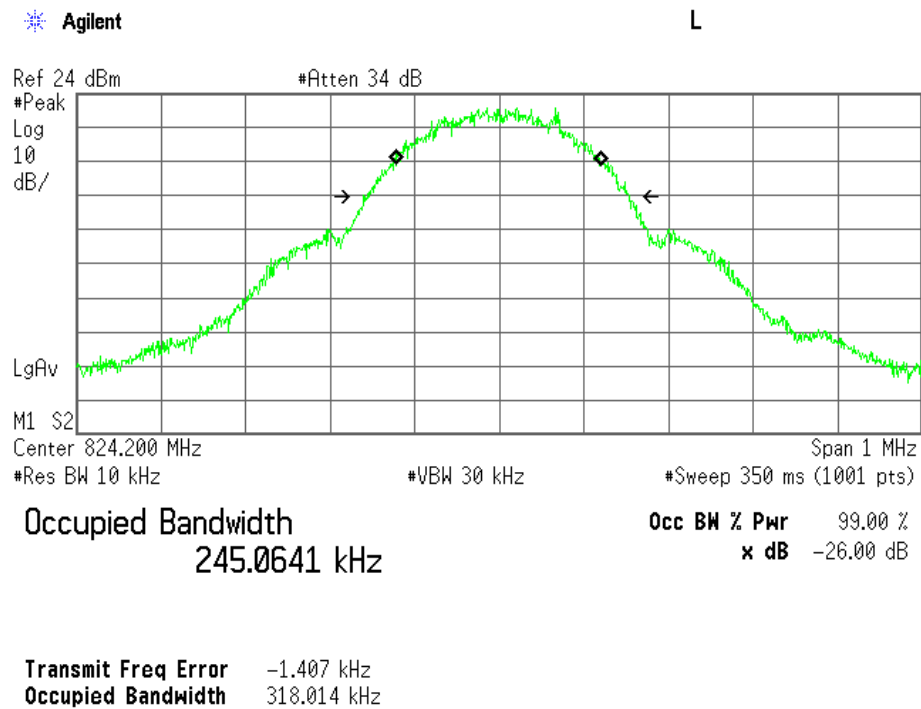

Middle Channel

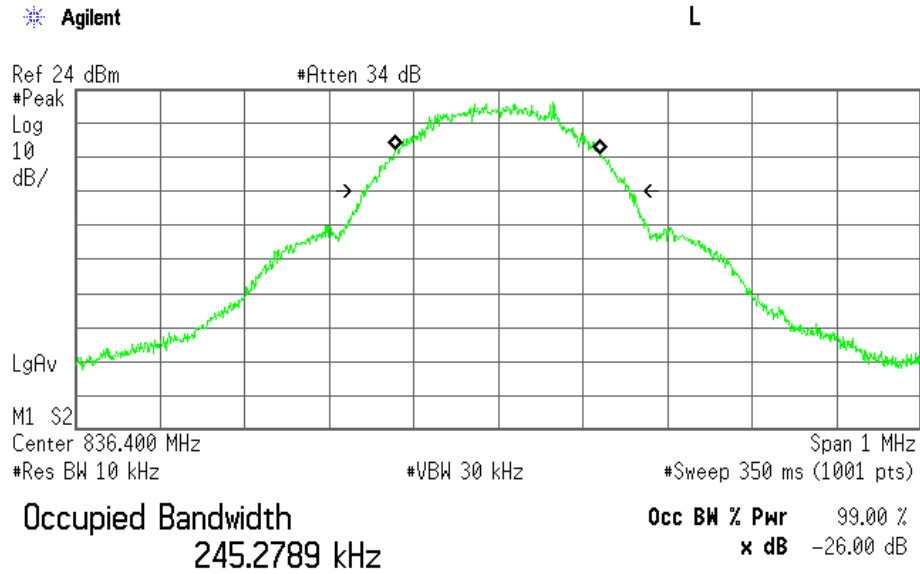

Transmit Freq Error -1.051 kHz
 Occupied Bandwidth 315.245 kHz

High Channel

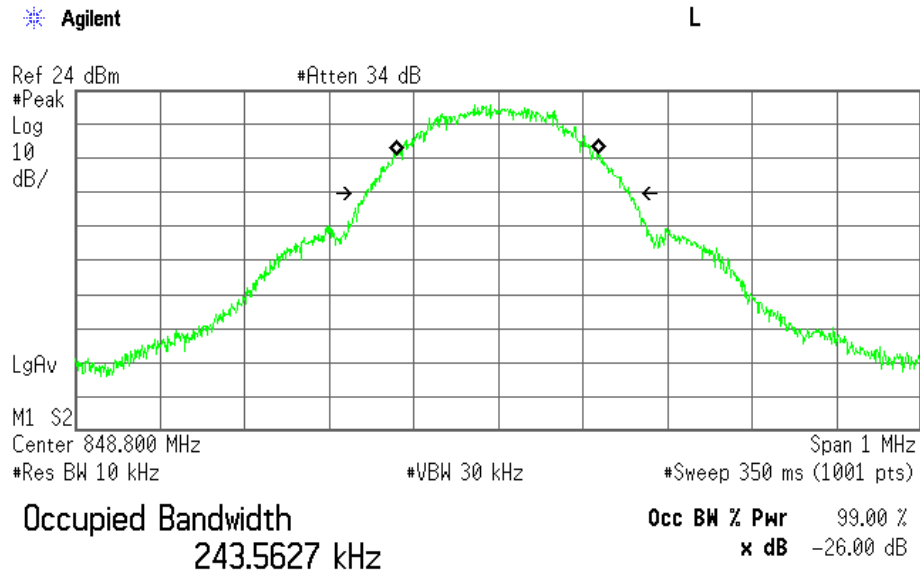

Transmit Freq Error -1.245 kHz
 Occupied Bandwidth 315.410 kHz

7.5 Spurious Emissions at Antenna Terminals (§2.1051)

For the requirements, - Applicable - Tested. - Not tested by applicant request.]
 - Not Applicable

For the limits, - Passed - Failed - Not judged

7.5.1 Worst Point and Measurement Uncertainty

Min. Limit Margin 32.9 dB at 1697.600 MHz

Uncertainty of Measurement Results	9 kHz – 1GHz	<u>+/-1.0</u>	dB(2 σ)
	1GHz – 18GHz	<u>+/-1.2</u>	dB(2 σ)
	18GHz – 40GHz	<u>+/-1.6</u>	dB(2 σ)

Remarks : _____

7.5.2 Test Site

KITA-KANSAI Testing Center

Test site : SAITO

<input type="checkbox"/> - Anechoic chamber (A1)	<input type="checkbox"/> - Measurement room (M1)
<input type="checkbox"/> - Measurement room (M2)	<input type="checkbox"/> - Measurement room (M3)
<input type="checkbox"/> - Shielded room (S1)	<input type="checkbox"/> - Shielded room (S2)
<input type="checkbox"/> - Shielded room (S3)	<input checked="" type="checkbox"/> - Shielded room (S4)

7.5.3 Test Instruments

Type	Model	Manufacturer	ID No.	Last Cal.	Interval
Spectrum Analyzer	E4446A	Agilent	A-39	2012/9	1 Year
Attenuator	54A-10	Weinschel	D-28	2012/9	1 Year
RF Cable	SUCOFLEX102	SUHNER	C-52	2013/7	1 Year
HPF	HPM5010S	MICRO-TRONICS	D-94	2013/2	1 Year

7.5.4 Test Method and Test Setup (Diagrammatic illustration)

The Antenna Conducted Emission was measured with a spectrum analyzer. The test system is shown as follows:

a) Frequency Range : 9kHz - 1.2GHz

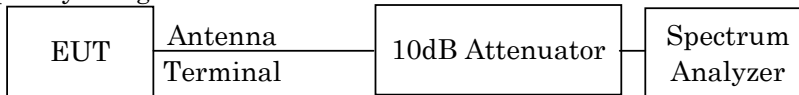

b) Frequency Range : 1.2GHz - 10GHz



The setting of the spectrum analyzer are shown as follows:

Frequency Range	9 kHz - 150 kHz	150 kHz - 30 MHz	30 MHz - 10 GHz
Res. Bandwidth	200 Hz	10 kHz	1 MHz
Video Bandwidth	1 kHz	30 kHz	3 MHz
Sweep Time	AUTO	AUTO	AUTO
Trace	Maxhold	Maxhold	Maxhold

7.5.5 Test Data

(GSM850)

Test Date: September 13, 2013

Temp.: 28 °C, Humi: 60 %

Transmitting Frequency CH	[MHz]	Measured Frequency [MHz]	Corr. Factor [dB]	Meter Readings [dBm]	Limits [dBm]	Results [dBm]	Margin [dB]	Remarks
128	824.200	1648.400	11.2	-60.4	-13.0	-49.2	+36.2	C
		2472.600	10.8	-56.9	-13.0	-46.1	+33.1	C
		3296.800	11.0	< -63.0	-13.0	< -52.0	> +39.0	C
		4121.000	11.1	< -63.0	-13.0	< -51.9	> +38.9	C
		4945.200	11.2	< -63.0	-13.0	< -51.8	> +38.8	C
		5769.400	11.3	< -63.0	-13.0	< -51.7	> +38.7	C
		6593.600	11.4	< -63.0	-13.0	< -51.6	> +38.6	C
		7417.800	11.7	< -63.0	-13.0	< -51.3	> +38.3	C
		8242.000	11.9	< -63.0	-13.0	< -51.1	> +38.1	C
189	836.400	1672.800	11.2	-60.7	-13.0	-49.5	+36.5	C
		2509.200	10.8	-57.9	-13.0	-47.1	+34.1	C
		3345.600	11.0	< -63.0	-13.0	< -52.0	> +39.0	C
		4182.000	11.1	< -63.0	-13.0	< -51.9	> +38.9	C
		5018.400	11.2	< -63.0	-13.0	< -51.8	> +38.8	C
		5854.800	11.3	< -63.0	-13.0	< -51.7	> +38.7	C
		6691.200	11.5	< -63.0	-13.0	< -51.5	> +38.5	C
		7527.600	11.8	< -63.0	-13.0	< -51.2	> +38.2	C
		8364.000	12.0	< -63.0	-13.0	< -51.0	> +38.0	C
251	848.800	1697.600	11.1	-57.0	-13.0	-45.9	+32.9	C
		2546.400	10.8	-57.6	-13.0	-46.8	+33.8	C
		3395.200	11.0	< -63.0	-13.0	< -52.0	> +39.0	C
		4244.000	11.1	< -63.0	-13.0	< -51.9	> +38.9	C
		5092.800	11.2	< -63.0	-13.0	< -51.8	> +38.8	C
		5941.600	11.3	< -63.0	-13.0	< -51.7	> +38.7	C
		6790.400	11.5	< -63.0	-13.0	< -51.5	> +38.5	C
		7639.200	11.8	< -63.0	-13.0	< -51.2	> +38.2	C
		8488.000	12.0	< -63.0	-13.0	< -51.0	> +38.0	C

Calculated result at 1697.6 MHz, as the worst point shown on underline:

Corr. Factor	=	11.1 dB
+) Meter Reading	=	<u>-57.0 dBm</u>
Result	=	-45.9 dBm

Minimum Margin: -13.0 - (-45.9) = 32.9 (dB)

NOTES

- The spectrum was checked from 9 kHz to 10 GHz.
- Applied limits : -13.0 [dBm] = $10\log(TP[mW]) - (43 + 10\log(tp[W])) = 10\log(TP[mW]) - (43 + (10 \log(TP[mW]) - 30))$
 where, $tp[W] = TP[mW] / 1000$: Transmitter power at antenna terminal
- The correction factor is shown as follows:
 Corr. Factor [dB] = Cable Loss + 10dB Pad Att. [dB] (9 kHz - 2 GHz)
 Corr. Factor [dB] = Cable Loss + 10dB Pad Att. + High Pass Filter Loss (D-96) [dB] (over 2 GHz)
- The symbol of "<" means "or less".
- The symbol of ">" means "more than".
- Setting of measuring instrument(s) :

	Detector Function	RES B.W.	V.B.W.	Sweep Time
A	Peak	200 Hz	1 kHz	AUTO
B	Peak	10 kHz	30 kHz	AUTO
C	Peak	1 MHz	3 MHz	AUTO

Low Channel, Out-Of-Band Emissions (9 kHz – 150 kHz)

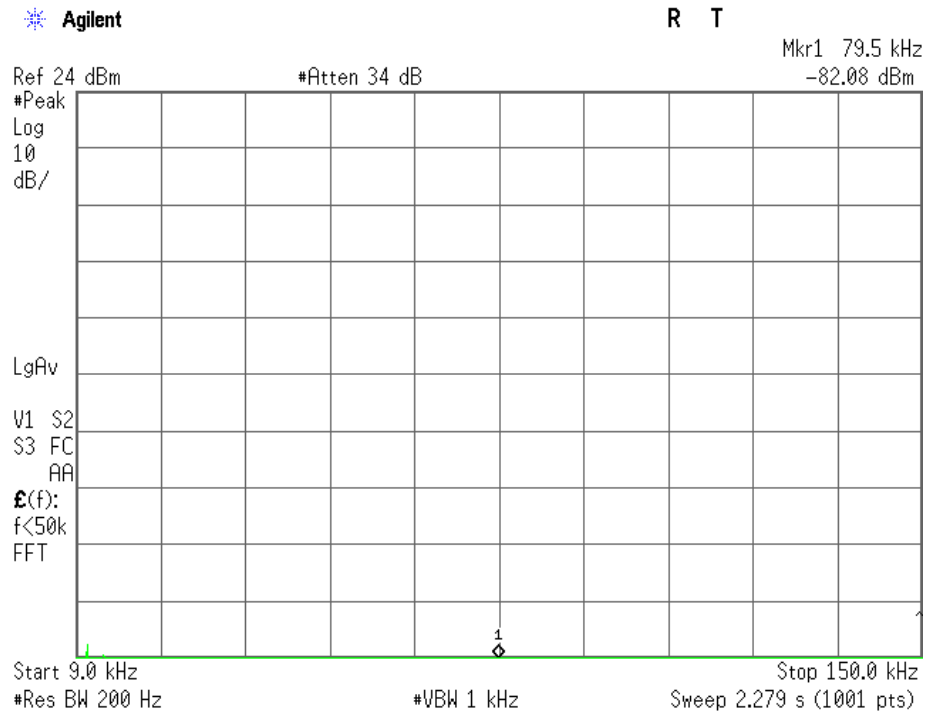

Low Channel, Out-Of-Band Emissions (150 kHz – 30 MHz)

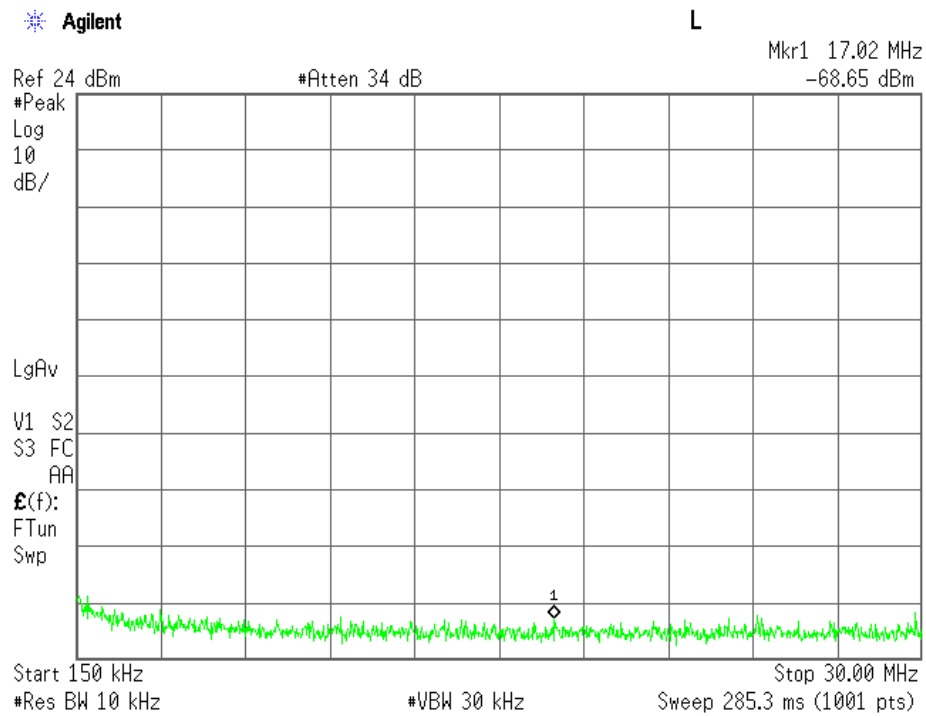

Low Channel, Out-Of-Band Emissions (30 MHz – 1.2 GHz)

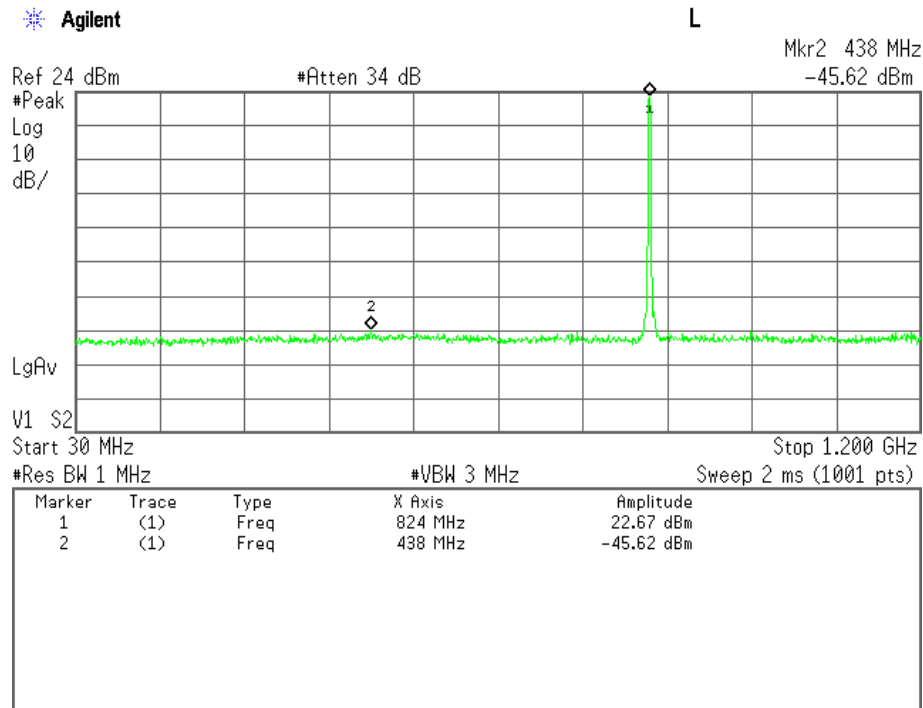

Low Channel, Out-Of-Band Emissions (1.2 GHz – 10 GHz)

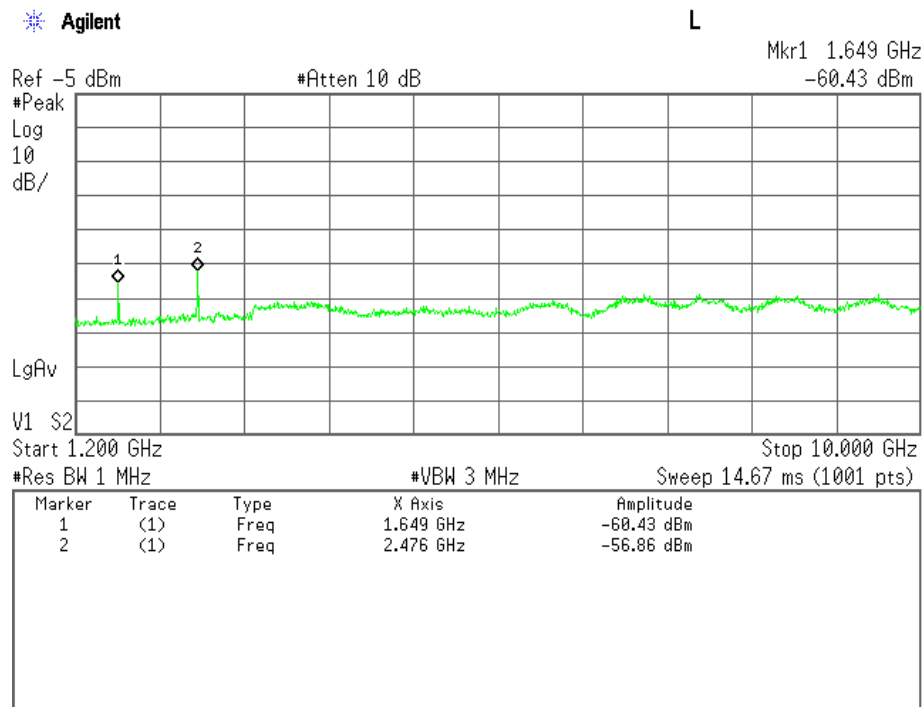

Middle Channel, Out-Of-Band Emissions (9 kHz – 150 kHz)

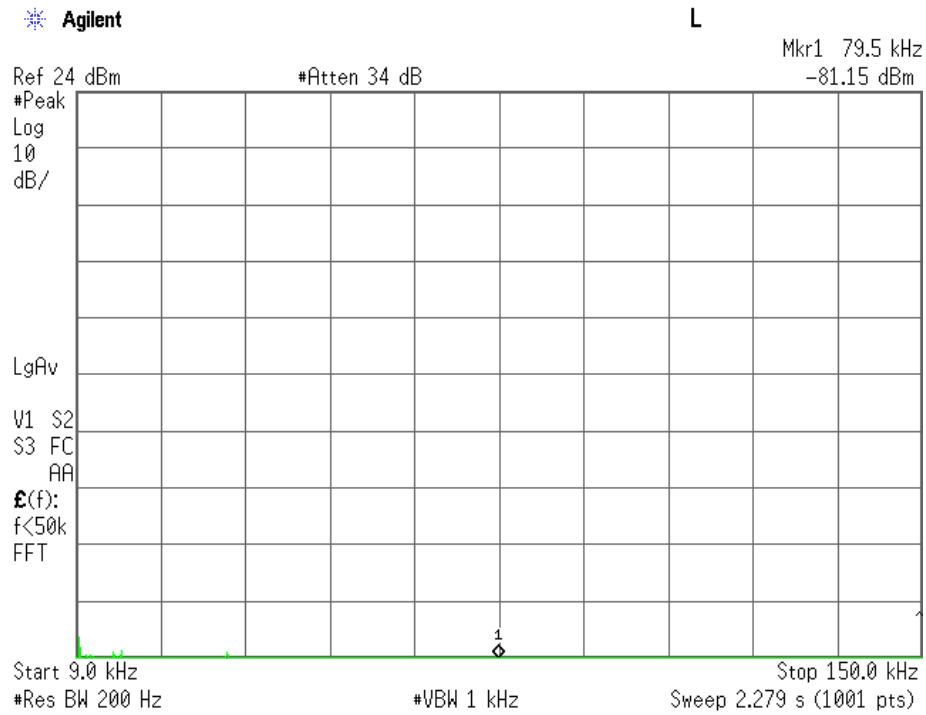

Middle Channel, Out-Of-Band Emissions (150 kHz – 30 MHz)

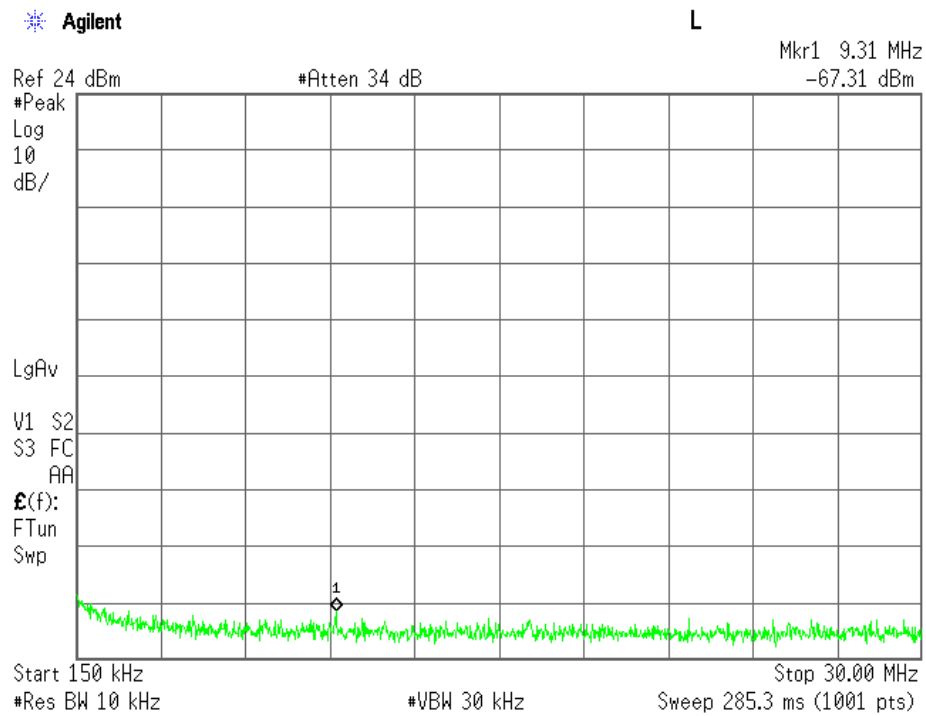

Middle Channel, Out-Of-Band Emissions (30 MHz – 1.2 GHz)

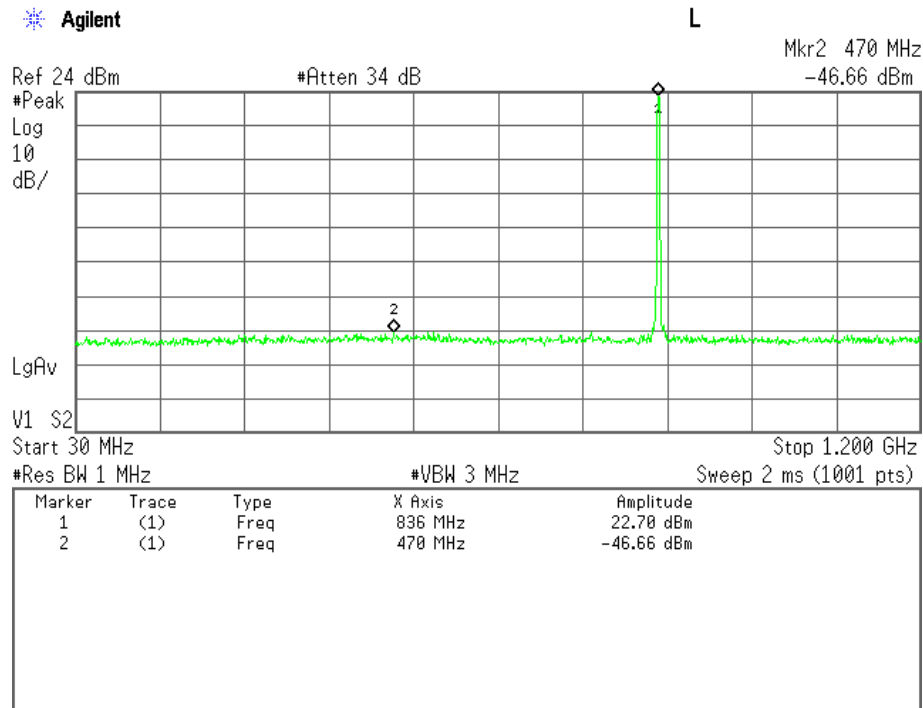

Middle Channel, Out-Of-Band Emissions (1.2 GHz – 10 GHz)

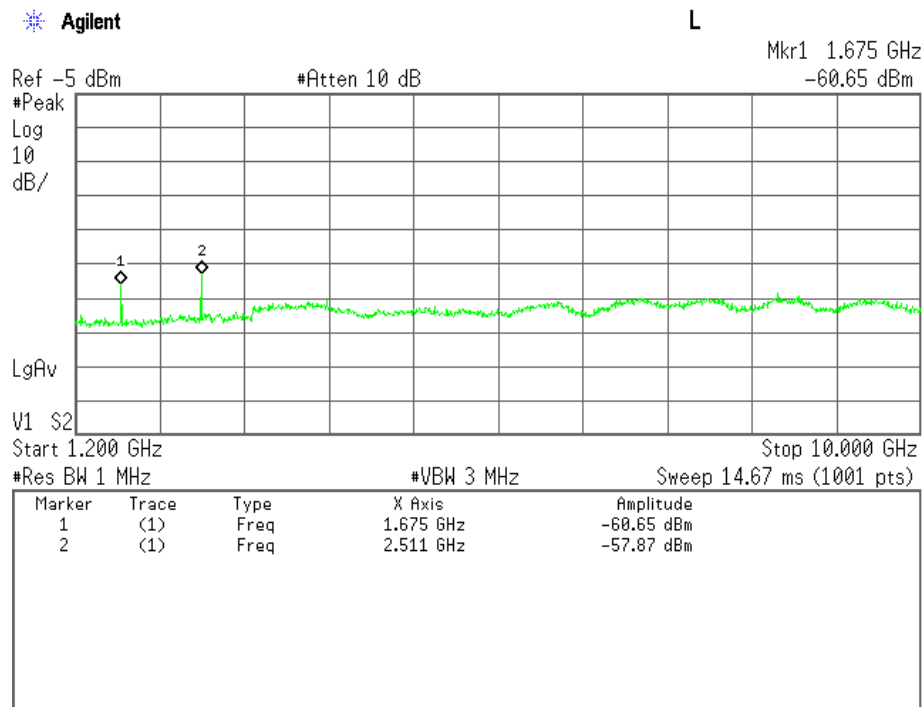

High Channel, Out-Of-Band Emissions (9 kHz – 150 kHz)

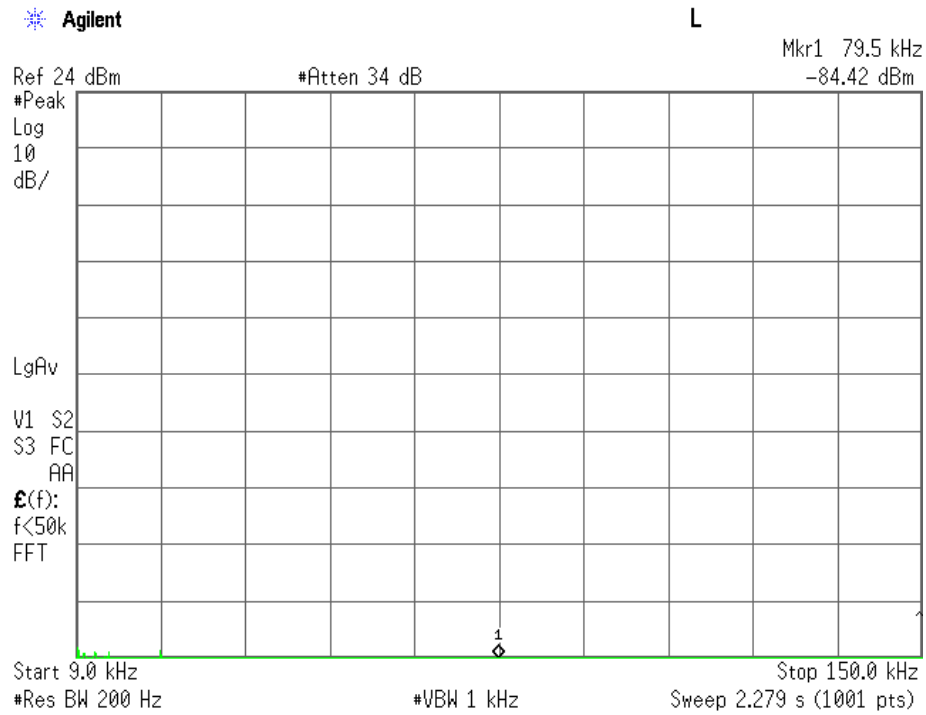

High Channel, Out-Of-Band Emissions (150 kHz – 30 MHz)

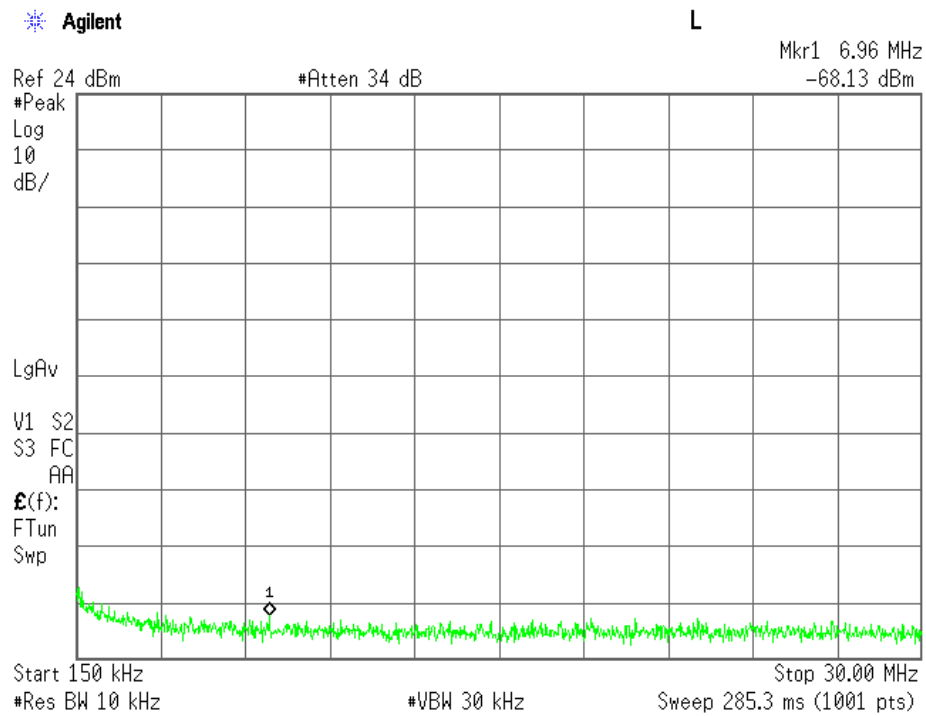

High Channel, Out-Of-Band Emissions (30 MHz – 1.2 GHz)

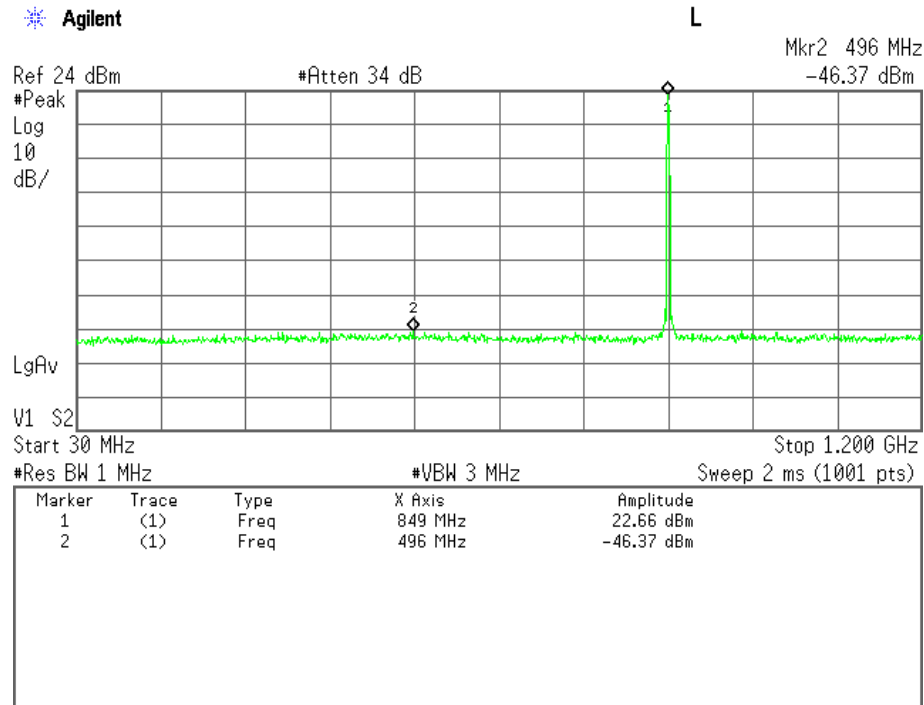

High Channel, Out-Of-Band Emissions (1.2 GHz – 10 GHz)

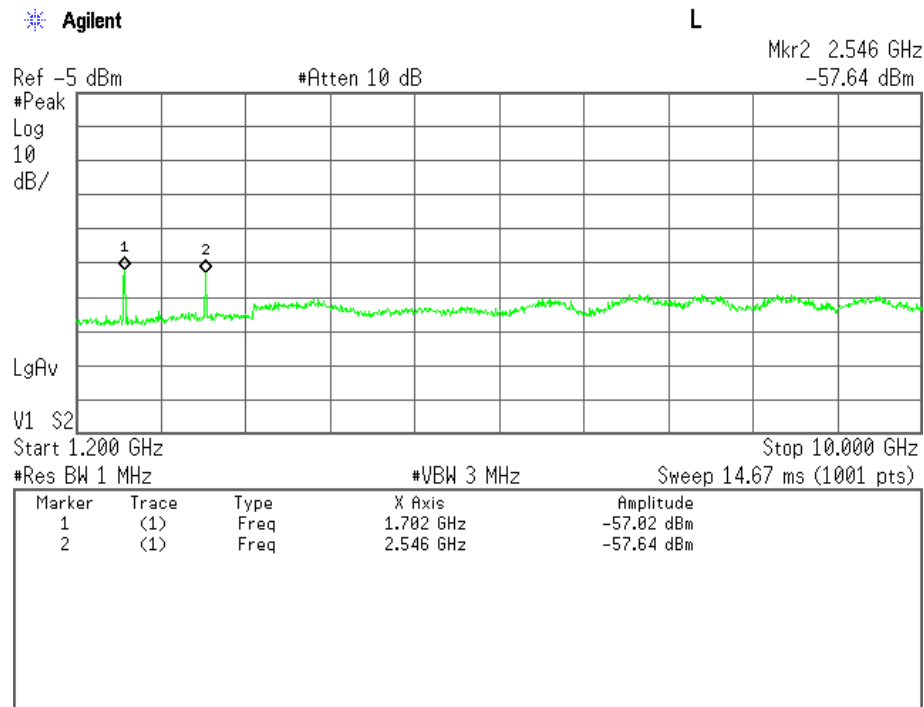

7.6 Band-Edge Emission (§2.1051)

For the requirements, - Applicable - Tested. - Not tested by applicant request.]
 - Not Applicable

For the limits, - Passed - Failed - Not judged

7.6.1 Worst Point and Measurement Uncertainty

The Band-Edge level is -14.0 dBm at 824.000 MHz

Uncertainty of Measurement Results +/-1.2 dB(2σ)

Remarks : The measurement result is within the range of measurement uncertainty.

7.6.2 Test Site

KITA-KANSAI Testing Center

Test site : SAITO - Anechoic chamber (A1) - Measurement room (M1)
 - Measurement room (M2) - Measurement room (M3)
 - Shielded room (S1) - Shielded room (S2)
 - Shielded room (S3) - Shielded room (S4)

7.6.3 Test Instruments

Type	Model	Manufacturer	ID No.	Last Cal.	Interval
Spectrum Analyzer	E4446A	Agilent	A-39	2012/9	1 Year
Attenuator	54A-10	Weinschel	D-28	2012/9	1 Year
RF Cable	SUCOFLEX102	SUHNER	C-52	2013/7	1 Year

7.6.4 Test Method and Test Setup (Diagrammatic illustration)

The test system is shown as follows:

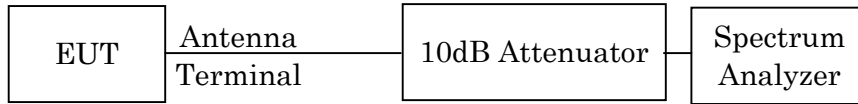

The setting of the spectrum analyzer are shown as follows:

TX Frequency	824.20 MHz / 848.80 MHz
Band-Edge Frequency	824.00 MHz / 849.00 MHz
Res. Bandwidth	2.7 kHz
Video Bandwidth	10 kHz
Span	2 MHz
Sweep Time	AUTO
Trace	Maxhold

7.6.5 Test Data

Test Date : September 13, 2013

Temp.:28°C, Humi:60%

Channel	Frequency (MHz)	Band-Edge Frequency (MHz)	Band-Edge Level (dBm)
128	824.2	824.0	-14.0
251	848.8	849.0	-14.2

Low Channel, Band-Edge Emission

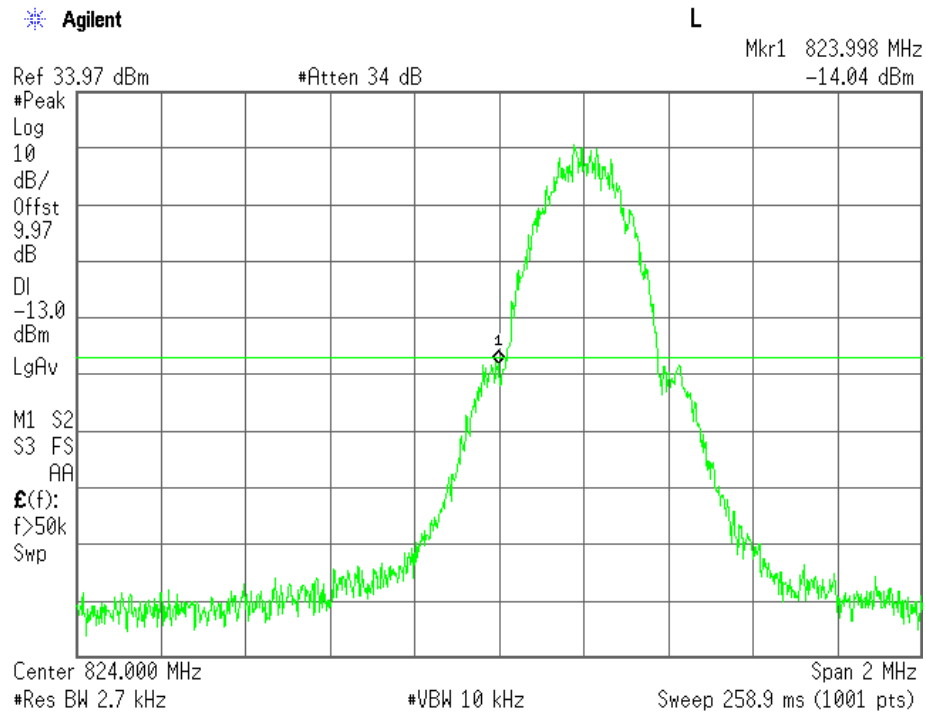

High Channel, Band-Edge Emission

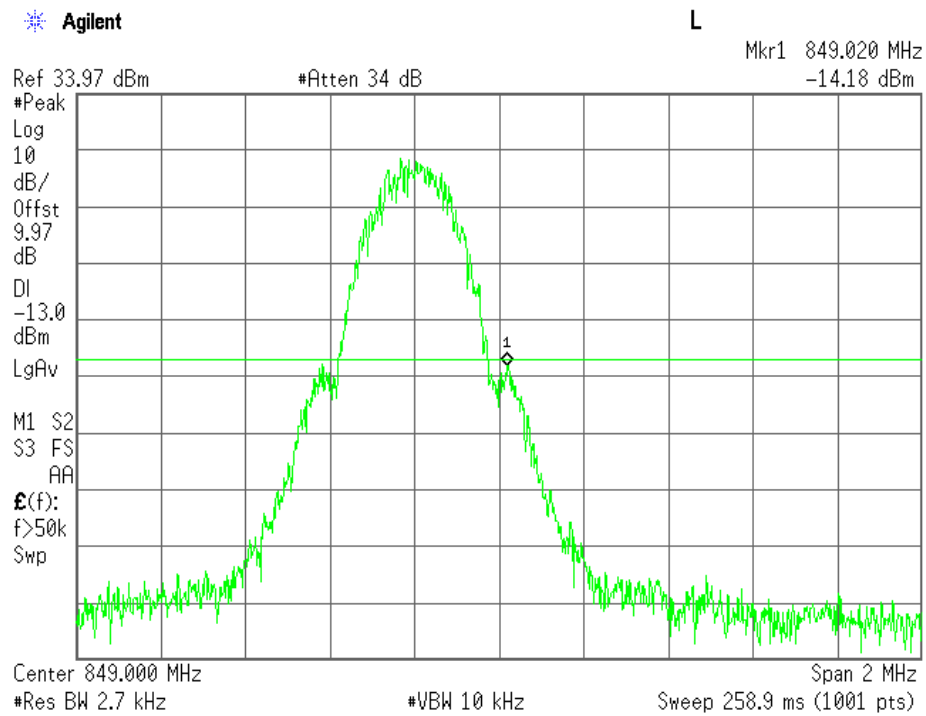

7.7 Field Strength of Spurious Radiation (§2.1053)

For the requirements, - Applicable - Tested. - Not tested by applicant request.]
 - Not Applicable

For the limits, - Passed - Failed - Not judged

7.7.1 Worst Point and Measurement Uncertainty

Min. Limit Margin 29.3 dB at 2472.600 MHz

Uncertainty of Measurement Results 30 MHz – 1000 MHz +/-1.4 dB(2σ)
 above 1 GHz +/-2.2 dB(2σ)

Remarks : _____

7.7.2 Test Site

KITA-KANSAI Testing Center SAITO EMC Branch

- Anechoic chamber A1 - Anechoic chamber A2

7.7.3 Test Instruments

Type	Model	Manufacturer	ID No.	Last Cal.	Interval
Test Receiver	ESU26	Rohde & Schwarz	A-6	2013/4	1 Year
Signal Generator	E8257A	Agilent	B-39	2013/8	1 Year
Power Meter	N1911A	Agilent	B-63	2013/7	1 Year
Power Sensor	N1921A	Agilent	B-64	2013/7	1 Year
Horn Antenna	91888-2	EATON	C-41-1	2013/6	1 Year
Horn Antenna	91889-2	EATON	C-41-2	2013/6	1 Year
Horn Antenna	3160-05	EATON	C-56	2013/7	1 Year
Horn Antenna	3160-06	EATON	C-57	2013/7	1 Year
Horn Antenna	3160-07	EATON	C-58	2013/7	1 Year
RF Cable	SUCOFLEX104	SUHNER	C-66	2013/2	1 Year
RF Cable	SUCOFLEX104	SUHNER	C-67	2013/2	1 Year
Attenuator	2-10	Weinschel	D-79	2012/11	1 Year
Attenuator	54-10	Weinschel	D-29	2012/9	1 Year
Pre-Amplifier	WJ-6611-513	Watkins Johnson	A-23	2013/2	1 Year
Pre-Amplifier	WJ-6882-824	Watkins Johnson	A-21	2013/2	1 Year
Pre-Amplifier	DBL-0618N515	DBS Microwave	A-33	2013/2	1 Year
HPF	HPM5010S	MICRO-TRONICS	D-94	2013/2	1 Year

7.7.4 Test Method and Test Setup (Diagrammatic illustration)

Step 1) The spurious radiation for transmitter were measured at the distance 3 m away from the EUT which was placed on a non-conducted support 0.8 m in height and was varying at three orthogonal axes. The receiving antenna was oriented for vertical polarization and varied from 1 m to 4 m until the maximum emission level was detected on the measuring instrument. The EUT was rotated 360 degrees until the maximum emission was received. The measurement was also repeated with the receiving antenna in the horizontal polarization.

This test was carried out using the half-wave dipole antenna for up to 1GHz and using the horn antenna for above 1 GHz.

Step 2)

A) Up to 1 GHz

The ERP measurement was carried out with according to Step 2 in Clause 7.2.4. Then the RF power in the substitution antenna half-wave dipole antenna for up to 1 GHz and the substitution horn antenna for above 1 GHz.

The ERP is calculated in the following equation.

$$ERP(dBm) = P (dBm) - (Balun Loss of the half-wave dipole Ant. (dB)) + Cable Loss (dB)$$

B) Above 1 GHz

The ERP is calculated from the maximum emission level by the following formula.

$$\frac{e^2}{120\pi} = \frac{eirp}{4\pi d^2} \quad \text{---(Eq.1)}$$

$$erp = eirp - Gd \quad \text{---(Eq.2)}$$

Where, $e[V/m]$: Field Strength at measuring distance($d=3m$)

$eirp[W]$: Equivalent Isotropic Radiated Power

$erp[W]$: Effective Radiated Power

$Gd(dBi)$: Gain of the substitution half-wave dipole antenna(2.15dBi)

$$eirp = \frac{(de)^2}{30} = \frac{3}{10} e^2$$

$$\therefore 10 \log(eirp) = 20 \log(e) + 10 \log(3/10) = 20 \log(e) - 5.23$$

$$10 \log(eirp) = EIRP[dBm] - 30$$

$$20 \log(e) = E[dB(\mu V/m)] - 120$$

$$\therefore EIRP = E - 120 + 30 - 5.23 = E - 95.23$$

$$\therefore ERP[dBm] = EIRP - 2.15 = E - 97.38$$

The respective calculated ERP of the spurious and harmonics were compared with the ERP of fundamental frequency by specified attenuation limits, $43+10\log_{10}(TP \text{ in watt})[dB]$. Where, TP = Transmitter power at the ANT OUT under test configuration as the hands free unit used.

Radiated Emission 30 MHz to 1000 MHz

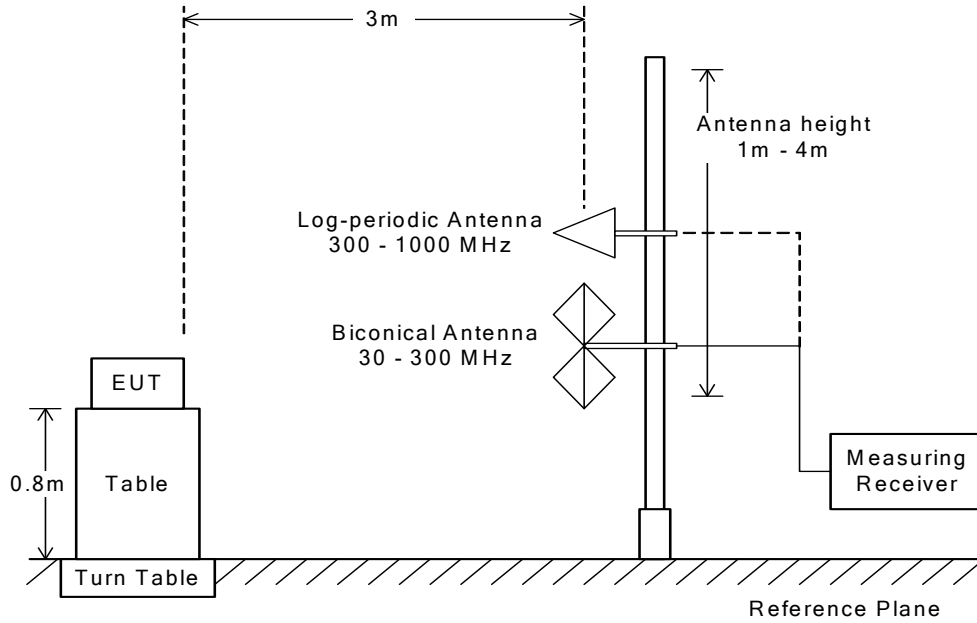

Radiated Emission above 1 GHz

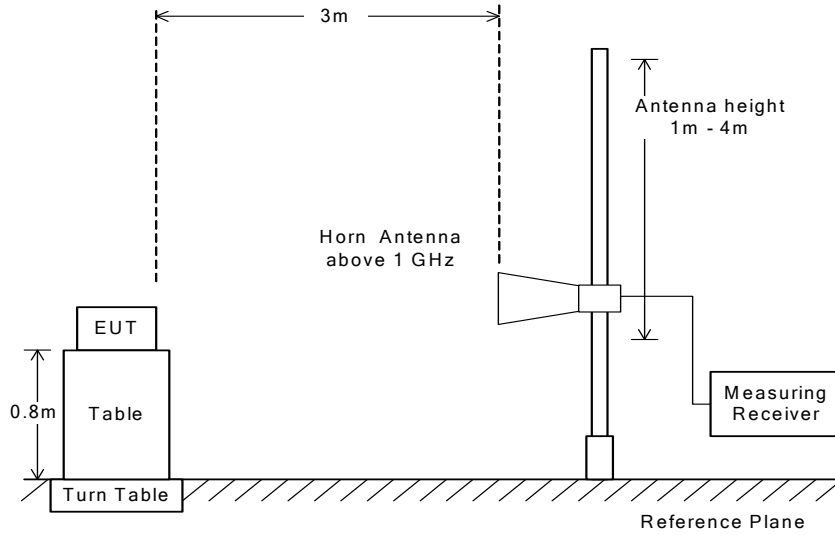

NOTE

The antenna height is scanned depending on the EUT's size and mounting height.

Radiated Emission 30 to 1000 MHz – Substitution Method

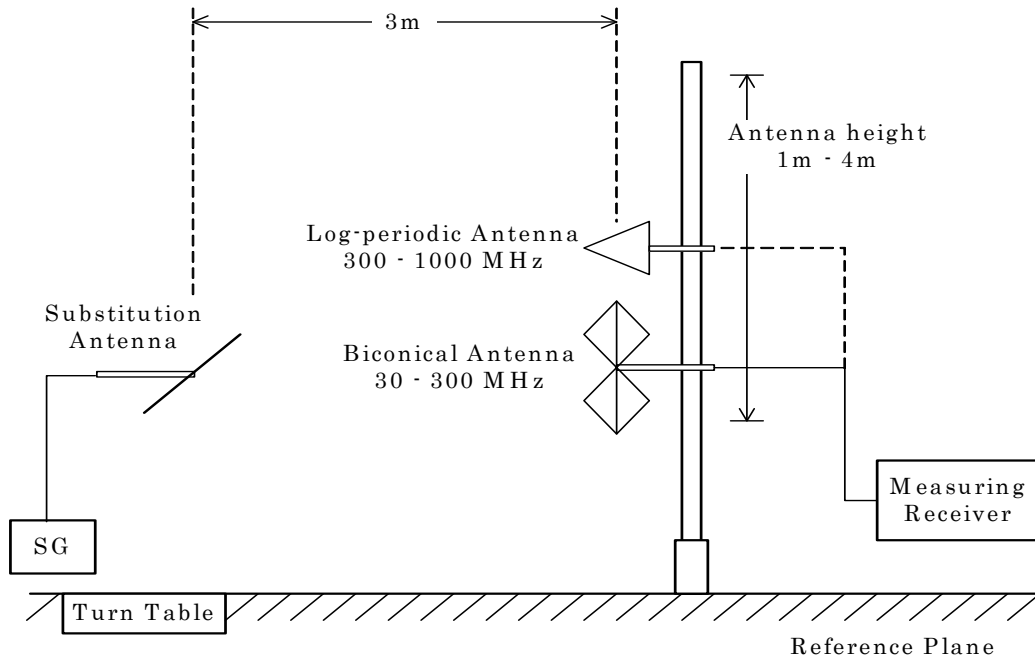

7.7.5 Test Data

(GSM850)

Test Date: September 19, 2013

Temp.: 25 °C, Humi: 59 %

Test Configuration : Single Unit

CH	Transmitting Frequency [MHz]	Measured Frequency [MHz]	ERP [dBm]		Limits [dBm]	Margin [dB]	Remarks
			Hori.	Vert.			
128	824.200	1648.400	-46.3	-47.5	-13.0	+33.3	C
		2472.600	-42.3	-42.6	-13.0	+29.3	C
		3296.800	< -56.7	< -56.7	-13.0	> +43.7	C
		4121.000	< -51.2	< -51.2	-13.0	> +38.2	C
		4945.200	< -51.6	< -51.6	-13.0	> +38.6	C
		5769.400	< -50.6	< -50.6	-13.0	> +37.6	C
		6593.600	< -47.7	< -47.7	-13.0	> +34.7	C
		7417.800	< -57.2	< -57.2	-13.0	> +44.2	C
		8242.000	< -51.3	< -51.3	-13.0	> +38.3	C
189	836.400	1672.800	-45.4	-46.6	-13.0	+32.4	C
		2509.200	-47.8	-45.5	-13.0	+32.5	C
		3345.600	< -56.5	< -56.5	-13.0	> +43.5	C
		4182.000	< -51.2	< -51.2	-13.0	> +38.2	C
		5018.400	< -51.5	< -51.5	-13.0	> +38.5	C
		5854.800	< -50.5	< -50.5	-13.0	> +37.5	C
		6691.200	< -47.6	< -47.6	-13.0	> +34.6	C
		7527.600	< -57.1	< -57.1	-13.0	> +44.1	C
		8364.000	< -51.3	< -51.3	-13.0	> +38.3	C
251	848.800	1697.600	-46.5	-44.7	-13.0	+31.7	C
		2546.400	-44.1	-44.5	-13.0	+31.1	C
		3395.200	< -56.5	< -56.5	-13.0	> +43.5	C
		4244.000	< -51.2	< -51.2	-13.0	> +38.2	C
		5092.800	< -51.5	< -51.5	-13.0	> +38.5	C
		5941.600	< -49.9	< -49.9	-13.0	> +36.9	C
		6790.400	< -47.7	< -47.7	-13.0	> +34.7	C
		7639.200	< -55.1	< -55.1	-13.0	> +42.1	C
		8488.000	< -51.4	< -51.4	-13.0	> +38.4	C

Calculated result at 2472.6 MHz, as the worst point shown on underline:
 Minimum Margin: $-13.0 - (-42.3) = 29.3$ (dB)

NOTES

1. Test Distance : 3 m
2. The spectrum was checked from 30 MHz to 10 GHz.
3. All emissions not reported were more than 20 dB below the applied limits.
4. Applied limits : -13.0 [dBm] = $10\log(TP[mW]) - (43 + 10\log(tp[W])) = 10\log(TP[mW]) - (43 + (10 \log(TP[mW]) - 30))$
 where, $tp[W] = TP[mW] / 1000$: Transmitter power at antenna terminal
5. The symbol of "<" means "or less".
6. The symbol of ">" means "more than".
7. Setting of measuring instrument(s) :

	Detector Function	RES B.W.	V.B.W.	Sweep Time
A	Peak	10 kHz	30 kHz	20 msec.
B	Peak	100 kHz	300 kHz	20 msec.
C	Peak	1 MHz	3 MHz	20 msec.

7.8 Frequency Stability(\$2.1055)

For the requirements, - Applicable - Tested. - Not tested by applicant request.]
 - Not Applicable

For the limits, - Passed - Failed - Not judged

7.8.1 Worst Point and Measurement Uncertainty

The Frequency Stability level is +0.04 ppm at 836.400 MHz

Uncertainty of Measurement Results +/-0.02 ppm(2σ)

Remarks : _____

7.8.2 Test Site

KITA-KANSAI Testing Center

Test site : SAITO - Environment Testing Room
 MINOH - Environment Testing Room

7.8.3 Test Instruments

Type	Model	Manufacturer	ID No.	Last Cal.	Interval
Universal Radio Communication Tester	CMU200	Rohde & Schwarz	B-21	2013/4	1 Year
DC Voltage Meter	2011-39	YEW	B-33	2013/4	1 Year
Environmental Chamber	SH-641	ESPEC	F-32	2013/7	1 Year
DC Power Supply	NL035-10	TAKASAGO	F-4	N/A	N/A

7.8.4 Test Method and Test Setup (Diagrammatic illustration)

Frequency Stability versus Temperature

The EUT was placed in an environmental chamber and was tested in the range from -30 to +50 degrees Celsius. The EUT was stabilized at each temperature. The power (4.0VDC) supplied was applied to the transmitter and allowed to stabilize for 10 minutes. The transmitting frequency was measured at startup and 2 minutes, 5 minutes and 10 minutes after startup. This procedure was repeated from -30 to +50 degrees Celsius at the interval of 10 degrees.

Frequency Stability versus Power Supply Voltage

The EUT was placed in an environmental chamber and was tested at the temperature of +20 degrees Celsius. The EUT was stabilized at the temperature. The power (4.0VDC) and the power (3.7VDC, the ending voltage) was applied to the EUT allowed to stabilize for 10 minutes. The transmitting frequency was measured at startup and 2 minutes, 5 minutes and 10 minutes after startup.

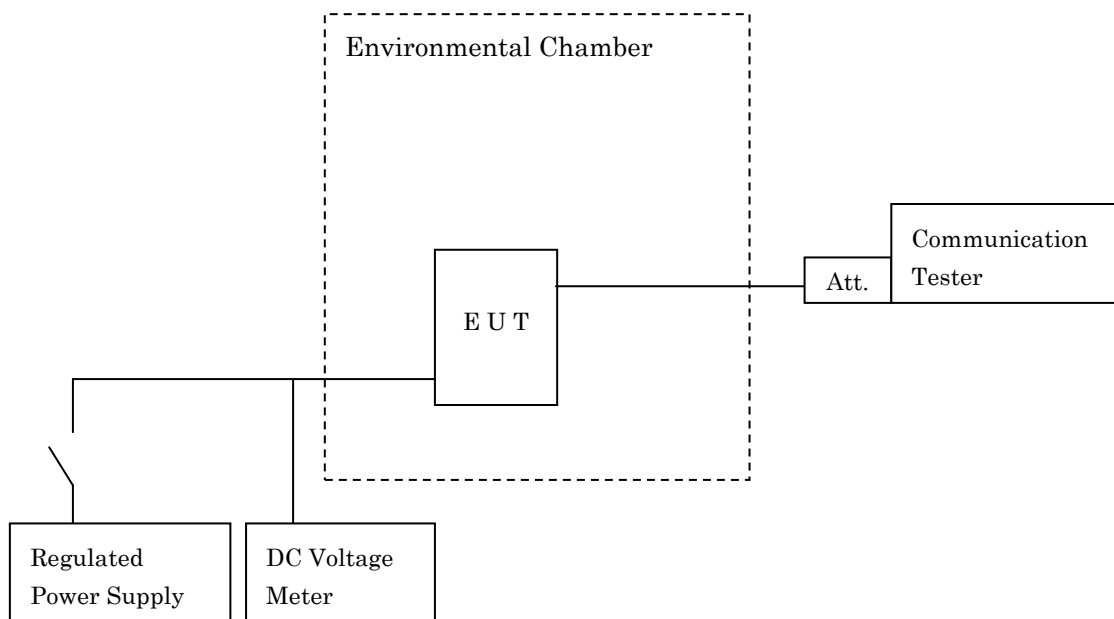

7.8.5 Test Data

(GSM850)

Test Date: September 20, 2013
- September 24, 2013

1. Frequency Stability Measurement versus Temperature

Transmitting Frequency : 836.400 MHz (189 ch)
 DC Supply Voltage : 4.0 VDC

Ambient Temperature [°C]	Startup	Deviation [ppm]			Limits [ppm]	Margin [ppm]
		2 minutes	5 minutes	10 minutes		
-30	<u>+ 0.04</u>	- 0.01	+ 0.02	+ 0.02	2.50	2.46
-20	+ 0.03	+ 0.02	+ 0.02	+ 0.02	2.50	2.47
-10	+ 0.02	+ 0.02	+ 0.02	+ 0.02	2.50	2.48
0	+ 0.02	+ 0.02	+ 0.02	+ 0.02	2.50	2.48
10	+ 0.03	+ 0.02	+ 0.02	+ 0.02	2.50	2.47
20	+ 0.03	+ 0.02	+ 0.02	+ 0.02	2.50	2.47
30	+ 0.03	+ 0.02	+ 0.02	+ 0.02	2.50	2.47
40	- 0.03	+ 0.02	+ 0.02	+ 0.02	2.50	2.47
50	- 0.02	+ 0.02	+ 0.02	+ 0.02	2.50	2.48

2. Frequency Stability Measurement versus Power Supply Voltage

Transmitting Frequency : 836.400 MHz (189 ch)
 Ambient Temperature: : 20 °C

DC Supply Voltage [V]	Startup	Deviation [ppm]			Limits [ppm]	Margin [ppm]
		2 minutes	5 minutes	10 minutes		
4.0	+ 0.03	+ 0.02	+ 0.02	+ 0.02	2.50	2.47
3.7 (Ending)	- 0.03	+ 0.02	+ 0.02	+ 0.02	2.50	2.47

Test condition example as the maximum deviation point shown on underline:

Ambient Temperature : -30 °C / Startup

DC Supply Voltage : 4 VDC

Minimum Margin: 2.50 - 0.04 = 2.46 (ppm)

NOTE : The measurement were made after all of components of the oscillator sufficiently stabilized at each temperature.