

TEST REPORT

Applicant : SHARP CORPORATION
Quality and Environmental Promotion Unit

Address : 1 Takumi-cho, Sakai-ku, Sakai City, Osaka 590-8522, Japan

Products : Microwave Oven

Model No. : R-CD1200M

Serial No. : 11800

FCC ID : APYDMR0169

Test Standard : FCC Rules and Regulations Title 47 CFR Part 18

Test Results : **Passed**

Date of Test : September 19, 2018 ~ October 19, 2018



Kousei Shibata
Manager
Japan Quality Assurance Organization
KITA-KANSAI Testing Center
SAITO EMC Branch
7-3-10, Saito-asagi, Ibaraki-shi, Osaka 567-0085, Japan

- The test results in this test report was made by using the measuring instruments which are traceable to national standards of measurement in accordance with ISO/IEC 17025.
- The applicable standard, testing condition and testing method which were used for the tests are based on the request of the applicant.
- The test results presented in this report relate only to the offered test sample.
- The contents of this test report cannot be used for the purposes, such as advertisement for consumers.
- This test report shall not be reproduced except in full without the written approval of JQA.
- VLAC does not approve, certify or warrant the product by this test report.

TABLE OF CONTENTS

	Page
1 Description of the Equipment Under Test.....	3
2 Summary of Test Results.....	4
3 Test Procedure.....	5
4 Test Location	5
5 Recognition of Test Laboratory.....	5
6 Description of Test Setup.....	6
7 Test Requirements	7

DEFINITIONS FOR ABBREVIATION AND SYMBOLS USED IN THIS TEST REPORT

EUT : Equipment Under Test	EMC : Electromagnetic Compatibility
AE : Associated Equipment	EMI : Electromagnetic Interference
N/A : Not Applicable	EMS : Electromagnetic Susceptibility
N/T : Not Tested	

- indicates that the listed condition, standard or equipment is applicable for this report.
- indicates that the listed condition, standard or equipment is not applicable for this report.

1 Description of the Equipment Under Test

1. Manufacturer : SHARP APPLIANCES (THAILAND) LIMITED
64 Moo 5, Tambol Bangsamak, Amphur Bangpakong
Chachoengsao Province, Thailand
2. Products : Microwave Oven
3. Model No. : R-CD1200M
4. Serial No. : 11800
5. Product Type : Prototype
6. Date of Manufacture : April, 2018
7. Power Rating : 120VAC60Hz, Input:1.9kW
8. Rated RF Power Output : 1200 W
9. EUT Grounding : Grounded at the plug end of the power line
10. Type of Device : Consumer ISM equipment
11. EUT Authorization : Certification
12. Operating Frequency : 2450 MHz(ISM frequency)
13. Received Date of EUT : September 14, 2018

2 Summary of Test Results

Applied Standard : FCC Rules and Regulations Title 47 CFR Part 18
Industrial, Scientific, and Medical Equipment

The EUT described in clause 1 was tested according to the applied standard shown above.
Details of the test configuration is shown in clause 6.

The conclusion for the test items of which are required by the applied standard is indicated under the test result.

- The test result was **passed** for the test requirements of the applied standard.
- The test result was **failed** for the test requirements of the applied standard.
- The test result was **not judged** the test requirements of the applied standard.

In the approval of test results,

- Determining compliance with the limits in this report was based on the results of the compliance measurement, not taking into account measurement instrumentation uncertainty.
- No deviations were employed from the applied standard.
- No modifications were conducted by JQA to achieve compliance to the limitations.

Reviewed by:

Tested by:



Yasuhisa Sakai
Manager
JQA KITA-KANSAI Testing Center
SAITO EMC Branch

Shigeru Kinoshita
Assistant Manager
JQA KITA-KANSAI Testing Center
SAITO EMC Branch

3 Test Procedure

The tests documented in this report were performed in accordance with FCC/OET MP-5 (1986).

4 Test Location

Japan Quality Assurance Organization (JQA)
KITA-KANSAI Testing Center
7-7, Ishimaru, 1-chome, Minoh-shi, Osaka, 562-0027, Japan
SAITO EMC Branch
7-3-10, Saito-asagi, Ibaraki-shi, Osaka 567-0085, Japan

5 Recognition of Test Laboratory

JQA KITA-KANSAI Testing Center SAITO EMC Branch is accredited under ISO/IEC 17025 by following accreditation bodies and the test facility is registered by the following bodies.

VLAC Accreditation No. : VLAC-001-2 (Expiry date : March 30, 2020)
VCCI Registration No. : A-0002 (Expiry date : March 30, 2020)
FCC Accreditation No. : JP5008 (Expiry date : March 30, 2020)
IC Registration No. : 2079E-3, 2079E-4 (Expiry date : June 26, 2020)
BSMI Registration No. : SL2-IS-E-6006, SL2-IN-E-6006, SL2-R1/R2-E-6006, SL2-A1-E-6006
(Expiry date : September 14, 2019)
CNAS Accreditation No. : L8352 (Expiry date : February 19, 2019)

Accredited as conformity assessment body for Japan electrical appliances and material law by METI.
(Expiry date : February 22, 2019)

6 Description of Test Setup

6.1 Test Configuration

The equipment under test (EUT) consists of :

	Item	Manufacturer	Model No.	Serial No.	FCC ID
A	Microwave Oven	Sharp Appliances (Thailand) Ltd.	R-CD1200M	11800	APYDMR0169

The auxiliary equipment used for testing :

None

Type of Cable:

No.	Description	Identification (Manu. etc.)	Connector Shielded	Cable Shielded	Ferrite Core	Length (m)
1	AC Power Cable	--	--	No	No	1.4

6.2 Test Arrangement (Drawings)

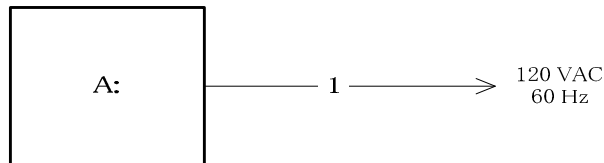

6.3 Operating Condition

Power Supply Voltage : 120VAC 60Hz

Operation Mode

The EUT is tested with the dummy load located in the center of the oven.
 The load consists of a quantity of tap water in a beaker, which is as follows.

- Power output measurement : 1500 ml
- ISM frequency measurement : 1500 ml
- Conducted powerline measurement : 1000 ml
- Radiated emission measurement : 1050 ml

For measurement of radiation on 2nd and 3rd harmonic, two loads, one of 1050 ml and the other of 450 ml, of water are used. Each load is tested both with the beaker located in the center of the oven and with it in the right front corner.

Type of Magnetron

Type No. 2M303K(L) , manufactured by Toshiba

Clock Frequency

- Magnetron : 2450 MHz
- LSI : 4 MHz

7 Test Requirements

7.1 Power Output

For the requirements, - Applicable [- Tested. - Not tested by applicant request.]
 - Not Applicable

7.1.1 Test Results

Power Output (calorimetric method) 1135.2 watts
 Field Strength Limit 37.7 $\mu\text{V/m}$ at 300 meters
 AC Power Input 1948.9 watts

Remarks : Field strength may not exceed 10 $\mu\text{V/m}$ at 1600 meters.

7.1.2 Test Instruments

KITA-KANSAI Testing Center 3 rd Floor Testing Room				
Type	Model	Serial No. (ID)	Manufacturer	Cal. Due
Digital Power Meter	3331	060218709SSS(G4700528)	HIOKI	2019/06/28
Stopwatch	S321-4000	280698(Q47097356)	SEIKO	2019/08/07
Thermometer	245506	74JJ0064(Q47097361)	YOKOGAWA	2019/04/03

NOTE : The calibration interval of the above test instruments is 12 months.

7.1.3 Test Procedure

The power output is measured by the calorimetric method, computing from the observed temperature rise of the load over a period of time. The measured value of power output is used to determine the allowable out-of-band field strength.

7.1.4 Test Data

Test Date: September 19, 2018

Temp.: 25 °C, Humi: 60 %

The power output was measured by the calorimetric method, computing the power output from the observed temperature rise of the load over a period of time.

Rated RF Power: 1200W
 Load(water): 1500ml (750mk 2)
 Time: 53sec $T = \frac{4.2 \times Load(ml) \times 10}{RFPower}$

	t_1 (before test)	t_2 (after test)	$t_2 - t_1$	RF Power**
1st	9.5°C	19.3°C	9.8°C	
	9.4°C	19.1°C	9.7°C	
Average			9.75°C	1159.0W
2nd	9.8°C	19.3°C	9.5°C	
	9.8°C	19.0°C	9.2°C	
Average			9.35°C	1111.4W
3rd	9.5°C	19.4°C	9.9°C	
	9.6°C	19.0°C	9.4°C	
Average			9.65°C	1147.1W
4th	10.0°C	19.8°C	9.8°C	
	9.8°C	19.5°C	9.7°C	
Average			9.75°C	1159.0W
5th	10.0°C	19.4°C	9.4°C	
	10.0°C	19.1°C	9.1°C	
Average			9.25°C	1099.5W

$$**RFPower = \frac{4.2 \times Load(ml) \times (t_2 - t_1)}{T}$$

Results of Average RF Power: 1135.2W

The limit of the radiated emission at 300m : $25\sqrt{1135.2/500}[\mu V/m]=37.7[\mu V/m]$

$25\sqrt{1135.2/500}[\mu V/m]=31.6[dB(\mu V/m)]$

The AC power input to the oven is measured to determine if the oven is operating in accordance with the manufacturer's specifications.

Rated Power Supply:AC120V/60Hz, 1900W

Measured Input Power :AC100V60Hz 16.775A, 1948.9W

7.2 ISM Frequency

For the requirements, - Applicable [- Tested. - Not tested by applicant request.]
 - Not Applicable

7.2.1 Test Results

For the standard, - **Passed** - **Failed** - **Not judged**

Remarks : _____

7.2.2 Test Instruments

Anechoic Chamber A2				
Type	Model	Serial No. (ID)	Manufacturer	Cal. Due
Test Receiver	ESU 26	100170 (A-6)	Rohde & Schwarz	2018/11/09
Horn Antenna	91889-2	568 (C-41-2)	EATON	2019/06/14
Attenuator	2-10	BA6214 (D-79)	Weinschel	2018/11/30
RF Cable	SF104	267415/4 (C-68)	HUBER+SUHNER	2019/01/15

NOTE : The calibration interval of the above test instruments is 12 months.

7.2.3 Test Method and Test Setup (Diagrammatic illustration)

For the EUT was operated with a fundamental frequency in one of the designated band listed in International Telecommunication Union for use as ISM frequencies, the frequency was checked with measuring equipment.

The variation of frequency with time, starting with the EUT and load at the room temperature and continuing until the load quantity has been reduced by evaporation to approximately 20 % of the original quantity. This test is made with nominal rated ac supply voltage.

The variation of frequency for line voltage variation from 80 % to 125 % of nominal rated voltage, starting from the EUT warm from at least 10 minutes use, with the load at room temperature at the beginning of the test.

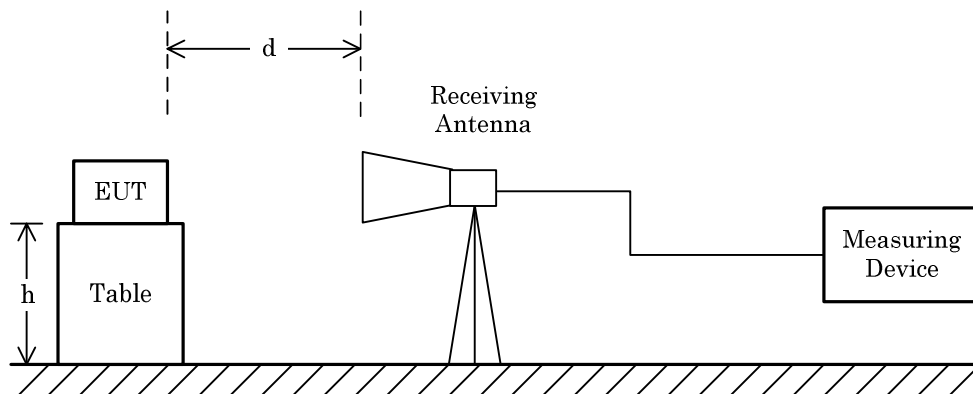

NOTE

- d : Arbitrary distance
- h : Arbitrary height

7.2.4 Test Data

Test Date : October 18, 2018
 Temp. : 23°C Humi. :58 %

1) Variation in Operating Frequency with Time

Power Supply : 120VAC 60Hz

The END time was 20 minutes. The load after 20 minutes was approx 1050ml.

Time	Peak Frequency [MHz]	Remarks
1 minute since START	2465.18	A
1 minute till END	2462.02	A

The results were within 2450MHz±50MHz.

2) Deviation in Operating Frequency with power supply volatage

Power Supply Voltage and time	Peak Frequency [MHz]	Remarks
96V(80%)1 minute since START	2473.40	A
150V(125%)30 seconds since START	2470.26	A

The results were within 2450MHz±50MHz.

Remarks					
	Detector Function	RES B.W.	V.B.W.	Sweep Time	Span
A	Peak	1 MHz	1 MHz	AUTO	200 MHz

7.2.5 Test Setup (Photographs)

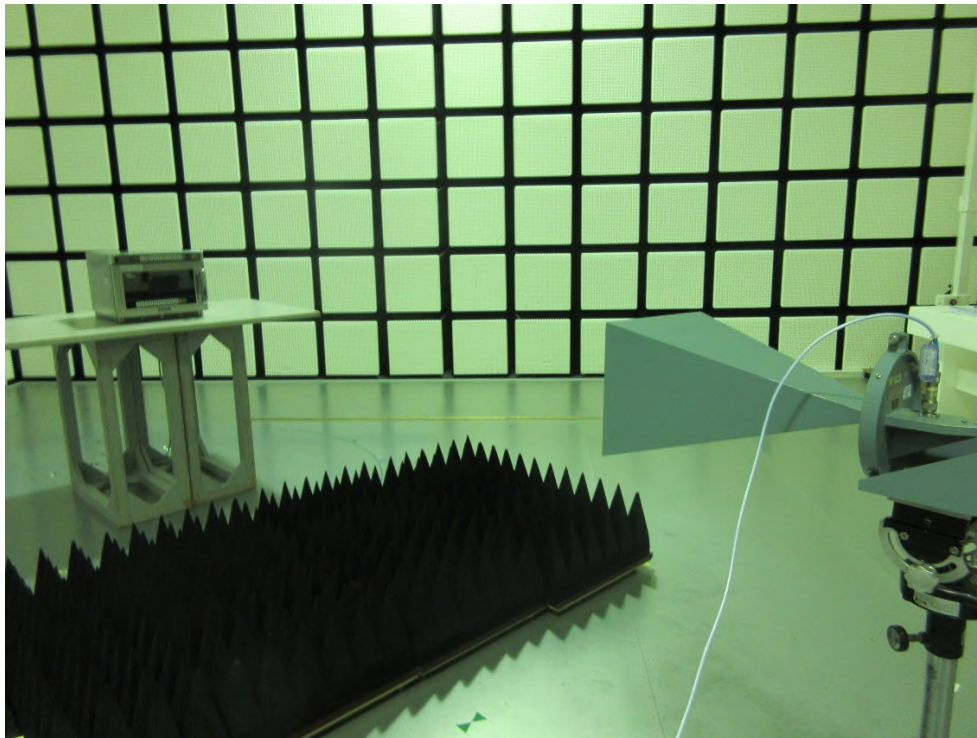

7.3 AC Powerline Conducted Emission

For the requirements, - Applicable [- Tested. - Not tested by applicant request.]
 - Not Applicable

7.3.1 Test Results

For the standard, - Passed - Failed - Not judged

Min. Limit Margin (Quasi-Peak) 17.4 dB at 0.326 MHz

Uncertainty of Measurement Results ± 2.6 dB(2σ)

Remarks : _____

7.3.2 Test Instruments

Shielded Room S2				
Type	Model	Serial No. (ID)	Manufacturer	Cal. Due
Test Receiver	ESCI	100453 (A-42)	Rohde & Schwarz	2018/12/04
AMN (main)	KNW-408	8-1402-2 (D-78)	Kyoritsu	2018/11/19
RF Cable	RG223/U	--- (H-7)	HUBER+SUHNER	2018/11/30

NOTE : The calibration interval of the above test instruments is 12 months.

7.3.3 Test Method and Test Setup (Diagrammatic illustration)

The preliminary tests were performed using the scan mode of test receiver or spectrum analyzer to observe the emissions characteristics of the EUT.

The EUT configuration, cable configuration and mode of operation were determined for producing the maximum level of emissions.

This configurations was used for final tests.

(Reference divisional instruction No. G703649)

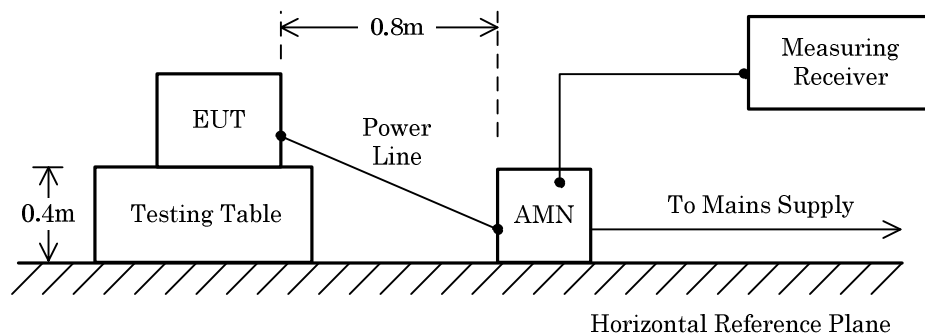

NOTE

AMN : Artificial Mains Network

7.3.4 Test Data

Test voltage : 120VAC 60Hz

Test Date: October 19, 2018

Temp.: 22 °C, RH: 49 %, Atm.: 1000 hPa

Measured phase : L1

Frequency [MHz]	Factor [dB]	Readings [dB(μV)]		Limits [dB(μV)]		Results [dB(μV)]		Margin [dB]		Remarks
		QP	AVE	QP	AVE	QP	AVE	QP	AVE	
0.1500	10.3	35.6	--	66.0	56.0	45.9	--	+ 20.1	--	-
0.2770	10.1	31.6	--	60.9	50.9	41.7	--	+ 19.2	--	-
0.3260	10.1	32.1	--	59.6	49.6	42.2	--	+ 17.4	--	-
0.5000	10.1	26.7	--	56.0	46.0	36.8	--	+ 19.2	--	-
0.7470	10.2	18.6	--	56.0	46.0	28.8	--	+ 27.2	--	-
2.1710	10.2	28.2	--	56.0	46.0	38.4	--	+ 17.6	--	-
13.0925	10.4	18.8	--	60.0	50.0	29.2	--	+ 30.8	--	-
28.9700	10.8	11.2	--	60.0	50.0	22.0	--	+ 38.0	--	-

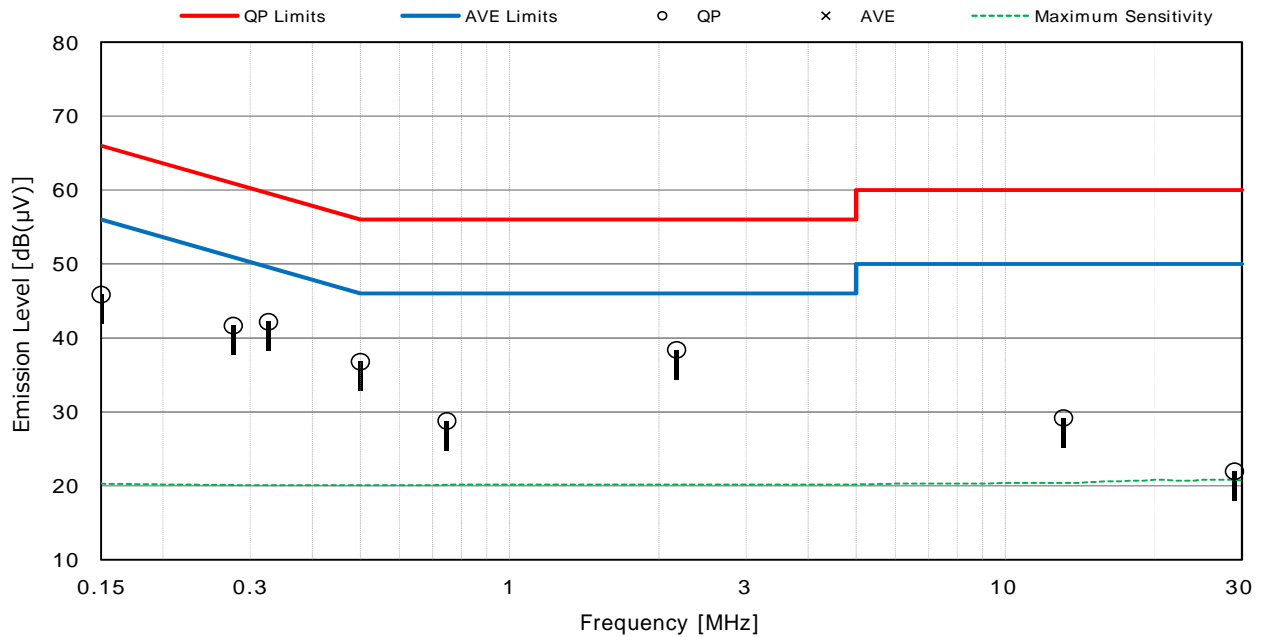

NOTES

- 1) The spectrum was checked from 150 kHz to 30 MHz.
- 2) The factor includes the AMN voltage division factor and the cable loss.
- 3) The symbol of "--" means "not applicable".
- 4) Calculated result as the worst point shown on underline :
 Factor + Reading (QP) = 10.1 + 32.1 = 42.2 dB(μV) at 0.3260 MHz
- 5) QP : Quasi-Peak detector, AVE : Average detector
- 6) Bandwidth : 9 kHz (150 kHz - 30 MHz)

Test voltage : 120VAC 60Hz

Test Date: October 19, 2018

Temp.: 22 °C, RH: 49 %, Atm.: 1000 hPa

Measured phase : L2

Frequency [MHz]	Factor [dB]	Readings [dB(μV)]		Limits [dB(μV)]		Results [dB(μV)]		Margin [dB]		Remarks
		QP	AVE	QP	AVE	QP	AVE	QP	AVE	
0.1500	10.3	37.7	--	66.0	56.0	48.0	--	+ 18.0	--	-
0.2770	10.1	31.7	--	60.9	50.9	41.8	--	+ 19.1	--	-
0.3260	10.1	31.3	--	59.6	49.6	41.4	--	+ 18.2	--	-
0.5000	10.1	25.4	--	56.0	46.0	35.5	--	+ 20.5	--	-
0.7470	10.2	27.5	--	56.0	46.0	37.7	--	+ 18.3	--	-
2.1710	10.2	25.9	--	56.0	46.0	36.1	--	+ 19.9	--	-
6.9200	10.3	10.6	--	60.0	50.0	20.9	--	+ 39.1	--	-
13.0925	10.4	14.9	--	60.0	50.0	25.3	--	+ 34.7	--	-

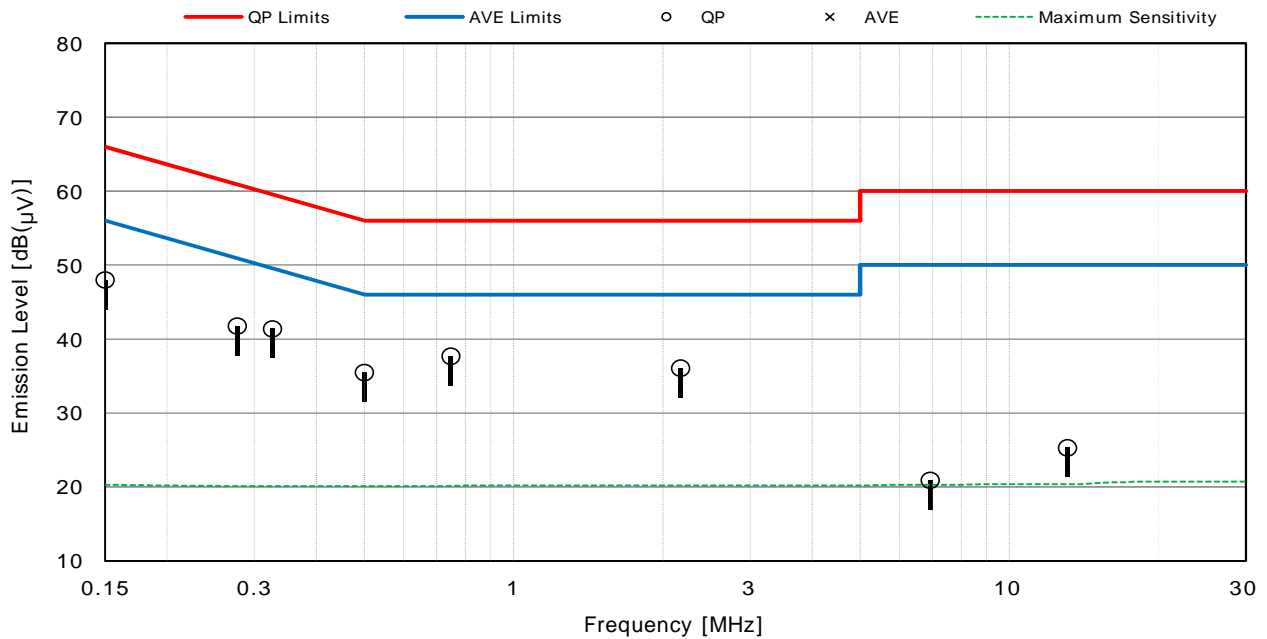

NOTES

- 1) The spectrum was checked from 150 kHz to 30 MHz.
- 2) The factor includes the AMN voltage division factor and the cable loss.
- 3) The symbol of "--" means "not applicable".
- 4) Calculated result as the worst point shown on underline :
 $\text{Factor} + \text{Reading (QP)} = 10.3 + 37.7 = 48.0 \text{ dB}(\mu\text{V})$ at 0.1500 MHz
- 5) QP : Quasi-Peak detector, AVE : Average detector
- 6) Bandwidth : 9 kHz (150 kHz - 30 MHz)

7.3.5 Test Setup (Photographs)

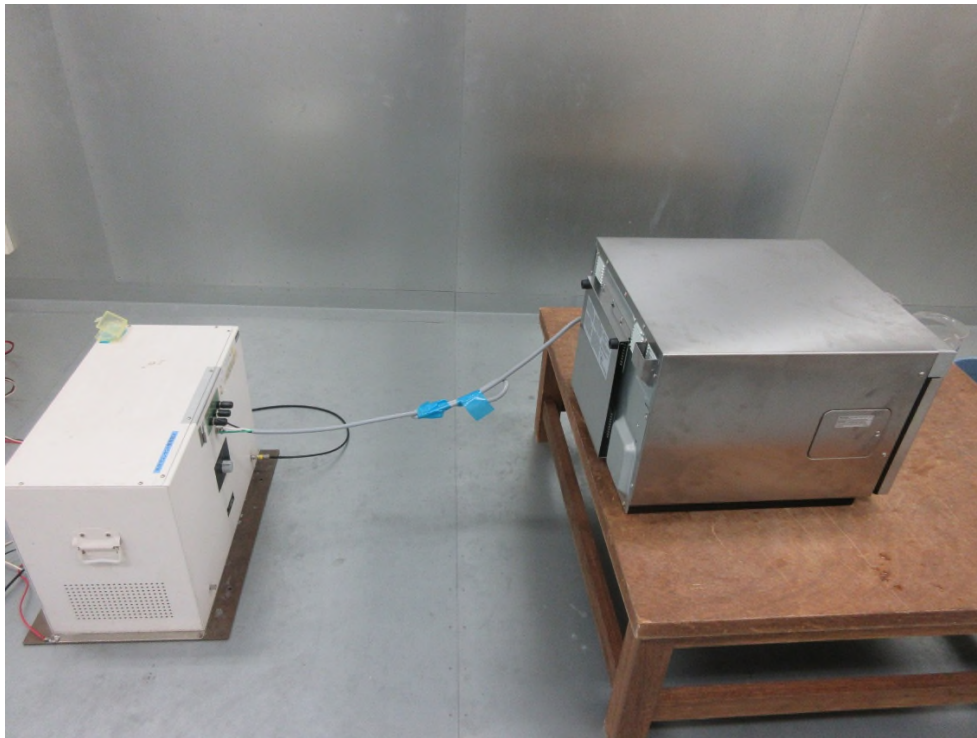

– Side View –

=

Photograph present configuration with maximum emission

7.4 Radiated Emission 9 kHz – 30 MHz

For the requirements, - Applicable [- Tested. - Not tested by applicant request.]
 - Not Applicable

7.4.1 Test Results

For the standard, - Passed - Failed - Not judged

Min. Limit Margin (Average) >15.0 dB at -- MHz

Uncertainty of Measurement Results ± 3.0 dB(2σ)

Test Distance 10 m

Remarks : Field strength limit is calculated $25 \times \text{SQRT}(1135.2\text{W}/500\text{W}) \mu\text{V}/\text{m} (=31.6 \text{ dB}\mu\text{V}/\text{m})$ at 300 m) and the emission levels are calculated using 20dB/decade as attenuation factor.

7.4.2 Test Instruments

Anechoic Chamber A1				
Type	Model	Serial No. (ID)	Manufacturer	Cal. Due
Test Receiver	ESW 44	101618 (A-3)	Rohde & Schwarz	2019/10/01
Loop Antenna	HFH2-Z2	860605/030 (C-3)	Rohde & Schwarz	2019/08/02
RF Cable	S 10162 B-11 etc.	--- (H-3)	HUBER+SUHNER	2019/04/01
RF Cable	RG213/U	--- (H-29)	HUBER+SUHNER	2019/08/02

NOTE : The calibration interval of the above test instruments is 12 months.

7.4.3 Test Method and Test Setup (Diagrammatic illustration)

The preliminary tests were performed at the measurement distance that specified for compliance to determine the emission characteristics of the EUT.

The EUT configuration, cable configuration and mode of operation were determined for producing the maximum level of emissions.

This configurations was used for the final tests.

(Reference divisional instruction No. G703649)

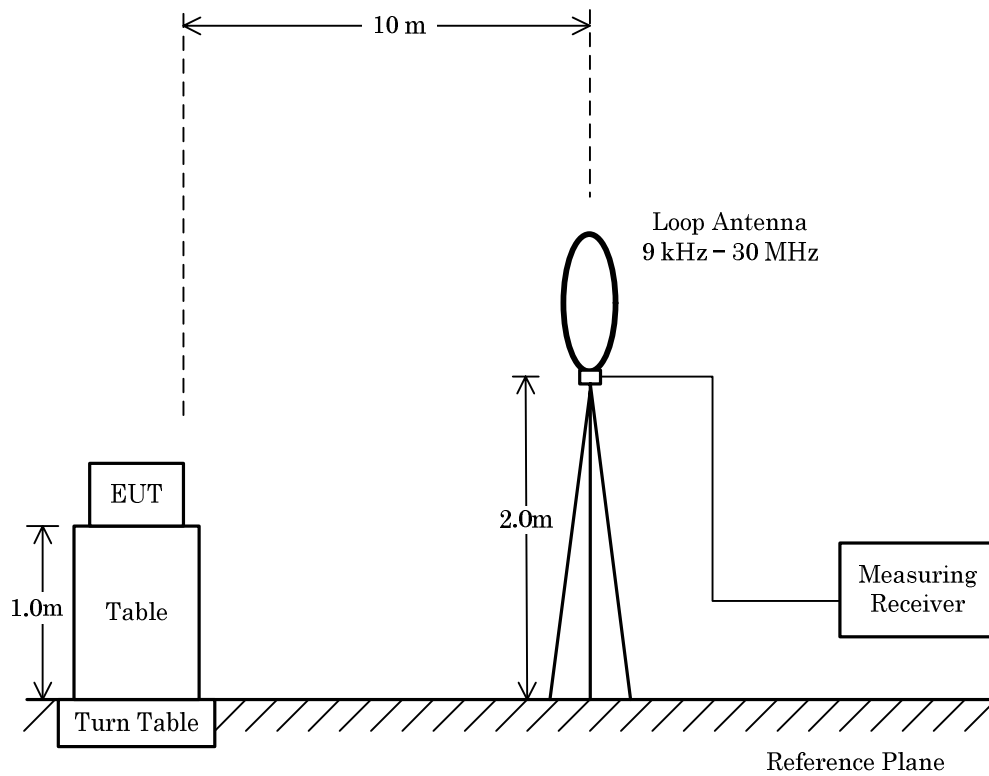

7.4.4 Test Data

Test voltage : 120VAC 60Hz

Test Date: October 5, 2018
 Temp.: 24 °C, RH: 64 %, Atm.: 1006 hPa

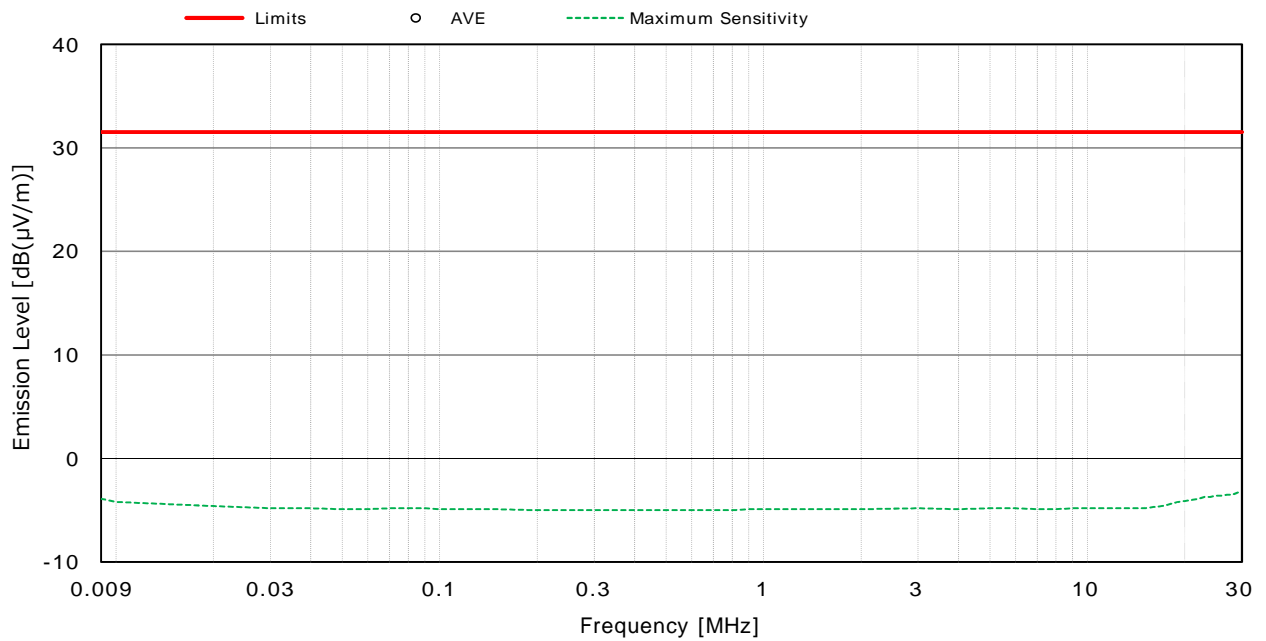

NOTES

- 1) Measurement Distance : 10 m (Specified Distance : 300 m)
- 2) The spectrum was checked from 9 kHz to 30 MHz.
- 3) AVE : Average detector
- 4) Bandwidth : 200 Hz (9 kHz - 150 kHz), 9 kHz (150 kHz - 30 MHz)
- 5) All emission levels were below the noise floor, or more than 15 dB below the applied limits.

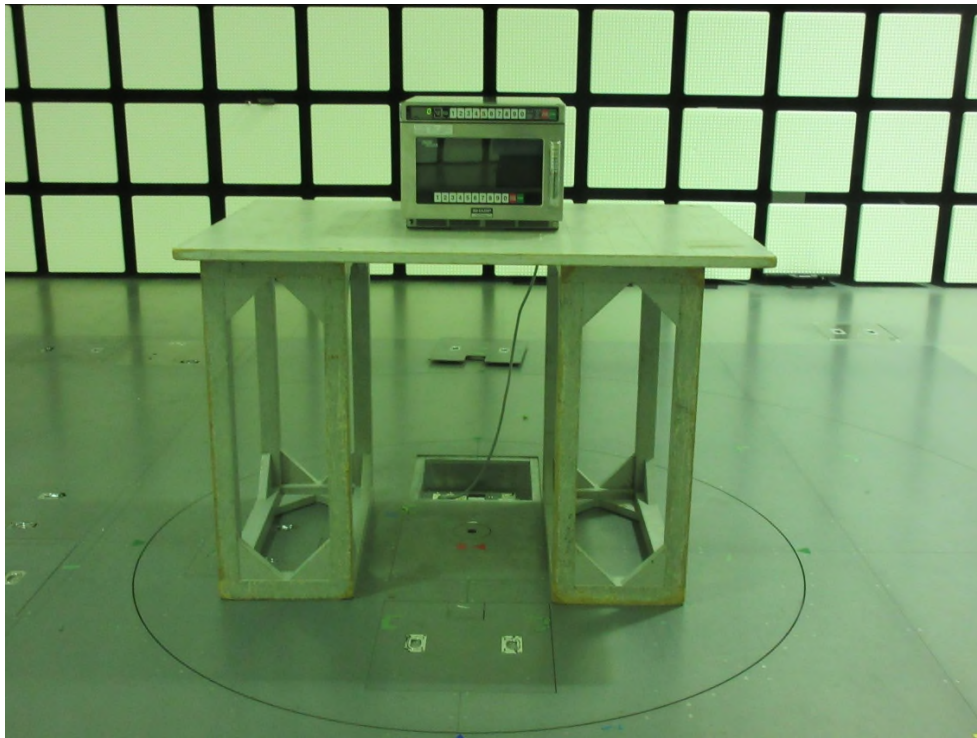
7.4.5 Test Setup (Photographs)

– Front View –

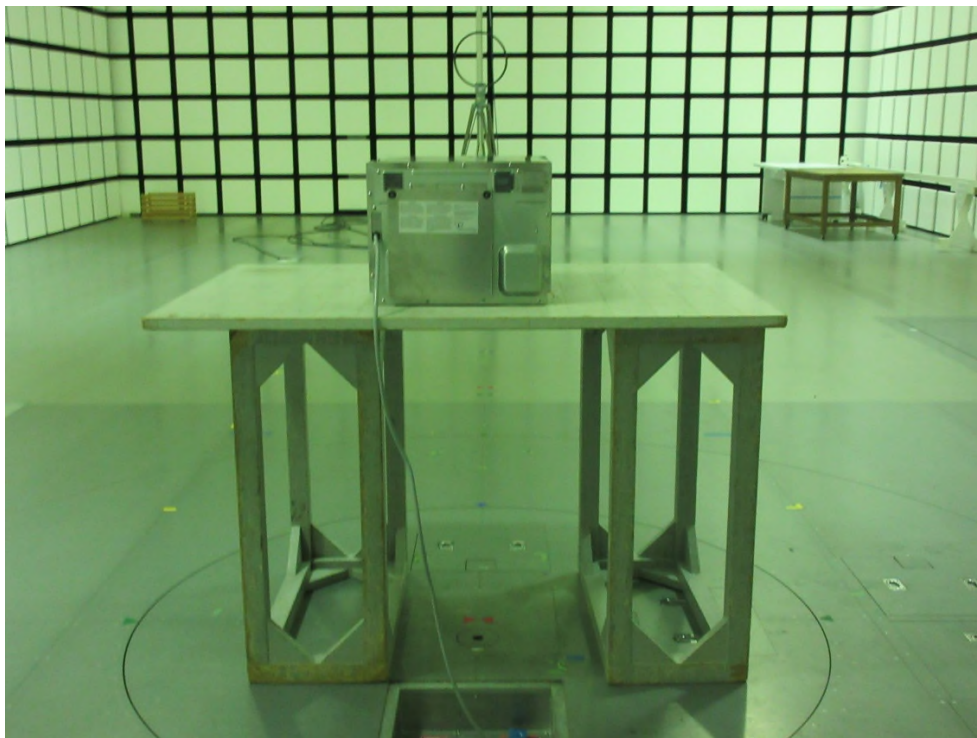

– Rear View –

Photograph present configuration with maximum emission

7.5 Radiated Emission 30 MHz – 1000 MHz

For the requirements, - Applicable [- Tested. - Not tested by applicant request.]
 - Not Applicable

7.5.1 Test Results

For the standard, - Passed - Failed - Not judged

Min. Limit Margin (Average) 49.7 dB at 187.853 MHz

Uncertainty of Measurement Results
 30 MHz – 200 MHz ± 4.2 dB(2σ)
 200 MHz – 1000 MHz ± 3.7 dB(2σ)

Test Distance 10 m

Remarks : Field strength limit is calculated $25 \times \text{SQRT}(1135.2\text{W}/500\text{W}) \mu\text{V}/\text{m} (=31.6 \text{ dB}\mu\text{V}/\text{m})$ at 300 m) and the emission levels are calculated using 20dB/decade as attenuation factor.

7.5.2 Test Instruments

Anechoic Chamber A1				
Type	Model	Serial No. (ID)	Manufacturer	Cal. Due
Test Receiver	ESW 44	101618 (A-3)	Rohde & Schwarz	2019/10/01
Hybrid Antenna	CBL6111D	30644 (C-71)	TESEQ	2018/11/28
Pre-Amplifier	310N	304572 (A-16)	SONOMA	2019/04/01
RF Cable	S 10162 B-11 etc.	--- (H-3)	HUBER+SUHNER	2019/04/01

NOTE : The calibration interval of the above test instruments is 12 months.

7.5.3 Test Method and Test Setup (Diagrammatic illustration)

The preliminary tests were performed at the measurement distance that specified for compliance to determine the emission characteristics of the EUT.

The EUT configuration, cable configuration and mode of operation were determined for producing the maximum level of emissions.

This configurations was used for the final tests.

(Reference divisional instruction No. G703649)

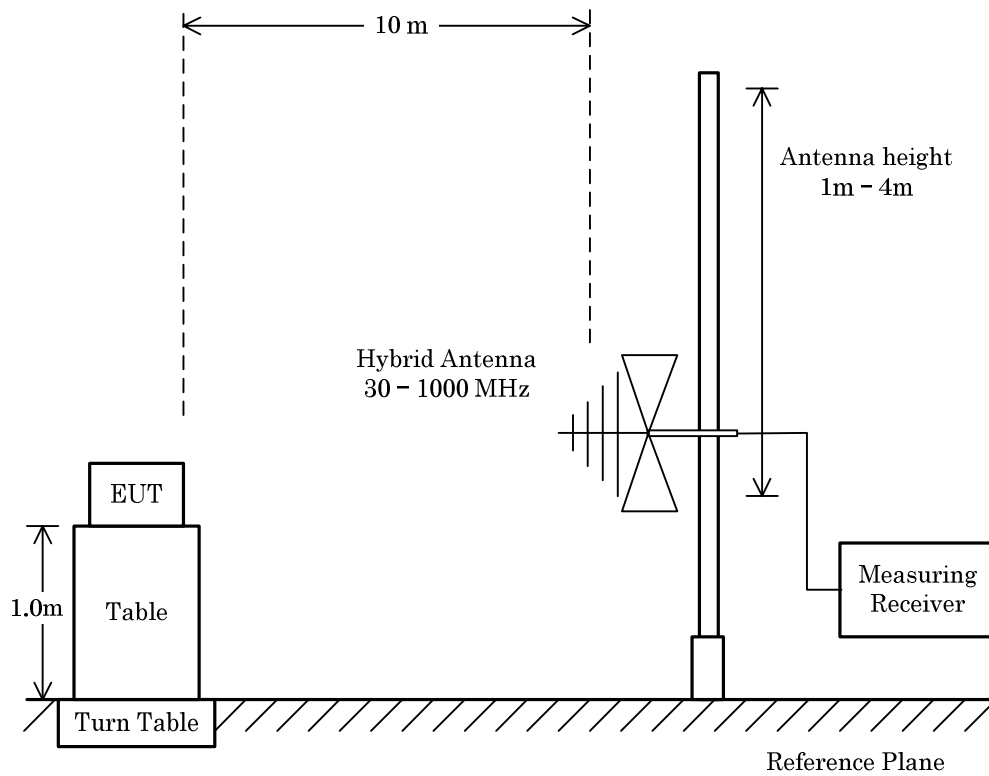

7.5.4 Test Data

Test voltage : 120VAC 60Hz

Test Date: October 5, 2018

Temp.: 24 °C, RH: 64 %, Atm.: 1006 hPa

Antenna polarization : Horizontal

Frequency [MHz]	Factor [dB]	Readings [dB(μV)]	Limits [dB(μV/m)]	Results [dB(μV/m)]	Margin [dB]	Remarks
84.756	-49.1	34.0	31.6	-15.1	+ 46.7	-
106.994	-46.3	27.3	31.6	-19.0	+ 50.6	-

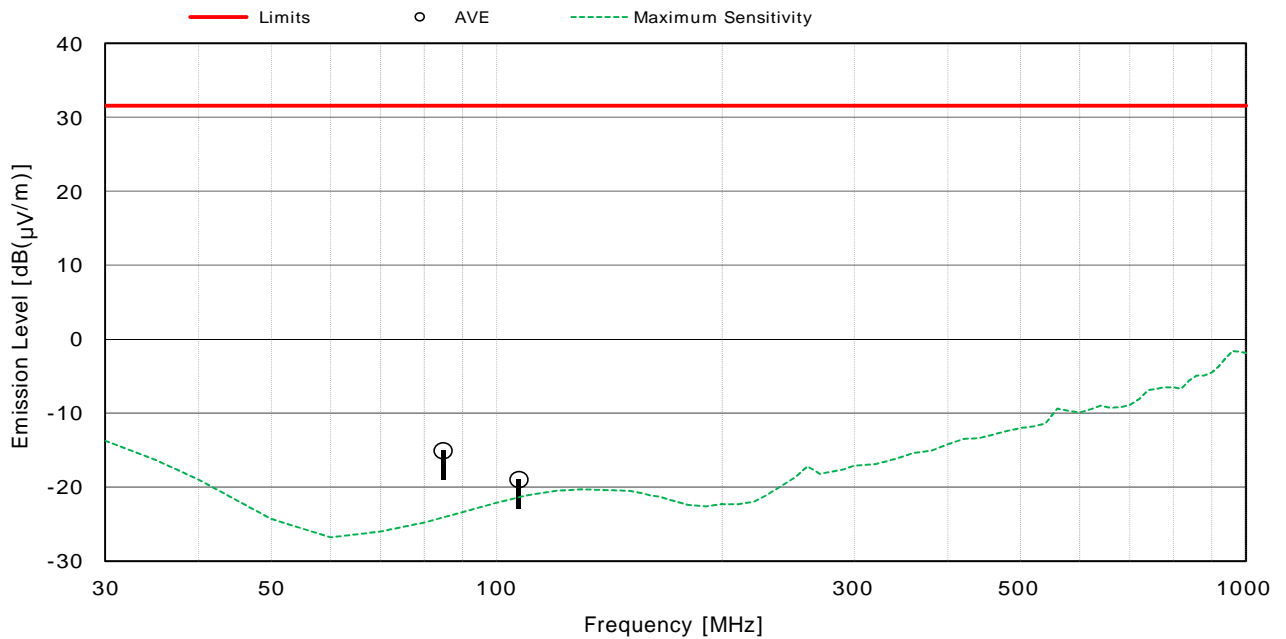

NOTES

- 1) Measurement Distance : 10 m (Specified Distance : 300 m)
- 2) The spectrum was checked from 30 MHz to 1000 MHz.
- 3) The factor includes the antenna factor, the cable loss and the distance conversion.
- 4) Calculated result as the worst point shown on underline :
 Factor + Reading (AVE) = -49.1 + 34.0 = -15.1 dB(μV) at 84.756 MHz
 Antenna Height : 400 cm, Turntable Rotation Position : 238 °
- 5) AVE : Average detector
- 6) Bandwidth : 120 kHz (30 MHz - 1000 MHz)

Test voltage : 120VAC 60Hz

Test Date: October 5, 2018

Temp.: 24 °C, RH: 64 %, Atm.: 1006 hPa

Antenna polarization : Vertical

Frequency [MHz]	Factor [dB]	Readings [dB(μV)]	Limits [dB(μV/m)]	Results [dB(μV/m)]	Margin [dB]	Remarks
49.725	-49.2	29.5	31.6	-19.7	+ 51.3	-
187.583	-47.6	29.5	31.6	-18.1	+ 49.7	-

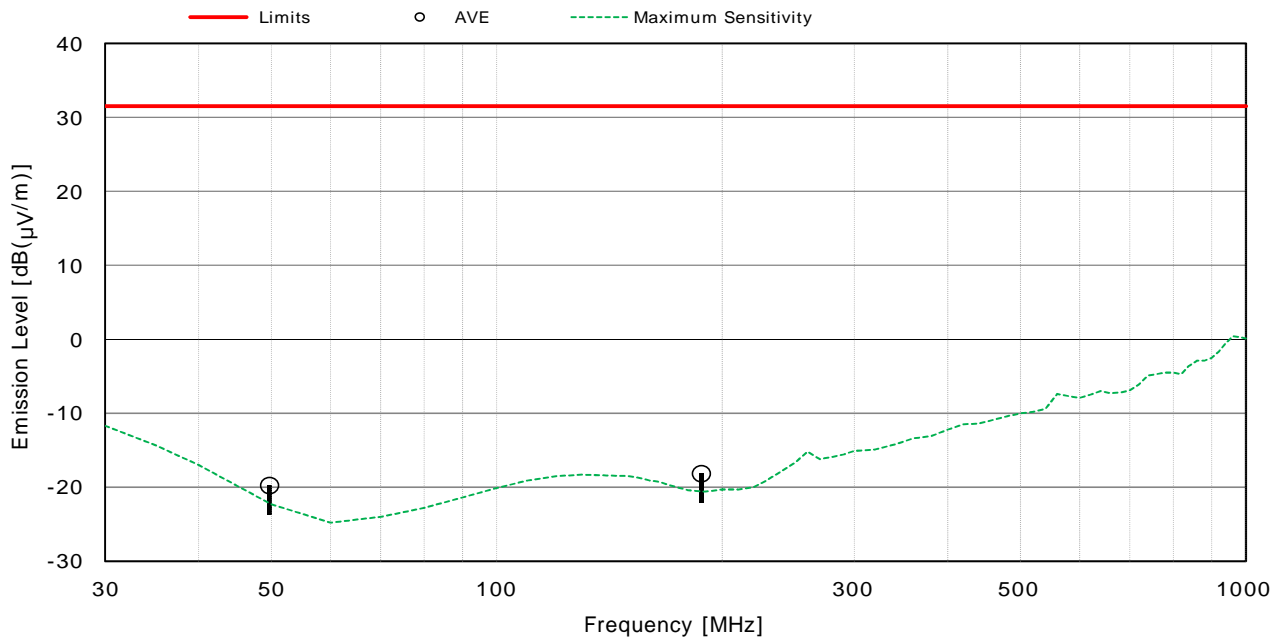

NOTES

- 1) Measurement Distance : 10 m (Specified Distance : 300 m)
- 2) The spectrum was checked from 30 MHz to 1000 MHz.
- 3) The factor includes the antenna factor, the cable loss and the distance conversion.
- 4) Calculated result as the worst point shown on underline :
 Factor + Reading (AVE) = -47.6 + 29.5 = -18.1 dB(μV) at 187.583 MHz
 Antenna Height : 100 cm, Turntable Rotation Position : 145 °
- 5) AVE : Average detector
- 6) Bandwidth : 120 kHz (30 MHz - 1000 MHz)

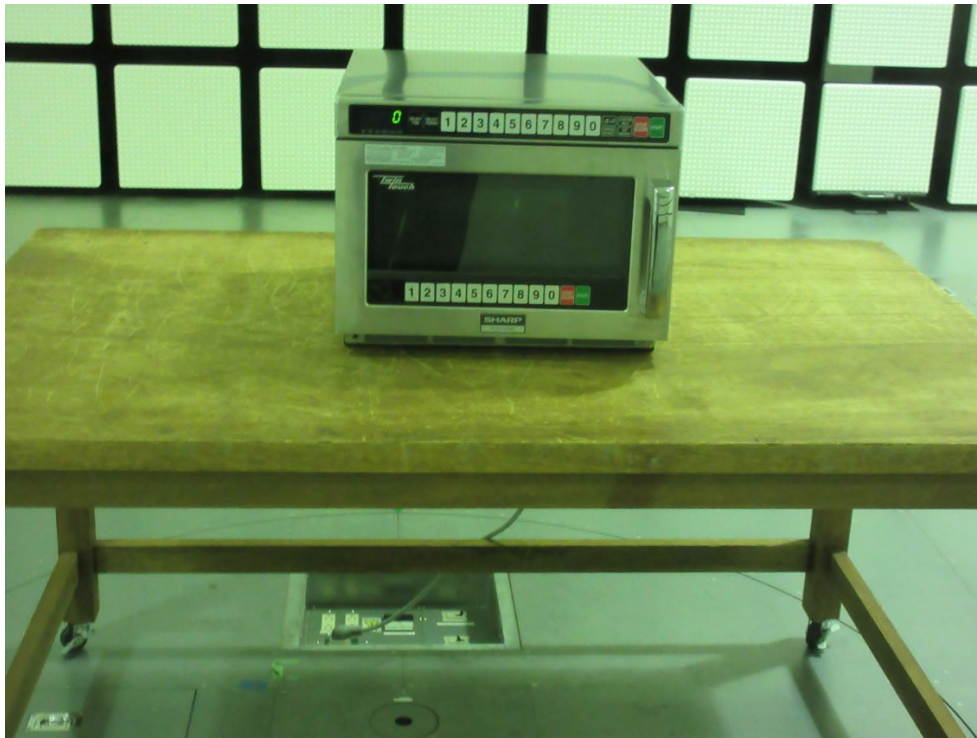
7.5.5 Test Setup (Photographs)

– Front View –

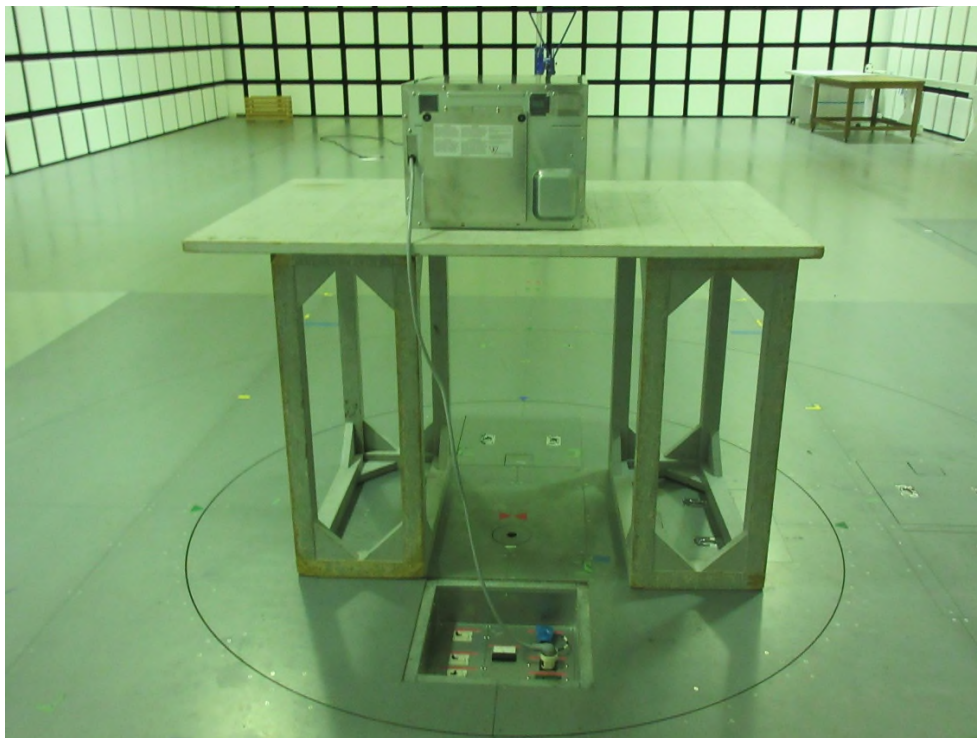

– Rear View –

Photograph present configuration with maximum emission

7.6 Radiated Emission 1 GHz – 25 GHz

For the requirements, - Applicable [- Tested. - Not tested by applicant request.]
 - Not Applicable

7.6.1 Test Results

For the standard, - **Passed** - **Failed** - **Not judged**

Min. Limit Margin (Average) 11.0 dB at 4935.60 MHz

Uncertainty of Measurement Results

1 GHz – 6 GHz	<u>± 4.7</u>	dB(2σ)
6 GHz – 18 GHz	<u>± 4.6</u>	dB(2σ)
18 GHz – 40 GHz	<u>± 5.5</u>	dB(2σ)

Test Distance 3 m

Remarks : Field strength limit is calculated $25 \times \text{SQRT}(1135.2\text{W}/500\text{W}) \mu\text{V}/\text{m} (=31.6 \text{ dB}\mu\text{V}/\text{m})$ at 300 m) and the emission levels are calculated using 20dB/decade as attenuation factor.

7.6.2 Test Instruments

Anechoic Chamber A2				
Type	Model	Serial No. (ID)	Manufacturer	Cal. Due
Test Receiver	ESU 26	100170 (A-6)	Rohde & Schwarz	2018/11/09
Horn Antenna	91888-2	562 (C-41-1)	EATON	2019/06/14
Horn Antenna	91889-2	568 (C-41-2)	EATON	2019/06/14
Horn Antenna	3160-04	9903-1053 (C-55)	EMCO	2019/06/14
Horn Antenna	3160-05	9902-1061 (C-56)	EMCO	2019/06/14
Horn Antenna	3160-06	9712-1045 (C-57)	EMCO	2019/06/14
Horn Antenna	3160-07	9902-1113 (C-58)	EMCO	2019/06/14
Horn Antenna	3160-08	9904-1099 (C-59)	EMCO	2019/06/14
Horn Antenna	3160-09	9808-1117 (C-48)	EMCO	2019/06/24
Pre-Amplifier	WJ-6882-824	0048 (A-21)	Watkins Johnson	2019/01/10
Pre-Amplifier	WJ-6611-513	0289 (A-23)	Watkins Johnson	2019/01/10
Pre-Amplifier	DBL-0618N515	001 9830 (A-33)	DBS Microwave	2019/01/10
Pre-Amplifier	RP1826G-45H	RP140121-11 (A-53)	EMCS	2019/06/24
Attenuator	2-10	BA6214 (D-79)	Weinschel	2018/11/30
RF Cable	SF104	37210/4 (C-40-14)	HUBER+SUHNER	2019/01/15
RF Cable	SF104	267415/4 (C-68)	HUBER+SUHNER	2019/01/15
RF Cable	SF102EA	3041/2EA (C-69)	HUBER+SUHNER	2019/01/10

NOTE : The calibration interval of the above test instruments is 12 months.

7.6.3 Test Method and Test Setup (Diagrammatic illustration)

The preliminary tests were performed at the measurement distance that specified for compliance to determine the emission characteristics of the EUT.

The EUT configuration, cable configuration and mode of operation were determined for producing the maximum level of emissions.

This configurations was used for the final tests.

(Reference divisional instruction No. G703649)

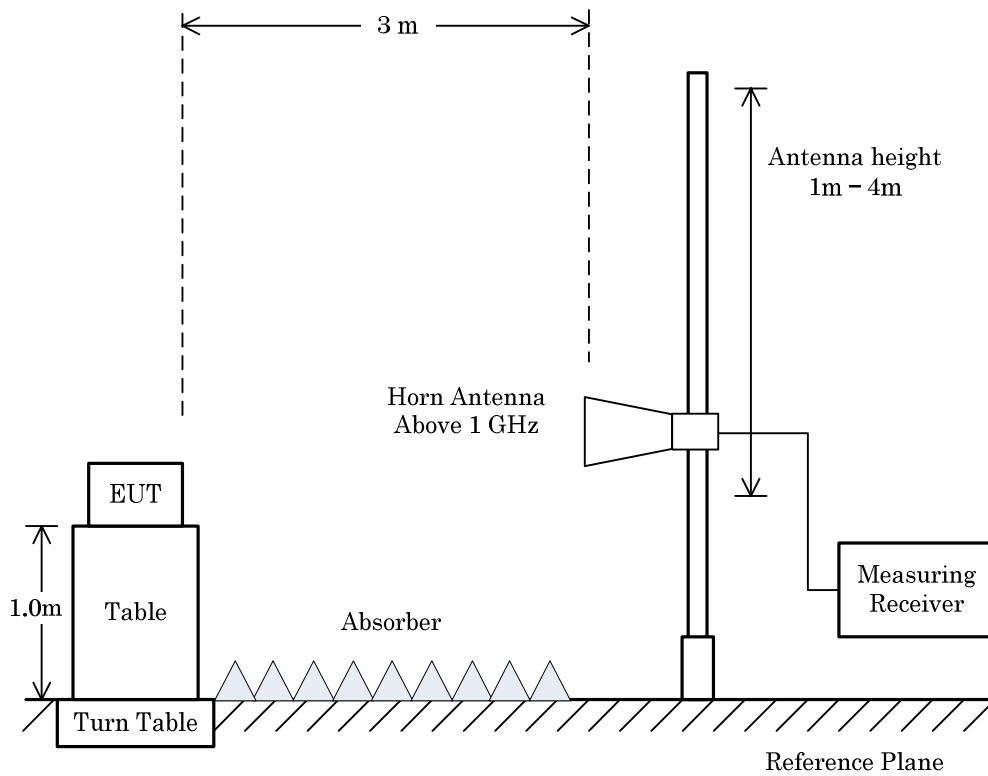

7.6.4 Test Data

Test voltage : 120VAC 60Hz
 Test condition : Center 1050ml
 Antenna polarization : Horizontal

Test Date: October 17, 2018
 Temp.: 19 °C, RH: 65 %, Atm.: 996 hPa

Frequency [MHz]	Factor [dB]	Readings [dB(μV)]	Limits [dB(μV/m)]	Results [dB(μV/m)]	Margin [dB]	Remarks
2361.00	- 8.0	14.4	31.6	6.4	+ 25.2	-
2789.60	- 7.6	18.5	31.6	10.9	+ 20.7	-
4931.60	-43.3	52.8	31.6	9.5	+ 22.1	-
7397.80	-39.0	50.6	31.6	11.6	+ 20.0	-
8624.70	-32.6	38.2	31.6	5.6	+ 26.0	-
10096.90	-32.4	34.3	31.6	1.9	+ 29.7	-
17244.70	-28.1	36.0	31.6	7.9	+ 23.7	-
19722.60	-41.9	49.8	31.6	7.9	+ 23.7	-
22156.20	-42.1	39.3	31.6	- 2.8	+ 34.4	-
24624.20	-42.1	39.0	31.6	- 3.1	+ 34.7	-

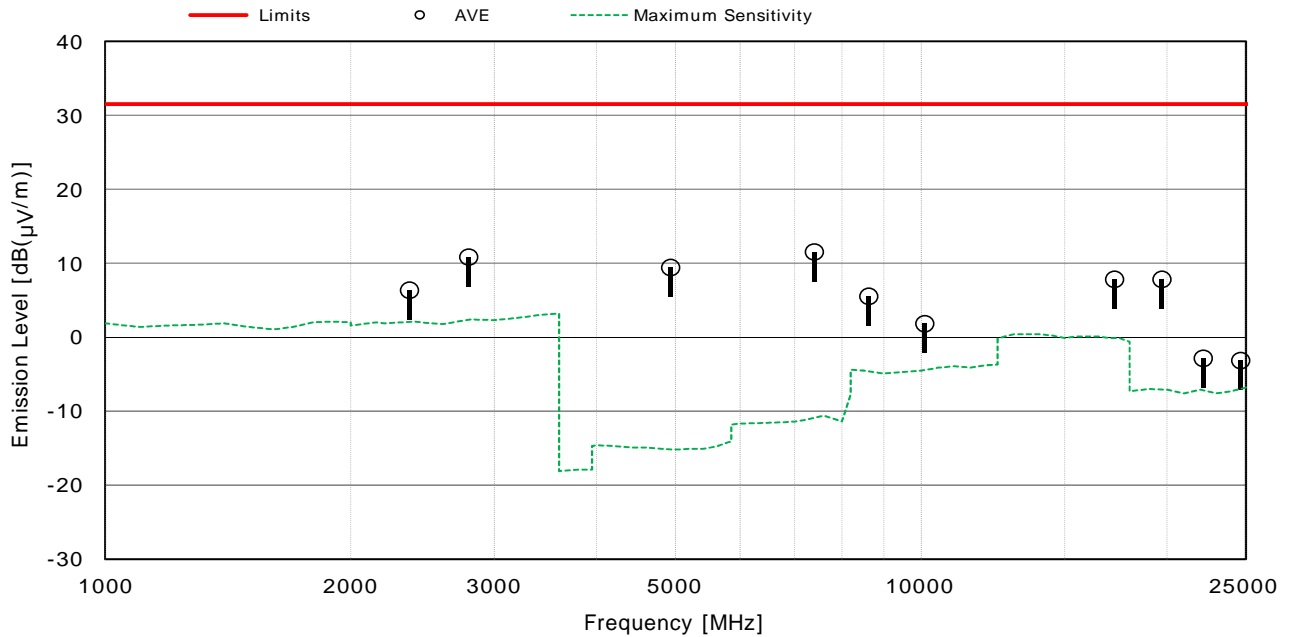

NOTES

- 1) Measurement Distance : 3 m (Specified Distance : 300 m)
- 2) The spectrum was checked from 1 GHz to 25 GHz.
- 3) The factor includes the antenna factor, the pre-amplifier gain, the cable loss and the distance conversion.
- 4) Calculated result as the worst point shown on underline :
 Factor + Reading (AVE) = -39.0 + 50.6 = 11.6 dB(μV) at 7397.80 MHz
 Antenna Height : 118 cm, Turntable Rotation Position : 355 °
- 5) AVE : Average detector
- 6) Bandwidth : 1 MHz (1 GHz - 25 GHz)

Test voltage : 120VAC 60Hz
 Test condition : Center 1050ml
 Antenna polarization : Vertical

Test Date: October 17, 2018
 Temp.: 19 °C, RH: 65 %, Atm.: 996 hPa

Frequency [MHz]	Factor [dB]	Readings [dB(μV)]	Limits [dB(μV/m)]	Results [dB(μV/m)]	Margin [dB]	Remarks
2361.00	- 8.0	23.8	31.6	15.8	+ 15.8	-
2789.60	- 7.6	15.4	31.6	7.8	+ 23.8	-
4931.60	-43.3	52.1	31.6	8.8	+ 22.8	-
7397.80	-39.0	42.1	31.6	3.1	+ 28.5	-
8624.70	-32.6	44.6	31.6	12.0	+ 19.6	-
10096.90	-32.4	36.5	31.6	4.1	+ 27.5	-
17244.70	-28.1	39.0	31.6	10.9	+ 20.7	-
19722.60	-41.9	50.0	31.6	8.1	+ 23.5	-
22156.20	-42.1	44.3	31.6	2.2	+ 29.4	-
24624.20	-42.1	43.2	31.6	1.1	+ 30.5	-

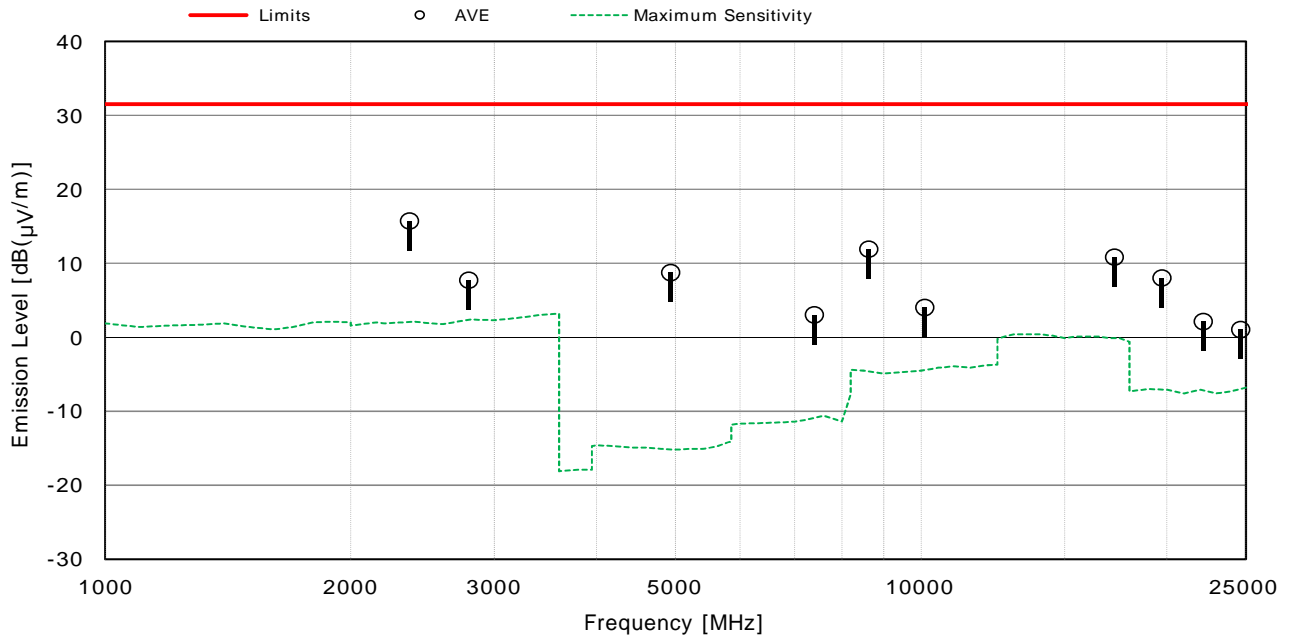

NOTES

- 1) Measurement Distance : 3 m (Specified Distance : 300 m)
- 2) The spectrum was checked from 1 GHz to 25 GHz.
- 3) The factor includes the antenna factor, the pre-amplifier gain, the cable loss and the distance conversion.
- 4) Calculated result as the worst point shown on underline :
 Factor + Reading (AVE) = -8.0 + 23.8 = 15.8 dB(μV) at 2361.00 MHz
 Antenna Height : 118 cm, Turntable Rotation Position : 14 °
- 5) AVE : Average detector
- 6) Bandwidth : 1 MHz (1 GHz - 25 GHz)

Test voltage : 120VAC 60Hz
 Test condition : Center 450ml
 Antenna polarization : Horizontal

Test Date: October 17, 2018
 Temp.: 19 °C, RH: 65 %, Atm.: 996 hPa

Frequency [MHz]	Factor [dB]	Readings [dB(μV)]	Limits [dB(μV/m)]	Results [dB(μV/m)]	Margin [dB]	Remarks
4933.00	-43.3	60.3	31.6	17.0	+ 14.6	-
7395.80	-39.0	46.9	31.6	7.9	+ 23.7	-

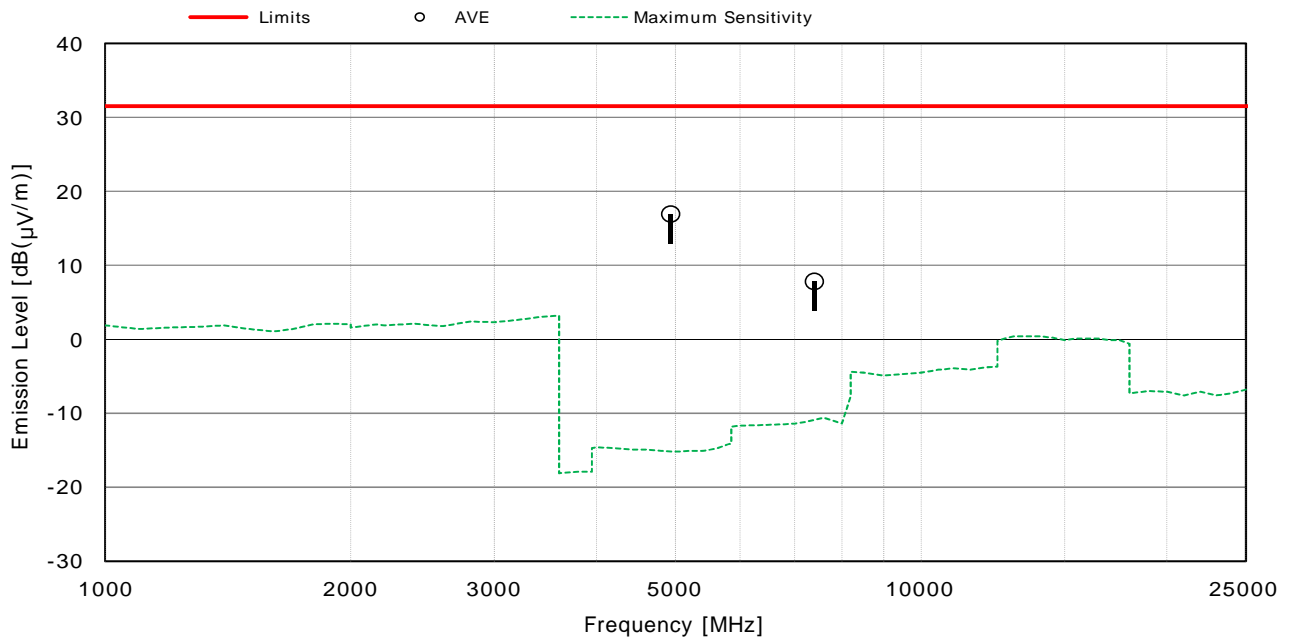

NOTES

- 1) Measurement Distance : 3 m (Specified Distance : 300 m)
- 2) The spectrum was checked from 1 GHz to 25 GHz.
- 3) The factor includes the antenna factor, the pre-amplifier gain, the cable loss and the distance conversion.
- 4) Calculated result as the worst point shown on underline :
 Factor + Reading (AVE) = -43.3 + 60.3 = 17.0 dB(μV) at 4933.00 MHz
 Antenna Height : 118 cm, Turntable Rotation Position : 323 °
- 5) AVE : Average detector
- 6) Bandwidth : 1 MHz (1 GHz - 25 GHz)

Test voltage : 120VAC 60Hz
 Test condition : Center 450ml
 Antenna polarization : Vertical

Test Date: October 17, 2018
 Temp.: 19 °C, RH: 65 %, Atm.: 996 hPa

Frequency [MHz]	Factor [dB]	Readings [dB(μV)]	Limits [dB(μV/m)]	Results [dB(μV/m)]	Margin [dB]	Remarks
4933.00	-43.3	59.7	31.6	16.4	+ 15.2	-
7395.80	-39.0	45.1	31.6	6.1	+ 25.5	-

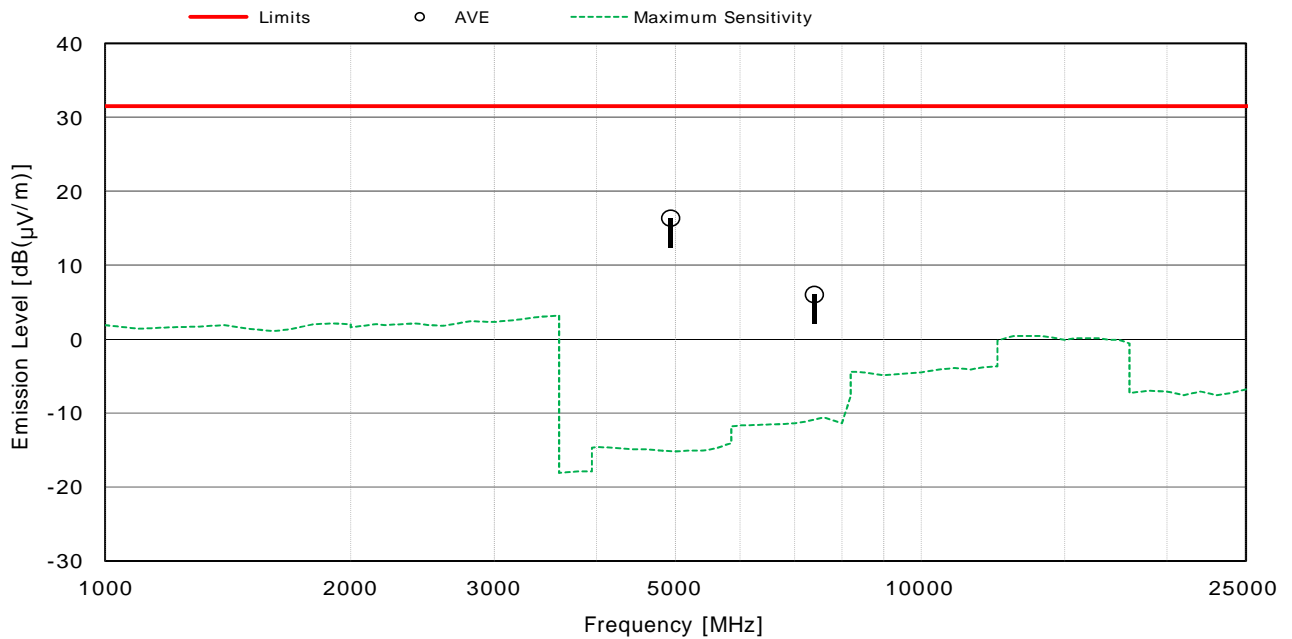

NOTES

- 1) Measurement Distance : 3 m (Specified Distance : 300 m)
- 2) The spectrum was checked from 1 GHz to 25 GHz.
- 3) The factor includes the antenna factor, the pre-amplifier gain, the cable loss and the distance conversion.
- 4) Calculated result as the worst point shown on underline :
 Factor + Reading (AVE) = -43.3 + 59.7 = 16.4 dB(μV) at 4933.00 MHz
 Antenna Height : 118 cm, Turntable Rotation Position : 12 °
- 5) AVE : Average detector
- 6) Bandwidth : 1 MHz (1 GHz - 25 GHz)

Test voltage : 120VAC 60Hz
 Test condition : Front Right Corner 1050ml
 Antenna polarization : Horizontal

Test Date: October 17, 2018
 Temp.: 19 °C, RH: 65 %, Atm.: 996 hPa

Frequency [MHz]	Factor [dB]	Readings [dB(μV)]	Limits [dB(μV/m)]	Results [dB(μV/m)]	Margin [dB]	Remarks
4914.80	-43.3	50.6	31.6	7.3	+ 24.3	-
7413.10	-39.0	40.4	31.6	1.4	+ 30.2	-

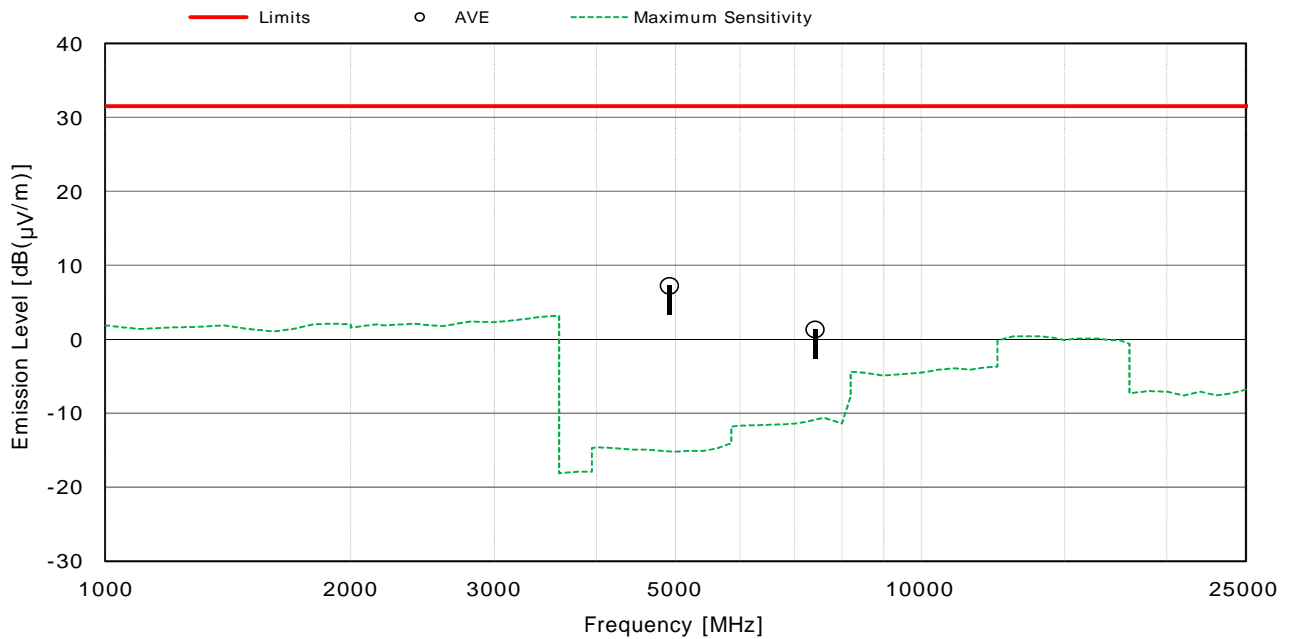

NOTES

- 1) Measurement Distance : 3 m (Specified Distance : 300 m)
- 2) The spectrum was checked from 1 GHz to 25 GHz.
- 3) The factor includes the antenna factor, the pre-amplifier gain, the cable loss and the distance conversion.
- 4) Calculated result as the worst point shown on underline :
 Factor + Reading (AVE) = -43.3 + 50.6 = 7.3 dB(μV) at 4914.80 MHz
 Antenna Height : 118 cm, Turntable Rotation Position : 300 °
- 5) AVE : Average detector
- 6) Bandwidth : 1 MHz (1 GHz - 25 GHz)

Test voltage : 120VAC 60Hz
 Test condition : Front Right Corner 1050ml
 Antenna polarization : Vertical

Test Date: October 17, 2018
 Temp.: 19 °C, RH: 65 %, Atm.: 996 hPa

Frequency [MHz]	Factor [dB]	Readings [dB(μV)]	Limits [dB(μV/m)]	Results [dB(μV/m)]	Margin [dB]	Remarks
4914.80	-43.3	54.3	31.6	11.0	+ 20.6	-
7413.10	-39.0	48.3	31.6	9.3	+ 22.3	-

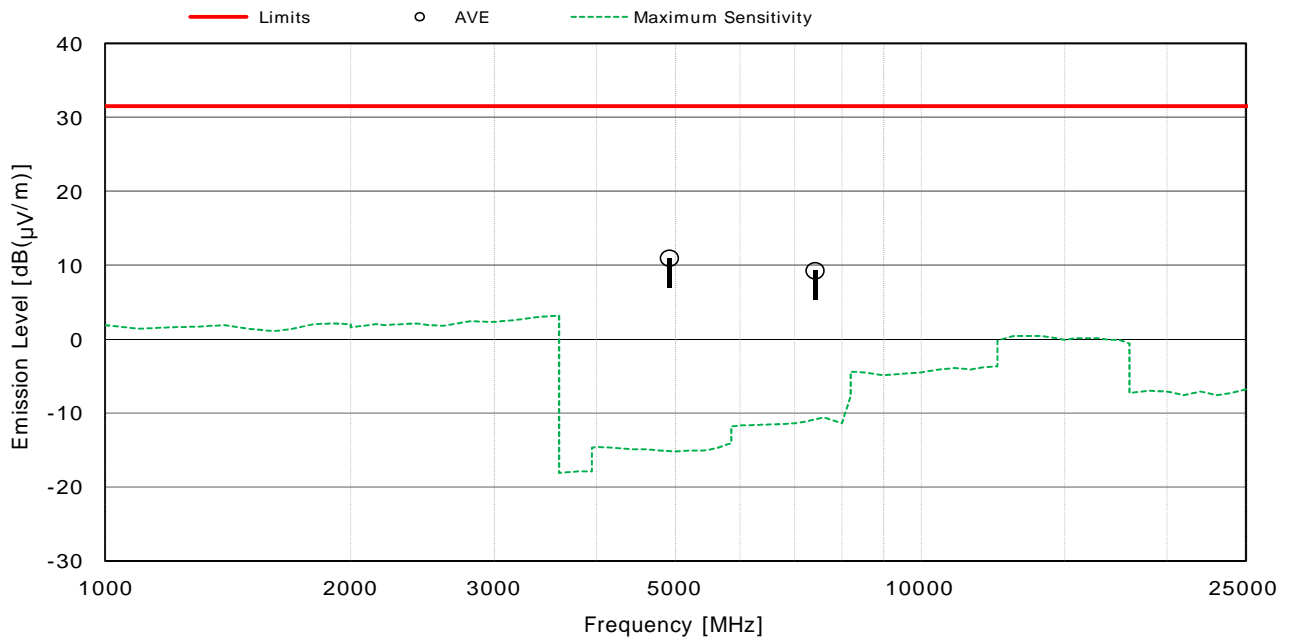

NOTES

- 1) Measurement Distance : 3 m (Specified Distance : 300 m)
- 2) The spectrum was checked from 1 GHz to 25 GHz.
- 3) The factor includes the antenna factor, the pre-amplifier gain, the cable loss and the distance conversion.
- 4) Calculated result as the worst point shown on underline :
 Factor + Reading (AVE) = -43.3 + 54.3 = 11.0 dB(μV) at 4914.80 MHz
 Antenna Height : 118 cm, Turntable Rotation Position : 12 °
- 5) AVE : Average detector
- 6) Bandwidth : 1 MHz (1 GHz - 25 GHz)

Test voltage : 120VAC 60Hz
 Test condition : Front Right Corner 450ml
 Antenna polarization : Horizontal

Test Date: October 17, 2018
 Temp.: 19 °C, RH: 65 %, Atm.: 996 hPa

Frequency [MHz]	Factor [dB]	Readings [dB(μV)]	Limits [dB(μV/m)]	Results [dB(μV/m)]	Margin [dB]	Remarks
4935.60	-43.3	58.1	31.6	14.8	+ 16.8	-
7397.20	-39.0	41.0	31.6	2.0	+ 29.6	-

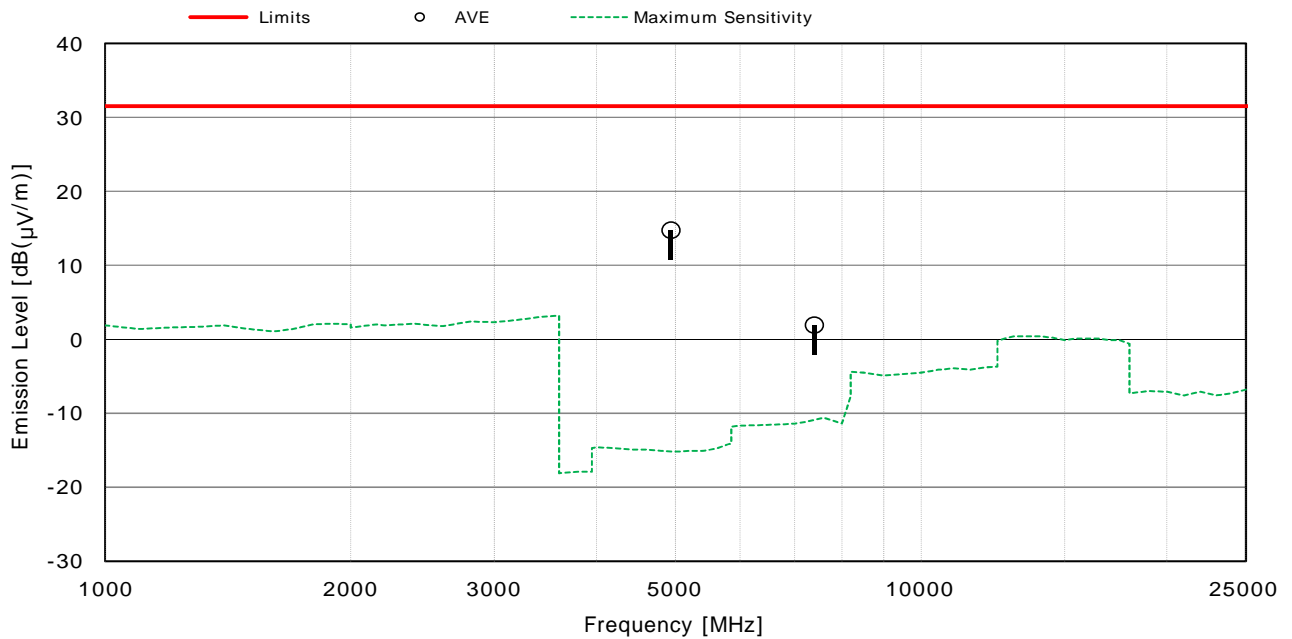

NOTES

- 1) Measurement Distance : 3 m (Specified Distance : 300 m)
- 2) The spectrum was checked from 1 GHz to 25 GHz.
- 3) The factor includes the antenna factor, the pre-amplifier gain, the cable loss and the distance conversion.
- 4) Calculated result as the worst point shown on underline :
 Factor + Reading (AVE) = -43.3 + 58.1 = 14.8 dB(μV) at 4935.60 MHz
 Antenna Height : 118 cm, Turntable Rotation Position : 22 °
- 5) AVE : Average detector
- 6) Bandwidth : 1 MHz (1 GHz - 25 GHz)

Test voltage : 120VAC 60Hz
 Test condition : Front Right Corner 450ml
 Antenna polarization : Vertical

Test Date: October 17, 2018
 Temp.: 19 °C, RH: 65 %, Atm.: 996 hPa

Frequency [MHz]	Factor [dB]	Readings [dB(μV)]	Limits [dB(μV/m)]	Results [dB(μV/m)]	Margin [dB]	Remarks
4935.60	-43.3	63.9	31.6	20.6	+ 11.0	-
7397.20	-39.0	46.0	31.6	7.0	+ 24.6	-

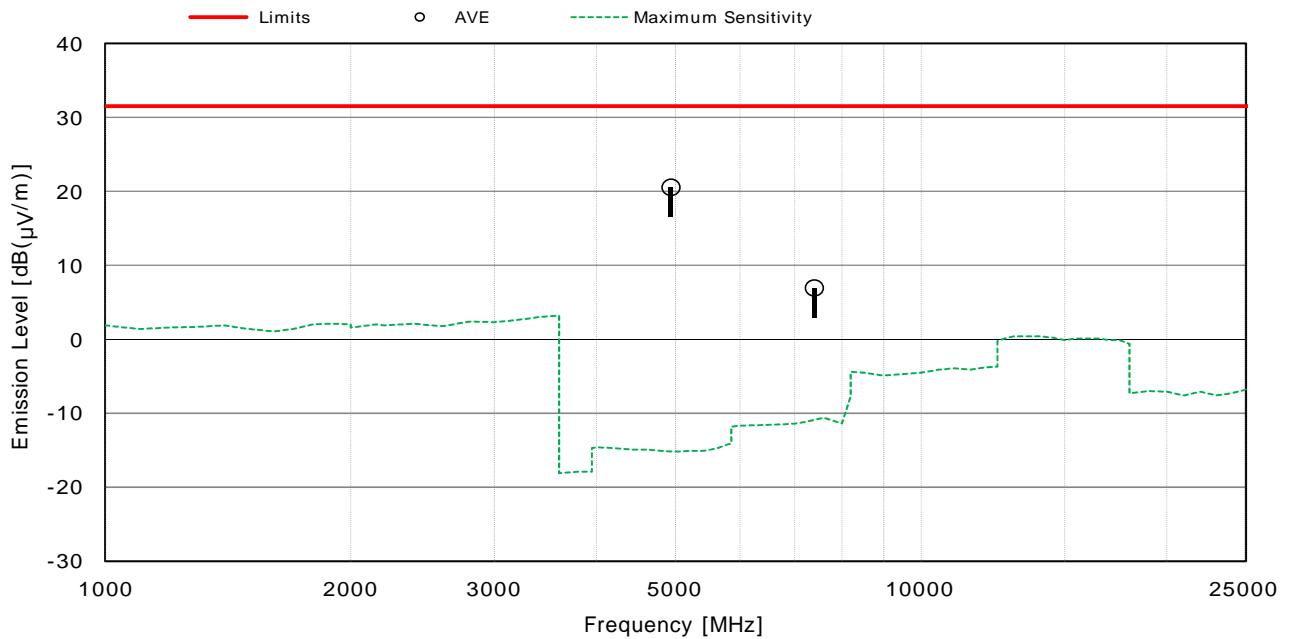

NOTES

- 1) Measurement Distance : 3 m (Specified Distance : 300 m)
- 2) The spectrum was checked from 1 GHz to 25 GHz.
- 3) The factor includes the antenna factor, the pre-amplifier gain, the cable loss and the distance conversion.
- 4) Calculated result as the worst point shown on underline :
 Factor + Reading (AVE) = -43.3 + 63.9 = 20.6 dB(μV) at 4935.60 MHz
 Antenna Height : 118 cm, Turntable Rotation Position : 16 °
- 5) AVE : Average detector
- 6) Bandwidth : 1 MHz (1 GHz - 25 GHz)

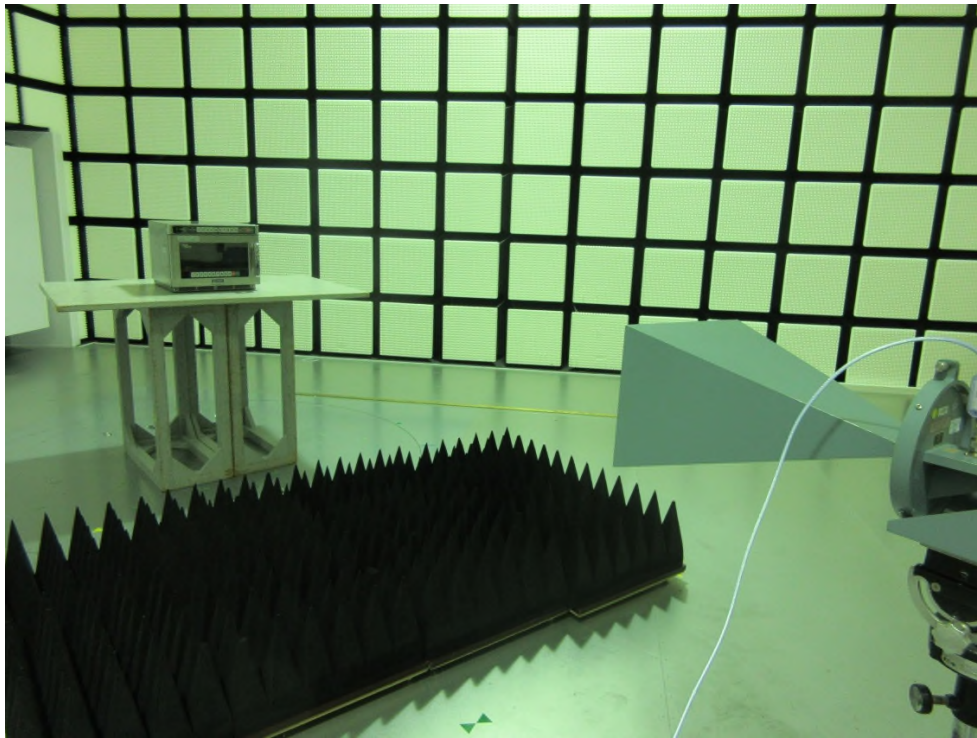
7.6.5 Test Setup (Photographs)

– View(1) –

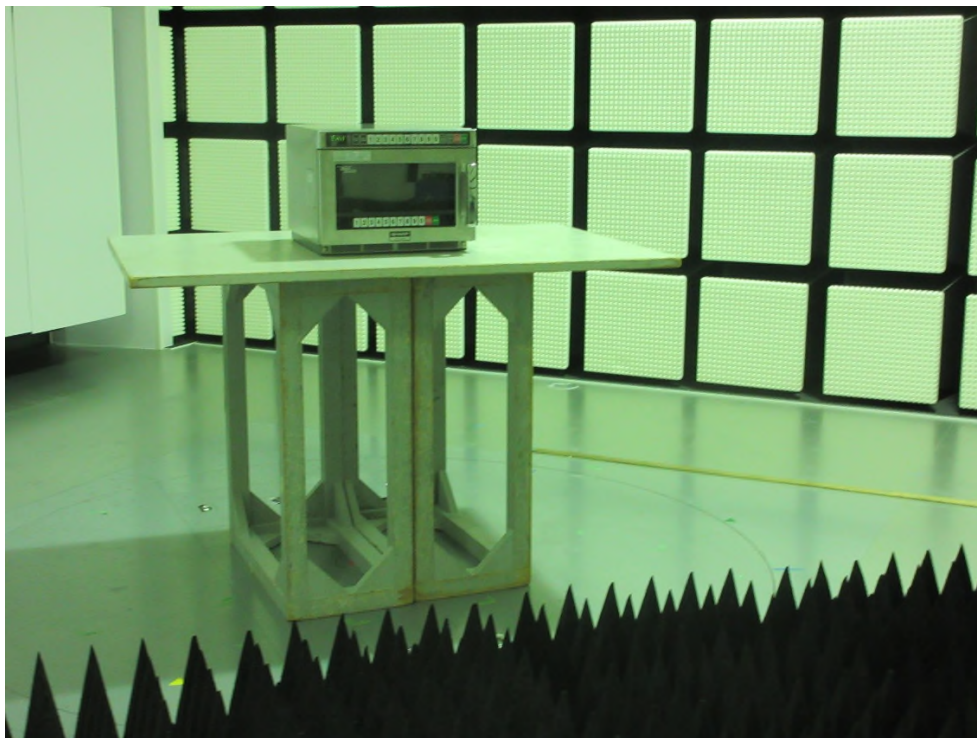

– View(2) –

Photograph present configuration with maximum emission