



M. Flom Associates, Inc. - Global Compliance Center

3356 North San Marcos Place, Suite 107, Chandler, Arizona 85224-1571

www.goodnet.com/~mflom, (602) 926-3100, FAX: 926-3598

Sub-part
2.1033(c):

EQUIPMENT IDENTIFICATION

FCC ID: APV09981

NAMEPLATE DRAWING

ATTACHED, EXHIBIT 1.

LOCATION

AS PER LABEL DRAWING(S)

DATE OF REPORT

January 12, 1999

SUPERVISED BY:

A handwritten signature in black ink that reads 'Morton Flom, P. Eng.' The signature is written in a cursive, flowing style.

Morton Flom, P. Eng.

TABLE OF CONTENTS

RULE	DESCRIPTION	PAGE
	Test Report	1
2.1033(c)	General Information Required	2
2.1033(c) (14)	Rule Summary	4
	Standard Test Conditions and Engineering Practices	5
2.1046(a)	P.F. Power Output	6
2.1047(a)	Audio Frequency Response	8
2.1047(a)	Audio Low Pass Filter (Voice Input)	11
2.1047(b)	Modulation Limiting	13
2.1049(c) (1)	Emission Masks (Occupied Bandwidth)	15
2.1051	Spurious Emissions at Antenna Terminals)	20
2.1053(a)	Field Strength of Spurious Radiation	23
2.1055(a) (1)	Frequency Stability (Temperature Variation)	27
2.1055(b) (1)	Frequency Stability (Voltage Variation)	30
2.202(g)	Necessary Bandwidth and Emission Bandwidth	36

PAGE NO. 1 of 36.

Required information per ISO/IEC Guide 25-1990, paragraph 13.2:

- a) TEST REPORT
- b) Laboratory: M. Flom Associates, Inc.
(FCC: 31040/SIT) 3356 N. San Marcos Place, Suite 107
(Canada: IC 2044) Chandler, AZ 85224
- c) Report Number: d9910003
- d) Client: Standard Communications Corp.
P.O. Box 92151
Los Angeles, CA 90009-2151
- e) Identification: GX1260S(AA1S1)
FCC ID: APV09981
Description: Mobile Marine Transceiver
- f) EUT Condition: Not required unless specified in individual tests.
- g) Report Date: January 12, 1999
EUT Received: December 22, 1998
- h, j, k): As indicated in individual tests.
- i) Sampling method: No sampling procedure used.
- l) Uncertainty: In accordance with MFA internal quality manual.
- m) Supervised by: 
Morton Flom, P. Eng.
- n) Results: The results presented in this report relate only to the item tested.
- o) Reproduction: This report must not be reproduced, except in full, without written permission from this laboratory.

PAGE NO.

2 of 36.

LIST OF GENERAL INFORMATION REQUIRED FOR CERTIFICATION

IN ACCORDANCE WITH FCC RULES AND REGULATIONS,
VOLUME II, PART 2 AND TO

80

Sub-part 2.1033

(c) (1): NAME AND ADDRESS OF APPLICANT:

Standard Communications Corp.
P.O. Box 92151
Los Angeles, CA 90009-2151

MANUFACTURER:

Dongguan Albatronics (Far East) Electronics Co., Ltd.
501-504 Block A
Po Lung Centre
11 Wang Chiu Road
Kowloon Bay, Kowloon
Hong Kong

(c) (2): FCC ID: APV09981MODEL NO: GX1260S(AA1S1)(c) (3): INSTRUCTION MANUAL(S):

PLEASE SEE ATTACHED EXHIBITS

(c) (4): TYPE OF EMISSION: 16K0G3E(c) (5): FREQUENCY RANGE, MHz: 156 to 163.575(c) (6): POWER RATING, Watts: 1 to 25
x Switchable Variable N/A(c) (7): MAXIMUM POWER RATING, Watts: 500

PAGE NO. 3 of 36.

Subpart 2.1033 (continued)

(c) (8): VOLTAGES & CURRENTS IN ALL ELEMENTS IN FINAL R. F. STAGE,
INCLUDING FINAL TRANSISTOR OR SOLID STATE DEVICE:

COLLECTOR CURRENT, A = per manual
COLLECTOR VOLTAGE, Vdc = per manual
SUPPLY VOLTAGE, Vdc = 13.8

(c) (9): TUNE-UP PROCEDURE:

PLEASE SEE ATTACHED EXHIBITS

(c) (10): CIRCUIT DIAGRAM/CIRCUIT DESCRIPTION:

Including description of circuitry & devices provided for determining and stabilizing frequency, for suppression of spurious radiation, for limiting modulation and limiting power.

PLEASE SEE ATTACHED EXHIBITS

(c) (11): LABEL INFORMATION:

PLEASE SEE ATTACHED EXHIBITS

(c) (12): PHOTOGRAPHS:

PLEASE SEE ATTACHED EXHIBITS

(c) (13): DIGITAL MODULATION DESCRIPTION:

ATTACHED EXHIBITS
x N/A

(c) (14): TEST AND MEASUREMENT DATA:

FOLLOWS

PAGE NO.

4 of 36.

Sub-part

2.1033(c) (14):

TEST AND MEASUREMENT DATA

All tests and measurement data shown were performed in accordance with FCC Rules and Regulations, Volume II; Part 2, Sub-part J, Sections 2.947, 2.1033(c), 2.1041, 2.1046, 2.1047, 2.1079, 2.1051, 2.1053, 2.1055, 2.1057 and the following individual Parts:

- ___ 21 - Domestic Public Fixed Radio Services
- ___ 22 - Public Mobile Services
- ___ 22 Subpart H - Cellular Radiotelephone Service
- ___ 22.901(d) - Alternative technologies and auxiliary services
- ___ 23 - International Fixed Public Radiocommunication services
- ___ 24 - Personal Communications Services
- ___ 74 Subpart H - Low Power Auxiliary Stations
- x 80 - Stations in the Maritime Services
- ___ 80 Subpart E - General Technical Standards
- ___ 80 Subpart F - Equipment Authorization for Compulsory Ships
- ___ 80 Subpart K - Private Coast Stations and Marine Utility Stations
- ___ 80 Subpart S - Compulsory Radiotelephone Installations for Small Passenger Boats
- ___ 80 Subpart T - Radiotelephone Installation Required for Vessels on the Great Lakes
- ___ 80 Subpart U - Radiotelephone Installations Required by the Bridge-to-Bridge Act
- ___ 80 Subpart V - Emergency Position Indicating Radiobeacons (EPIRB'S)
- ___ 80 Subpart W - Global Maritime Distress and Safety System (GMDSS)
- ___ 80 Subpart X - Voluntary Radio Installations
- ___ 87 - Aviation Services
- ___ 90 - Private Land Mobile Radio Services
- ___ 94 - Private Operational-Fixed Microwave Service
- ___ 95 Subpart A - General Mobile Radio Service (GMRS)
- ___ 95 Subpart C - Radio Control (R/C) Radio Service
- ___ 95 Subpart D - Citizens Band (CB) Radio Service
- ___ 95 Subpart E - Family Radio Service
- ___ 95 Subpart F - Interactive Video and Data Service (IVDS)
- ___ 101 - Fixed Microwave Services

PAGE NO.

5 of 36.

STANDARD TEST CONDITIONS
and
ENGINEERING PRACTICES

Except as noted herein, the following conditions and procedures were observed during the testing:

In accordance with ANSI C63.4-1992, section 6.1.9, and unless otherwise indicated in the specific measurement results, the ambient temperature of the actual EUT was maintained within the range of 10° to 40°C (50° to 104 °F) unless the particular equipment requirements specify testing over a different temperature range. Also, unless otherwise indicated, the humidity levels were in the range of 10% to 90% relative humidity.

Prior to testing, the EUT was tuned up in accordance with the manufacturer's alignment procedures. All external gain controls were maintained at the position of maximum and/or optimum gain throughout the testing.

Measurement results, unless otherwise noted, are worst case measurements.

PAGE NO. 6 of 36.
NAME OF TEST: R.F. Power Output
SPECIFICATION: 47 CFR 2.1046(a)
GUIDE: ANSI/TIA/EIA-603-1992, Paragraph 2.2.1
TEST EQUIPMENT: As per attached page

MEASUREMENT PROCEDURE

1. The EUT was connected to a resistive coaxial attenuator of normal load impedance, and the unmodulated output power was measured by means of an R. F. Power Meter.
2. Measurement accuracy is $\pm 3\%$.

MEASUREMENT RESULTS

NOMINAL, MHz	CHANNEL	R. F. POWER, WATTS	
		LO	HI
156.300	06	1	25
156.550	11	1	25
156.600	12	1	25
156.650	13* Mobile Only	1	**1/25
156.700	14	1	25
156.750	15	1	25
156.800	16	1	25
156.850	17* Mobile Only	1	**1/25
156.875	67* Mobile Only	1	**1/25

*Automatic switching to low power.

**High power with manual over-ride, see attached manual.

SUPERVISED BY:

Morton Flom P. Eng.

Morton Flom, P. Eng.

PAGE NO.

7 of 36.

TRANSMITTER POWER CONDUCTED MEASUREMENTS

TEST 1: R. F. POWER OUTPUT
 TEST 2: FREQUENCY STABILITY

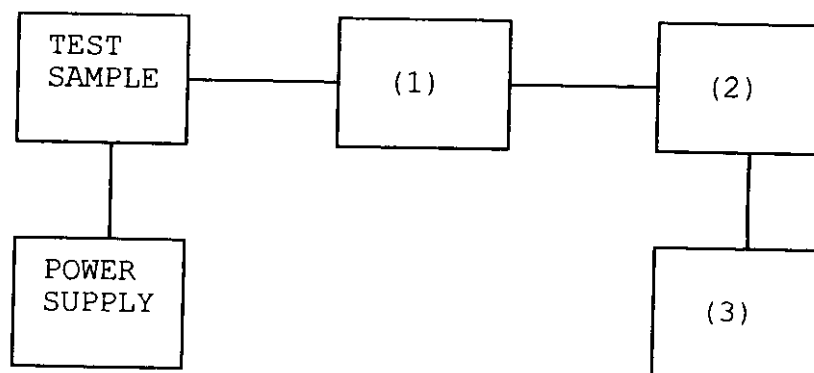

Asset	Description	s/n
-------	-------------	-----

(1) COAXIAL ATTENUATOR

___	i00122 Narda 766-10	7802
___	i00123 Narda 766-10	7802A
___	i00069 Bird 8329 (30 dB)	1006
<u>x</u>	i00113 Sierra 661A-3D	1059

(2) POWER METERS

___	i00014 HP 435A	1733A05836
<u>x</u>	i00039 HP 436A	2709A26776
<u>x</u>	i00020 HP 8901A POWER MODE	2105A01087

(3) FREQUENCY COUNTER

___	i00042 HP 5383A	1628A00959
<u>x</u>	i00019 HP 5334B	2704A00347
<u>x</u>	i00020 HP 8901A FREQUENCY MODE	2105A01087

PAGE NO. 8 of 36.
NAME OF TEST: Audio Frequency Response
SPECIFICATION: 47 CFR 2.1047(a)
GUIDE: ANSI/TIA/EIA-603-1992, Paragraph 2.2.6
TEST EQUIPMENT: As per attached page

MEASUREMENT PROCEDURE

1. The EUT and test equipment were set up as shown on the following page.
2. The audio signal generator was connected to the audio input circuit/microphone of the EUT.
3. The audio signal input was adjusted to obtain 50% modulation at 1 kHz, and this point was taken as the 0 dB reference level.
4. With input levels held constant and below limiting at all frequencies, the audio signal generator was varied from 100 Hz to 50 kHz.
5. The response in dB relative to 1 kHz was then measured, using the HP 8901A Modulation Analyzer.
6. MEASUREMENT RESULTS: ATTACHED

TRANSMITTER TEST SET-UP

- TEST A. MODULATION CAPABILITY/DISTORTION
- TEST B. AUDIO FREQUENCY RESPONSE
- TEST C. HUM AND NOISE LEVEL
- TEST D. RESPONSE OF LOW PASS FILTER
- TEST E. MODULATION LIMITING

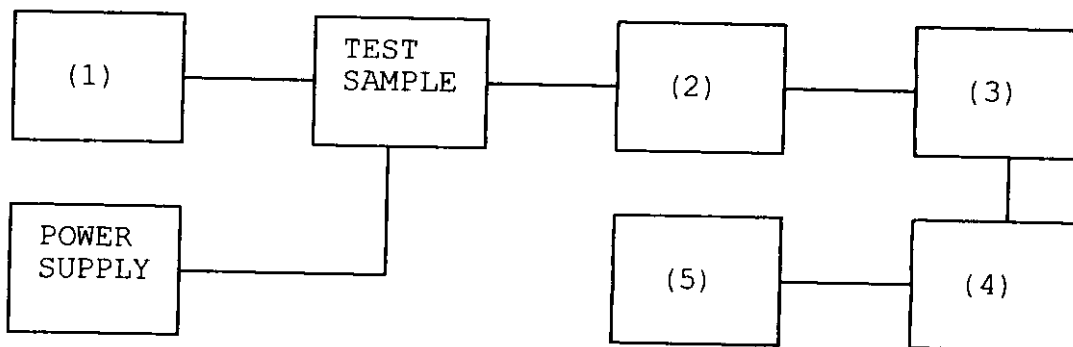

Asset	Description	s/n
(1)	<u>LINE IMPEDANCE STABILIZATION NETWORK</u>	
	i00010 HP 204D	1105A04683
<u>x</u>	i00017 HP 8903A	2216A01753
	i00118 HP 33120A	US36002064
(2)	<u>COAXIAL ATTENUATOR</u>	
	i00122 NARDA 766-10	7802
	i00123 NARDA 766-10	7802A
<u>x</u>	i00113 SIERRA 661A-3D	1059
	i00069 BIRD 8329 (30 dB)	10066
(3)	<u>MODULATION ANALYZER</u>	
<u>x</u>	i00020 HP 8901A	2105A01087
(4)	<u>AUDIO ANALYZER</u>	
<u>x</u>	i00017 HP 8903A	2216A01753
(5)	<u>SCOPE</u>	
	i00058 HP 1741A	2215A09356
	i00071 Tektronix 935	1935-B011343

PAGE NO. 10 of 36.

NAME OF TEST: Audio Frequency Response
 g98c0167: 1998-Dec-22 Tue 12:09:00
 STATE: 0:General

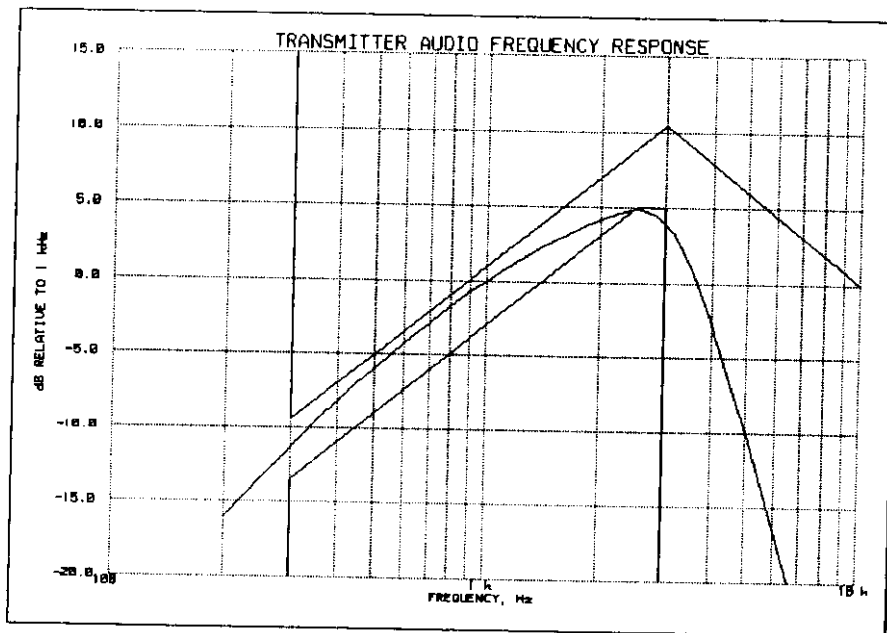

Additional points:

FREQUENCY, Hz	LEVEL, dB
300	-11.32
20000	-36.17
30000	-34.97
50000	-36.51

SUPERVISED BY:

Morton Flom P. Eng.

Morton Flom, P. Eng.

PAGE NO. 11 of 36.
NAME OF TEST: Audio Low Pass Filter (Voice Input)
SPECIFICATION: 47 CFR 2.1047(a)
GUIDE: ANSI/TIA/EIA-603-1992, Paragraph 2.2.15
TEST EQUIPMENT: As per previous page

MEASUREMENT PROCEDURE

1. The EUT and test equipment were set up such that the audio input was connected at the input to the modulation limiter, and the modulated stage.
2. The audio output was connected at the output to the modulated stage.
3. MEASUREMENT RESULTS: ATTACHED

PAGE NO.

12 of 36.

NAME OF TEST: Audio Low Pass Filter (Voice Input)
g98c0166: 1998-Dec-22 Tue 12:06:00
STATE: 0:General

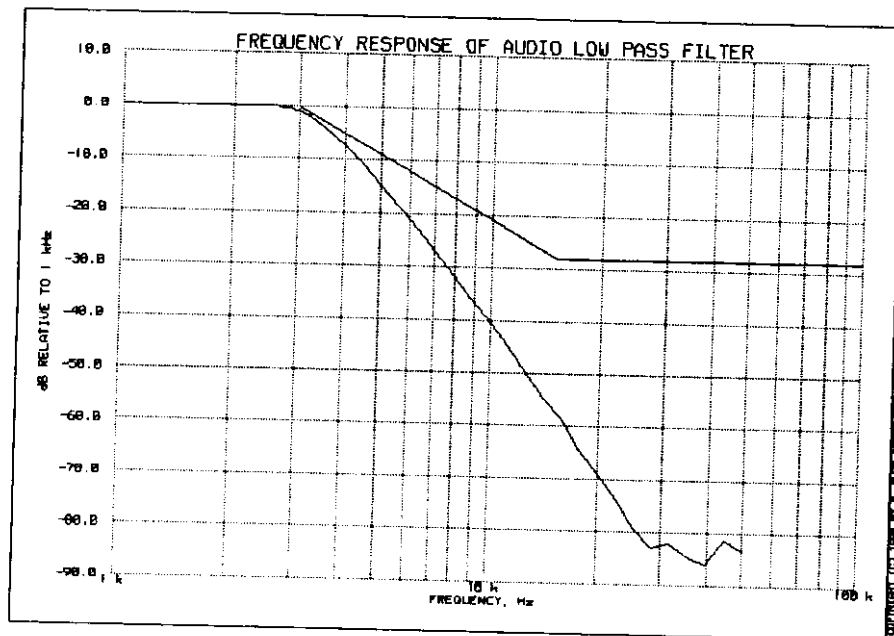

SUPERVISED BY:

Morton Flom P. Eng.

Morton Flom, P. Eng.

PAGE NO. 13 of 36.
NAME OF TEST: Modulation Limiting
SPECIFICATION: 47 CFR 2.1047(b), 80.211, 80.213
GUIDE: ANSI/TIA/EIA-603-1992, Paragraph 2.2.3
TEST EQUIPMENT: As per previous page

MEASUREMENT PROCEDURE

1. The signal generator was connected to the input of the EUT as for "Frequency Response of the Modulating Circuit."
2. The modulation response was measured for each of three frequencies (one of which was the frequency of maximum response), and the input voltage was varied and was observed on an HP 8901A Modulation Analyzer.
3. The input level was varied from 30% modulation (± 1.5 kHz deviation) to at least 20 dB higher than the saturation point.
4. Measurements were performed for both negative and positive modulation and the respective results were recorded.
5. MEASUREMENT RESULTS: ATTACHED

PAGE NO.

14 of 36.

NAME OF TEST: Modulation Limiting
g98c0168: 1998-Dec-22 Tue 12:19:00
STATE: 0:General

Positive
Peaks:

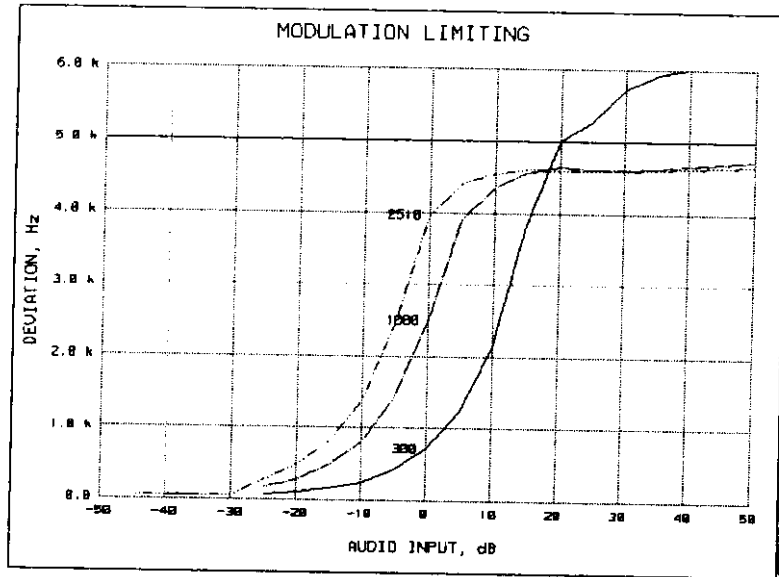

Negative
Peaks:

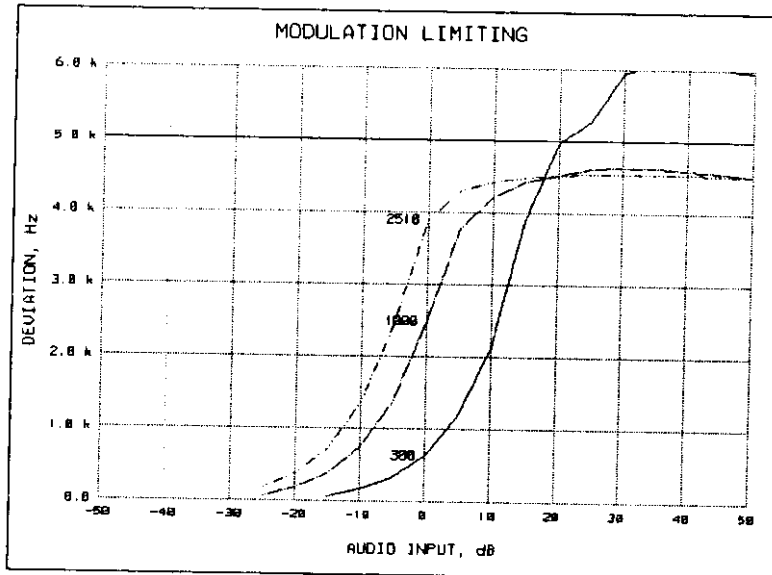

SUPERVISED BY:

Morton Flom, P. Eng.

Morton Flom, P. Eng.

PAGE NO. 15 of 36.
NAME OF TEST: Emission Masks (Occupied Bandwidth)
SPECIFICATION: 47 CFR 2.1049(c) (1)
GUIDE: ANSI/TIA/EIA-603-1992, Paragraph 2.2.11
TEST EQUIPMENT: As per previous page

MEASUREMENT PROCEDURE

1. The EUT and test equipment were set up as shown on the following page, with the Spectrum Analyzer connected.
2. For EUTs supporting audio modulation, the audio signal generator was adjusted to the frequency of maximum response and with output level set for ± 2.5 kHz deviation (or 50% modulation). With level constant, the signal level was increased 16 dB.
3. For EUTs supporting digital modulation, the digital modulation mode was operated to its maximum extent.
4. The Occupied Bandwidth was measured with the Spectrum Analyzer controls set as shown on the test results.
5. MEASUREMENT RESULTS: ATTACHED

PAGE NO.

16 of 36.

NAME OF TEST: Emission Masks (Occupied Bandwidth)
g98c0212: 1998-Dec-22 Tue 15:15:00
STATE: 1:Low Power

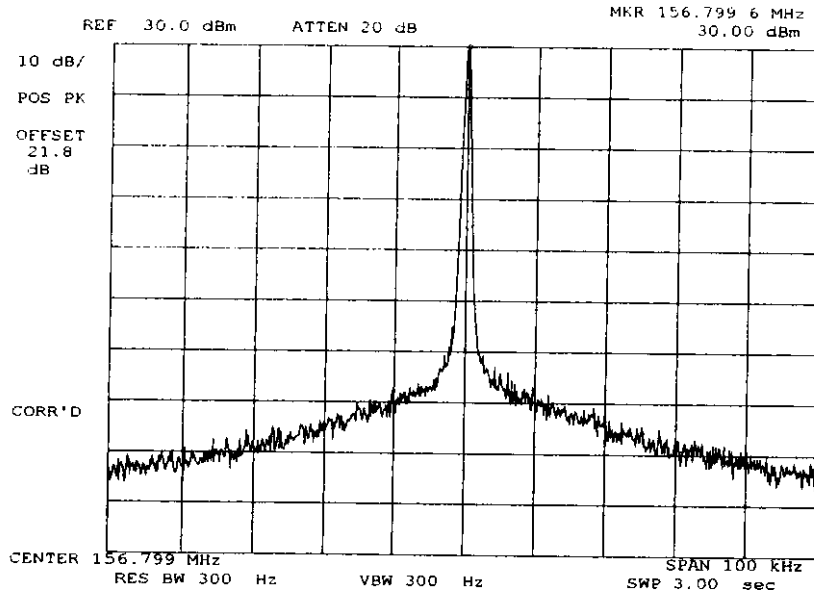

POWER: LOW
MODULATION: NONE

SUPERVISED BY:

Morton Flom, P. Eng.

PAGE NO.

17 of 36.

NAME OF TEST: Emission Masks (Occupied Bandwidth)
g98c0213: 1998-Dec-22 Tue 15:17:00
STATE: 1:Low Power

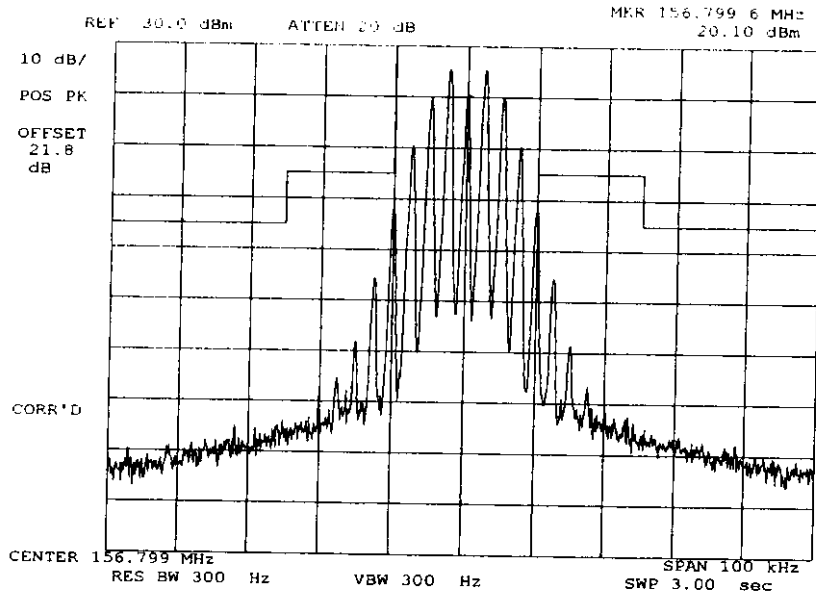

POWER:
MODULATION:

LOW
VOICE: 2500 Hz SINE WAVE
MASK: B, VHF/UHF 25kHz,
w/LPF

SUPERVISED BY:

Morton Flom, P. Eng.
Morton Flom, P. Eng.

PAGE NO.

18 of 36.

NAME OF TEST: Emission Masks (Occupied Bandwidth)
g98c0211: 1998-Dec-22 Tue 15:12:00
STATE: 2:High Power

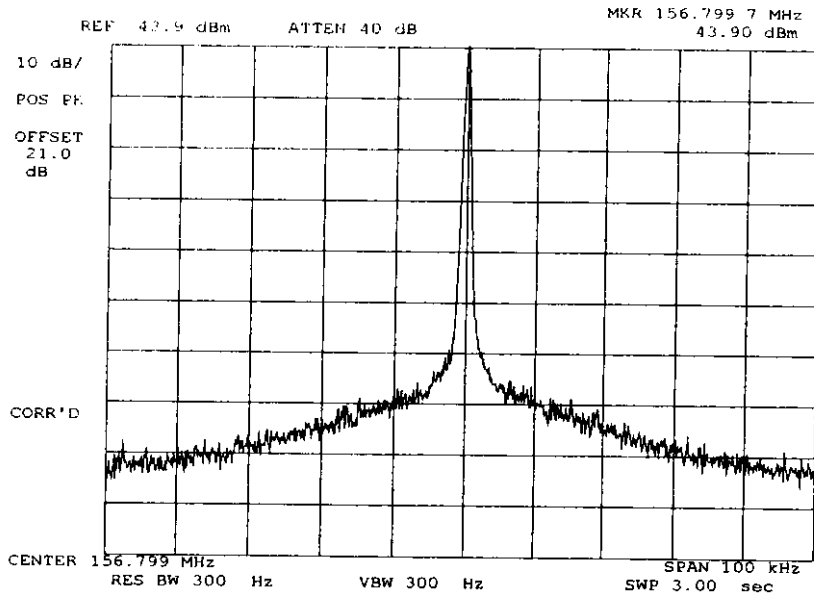

POWER: HIGH
MODULATION: NONE

SUPERVISED BY:

Morton Flom, P. Eng.

PAGE NO.

19 of 36.

NAME OF TEST: Emission Masks (Occupied Bandwidth)
g98c0214: 1998-Dec-22 Tue 15:18:00
STATE: 2:High Power

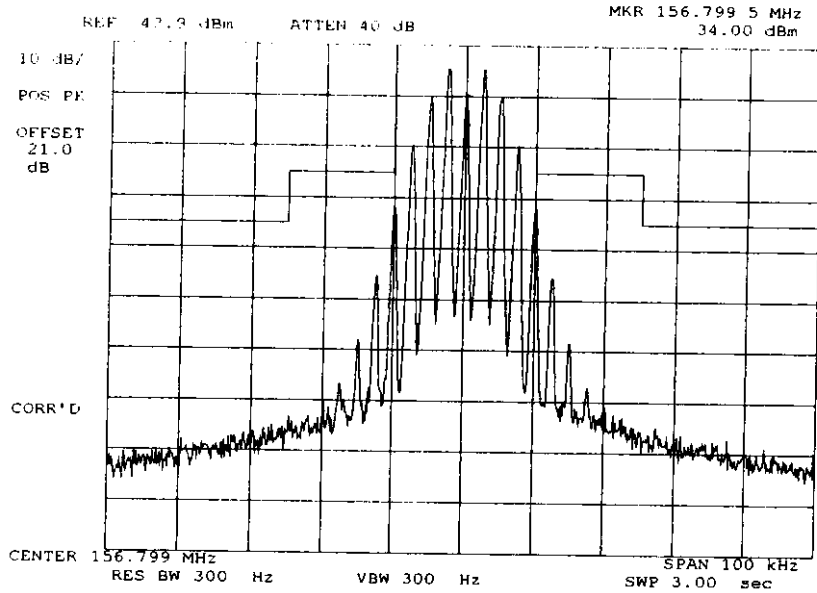

POWER: HIGH
MODULATION: VOICE: 2500 Hz SINE WAVE
MASK: B, VHF/UHF 25kHz, w/LPF

SUPERVISED BY:

Morton Flom P. Eng.
Morton Flom, P. Eng.

PAGE NO. 20 of 36.
NAME OF TEST: Spurious Emissions at Antenna Terminals
SPECIFICATION: 47 CFR 2.1051
GUIDE: ANSI/TIA/EIA-603-1992, Paragraph 2.2.13
TEST EQUIPMENT: As per attached page

MEASUREMENT PROCEDURE

1. The emissions were measured for the worst case as follows:
 - (a): within a band of frequencies defined by the carrier frequency plus and minus one channel.
 - (b): from the lowest frequency generated in the EUT and to at least the 10th harmonic of the carrier frequency, or 40 GHz, whichever is lower.
2. The magnitude of spurious emissions that are attenuated more than 20 dB below the permissible value need not be specified.

3. MEASUREMENT RESULTS: ATTACHED FOR WORST CASE

FREQUENCY OF CARRIER, MHz	=	156.8
SPECTRUM SEARCHED, GHz	=	0 to 10 x F _c
MAXIMUM RESPONSE, Hz	=	2510
ALL OTHER EMISSIONS	=	≥ 20 dB BELOW LIMIT
LIMIT(S), dBc		
	- (43+10xLOG P)	= -43 (1 Watt)
	- (43+10xLOG P)	= -57 (25 Watts)

SUPERVISED BY:

Morton Flom, P. Eng.

PAGE NO.

21 of 36.

NAME OF TEST: Spurious Emissions at Antenna Terminals
 g98c0216: 1998-Dec-22 Tue 15:30:00
 STATE: 1:Low Power

FREQUENCY TUNED, MHz	FREQUENCY EMISSION, MHz	LEVEL, dBm	LEVEL, dBc	MARGIN, dB
156.800000	313.598000	-32.7	-62.7	-19.7
156.800000	470.400000	-49.3	-79.3	-36.3
156.800000	627.242000	-53.1	-83.1	-40.1
156.800000	783.652000	-52.2	-82.2	-39.2
156.800000	940.875000	-52.9	-82.9	-39.9
156.800000	1098.024000	-52.8	-82.8	-39.8
156.800000	1254.387000	-52.5	-82.5	-39.5
156.800000	1411.199000	-50.5	-80.5	-37.5
156.800000	1567.773000	-52.7	-82.7	-39.7
156.800000	1724.888000	-52.2	-82.2	-39.2
156.800000	1881.789000	-51.6	-81.6	-38.6
156.800000	2038.330000	-51.8	-81.8	-38.8
156.800000	2195.582000	-51.2	-81.2	-38.2
156.800000	2351.650000	-51.2	-81.2	-38.2

PAGE NO.

22 of 36.

NAME OF TEST: Spurious Emissions at Antenna Terminals
 g98c0215: 1998-Dec-22 Tue 15:28:00
 STATE: 2:High Power

FREQUENCY TUNED, MHz	FREQUENCY EMISSION, MHz	LEVEL, dBm	LEVEL, dBc	MARGIN, dB
156.800000	313.599000	-32.3	-76.2	-19.3
156.800000	470.411000	-32.4	-76.3	-19.4
156.800000	627.695000	-32.9	-76.8	-19.9
156.800000	783.548000	-33.9	-77.8	-20.9
156.800000	940.900000	-32.7	-76.6	-19.7
156.800000	1097.436000	-33.9	-77.8	-20.9
156.800000	1254.360000	-33	-76.9	-20
156.800000	1411.196000	-32.4	-76.3	-19.4
156.800000	1568.113000	-33.2	-77.1	-20.2
156.800000	1725.214000	-32.3	-76.2	-19.3
156.800000	1882.057000	-33.4	-77.3	-20.4
156.800000	2038.392000	-32.3	-76.2	-19.3
156.800000	2195.120000	-32.5	-76.4	-19.5
156.800000	2351.538000	-31.8	-75.7	-18.8

PAGE NO. 23 of 36.
NAME OF TEST: Field Strength of Spurious Radiation
SPECIFICATION: 47 CFR 2.1053(a)
GUIDE: ANSI/TIA/EIA-603-1992, Paragraph 2.2.12
TEST EQUIPMENT: As per attached page

MEASUREMENT PROCEDURE

1. A description of the measurement facilities was filed with the FCC and was found to be in compliance with the requirements of Section 15.38, by letter from the FCC dated March 3, 1997, FILE 31040/SIT. All pertinent changes will be reported to the Commission by up-date prior to March 2000.
2. At first, in order to locate all spurious frequencies and approximate amplitudes, and to determine proper equipment functioning, the test sample was set up at a distance of three meters from the test instrument. Valid spurious signals were determined by switching the power on and off.
3. In the field, the test sample was placed on a wooden turntable above ground at three (or thirty) meters away from the search antenna. Excess power leads were coiled near the power supply.

In order to obtain the maximum response at each spurious frequency, the turntable was rotated. Also, the search Antennas were raised and lowered vertically, and all cables were oriented. Excess power lead was coiled near the power supply.
4. A signal generator, connected with a non-radiating cable to a vertically polarized half-wave antenna (for each frequency involved) was substituted for the transmitter. The Search Antenna was raised and lowered to obtain maximum indicated.
5. The signal generator output was adjusted until a signal level indication equal to that from the transmitter was obtained.
6. Steps 4 and 5 were repeated, using a horizontally polarized half-wave antenna. The higher of the two observations was noted.
7. Power into the half-wave antenna was calculated from the characteristic impedance of the line, and the voltage output from the signal generator.

PAGE NO. 24 of 41.
NAME OF TEST: Field Strength of Spurious Radiation
SPECIFICATION: 47 CFR 2.1053(a)
GUIDE: ANSI/TIA/EIA-603-1992, Paragraph 2.2.12
TEST EQUIPMENT: As per attached page

MEASUREMENT PROCEDURE (CONT.)

8. The level of each spurious radiation with reference to the transmitter power in dB, was calculated from:

$$\text{SPURIOUS LEVEL, dB} = 10 \text{ LOG (Calculated Spurious Power)} \\ \frac{[\text{From Para. 7}]}{\text{TX Power (Wattmeter)}}$$

9. The worst case for all channels is shown.

10. Measurement summary:

FREQUENCY OF CARRIER, MHz = 156.8
 SPECTRUM SEARCHED, GHz = 0 to 10 x F_c
 ALL OTHER EMISSIONS = ≥ 20 dB BELOW LIMIT
 LIMIT, dBc
 -(43+10xLOG P) = -43 (1 Watt)
 -(43+10xLOG P) = -57 (25 Watts)

RADIATED TEST SETUP

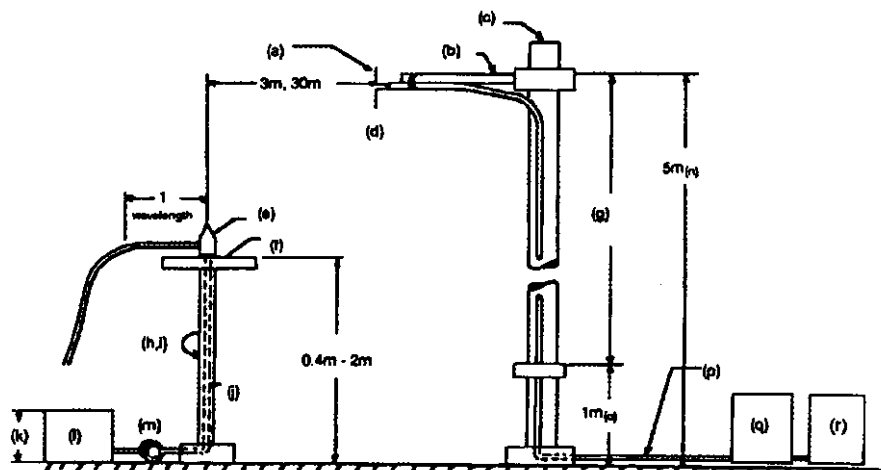

NOTES:

- (a) Search Antenna - Rotatable on boom
- (b) Non-metallic boom
- (c) Non-metallic mast
- (d) Adjustable horizontally
- (e) Equipment Under Test
- (f) Turntable
- (g) Boom adjustable in height.
- (h) External control cables routed horizontally at least one wavelength.
- (i) Rotatable
- (j) Cables routed through hollow turntable center
- (k) 30 cm or less
- (l) External power source
- (m) 10 cm diameter coil of excess cable
- (n) 25 cm (V), 1 m-7 m (V, H)
- (o) 25 cm from bottom end of 'V', 1m normally
- (p) Calibrated Cable at least 10m in length
- (q) Amplifier (optional)
- (r) Spectrum Analyzer

Asset	Description	s/n	Cycle	Last Cal
-------	-------------	-----	-------	----------

Per ANSI C63.4-1992, 10.1.4

TRANSDUCER

___	i00065	EMCO 3109B 100Hz-50MHz	2336	12 mo.	
___	i00033	Singer 94593-1 10kHz-32MHz	0219	12 mo.	
x	i00088	EMCO 3109-B 25MHz-300MHz	2336	12 mo.	Oct-98
x	i00089	Apral 2001 200MHz-1GHz	001500	12 mo.	Oct-98
x	i00103	EMCO 3115 1GHz-18GHz	9208-3925	12 mo.	Oct-98
___	i00085	EMCO 3116 10GHz-40GHz	2076	12 mo.	

AMPLIFIER

___	i00028	HP 8449A	2749A00121	12 mo.	Mar-98
-----	--------	----------	------------	--------	--------

SPECTRUM ANALYZER

___	i00029	HP 8563E	3213A00104	12 mo.	Aug-98
x	i00033	HP 85462A	3625A00357	12 mo.	Dec-98
___	i00048	HP 8566B	2511AD1467	6 mo.	Dec-98

PAGE NO. 26 of 36.

NAME OF TEST: Field Strength of Spurious Radiation

ALL OTHER EMISSIONS = \geq 20 dB BELOW LIMIT

EMISSION, MHz/HARMONIC	SPURIOUS LEVEL, dBc	
	Low	High
2nd to 10th	<-60	<-75

SUPERVISED BY:

Morton Flom, P. Eng.

PAGE NO. 27 of 36.
NAME OF TEST: Frequency Stability (Temperature Variation)
SPECIFICATION: 47 CFR 2.1055(a) (1)
GUIDE: ANSI/TIA/EIA-603-1992, Paragraph 2.2.2
TEST CONDITIONS: As Indicated
TEST EQUIPMENT: As per previous page

MEASUREMENT PROCEDURE

1. The EUT and test equipment were set up as shown on the following page.
2. With all power removed, the temperature was decreased to -30°C and permitted to stabilize for three hours. Power was applied and the maximum change in frequency was noted within one minute.
3. With power OFF, the temperature was raised in 10°C steps. The sample was permitted to stabilize at each step for at least one-half hour. Power was applied and the maximum frequency change was noted within one minute.
4. The temperature tests were performed for the worst case.
5. MEASUREMENT RESULTS: ATTACHED

TRANSMITTER TEST SET-UP

- TEST A. OPERATIONAL STABILITY
- TEST B. CARRIER FREQUENCY STABILITY
- TEST C. OPERATIONAL PERFORMANCE STABILITY
- TEST D. HUMIDITY
- TEST E. VIBRATION
- TEST F. ENVIRONMENTAL TEMPERATURE
- TEST G. FREQUENCY STABILITY: TEMPERATURE VARIATION
- TEST H. FREQUENCY STABILITY: VOLTAGE VARIATION

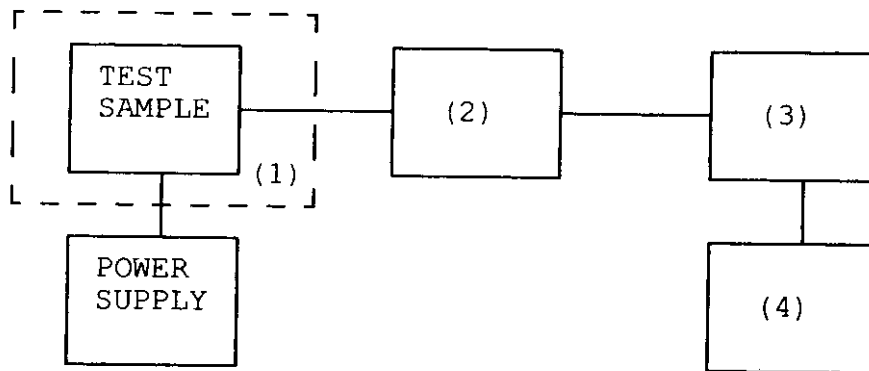

Asset Description s/n

(1) TEMPERATURE, HUMIDITY, VIBRATION

<u>x</u>	i00027	Tenny Temp. Chamber	9083-765-234
___	i00	Weber Humidity Chamber	
___	i00	L.A.B. RVH 18-100	

(2) COAXIAL ATTENUATOR

___	i00122	NARDA 766-10	7802
___	i00123	NARDA 766-10	7802A
<u>x</u>	i00113	SIERRA 661A-3D	1059
<u>x</u>	i00069	BIRD 8329 (30 dB)	10066

(3) R.F. POWER

___	i00014	HP 435A POWER METER	1733A05839
<u>x</u>	i00039	HP 436A POWER METER	2709A26776
<u>x</u>	i00020	HP 8901A POWER MODE	2105A01087

(4) FREQUENCY COUNTER

___	i00042	HP 5383A	1628A00959
<u>x</u>	i00019	HP 5334B	2704A00347
___	i00020	HP 8901A	2105A01087

PAGE NO.

29 of 36.

NAME OF TEST: Frequency Stability (Temperature Variation)
g98c0175: 1998-Dec-22 Tue 15:39:00
STATE: 0:General

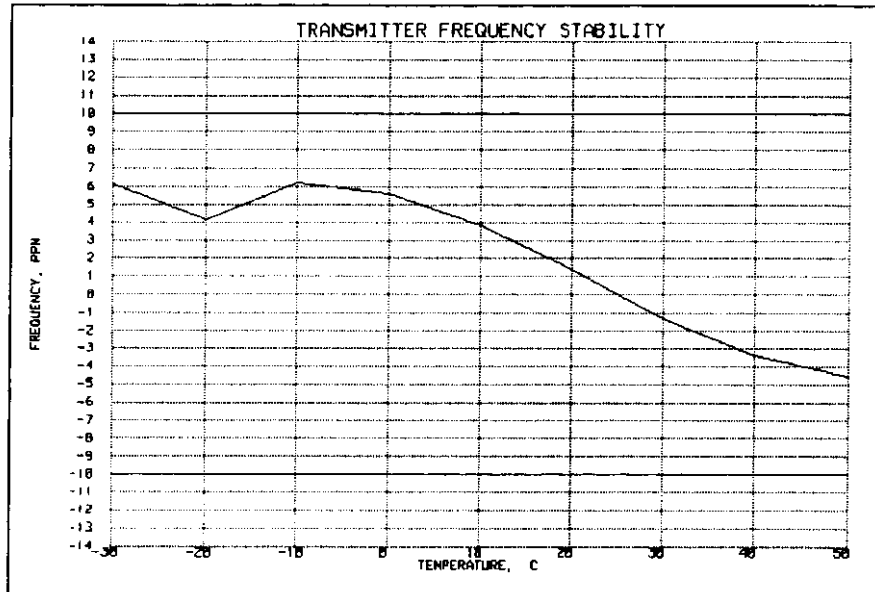

SUPERVISED BY:

Morton Flom, P. Eng.

PAGE NO. 30 of 36.
NAME OF TEST: Frequency Stability (Voltage Variation)
SPECIFICATION: 47 CFR 2.1055(b) (1)
GUIDE: ANSI/TIA/EIA-603-1992, Paragraph 2.2.2
TEST EQUIPMENT: As per previous page

MEASUREMENT PROCEDURE

1. The EUT was placed in a temperature chamber at 25±5°C and connected as for "Frequency Stability - Temperature Variation" test.
2. The power supply voltage to the EUT was varied from 85% to 115% of the nominal value measured at the input to the EUT.
3. The variation in frequency was measured for the worst case.

RESULTS: Frequency Stability (Voltage Variation)
g98c0206: 1998-Dec-22 Tue 13:46:16
STATE: 0:General

LIMIT, ppm = 10
LIMIT, Hz = 1568
BATTERY END POINT (Voltage) = 10.4

% of STV	Voltage	Frequency, MHz	Change, Hz	Change, ppm
85	11.73	156.800010	10	0.06
100	13.8	156.800000	0	0.00
115	15.87	156.800000	0	0.00
75	10.4	156.800010	10	0.06

SUPERVISED BY:

Morton Flom, P. Eng.

PAGE NO. 31 of 36.
NAME OF TEST: User Controls
SPECIFICATION: 47 CFR 80.203(b)

STATEMENT

The external controls of the maritime station transmitter capable of operation in the 156-162 MHz band only provides for selection of maritime channels for which the maritime station is authorized. This transmitter is not capable of being programmed by station operators using external controls to transmit on channels other than those programmed by the manufacturer, service or maintenance personnel.

The EUT fully complies with the requirements of 47 CFR 80.203 (b).

PAGE NO. 32 of 36.
NAME OF TEST: Power Output Over Time
SPECIFICATION: 47 CFR 80.959(c) (1) (2) & (3)
GUIDE: ANSI/TIA/EIA-603-1992, Paragraph
TEST EQUIPMENT: As per previous page

MEASUREMENT PROCEDURE

1. The EUT was connected to a resistive coaxial attenuator of normal load impedance, and the unmodulated output power was measured by means of an R. F. Power meter.
2. Measurement accuracy is $\pm 3\%$.
3. The transmitter was operated continuously.
4. Measurements summary:

<u>TIME, Min.</u>	<u>SUPPLY VOLTAGE, vdc</u>	<u>R.F. Power Output, Watts</u>
0	13.8	25
10	13.8	25

Measurement Results: Attached

SUPERVISED BY:

Morton Flom, P. Eng.

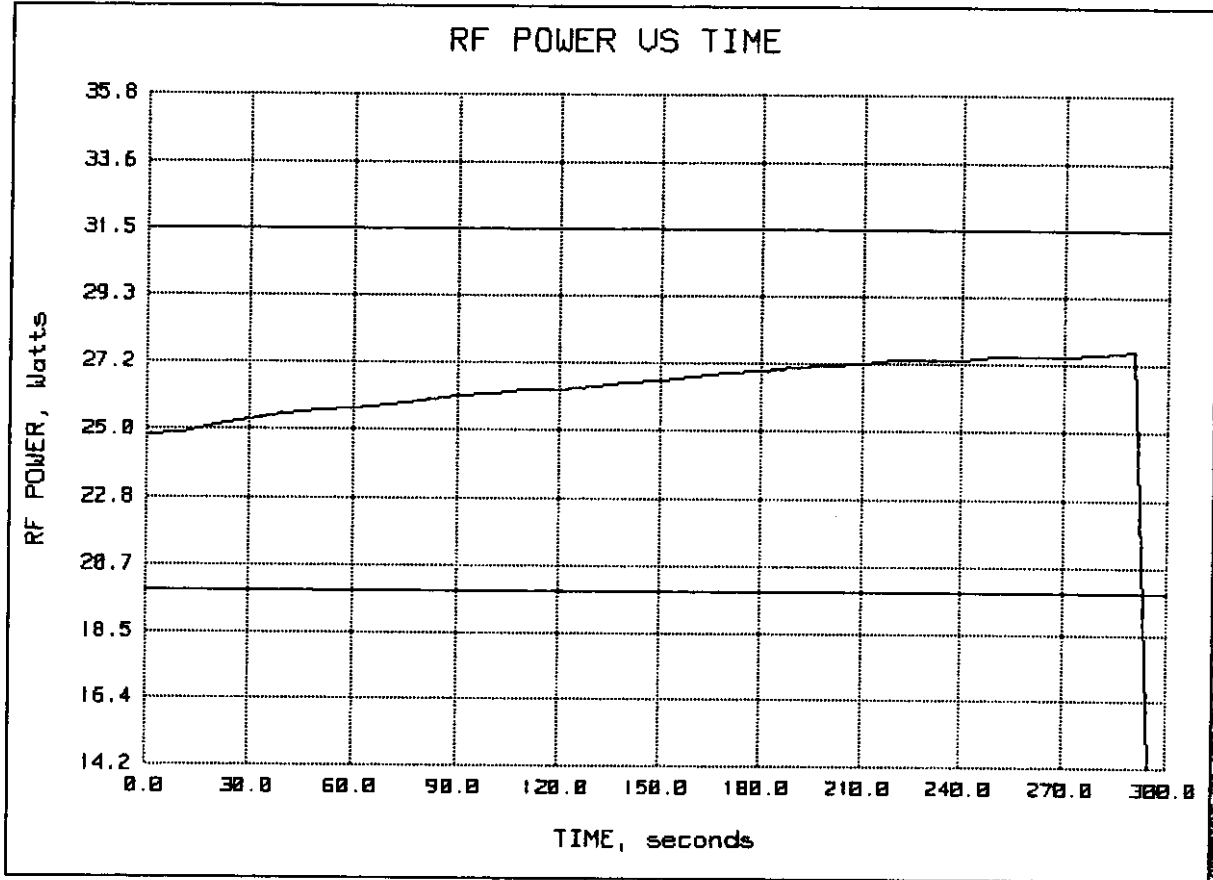

NOMINAL, Watts	= 25
UPPER LIMIT, dB	= 1.0
UPPER LIMIT, Watts	= 31.5
LOWER LIMIT, dB	= 1.0
LOWER LIMIT, Watts	= 19.9

PAGE NO. 34 of 36.
NAME OF TEST: Subpart T - G3E Emissions
SPECIFICATION: 47 CFR 80.961(a) & (b)
TEST EQUIPMENT: As per previous page

MEASUREMENT RESULTS

- (a) The receiver is capable of reception of G3E emissions on the required frequencies.
- (b) The sensitivity of the receiver at 20 dB SINAD is better than:

SENSITIVITY, dBm = -115.2
SENSITIVITY, μ V = 0.389

SUPERVISED BY:

Morton Flom, P. Eng.

PAGE NO. 35 of 36.
NAME OF TEST: Subpart U - Bridge-to-Bridge Act
SPECIFICATION: 47 CFR 80.1011, 80.1013
TEST EQUIPMENT: As per previous page

RESULTS

80.1011 Transmitter.

The transmitter is capable of G3E emissions on the navigational frequency 156.650 MHz (Channel 13) and the Coast Guard liaison frequency 157.100 MHz (Channel 22). Additionally the transmitter is capable of transmission of G3E emissions on the navigational frequency of 156.375 MHz (Channel 67) while transmitting in any of the applicable waters.

80.1013 Receiver.

The receiver is capable of reception of G3E emissions on the navigational frequency 156.650 MHz (Channel 13) and the Coast Guard liaison frequency 157.100 MHz (Channel 22A). Additionally the receiver is capable of reception of G3E emissions on the navigational frequency of 156.375 MHz (Channel 67) while receiving in any of the applicable waters.

SUPERVISED BY:



Morton Flom, P. Eng.

PAGE NO. 36 of 36.
NAME OF TEST: Necessary Bandwidth and Emission Bandwidth
SPECIFICATION: 47 CFR 2.202(g)

MODULATION = 16K0G3E

NECESSARY BANDWIDTH CALCULATION:

MAXIMUM MODULATION (M), kHz	=	3
MAXIMUM DEVIATION (D), kHz	=	5
CONSTANT FACTOR (K)	=	1
NECESSARY BANDWIDTH (B _N), kHz	=	(2 x M) + (2 x D x K)
	=	16.0

SUPERVISED BY:

Morton Flom P. Eng.

Morton Flom, P. Eng.

TESTIMONIAL
AND
STATEMENT OF CERTIFICATION

THIS IS TO CERTIFY THAT:

1. THAT the application was prepared either by, or under the direct supervision of, the undersigned.
2. THAT the technical data supplied with the application was taken under my direction and supervision.
3. THAT the data was obtained on representative units, randomly selected.
4. THAT, to the best of my knowledge and belief, the facts set forth in the application and accompanying technical data are true and correct.

CERTIFYING ENGINEER:



Morton Flom, P. Eng.

STATEMENT OF QUALIFICATIONS

EDUCATION:

1. B. ENG. in ENGINEERING PHYSICS, 1949, McGill University, Montreal, Canada.
2. Post Graduate Studies, McGill University & Sir Goerge Williams University, Montreal.

PROFESSIONAL AFFILIATIONS:

1. ARIZONA SOCIETY OF PROFESSIONAL ENGINEERS (NSPE), #026 031 821.
2. ORDER OF ENGINEERS (QUEBEC) 1949. #45 34.
3. ASSOCIATION OF PROFESSIONAL ENGINEERS, GEOPHYSICISTS & GEOLOGISTS OF ALBERIA #5916.
4. REGISTERED ENGINEERING CONSULTANT - GOVERNMENT OF CANADA, DEPARTMENT OF COMMUNICATIONS. Radio Equipment approvals.
5. IEEE, Lifetime member no. 041/204 (Member since 1947).

EXPERIENCE:

1. Research/Development/Senior Project Engineer. R.C.A. LIMITED (4 years).
2. Owner/Chief Engineer of Electronics. Design/Manufacturing & Cable TV Companies (10 years)
3. CONSULTING ENGINEER (over 25 years).



MORTON FLOM, P. Eng.