

Sub-part  
2.983(e):

TEST AND MEASUREMENT DATA

All tests and measurement data shown were performed in accordance with FCC Rules and Regulations, Volume II; Part 2, Sub-part J, Sections 2.981, 2.983, 2.985, 2.987, 2.989, 2.991, 2.993, 2.995, 2.997, 2.999 and the following individual Parts:

- \_\_\_ 21 - Domestic Public Fixed Radio Services
- \_\_\_ 22 - Public Mobile Services
- \_\_\_ 22 Subpart H - Cellular Radiotelephone Service
- \_\_\_ 22.901(d) - Alternative technologies and auxiliary services
- \_\_\_ 23 - International Fixed Public Radiocommunication services
- \_\_\_ 24 - Personal Communications Services
- \_\_\_ 74 Subpart H - Low Power Auxiliary Stations
- x 80 - Stations in the Maritime Services
- \_\_\_ 80 Subpart E - General Technical Standards
- \_\_\_ 80 Subpart F - Equipment Authorization for Compulsory Ships
- \_\_\_ 80 Subpart K - Private Coast Stations and Marine Utility Stations
- \_\_\_ 80 Subpart S - Compulsory Radiotelephone Installations for Small Passenger Boats
- \_\_\_ 80 Subpart T - Radiotelephone Installation Required for Vessels on the Great Lakes
- \_\_\_ 80 Subpart U - Radiotelephone installations Required by the Bridge-to-Bridge Act
- \_\_\_ 80 Subpart V - Emergency Position Indicating Radiobeacons (EPIRB'S)
- \_\_\_ 80 Subpart W - Global Maritime Distress and Safety System (GMDSS)
- \_\_\_ 80 Subpart X - Voluntary Radio Installations
- \_\_\_ 87 - Aviation Services
- \_\_\_ 90 - Private Land Mobile Radio Services
- \_\_\_ 94 - Private Operational-Fixed Microwave Service
- \_\_\_ 95 Subpart A - General Mobile Radio Service (GMRS)
- \_\_\_ 95 Subpart C - Radio Control (R/C) Radio Service
- \_\_\_ 95 Subpart D - Citizens Band (CB) Radio Service
- \_\_\_ 95 Subpart E - Family Radio Service
- \_\_\_ 95 Subpart F - Interactive Video and Data Service (IVDS)

STANDARD TEST CONDITIONS  
and  
ENGINEERING PRACTICES

Except as noted herein, the following conditions and procedures were observed during the testing:

ROOM TEMPERATURE	=	25±5°C
ROOM HUMIDITY	=	20-50%
D.C. SUPPLY VOLTAGE, Vdc	=	7.2
A.C. SUPPLY VOLTAGE, Vac	=	N/A
A.C. SUPPLY FREQUENCY, Hz	=	N/A

Prior to testing, the E.U.F. was tuned up in accordance with the manufacturer's alignment procedures. All external gain controls were maintained at the position of maximum and/or optimum gain throughout the testing.

Measurement results, unless otherwise noted, are worst case measurements.

NAME OF TEST: R. F. POWER OUTPUT  
PARAGRAPH: 47 CFR 2.985 (a)  
GUIDE: TIA/EIA STANDARD 603  
TEST CONDITIONS: STANDARD TEMPERATURE & HUMIDITY  
TEST EQUIPMENT: AS PER ATTACHED PAGE

MEASUREMENT PROCEDURE

1. The E.U.T. was connected to a resistive coaxial attenuator of normal load impedance, and the unmodulated output power was measured by means of an R. F. Power Meter.
2. Measurement accuracy is  $\pm 3\%$ .

MEASUREMENT RESULTS

NOMINAL, MHz	CHANNEL	R.F. POWER OUTPUT, WATTS	
		Lo	Hi
156.800	16	1	5

SUPERVISED BY:

*M. J. Flom P. Eng.*  
MORTON FLOM, P. Eng.

R.F. POWER OUTPUT (A.M. OR F.M.)

TEST 1: R. F. POWER OUTPUT  
 TEST 2: FREQUENCY STABILITY

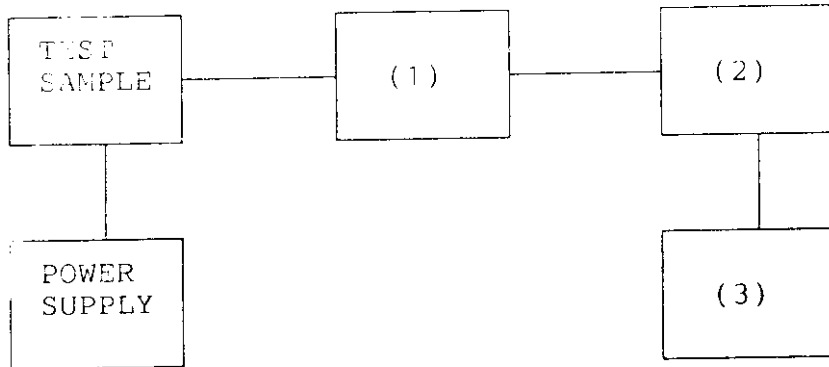

(1) COAXIAL ATTENUATOR

NARDA 766-10	---
SIERRA 661A-30	x
BIRD 8329 (30 dB)	---
_____	---

(2) POWER METERS

HP 435A	---
HP 436A	x
HP 8901A	x
_____	---

(3) FREQUENCY COUNTER

HP 5383A	---
HP 5334B	x
HP 8901A FREQUENCY MODE	x
_____	---

PAGE 8.

NAME OF TEST: MODULATION CHARACTERISTICS -  
FREQUENCY RESPONSE OF AUDIO MODULATING CIRCUIT

PARAGRAPH: 47 CFR 2.987 (a)

GUIDE: TIA/EIA STANDARD 603

TEST CONDITIONS: S. T. & H.

TEST EQUIPMENT: AS PER ATTACHED PAGE

MEASUREMENT PROCEDURE

1. The E.U.T. and test equipment were set up as shown on the following page.
2. The audio signal generator was connected to the audio input circuit/microphone of the E.U.T.
3. The audio signal input was adjusted to obtain 50% modulation at 1 kHz, and this point was taken as the 0 dB reference level.
4. With input levels held constant and below limiting at all frequencies, the audio signal generator was varied from 100 Hz to 50 kHz.
5. The response in dB relative to 1 kHz was then measured, using the HP 8901A Modulation Analyzer.
6. MEASUREMENT RESULTS: ATTACHED

TRANSMITTER TEST SET-UP

- TEST A. MODULATION CAPABILITY/DISTORTION
- TEST B. AUDIO FREQUENCY RESPONSE
- TEST C. HUM AND NOISE LEVEL
- TEST D. RESPONSE OF LOW PASS FILTER
- TEST E. MODULATION LIMITING

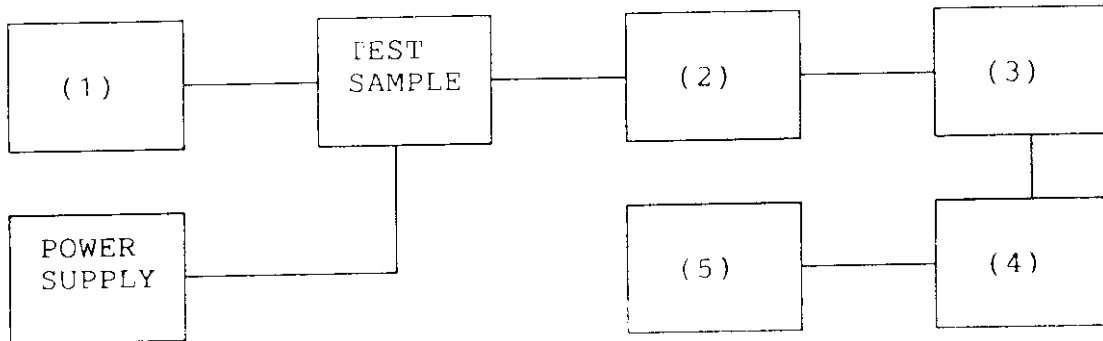

(1) AUDIO OSCILLATOR/GENERATOR

HP 204D	---
HP 8903A	<u>  x  </u>
HP 3312A	---
_____	---

(2) COAXIAL ATTENUATOR

NARDA 766-10	---
SIERRA 661A-30	<u>  x  </u>
BIRD 8329 (30 dB)	---
_____	---

(3) MODULATION ANALYZER

HP 8901A	<u>  x  </u>
_____	---

(4) AUDIO ANALYZER

HP 8903A	<u>  x  </u>
_____	---

(5) SCOPE

HP 1741A	---
HP 181F	---
TEK 935	---
_____	---

PAGE 10.  
 TRANSMITTER AUDIO FREQUENCY RESPONSE  
 STANDARD, HX350S  
 12 MAR 1998, 09:58

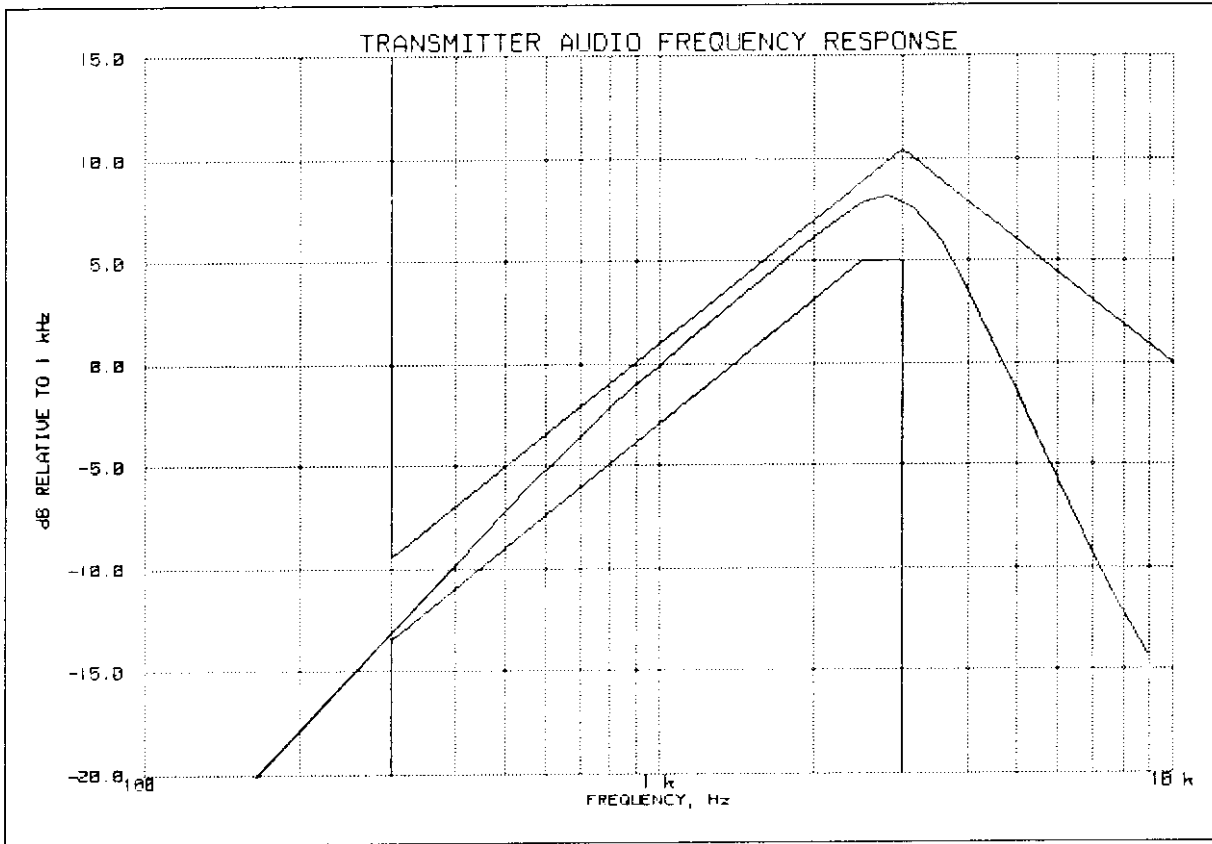

PEAK AUDIO FREQUENCY, Hz: 2820

TABLE VALUES:

FREQUENCY, Hz	LEVEL, dB	FREQUENCY, Hz	LEVEL, dB	FREQUENCY, Hz	LEVEL, dB
300	-13.0	30000	-19.9		
20000	-19.8	50000	-19.9		

*M. Flom P. Eng.*

SUPERVISED BY:

MORTON FLOM, P. Eng.

NAME OF TEST: MODULATION CHARACTERISTICS -  
FREQUENCY RESPONSE OF AUDIO LOW PASS FILTER

PARAGRAPH: 47 CFR 2.987 (a)

GUIDE: TIA/EIA STANDARD 603

TEST CONDITIONS: S. T. & H.

TEST EQUIPMENT: AS PER PREVIOUS PAGE

MEASUREMENT PROCEDURE

1. The E.U.T. and test equipment were set up such that the audio input was connected at the input to the modulation limiter, and the modulated stage.
2. The audio output was connected at the output to the modulated stage.
3. MEASUREMENT RESULTS: ATTACHED



PAGE 12.

FREQUENCY RESPONSE OF AUDIO LOW PASS FILTER  
STANDARD, HX350S  
20 MAR 1998, 09:55

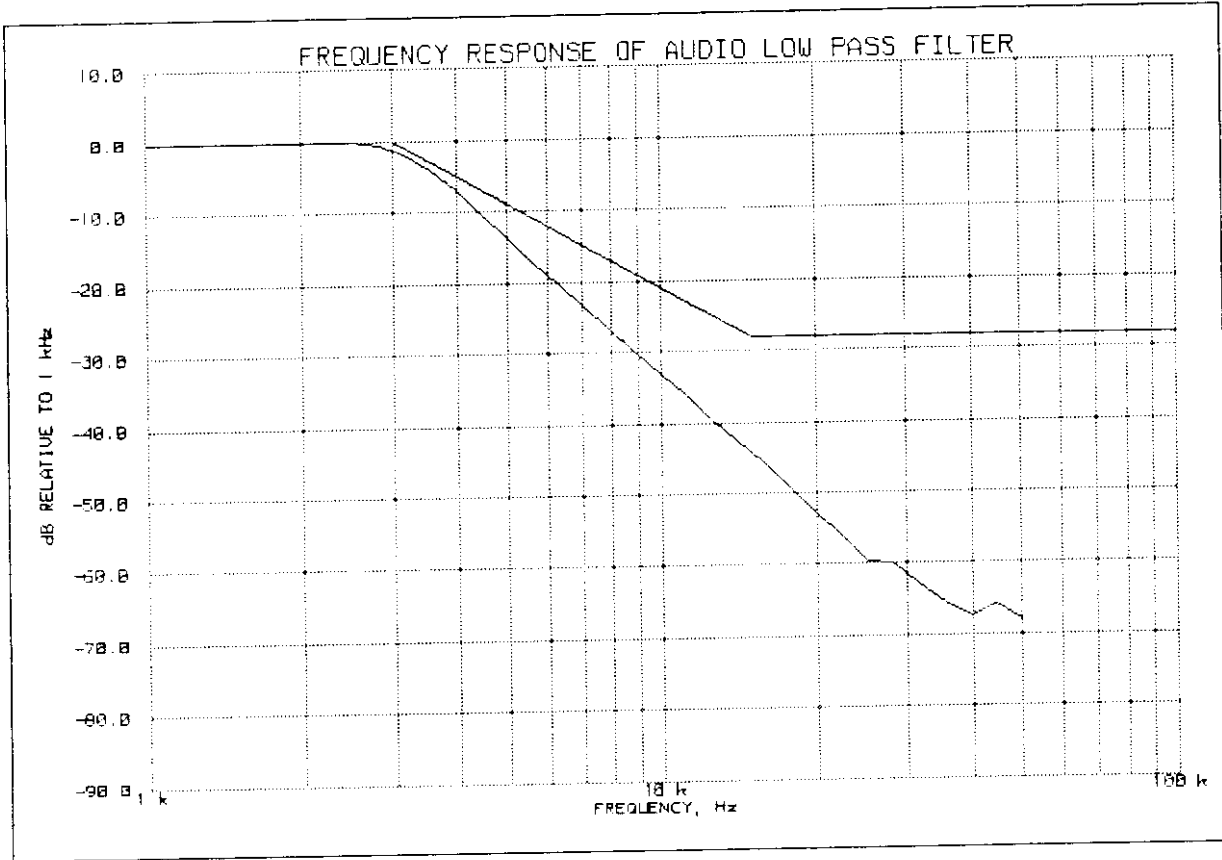

COPYRIGHT © 1969 BY W. FLOM ASSOCIATES, INC. ALL RIGHTS RESERVED.

PEAK AUDIO FREQUENCY, Hz: 2500

*Morton Flom P. Eng.*

SUPERVISED BY:

MORTON FLOM, P. Eng.

NAME OF TEST: MODULATION CHARACTERISTICS -  
MODULATION LIMITING

PARAGRAPH: 47 CFR 2.987 (b), 80.211, 80.213

GUIDE: TIA/EIA STANDARD 603

TEST CONDITIONS: S. T. & H.

TEST EQUIPMENT: AS PER PREVIOUS PAGE

MEASUREMENT PROCEDURE

1. The audio signal generator was connected to the audio input circuit/microphone of the E.U.T. as for "Frequency Response of the Audio Modulating Circuit."
2. The modulation response was measured for each of three tones (one of which was the frequency of maximum response), and the input voltage was varied and was observed on an HP 8901A Modulation Analyzer.
3. The audio input level was varied from 30% modulation ( $\pm 1.5$  kHz deviation) to at least 20 dB higher than the saturation point.
4. Measurements were performed for both negative and positive modulation and the respective results were recorded.
5. MEASUREMENT RESULTS: ATTACHED

PAGE 14.1.  
 MODULATION LIMITING  
 STANDARD, HX350S  
 1998-MAR-12, 10:14

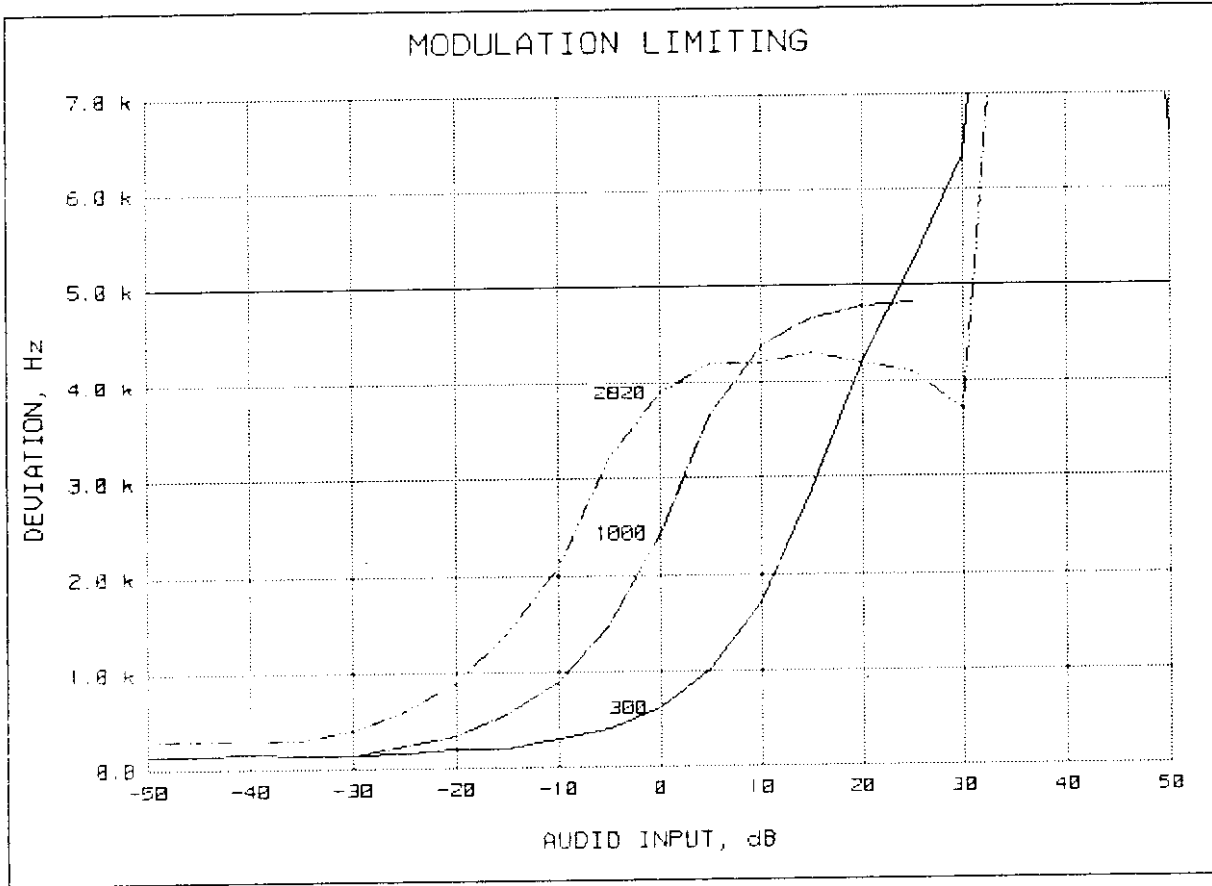

REFERENCE DEVIATION, kHz = 2.5  
 REFERENCE MODULATION, Hz = 1000  
 PEAKS = POSITIVE  
 AUDIO AMPLITUDE, mV = 15.28

*Morton Flom, P. Eng.*

SUPERVISED BY:

MORTON FLOM, P. Eng.

PAGE 14.2.  
MODULATION LIMITING  
STANDARD, HX350S  
1998-MAR-12, 10:14

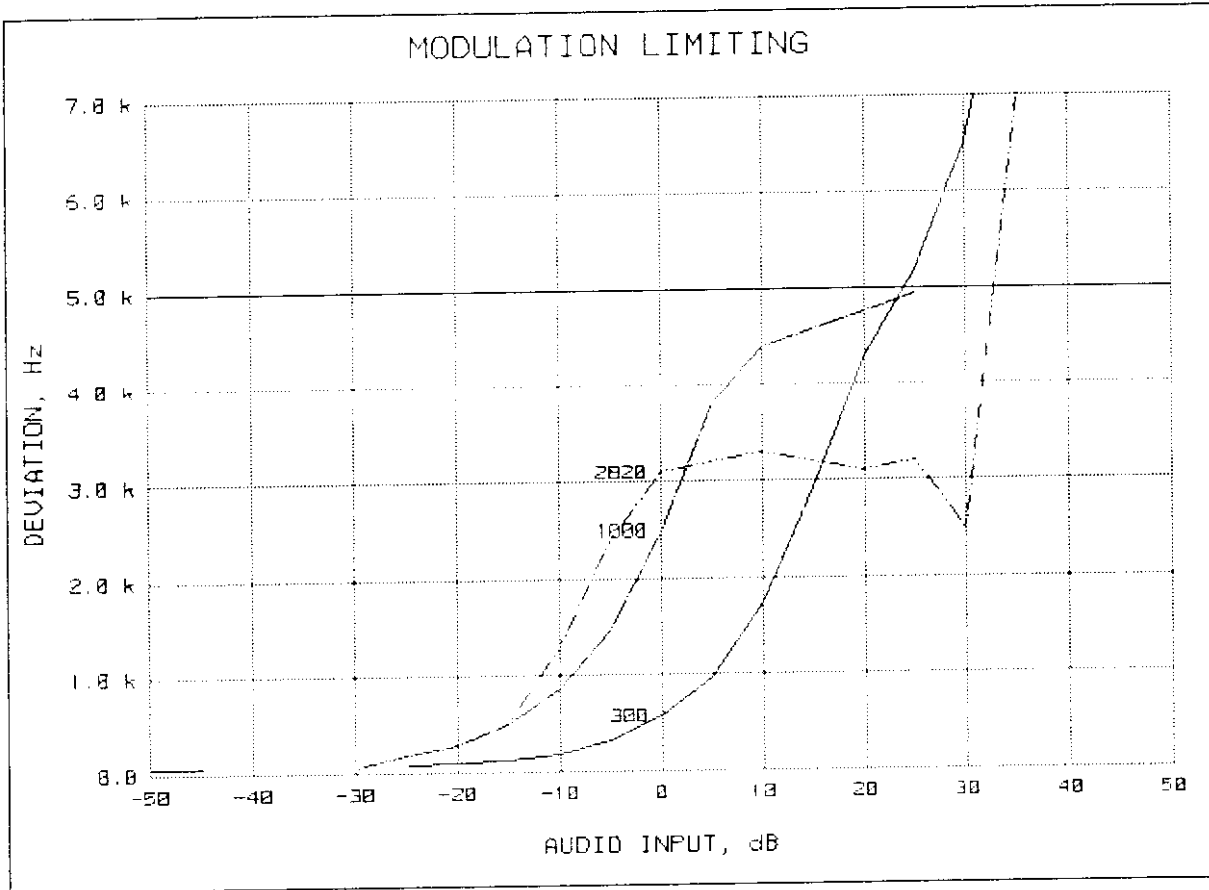

REFERENCE DEVIATION, kHz = 2.5  
 REFERENCE MODULATION, Hz = 1000  
 PEAKS = NEGATIVE  
 AUDIO AMPLITUDE, mV = 16.18

*Morton Flom P. Eng.*

SUPERVISED BY:

MORTON FLOM, P. Eng.

NAME OF TEST: OCCUPIED BANDWIDTH  
PARAGRAPH: 47 CFR 2.989 (c)(1), 80.205  
GUIDE: TIA/EIA STANDARD 603  
TEST CONDITIONS: S. T. & H.  
TEST EQUIPMENT: AS PER ATTACHED PAGE

MEASUREMENT PROCEDURE

1. The E.U.T. and test equipment were set up as shown on the following page, with the Spectrum Analyzer connected.
2. The audio signal generator was adjusted to the frequency of maximum response and with output level set for  $\pm 2.5$  kHz deviation (or 50% modulation).
3. With level constant, the frequency was set at 2.5 kHz, then the signal level was increased 16 dB.
4. The Occupied Bandwidth was measured with the Spectrum Analyzer controls set as shown on the test results.
5. MEASUREMENT RESULTS: ATTACHED

TRANSMITTER SPURIOUS EMISSION

TEST A. OCCUPIED BANDWIDTH (IN-BAND SPURIOUS)  
 TEST B. OUT-OF-BAND SPURIOUS

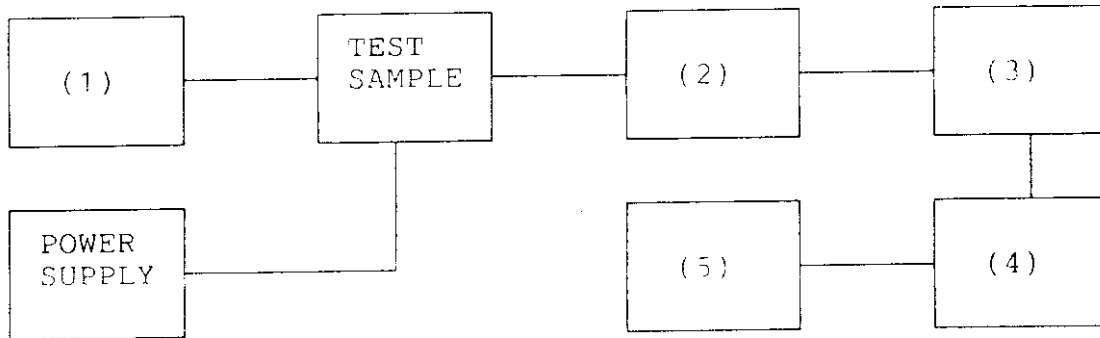

- (1) AUDIO OSCILLATOR/GENERATOR
  - HP 204D \_\_\_\_\_
  - HP 8903A   X
  - HP 3312A \_\_\_\_\_
  
- (2) COAXIAL ATTENUATOR
  - NARDA 766-10 \_\_\_\_\_
  - SIERRA 661A-30   X
  - BIRD 8329 (30 dB)   X
  
- (3) FILTERS; NOTCH, HP, LP, BP
  - CIRQTEL FHT \_\_\_\_\_
  - EAGLE TNF-1   X
  - PHELPS DODGE PD-495-8 \_\_\_\_\_
  
- (4) SPECTRUM ANALYZER
  - HP 8566B   X
  - HP 8563E \_\_\_\_\_
  
- (5) SCOPE
  - HP 1741A \_\_\_\_\_
  - HP 181T \_\_\_\_\_
  - TEK 935 \_\_\_\_\_

PAGE 17.1.  
SPECTRUM ANALYZER PRESENTATION  
STANDARD, HX350S  
1998-MAR-12, 10:42, THR

APV0697

POWER: LOW  
MODULATION: NONE

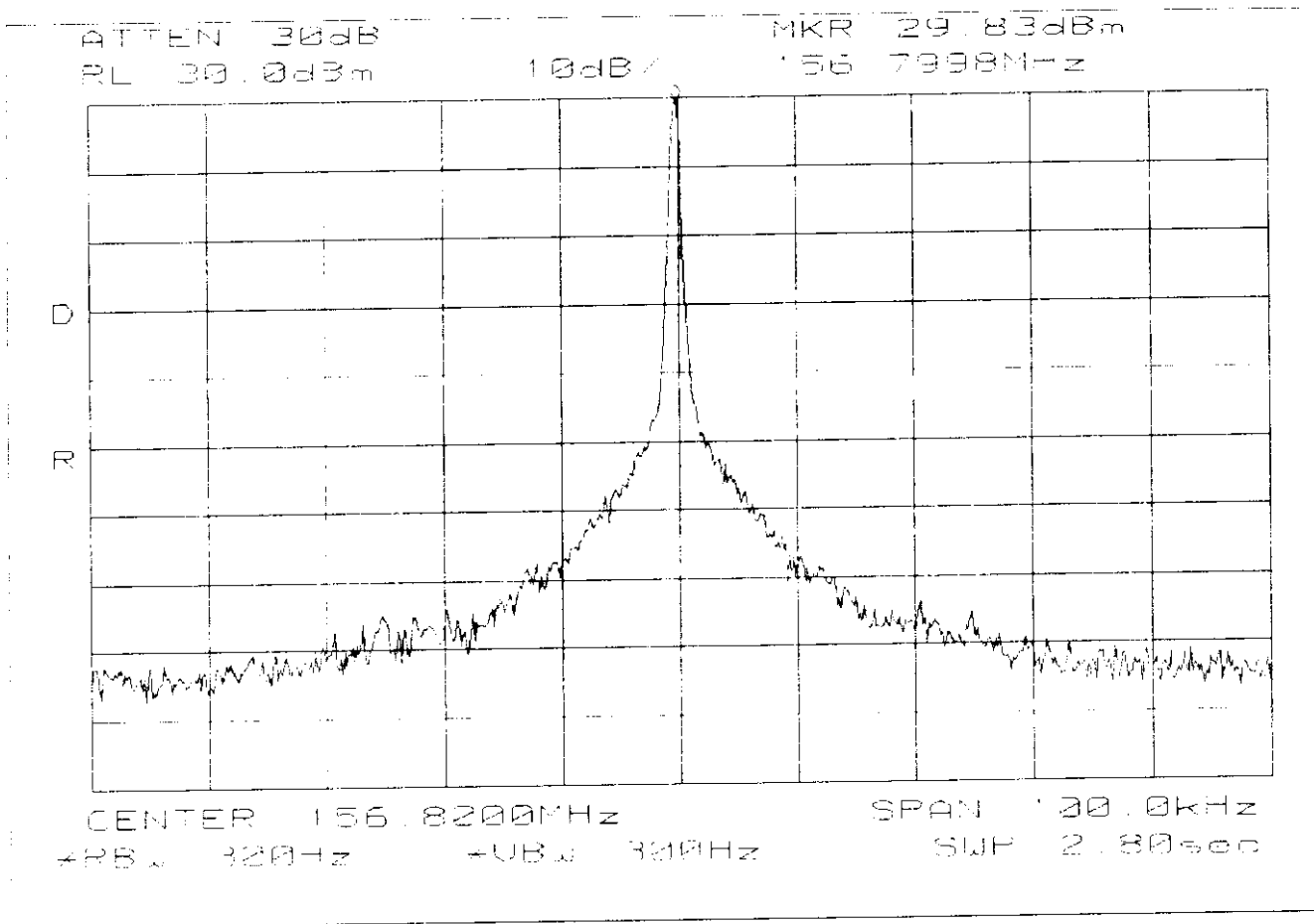

PAGE 17.2.  
SPECTRUM ANALYZER PRESENTATION  
STANDARD, HX350S  
1998-MAR-12, 10:44, THR

POWER: LOW  
MODULATION: VOICE: 2500 Hz SINE WAVE  
MASK: B, VHF/UHF 25kHz, w/LPF

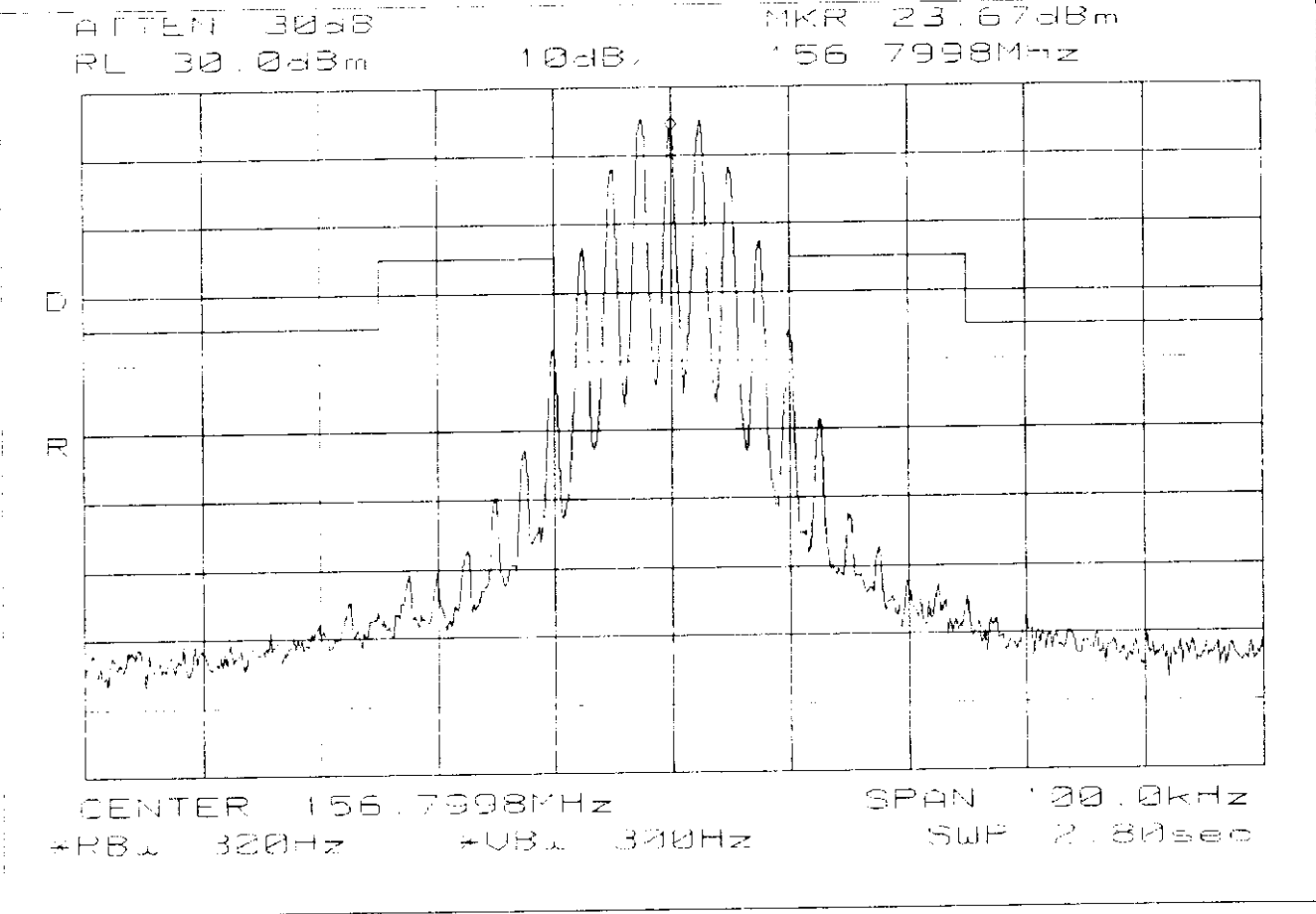



PAGE 17.3.  
SPECTRUM ANALYZER PRESENTATION  
STANDARD, HX350S  
1998-MAR-12, 10:40, THR

POWER: HIGH  
MODULATION: NONE

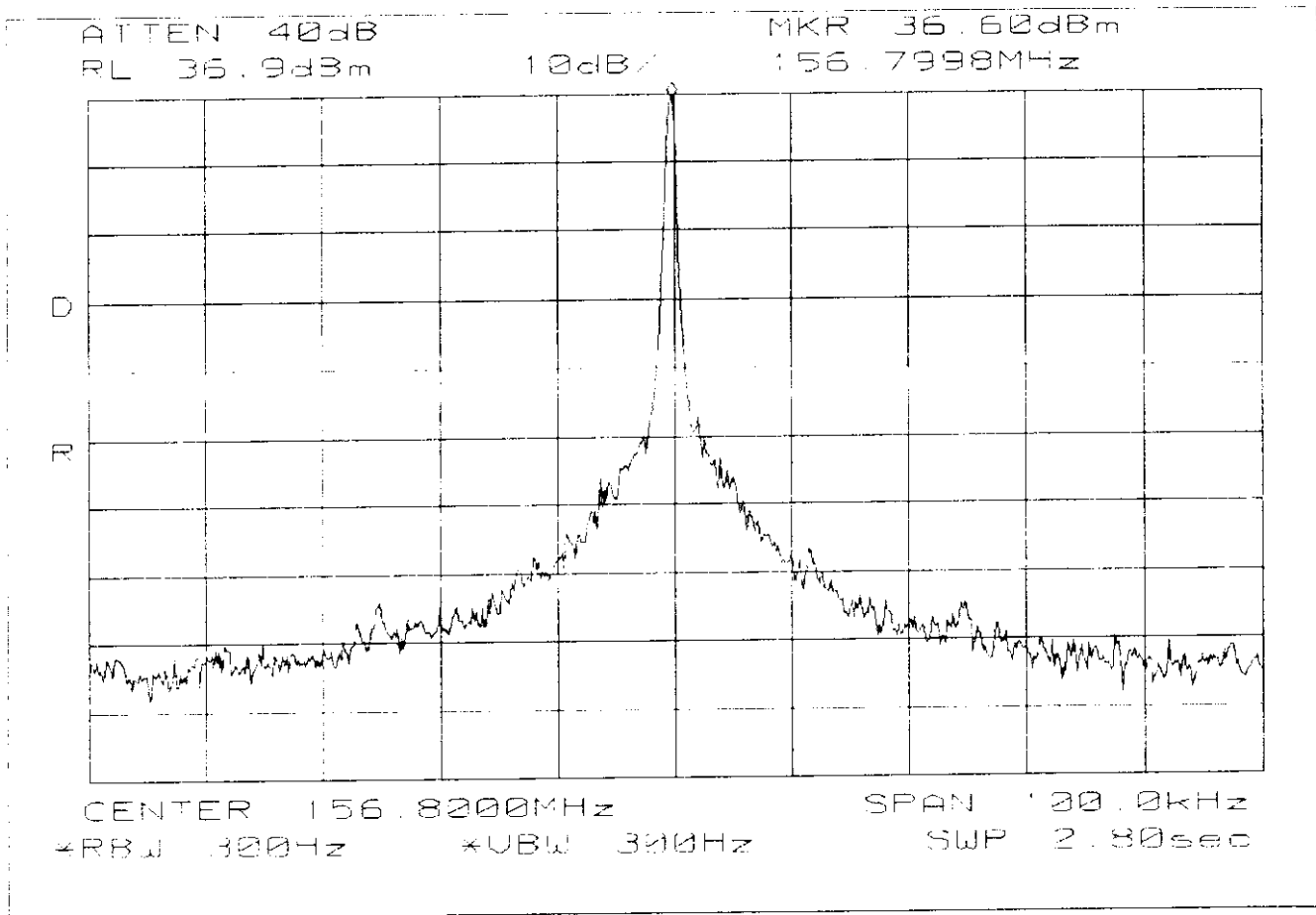

PAGE 17.4.  
SPECTRUM ANALYZER PRESENTATION  
STANDARD, HX350S  
1998-MAR-12, 10:45, THR

POWER: HIGH  
MODULATION: VOICE: 2500 Hz SINE WAVE  
MASK: B, VHF/UHF 25kHz, w/LPF

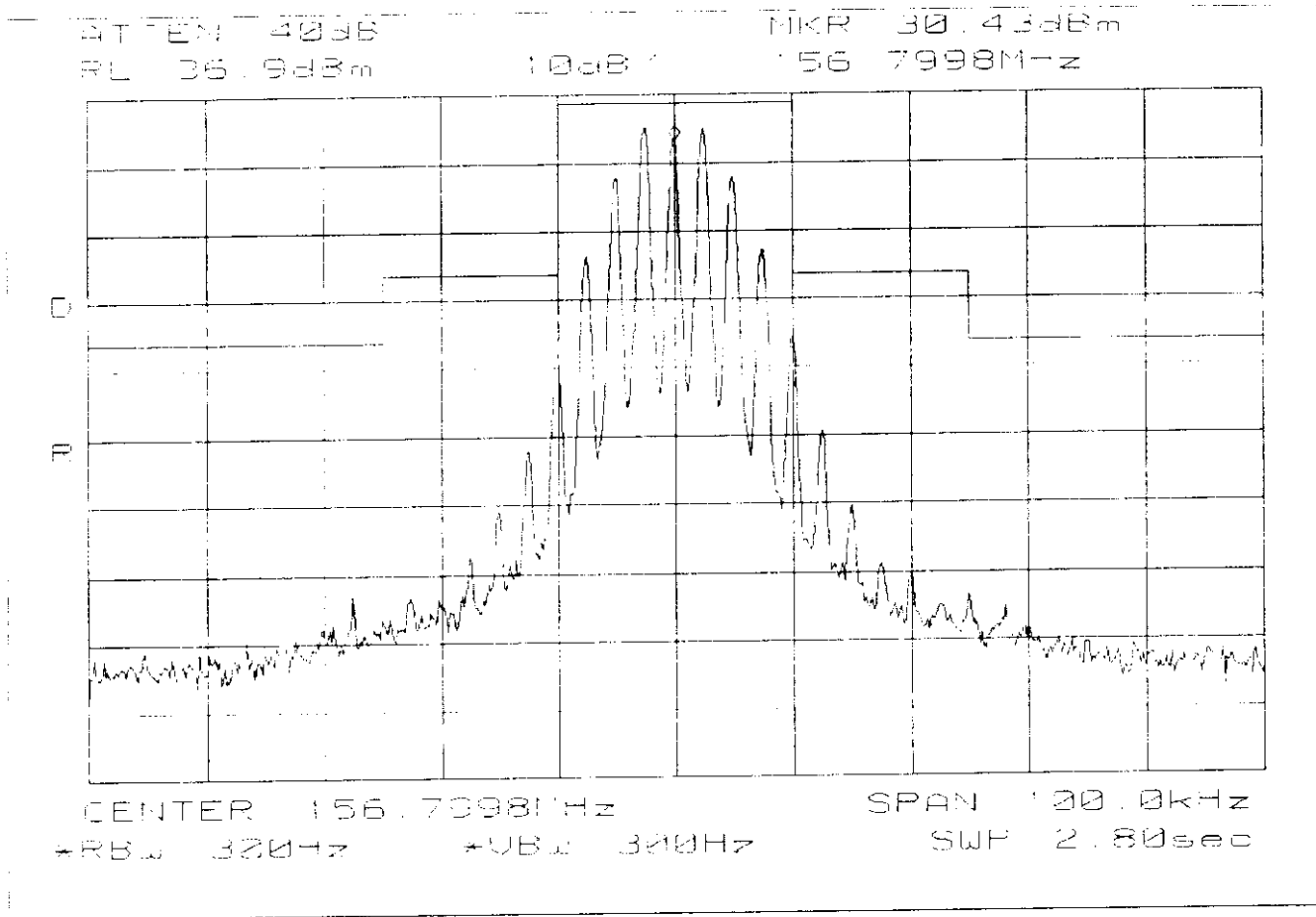

NAME OF TEST: SPURIOUS EMISSIONS AT ANTENNA TERMINALS  
PARAGRAPH: 47 CFR 2.991  
GUIDE: TIA/EIA STANDARD 603  
TEST CONDITIONS: S. T. & H.  
TEST EQUIPMENT: AS PER ATTACHED PAGE

MEASUREMENT PROCEDURE

1. The emissions were measured for the worst case as follows:
  - (a): within a band of frequencies defined by the carrier frequency plus and minus one channel.
  - (b): from the lowest frequency generated in the E.U.T. and to at least the 10th harmonic of the carrier frequency, or 40 GHz, whichever is lower.
2. The magnitude of spurious emissions which are attenuated more than 20 dB below the permissible value need not be specified.
3. MEASUREMENT RESULTS: ATTACHED

FREQUENCY OF CARRIER, MHz = 156.8  
 SPECTRUM SEARCHED, GHz = 0 to 10 x F<sub>C</sub>  
 MAXIMUM RESPONSE, Hz = 2500  
 ALL OTHER EMISSIONS = ≥ 20 dB BELOW LIMIT  
 LIMIT, dBc:  $-(43 + 10 \text{ LOG } P_0)$  = -50.0 (5 Watts)  
 -43.0 (1 Watt)

SUPERVISED BY:

  
MORTON FLOM, P. Eng.

PAGE NO.

19.1.

APV0697

G83C002

TRANSMITTER SPURIOUS EMISSIONS (CONDUCTED)

POWER: LOW

---

FREQUENCY TUNED, MHz	FREQUENCY EMISSION, MHz	LEVEL, dBm	LEVEL, dBc	LEVEL, µW
156.800	134.808	-37.3	-67.3	0
156.800	178.392	-36.5	-66.5	0
156.800	313.605	-32.5	-62.5	1
156.800	470.388	-35.7	-65.7	0
156.800	627.215	-48.5	-78.5	0
156.800	783.617	-48.2	-78.2	0
156.800	940.815	-44.7	-74.7	0
156.800	1097.558	-43.0	-73.0	0
156.800	1254.283	-31.7	-61.7	1
156.800	1411.160	-37.7	-67.7	0
156.800	1568.028	-45.5	-75.5	0
156.800	1724.807	-46.0	-76.0	0
156.800	1881.710	-49.5	-79.5	0
156.800	2037.933	-49.2	-79.2	0
156.800	2194.907	-48.5	-78.5	0
156.800	2351.655	-48.7	-78.7	0

---

PAGE NO.

19.2.

APV0697

G83C001

TRANSMITTER SPURIOUS EMISSIONS (CONDUCTED)

POWER: HIGH

FREQUENCY TUNED, MHz	FREQUENCY EMISSION, MHz	LEVEL, dBm	LEVEL, dBc	LEVEL, $\mu$ W
156.800	112.992	-32.6	-69.5	1
156.800	134.808	-32.7	-69.6	1
156.800	178.392	-31.9	-68.8	1
156.800	313.602	-34.1	-71.0	0
156.800	470.397	-30.2	-67.1	1
156.800	627.353	-39.7	-76.6	0
156.800	783.987	-38.6	-75.5	0
156.800	941.118	-39.2	-76.1	0
156.800	1097.722	-39.4	-76.3	0
156.800	1254.365	-32.2	-69.1	1
156.800	1411.173	-35.7	-72.6	0
156.800	1567.942	-39.7	-76.6	0
156.800	1724.587	-39.1	-76.0	0
156.800	1881.218	-39.7	-76.6	0
156.800	2038.265	-39.9	-76.8	0
156.800	2195.140	-39.2	-76.1	0
156.800	2352.237	-38.7	-75.6	0

NAME OF TEST: FIELD STRENGTH OF SPURIOUS RADIATION

PARAGRAPH: 47 CFR 2.993 (a)

GUIDE: SEE MEASUREMENT PROCEDURE BELOW

TEST CONDITIONS: S. T. & H.

TEST EQUIPMENT: AS PER ATTACHED PAGE

MEASUREMENT PROCEDURE

1. A description of the measurement facilities was filed with the FCC and was found to be in compliance with the requirements of Section 15.38, by letter from the FCC dated March 3, 1997, FILE 31040/SIT. All pertinent changes will be reported to the Commission by up-date prior to March 2000.

2. At first, in order to locate all spurious frequencies and approximate amplitudes, and to determine proper equipment functioning, the test sample was set up at a distance of three meters from the test instrument. Valid spurious signals were determined by switching the power on and off.

3. In the field, the test sample was placed on a wooden turntable above ground at three (or thirty) meters away from the search antenna. The test sample was connected to an R.F. Wattmeter and a 50 ohm dummy load, and adjusted to its rated output.

In order to obtain the maximum response at each spurious frequency, the turntable was rotated. Also, the Search Antennas were raised and lowered vertically, and all cables were oriented. Excess power lead was coiled near the power supply.

4. A signal generator, connected with a non-radiating cable to a vertically polarized half-wave antenna (for each frequency involved) was substituted for the transmitter. The Search Antenna was raised and lowered to obtain maximum indicated.

5. The signal generator output was adjusted until a signal level indication equal to that from the transmitter was obtained.

6. Steps 4 and 5 were repeated, using a horizontally polarized half-wave antenna. The higher of the two observations was noted.

NAME OF TEST: FIELD STRENGTH OF SPURIOUS RADIATION

PARAGRAPH: 47 CFR 2.993 (a)

MEASUREMENT PROCEDURE (CONT.)

7. Power into the half-wave antenna was calculated from the characteristic impedance of the line, and the voltage output from the signal generator.

8. The level of each spurious radiation with reference to the transmitter power in dB, was calculated from:

$$\text{SPURIOUS LEVEL, dB} = 10 \text{ LOG } \left( \frac{\text{Calculated Spurious Power}}{\text{Tx Power (Wattmeter)}} \right) \text{ [from para. 7].}$$

9. The worst case for all channels is shown.

10. Measurement summary:

FREQUENCY OF CARRIER, MHz	= 156.8
SPECTRUM SEARCHED, GHz	= 0 to 10 x F <sub>C</sub>
ALL OTHER EMISSIONS	= ≥ 20 dB BELOW LIMIT
LIMIT, dBc	= -50 (5 Watts) -43 (1 Watt)

10. Measurement results: ATTACHED

RADIATED TEST SETUP

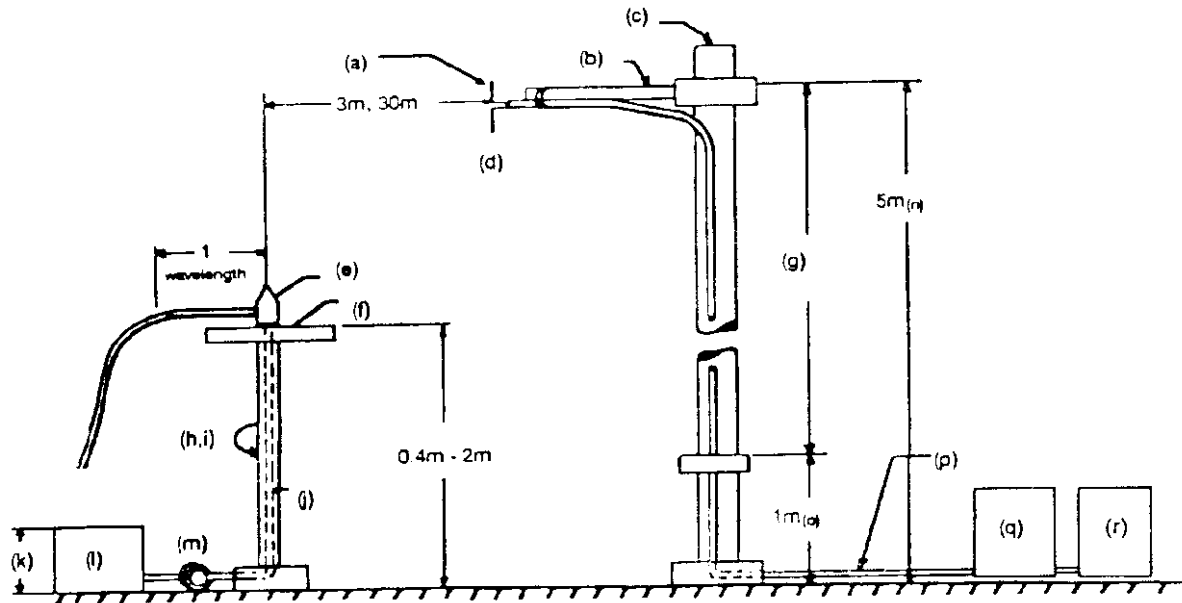

NOTES:

- (a) Search Antenna - Rotatable on boom.
- (b) Non-metallic boom.
- (c) Non-metallic mast.
- (d) Adjustable horizontally.
- (e) Equipment Under Test.
- (f) Turntable.
- (g) Boom adjustable in height.
- (h) External control cables routed horizontally at least one wavelength.
- (i) Rotatable.
- (j) Cables routed through hollow turntable center.
- (k) 30 cm or less.
- (l) External power source.
- (m) 10 cm diameter coil of excess cable.
- (n) 25 cm (V), 1 m-7 m (V, H).
- (o) 25 cm from bottom end of 'V', 1 m normally.
- (p) Calibrated Cable at least 10 m in length.
- (q) Amplifier (optional).
- (r) Spectrum Analyzer.



TRANSMITTER SPURIOUS EMISSIONS (RADIATED FIELD STRENGTH)

ALL OTHER EMISSIONS =  $\geq$  20 dB BELOW LIMIT

EMISSION, MHz/HARMONIC	SPURIOUS LEVEL BELOW	
	Lo	Hi
2nd to 10th	<-60	<-65

SUPERVISED BY:

*M. F. Eng.*  
MORTON FLOM, P. Eng.

PAGE 24.

APV0697

NAME OF TEST: FREQUENCY STABILITY - TEMPERATURE VARIATION  
PARAGRAPH: 47 CFR 2.995 (a)(1), 80.209  
GUIDE: TIA/EIA STANDARD 603  
TEST CONDITIONS: AS INDICATED  
TEST EQUIPMENT: AS PER ATTACHED PAGE

MEASUREMENT PROCEDURE

1. The E.U.T. and test equipment were set up as shown on the following page.
2. With all power removed, the temperature was decreased to  $-30^{\circ}\text{C}$  and permitted to stabilize for three hours. Power was applied and the maximum change in frequency was noted within one minute.
3. With power OFF, the temperature was raised in  $10^{\circ}\text{C}$  steps. The sample was permitted to stabilize at each step for at least one-half hour. Power was applied and the maximum frequency change was noted within one minute.
4. The temperature tests were performed for the worst case.
5. MEASUREMENT RESULTS: ATTACHED

TRANSMITTER TEST SET-UP

- TEST A. OPERATIONAL STABILITY
- TEST B. CARRIER FREQUENCY STABILITY
- TEST C. OPERATIONAL PERFORMANCE STABILITY
- TEST D. HUMIDITY
- TEST E. VIBRATION
- TEST F. ENVIRONMENTAL TEMPERATURE
- TEST G. FREQUENCY STABILITY: TEMPERATURE VARIATION
- TEST H. FREQUENCY STABILITY: VOLTAGE VARIATION

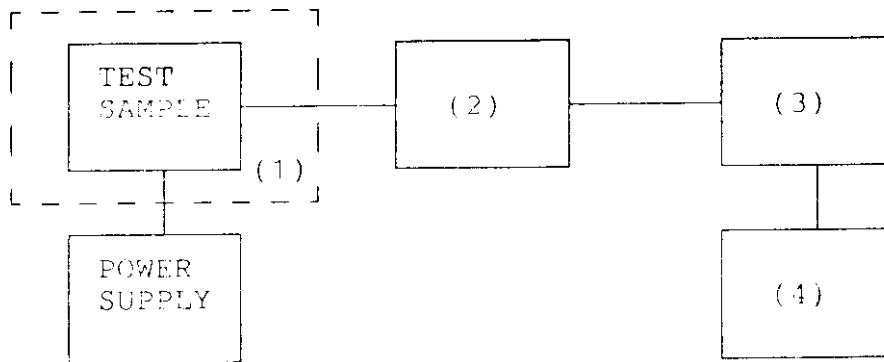

(1) TEMPERATURE, HUMIDITY, VIBRATION

TENNEY TEMPERATURE CHAMBER	<u>  x  </u>
WEBER HUMIDITY CHAMBER	<u>      </u>
L.A.B. RVH 18-100	<u>      </u>
<hr/>	

(2) COAXIAL ATTENUATOR

NARDA 766-10	<u>      </u>
SIERRA 661A-30	<u>  x  </u>
BIRD 8329 (30 dB)	<u>  x  </u>
<hr/>	

(3) R.F. POWER

HP 435A POWER METER	<u>      </u>
HP 436A POWER METER	<u>  x  </u>
HP 8901A POWER MODE	<u>  x  </u>
<hr/>	

(4) FREQUENCY COUNTER

HP 5383A	<u>      </u>
HP 5334B	<u>  x  </u>
HP 8901A	<u>  x  </u>
<hr/>	

TRANSMITTER FREQUENCY STABILITY  
STANDARD, HX350S  
13 MAR 1998, 08:16

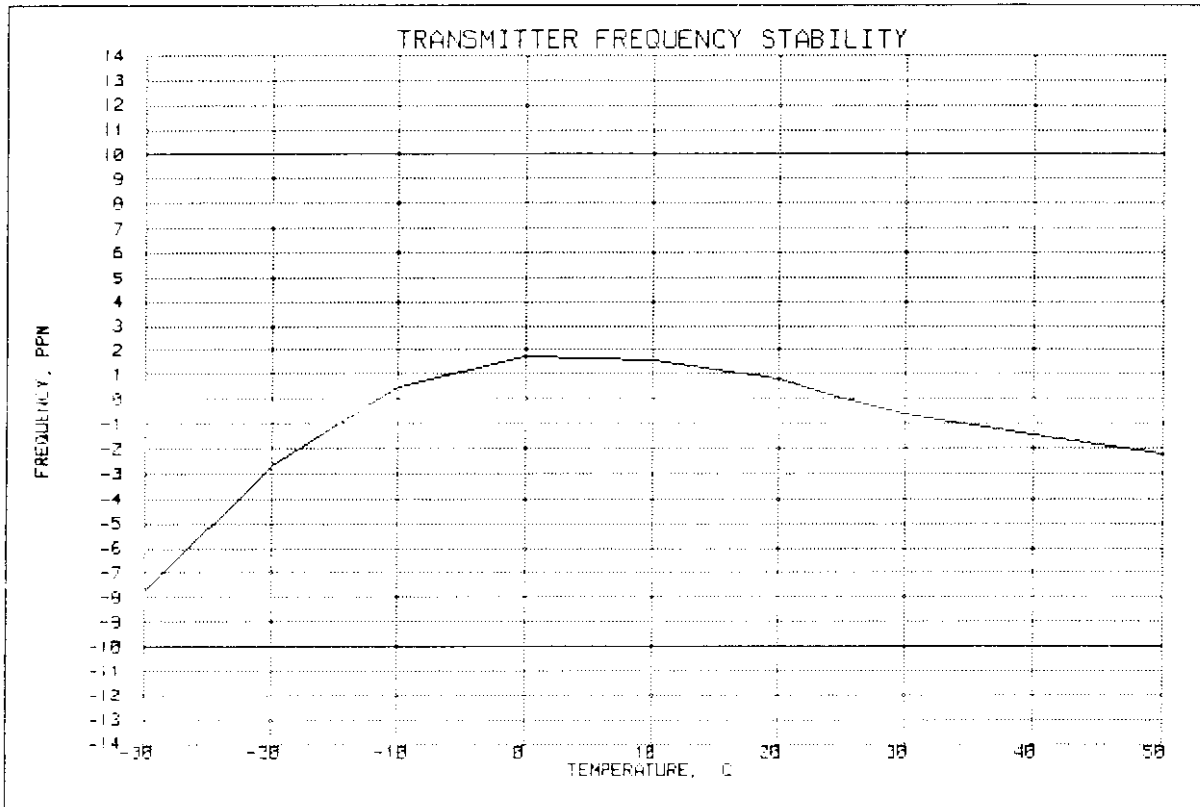

FREQUENCY OF CARRIER, MHz = 156.79992

LIMIT, ppm = 10

LIMIT, Hz = 1568

SUPERVISED BY:

MORTON FLOM, P. Eng.

NAME OF TEST: FREQUENCY STABILITY - VOLTAGE VARIATION  
PARAGRAPH: 47 CFR 2.995 (b)(1)  
GUIDE: SEE MEASUREMENT PROCEDURE BELOW  
TEST CONDITIONS: AS SHOWN  
TEST EQUIPMENT: AS PER PREVIOUS PAGE

MEASUREMENT PROCEDURE

1. The E.U.T. was placed in a temperature chamber at  $25 \pm 5^\circ\text{C}$  and connected as for "Frequency Stability - Temperature Variation" test.
2. The power supply voltage to the E.U.T. was varied from 85% to 115% of the nominal value measured at the input to the E.U.T.
3. The variation in frequency was measured for the worst case.

MEASUREMENT RESULTS

LIMIT, ppm = 2.5  
 LIMIT, Hz = 3928

STV, %	Vdc	<u>CHANGE IN FREQUENCY, Hz</u>	
85	6.1	156800000	0
100	7.2	156800000	0
115	8.3	156800000	0
BATTERY END POINT:	6.0	156800000	0

SUPERVISED BY:

*William F. Eng*  
 WILLIAM F. ENG, P. Eng.

PAGE 28.

APV0697

NAME OF TEST: USER CONTROLS

PARAGRAPH: 47 CFR 80.203(b)

GUIDE:

TEST CONDITIONS:

TEST EQUIPMENT:

STATEMENT

The external controls of this maritime station transmitter capable of operation in the 156-162 MHz band only provides for selection of maritime channels for which the maritime station is authorized. This transmitter is not capable of being programmed by station operators using external controls to transmit on channels other than those programmed by the manufacturer, service or maintenance personal.

The EUT fully complies with the requirements of 47 CFR 80.203(b).

NAME OF TEST: SUBPART T -  
G3E EMISSIONS & RECEIVER SENSITIVITY

PARAGRAPH: 47 CFR 80.961(a) & (b)

GUIDE:

TEST CONDITIONS: S. T. & H.

TEST EQUIPMENT: AS PER PREVIOUS PAGE

MEASUREMENT RESULTS

(a) The receiver is capable of reception of G3E emissions on the required frequencies.

(b) The sensitivity of the receiver at 20 dB SINAD is better than:

SENSITIVITY, dBm = -118.7

SENSITIVITY,  $\mu$ V = 0.260

SUPERVISED BY:

  
MOSTON FLOM, P. Eng.

NAME OF TEST: SUBPART U - BRIDGE-TO-BRIDGE ACT

PARAGRAPH: 47 CFR 80.1011, 80.1013

GUIDE:

TEST CONDITIONS: S. T. & H.

TEST EQUIPMENT: AS PER PREVIOUS PAGE

RESULTS

80.1011 Transmitter.

The transmitter is capable of G3E emissions on the navigational frequency 156.650 MHz (Channel 13) and the Coast Guard liaison frequency 157.100 MHz (Channel 22). Additionally the transmitter is capable of transmission of G3E emissions on navigational frequency of 156.375 MHz (Channel 67) while transmitting in any of the applicable waters.

80.1013 Receiver.

The receiver is capable of reception of G3E emissions on the navigational frequency of 156.650 MHz (Channel 13) and the Coast Guard liaison frequency 157.100 MHz (Channel 22A). In addition, the receiver is capable of reception of G3E emissions on the navigational frequency of 156.375 MHz (Channel 67) while receiving in any of the applicable waters.

SUPERVISED BY:

  
M. J. Flom, P. Eng.



PAGE 31.

APV0697

NAME OF TEST: NECESSARY BANDWIDTH AND EMISSION BANDWIDTH

PARAGRAPH: 47 CFR 2.202(g)

MODULATION = 16K0F3E

NECESSARY BANDWIDTH CALCULATION:

MAXIMUM MODULATION (M), kHz = 3  
MAXIMUM DEVIATION (D), kHz = 5  
CONSTANT FACTOR (K) = 1  
NECESSARY BANDWIDTH ( $B_N$ ), kHz =  $(2 \times M) + (2 \times D \times K)$   
= 16.0

SUPERVISED BY:

  
MORTON FLOM, P. Eng.

§ 15.205 Restricted Bands of operation.

APV0697

(a) Except as shown in paragraph (d) of this section, only spurious emissions are permitted in any of the frequency bands listed below:

MHz	MHz	MHz	GHz
0.090-0.110	16.42-16.423	399.9-410	4.5-5.25
0.495-0.505 <sup>1</sup>	16.89475-16.69525	600-614	5.35-5.46
2.1735-2.1905	16.80425-16.80475	960-1240	7.25-7.75
4.125-4.128	25.5-25.67	1300-1427	8.025-8.5
4.17725-4.17775	37.5-38.25	1435-1626.5	9.0-9.2
4.20725-4.20775	73-74.6	1645.5-1646.5	9.3-9.5
6.215-6.213	74.8-75.2	1660-1710	10.6-12.7
6.26775-6.26825	108-121.94	1718.8-1722.2	13.25-13.4
6.31175-6.31225	123-138	2200-2300	14.47-14.5
8.291-8.294	149.9-150.05	2310-2390	15.35-16.2
8.362-8.366	156.52475-156.52525	2483.5-2500	17.7-21.4
8.37625-8.38675	156.7-156.9	2655-2900	22.01-23.12
8.41425-8.41475	162.0125-167.17	3260-3267	23.6-24.0
12.29-12.293	167.72-173.2	3332-3339	31.2-31.8
12.51975-12.52025	240-285	3345.8-3358	36.43-36.5
12.57675-12.57725	322-335.4	3500-4400	(2)
13.36-13.41			

<sup>1</sup> Until February 1, 1999, this restricted band shall be 0.490-0.510 MHz.

<sup>2</sup> Above 38.6

TESTIMONIAL  
AND  
STATEMENT OF CERTIFICATION

APV0697

THIS IS TO CERTIFY:

1. THAT the application was prepared either by, or under the direct supervision of, the undersigned.
2. THAT the technical data supplied with the application was taken under my direction and supervision.
3. THAT the data was obtained on representative units, randomly selected.
4. THAT, to the best of my knowledge and belief, the facts set forth in the application and accompanying technical data are true and correct.

CERTIFYING ENGINEER:

  
MORTON FLOM, P. Eng.

STATEMENT OF QUALIFICATIONS
-----------------------------

EDUCATION:

1. B. ENG. in ENGINEERING PHYSICS, 1949, McGill University, Montreal, Canada.
2. Post Graduate Studies, McGill University & Sir George Williams University, Montreal.

PROFESSIONAL AFFILIATIONS:

1. ARIZONA SOCIETY OF PROFESSIONAL ENGINEERS (NSPE), #026 031 821.
2. ORDER OF ENGINEERS (QUEBEC) 1949. #4534.
3. ASSOCIATION OF PROFESSIONAL ENGINEERS, GEOPHYSICISTS & GEOLOGISTS OF ALBERTA #5916.
4. REGISTERED ENGINEERING CONSULTANT - GOVERNMENT OF CANADA, DEPARTMENT OF COMMUNICATIONS. Radio Equipment Approvals.
5. IEEE, Lifetime Member No. 0417204 (member since 1947).

EXPERIENCE:

1. Research/Development/Senior Project Engineer, R.C.A. LIMITED (4 years).
2. Owner/Chief Engineer of Electronics. Design/Manufacturing & Cable TV Companies (10 years).
3. CONSULTING ENGINEER (over 25 years).

*Morton Flom P. Eng.*  
MORTON FLOM, P. Eng.

## TEST INSTRUMENTATION LIST

All equipment calibrated  
within last 90 days

### ADAPTER

HP X281 (Coaxial waveguide); HP S281; HP 85659 (Quasi peak)

### AMPLIFIER

Pre-amp. HP 10885A (2-1300 MHz); HP 8447D, HP 8447E, HP 8449A

### ANTENNA See end

### ATTENUATOR

Ray 432D; Power, Sierra 661A-30; Narda 76610; Narda 4779-3, -6, -10 dB

### AUDIO OSCILLATOR

HP 204D; AIEC DFC-1; Motorola S-1333B; HP 3312A; HP 8903A

### BATTERY

Sears Roebuck, Stock #4341

### CAMERA

Oscilloscope, Tektronix CSA; Polaroid Impulse AF; Kodak DC-50

### CAPACITOR

Feed-Thru, 10  $\mu$ F, Solar 6512-106R; Solar 7525-1

### CLOSE FIELD PROBE

HP 11940A, 11941A, HP 11945A

### COMPUTER

HP 332; HP Vectra 486/25VL; Various PC Compatibles

### CONVERTOR, Down

HP 117 10B

### COUPLER

Narda 1080, Waveguide; HP S750E (Cross guide); Waveline 274/40; Solar 7415-3; Solar 7835-891 & -896

### CURRENT PROBE

Solar 6741-1

### DETECTOR

HP 8470B

### DIGITAL MULTIMETER

HP 3476A w/H.F. Probe; Fluke 8030A-01; HP 3478A

### DISTORTION ANALYZER

HP 334A; HP 8903A

### ELECTRONIC COUNTER

HP 5383A; HP 5334B

### FILTER

Circuit FHT/7-50-57/50-1A/1B (HP); Jerrold TLB-1; TrB-1, Piezo 5064; Eagle NF-I Series, Kron-Hite 3202; Phelos-Dodge #PD-495-8; Newton #PC6000 Line Protector; 870-890 MHz (Lab Design); 900 MHz (Lab Design); Solar High-Pass s/n 882029

### FREQ. DEV. METER

HP 8901A

### FREQ. DOUBLER

HP 11721A

### FREQUENCY METER

HP 537A; HP 536A

### GENERATOR

Solar 6550-1 (power sweep); HP 8640B, GAW 1012, HP 8656A (signal); Solar 8282-1 (spike)

### HUMIDITY CHAMBER

Ember Co FW30; Bowser 0

### LIMITER, R.F.

HP 11867A; HP 11693A; HP 10509A

### LISN

Singer 91221-1; Ailtech 94641-1 (50 $\mu$ H)

### LOAD, POWER

Telewave TLW-25; Bird 8329

### MILLIAMETER

HP 428B

### MIXER

HP 10514A; Mini-Circuits TAK-1H

### OPEN FIELD SITE

As filed with FCC & IC and kept up-dated.  
TURNTABLES:  
Up to 2000# capacity  
GROUND SCREEN:  
Complies with docket 80-284  
ANTENNA MAST:  
Complies as above

### OSCILLOSCOPE

HP 1741A; HP 181T; Tektronix T935; HP 54502A

### PHANTOM

M.F.A. Labs Left and Right human head

### PLOTTER

HP 7470; HP7475A

### POWER METER

AF GR 1840A; HP 435A with 8481A & 8482H Power Sensors; HP 436A; HP 8901A

### POWER SUPPLY

HP 6226A; Heatkit 1P 2711; 1P 3020; Honda EM400 (portable gas gen.); HP 6012

### PRINTER

Brother HL-8; Brother HL-10V; HP DeskJet E40C

### R. F. PRESELECTION

HP 85685A

### RADIATION METER

Narda 8717 w/8010 Amp, 8021B and 8760 probes

### RESISTOR, PRECISION

Solar 7144-1.0, 7144-10.0; Solar 8525-1

### SCALE

weigh-Tronix 3632T-50

### SCANNER

HP 9190A Scanjet

### SCREEN ROOM

Lindgren 22-2/2-0

### SIGNAL LEVEL METER

Jerrold 704B

### SIGNAL SAMPLER

R. F. Bird 4273-030, 4275-030

### SINAD/VOLTMETER

Helper Sinadder

### SPECTRUM ANALYZER

HP 8558B, 8557; HP 8563E; HP 853A; HP 8566B/8568B

### TEMPERATURE CHAMBER

Tenney, Jr

### TEMPERATURE PROBE

Fluke 80T-150C

### TERMINATION

Narda 320B Waveguide, Waveline #281

### TEST SET

Semi-Automatic: HP 8953A; HP 8954A Interface; Computer / Controller; P.S. Programmer; HP 59501A; RF Communications: HP 8920A

### TRANSFORMERS

Audio Isolation: Solar 6220-1A; Impedance: HP 11694A; Isolation: Solar 7032-1; Matching: Solar 7033-1

### TRANSMISSION & NOISE MEASURING SET

HP 3555B

### VIBRATION CHAMBER

Linnoltz-Dickie T 500; Linnoltz-Dickie T 4000

### VOLTMETER

HP 410C; HP 3478A

### WATTMETER

Bird 43, Sierra 174A-2

### ANTENNAS

#### 30 - 50 Hz

Emco 7603 M-Field; Emco 7604 M-Field

#### 20 - 200 MHz

Apriel Biconical Model AAB20200

#### 20 - 300 MHz

Emco Biconical H-Field

#### 25 - 1000 MHz

Singer DM-105A; EMC0 3121C

#### 200 - 1000 MHz

Apriel Log Periodic, Model AALP 2001

#### 10 kHz - 30 MHz

Emco 3107B, E-Field; Emco 3101B/1, Rod E-Field

#### 10 kHz - 32 MHz

Singer 94593-1 (Loop)

#### 150 kHz - 32 MHz

Singer 92197-1 (41")

#### 150 kHz - 32 MHz

Singer 93049-1 (9')

#### 1 - 10 GHz

Singer 90794-A Discone

#### 1 - 18 GHz

Horn; Apriel Model AAH-118

#### 18 - 40 GHz

Emco 3116, Horn

#### 40 - 60 GHz

Horn; HP 11970U, HP 11971U,

HP 11975A (Lo Drive

Amplifier)

#### 50 - 75 GHz

Mixer, HP 11970V, HP 11971V

#### 75 - 110 GHz

Mixer, HP 11970W