

RF Test Report

Test in accordance with
Federal Communications Commission(FCC)
CFR TITLE 47, Parts 2, 22, 24,27
&
Industry Canada (IC), RSS-GEN, 132,133,139

Product Name : ELS61-US
Model No. : ELS61-US
FCC ID: QIPELS61-US
IC ID: 7830A-ELS61US

Applicant : Gemalto M2M GmbH
Address : Siemensdamm 50, 13629 Berlin, Germany

Date of Receipt : 11-02-2015
Test Date : 11-04-2015~11-06-2015
Issued Date : 01-21-2016
Report No. : UL05420151102FCC/IC042-1
Report Version : V1.0

Notes:

The test results only relate to these samples which have been tested.
Partly using this report will not be admitted unless been allowed by Unilab.
Unilab is only responsible for the complete report with the reported stamp of Unilab.

Test Report Certification

Issued Date : 01-21-201611-10-2015
Report No. : UL05420151102FCC/IC042-1

Product Name : ELS61-US
Applicant : Gemalto M2M GmbH
Address : Siemensdamm 50, 13629 Berlin, Germany
Manufacturer : Gemalto M2M GmbH
Address : Siemensdamm 50, 13629 Berlin, Germany
Model No. : ELS61-US
EUT Voltage : MIN: 3.0V, NOR: 3.8V, MAX: 4.5V
Brand Name : GEMALTO
FCC ID: QIPELS61-US
IC ID: 7830A-ELS61US
Applicable Standard : ANSI/TIA-603-D-2010; FCC KDB 971168 D01 Power Meas License Digital Systems v02r02; FCC CFR Title 47 Part 2; FCC CFR Title 47 Part 22 Subpart H; FCC CFR Title 47 Part 24 Subpart E; FCC CFR Title 47 Part 27 Subpart C; RSS 132 Issue 3; RSS 133 Issue 6; RSS 139 Issue 3; RSS-GEN Issue 4; ANSI C63.4-2014
Test Result : Complied
Performed Location : Unilab (Shanghai) Co., Ltd.
FCC 2.948 register number is 714465
IC register number is 11025A-1
No. 1350, Lianxi Rd. Pudong New District, Shanghai, China
TEL: +86-21-50275125 FAX: +86-21-50277862

Prepared by : Wayne Wu
(Technical Engineer: Wayne Wu)

Reviewed by : Forest Cao
(Senior Engineer: Forest Cao)

Approved by : Eva Wang
(Supervisor Engineer: Eva Wang)

TABLE OF CONTENTS

SUMMARY OF TEST RESULT	6
1. General Information	7
1.1. EUT Description	7
1.2. Mode of Operation	8
1.3. Tested System Details	9
1.4. Configuration of Tested System.....	10
1.5. EUT Exercise Software	10
2. Technical Test.....	11
2.1. Test Environment	11
3. Peak Output Power	12
3.1. Test Equipment.....	12
3.2. Test Setup.....	12
3.3. Limit.....	13
3.4. Test Procedure	14
3.5. Uncertainty	14
3.6. Test Result	15
4. Occupied Bandwidth	17
4.1. Test Equipment.....	17
4.2. Test Setup	17
4.3. Limit.....	17
4.4. Test Procedure	17
4.5. Uncertainty	17
4.6. Test Result	18
5.Spurious Emission At Antenna Terminals (+/- 1MHz)	24
5.1. Test Equipment.....	24
5.2. Test Setup	24
5.3. Limit.....	24
5.4. Test Procedure	25
5.5. Uncertainty	25
5.6. Test Result	26
6.Spurious Emission.....	29
6.1. Test Equipment.....	29
6.2. Test Setup	30
6.3. Limit.....	31
6.4. Test Procedure	31
6.5. Uncertainty	32
6.6. Test Result	33
7. Frequency Stability Under Temperature & Voltage Variations.....	41
7.1. Test Equipment.....	41
7.2. Test Setup	41
7.3. Limit.....	41
7.4. Test Procedure	42
7.5. Uncertainty	42
7.6. Test Result	43
8. Peak to Average	46
8.1. Test Equipment.....	46
8.2. Test Setup	46
8.3. Limit.....	46
8.4. Test Procedure	46
8.5. Uncertainty	47
8.6. Test Result	47
9.Receiver Spurious Emission for RSS 132/133	49

9.1. Test Equipment.....	49
9.2. Test Setup	49
9.3. Limit.....	50
9.4. Test Procedure	50
9.5. Uncertainty	50
9.6. Test Result	51
10.Attachment	63

SUMMARY OF TEST RESULT

Report Section	SPECIFICATION		Description	Limit	Result
	FCC CFR 47	IC			
3	part 2.1046	RSS GEN 6.12	Conducted Output Power	N/A	PASS
3	part 22.913(a)(2) part 24.232(c) part 27.50(d)(4) part 27.50(c)(10)	RSS-132, 5.4 RSS-133, 6.4	Effective Radiated Power Equivalent Isotropic Radiated Power	<7 Watts <2 Watts	PASS
4	part 2.1049 part 22.917(a) part 24.238(a) part 27.53 (g)(h)	RSS-GEN, 6.6 RSS-132, 5.2 RSS-133, 6.2 RSS-139, 6.2	Occupied Bandwidth	N/A	PASS
5	part 2.1051 part 22.917(a) part 24.238(a) part 27.53(g)(h)	RSS-132, 5.5 RSS-133, 6.5	Band Edge Measurement	<43+10lg(P[Watts])	PASS
6	part 2.1051 part 22.917(a) part 24.238(a) part 24.50(d) part 27.53 (g)(h)	RSS-132, 5.5 RSS-133, 6.5 RSS-139, 6.5	Conducted Spurious Emission	<43+10lg(P[Watts])	PASS
6	part 2.1053 part 22.917(a) part 24.238(a) part 27.53(g)(h)	RSS-132, 5.5 RSS-133, 6.5 RSS-139, 6.5	Field Strength of Spurious Radiation	<43+10lg(P[Watts])	PASS
7	part 2.1055 part 22.355 part 24.235 part 27.54	RSS GEN 6.11 RSS-132, 5.3 RSS-133, 6.3 RSS-139, 6.3	Frequency Stability for Temperature & Voltage	<2.5 ppm	PASS
8	part 24.232(d) part 27.50(d)(5)	RSS 133,6.4 RSS 132,5.4	Peak-to-Average	<13dB	PASS
9	/	RSS-132,5.6 RSS-133,6.6	Receiver Spurious Emission	30~88MHz: <40 dBμV/m 88~216MHz: <43.5 dBμV/m 216~960MHz: <46 dBμV/m Above 960MHz: <54 dBμV/m	PASS

1.General Information

1.1. EUT Description

Product Name:	ELS61-US
Model Name:	ELS61-US
Hardware Version:	00.301
Software Version:	B2
RF Exposure Environment:	Uncontrolled
WCDMA	
Support Band:	WCDMA Band II
Tx Frequency Range:	WCDMA Band II: 1850MHz ~1910MHz
Rx Frequency Range:	WCDMA Band II: 1930MHz ~1990MHz
Type of modulation:	WCDMA(UMTS): QPSK
Antenna Type:	Connector
Antenna Peak Gain:	WCDMA Band II: 2.15dBi
Support Band:	WCDMA Band V
Tx Frequency Range:	WCDMA Band V: 824MHz ~849MHz
Rx Frequency Range:	WCDMA Band V: 869MHz ~894MHz
Type of modulation:	WCDMA(UMTS): QPSK
Antenna Type:	Connector
Antenna Peak Gain:	WCDMA Band V: 2.15dBi
Support Band:	WCDMA Band IV
Tx Frequency Range:	WCDMA Band IV: 1710MHz~1755MHz
Rx Frequency Range:	WCDMA Band IV: 2110MHz~2155MHz
Type of modulation:	WCDMA(UMTS): QPSK
Antenna Type:	Connector
Antenna Peak Gain:	WCDMA Band IV: 2.15dBi

1.2. Mode of Operation

Unilab has verified the construction and function in typical operation. EUT is in link mode with base station emulator at maximum power level. All the test modes were carried out with the EUT in normal operation, which was shown in this test report is the worst test mode and defined as:

Test Mode		
Band	Radiated TCs	Conducted TCs
WCDMA Band V	RMC 12.2Kbps Link	RMC 12.2Kbps Link
WCDMA Band II	RMC 12.2Kbps Link	RMC 12.2Kbps Link
WCDMA Band IV	RMC 12.2Kbps Link	RMC 12.2Kbps Link

Note:

1. Regards to the frequency band operation: the lowest, middle and highest frequency of channel were selected to perform the test, then shown on this report.
2. The maximum power levels are RMC 12.2Kbps mode for WCDMA Band V and RMC 12.2Kbps mode for WCDMA Band II, only these modes were used for all tests.
3. For the ERP/EIRP and radiated emission test, every axis (X, Y, Z) was verified, and show the worst (Z axis) result in this report.

The conducted power table is as follows:

Conducted Power									
Band	WCDMA V			WCDMA II			WCDMA IV		
TX Channel	4132	4182	4233	9262	9400	9538	1312	1413	1513
RX Channel	4357	4407	4458	9662	9800	9938	1537	1638	1738
Frequency (MHz)	826.4	836.4	846.6	1852.4	1880	1907.6	1712.4	1732.6	1752.6
RMC 12.2Kbps	23.35	23.37	23.32	22.81	22.85	22.73	23.01	23.03	22.85
AMC 12.2Kbps	22.58	23.01	22.96	22.52	22.39	22.66	22.81	23.01	22.82
HSDPA Subtest-1	22.55	23.01	22.99	22.67	22.47	22.59	23.00	22.99	22.66
HSDPA Subtest-2	22.66	23.00	22.87	22.51	22.19	22.57	22.88	22.97	22.67
HSDPA Subtest-3	22.87	22.52	22.75	22.57	22.56	22.57	22.88	22.76	22.63
HSDPA Subtest-4	22.63	22.48	22.73	22.36	22.59	22.56	22.51	22.75	22.56

HSUPA Subtest-1	22.64	22.46	22.71	22.44	22.51	22.19	22.76	22.68	22.51
HSUPA Subtest-2	22.82	22.74	22.67	22.19	22.58	22.40	22.52	22.66	22.52
HSUPA Subtest-3	22.88	22.84	22.57	22.43	22.67	22.30	22.38	22.52	22.47
HSUPA Subtest-4	22.67	22.83	22.59	22.17	22.46	22.29	22.18	22.27	22.49

1.3. Tested System Details

The types for all equipments, plus descriptions of all cables used in the tested system (including inserted cards) are:

Product	Manufacturer	Model	Serial No.	Power Cord
Radio Communication Tester	R&S	CMW500	147483	N/A

1.4. Configuration of Tested System

Connection Diagram

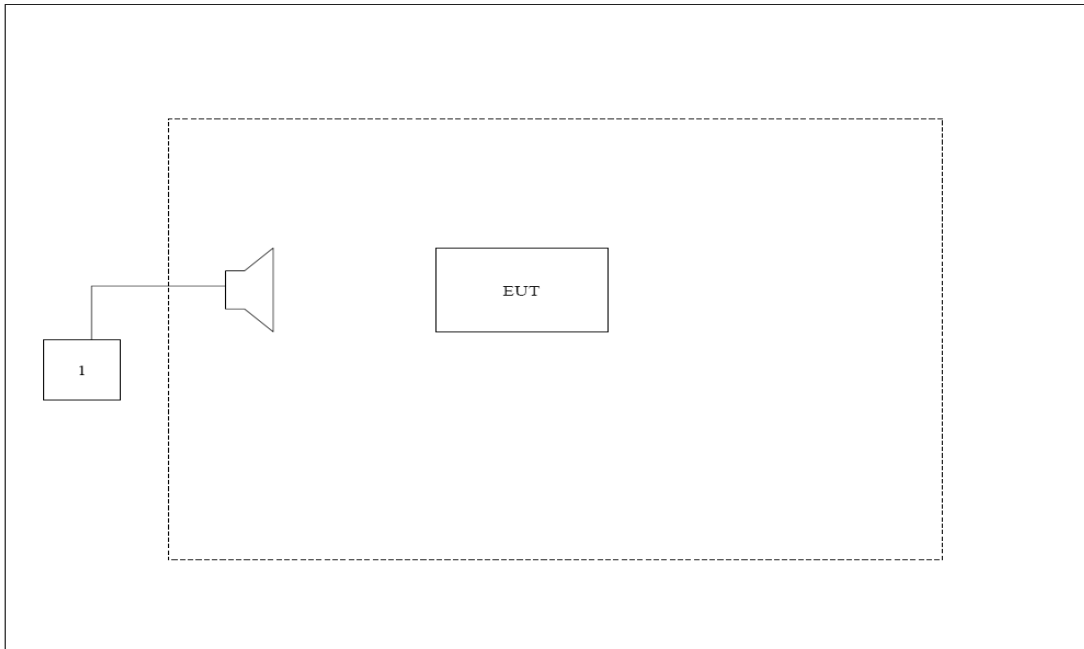

1.5. EUT Exercise Software

1	Setup the EUT and simulators as shown on above.
2	Turn on the power of all equipment.
3	EUT Communicate with CMW500, then select channel to test.

2. Technical Test

2.1. Test Environment

Items	Required (IEC 68-1)	Actual
Temperature (°C)	15-35	22
Humidity (%RH)	25-75	53
Barometric pressure (mbar)	860-1060	950-1000

3. Peak Output Power

3.1. Test Equipment

Instrument	Manufacturer	Model	Serial No.	Cali. Due Date
Spectrum Analyzer	Agilent	N9038A	MY51210142	11/05/2016
Radio Communication Tester	R&S	CMW500	147483	11/08/2016
Signal Generator	Agilent	N5183A	MY50140938	01/04/2016
Preamplifier	CEM	EM30180	3008A0245	02/27/2016
DC Power Supply	Agilent	6612C	MY43002989	03/02/2016
Bilog Antenna	Schwarzbeck	VULB9160	9160-3316	09/19/2016
VHF-UHF-Biconical Antenna	Schwarzbeck	VUBA9117	9117-263	09/19/2016
Broad-Band Horn Antenna	Schwarzbeck	BBHA9120D	9120D-942	09/19/2016
Broad-Band Horn Antenna	Schwarzbeck	BBHA9120D	9120D-943	09/19/2016

The measure equipment had been calibrated once a year.

3.2. Test Setup

Conducted Power Measurement:

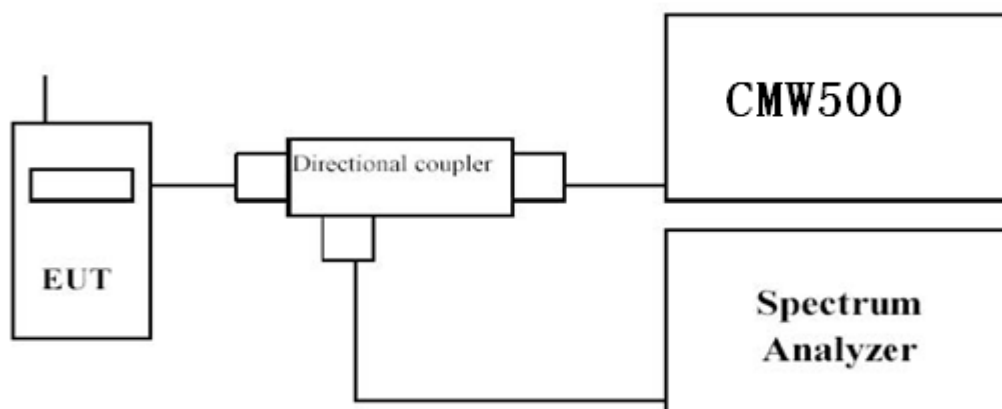

Radiated Spurious Measurement: below 1GHz

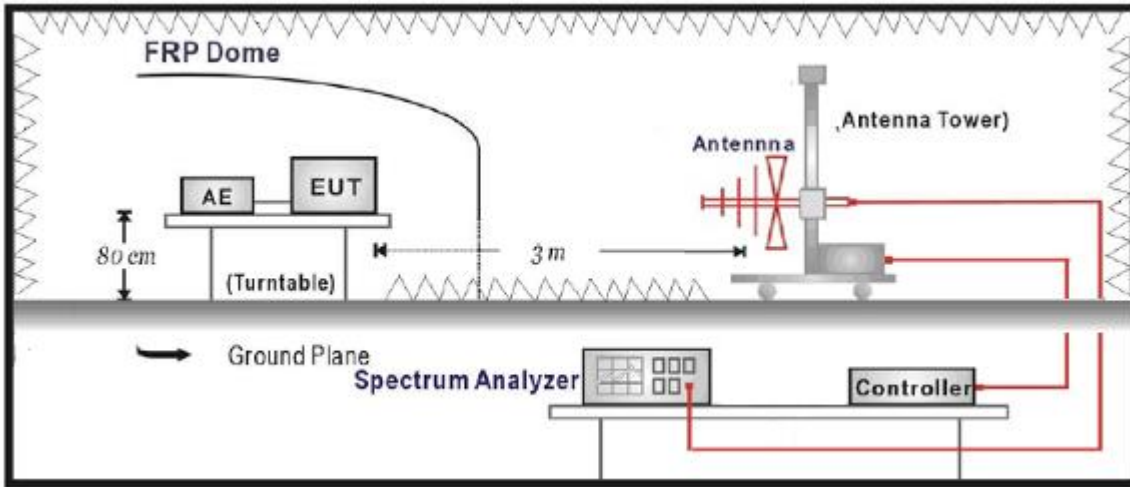

Radiated Spurious Measurement: above 1GHz

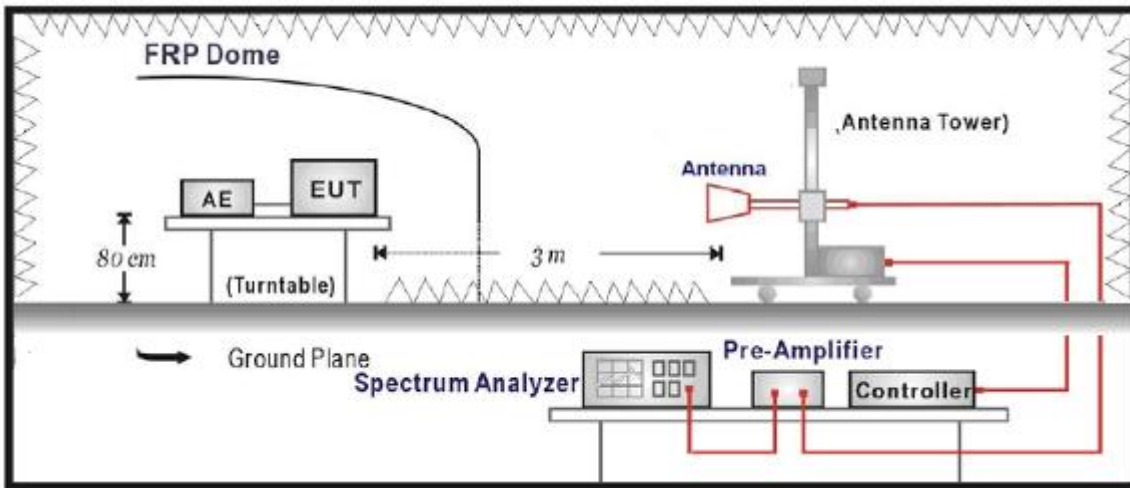

3.3. Limit

For FCC Part 22.913(a)(2):

The ERP of mobile transmitters and auxiliary test transmitters must not exceed 7 Watts.

For FCC Part 24.232(c):

The EIRP of mobile transmitters and auxiliary test transmitters must not exceed 2 Watts.

3.4. Test Procedure

Conducted Power Measurement:

- a. Place the EUT on a bench and set it in transmitting mode.
- b. Connect a low loss RF cable from the antenna port to a spectrum analyzer and CMW500 by a Directional Couple.
- c. EUT Communicate with CMW500, then selects a channel for testing.
- d. Add a correction factor to the display of spectrum, and then test.

Radiated Power Measurement:

- a. The EUT shall be placed at the specified height on a support, and in the position closest to normal use as declared by provider.
- b. The test antenna shall be oriented initially for vertical polarization and shall be chosen to correspond to the frequency of the transmitter
- c. The output of the test antenna shall be connected to the measuring receiver.
- d. The transmitter shall be switched on and the measuring receiver shall be tuned to the frequency of the transmitter under test.
- e. The test antenna shall be raised and lowered through the specified range of height until a maximum signal level is detected by the measuring receiver.
- f. The transmitter shall then be rotated through 360° in the horizontal plane, until the maximum signal level is detected by the measuring receiver.
- g. The test antenna shall be raised and lowered again through the specified range of height until a maximum signal level is detected by the measuring receiver.
- h. The maximum signal level detected by the measuring receiver shall be noted.
- i. The transmitter shall be replaced by a substitution antenna.
- j. The substitution antenna shall be orientated for vertical polarization and the length of the substitution antenna shall be adjusted to correspond to the frequency of the transmitter.
- k. The substitution antenna shall be connected to a calibrated signal generator.
- l. If necessary, the input attenuator setting of the measuring receiver shall be adjusted in order to increase the sensitivity of the measuring receiver.
- m. The test antenna shall be raised and lowered through the specified range of height to ensure that the maximum signal is received.
- n. The input signal to the substitution antenna shall be adjusted to the level that produces a level detected by the measuring receiver, that is equal to the level noted while the transmitter radiated power was measured, corrected for the change of input attenuator setting of the measuring receiver.
- o. The measurement shall be repeated with the test antenna and the substitution antenna orientated for horizontal polarization.
- p. The measure of the effective radiated power is the larger of the two levels recorded at the input to the substitution antenna, corrected for gain of the substitution antenna if necessary.
- q. Test site anechoic chamber refer to ANSI C63.4: 2014.

3.5. Uncertainty

The measurement uncertainty is defined as for Conducted Power Measurement ± 1.1 dB,
for Radiated Power Measurement ± 3.1 dB

3.6. Test Result

The following table shows the conducted power measured:

Table 1

WCDMA				
Modes	Channel	Frequency (MHz)	Conducted Power (dBm)	Conducted Power (W)
WCDMA Band V	4132(Low)	826.4	23.35	0.22
	4182(Mid)	836.4	23.37	0.22
	4233(High)	846.6	23.32	0.21
WCDMA Band II	9262(Low)	1852.4	22.81	0.19
	9400(Mid)	1880.0	22.85	0.19
	9538(High)	1907.6	22.73	0.19
WCDMA Band IV	1312(Low)	1712.4	23.01	0.20
	1413(Mid)	1732.6	23.03	0.20
	1513(High)	1752.6	22.85	0.19

The following table shows the Radiated power measured :
 WCDMA Band V

Frequency (MHz)	Ant. Pol. (H/V)	SG Reading (dBm)	Cable Loss (dB)	Gain (dBd)	ERP (dBm)	ERP (W)
Low Channel 4132(826.4MHz)						
826.4	H	30.67	3.83	-2.99	23.85	0.24
826.4	V	30.75	3.83	-2.99	23.93	0.25
Middle Channel 4182 (836.4MHz)						
836.4	H	30.41	3.96	-3.04	23.41	0.22
836.4	V	30.39	3.96	-3.04	23.39	0.22
High Channel 4233 (846.6MHz)						
846.6	H	30.57	3.97	-3.10	23.50	0.22
846.6	V	30.85	3.97	-3.10	23.78	0.24

WCDMA Band II

Frequency (MHz)	Ant. Pol. (H/V)	SG Reading (dBm)	Cable Loss (dB)	Gain (dBi)	EIRP (dBm)	EIRP (W)
Low Channel 9262(1852.40MHz)						
1850.2	H	19.54	6.26	10.40	23.68	0.23
1850.2	V	19.37	6.26	10.40	23.51	0.22
Middle Channel 9400 (1880.00MHz)						
1880.0	H	19.19	6.19	10.43	23.43	0.22
1880.0	V	19.14	6.19	10.43	23.38	0.22
High Channel 9538 (1907.60MHz)						
1909.8	H	19.24	6.15	10.44	23.53	0.23
1909.8	V	19.09	6.15	10.44	23.18	0.21

WCDMA Band IV

Frequency (MHz)	Ant. Pol. (H/V)	SG Reading (dBm)	Cable Loss (dB)	Gain (dBi)	EIRP (dBm)	EIRP (W)
Low Channel 1312(1712.40MHz)						
1712.4	H	20.35	6.12	9.40	23.63	0.23
1712.4	V	20.15	6.12	9.40	23.43	0.22
Middle Channel 1413 (1732.60MHz)						
1732.6	H	19.96	6.19	9.44	23.21	0.22
1732.6	V	19.97	6.19	9.44	23.22	0.22
High Channel 1513 (1752.60MHz)						
1752.6	H	20.18	6.21	9.48	23.45	0.23
1752.6	V	19.89	6.21	9.48	23.16	0.21

4. Occupied Bandwidth

4.1. Test Equipment

Occupied Bandwidth

Instrument	Manufacturer	Model	Serial No	Cal. Date
Radio Communication Tester	R&S	CMW500	147483	11/08/2016
Spectrum Analyzer	Agilent	N9038A	MY51210142	11/05/2016
DC Power Supply	Agilent	6612C	MY43002989	03/02/2016

The measure equipment had been calibrated once a year.

4.2. Test Setup

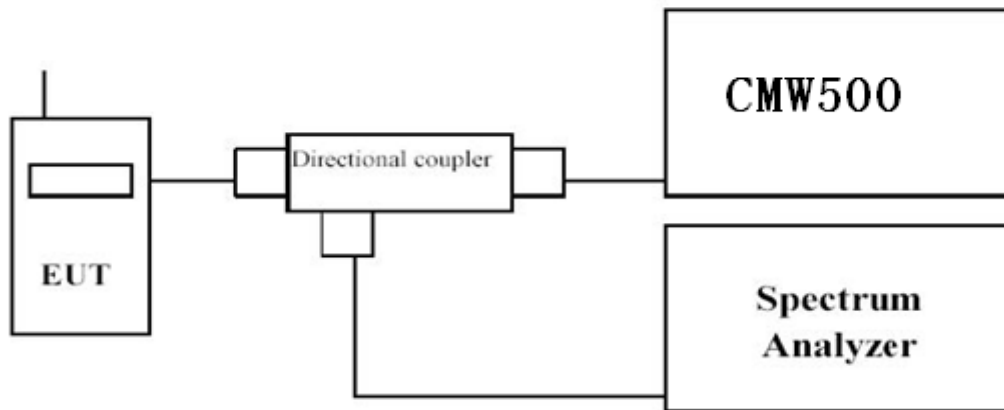

4.3. Limit

N/A

4.4. Test Procedure

1. The testing follows FCC KDB 971168 v02v02 Section 4.2;
2. Using Occupied Bandwidth measurement function of spectrum analyzer. In the Occupied Bandwidth measurement a resolution bandwidth of at least one percent of the emission bandwidth of the fundamental emission of the transmitter may be employed.

4.5. Uncertainty

The measurement uncertainty is defined as ± 10 Hz

4.6. Test Result

WCDMA Band V

Channel No.	Frequency (MHz)	-26dB Occupied Bandwidth (MHz)	99% Occupied Bandwidth (MHz)
4132	826.40	4.630	4.0686
4182	836.40	4.633	4.0666
4233	846.40	4.651	4.0668

WCDMA Band V, Channel 4132

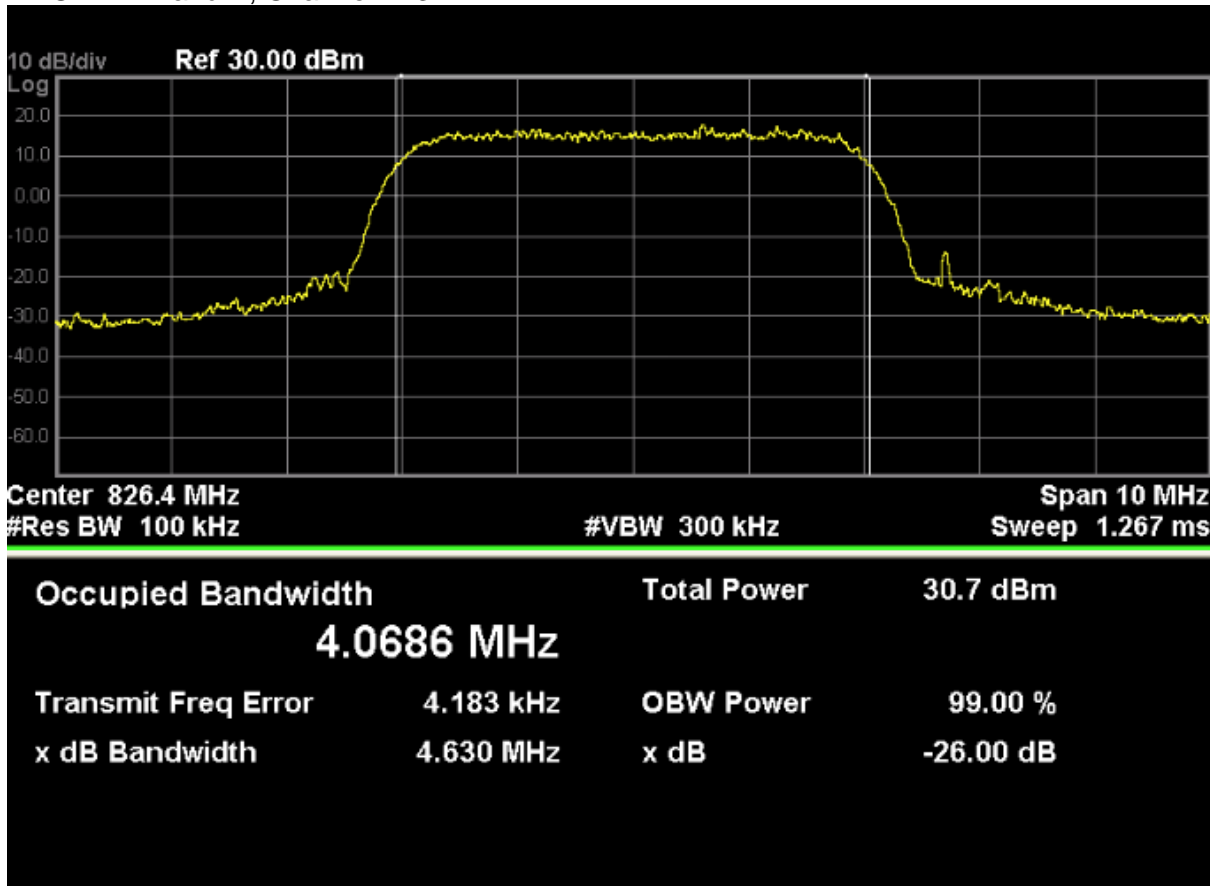

WCDMA Band V, Channel 4182

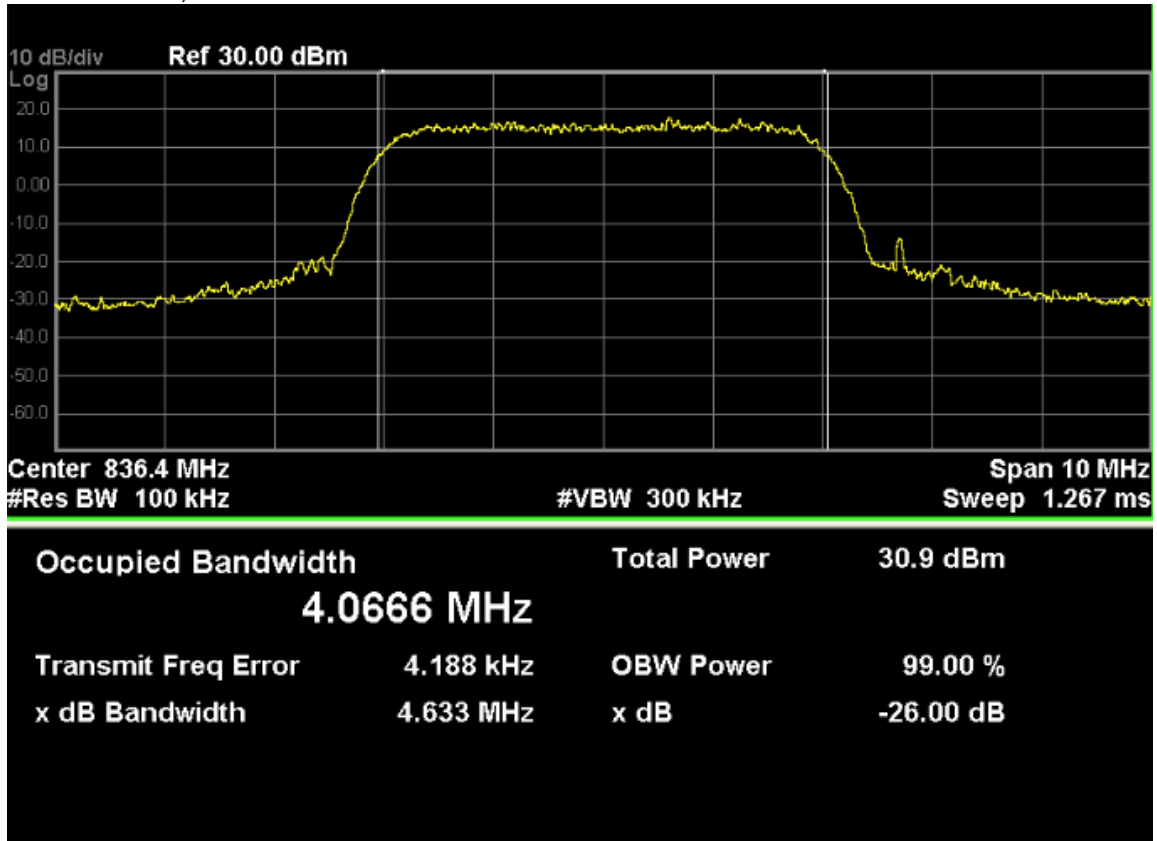

WCDMA Band V, Channel 4233

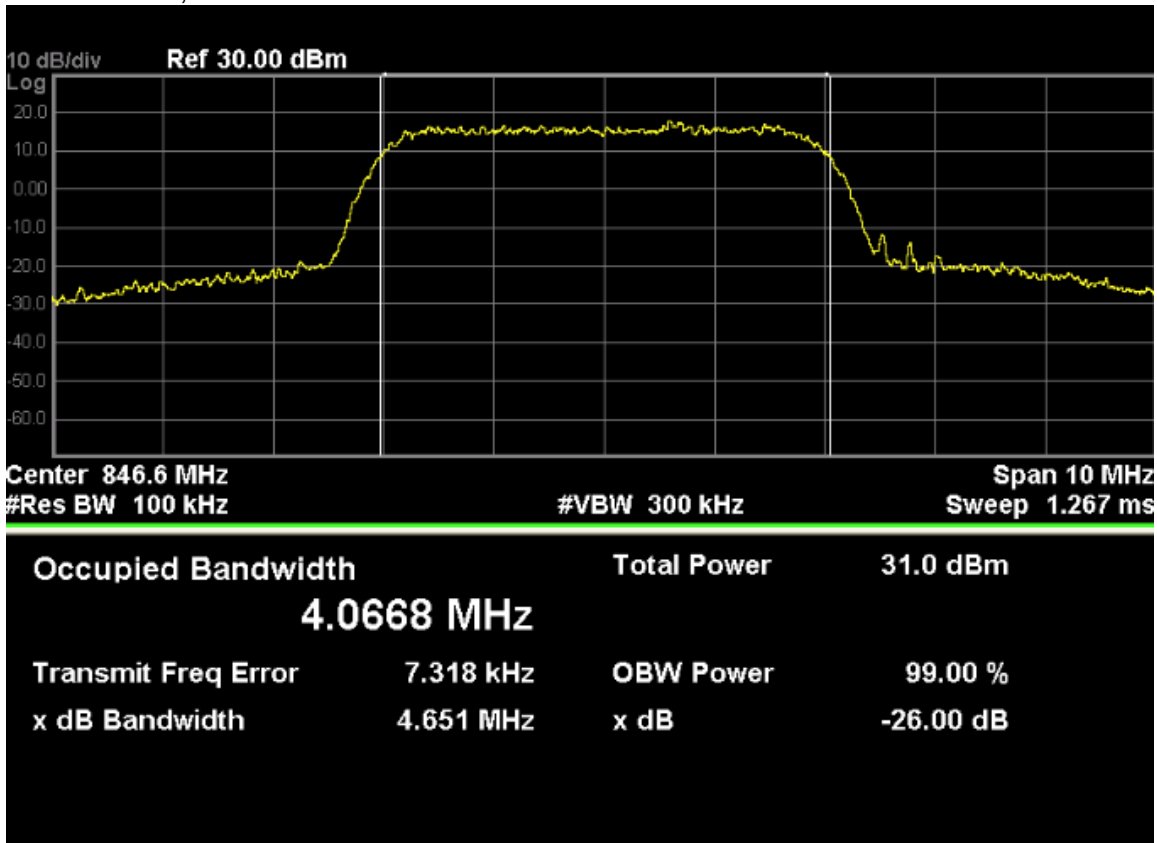

WCDMA Band II

Channel No.	Frequency (MHz)	-26dB Occupied Bandwidth (MHz)	99% Occupied Bandwidth (MHz)
9262	1852.4	4.646	4.0665
9400	1880.0	4.648	4.0765
9538	1907.6	4.651	4.0823

WCDMA Band II, Channel 9262

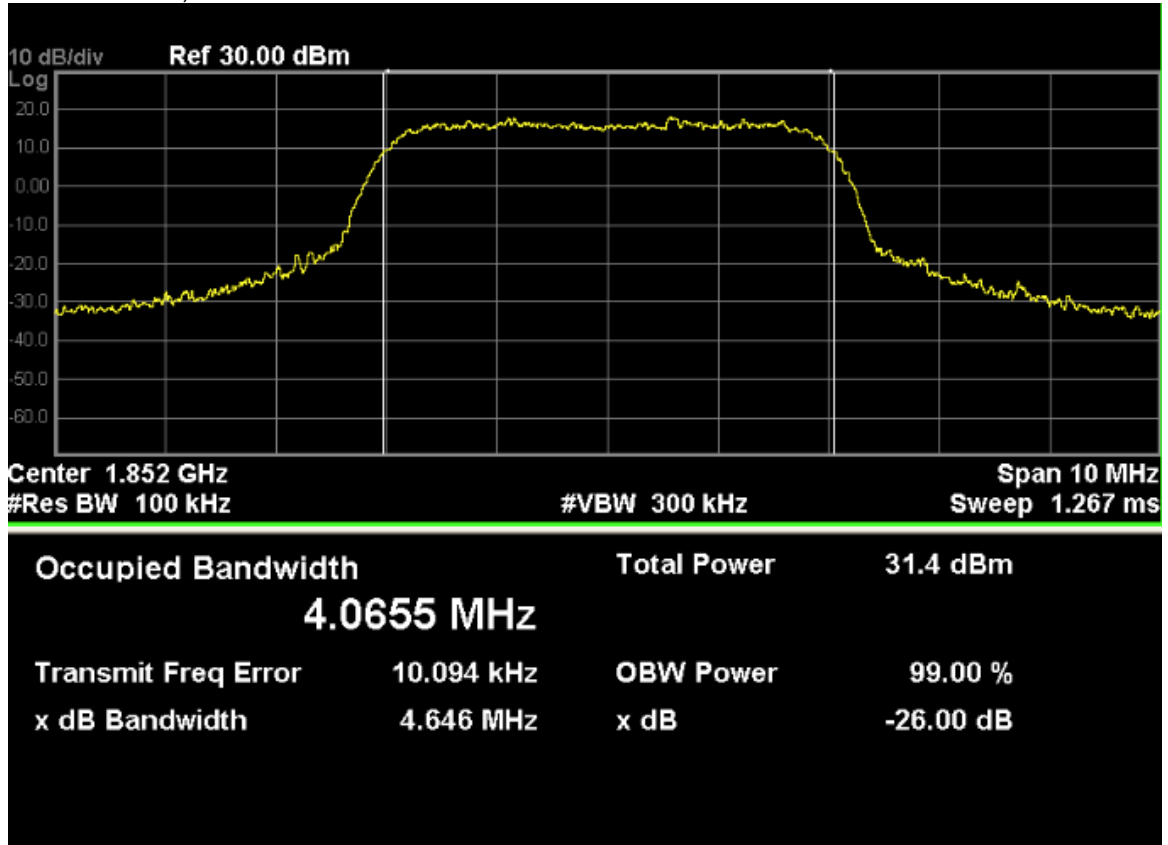

WCDMA Band II, Channel 9400

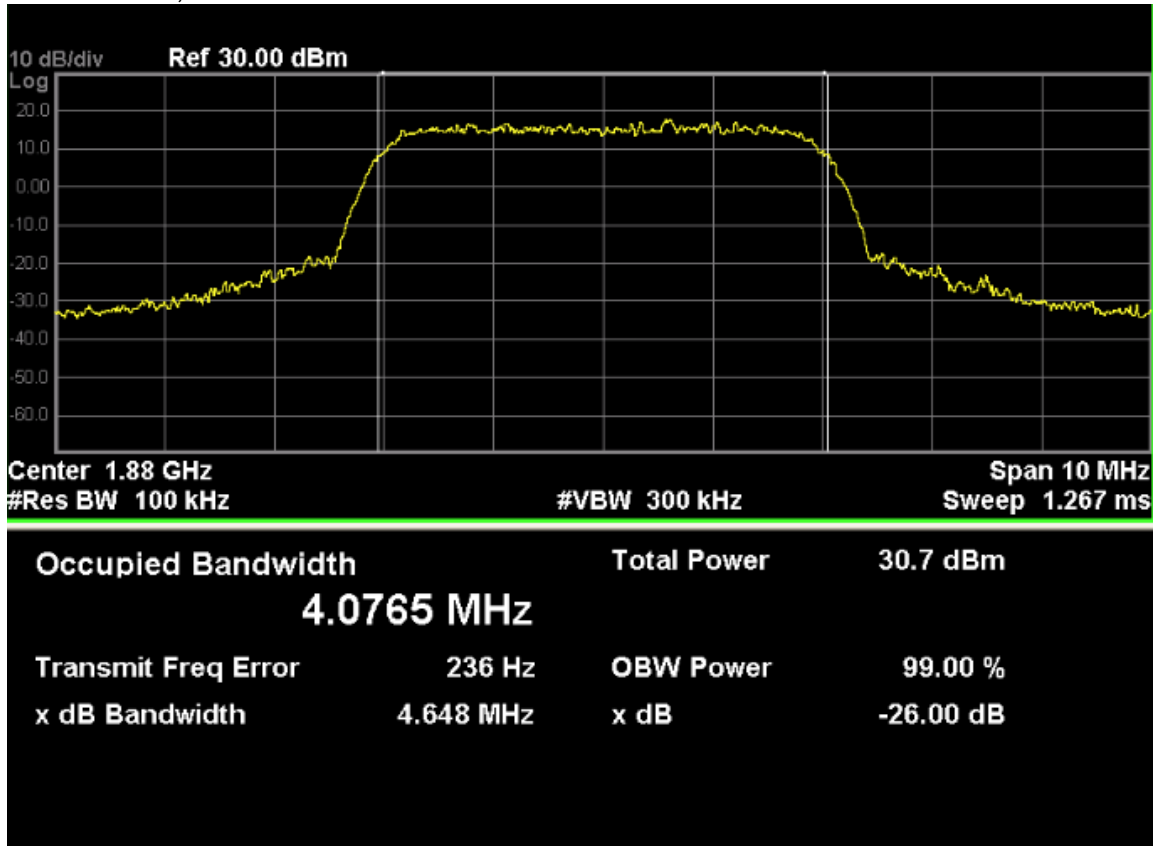

WCDMA Band II, Channel 9538

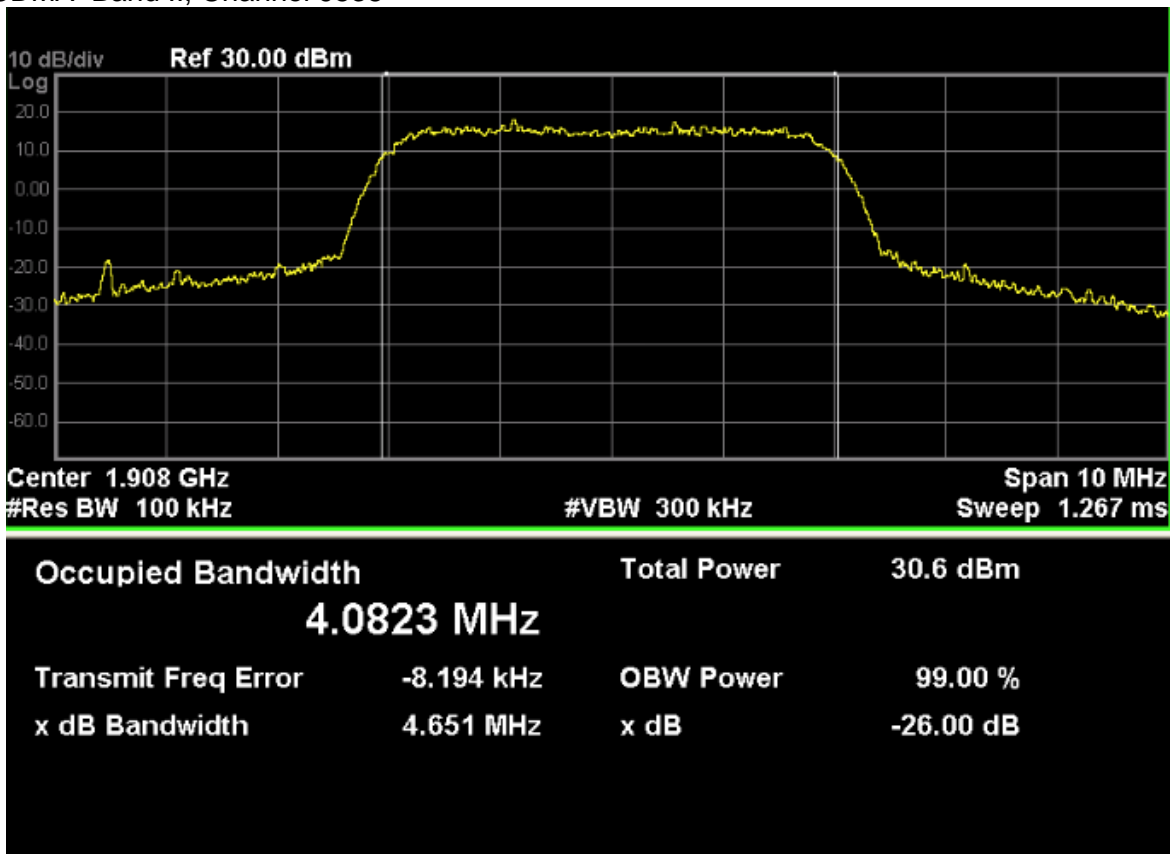

WCDMA Band IV

Channel No.	Frequency (MHz)	-26dB Occupied Bandwidth (MHz)	99% Occupied Bandwidth (MHz)
1312	1712.4	4.661	4.0915
1413	1732.6	4.645	4.0818
1513	1752.6	4.639	4.0794

WCDMA Band IV, Channel 1312

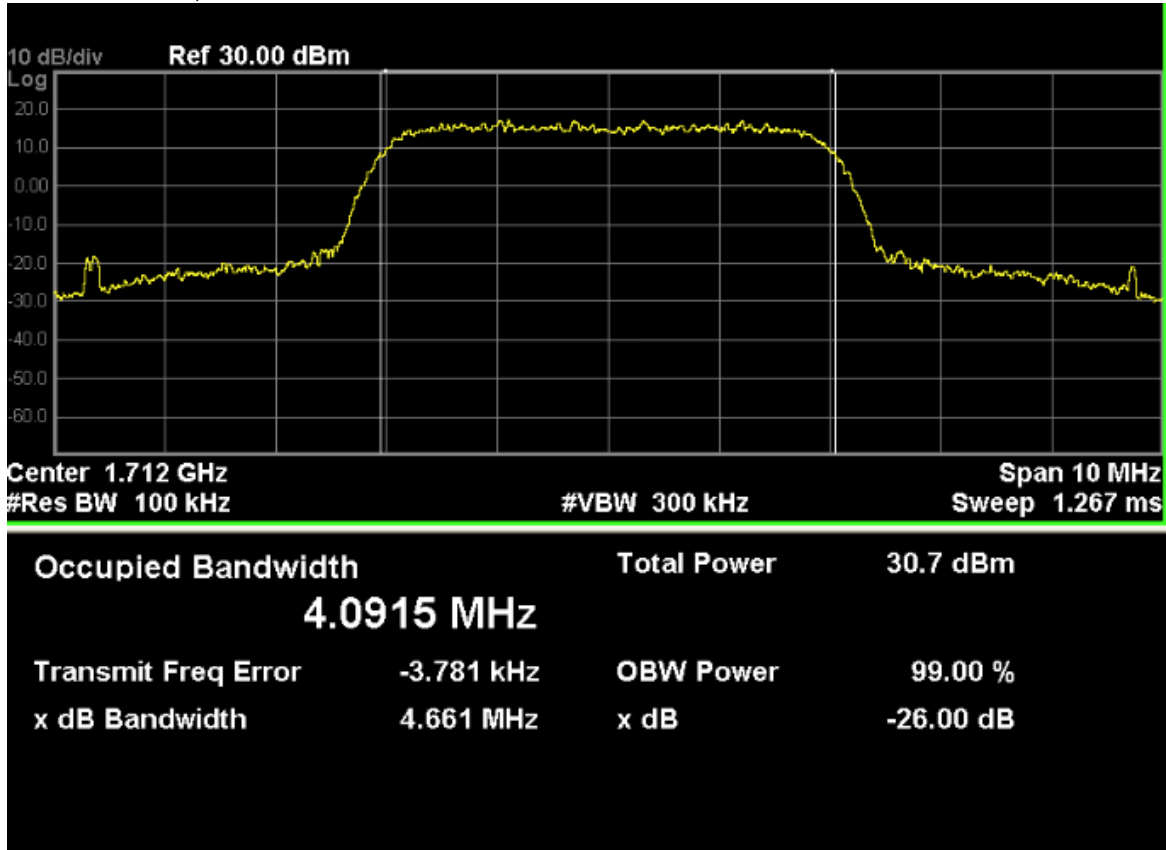

WCDMA Band IV, Channel 1413

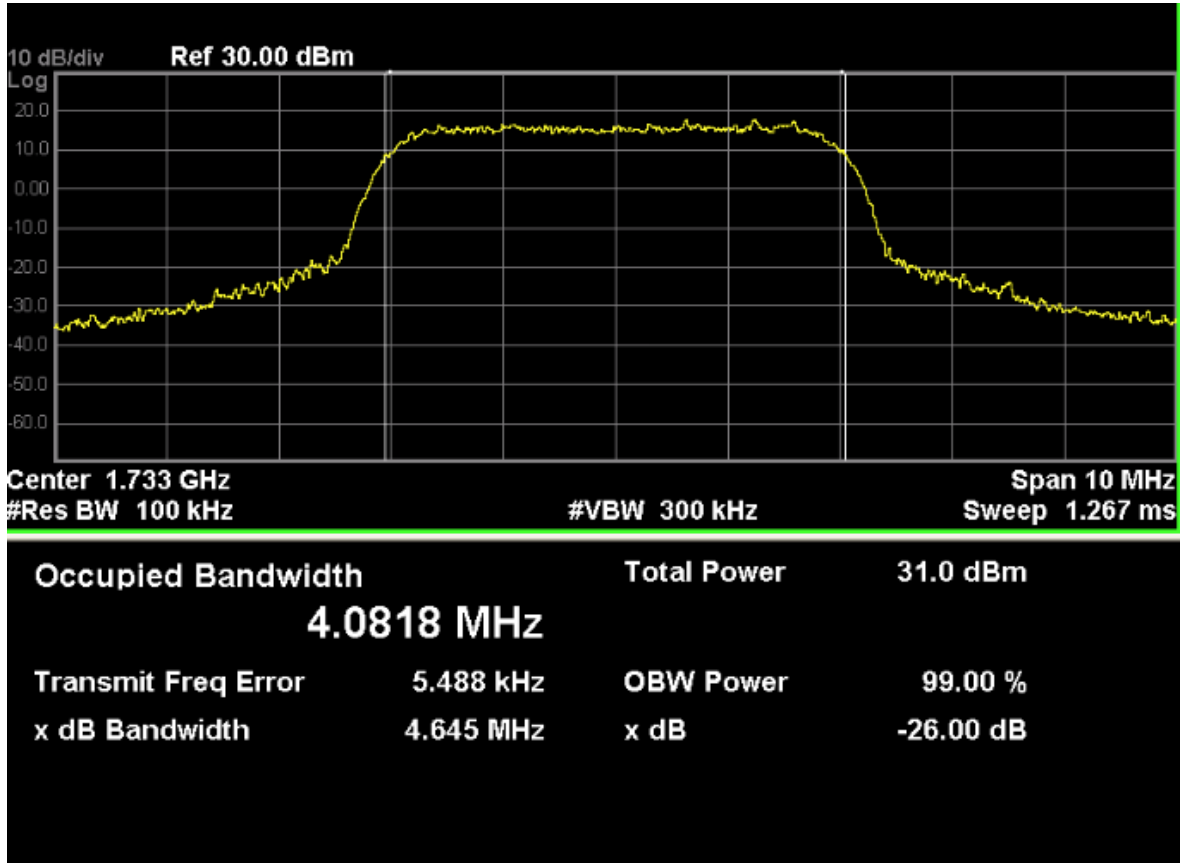

WCDMA Band IV, Channel 1513

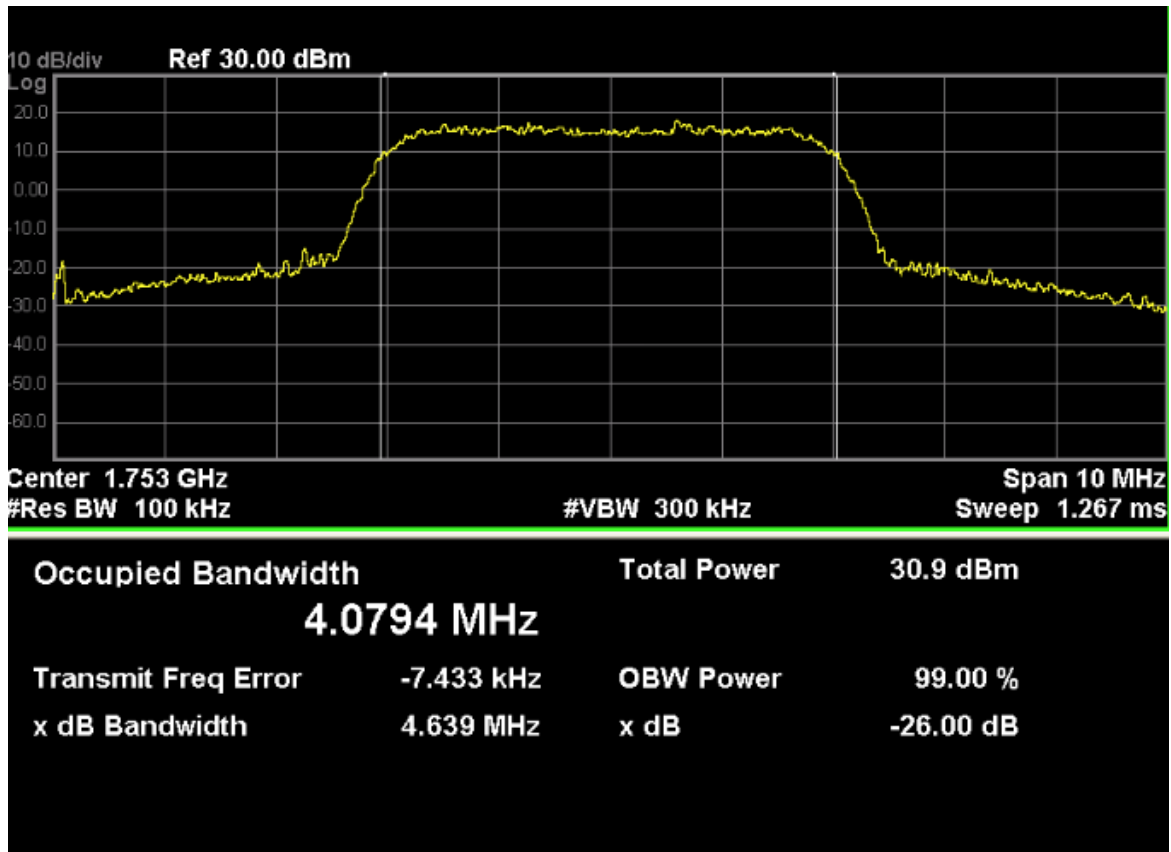

5. Spurious Emission At Antenna Terminals (+/- 1MHz)

5.1. Test Equipment

Instrument	Manufacturer	Model	Serial No	Cal. Date
Radio Communication Tester	R&S	CMW500	147483	11/08/2016
Spectrum Analyzer	Agilent	N9038A	MY51210142	11/05/2016
DC Power Supply	Agilent	6612C	MY43002989	03/02/2016

The measure equipment had been calibrated once a year.

5.2. Test Setup

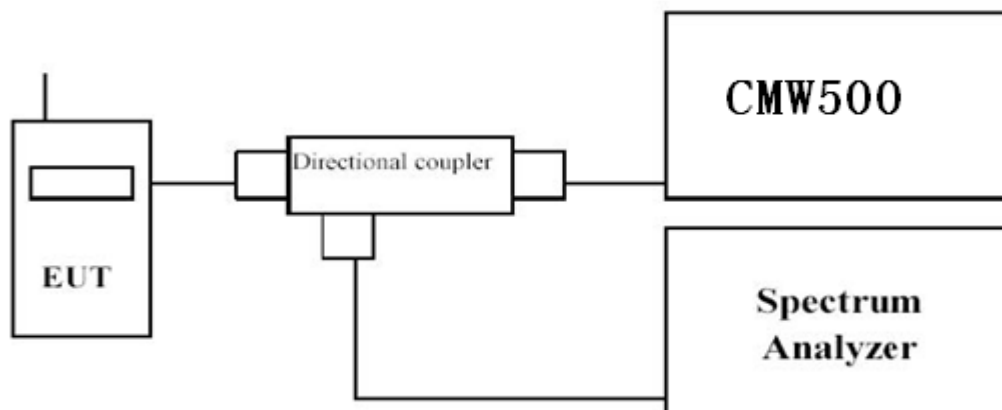

5.3. Limit

The power of any emission outside of the authorized operating frequency ranges must be attenuated below the transmitting power (P) by a factor of at least $43 + 10\log(P)$ dB.

5.4. Test Procedure

In the 1MHz bands immediately outside and adjacent to the frequency block a resolution bandwidth of at least one percent of the emission bandwidth of the fundamental emission of the transmitter may be employed to measure the out of band Emissions.

Procedure:

1. The testing follows FCC KDB 971168 v02v02 Section 6.0;
2. The EUT was connected to spectrum analyzer and the CMW500;
3. The band edges of low and high channels for the highest RF powers were measured. Set $RBW \geq 1\%OBW$ in the 1MHz band immediately outside and adjacent to the band edge.
4. Set spectrum analyzer with RMS detector.

5.5. Uncertainty

The measurement uncertainty is defined as ± 1.2 dB.

5.6. Test Result

WCDMA Band V, Channel 4132

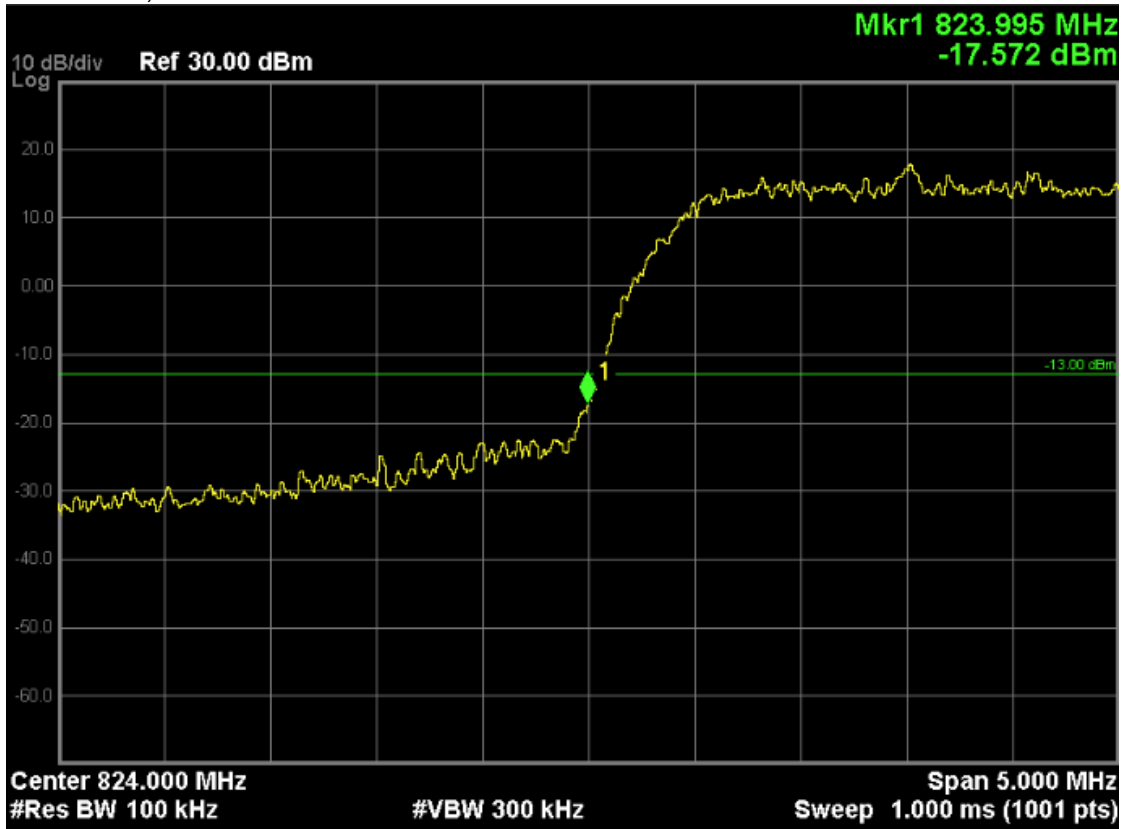

WCDMA Band V, Channel 4233

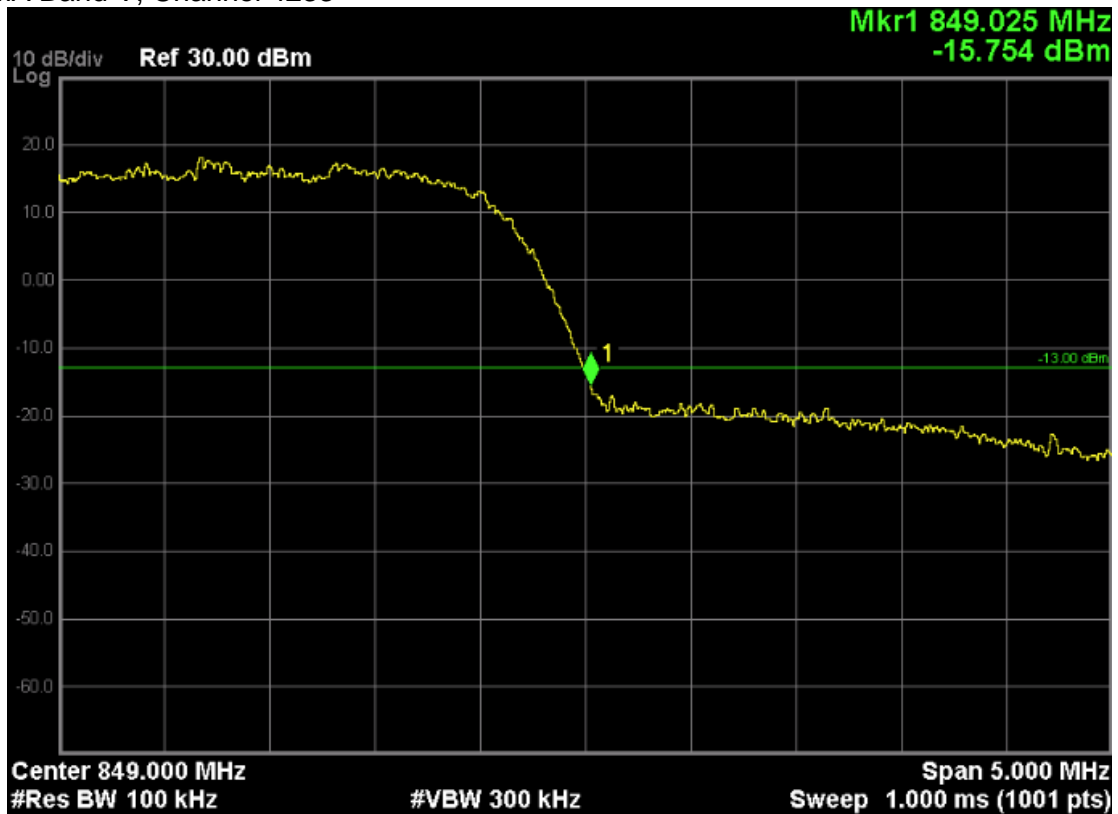

WCDMA Band II, Channel 9262



WCDMA Band II, Channel 9538

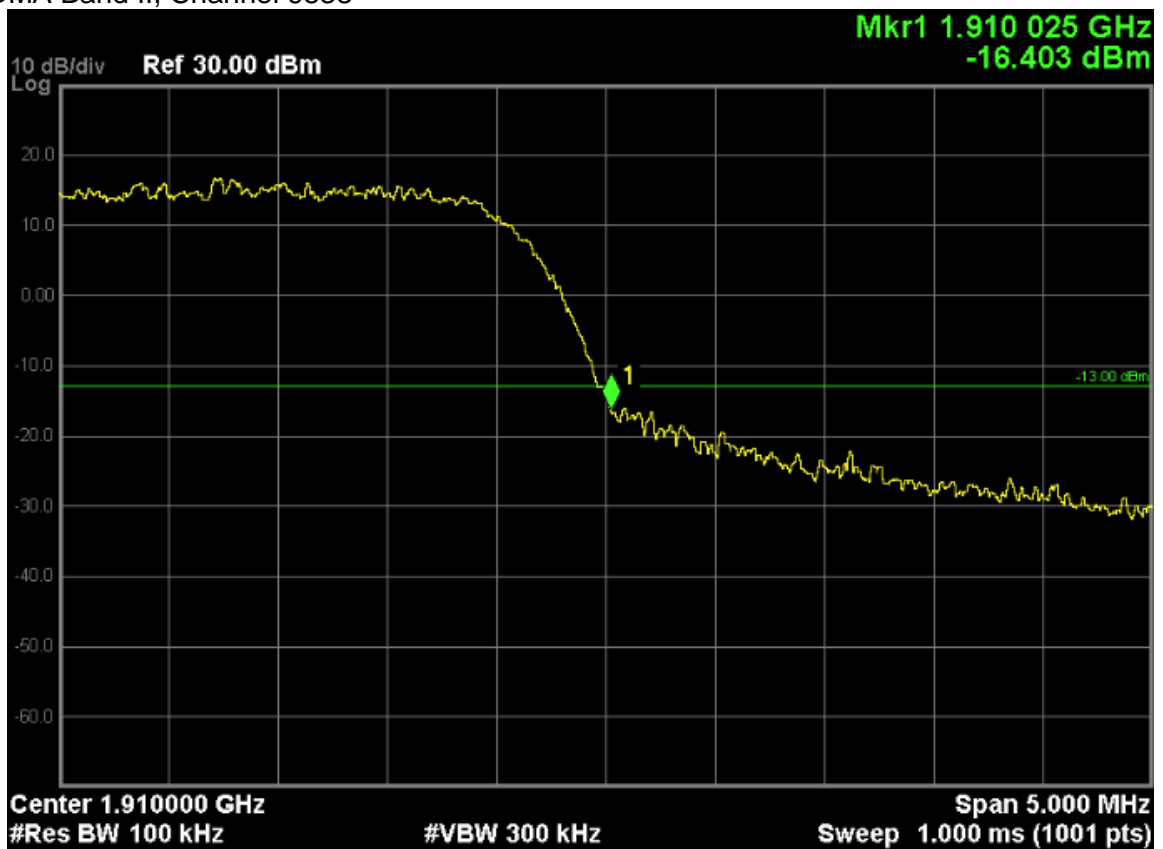

WCDMA Band IV, Channel 1312

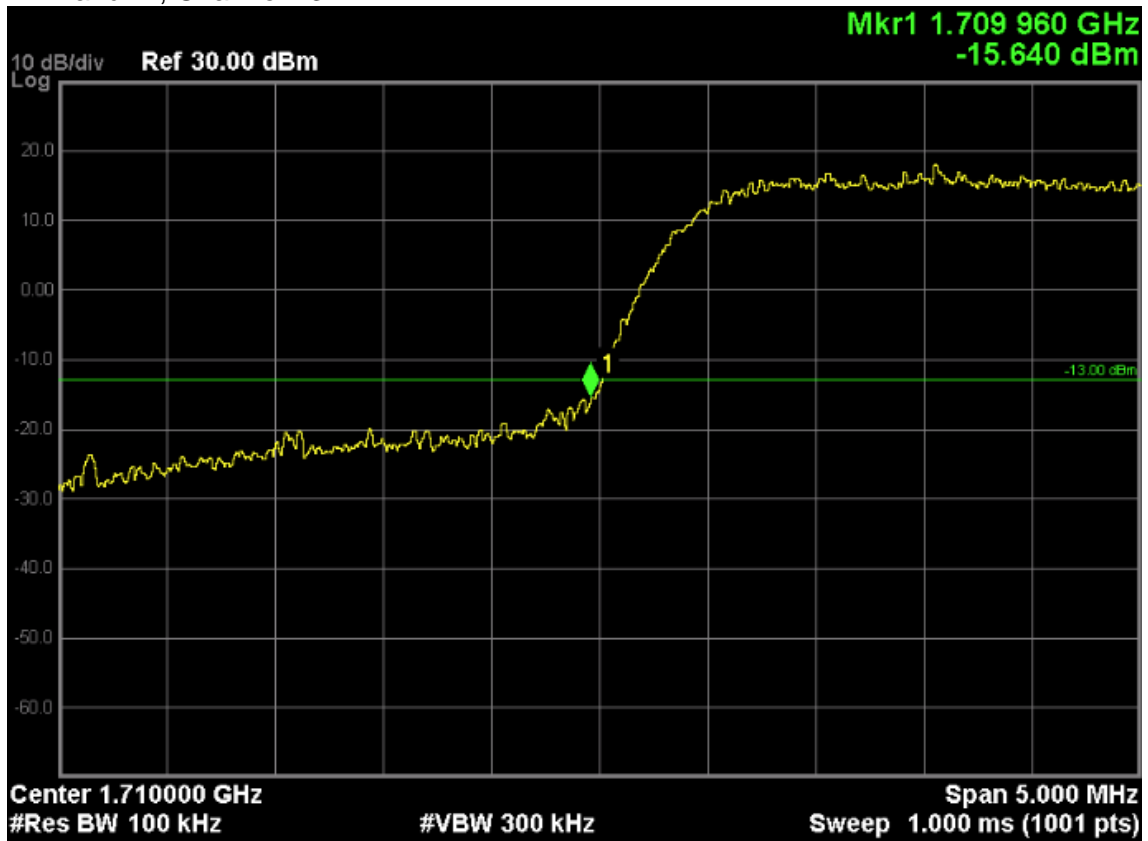

WCDMA Band IV, Channel 1513

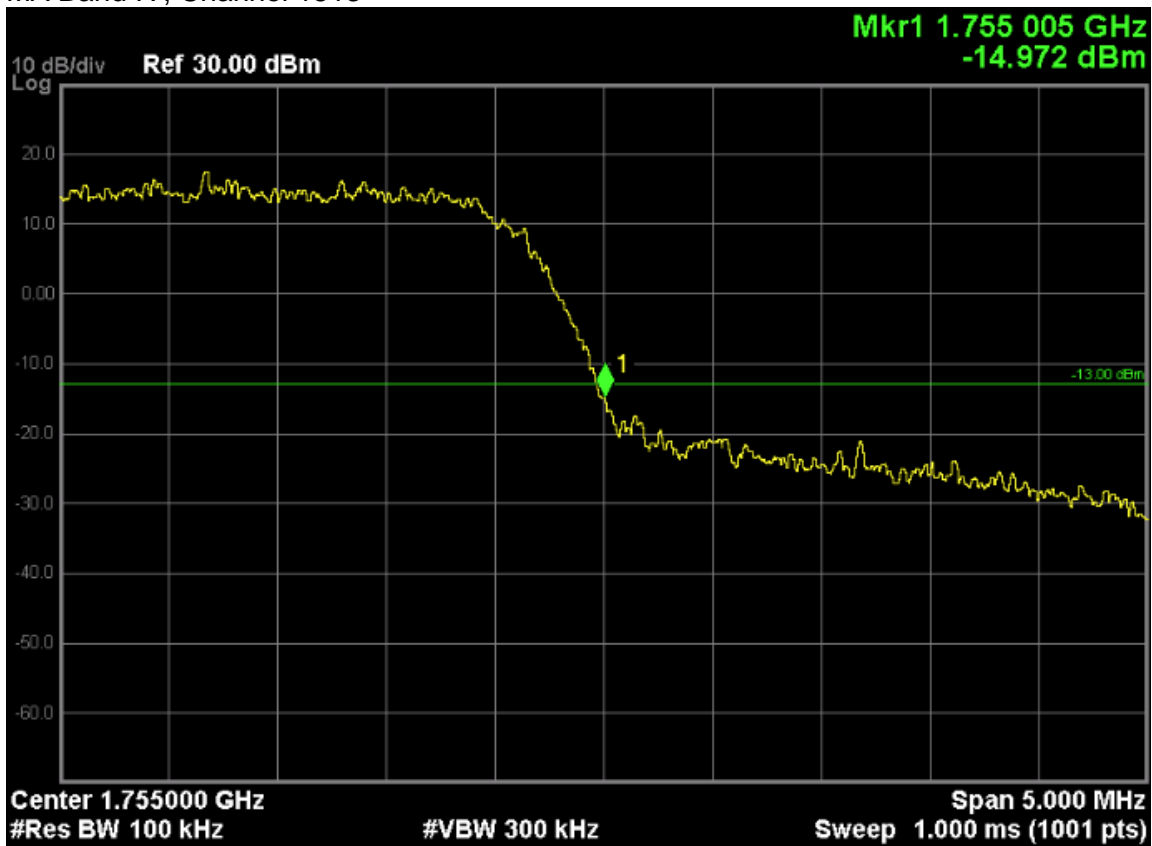

6.Spurious Emission

6.1. Test Equipment

Instrument	Manufacturer	Model	Serial No.	Cali. Due Date
Spectrum Analyzer	Agilent	N9038A	MY51210142	11/05/2016
Radio Communication Tester	R&S	CMW500	147483	11/08/2016
Signal Generator	Agilent	N5183A	MY50140938	01/04/2016
Preamplifier	CEM	EM30180	3008A0245	02/27/2016
Loop Antenna	Schwarzbeck	FMZB1519	1519-020	03/25/2016
Bilog Antenna	Schwarzbeck	VULB9160	9160-3316	09/19/2016
VHF-UHF-Biconical Antenna	Schwarzbeck	VUBA9117	9117-263	09/19/2016
Broad-Band Horn Antenna	Schwarzbeck	BBHA9120D	9120D-942	09/19/2016
Broad-Band Horn Antenna	Schwarzbeck	BBHA9120D	9120D-943	09/19/2016

The measure equipment had been calibrated once a year.

6.2. Test Setup

Conducted Spurious Emission Measurement:

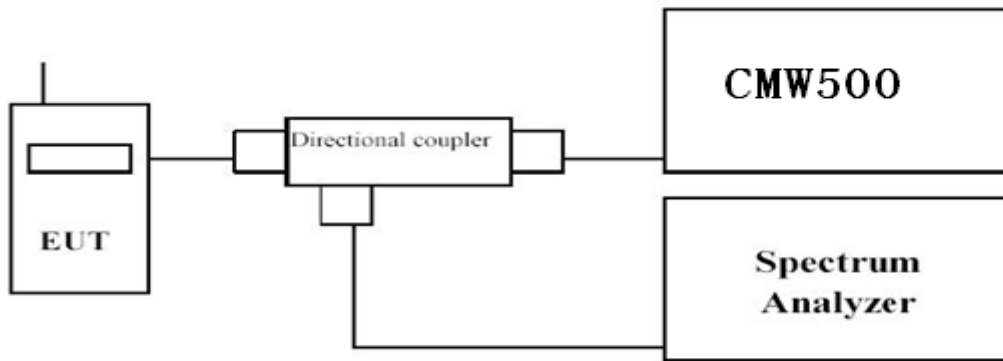

Radiated Spurious Measurement: below 30MHz

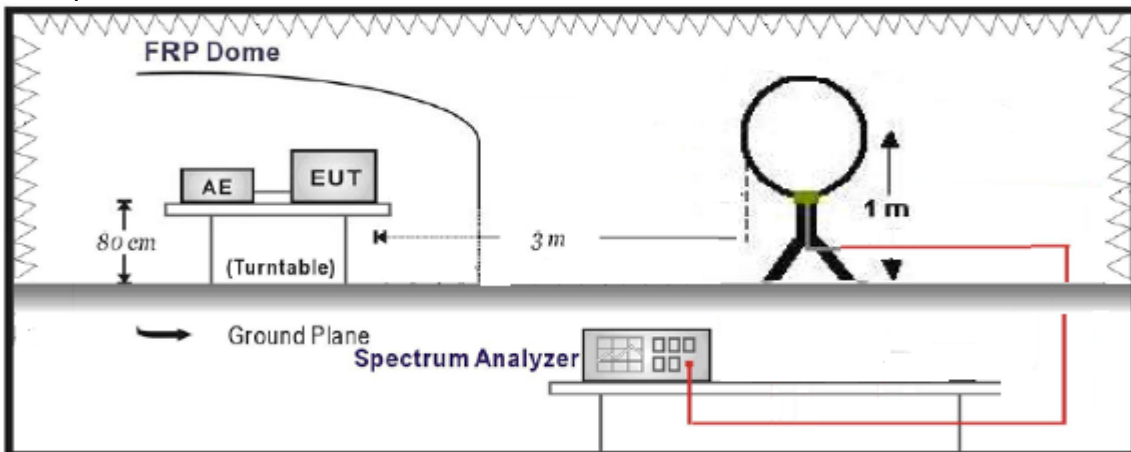

Radiated Spurious Measurement: 30MHz to 1GHz

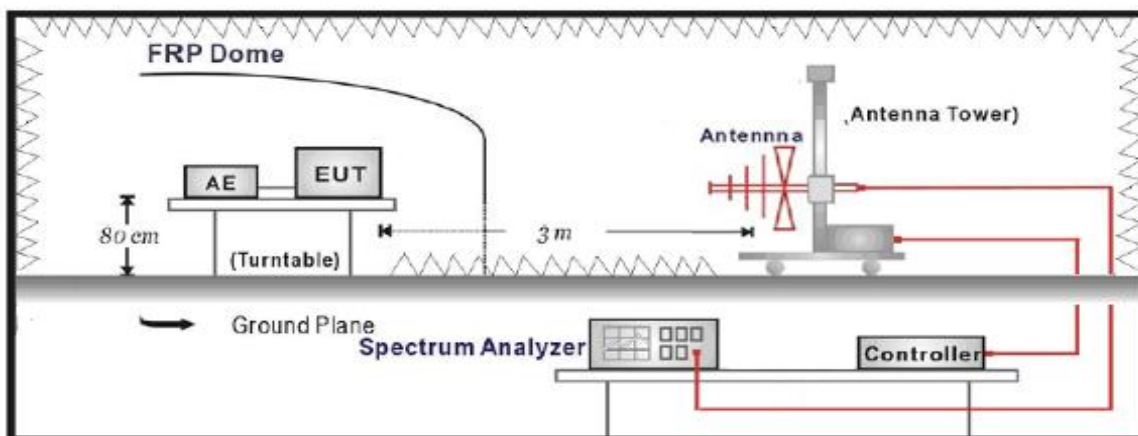

Radiated Spurious Measurement: above 1GHz

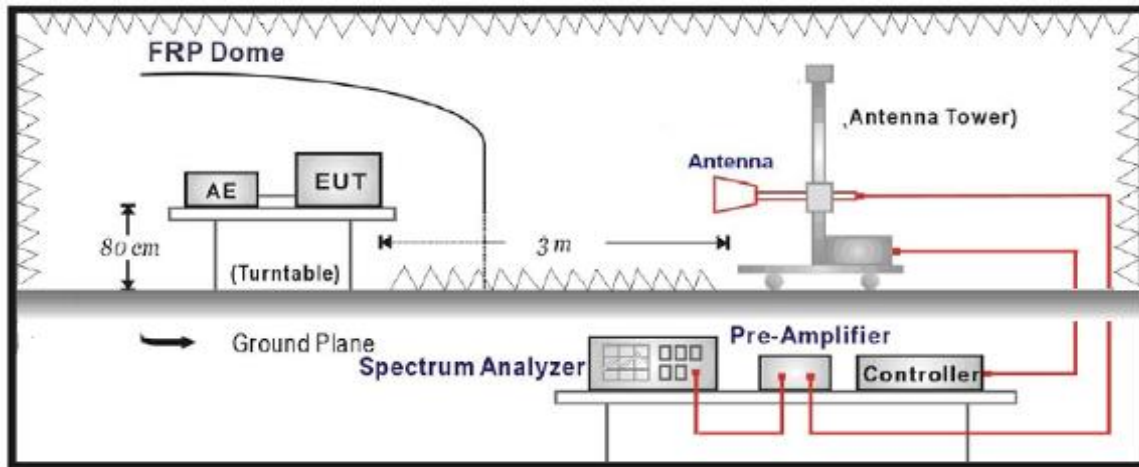

6.3. Limit

The power of any emission outside of the authorized operating frequency ranges must be attenuated below the transmitting power (P) by a factor of at least $43 + 10\log(P)$ dB.

6.4. Test Procedure

Conducted Spurious Measurement:

- The testing follows FCC KDB 971168 v02v02 Section 6.0;
- Place the EUT on a bench and set it in transmitting mode.
- Connect a low loss RF cable from the antenna port to a spectrum analyzer and CMW500 by a Directional Coupler.
- EUT Communicate with CMW500, then select a channel for testing.
- Add a correction factor to the display of spectrum, and then test.
- The resolution bandwidth of the spectrum analyzer was set at 1 MHz, sufficient scans were taken to show the out of band Emission if any up to 10th harmonic.

Radiated Spurious Measurement:

- The testing follows FCC KDB 971168 v02v02 Section 5.8 and ANSI/TIA-603-D-2010 Section 2.2.12;
- The EUT shall be placed at the specified height on a support, and in the position closest to normal use as declared by provider.
- The test antenna shall be oriented initially for vertical polarization and shall be chosen to correspond to the frequency of the transmitter
- The output of the test antenna shall be connected to the measuring receiver. The transmitter shall be switched on and the measuring receiver shall be tuned to the frequency of the transmitter under test.
- The test antenna shall be raised and lowered through the specified range of height until a

maximum signal level is detected by the measuring receiver.

- f. The transmitter shall then be rotated through 360° in the horizontal plane, until the maximum signal level is detected by the measuring receiver.
- g. The test antenna shall be raised and lowered again through the specified range of height until a maximum signal level is detected by the measuring receiver.
- h. The maximum signal level detected by the measuring receiver shall be noted.
- i. The transmitter shall be replaced by a substitution antenna.
- j. The substitution antenna shall be orientated for vertical polarization and the length of the substitution antenna shall be adjusted to correspond to the frequency of the transmitter.
- k. The substitution antenna shall be connected to a calibrated signal generator.
- l. If necessary, the input attenuator setting of the measuring receiver shall be adjusted in order to increase the sensitivity of the measuring receiver.
- m. The test antenna shall be raised and lowered through the specified range of height to ensure that the maximum signal is received.
- n. The input signal to the substitution antenna shall be adjusted to the level that produces a level detected by the measuring receiver, that is equal to the level noted while the transmitter radiated power was measured, corrected for the change of input attenuator setting of the measuring receiver.
- o. The measurement shall be repeated with the test antenna and the substitution antenna orientated for horizontal polarization.
- p. The measure of the effective radiated power is the larger of the two levels recorded at the input to the substitution antenna, corrected for gain of the substitution antenna if necessary.
- q. The frequency range was checked up to 10th harmonic.

6.5. Uncertainty

The measurement uncertainty is defined as 3.2 dB for Radiated Power Measurement.

6.6. Test Result

Conducted Spurious Measurement:

WCDMA Band II, Channel 9400:

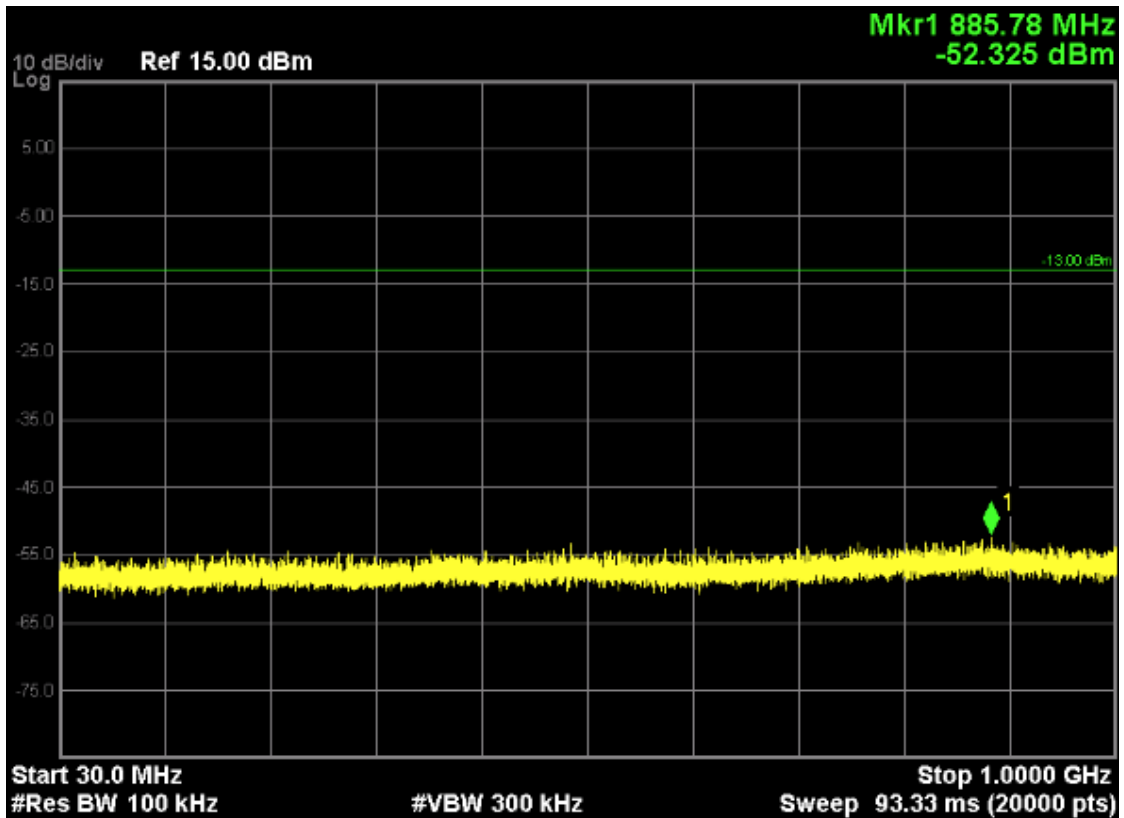
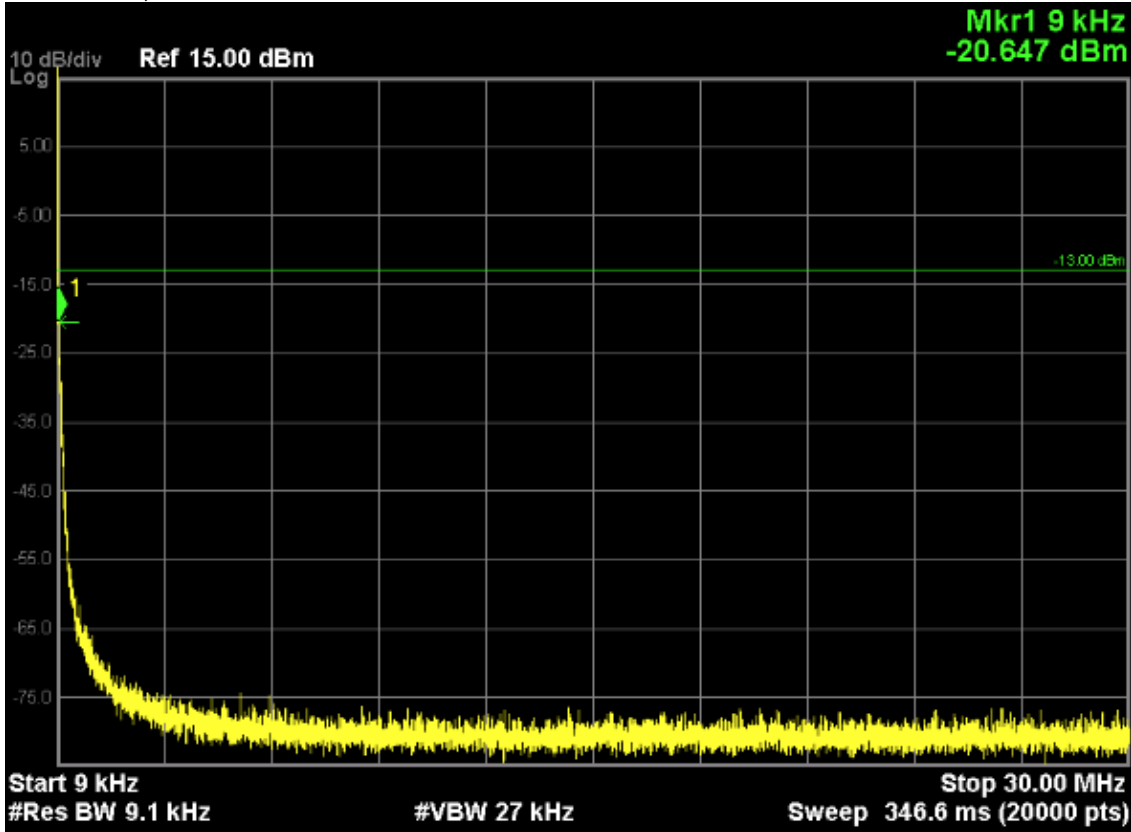

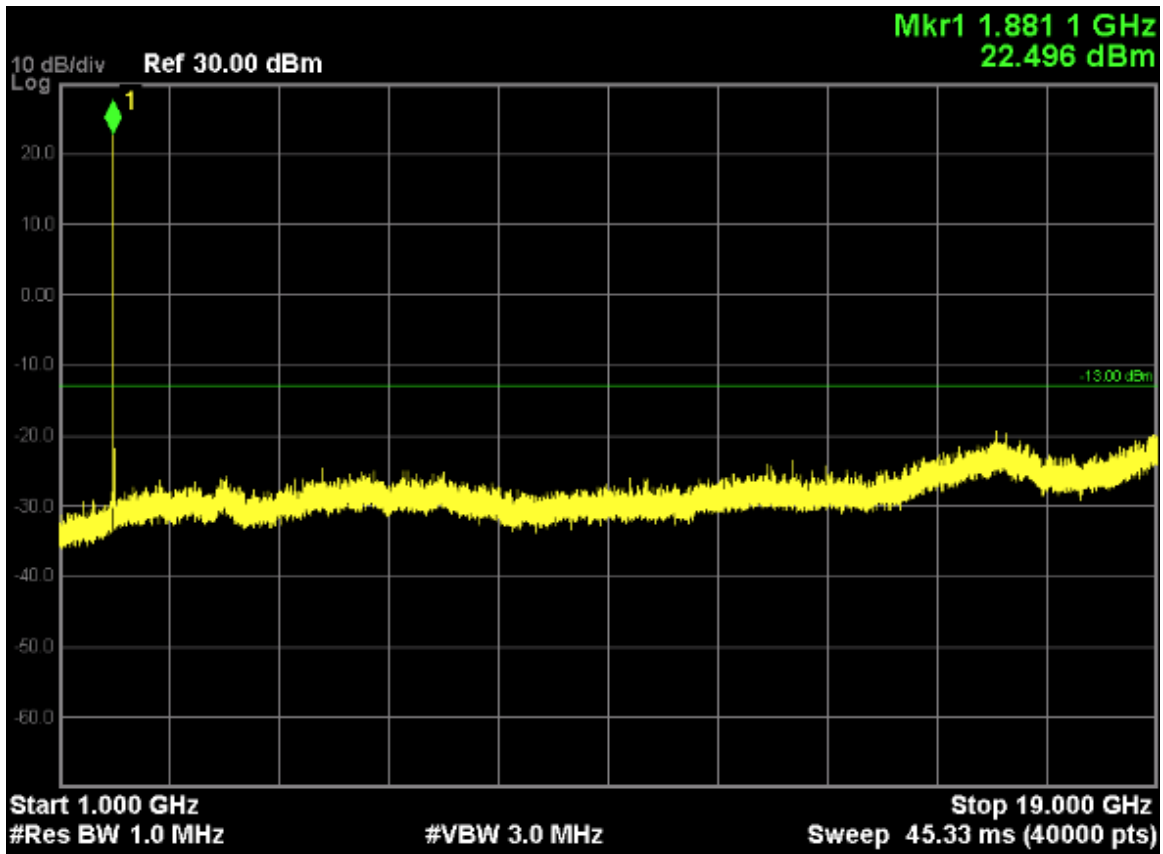

Note: The signal at point 1 is carrier

WCDMA Band V, Channel 4182:

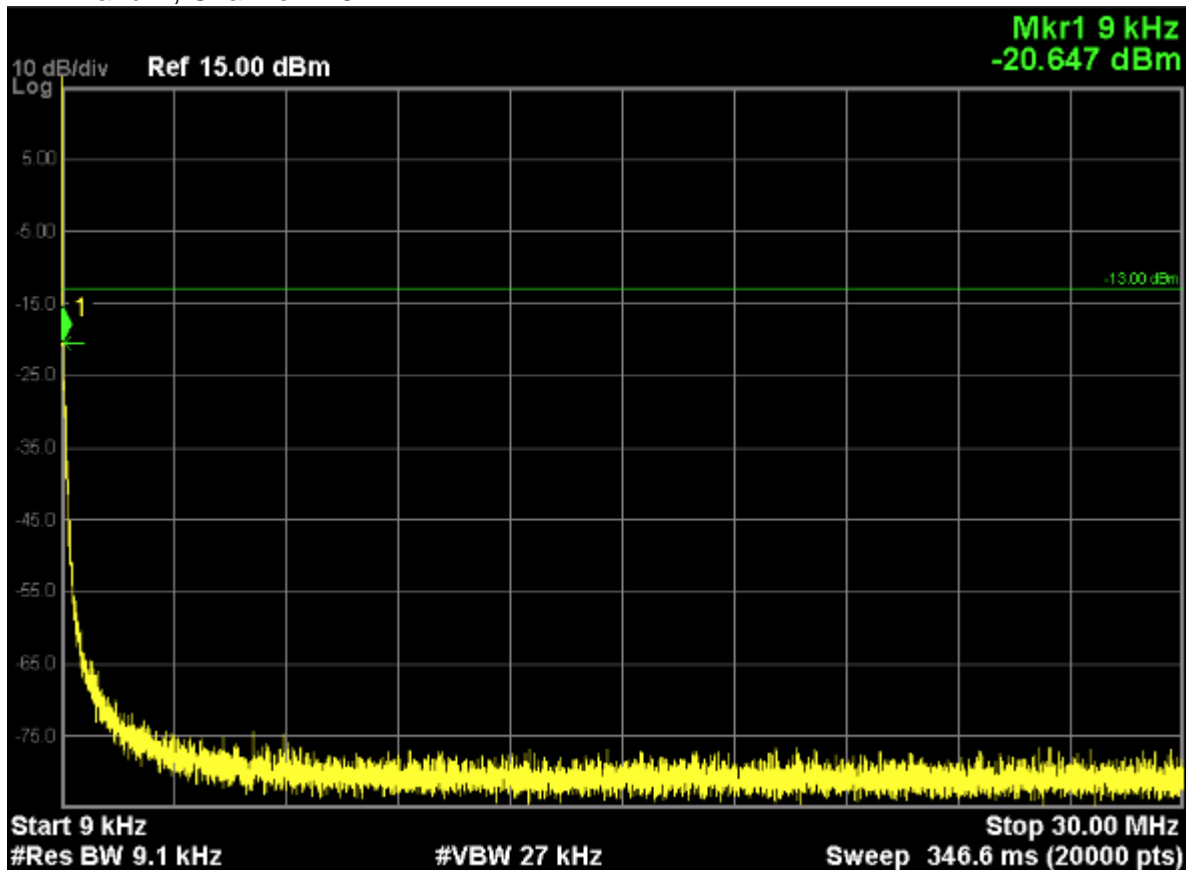

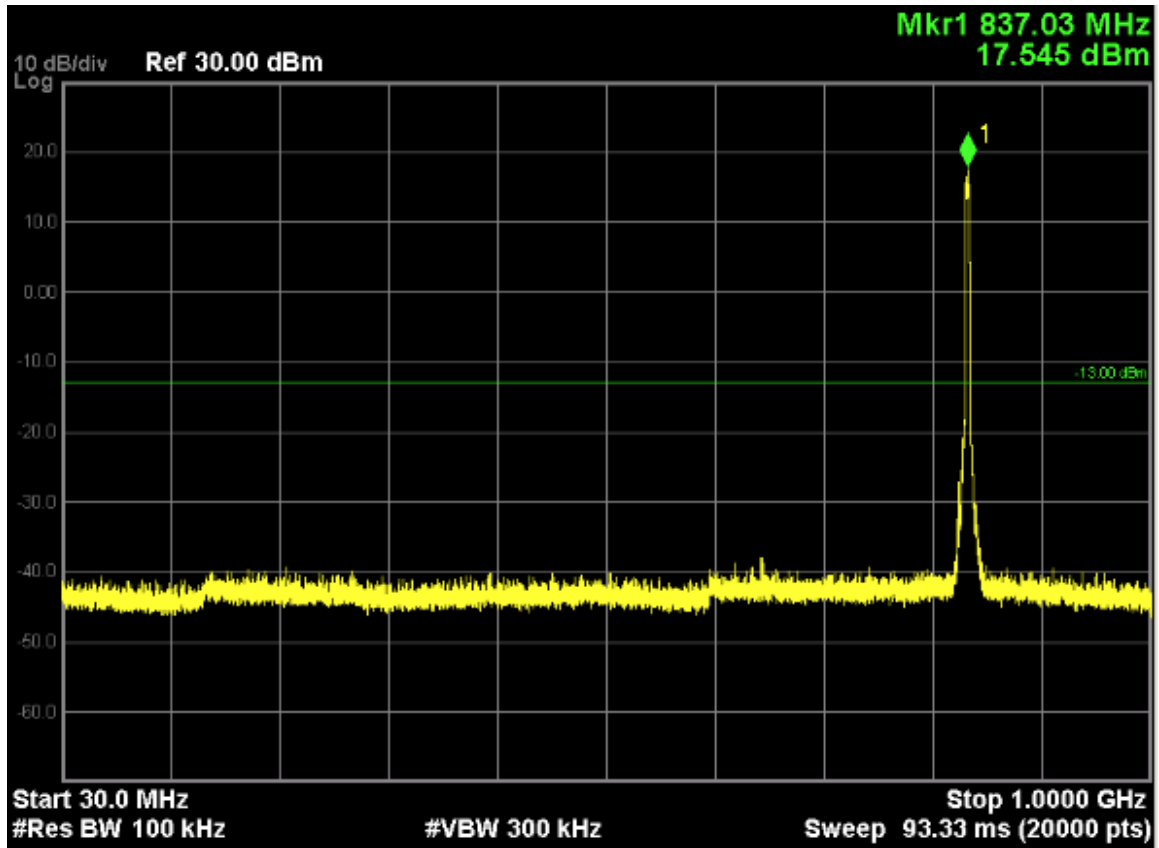

Note: The signal at point 1 is carrier

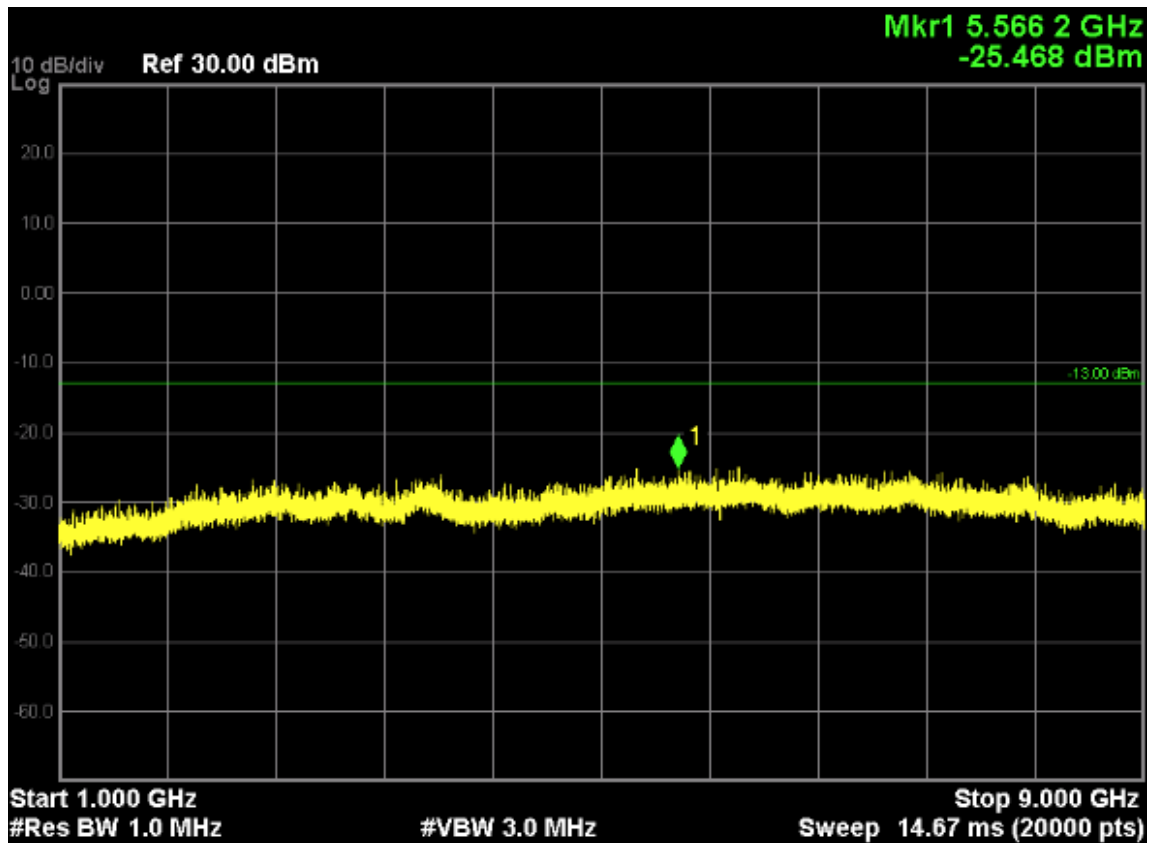

WCDMA Band IV, Channel 1413:

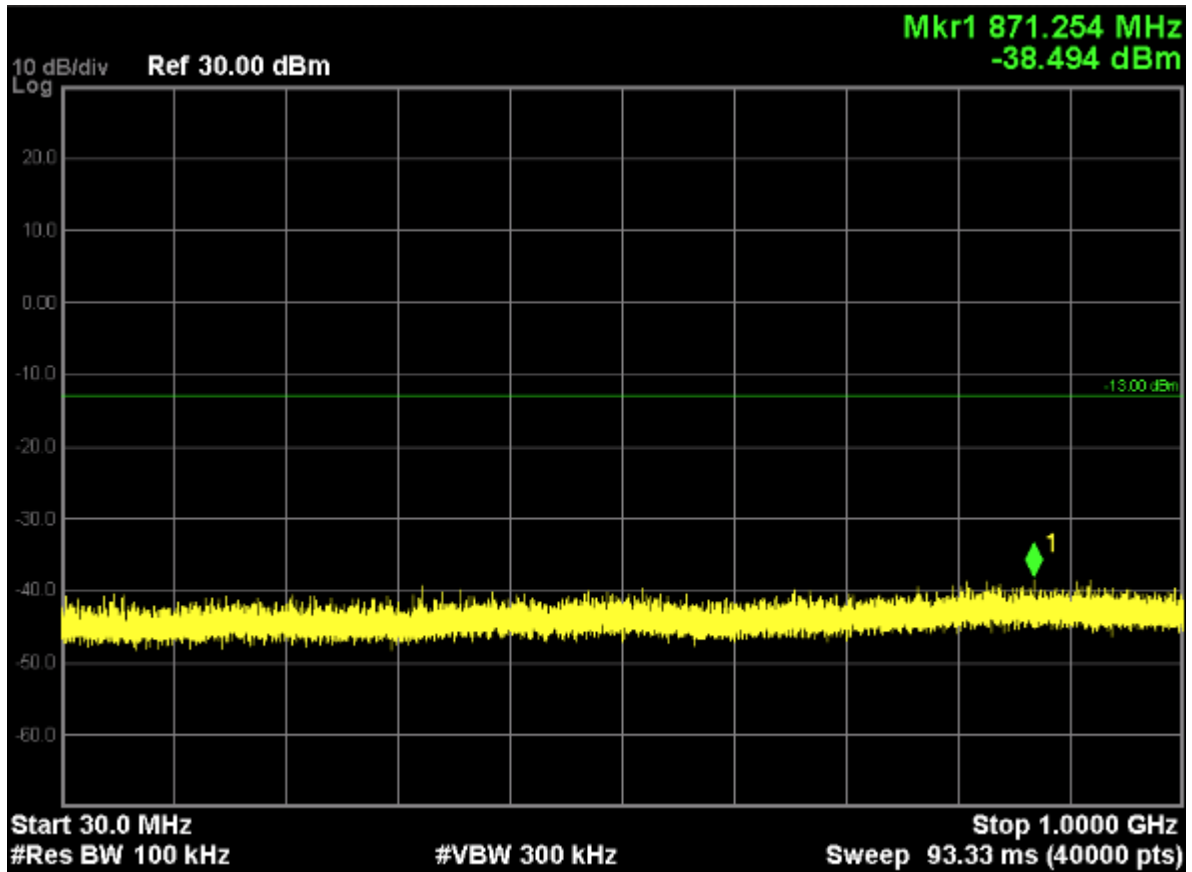
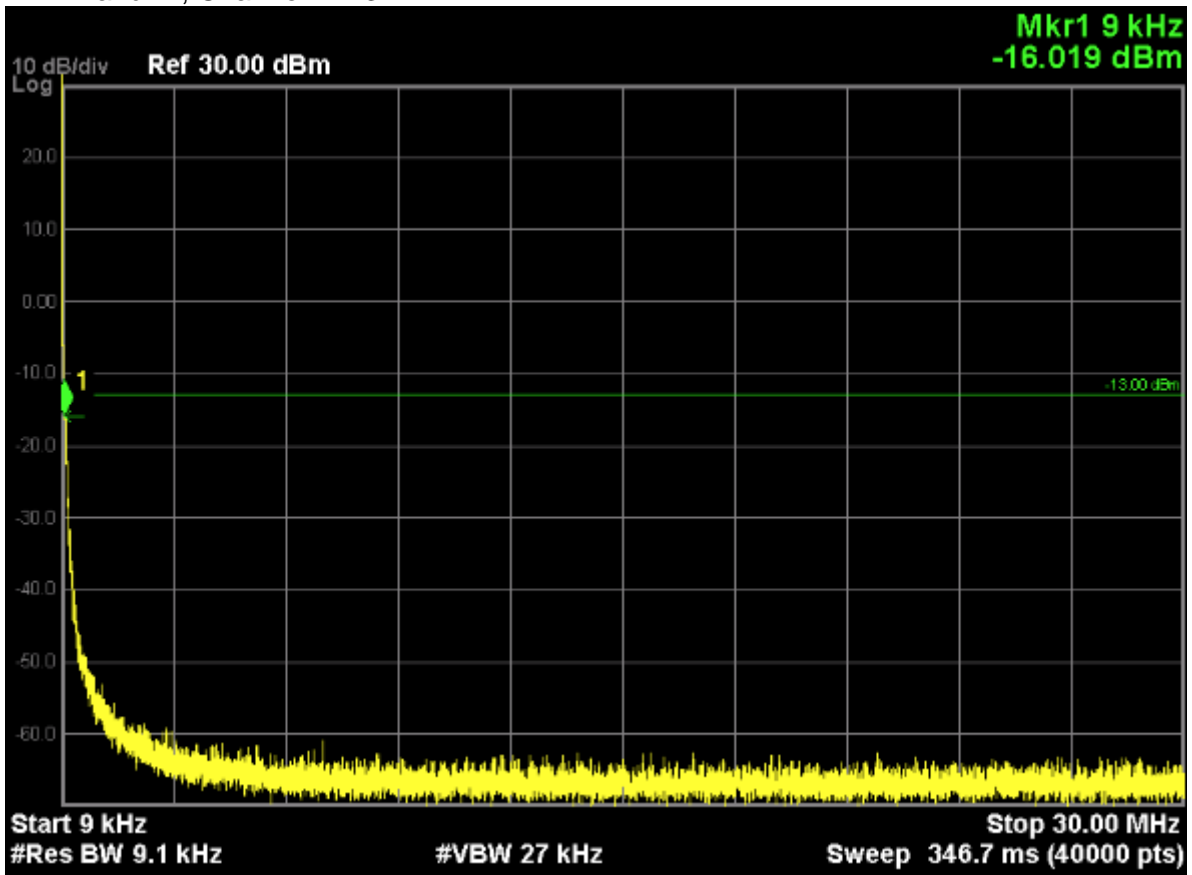

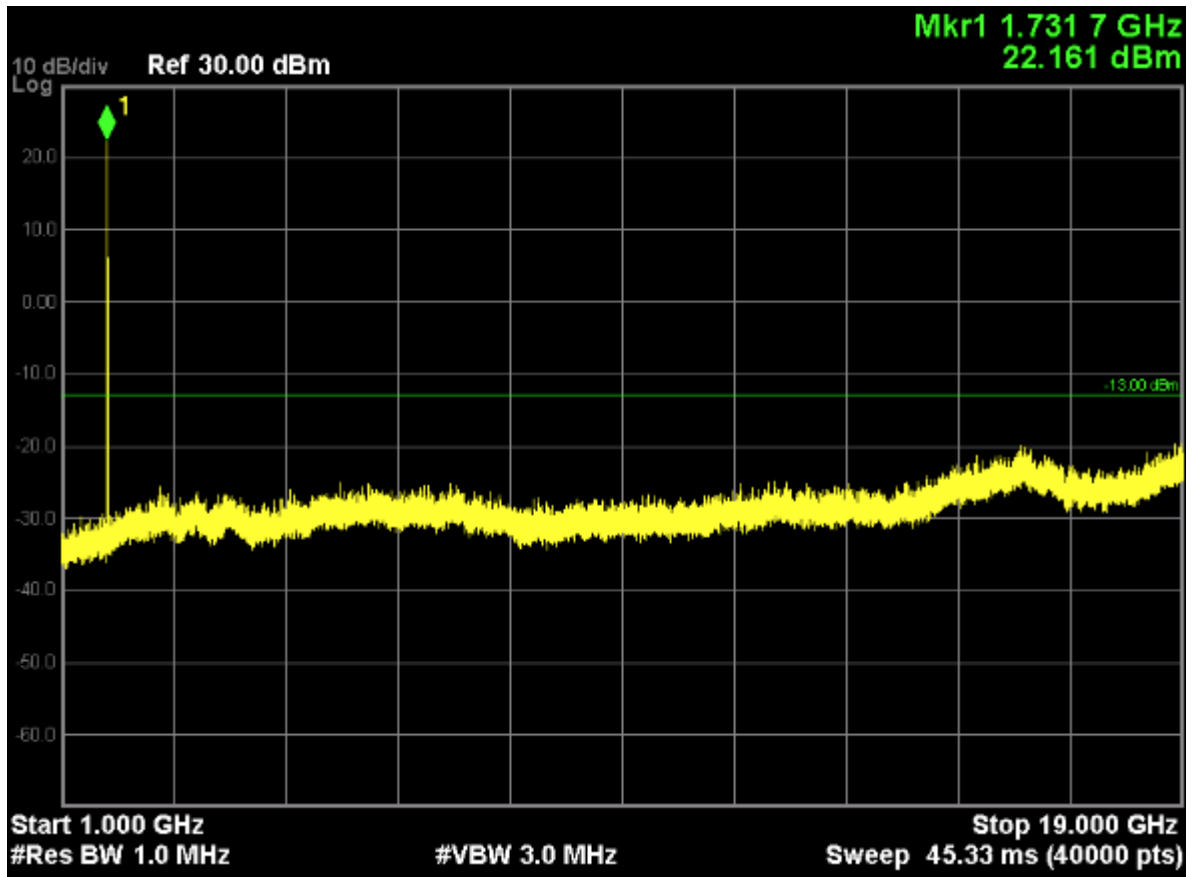

Note: The signal at point 1 is carrier

Radiated Spurious Measurement:

WCDMA Band V 9KHz to 30MHz

The low frequency, which started from 9KHz to 30MHz, was pre-scanned and the result which was 20dB lower than the limit line, and that was not reported per 2.1057 (c).

WCDMA Band V 30MHz to 1GHz

Frequency (MHz)	Ant. Pol. (H/V)	SG Reading (dBm)	Cable Loss (dB)	Gain (dBd)	ERP (dBm)	Limit (dBm)	Margin (dB)
Middle Channel 4182 (836.40MHz)							
667.8	H	-50.22	2.97	-2.16	-55.35	-13.00	-42.35
667.8	V	-48.33	2.97	-2.16	-54.49	-13.00	-41.49

WCDMA Band V Above 1GHz

Frequency (MHz)	Ant. Pol. (H/V)	SG Reading (dBm)	Cable Loss (dB)	Gain (dBd)	ERP (dBm)	Limit (dBm)	Margin (dB)
Middle Channel 4182 (836.40MHz)							
1672.8	H	-39.12	6.13	9.40	-36.35	-13.00	-23.35
1672.8	V	-41.25	6.13	9.40	-37.25	-13.00	-24.25
2509.2	H	-44.71	7.32	10.5	-41.20	-13.00	-28.20
2509.2	V	-48.35	7.32	10.5	-45.37	-13.00	-32.37
3345.6	H	-50.62	8.43	11.5	-47.64	-13.00	-34.64
3345.6	V	-52.49	8.43	11.5	-48.70	-13.00	-35.70

WCDMA Band II 9KHz to 30MHz

The low frequency, which started from 9KHz to 30MHz, was pre-scanned and the result which was 20dB lower than the limit line, and that was not reported per 2.1057 (c).

WCDMA Band II 30MHz to 1GHz

Frequency (MHz)	Ant. Pol. (H/V)	SG Reading (dBm)	Cable Loss (dB)	Gain (dBi)	EIRP (dBm)	Limit (dBm)	Margin (dB)
Middle Channel 9400 (1880MHz)							
732.7	H	-49.13	3.42	-2.56	-54.23	-13.00	-41.23
732.7	V	-51.10	3.42	-2.56	-55.61	-13.00	-42.61

WCDMA Band II Above 1GHz

Frequency (MHz)	Ant. Pol. (H/V)	SG Reading (dBm)	Cable Loss (dB)	Gain (dBi)	EIRP (dBm)	Limit (dBm)	Margin (dB)
Middle Channel 9400 (1880MHz)							
3760	H	-40.35	8.85	12.6	-37.60	-13.00	-24.60
3760	V	-43.54	8.85	12.6	-38.77	-13.00	-25.77
5640	H	-49.68	10.79	13.1	-47.70	-13.00	-34.70
5640	V	-52.03	10.79	13.1	-48.82	-13.00	-35.82

WCDMA Band IV 9KHz to 30MHz

The low frequency, which started from 9KHz to 30MHz, was pre-scanned and the result which was 20dB lower than the limit line, and that was not reported per 2.1057 (c).

WCDMA Band IV 30MHz to 1GHz

Frequency (MHz)	Ant. Pol. (H/V)	SG Reading (dBm)	Cable Loss (dB)	Gain (dBi)	EIRP (dBm)	Limit (dBm)	Margin (dB)
Middle Channel 1413 (1732.6MHz)							
731.8	H	-47.63	3.42	-2.56	-53.61	-13.00	-40.61
731.8	V	-49.66	3.42	-2.56	-55.64	-13.00	-42.64

WCDMA Band IV Above 1GHz

Frequency (MHz)	Ant. Pol. (H/V)	SG Reading (dBm)	Cable Loss (dB)	Gain (dBi)	EIRP (dBm)	Limit (dBm)	Margin (dB)
Middle Channel 1413 (1732.6MHz)							
3465.2	H	-48.30	8.58	11.56	-45.32	-13.00	-32.32
3465.2	V	-50.89	8.58	11.56	-47.91	-13.00	-34.91
5197.8	H	-52.36	9.69	12.83	-49.22	-13.00	-36.22
5197.8	V	-53.24	9.69	12.83	-50.10	-13.00	-37.10

7. Frequency Stability Under Temperature & Voltage Variations

7.1. Test Equipment

Instrument	Manufacturer	Model	Serial No.	Cali. Due Date
Spectrum Analyzer	Agilent	N9038A	MY51210142	11/05/2016
Radio Communication Tester	R&S	CMW500	147483	11/08/2016
DC Power Supply	Agilent	6612C	MY43002989	03/02/2016
Temperature Chamber	WEISS	DU/20/40	58226017340050	01/04/2016

The measure equipment had been calibrated once a year.

7.2. Test Setup

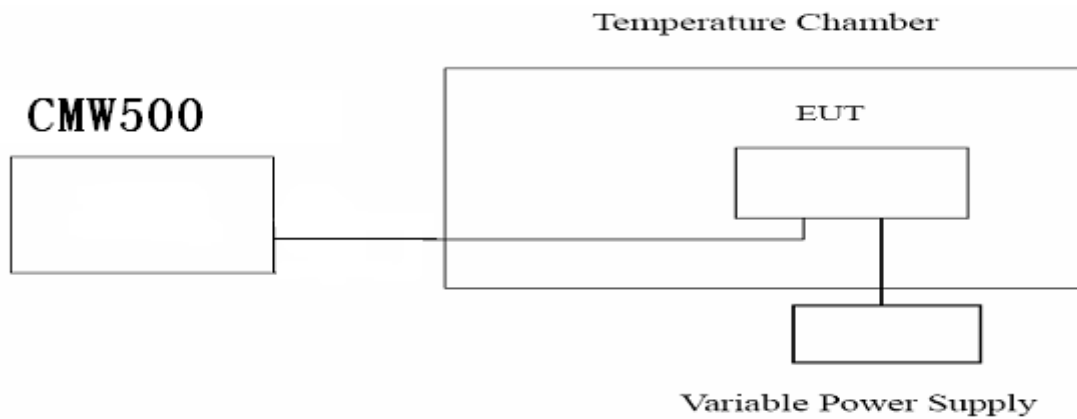

7.3. Limit

The frequency stability shall be sufficient to ensure that the fundamental emission stays within the authorized frequency block.

Limit	< ± 2.5 ppm
-------	-----------------

7.4. Test Procedure

1. The testing follows FCC KDB 971168 v02v02 Section 9.0;

2. Frequency Stability Under Temperature Variations:

The equipment under test was connected to an external AC or DC power supply and input rated voltage. RF output was connected to a frequency counter or CMW500. The EUT was placed inside the temperature chamber.

EUT 20°C operating frequency as reference frequency. Turn EUT off and set the chamber temperature to -20°C. After the temperature stabilized for approximately 30 minutes recorded the frequency. Repeat step measure with 10°C increased per stage until the highest temperature of +50°C reached.

3. Frequency Stability Under Voltage Variations:

Set chamber temperature to 20°C. Use a variable AC power supply / DC power source to power the EUT and set the voltage to rated voltage.

Reduce the input voltage to specify extreme voltage variation ($\pm 15\%$) and endpoint, record the maximum frequency change.

7.5. Uncertainty

The measurement uncertainty is defined as ± 10 Hz.

7.6. Test Result

WCDMA Band V:

Frequency Stability under Temperature

Temperature Interval (°C)	Test Frequency (MHz)	Deviation (Hz)	Limit(Hz)
-20	836.40	-9.08	± 2091
-10	836.40	-8.35	± 2091
0	836.40	-9.99	± 2091
10	836.40	-5.21	± 2091
20	836.40	-6.38	± 2091
30	836.40	-7.56	± 2091
40	836.40	-7.96	± 2091
50	836.40	-5.21	± 2091

Frequency Stability under Voltage

DC Voltage (V)	Test Frequency (MHz)	Deviation (Hz)	Limit(Hz)
3.0	836.40	-7.64	± 2091
3.8	836.40	-4.00	± 2091
4.5	836.40	-6.95	± 2091

WCDMA Band II:

Frequency Stability under Temperature

Temperature Interval (°C)	Test Frequency (MHz)	Deviation (Hz)	Limit(Hz)
-20	1880.00	-11.91	±4700
-10	1880.00	-5.95	±4700
0	1880.00	-6.38	±4700
10	1880.00	-7.57	±4700
20	1880.00	-6.51	±4700
30	1880.00	-9.85	±4700
40	1880.00	-5.21	±4700
50	1880.00	-8.36	±4700

Frequency Stability under Voltage

DC Voltage (V)	Test Frequency (MHz)	Deviation (Hz)	Limit(Hz)
3.2	1880.00	-9.98	±4700
3.8	1880.00	-7.65	±4700
4.4	1880.00	-13.25	±4700

WCDMA Band IV:

Frequency Stability under Temperature

Temperature Interval (°C)	Test Frequency (MHz)	Deviation (Hz)	Limit(Hz)
-20	1732.60	-8.35	± 4331.5
-10	1732.60	-5.87	± 4331.5
0	1732.60	-6.32	± 4331.5
10	1732.60	-8.76	± 4331.5
20	1732.60	-3.57	± 4331.5
30	1732.60	-9.21	± 4331.5
40	1732.60	-5.83	± 4331.5
50	1732.60	-7.30	± 4331.5

Frequency Stability under Voltage

DC Voltage (V)	Test Frequency (MHz)	Deviation (Hz)	Limit(Hz)
3.2	1732.60	-11.71	± 4331.5
3.8	1732.60	-7.64	± 4331.5
4.4	1732.60	10.47	± 4331.5

8. Peak to Average

8.1. Test Equipment

Instrument	Manufacturer	Model	Serial No.	Cali. Due Date
Spectrum Analyzer	Agilent	N9038A	MY51210142	11/05/2016
Radio Communication Tester	R&S	CMW500	147483	11/08/2016
Signal Generator	Agilent	N5183A	MY50140938	01/04/2016
Preamplifier	CEM	EM30180	3008A0245	02/27/2016
DC Power Supply	Agilent	6612C	MY43002989	03/02/2016

8.2. Test Setup

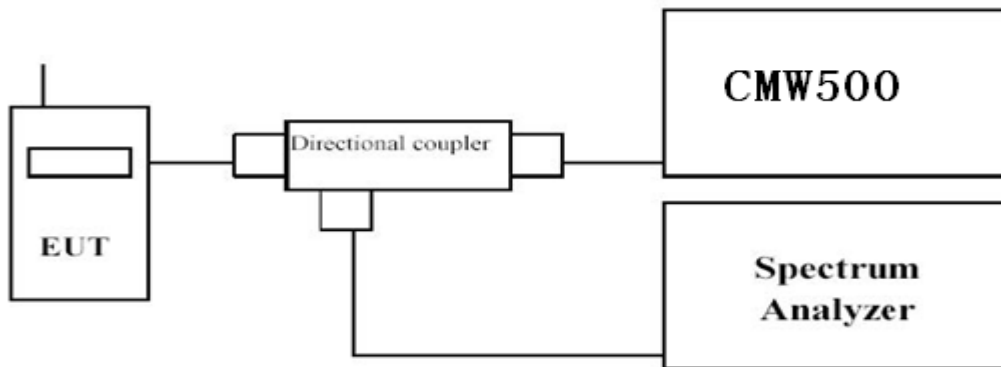

8.3. Limit

In addition, the transmitter's peak-to-average power ratio (PAPR) shall not exceed 13 dB for more than 0.1% of the time using a signal corresponding to the highest PAPR during periods of continuous transmission.

8.4. Test Procedure

A peak to average ratio measurement is performed at the conducted port of the EUT. For WCDMA signals, the spectrum analyzers Complementary Cumulative Distribution Function(CCDF) measurement profile is used to determine the largest deviation between the average and the peak power of the EUT in a given a bandwidth. The CCDF curve shows how much time the peak waveform spends at or above a given average power level. The percent of time the signal spends at or above the level defines the probability for that particular power level.

Procedure:

1. The testing follows FCC KDB 971168 v02v02 Section 5.7.1;
2. Place the EUT on a bench and set it in transmitting mode.
3. Connect a low loss RF cable from the antenna port to a spectrum analyzer and CMW500 by a Directional Couple.
4. EUT Communicate with CMW500, then select a channel for testing.
5. Add a correction factor to the display of spectrum, and then test.
6. Set resolution/measurement bandwidth \geq signal's occupied bandwidth;

8.5. Uncertainty

The measurement uncertainty is defined as ± 1.2 dB.

8.6. Test Result

Band	Channel No.	Limit (dB)	Result (dB)
WCDMA BAND II	9400	< 13	6.89
WCDMA BAND V	4182	< 13	6.00
WCDMA BAND IV	1413	< 13	6.50

For WCDMA BAND II, channel 9800

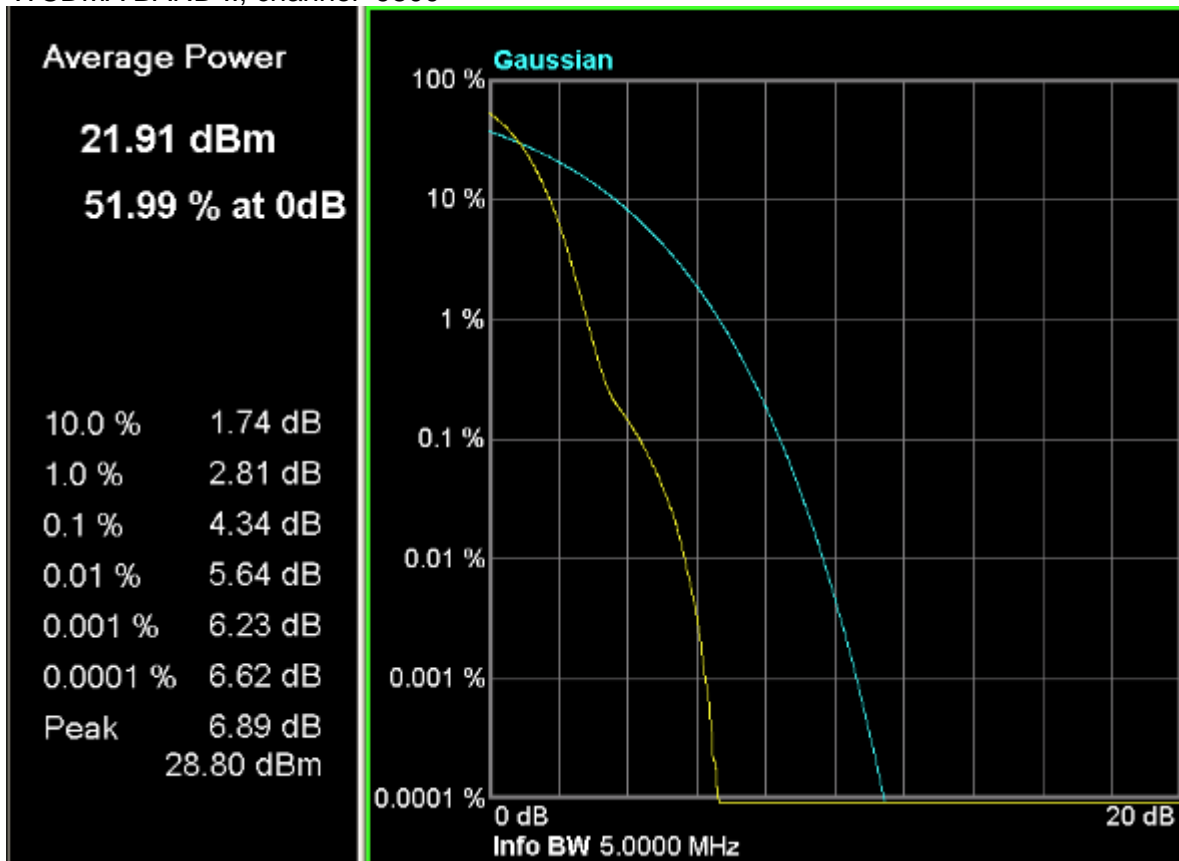

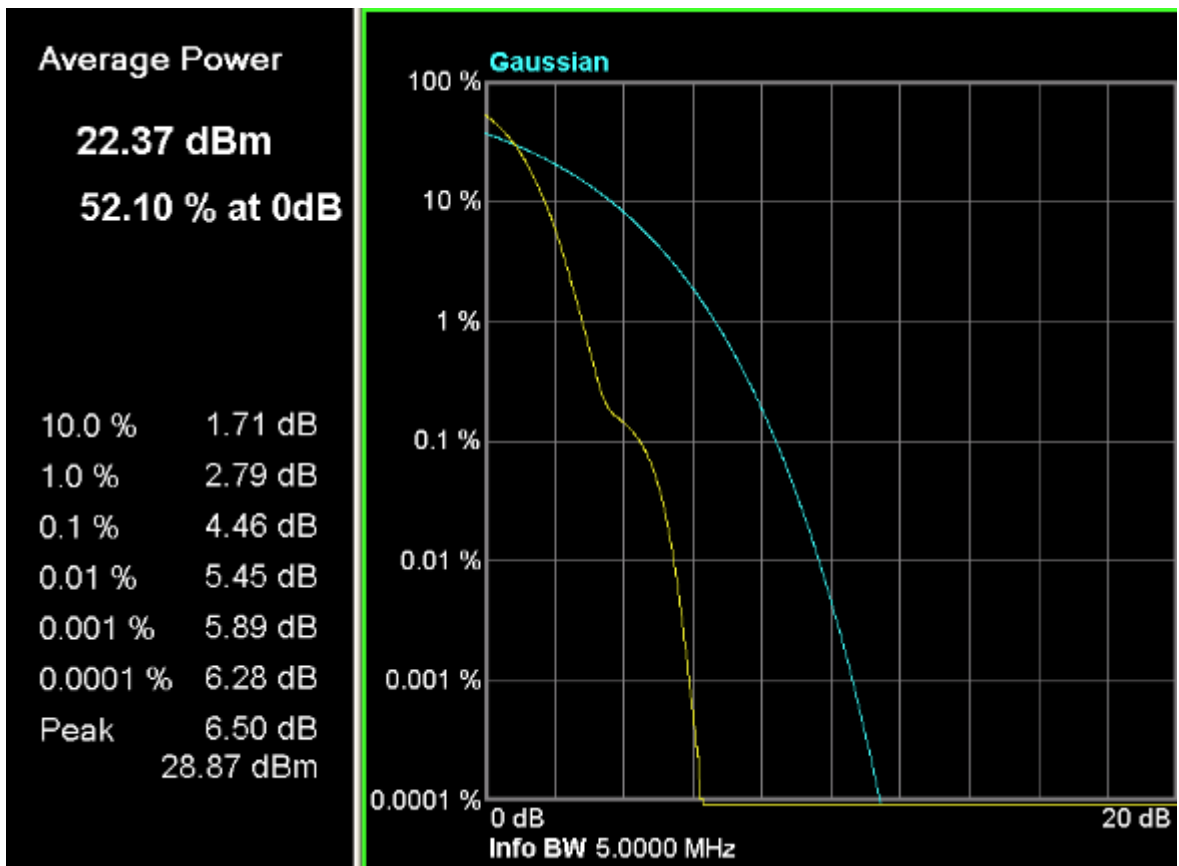
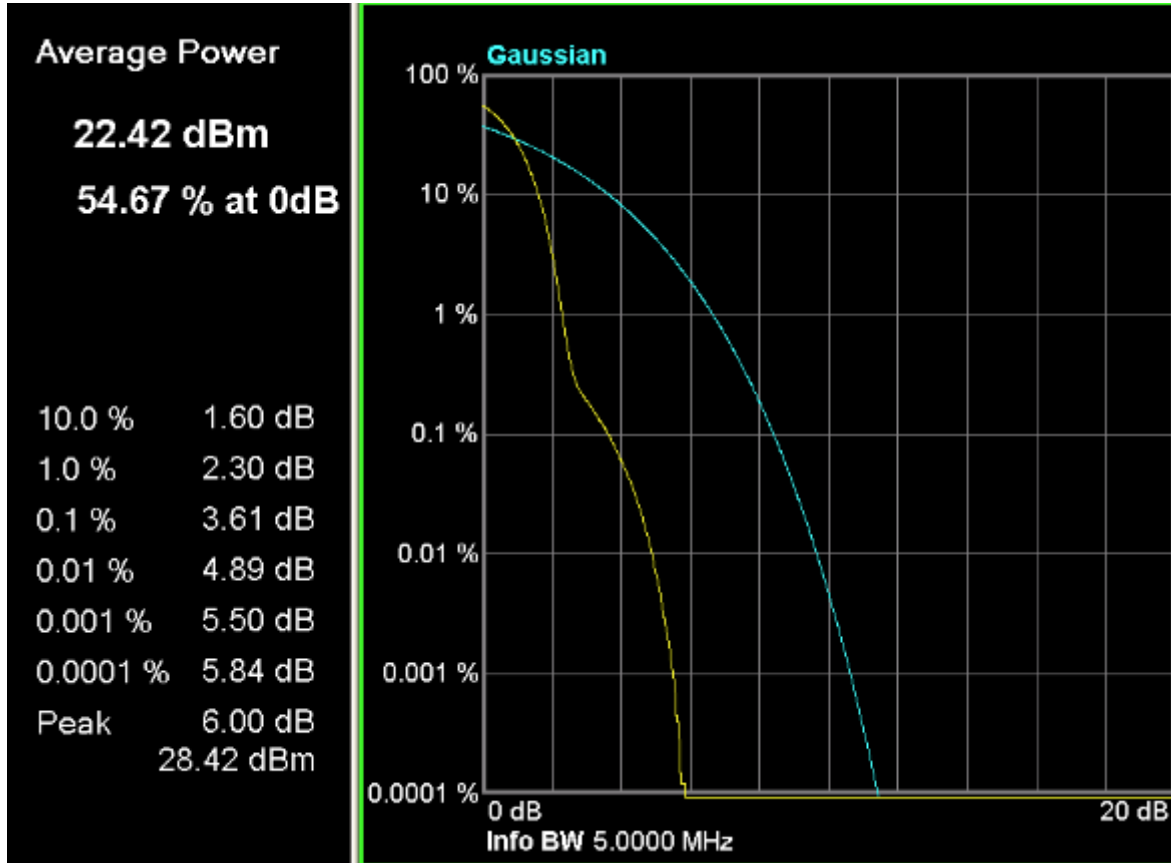

9.Receiver Spurious Emission for RSS 132/133

9.1. Test Equipment

Instrument	Manufacturer	Model	Serial No.	Cali. Due Date
Spectrum Analyzer	Agilent	N9038A	MY51210142	11/05/2016
Radio Communication Tester	Agilent	E5515C	GB46581718	11/08/2016
Signal Generator	Agilent	N5183A	MY50140938	01/02/2016
Preamplifier	CEM	EM30180	3008A0245	02/27/2016
Loop Antenna	Schwarzbeck	FMZB1519	1519-020	03/26/2016
Bilog Antenna	Schwarzbeck	VULB9160	9160-3316	09/19/2016
VHF-UHF-Biconical Antenna	Schwarzbeck	VUBA9117	9117-263	09/19/2016
Broad-Band Horn Antenna	Schwarzbeck	BBHA9120D	9120D-942	09/19/2016
Broad-Band Horn Antenna	Schwarzbeck	BBHA9120D	9120D-943	09/19/2016

The measure equipment had been calibrated once a year.

9.2. Test Setup

Below 1GHz Test Setup

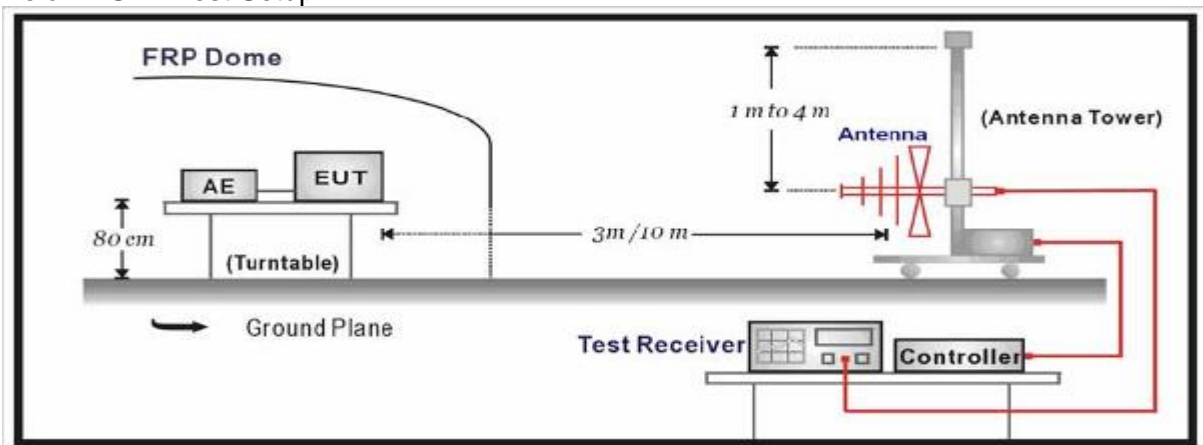

Above 1GHz Test Setup

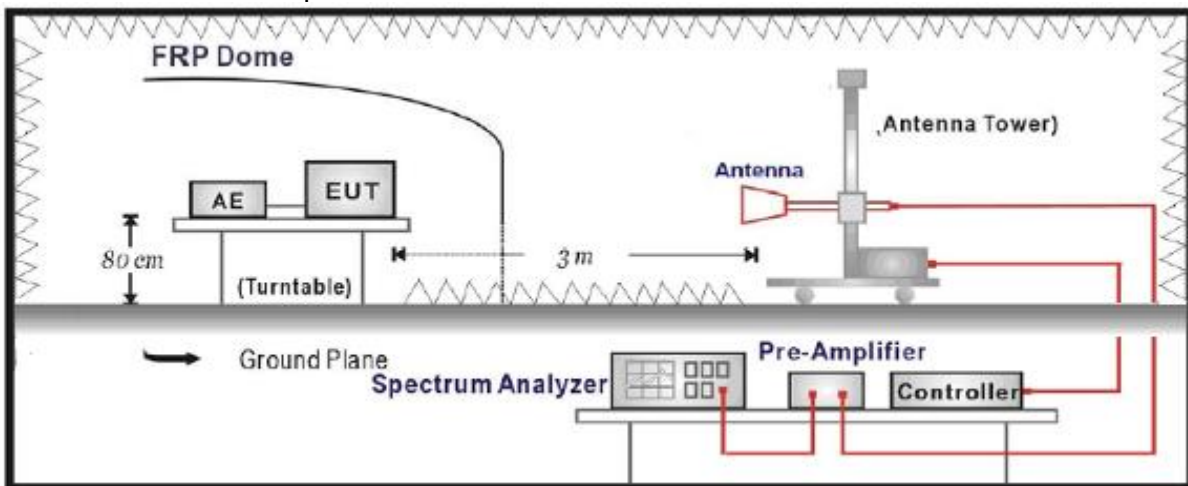

9.3. Limit

According to Standard RSS 132/133 refer to RSS-Gen Issu 4.

Field Strength micro-volts/m at 3 meters		
Frequency (MHz)	Distance (m)	Level (dB μ V/m)
30 - 88	3	40
88 - 216	3	43.5
216 - 960	3	46
Above 960	3	54

Note 1: The lower limit shall apply at the transition frequency.

Note 2: Distance refers to the distance in meters between the measuring instrument antenna and the closed point of any part of the device or system.

Note 3: E field strength (dB μ V/m) = 20 log E field strength (uV/m).

9.4. Test Procedure

The EUT and its simulators are placed on a turn table which is 0.8 meter above ground. The turn table can rotate 360 degrees to determine the position of the maximum emission level. The EUT was positioned such that the distance from antenna to the EUT was 3 meters. The antenna can move up and down between 1 meter and 4 meters to find out the maximum emission level. Both horizontal and vertical polarization of the antenna are set on measurement. In order to find the maximum emission, all of the interface cables must be manipulated on radiated measurement. On any frequency or frequencies below or equal to 1000 MHz, the radiated limits shown are based on measuring equipment employing a quasi-peak detector function and above 100MHz, the radiated limits shown are based measuring equipment employing an average detector function.

When average radiated emission measurement are included emission measurement Above 1000 MHz, there also is a limit on the radio frequency emissions, as measured using instrumentation with a peak detector function, corresponding to 20 dB above the maximum permitted average limit.

Note: When measurement above 1GHz, the horn antenna will bend down a little (as horn antenna have the narrow beamwidth) in order to find the maximum emission of EUT.

9.5. Uncertainty

The measurement uncertainty is defined as 3.1 dB for Radiated Power Measurement.

9.6. Test Result

No significant emissions measurable. Plots reported here represent the worse case emissions.

WCDMA BAND V(IDLE)

WCDMA BAND V Normal Voltage Condition at Middle Channel

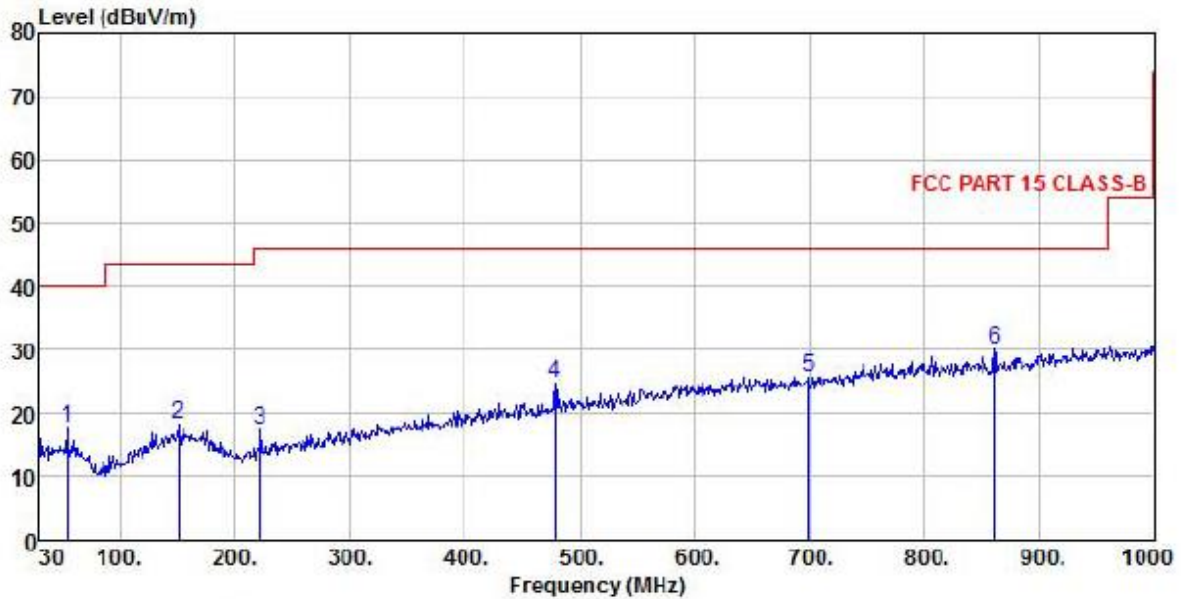

Site : chamber
 Condition : FCC PART 15 CLASS-B 3m VULB9160 HORIZONTAL
 EUT :
 Model Name :
 Temp/Humi : 20 °C / 50 %
 Power Rating:
 Mode : WCDMA BAND V
 Memo :

	ReadAntenna	Cable	Preamp	Limit	Over				
Freq	Level	Factor	Loss	Factor	Level	Line	Limit	Remark	
MHz	dBuV	dB/m	dB	dB	dBuV/m	dBuV/m	dB		
1	54.25	4.27	12.40	0.99	0.00	17.66	40.00	-22.34	Peak
2	150.28	2.75	13.90	1.64	0.00	18.29	43.50	-25.21	Peak
3	221.09	4.57	10.76	2.11	0.00	17.44	46.00	-28.56	Peak
4	479.11	4.91	16.89	3.00	0.00	24.80	46.00	-21.20	Peak
5	699.30	2.03	20.12	3.66	0.00	25.81	46.00	-20.19	Peak
6 pp	861.29	3.91	22.06	4.01	0.00	29.98	46.00	-16.02	Peak

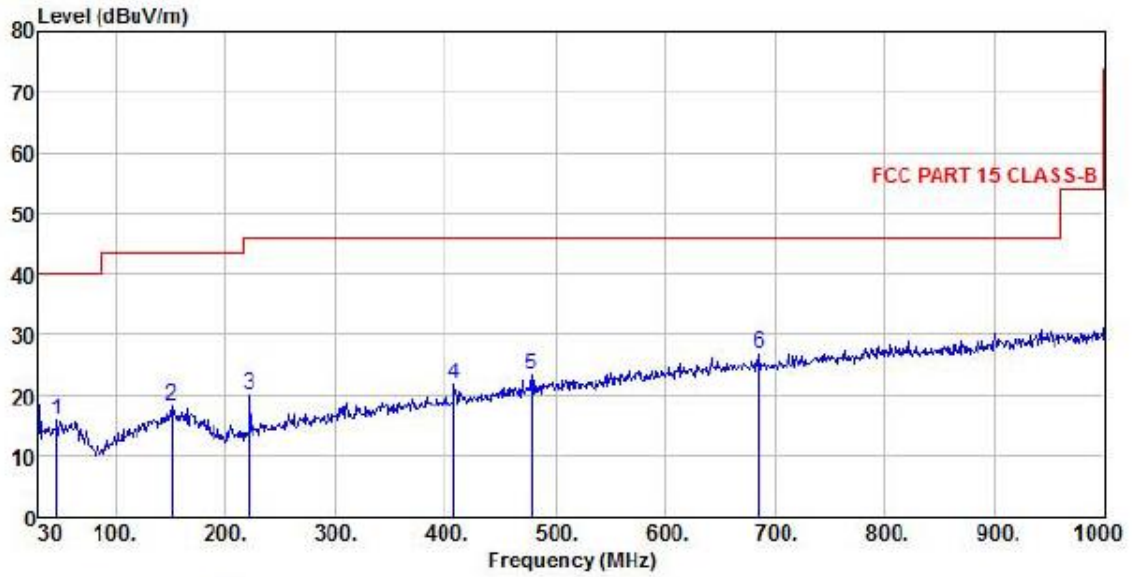

Site : chamber
 Condition : FCC PART 15 CLASS-B 3m VULB9160 VERTICAL
 EUT :
 Model Name :
 Temp/Humi : 20 °C / 50 %
 Power Rating:
 Mode : WCDMA BAND V
 Memo :

	ReadAntenna	Cable	Preamp		Limit	Over		
Freq	Level	Factor	Loss	Factor	Level	Line	Limit	Remark
MHz	dBuV	dB/m	dB	dB	dBuV/m	dBuV/m	dB	
1	45.52	2.24	12.75	0.90	0.00	15.89	40.00	-24.11 Peak
2	150.28	2.71	13.90	1.64	0.00	18.25	43.50	-25.25 Peak
3	221.09	7.28	10.76	2.11	0.00	20.15	46.00	-25.85 Peak
4	408.30	3.47	15.47	2.77	0.00	21.71	46.00	-24.29 Peak
5	479.11	3.56	16.89	3.00	0.00	23.45	46.00	-22.55 Peak
6 pp	685.72	3.20	19.97	3.59	0.00	26.76	46.00	-19.24 Peak

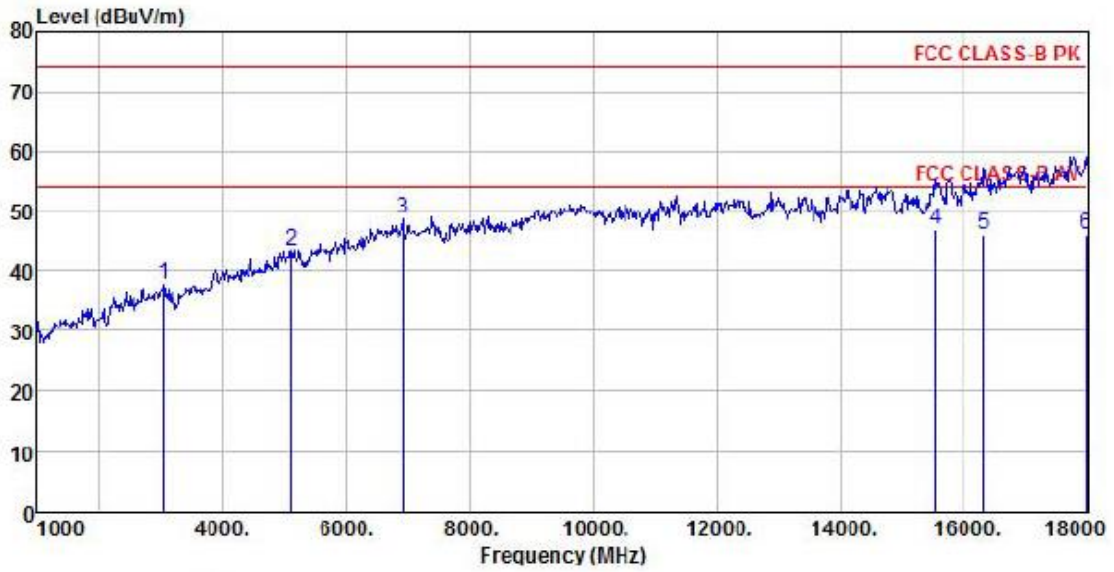

Site : chamber
 Condition : FCC CLASS-B PK 3m BBHA9120D(942) HORIZONTAL
 EUT :
 Model Name :
 Temp/Humi : 20 °C / 50 %
 Power Rating:
 Mode : WCDMA BAND V
 Memo :

	ReadAntenna	Cable	Preamp	Limit	Over			
Freq	Level	Factor	Loss	Factor	Level	Line	Limit	Remark
MHz	dBuV	dB/m	dB	dB	dBuV/m	dBuV/m	dB	
1	3040.00	39.11	28.65	8.14	38.08	37.82	74.00	-36.18 Peak
2	5114.00	37.87	32.10	10.58	37.06	43.49	74.00	-30.51 Peak
3 pk	6933.00	37.40	35.14	12.50	36.33	48.71	74.00	-25.29 Peak
4 pp	15552.00	28.54	38.29	18.34	38.20	46.97	54.00	-7.03 Average
5	16315.00	28.42	38.65	17.40	38.54	45.93	54.00	-8.07 Average
6	17983.00	16.23	47.82	18.74	36.73	46.06	54.00	-7.94 Average

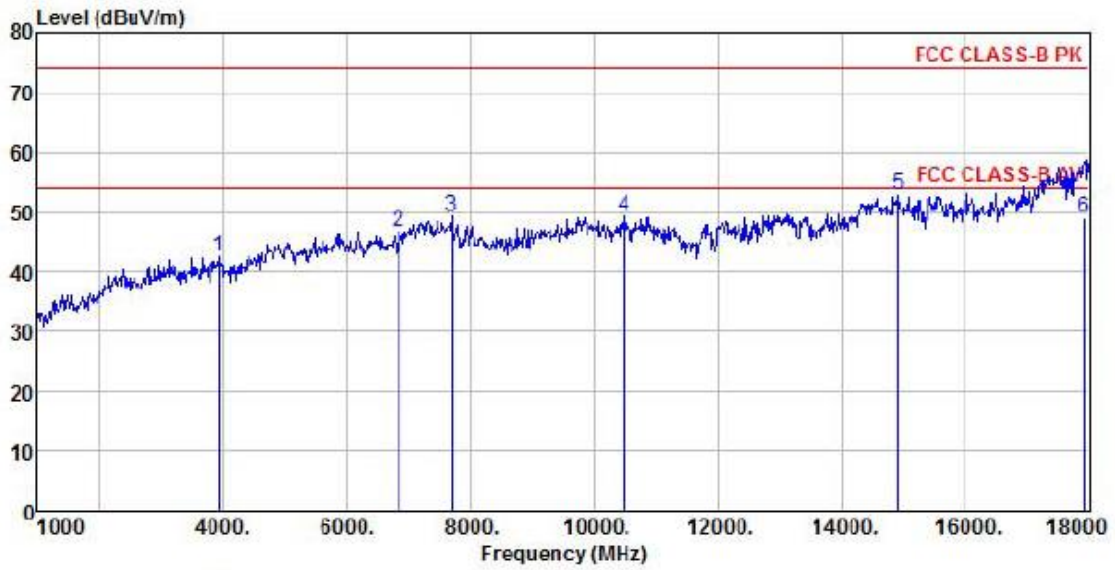

Site : chamber
 Condition : FCC CLASS-B PK 3m BBHA9120D(942) VERTICAL
 EUT :
 Model Name :
 Temp/Humi : 20 °C / 50 %
 Power Rating:
 Mode : WCDMA BAND V
 Memo :

	ReadAntenna	Cable	Preamp	Limit	Over				
Freq	Level	Factor	Loss	Factor	Level	Line	Limit	Remark	
MHz	dBuV	dB/m	dB	dB	dBuV/m	dBuV/m	dB		
1	3941.00	41.36	29.78	9.03	37.53	42.64	74.00	-31.36	Peak
2	6848.00	35.96	34.78	12.33	36.38	46.69	74.00	-27.31	Peak
3	7698.00	38.79	36.50	12.87	38.73	49.43	74.00	-24.57	Peak
4	10469.00	33.45	39.54	15.47	39.16	49.30	74.00	-24.70	Peak
5 pp	14923.00	30.63	41.33	18.75	37.78	52.93	74.00	-21.07	Peak
6	17920.00	20.02	46.80	18.89	36.84	48.87	54.00	-25.13	Average

WCDMA BAND II(IDLE)

WCDMA BAND II Normal Voltage Condition at Middle Channel

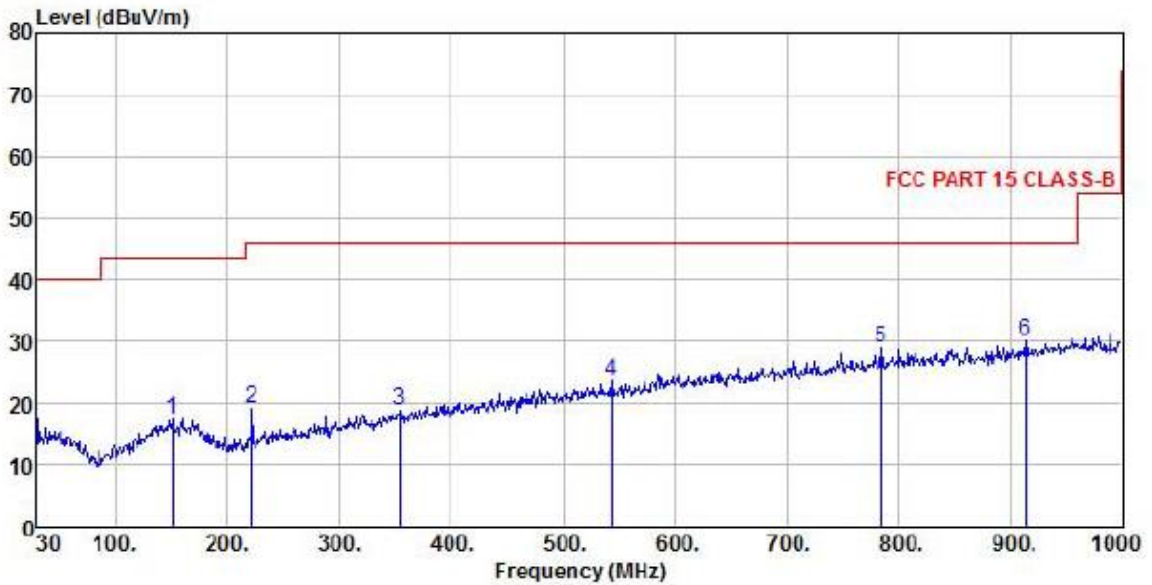

Site : chamber
 Condition : FCC PART 15 CLASS-B 3m VULB9160 HORIZONTAL
 EUT :
 Model Name :
 Temp/Humi : 20 °C / 50 %
 Power Rating:
 Mode : WCDMA BAND II
 Memo :

	ReadAntenna	Cable	Preamp	Limit	Over				
Freq	Level	Loss	Factor	Line	Limit	Remark			
MHz	dBuV	dB/m	dB	dB	dBuV/m	dBuV/m	dB		
1	150.28	1.95	13.90	1.64	0.00	17.49	43.50	-26.01	Peak
2	221.09	6.36	10.76	2.11	0.00	19.23	46.00	-26.77	Peak
3	353.98	1.91	14.31	2.60	0.00	18.82	46.00	-27.18	Peak
4	544.10	2.78	17.78	3.13	0.00	23.69	46.00	-22.31	Peak
5	784.66	3.49	21.56	3.83	0.00	28.88	46.00	-17.12	Peak
6 pp	912.70	3.19	22.75	4.08	0.00	30.02	46.00	-15.98	Peak

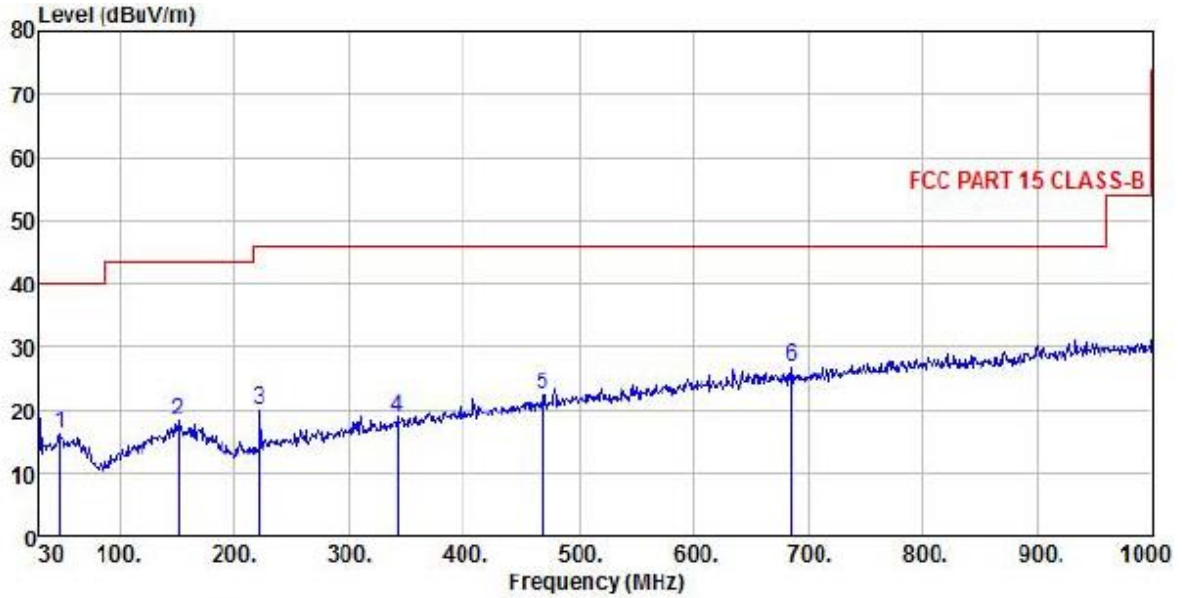

Site : chamber
 Condition : FCC PART 15 CLASS-B 3m VULB9160 VERTICAL
 EUT :
 Model Name :
 Temp/Humi : 20 °C / 50 %
 Power Rating:
 Mode : WCDMA BAND II
 Memo :

	ReadAntenna	Cable	Preamp		Limit	Over		
Freq	Level	Factor	Loss	Factor	Level	Line	Limit	Remark
MHz	dBuV	dB/m	dB	dB	dBuV/m	dBuV/m	dB	
1	47.46	2.61	12.69	0.92	0.00	16.22	40.00	-23.78 Peak
2	150.28	2.71	13.90	1.64	0.00	18.25	43.50	-25.25 Peak
3	221.09	7.28	10.76	2.11	0.00	20.15	46.00	-25.85 Peak
4	342.34	2.33	14.14	2.53	0.00	19.00	46.00	-27.00 Peak
5	469.41	2.74	16.70	2.92	0.00	22.36	46.00	-23.64 Peak
6 pp	685.72	3.20	19.97	3.59	0.00	26.76	46.00	-19.24 Peak

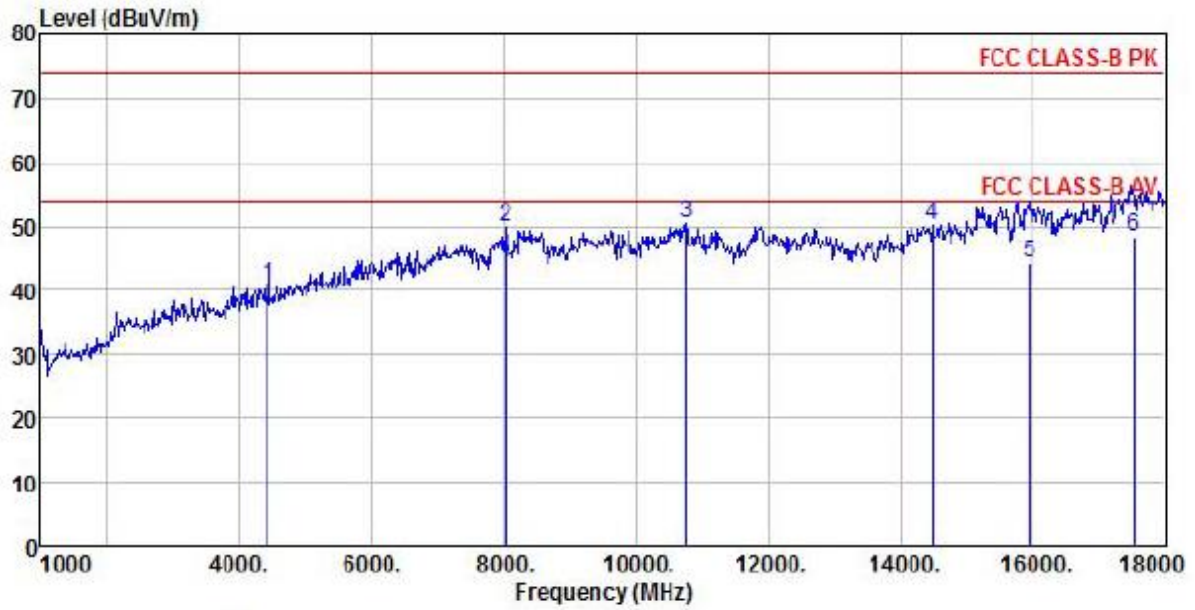

Site : chamber
 Condition : FCC CLASS-B PK 3m BBHA9120D(942) HORIZONTAL
 EUT :
 Model Name :
 Temp/Humi : 20 °C / 50 %
 Power Rating:
 Mode : WCDMA BAND II
 Memo :

	Freq	ReadAntenna	Cable	Preamp	Limit	Over		
	MHz	Level	Factor	Factor	Line	Limit	Remark	
		dBuV	dB/m	dB	dBuV/m	dBuV/m	dB	
1	4434.00	37.70	30.60	9.75	37.32	40.73	54.00	-13.27 Peak
2	8021.00	39.68	37.25	12.92	39.82	50.03	54.00	-3.97 Peak
3	pp 10758.00	33.83	39.87	15.91	39.02	50.59	54.00	-3.41 Peak
4	14481.00	27.21	42.55	18.75	38.23	50.28	54.00	-3.72 Peak
5	15943.00	27.21	37.64	17.97	38.55	44.27	54.00	-9.73 Average
6	av 17526.00	23.13	43.33	19.38	37.51	48.33	54.00	-5.67 Average

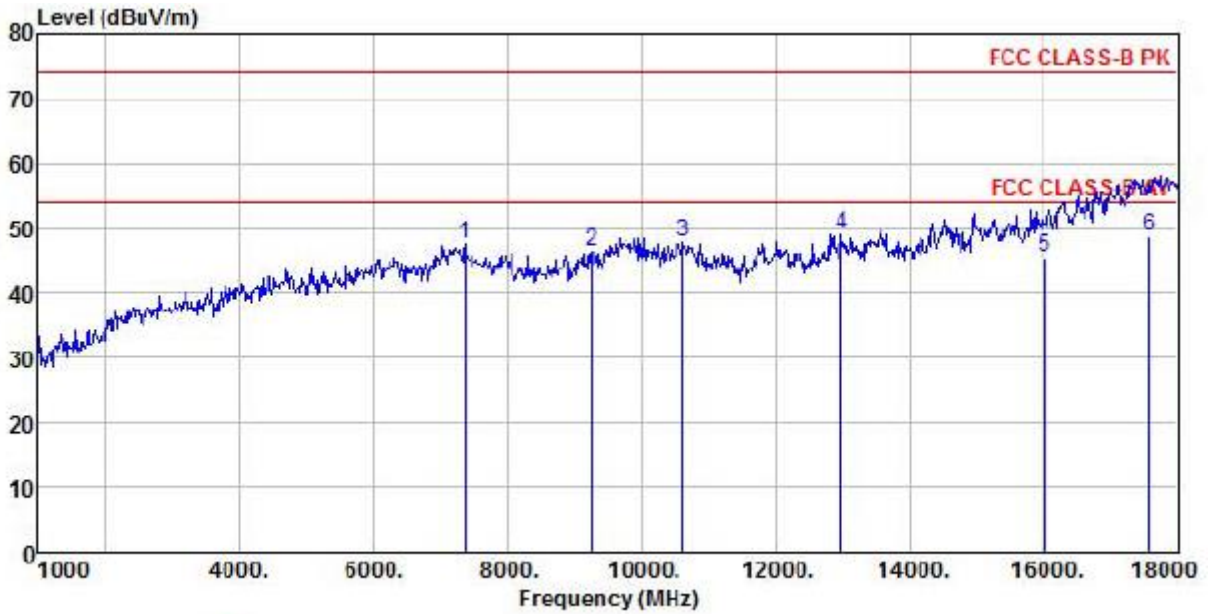

Site : chamber
 Condition : FCC CLASS-B PK 3m BBHA9120D(942) VERTICAL
 EUT :
 Model Name :
 Temp/Humi : 20 °C / 50 %
 Power Rating:
 Mode : WCDMA BAND II
 Memo :

	ReadAntenna	Cable	Preamp	Limit	Over			
Freq	Level	Factor	Loss	Factor	Level	Line	Limit	Remark
MHz	dBuV	dB/m	dB	dB	dBuV/m	dBuV/m	dB	
1	7358.00	35.88	36.49	12.84	37.55	47.66	74.00	-26.34 Peak
2	9245.00	35.28	37.79	13.98	40.77	46.28	74.00	-27.72 Peak
3	10622.00	31.85	39.66	15.36	39.09	47.78	74.00	-26.22 Peak
4 pk	12985.00	30.38	39.41	17.71	38.42	49.08	74.00	-24.92 Peak
5	16023.00	28.28	37.70	18.21	38.59	45.60	54.00	-8.40 Average
6 pp	17562.00	24.01	43.59	18.50	37.45	48.65	54.00	-5.35 Average

WCDMA BAND IV(IDLE)

WCDMA BAND IV Normal Voltage Condition at Middle Channel

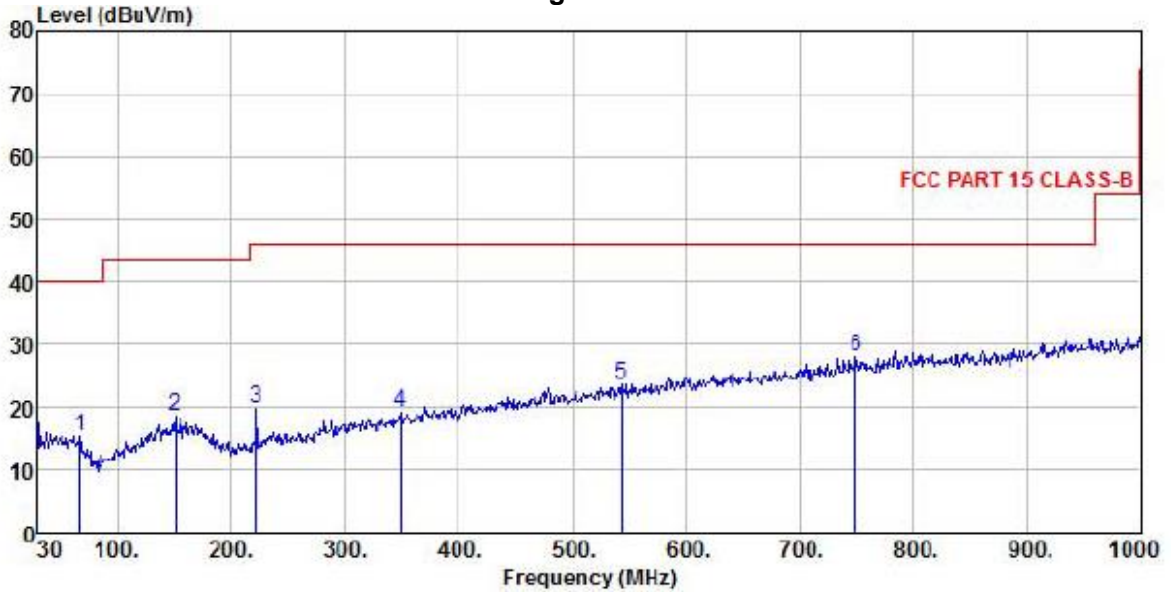

Site : chamber
 Condition : FCC PART 15 CLASS-B 3m VULB9160 HORIZONTAL
 EUT :
 Model Name :
 Temp/Humi : 20 °C / 50 %
 Power Rating:
 Mode : WCDMA BAND IV
 Memo :

		ReadAntenna	Cable	Preamp		Limit	Over	
	Freq	Level	Loss	Factor	Level	Line	Limit	Remark
	MHz	dBuV	dB/m	dB	dB	dBuV/m	dBuV/m	dB
1	66.86	2.42	11.89	1.10	0.00	15.41	40.00	-24.59 Peak
2	150.28	3.11	13.90	1.64	0.00	18.65	43.50	-24.85 Peak
3	221.09	6.77	10.76	2.11	0.00	19.64	46.00	-26.36 Peak
4	349.13	2.44	14.23	2.56	0.00	19.23	46.00	-26.77 Peak
5	544.10	2.78	17.78	3.13	0.00	23.69	46.00	-22.31 Peak
6 pp	749.74	2.94	21.35	3.80	0.00	28.09	46.00	-17.91 Peak

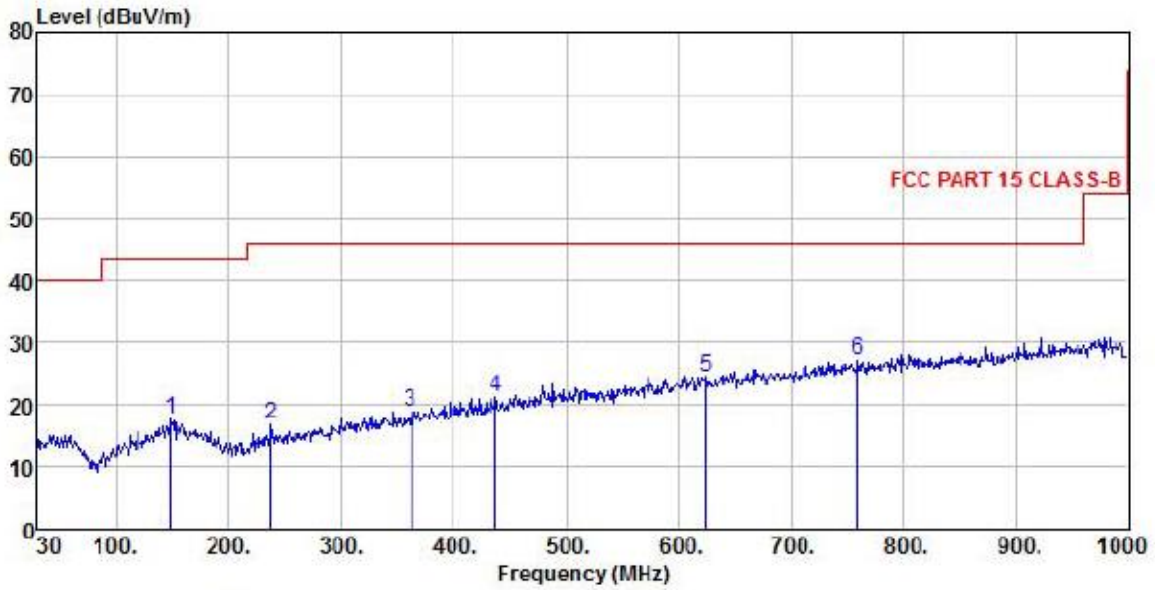

Site : chamber
 Condition : FCC PART 15 CLASS-B 3m VULB9160 VERTICAL
 EUT :
 Model Name :
 Temp/Humi : 20 °C / 50 %
 Power Rating:
 Mode : WCDMA BAND IV
 Memo :

	ReadAntenna	Cable	Preamp	Limit	Over		
Freq	Level	Factor	Loss	Factor	Level	Line	Limit Remark
MHz	dBuV	dB/m	dB	dB	dBuV/m	dBuV/m	dB
1	148.34	2.41	13.79	1.63	0.00	17.83	43.50 -25.67 Peak
2	237.58	3.00	11.61	2.11	0.00	16.72	46.00 -29.28 Peak
3	361.74	1.87	14.44	2.67	0.00	18.98	46.00 -27.02 Peak
4	437.40	2.28	16.16	2.84	0.00	21.28	46.00 -24.72 Peak
5	624.61	1.98	19.22	3.44	0.00	24.64	46.00 -21.36 Peak
6 pp	759.44	1.95	21.37	3.71	0.00	27.03	46.00 -18.97 Peak

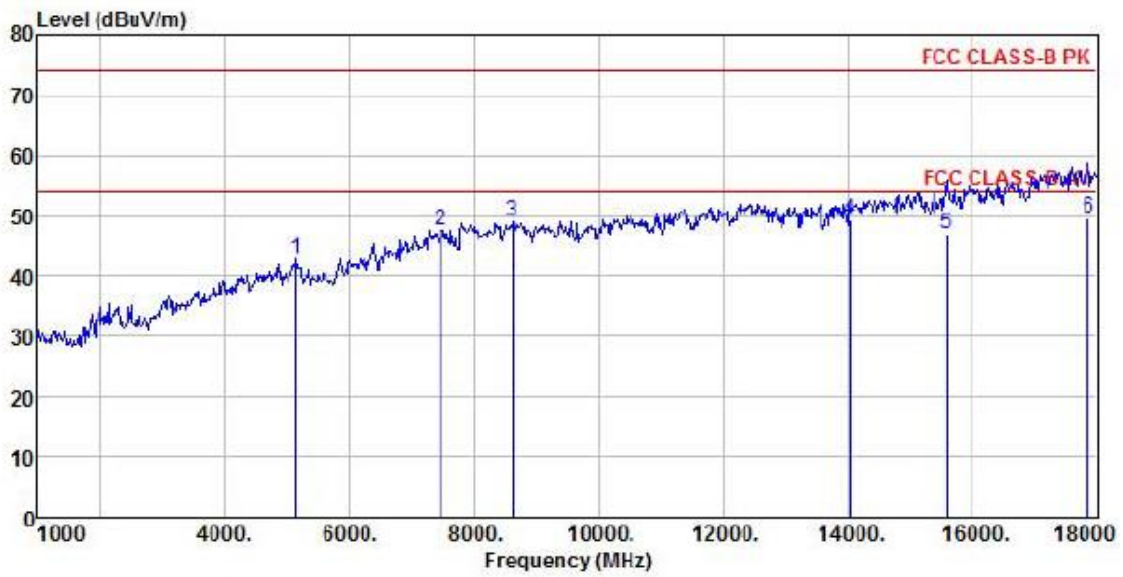

Site : chamber
 Condition : FCC CLASS-B PK 3m BBHA9120D(942) HORIZONTAL
 EUT :
 Model Name :
 Temp/Humi : 20 °C / 50 %
 Power Rating:
 Mode : WCDMA BAND IV
 Memo :

	ReadAntenna	Cable	Preamp	Limit	Over			
Freq	Level	Factor	Loss	Factor	Level	Line	Limit	Remark
MHz	dBuV	dB/m	dB	dB	dBuV/m	dBuV/m	dB	
1	5148.00	37.05	32.07	10.65	37.05	42.72	54.00	-11.28 Peak
2	7460.00	35.98	36.63	12.86	37.90	47.57	54.00	-6.43 Peak
3 pk	8616.00	39.35	36.87	13.44	40.65	49.01	54.00	-4.99 Peak
4	14025.00	28.32	41.83	17.97	38.68	49.44	54.00	-4.56 Average
5	15589.00	28.54	38.15	18.57	38.23	47.03	54.00	-6.97 Average
6 pp	17856.00	21.05	46.16	19.35	36.93	49.63	54.00	-4.37 Average

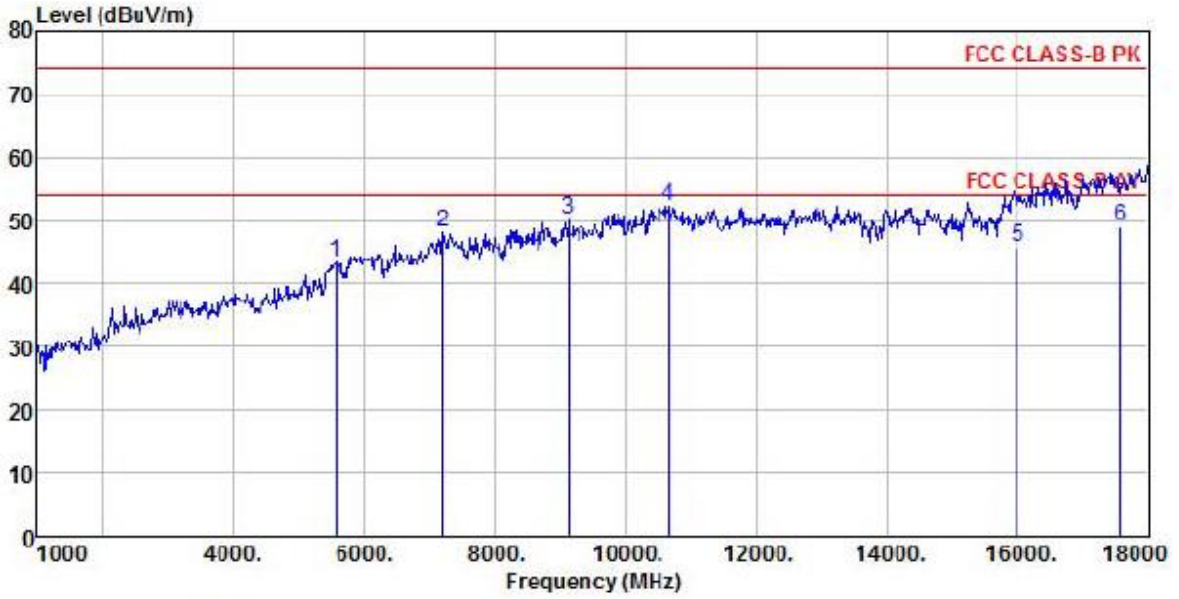

Site : chamber
 Condition : FCC CLASS-B PK 3m BBHA9120D(942) VERTICAL
 EUT :
 Model Name :
 Temp/Humi : 20 °C / 50 %
 Power Rating:
 Mode : WCDMA BAND IV
 Memo :

	ReadAntenna	Cable	Preamp		Limit	Over		
Freq	Level	Factor	Loss	Factor	Level	Line	Limit	Remark
MHz	dBuV	dB/m	dB	dB	dBuV/m	dBuV/m	dB	
1	5556.00	37.19	32.09	10.98	36.93	43.33	74.00	-30.67 Peak
2	7205.00	35.84	36.47	12.73	37.01	48.03	74.00	-25.97 Peak
3	9126.00	39.68	37.27	14.20	40.98	50.17	74.00	-23.83 Peak
4 pk	10656.00	36.60	39.68	15.19	39.07	52.40	74.00	-21.60 Peak
5	16008.00	28.51	37.68	18.22	38.60	45.81	54.00	-8.19 Average
6 pp	17562.00	24.32	43.59	18.50	37.45	48.96	54.00	-5.04 Average

10.Attachment

PHOTOGRAPHS OF TEST SETUP

Please refer to the file named "RF Setup Photos".

PHOTOGRAPHS OF EUT

Please refer to the two files named "External Photos" and " Internal Photos" .

----End of the report----