







MEASUREMENT REPORT

FCC PART 15.209

FCC ID: APV-CH1A55VOCP-5
APPLICANT: CalAmp
Application Type: Certification
Product: CalAmp SC Ion Track 5-way charger
Model No.: CH1A55VOCP-5
Trademark: 
FCC Classification: DCD (Part 15 Low Power Transmitter Below 1705 kHz)
FCC Rule Part(s): Part 15.209
Test Procedure(s): ANSI C63.10-2013
Received Date: May 21, 2019
Test Date: June 4 ~ 17, 2019

Tested By : 
(Peter Syu)
Reviewed By : 
(Paddy Chen)
Approved By : 
(Chenz Ker)



The test results only relate to the tested sample.

This equipment has been shown to be capable of compliance with the applicable technical standards as indicated in the measurement report and was tested in accordance with the measurement procedures specified in ANSI C63.10-2013. Test results reported herein relate only to the item(s) tested.

The test report shall not be reproduced except in full without the written approval of MRT Technology (Taiwan) Co., Ltd.

Revision History

Report No.	Version	Description	Issue Date	Note
1905TW0112-U2	1.0	Original Report	2019-07-03	

CONTENTS

Description	Page
§2.1033 General Information	5
1. INTRODUCTION	6
1.1. Scope.....	6
1.2. MRT Test Location.....	6
2. PRODUCT INFORMATION	7
2.1. Equipment Description.....	7
2.2. Test Mode.....	7
2.3. Test Software.....	8
2.4. Test Configuration.....	8
2.5. EMI Suppression Device(s)/Modifications.....	8
2.6. Labeling Requirements.....	8
3. DESCRIPTION of TEST	9
3.1. Evaluation Procedure.....	9
3.2. AC Line Conducted Emissions.....	9
3.3. Radiated Emissions.....	10
4. ANTENNA REQUIREMENTS	11
5. TEST EQUIPMENT CALIBRATION DATE	12
6. MEASUREMENT UNCERTAINTY	13
7. TEST RESULT	14
7.1. Summary.....	14
7.2. Radiated Spurious Emissions and Field Strength of Fundamental Emissions Measurement.....	15
7.2.1. Test Limit.....	15
7.2.2. Test Procedure Used.....	15
7.2.3. Test Setup.....	17
7.2.4. Test Result.....	18
7.3. 99% Bandwidth Measurement.....	22
7.3.1. Test Limit.....	22
7.3.2. Test Procedure Used.....	22
7.3.3. Test Setting.....	22
7.3.1. Test Setup.....	22
7.3.2. Test Result.....	23
7.4. AC Conducted Emissions Measurement.....	24

7.4.1. Test Limit24

7.4.2. Test Setup24

7.4.3. Test Result.....25

8. CONCLUSION27

§2.1033 General Information

Applicant	CalAmp
Applicant Address	2177 Salk Ave, Suite 200 Carlsbad, CA 92008
Manufacturer	CalAmp
Manufacturer Address	2177 Salk Ave, Suite 200 Carlsbad, CA 92008
Test Site	MRT Technology (Taiwan) Co., Ltd
Test Site Address	No. 38, Fuxing Second Rd., Guishan Dist., Taoyuan City 333, Taiwan (R.O.C)
MRT FCC Registration No.	291082
FCC Rule Part(s)	Part 15.209
Model No.	CH1A55VOCP-5
Test Device Serial No.	N/A <input type="checkbox"/> Production <input checked="" type="checkbox"/> Pre-Production <input type="checkbox"/> Engineering

Test Facility / Accreditations

1. MRT facility is a FCC registered (Reg. No. 291082) test facility with the site description report on file and is designated by the FCC as an Accredited Test Firm.
2. MRT facility is an IC registered (MRT Reg. No. 21723) test laboratory with the site description on file at Industry Canada.
3. MRT Lab is accredited to ISO 17025 by the Taiwan Accreditation Foundation (TAF Cert. No. 3261) in EMC, Telecommunications and Radio testing for FCC (Designation Number: TW3261), Industry Taiwan, EU and TELEC Rules.

1. INTRODUCTION

1.1. Scope

Measurement and determination of electromagnetic emissions (EMC) of radio frequency devices including intentional and/or unintentional radiators for compliance with the technical rules and regulations of the Federal Communications Commission and the Industry Canada Certification and Engineering Bureau.

1.2. MRT Test Location

The map below shows the location of the MRT LABORATORY, its proximity to the Taoyuan City. These measurement tests were conducted at the MRT Technology (Taiwan) Co., Ltd. Facility located at No.38, Fuxing 2nd Rd., Guishan Dist., Taoyuan City 33377, Taiwan (R.O.C).

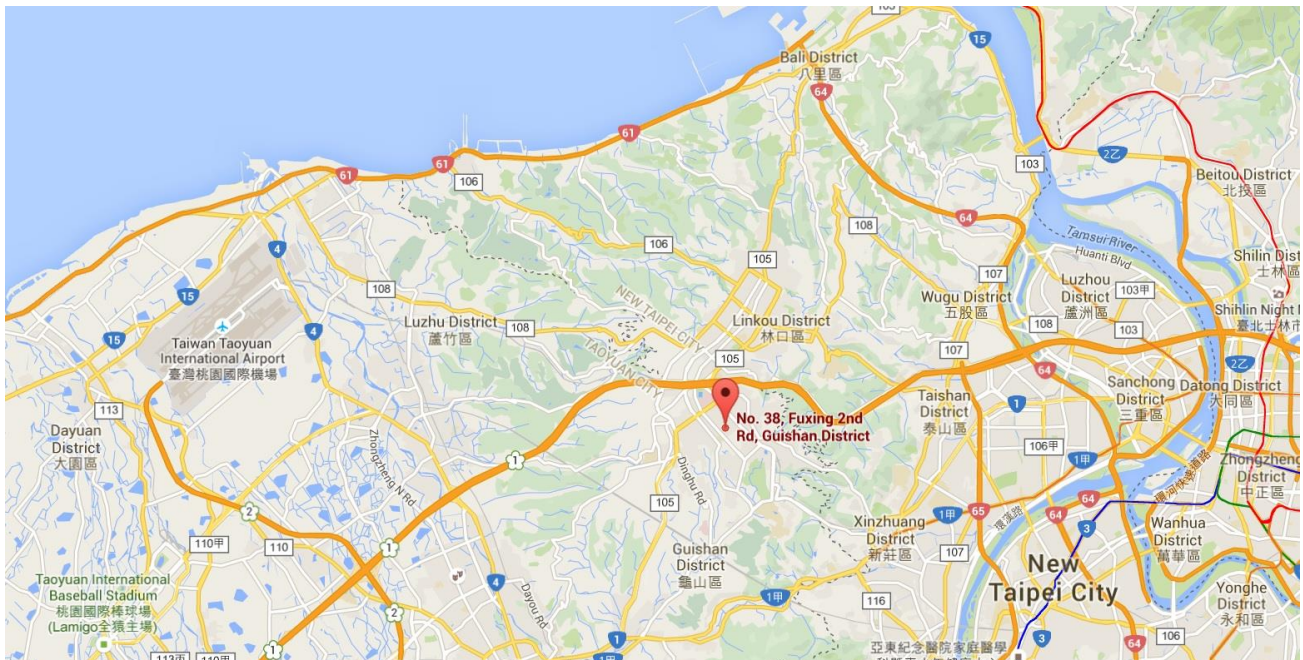

2. PRODUCT INFORMATION

2.1. Equipment Description

Product Name	CalAmp SC Ion Track 5-way charger
Model No.	CH1A55VOCP-5
Trademark	
Frequency Radios	120kHz ~ 200kHz
Modulation	ASK
Antenna Type	Loop
Specification	Input Supply Voltage: 12Vdc Input Supply Current: 3A maximum Total Charging Power: 36W Charging current: max 1000mA (4.2V battery charge) Charging power: 5W Coil diameter : 44mm Coil number of turns : 10 Coil current : 500~1000mA
Power Adapter	Brand Name: Power Pax Model: KSA-36W-120300D5 Input: AC 100-240V~1.0A, 50-60Hz Output: DC 12V-3.0A DC Cable Out Non-Shielded, 1.5m with Core*1

2.2. Test Mode

Test Mode	Mode 1: Transmit by DC 5V
-----------	---------------------------

2.3. Test Software

N/A.

2.4. Test Configuration

The **CalAmp SC Ion Track 5-way charger**, ANSI C63.10-2013 was used to reference the appropriate EUT setup for radiated spurious emissions testing and AC line conducted testing.

2.5. EMI Suppression Device(s)/Modifications

No EMI suppression device(s) were added and/or no modifications were made during testing.

2.6. Labeling Requirements

Per 2.1074 & 15.19; Docket 95-19

The label shall be permanently affixed at a conspicuous location on the device; instruction manual or pamphlet supplied to the user and be readily visible to the purchaser at the time of purchase. However, when the device is so small wherein placement of the label with specified statement is not practical, only the FCC ID must be displayed on the device per Section 15.19(a)(5). Please see attachment for FCC ID label and label location.

3. DESCRIPTION of TEST

3.1. Evaluation Procedure

The measurement procedures described in the American National Standard for Testing Unlicensed Wireless Devices (ANSI C63.10-2013) were used in the measurement of the **CalAmp SC Ion Track 5-way charger**

Deviation from measurement procedure.....None

3.2. AC Line Conducted Emissions

The line-conducted facility is located inside an 9'x4'x3' shielded enclosure. A 1m x 2m wooden table 80cm high is placed 40cm away from the vertical wall and 80cm away from the sidewall of the shielded room. Two 10kHz-30MHz, 50Ω/50uH Line-Impedance Stabilization Networks (LISNs) are bonded to the shielded room floor. Power to the LISNs is filtered by external high-current high-insertion loss power line filters. These filters attenuate ambient signal noise from entering the measurement lines. These filters are also bonded to the shielded enclosure.

The EUT is powered from one LISN and the support equipment is powered from the second LISN. All interconnecting cables more than 1 meter were shortened to a 1 meter length by non-inductive bundling (serpentine fashion) and draped over the back edge of the test table. All cables were at least 40cm above the horizontal reference ground-plane. Power cables for support equipment were routed down to the second LISN while ensuring that that cables were not draped over the second LISN.

Sufficient time for the EUT, support equipment, and test equipment was allowed in order for them to warm up to their normal operating condition. The RF output of the LISN was connected to the receiver and exploratory measurements were made to determine the frequencies producing the maximum emission from the EUT. The receiver was scanned from 150kHz to 30MHz. The detector function was set to peak mode for exploratory measurements while the bandwidth of the analyzer was set to 9kHz. The EUT, support equipment, and interconnecting cables were arranged and manipulated to maximize each emission. Each emission was also maximized by varying: power lines, the mode of operation or data exchange speed, or support equipment which determined the worst-case emission. Once the worst case emissions have been identified, the one EUT cable configuration/arrangement and mode of operation that produced these emissions are used for final measurements on the same test site. The analyzer is set to CISPR quasi-peak and average detectors with a 9kHz resolution bandwidth for final measurements.

An extension cord was used to connect to a single LISN which powered by EUT. The extension cord was calibrated with LISN, the impedance and insertion loss are compliance with the requirements as stated in ANSI C63.10-2013.

Line conducted emissions test results are shown in Section 7.6.

3.3. Radiated Emissions

The radiated test facilities consisted of an indoor 3 meter semi-anechoic chamber used for final measurements and exploratory measurements, when necessary. The measurement area is contained within the semi-anechoic chamber which is shielded from any ambient interference. For measurements above 1GHz absorbers are arranged on the floor between the turn table and the antenna mast in such a way so as to maximize the reduction of reflections. For measurements below 1GHz, the absorbers are removed. A MF Model 210SS turntable is used for radiated measurement. It is a continuously rotatable, remote controlled, metallic turntable and 2 meters (6.56 ft.) in diameter. The turn table is flush with the raised floor of the chamber in order to maintain its function as a ground plane. An 80cm high PVC support structure is placed on top of the turntable.

For all measurements, the spectrum was scanned through all EUT azimuths and from 1 to 4 meter receive antenna height using a broadband antenna from 30MHz up to the upper frequency shown in 15.33(b)(1) depending on the highest frequency generated or used in the device or on which the device operates or tunes. For frequencies above 1GHz, linearly polarized double ridge horn antennas were used. For frequencies below 30MHz, a calibrated loop antenna was used. When exploratory measurements were necessary, they were performed at 1 meter test distance inside the semi-anechoic chamber using broadband antennas, broadband amplifiers, and spectrum analyzers to determine the frequencies and modes producing the maximum emissions. Sufficient time for the EUT, support equipment, and test equipment was allowed in order for them to warm up to their normal operating condition. The test set-up for frequencies below 1GHz was placed on top of the 0.8 meter high, 1 x 1.5 meter table; and test set-up for frequencies 1-40GHz was placed on top of the 1.5 meter high, 1 x 1.5 meter table. The EUT, support equipment, and interconnecting cables were arranged and manipulated to maximize each emission. Appropriate precaution was taken to ensure that all emissions from the EUT were maximized and investigated. The system configuration, clock speed, mode of operation or video resolution, if applicable, turntable azimuth, and receive antenna height was noted for each frequency found.

Final measurements were made in the semi-anechoic chamber using calibrated, linearly polarized broadband and horn antennas. The test setup was configured to the setup that produced the worst case emissions. The spectrum analyzer was set to investigate all frequencies required for testing to compare the highest radiated disturbances with respect to the specified limits. The turntable containing the EUT was rotated through 360 degrees and the height of the receive antenna was varied 1 to 4 meters and stopped at the azimuth and height producing the maximum emission. Each emission was maximized by changing the orientation of the EUT through three orthogonal planes and changing the polarity of the receive antenna, which produced the worst-case emissions. According to 3dB Beam-Width of horn antenna, the horn antenna should be always directed to the EUT when rising height.

Radiated Emissions test results are shown in Section 7.2 & 7.3 .

4. ANTENNA REQUIREMENTS

Excerpt from §15.209 of the FCC Rules/Regulations:

“An intentional radiator antenna shall be designed to ensure that no antenna other than that furnished by the responsible party can be used with the device. The use of a permanently attached antenna or of an antenna that uses a unique coupling to the intentional radiator shall be considered sufficient to comply with the provisions of this section.”

- The antenna of **CalAmp SC Ion Track 5-way charger** is **permanently attached**.
- There are no provisions for connection to an external antenna.

Conclusion:

The **CalAmp SC Ion Track 5-way charger** unit complies with the requirement of §15.209.

5. TEST EQUIPMENT CALIBRATION DATE

Conducted Emissions – SR2

Instrument	Manufacturer	Type No.	Asset No.	Cali. Interval	Cali. Due Date
Two-Line V-Network	R&S	ENV216	MRTTWA00019	1 year	2020/3/25
Cable	Rosnol	N1C50-RG400-B 1C50-500CM	MRTTWE00013	1 year	2019/6/21
EMI Test Receiver	R&S	ESR3	MRTTWA00009	1 year	2020/3/25

Radiated Emissions – AC1

Instrument	Manufacturer	Type No.	Asset No.	Cali. Interval	Cali. Due Date
Broadband TRILOG Antenna	SCHWARZBECK	VULB 9162	MRTTWA00001	1 year	2020/6/4
EMI Test Receiver	R&S	ESR3	MRTTWA00009	1 year	2020/3/25
Active Loop Antenna	Schwarzbeck	FMZB 1519B	MRTTWA00002	1 year	2020/4/29
Broadband Horn antenna	SCHWARZBECK	BBHA 9120D	MRTTWA00003	1 year	2020/4/22
Breitband Hornantenna	Schwarzbeck	BBHA 9170	MRTTWA00004	1 year	2020/4/23
Broadband Amplifier	Schwarzbeck	BBV 9721	MRTTWA00006	1 year	2020/4/24
Broadband Preampfier	SCHWARZBECK	BBV 9718	MRTTWA00005	1 year	2020/4/24
Cable	HUBERSUHNER	SF106	MRTTWA00010	1 year	2019/6/18
Cable	Rosnol	K1K50-UP0264- K1K50-4M	MRTTWA00012	1 year	2019/7/30

Test Software

Software	Version	Function
e3	9.160520a	EMI Test Software
EMI	V3	EMI Test Software

6. MEASUREMENT UNCERTAINTY

Where relevant, the following test uncertainty levels have been estimated for tests performed on the EUT as specified in CISPR 16-4-2. This uncertainty represents an expanded uncertainty expressed at approximately the 95% confidence level using a coverage factor of $k = 2$.

AC Conducted Emission Measurement – SR2
Measuring Uncertainty for a Level of Confidence of 95% ($U=2Uc(y)$): 150kHz~30MHz: 2.42dB
Conducted Measurement– SR1
Measuring Uncertainty for a Level of Confidence of 95% ($U=2Uc(y)$): 1.3dB
Radiated Emission Measurement – AC1
Measuring Uncertainty for a Level of Confidence of 95% ($U=2Uc(y)$): Horizontal: 9K~30MHz: 4.14dB 30MHz~1GHz: 4.22dB 1GHz~40GHz: 4.05dB Vertical: 9K~30MHz: 4.14dB 30MHz~1GHz: 3.37dB 1GHz~40GHz: 4.08dB

7. TEST RESULT

7.1. Summary

Product Name: CalAmp SC Ion Track 5-way charger

FCC Classification: DCD (For 115kHz – 205kHz Only)

FCC Part Section(s)	Test Description	Test Limit	Test Condition	Test Result	Reference
15.209	Radiated Spurious Emissions and Field Strength of Fundamental Emissions	FCC 15.209 limits	Radiated	Pass	Section 7.2
2.1049	99% Bandwidth	N/A		Pass	Section 7.3
15.207	AC Conducted Emissions 150kHz - 30MHz	FCC 15.207 limits	Line Conducted	Pass	Section 7.4

Notes:

- 1) Determining compliance is based on the test results met the regulation limits or requirements declared by clients, and the test results don't take into account the value of measurement uncertainty.
- 2) All modes of operation and data rates were investigated. For radiated emission test, every axis (X, Y, Z) was also verified. The test results shown in the following sections represent the worst case emissions.
- 3) The analyzer plots shown in this section were all taken with a correction table loaded into the analyzer. The correction table was used to account for the losses of the cables and attenuators used as part of the system to connect the EUT to the analyzer at all frequencies of interest.
- 4) All antenna port conducted emissions testing was performed on a test bench with the antenna port of the EUT connected to the spectrum analyzer through calibrated cables and attenuators.

7.2. Radiated Spurious Emissions and Field Strength of Fundamental Emissions Measurement

7.2.1. Test Limit

All out of band emissions appearing in a restricted band as specified in Section 15.209 of the Title 47 CFR must not exceed the limits shown in Table per Section 15.209.

FCC Part 15 Subpart C Paragraph 15.209		
Frequency [MHz]	Field Strength [V/m]	Measured Distance [Meters]
0.009 - 0.490	2400/F (kHz)	300
0.490 - 1.705	24000/F (kHz)	30
1.705 - 30	30	30
30 - 88	100	3
88 - 216	150	3
216 - 960	200	3
Above 960	500	3

Note : The emission limits shown in the above table are based on measurements employing a CISPR quasi-peak detector except for the frequency bands 9-90 kHz, 110-490 kHz and above 1000 MHz. Radiated emission limits in these three bands are based on measurements employing an average detector.

7.2.2. Test Procedure Used

ANSI C63.10 - Section 11.12.2.3 (quasi-peak measurements)

ANSI C63.10 - Section 11.12.2.4 (peak power measurements)

ANSI C63.10 - Section 11.12.2.5 (average power measurements)

Test Setting

Peak Power Measurement

1. Analyzer center frequency was set to the frequency of the radiated spurious emission of interest
2. RBW = as specified in Table 1
3. VBW = 3 × RBW
4. Detector = peak
5. Sweep time = auto couple

Table 1 - RBW as a function of frequency

Frequency	RBW
9 kHz ~ 150 kHz	200 Hz ~ 300 Hz
0.15 MHz ~ 30 MHz	9 kHz ~ 10 kHz
30 MHz ~ 1000 MHz	100 kHz ~ 120 kHz
> 1000 MHz	1 MHz

7.2.3. Test Setup

9kHz ~ 30MHz Test Setup:

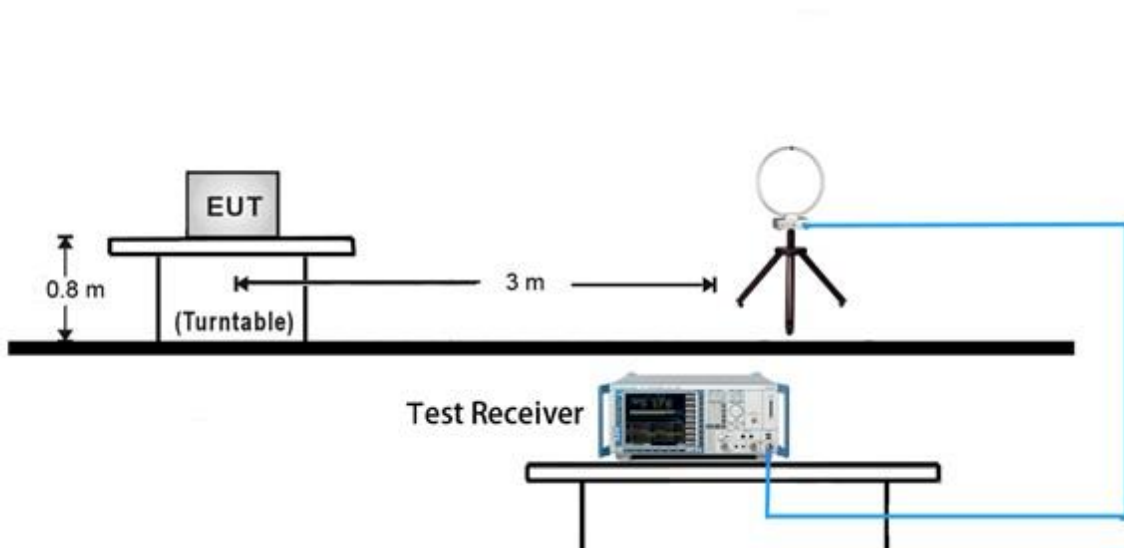

30MHz ~ 1GHz Test Setup:

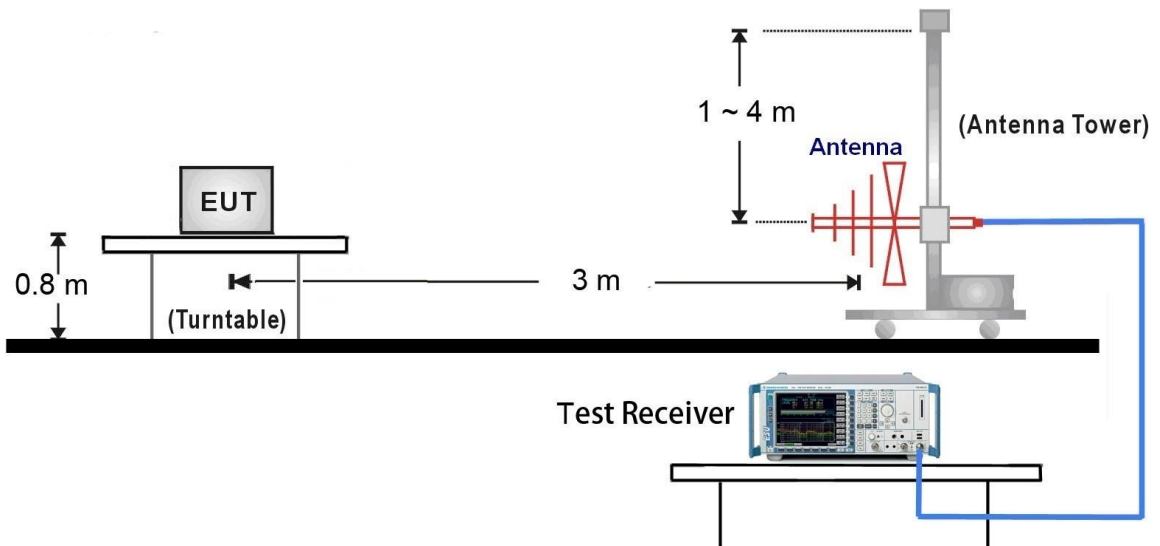

7.2.4. Test Result

EUT	CalAmp SC Ion Track 5-way charger	Date of Test	2019/6/4
Factor	FMZB 1519B	Temp. / Humidity	25°C / 57%
Polarity	--	Site / Test Engineer	AC1 / Peter
Test Mode	Mode1	Test Voltage	AC 120V/60Hz

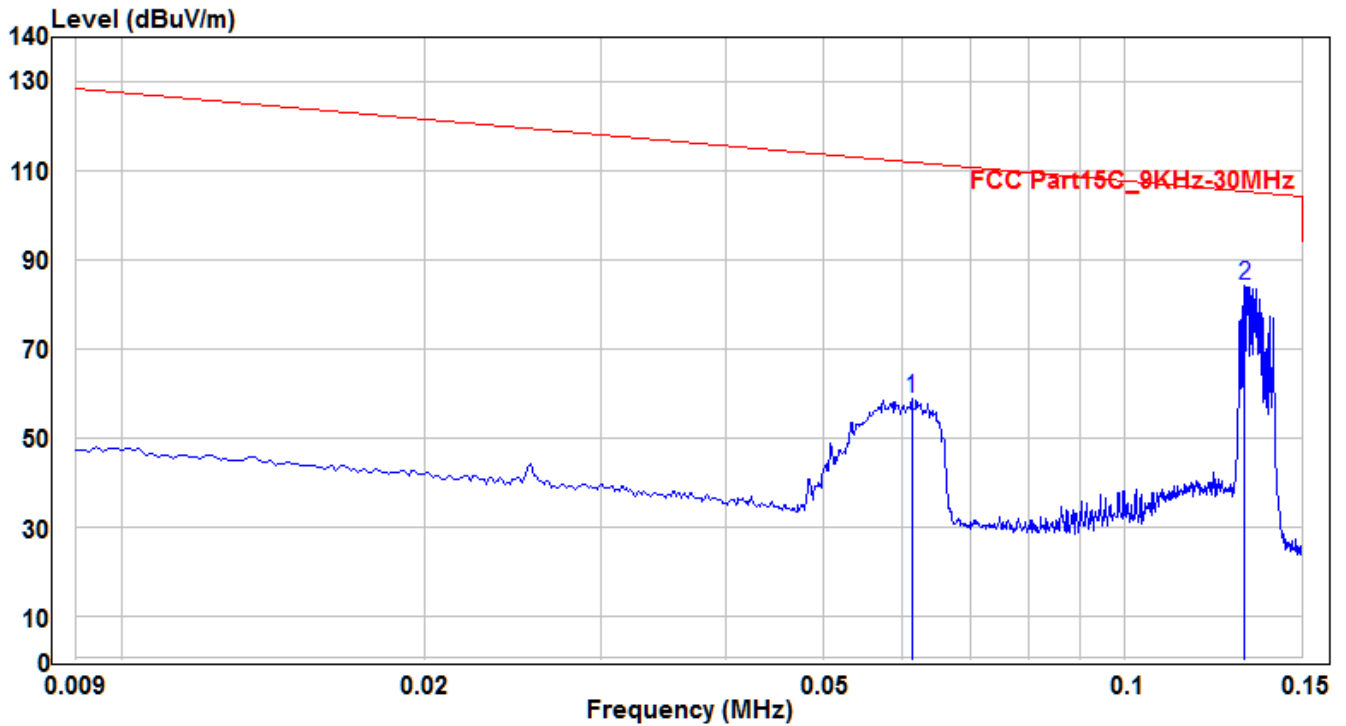

No	Frequency (MHz)	Reading (dBuV)	C.F (dB)	Measurement (dBuV/m)	Margin (dB)	Limit (dBuV)	Height (cm)	Angle (deg)	Remark (QP/PK/AV)
1	0.06131	40.18	18.77	58.95	-52.9	111.85	100	400	Peak
2	* 0.13153	65.71	18.36	84.07	-21.15	105.22	100	400	Peak

Note:

1. " *", means this data is the worst emission level.
2. C.F (Correction Factor) = Antenna Factor (dB)+ Cable Loss (dB)
3. Measurement (dBuV/m) = Reading(dBuV) + C.F (Correction Factor)

EUT	CalAmp SC Ion Track 5-way charger	Date of Test	2019/6/4
Factor	FMZB 1519B	Temp. / Humidity	25°C / 57%
Polarity	--	Site / Test Engineer	AC1 / Peter
Test Mode	Mode1	Test Voltage	AC 120V/60Hz

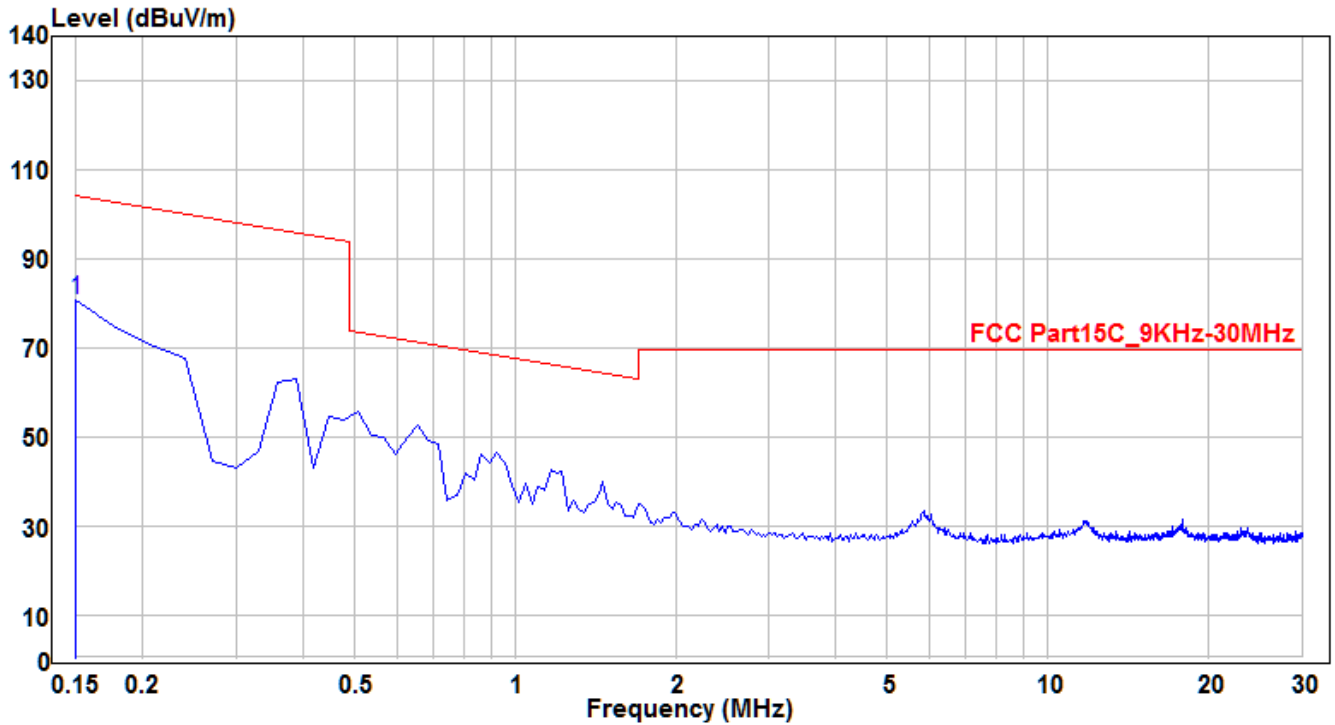

No	Frequency (MHz)	Reading (dBuV)	C.F (dB)	Measurement (dBuV/m)	Margin (dB)	Limit (dBuV)	Height (cm)	Angle (deg)	Remark (QP/PK/AV)
1	*	62.57	18.39	80.96	-23.12	104.08	100	400	Peak

Note:

1. " *", means this data is the worst emission level.
2. C.F (Correction Factor) = Antenna Factor (dB)+ Cable Loss (dB)
3. Measurement (dBuV/m) = Reading(dBuV) + C.F (Correction Factor)

EUT	CalAmp SC Ion Track 5-way charger	Date of Test	2019/6/17
Factor	VULB 9162	Temp. / Humidity	25°C / 57%
Polarity	Horizontal	Site / Test Engineer	AC1 / Peter
Test Mode	Mode1	Test Voltage	AC 120V/60Hz

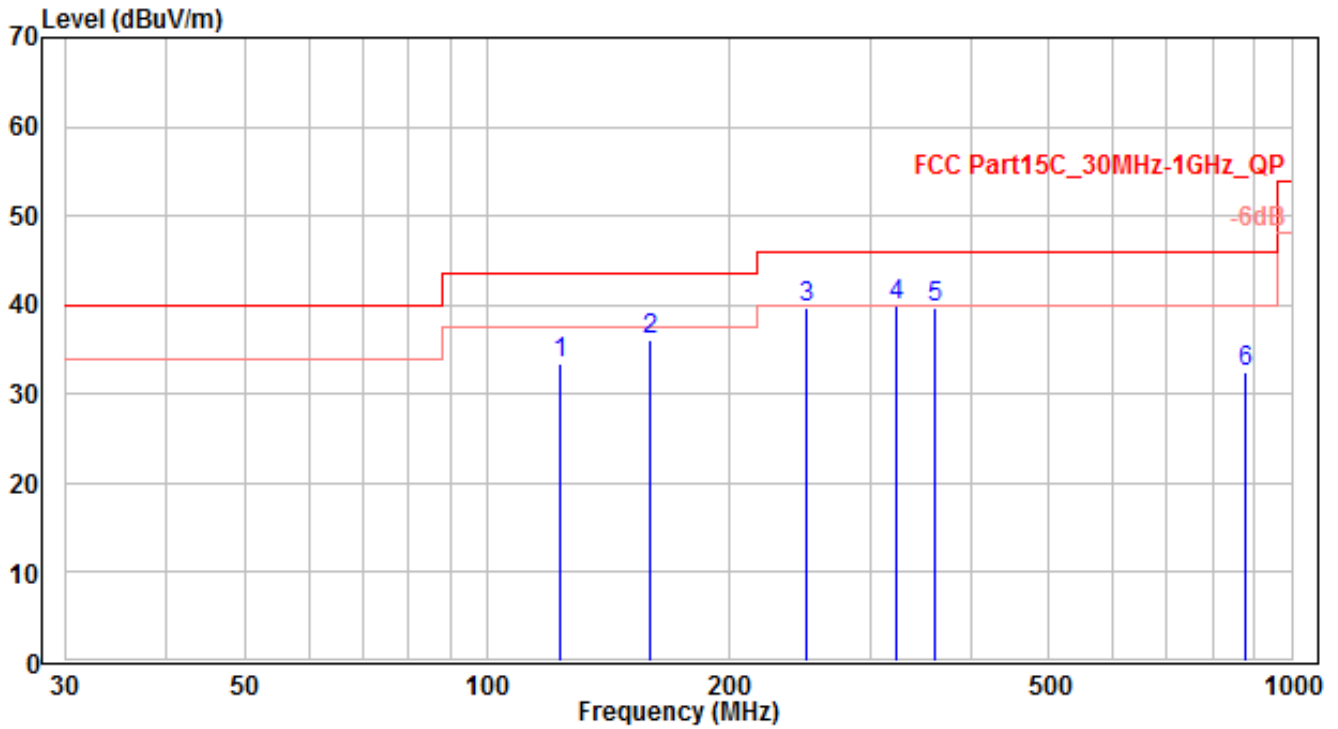

No	Frequency (MHz)	Reading (dBuV)	C.F (dB)	Measurement (dBuV/m)	Margin (dB)	Limit (dBuV)	Height (cm)	Angle (deg)	Remark (QP/PK/AV)
1	123.091	16.82	16.64	33.46	-10.04	43.5	100	25	QP
2	159.431	20.1	16.1	36.2	-7.3	43.5	110	5	QP
3	249.916	19.04	20.54	39.58	-6.42	46	100	55	QP
4	* 322.262	17.52	22.31	39.83	-6.17	46	100	0	QP
5	360.722	16.11	23.59	39.7	-6.3	46	110	200	QP
6	875.356	1.09	31.38	32.47	-13.53	46	110	155	QP

Note:

1. " *", means this data is the worst emission level.
2. C.F (Correction Factor) = Antenna Factor (dB)+ Cable Loss (dB)
3. Measurement (dBuV/m) = Reading(dBuV) + C.F (Correction Factor)

EUT	CalAmp SC Ion Track 5-way charger	Date of Test	2019/6/17
Factor	VULB 9162	Temp. / Humidity	25°C / 57%
Polarity	Vertical	Site / Test Engineer	AC1 / Peter
Test Mode	Mode1	Test Voltage	AC 120V/60Hz

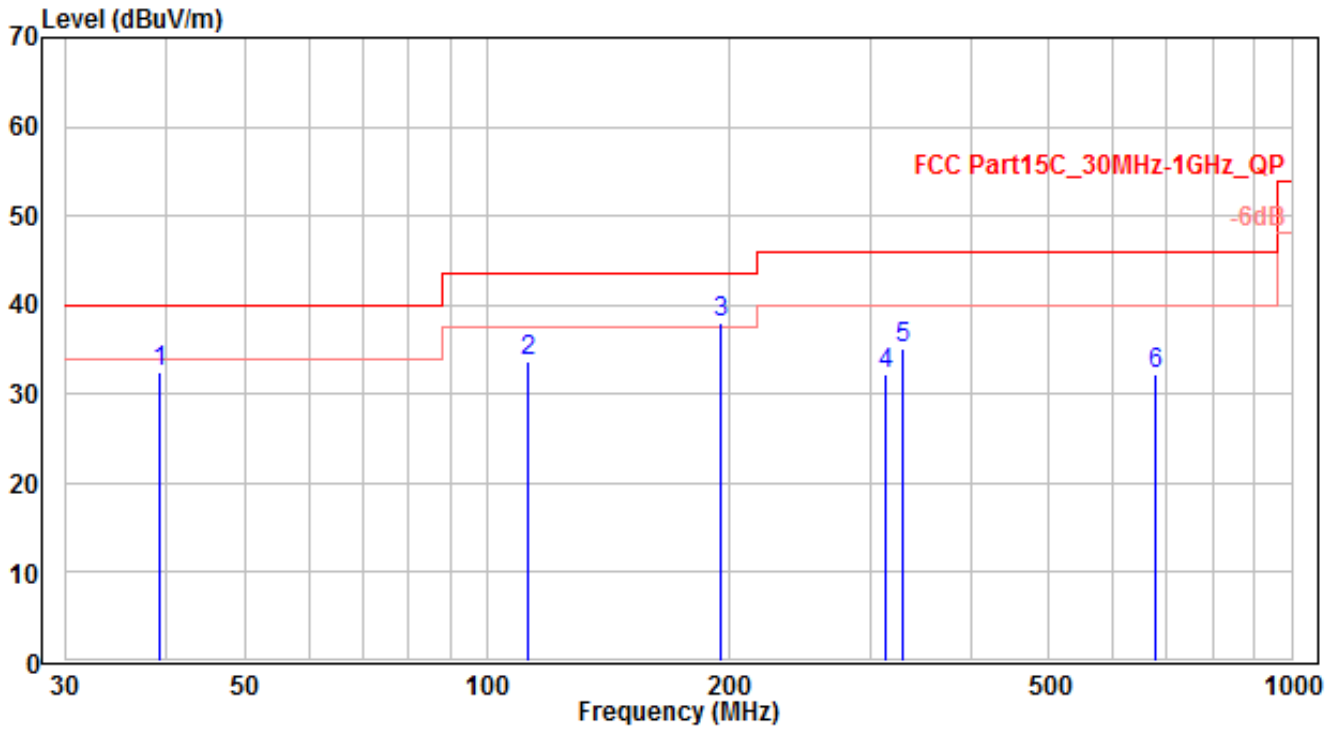

No	Frequency (MHz)	Reading (dBuV)	C.F (dB)	Measurement (dBuV/m)	Margin (dB)	Limit (dBuV)	Height (cm)	Angle (deg)	Remark (QP/PK/AV)
1	39.111	12.15	20.37	32.52	-7.48	40	120	50	QP
2	112.251	15.33	18.31	33.64	-9.86	43.5	120	150	QP
3	* 195.125	19.22	18.83	38.05	-5.45	43.5	110	140	QP
4	312.951	10.2	21.92	32.12	-13.88	46	100	160	QP
5	328.215	12.52	22.54	35.06	-10.94	46	100	180	QP
6	677.11	3.32	28.8	32.12	-13.88	46	150	150	QP

Note:

1. " *", means this data is the worst emission level.
2. C.F (Correction Factor) = Antenna Factor (dB)+ Cable Loss (dB)
3. Measurement (dBuV/m) = Reading(dBuV) + C.F (Correction Factor)

7.3. 99% Bandwidth Measurement

7.3.1. Test Limit

N/A

7.3.2. Test Procedure Used

FCC Part 2.1049 / ANSI 63.10 6.9.3

7.3.3. Test Setting

The occupied bandwidth is the frequency bandwidth such that, below its lower and above its upper frequency limits, the mean powers are each equal to 0.5% of the total mean power of the given emission. The following procedure shall be used for measuring 99% power bandwidth:

- a) The instrument center frequency is set to the nominal EUT channel center frequency. The frequency span for the spectrum analyzer shall be between 1.5 times and 5.0 times the OBW.
- b) The nominal IF filter bandwidth (3 dB RBW) shall be in the range of 1% to 5% of the OBW, and VBW shall be approximately three times the RBW, unless otherwise specified by the applicable requirement.
- c) Set the reference level of the instrument as required, keeping the signal from exceeding the maximum input mixer level for linear operation. In general, the peak of the spectral envelope shall be more than $[10 \log (OBW/RBW)]$ below the reference level.
- d) Step a) through step c) might require iteration to adjust within the specified range.
- e) Video averaging is not permitted. Where practical, a sample detection and single sweep mode shall be used. Otherwise, peak detection and max hold mode (until the trace stabilizes) shall be used.
- f) Use the 99% power bandwidth function of the instrument (if available) and report the measured bandwidth.

7.3.1. Test Setup

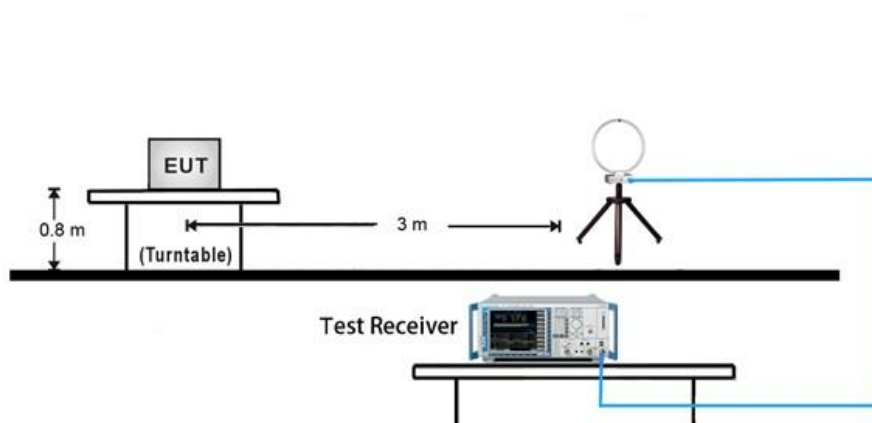

7.3.2. Test Result

Test Mode	Frequency (kHz)	99% Bandwidth (kHz)
WPC	131.45	6.91

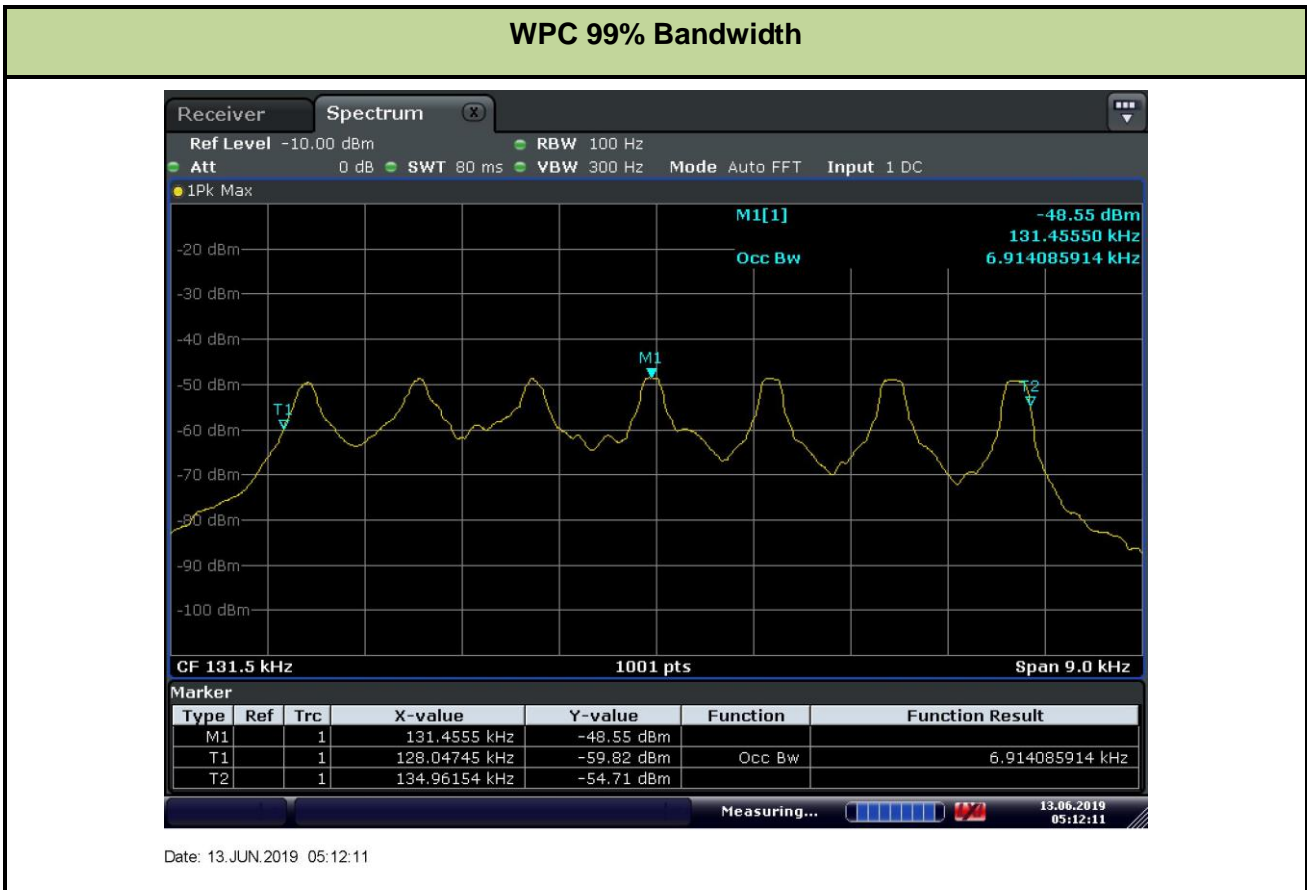

7.4. AC Conducted Emissions Measurement

7.4.1. Test Limit

FCC Part 15 Subpart C Paragraph 15.207 Limits		
Frequency (MHz)	QP (dBuV)	AV (dBuV)
0.15 - 0.50	66 - 56	56 - 46
0.50 - 5.0	56	46
5.0 - 30	60	50

Note 1: The lower limit shall apply at the transition frequencies.

Note 2: The limit decreases linearly with the logarithm of the frequency in the range 0.15MHz to 0.5MHz.

7.4.2. Test Setup

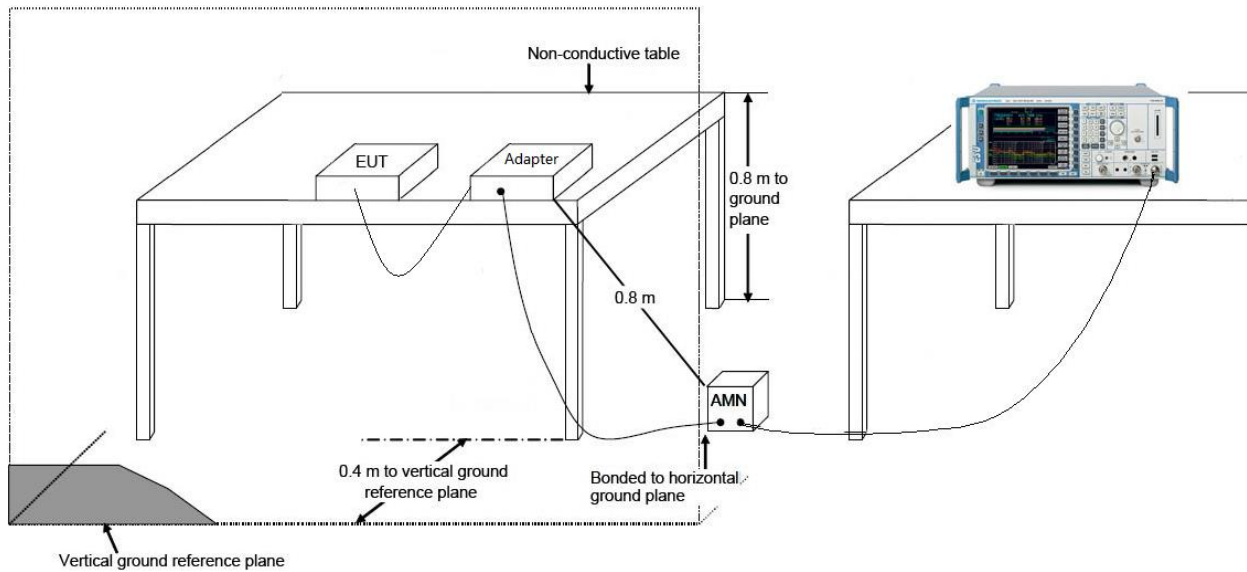

7.4.3. Test Result

EUT	CalAmp SC Ion Track 5-way charger	Date of Test	2019/6/12
Factor	CE_ENV216-L1 (Filter ON)	Temp. / Humidity	24°C / 68%
Polarity	Line1	Site / Test Engineer	SR2 / Peter
Test Mode	Mode1	Test Voltage	AC 120V/60Hz

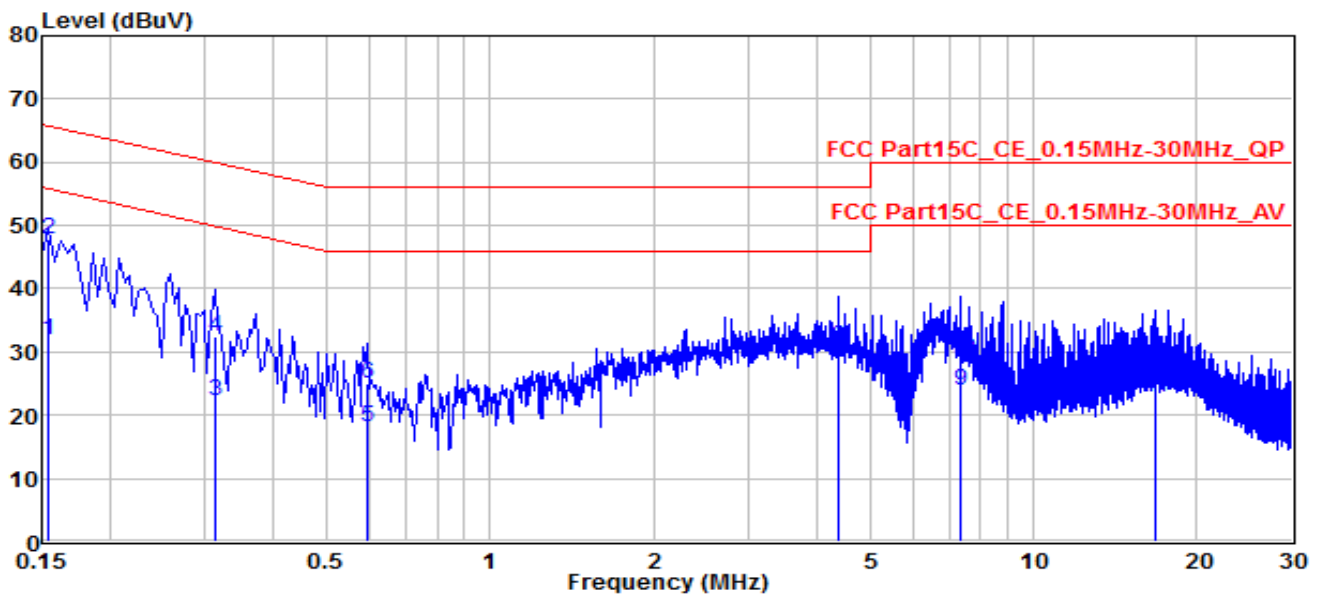

No	Frequency (MHz)	Reading (dBuV)	C.F (dB)	Measurement (dBuV)	Margin (dB)	Limit (dBuV)	Remark (QP/PK/AV)
1	0.1545	22.22	9.6	31.82	-23.93	55.75	Average
2	0.1545	38.13	9.6	47.73	-18.02	65.75	QP
3	0.31198	12.79	9.61	22.4	-27.52	49.92	Average
4	0.31198	22.91	9.61	32.52	-27.4	59.92	QP
5	0.59546	8.51	9.61	18.12	-27.88	46	Average
6	0.59546	15.34	9.61	24.95	-31.05	56	QP
7	*	4.375	9.73	29.25	-16.75	46	Average
8	*	4.375	9.73	30.82	-25.18	56	QP
9	7.345	14.2	9.8	24	-26	50	Average
10	7.345	19.11	9.8	28.91	-31.09	60	QP
11	16.798	12.88	9.96	22.84	-27.16	50	Average
12	16.798	16.69	9.96	26.65	-33.35	60	QP

Note:

- "*", means this data is the worst emission level.
- C.F (Correction Factor) = Factor (dB)+ Cable Loss (dB)
- Measurement (dBuV) = Reading(dBuV)+ C.F (Correction Factor)

EUT	CalAmp SC Ion Track 5-way charger	Date of Test	2019/6/12
Factor	CE_ENV216-N (Filter ON)	Temp. / Humidity	24°C / 68%
Polarity	Neutral	Site / Test Engineer	SR2 / Peter
Test Mode	Mode1	Test Voltage	AC 120V/60Hz

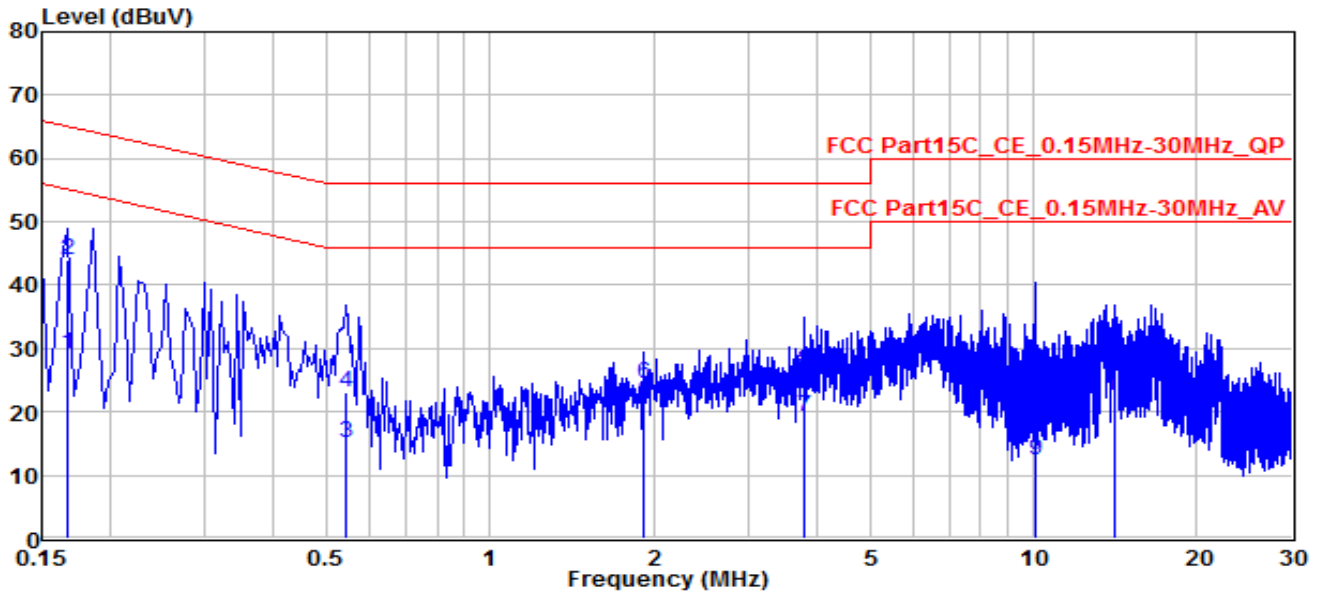

No		Frequency (MHz)	Reading (dBuV)	C.F (dB)	Measurement (dBuV)	Margin (dB)	Limit (dBuV)	Remark (QP/PK/AV)
1	*	0.168	19.42	9.61	29.03	-26.03	55.06	Average
2	*	0.168	34.43	9.61	44.04	-21.02	65.06	QP
3		0.54596	5.48	9.61	15.09	-30.91	46	Average
4		0.54596	13.55	9.61	23.16	-32.84	56	QP
5		1.927	11.59	9.68	21.27	-24.73	46	Average
6		1.927	14.83	9.68	24.51	-31.49	56	QP
7		3.799	9.66	9.71	19.37	-26.63	46	Average
8		3.799	16.58	9.71	26.29	-29.71	56	QP
9		10.085	2.59	9.89	12.48	-37.52	50	Average
10		10.085	11.73	9.89	21.62	-38.38	60	QP
11		14.162	12.72	9.95	22.67	-27.33	50	Average
12		14.162	17.21	9.95	27.16	-32.84	60	QP

Note:

1. " *", means this data is the worst emission level.
2. C.F (Correction Factor) = Factor (dB)+ Cable Loss (dB)
3. Measurement (dBuV) = Reading(dBuV)+ C.F (Correction Factor)

8. CONCLUSION

The data collected relate only the item(s) tested and show that the **CalAmp SC Ion Track 5-way charger** is in compliance with Part 15.209 of the FCC Rules.

————— The End —————