



America

**Choose certainty.
Add value.**

Report On

Application for Grant of Equipment Authorization of the
CalAmp Wireless Networks Corp.
CalAmp BlueBoard Bluetooth Daughter Board

FCC Part 15 Subpart C §15.247 (FHSS)
RSS-247 Issue 1 May 2015

Report No. SD72115091-0316B

March 2016



REPORT ON Radio Testing of the
CalAmp Wireless Networks Corp.
Bluetooth Daughter Board

TEST REPORT NUMBER SD72115091-0316B

PREPARED FOR CalAmp Wireless Networks Corp.
2177 Salk Ave, Suite 200
San Diego, CA 92008

CONTACT PERSON Imad Rizk
Carrier& Product Certification Manager
(760) 814-9697
IRizk@CalAmp.com

PREPARED BY 
Ferdinand S. Custodio
Name
Authorized Signatory
Title: EMC/Senior Wireless Test Engineer

APPROVED BY 
Chip R. Fleury
Name
Authorized Signatory
Title: West Coast EMC Manager

DATED March 09, 2016



Revision History

SD72115091-0316B CalAmp Wireless Networks Corp. CalAmp BlueBoard Bluetooth Daughter Board					
DATE	OLD REVISION	NEW REVISION	REASON	PAGES AFFECTED	APPROVED BY
03/09/2016	Initial Release				Chip R. Fleury



CONTENTS

Section	Page No
1	REPORT SUMMARY 5
1.1	Introduction 6
1.2	Brief Summary Of Results 7
1.3	Product Information 8
1.4	EUT Test Configuration 12
1.5	Deviations From The Standard 14
1.6	Modification Record 14
1.7	Test Methodology 14
1.8	Test Facility Location 14
1.9	Test Facility Registration 14
2	TEST DETAILS 16
2.1	Conducted Emissions 17
2.2	Carrier Frequency Separation 18
2.3	Number Of Hopping Frequencies 20
2.4	Time Of Occupancy (Dwell Time) 22
2.5	20 dB Bandwidth 27
2.6	99% Emission Bandwidth 33
2.7	Peak Output Power 40
2.8	Band-Edge Compliance Of RF Conducted Emissions 42
2.9	Spurious RF Conducted Emissions 49
2.10	Spurious Radiated Emissions 55
2.11	Radiated Immediate Restricted Bands 63
3	TEST EQUIPMENT USED 69
3.1	Test Equipment Used 70
3.2	Measurement Uncertainty 71
4	DIAGRAM OF TEST SETUP 72
4.1	Test Setup Diagram 73
5	ACCREDITATION, DISCLAIMERS AND COPYRIGHT 75
5.1	Accreditation, Disclaimers and Copyright 76



SECTION 1

REPORT SUMMARY

Radio Testing of the
CalAmp Wireless Networks Corp.
Bluetooth Daughter Board



1.1 INTRODUCTION

The information contained in this report is intended to show verification of the CalAmp Wireless Networks Corp. CalAmp BlueBoard Bluetooth Daughter Board to the requirements of FCC Part 15 Subpart C §15.247 and RSS-247 Issue 1 May 2015.

Objective	To perform Radio Testing to determine the Equipment Under Test's (EUT's) compliance with the Test Specification, for the series of tests carried out.
Manufacturer	CalAmp Wireless Networks Corp.
Model Number(s)	BRD01
FCC ID Number	APV-BRD01
IC Number	5843C-BRD01
Serial Number(s)	N/A
Number of Samples Tested	2
Test Specification/Issue/Date	<ul style="list-style-type: none">• FCC Part 15 Subpart C §15.247 (October 1, 2015).• RSS-247 Issue 1 May 2015 - Digital Transmission Systems (DTSS), Frequency Hopping Systems (FHSs) and Licence-Exempt Local Area Network (LE-LAN) Devices.• RSS-Gen - General Requirements for Compliance of Radio Apparatus (Issue 4, November 2014).• Public Notice (DA 00-705 Released March 30, 2000) Filing and Measurement Guidelines for Frequency Hopping Spread Spectrum Systems.• ANSI C63.10-2013. American National Standard of Procedures for Compliance Testing of Unlicensed Wireless Devices
Start of Test	February 25, 2016
Finish of Test	March 08, 2016
Name of Engineer(s)	Ferdinand Custodio
Related Document(s)	None. Supporting documents for EUT certification are separate exhibits.



1.2 **BRIEF SUMMARY OF RESULTS**

A brief summary of the tests carried out in accordance with FCC Part 15 Subpart C §15.247 with cross-reference to the corresponding IC RSS standard is shown below.

Section	§15.247 Spec Clause	RSS	Test Description	Result	Comments/ Base Standard
2.1	§15.207 (a)	RSS-Gen 8.8	Conducted Emissions	Compliant	
2.2	§15.247(a)(1)	RSS-247 Clause 5.1(2)	Carrier Frequency Separation	Compliant	
2.3	§15.247(a)(1)(iii)	RSS-247 Clause 5.4(4)	Number of Hopping Frequencies	Compliant	
2.4	§15.247(a)(1)(iii)	RSS-247 Clause 5.4(4)	Time of Occupancy (Dwell Time)	Compliant	
2.5	§15.215(c)	RSS-247 Clause 5.1(1)	20 dB Bandwidth	Compliant	
2.6		RSS-Gen 6.6	99% Emission Bandwidth	Compliant	
2.7	§15.247(b)(1)	RSS-247 Clause 5.4(2)	Peak Output Power	Compliant	
2.8	§15.247(d)	RSS-247 Clause 5.5	Band-edge Compliance of RF Conducted Emissions	Compliant	
2.9	§15.247(d)	RSS-247 Clause 5.5	Spurious RF Conducted Emissions	Compliant	
2.10	§15.247(d)	RSS-Gen 8.9 and 8.10	Spurious Radiated Emissions	Compliant	
2.11	§15.247(d)	RSS-Gen 8.9 and 8.10	Radiated Immediate Restricted Bands	Compliant	

1.3 PRODUCT INFORMATION

1.3.1 Technical Description

The Equipment Under Test (EUT) was an CalAmp Wireless Networks Corp. CalAmp BlueBoard Bluetooth Daughter Board as shown in the photograph below. The EUT is a Bluetooth module used as an option to add Bluetooth connectivity to CalAmp Devices. The EUT when installed in Calamp LMU/TTU products provides wireless connectivity for programming and configuration purposes. Without this option, LMU/TTU products need to be connected via a serial cable. This can be done inside the vehicle or by physically removing the unit from the vehicle.

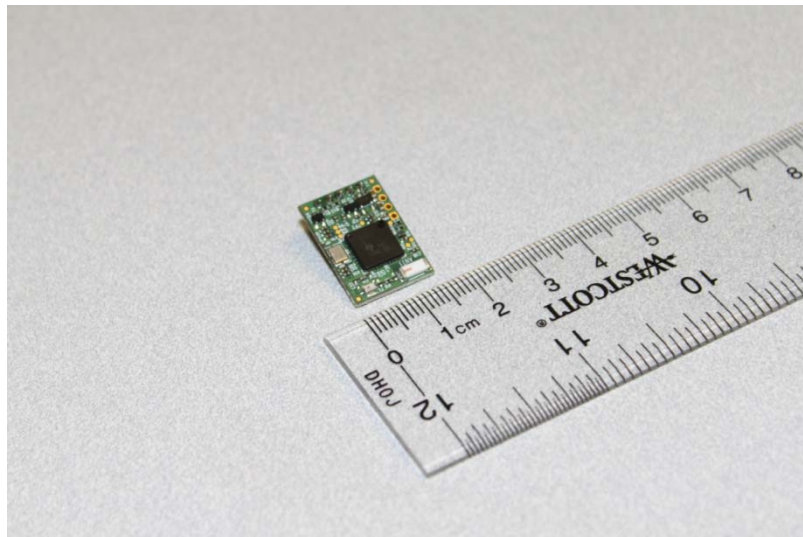
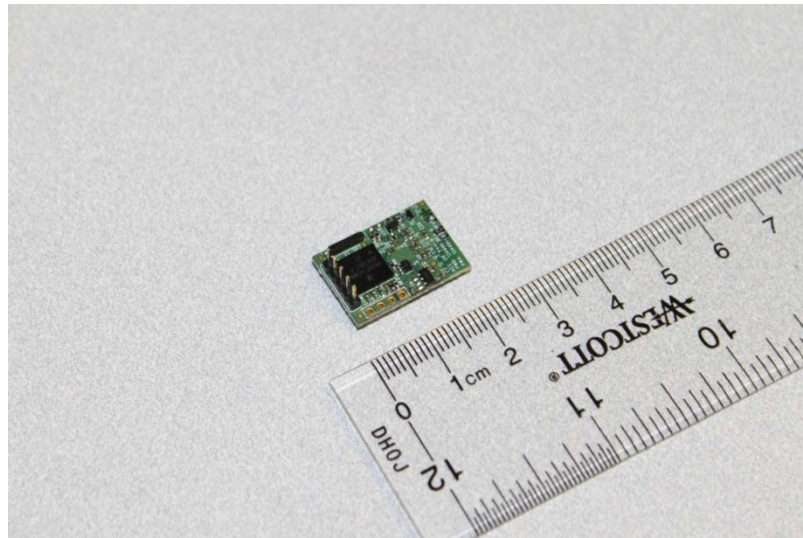

Equipment Under Test



LMU4230H used as a host for LMA application

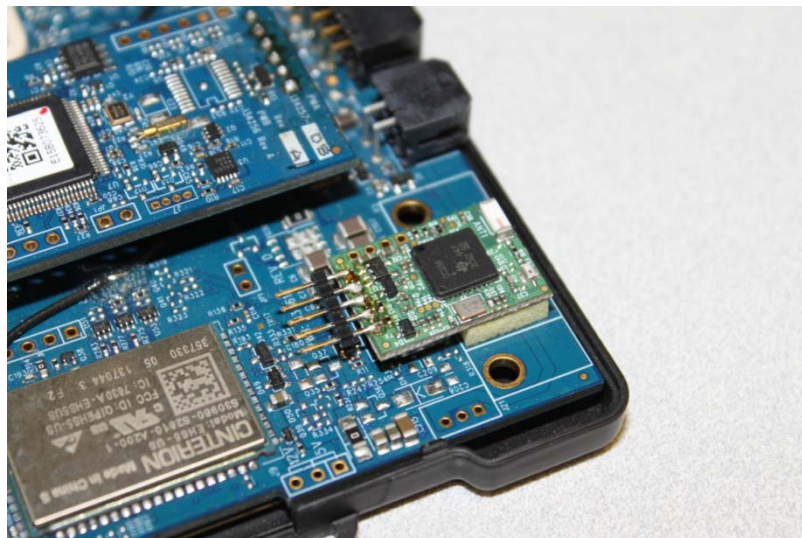

Header installed on the EUT to facilitate RF module configuration via USB



1.3.2 **EUT General Description**

EUT Description	Bluetooth Daughter Board
Model Name	CalAmp BlueBoard
Model Number(s)	BRD01
Rated Voltage	5VDC via USB
Mode Verified	Bluetooth (Bluetooth Basic Rate (BR) and Enhanced Data Rate (EDR)
Capability	Dual-Mode Bluetooth (Bluetooth Basic Rate (BR), Enhanced Data Rate (EDR) and Low Energy (LE) Support)
Primary Unit (EUT)	<input type="checkbox"/> Production <input checked="" type="checkbox"/> Pre-Production <input type="checkbox"/> Engineering
Antenna Type	RF Ceramic Chip antenna
Antenna Manufacturer	Johanson Technology
Antenna Model Number	2.45 GHZ Antenna P/N 2450AT42A100
Antenna Dimensions	5.00mm x 2.00mm x 1.10mm
Antenna Gain	0 dBi (Peak)

1.3.3 **Maximum Conducted Output Power**

Modulation	Frequency Range (MHz)	Average Output Power (dBm)	Peak Output Power (dBm)	Peak Output Power (mW)
GFSK	2402-2480	10.248	12.029	15.95
$\pi/4$ -DQPSK	2402-2480	8.607	12.023	15.93
8DPSK	2402-2480	7.863	12.213	16.65



1.4 **EUT TEST CONFIGURATION**

1.4.1 **Test Configuration Description**

Test Configuration	Description
Default	EUT connected to a support laptop via USB. The CC256x Bluetooth Hardware Evaluation Tool provided by the manufacturer was used to configure RF parameter of the EUT. For BT testing, the "Bluetooth_init_cc2564_2.10.bts" service pack was modified (Sleep Mode disable) and loaded. Packet TX/RX test mode was used with Hopping frequency mode, Disable RX, ACL Packet Type (DH1, DH3, DH5, 2-DH1, 2-DH3, 2-DH5, 3-DH1, 3-DH3 and 3-DH5), PRBS9 (Pseudo-Random) packet data pattern and Power Level of 15 (Max). For non-hopping tests, Continuous TX test mode was used with GFSK, $\pi/4$ -DQPSK and 8-DPSK modulation. PN9 (Pseudo-Random) test pattern was used while TX power was set to 15 (max). EUT was verified by itself during antenna conducted port measurements and inside a host for radiated measurements.

1.4.2 **EUT Exercise Software**

CC256x Bluetooth Hardware Evaluation Tool Version 1.0 Texas Instruments January 2013. User Guide: http://processors.wiki.ti.com/index.php/CC256x_Bluetooth_Hardware_Evaluation_Tool.

1.4.3 **Support Equipment and I/O cables**

Manufacturer	Equipment/Cable	Description
HP	Support Laptop	Elitebook 8560p S/N 5CB207539Y
HP	AC Adapter for support laptop	Model Series PPP012H-S
Armorview	USB to TTL UART RS232	PL2303HX USB with 0.9m cable (x4 conductors)
CalAmp	Fleet Management/Tracking Device	LMU4230H FCC ID:APV-4230HBT /IC: 5843C-4230HBT
CalAmp	Power Cable	Power cable for LMU4230H (2.1 meters with 4 conductors and Molex connector. Two cables are fused)

1.4.4 **Duty Cycle Correction Factor**

Duty cycle correction factor if applicable (EUT verified at worse case 100% duty cycle) will be based from dwell time of 1.25ms, 2.5ms and 3.75ms as per timeslot occupancy of 1, 3 and 5 respectively with a timeslot length of 0.625ms (e.g. for adaptive BT: $(5 \times 0.625) + 0.625 = 3.75\text{ms}$). In any given 100ms period, the DCCF will be >20dB (however limited to 20dB only) considering the 79 hop channels. For example using timeslot of 1, the dwell time is 1.25ms for an adaptive hopping system. This means it will transmit on the same channel every 98.75ms. Using pulse width of 0.378ms (GFSK from Section 2.4.9 of this test report) and worse case occurrence of two times per 100ms, DCCF will be:

$$\begin{aligned} \text{DCCF} &= 20\log((0.378 \times 2)/100) \\ &= -42.43 \text{ dB (limited to -20dB as per FCC rule)} \end{aligned}$$

1.4.5 **Worst Case Configuration**

Worst-case configuration used in this test report as per maximum conducted output power measurements:

Modulation	Channel/Packet Type	Mode
8DPSK	0 (Low Channel)	Non-hopping
GFSK	-	Hopping

EUT is an RF module. For radiated measurements, the EUT was verified inside a host using the worse case axis ("X") for the host (verified via prescan).



1.4.6 **Simplified Test Configuration Diagram**

Antenna Conducted Port Measurements

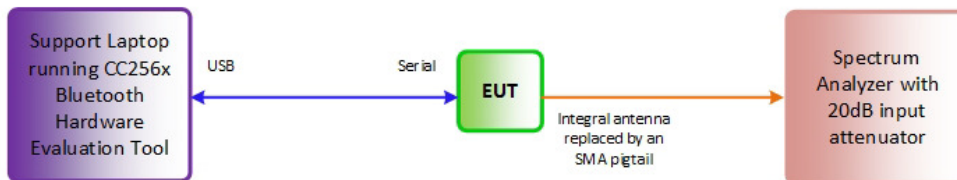

Radiated Emissions Test Configuration

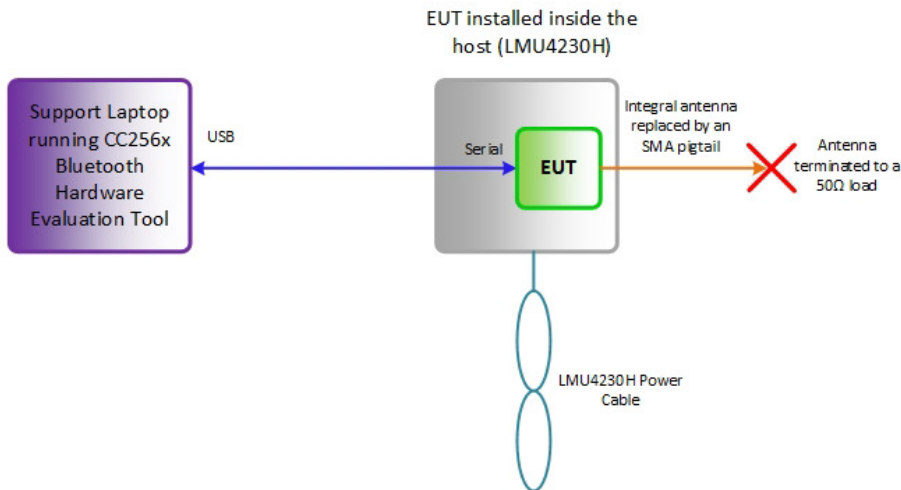



1.5 DEVIATIONS FROM THE STANDARD

No deviations from the applicable test standards or test plan were made during testing.

1.6 MODIFICATION RECORD

Description of Modification	Modification Fitted By	Date Modification Fitted
Serial Number N/A		
N/A		

The table above details modifications made to the EUT during the test programme. The modifications incorporated during each test (if relevant) are recorded on the appropriate test pages.

1.7 TEST METHODOLOGY

All measurements contained in this report were conducted with ANSI C63.10-2013. American National Standard of Procedures for Compliance Testing of Unlicensed Wireless Devices.

For conducted and radiated emissions the equipment under test (EUT) was configured to measure its highest possible emission level. This level was based on the maximized cable configuration from exploratory testing per ANSI C63.4-2014. The test modes were adapted according to the Operating Instructions provided by the manufacturer/client.

1.8 TEST FACILITY LOCATION

1.8.1 TÜV SÜD America Inc. (Mira Mesa)

10040 Mesa Rim Road, San Diego, CA 92121-2912 (32.901268,-117.177681). Phone: 858 678 1400 FAX: 858-546 0364

1.8.2 TÜV SÜD America Inc. (Rancho Bernardo)

16530 Via Esprillo, San Diego, CA 92127-1708 (33.018644,-117.092409). Phone: 858 678 1400 Fax: 858 546 0364.

1.9 TEST FACILITY REGISTRATION

1.9.1 FCC – Registration No.: US1146

TUV SUD America Inc. (San Diego), is an accredited test facility with the site description report on file and has met all the requirements specified in §2.948 of the FCC rules. The acceptance letter from the FCC is maintained in our files and the Registration is US1146.



1.9.2 **Industry Canada (IC) Registration No.: 3067A**

The 10m Semi-anechoic chamber of TÜV SÜD America Inc. (San Diego) has been registered by Certification and Engineering Bureau of Industry Canada for radio equipment testing with Registration No. 3067A.



SECTION 2

TEST DETAILS

Radio Testing of the
CalAmp Wireless Networks Corp.
Bluetooth Daughter Board



2.1 CONDUCTED EMISSIONS

2.1.1 Specification Reference

Part 15 Subpart C §15.207(a) and RSS-Gen 8.8

2.1.2 Standard Applicable

An intentional radiator that is designed to be connected to the public utility (AC) power line, the radio frequency voltage that is conducted back onto the AC power line on any frequency or frequencies, within the band 150 kHz to 30 MHz, shall not exceed the limits in the following table, as measured using a 50 µH/50 ohms line impedance stabilization network (LISN).

Frequency of emission (MHz)	Conducted limit (dBµV)	
	Quasi-peak	Average
0.15–0.5	66 to 56*	56 to 46*
0.5–5	56	46
5–30	60	50

**Decreases with the logarithm of the frequency.*

2.1.3 Equipment Under Test and Modification State

Not performed. EUT is a RF module. AC Conducted Emissions should be performed on the final host where the EUT will be integrated.



2.2 CARRIER FREQUENCY SEPARATION

2.2.1 Specification Reference

Part 15 Subpart C §15.247(a)(1) and RSS-247 Clause 5.1(2)

2.2.2 Standard Applicable

(1) Frequency hopping systems shall have hopping channel carrier frequencies separated by a minimum of 25 kHz or the 20 dB bandwidth of the hopping channel, whichever is greater. Alternatively, frequency hopping systems operating in the 2400–2483.5 MHz band may have hopping channel carrier frequencies that are separated by 25 kHz or two-thirds of the 20 dB bandwidth of the hopping channel, whichever is greater, provided the systems operate with an output power no greater than 125 mW. The system shall hop to channel frequencies that are selected at the system hopping rate from a pseudo randomly ordered list of hopping frequencies. Each frequency must be used equally on the average by each transmitter. The system receivers shall have input bandwidths that match the hopping channel bandwidths of their corresponding transmitters and shall shift frequencies in synchronization with the transmitted signals.

2.2.3 Equipment Under Test and Modification State

Serial No: N/A /Default Test Configuration

2.2.4 Date of Test/Initial of test personnel who performed the test

February 26, 2016/FSC

2.2.5 Test Equipment Used

The major items of test equipment used for the above tests are identified in Section 3.1.

2.2.6 Environmental Conditions

Test performed at TÜV SÜD America Inc. Rancho Bernardo facility.

Ambient Temperature	25.0 °C
Relative Humidity	25.3 %
ATM Pressure	99.3 kPa

2.2.7 Additional Observations

- Hopping function enabled.
- Span is wide enough to capture the peaks of two adjacent channels.
- RBW is 1% of the span.
- VBW is 3x RBW
- Sweep is auto

- Detector is peak.
- Trace is max hold.
- TDF (transducer factor) was added to compensate for the external attenuator and cable used.
- Marker-delta function is used between the peaks of the adjacent channels.
- Limit used is >966.7 kHz (2/3 of worst case 20dB BW).

2.2.8 Test Results

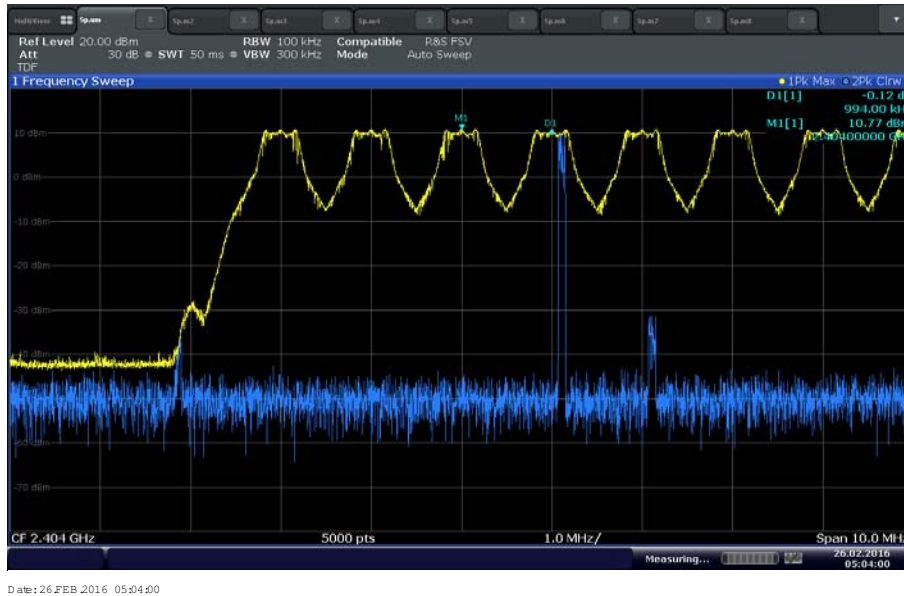

Observed carrier frequency separation between Channel 2 and Channel 3 = 0.996 MHz (Complies. Greater than 966.7 kHz, this is 2/3 of 1.45MHz 20 dB BW)



2.3 NUMBER OF HOPPING FREQUENCIES

2.3.1 Specification Reference

Part 15 Subpart C §15.247(a)(1)(iii) and RSS-247 Clause 5.4(4)

2.3.2 Standard Applicable

(iii) Frequency hopping systems in the 2400–2483.5 MHz band shall use at least 15 channels. The average time of occupancy on any channel shall not be greater than 0.4 seconds within a period of 0.4 seconds multiplied by the number of hopping channels employed. Frequency hopping systems may avoid or suppress transmissions on a particular hopping frequency provided that a minimum of 15 channels are used.

2.3.3 Equipment Under Test and Modification State

Serial No: N/A /Default Test Configuration

2.3.4 Date of Test/Initial of test personnel who performed the test

February 26, 2016/FSC

2.3.5 Test Equipment Used

The major items of test equipment used for the above tests are identified in Section 3.1.

2.3.6 Environmental Conditions

Test performed at TÜV SÜD America Inc. Rancho Bernardo facility.

Ambient Temperature	25.0 °C
Relative Humidity	25.3 %
ATM Pressure	99.3 kPa

2.3.7 Additional Observations

- Hopping function enabled.
- Span is the entire band (2400 MHz to 2483.5 MHz).
- Sweep is auto
- Detector is peak, trace is max hold.
- TDF (transducer factor) was added to compensate for the external attenuator and cable used.
- Marker Peak List function of the Spectrum Analyzer was used for this test.

2.3.8 Test Results

See attached plot.

2.3.9 Test Result Plot

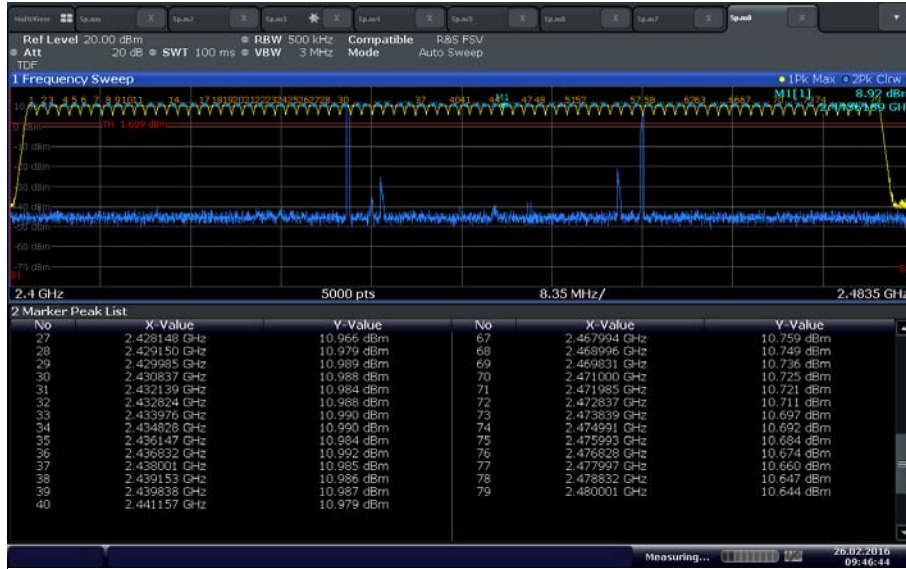

Date: 26.FEB.2016 09:46:44

Peak List verification showing 79 hopping channels. EUT Complies with the minimum 15 channels requirement.



2.4 TIME OF OCCUPANCY (DWELL TIME)

2.4.1 Specification Reference

Part 15 Subpart C §15.247(a)(1)(iii) and RSS-247 Clause 5.4(4)

2.4.2 Standard Applicable

(iii) Frequency hopping systems in the 2400–2483.5 MHz band shall use at least 15 channels. The average time of occupancy on any channel shall not be greater than 0.4 seconds within a period of 0.4 seconds multiplied by the number of hopping channels employed. Frequency hopping systems may avoid or suppress transmissions on a particular hopping frequency provided that a minimum of 15 channels are used.

2.4.3 Equipment Under Test and Modification State

Serial No: N/A /Default Test Configuration

2.4.4 Date of Test/Initial of test personnel who performed the test

February 26, 2016/FSC

2.4.5 Test Equipment Used

The major items of test equipment used for the above tests are identified in Section 3.1.

2.4.6 Environmental Conditions

Test performed at TÜV SÜD America Inc. Rancho Bernardo facility.

Ambient Temperature	25.0 °C
Relative Humidity	25.3 %
ATM Pressure	99.3 kPa

2.4.7 Additional Observations

- Hopping function enabled.
- Span = zero span, centered on a hopping channel.
- RBW is 1MHz, while VBW is 3x RBW
- Detector is peak.
- A single pulse is first measured. This measurement is then used to compute the average time of occupancy in the required period (no. of channels x 0.4 second).
- The EUT was configured using Packet TX/RX test mode of the BT Evaluation Tool provided by the manufacturer. Packet Data Pattern was set to PRBS9 while the ACL Packet Types were set to DH-1, 2-DH3 and 3-DH5.
- Only the worst packet type presented for each modulation.
- The Marker Peak List function of the Spectrum Analyzer was used to determine the number of pulses per required sweep time.

2.4.8 **Test Results**

Modulation	Measured time of occupancy	Requirement
GFSK	121.07 ms	<400 ms
$\pi/4$ -DQPSK	292.29 ms	<400 ms
8DPSK	316.58 ms	<400 ms

2.4.9 **Sample Computation (GFSK)**

Width of single pulse = 0.00037837 second
 Observed occurrence = 32 pulses/3.16 seconds
 Required period = 79 channels x 0.4 second
 = 31.6 seconds

Average time of occupancy = Pulse width x #pulses in 3.16 seconds x 10
 = 0.00037837 second x 32 x 10
 = 0.121 second

Compliance = **Complies.** 0.121 second < 0.4 second

2.4.10 **Test Results Plots**

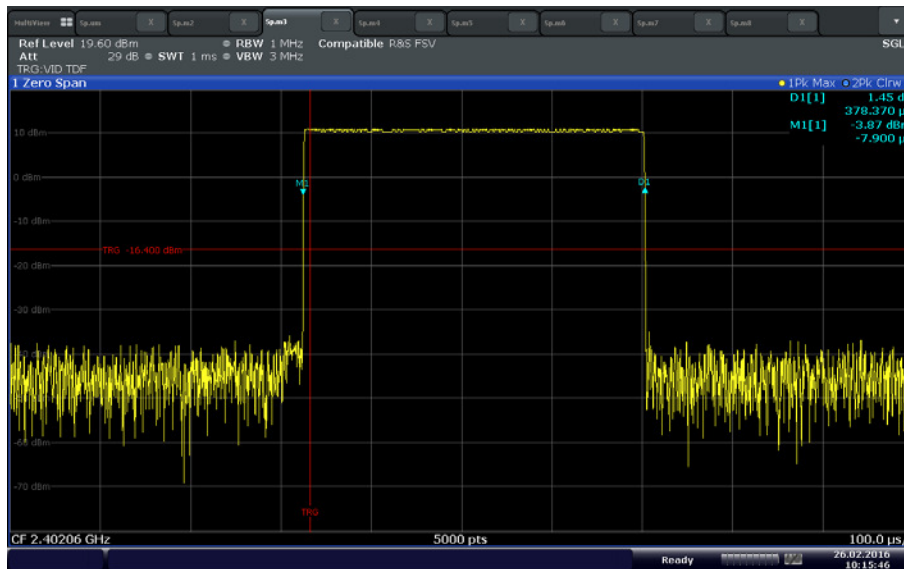

Date: 26.FEB.2016 10:15:47

GFSK width of single pulse (0.37837ms)

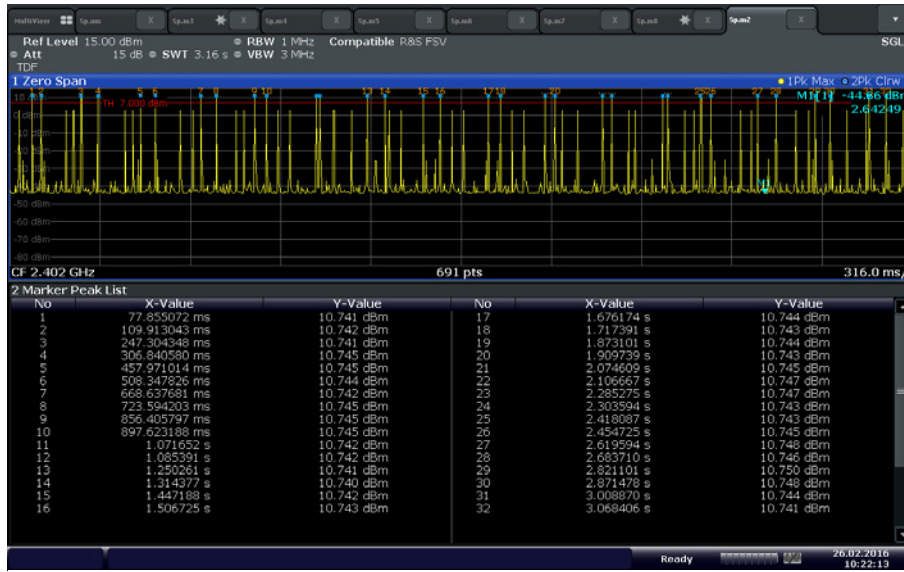

Date: 26.FEB.2016 10:22:13

32 pulses/3.16 seconds (DH1)

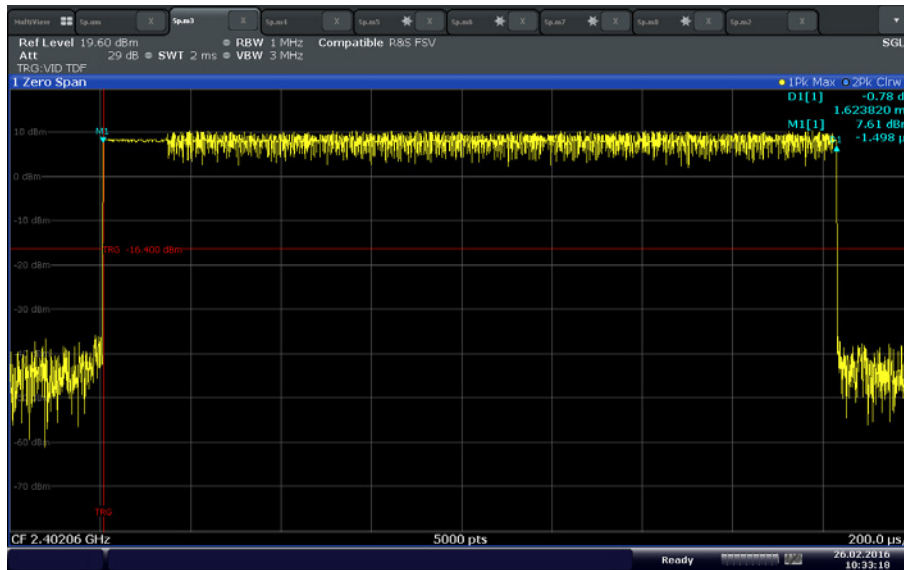

Date: 26.FEB.2016 10:33:18

$\pi/4$ -DQPSK width of single pulse (1.6238 ms)

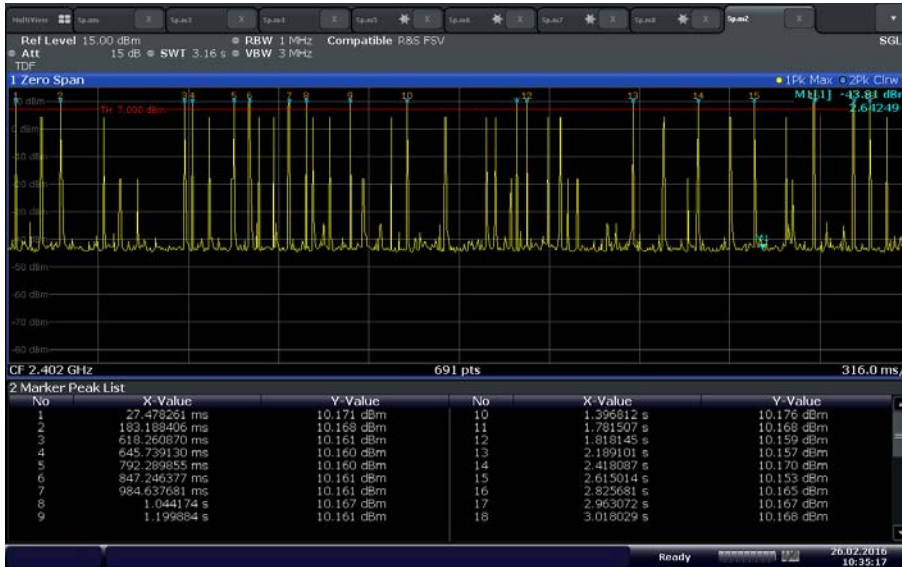

Date: 26.FEB.2016 10:35:17

18 pulses/3.16 seconds (2-DH3)

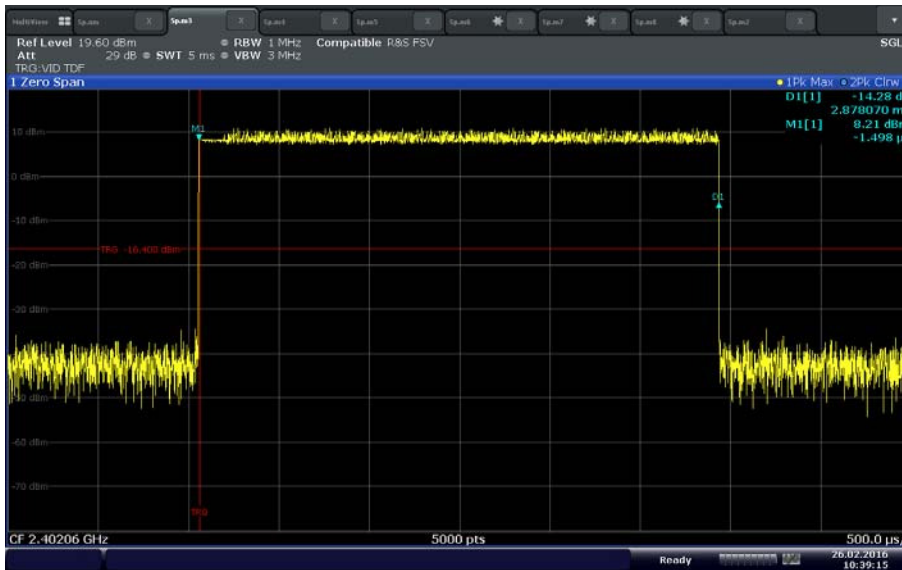

Date: 26.FEB.2016 10:39:14

8DPSK width of single pulse (2.878 ms)

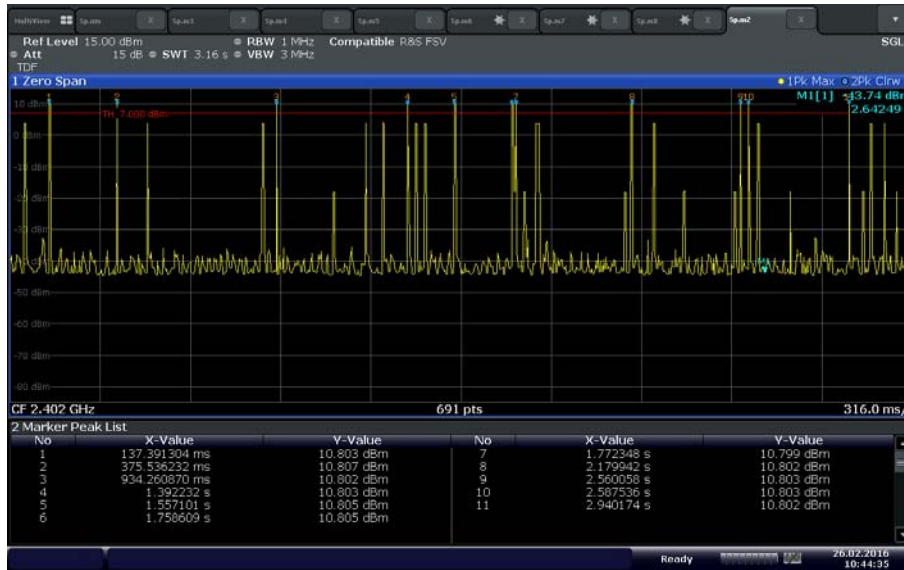

Date: 26.FEB.2016 10:44:35

11 pulses/3.16 seconds (3-DH5)



2.5 20 dB BANDWIDTH

2.5.1 Specification Reference

Part 15 Subpart C §15.215(c) and RSS-247 Clause 5.1(1)

2.5.2 Standard Applicable

(c) Intentional radiators operating under the alternative provisions to the general emission limits, as contained in §§15.217 through 15.257 and in Subpart E of this part, must be designed to ensure that the 20 dB bandwidth of the emission, or whatever bandwidth may otherwise be specified in the specific rule section under which the equipment operates, is contained within the frequency band designated in the rule section under which the equipment is operated. The requirement to contain the designated bandwidth of the emission within the specified frequency band includes the effects from frequency sweeping, frequency hopping and other modulation techniques that may be employed as well as the frequency stability of the transmitter over expected variations in temperature and supply voltage. If a frequency stability is not specified in the regulations, it is recommended that the fundamental emission be kept within at least the central 80% of the permitted band in order to minimize the possibility of out-of-band operation.

2.5.3 Equipment Under Test and Modification State

Serial No: N/A /Default Test Configuration

2.5.4 Date of Test/Initial of test personnel who performed the test

February 26, 2016/FSC

2.5.5 Test Equipment Used

The major items of test equipment used for the above tests are identified in Section 3.1.

2.5.6 Environmental Conditions

Test performed at TÜV SÜD America Inc. Rancho Bernardo facility.

Ambient Temperature	25.0 °C
Relative Humidity	25.3 %
ATM Pressure	99.3 kPa

2.5.7 Additional Observations

- This is a conducted test.
- TDF (transducer factor) was added to compensate for the external attenuator and cable used.
- Span is approximately 2 to 3 times the expected 20dB bandwidth.
- RBW is $\geq 1\%$ of the expected 20dB bandwidth while VBW is \geq RBW.
- Sweep is auto.
- Detector is peak.
- Max hold function activated.



- “n dB down” marker function (20dB) of the spectrum analyzer was used for this test.

2.5.8 Test Results

Modulation	Channel	Frequency (MHz)	Measured 20dB Bandwidth (MHz)
GFSK	0	2402	1.11
	38	2440	1.11
	78	2480	1.11
π/4-DQPSK	0	2402	1.45
	38	2440	1.45
	78	2480	1.44
8DPSK	0	2402	1.43
	38	2440	1.43
	78	2480	1.43

Worst case configuration (π/4-DQPSK)

2402 MHz – (20dB BW/2) = 2401.275 MHz (within the frequency band - **Compliant**)

Worst case configuration (π/4-DQPSK)

2480 MHz + (20dB BW/2) = 2480.725 MHz (within the frequency band - **Compliant**)

2.5.9 Test Results Plots

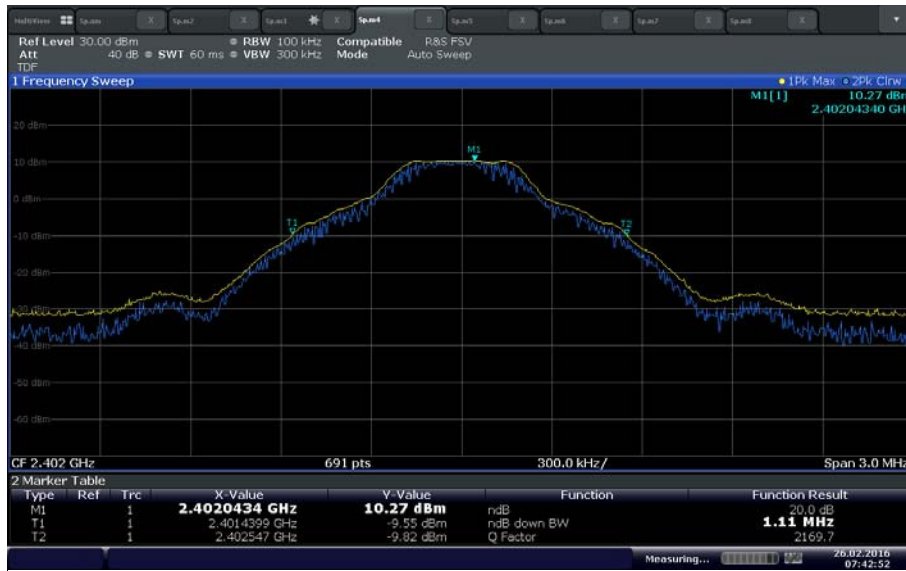

Date: 26.FEB.2016 07:42:52

GFSK Low Channel

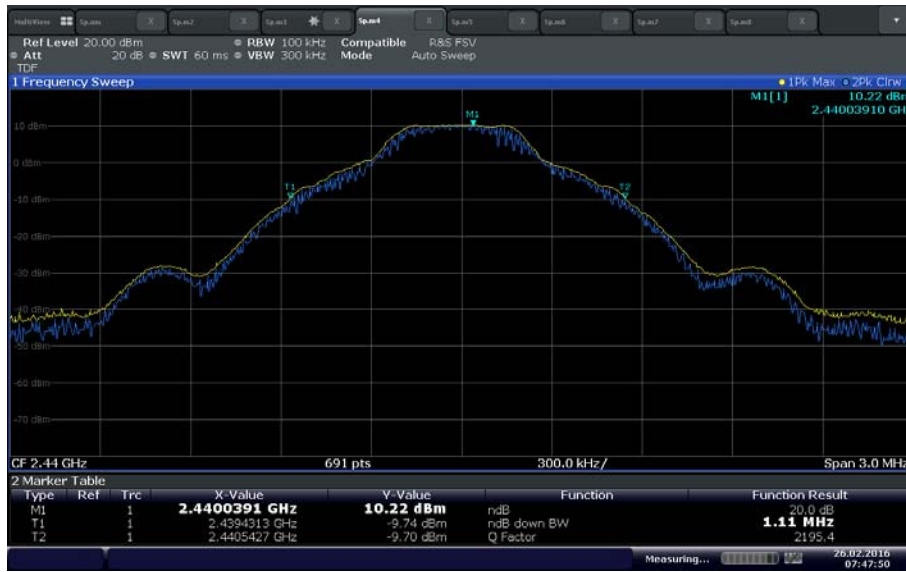

Date: 26.FEB.2016 07:47:50

GFSK Mid Channel

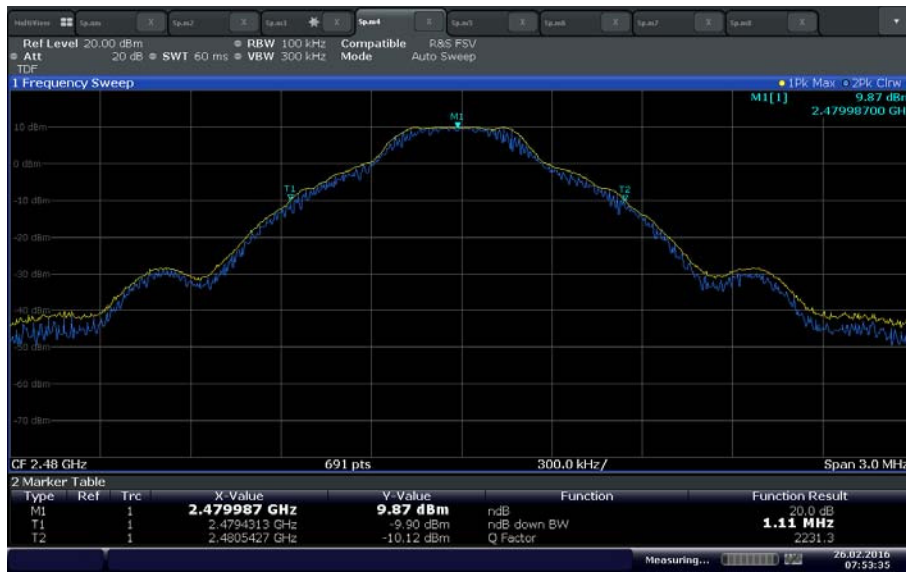

Date: 26.FEB.2016 07:53:35

GFSK High Channel

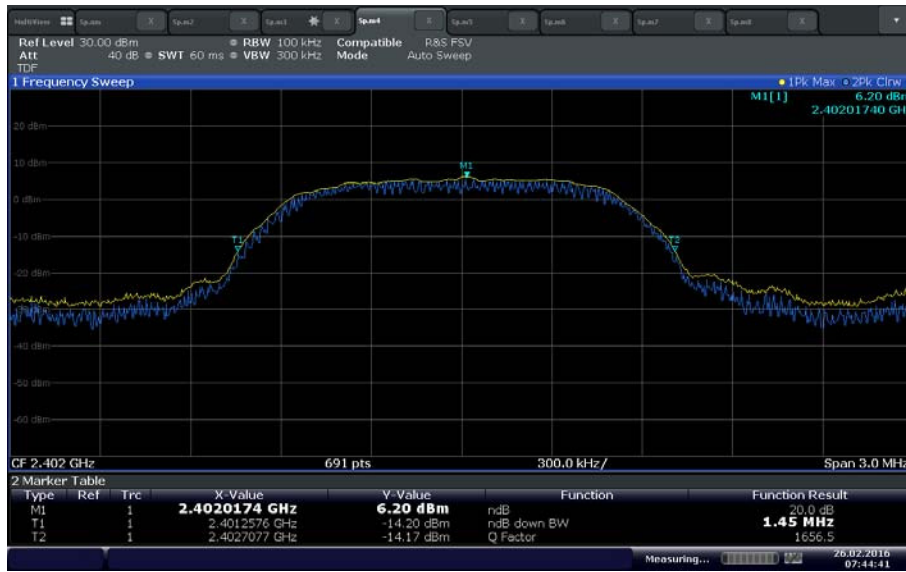

Date: 26.FEB.2016 07:44:41

$\pi/4$ -DQPSK Low Channel

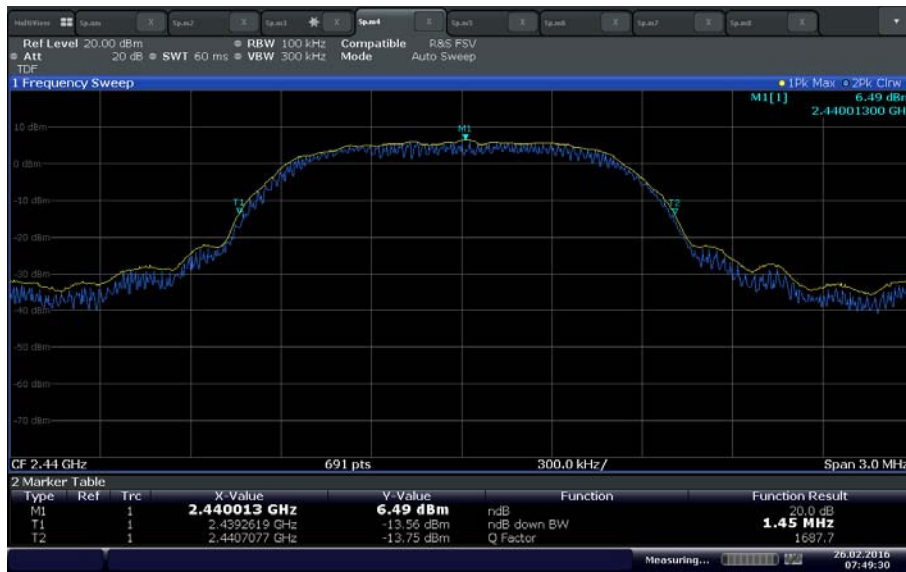

Date: 26.FEB.2016 07:49:30

$\pi/4$ -DQPSK Mid Channel



Date: 26.FEB.2016 07:52:44

π/4-DQPSK High Channel

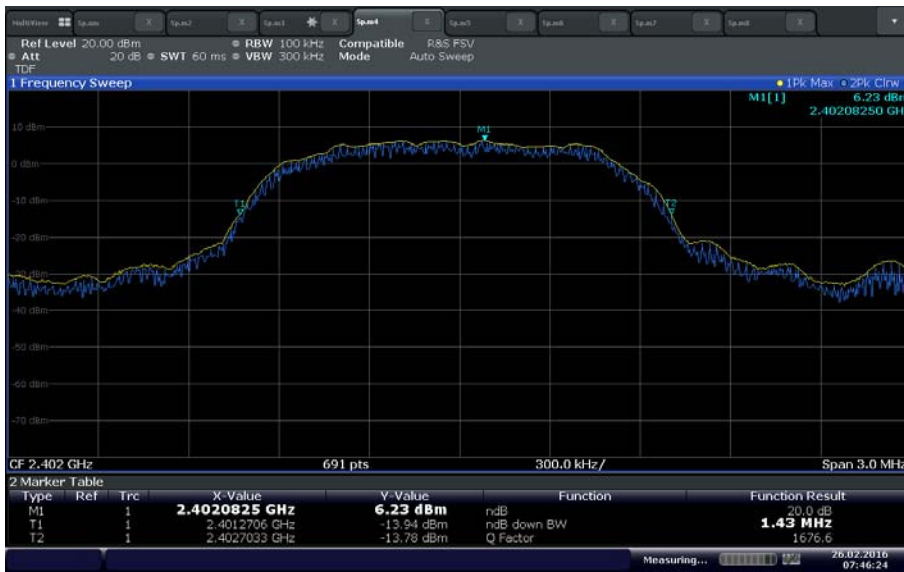

Date: 26.FEB.2016 07:46:25

8DPSK Low Channel



Date: 26.FEB.2016 07:50:31

8DPSK Mid Channel

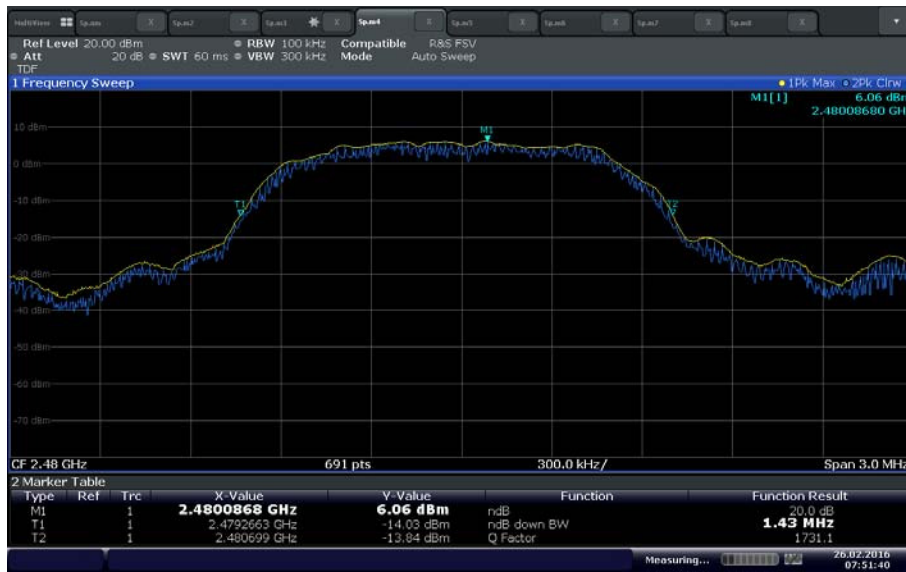

Date: 26.FEB.2016 07:51:40

8DPSK High Channel



2.6 99% EMISSION BANDWIDTH

2.6.1 Specification Reference

RSS-Gen Clause 6.6

2.6.2 Standard Applicable

The emission bandwidth (x dB) is defined as the frequency range between two points, one above and one below the carrier frequency, at which the spectral density of the emission is attenuated x dB below the maximum in-band spectral density of the modulated signal. Spectral density (power per unit bandwidth) is to be measured with a detector of resolution bandwidth in the range of 1% to 5% of the anticipated emission bandwidth, and a video bandwidth at least 3x the resolution bandwidth.

When the occupied bandwidth limit is not stated in the applicable RSS or reference measurement method, the transmitted signal bandwidth shall be reported as the 99% emission bandwidth, as calculated or measured.

- The transmitter shall be operated at its maximum carrier power measured under normal test conditions.
- • The span of the analyzer shall be set to capture all products of the modulation process, including the emission skirts.
- • The resolution bandwidth (RBW) shall be in the range of 1% to 5% of the occupied bandwidth (OBW) and video bandwidth (VBW) shall be approximately 3x RBW.

Note: Video averaging is not permitted.

A peak, or peak hold, may be used in place of the sampling detector as this may produce a wider bandwidth than the actual bandwidth (worst-case measurement). Use of a peak hold may be necessary to determine the occupied bandwidth if the device is not transmitting continuously.

The trace data points are recovered and are directly summed in linear power level terms. The recovered amplitude data points, beginning at the lowest frequency, are placed in a running sum until 0.5% of the total is reached and that frequency recorded. The process is repeated for the highest frequency data points (starting at the highest frequency, at the right side of the span, and going down in frequency). This frequency is then recorded.

The difference between the two recorded frequencies is the 99% occupied bandwidth.

2.6.3 Equipment Under Test and Modification State

Serial No: N/A /Default Test Configuration

2.6.4 Date of Test/Initial of test personnel who performed the test

February 26, 2016/FSC

2.6.5 Test Equipment Used

The major items of test equipment used for the above tests are identified in Section 3.1.

2.6.6 Environmental Conditions

Test performed at TÜV SÜD America Inc. Rancho Bernardo facility.



Ambient Temperature 25.0 °C
 Relative Humidity 25.3 %
 ATM Pressure 99.3 kPa

2.6.7 **Additional Observations**

- This is a conducted test.
- TDF (transducer factor) was added to compensate for the external attenuator and cable used.
- Span is wide enough to capture the channel transmission.
- RBW is 1% of the span.
- VBW is 3X RBW.
- Sweep is auto.
- Detector is peak.
- The % Power Bandwidth setting in the spectrum analyzer was set to 99% (default).
- The OBW power measurement function of the spectrum analyzer was used for this test.

2.6.8 **Test Results (For reporting purposes only)**

Modulation	Channel	Frequency (MHz)	Measured 20dB Bandwidth (MHz)
GFSK	0	2402	0.955
	38	2440	0.955
	78	2480	0.955
$\pi/4$ -DQPSK	0	2402	1.274
	38	2440	1.259
	78	2480	1.274
8DPSK	0	2402	1.273
	38	2440	1.274
	78	2480	1.274

2.6.9 Test Results Plots

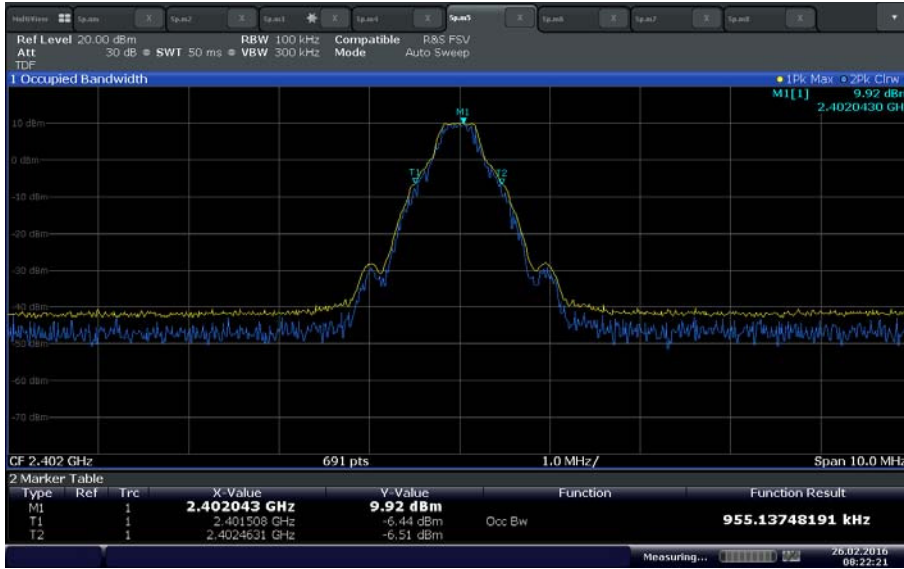

Date: 26.FEB.2016 08:22:22

GFSK Low Channel

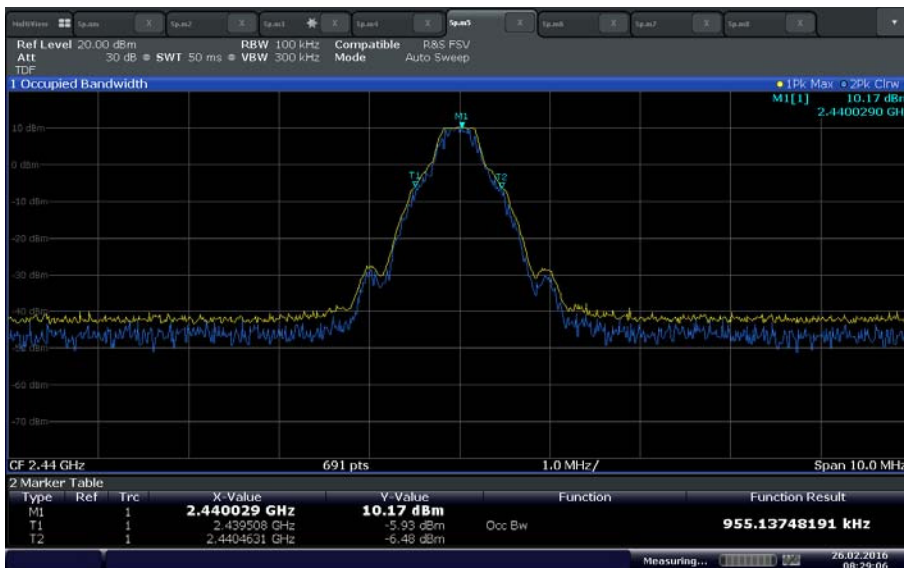

Date: 26.FEB.2016 08:29:06

GFSK Mid Channel

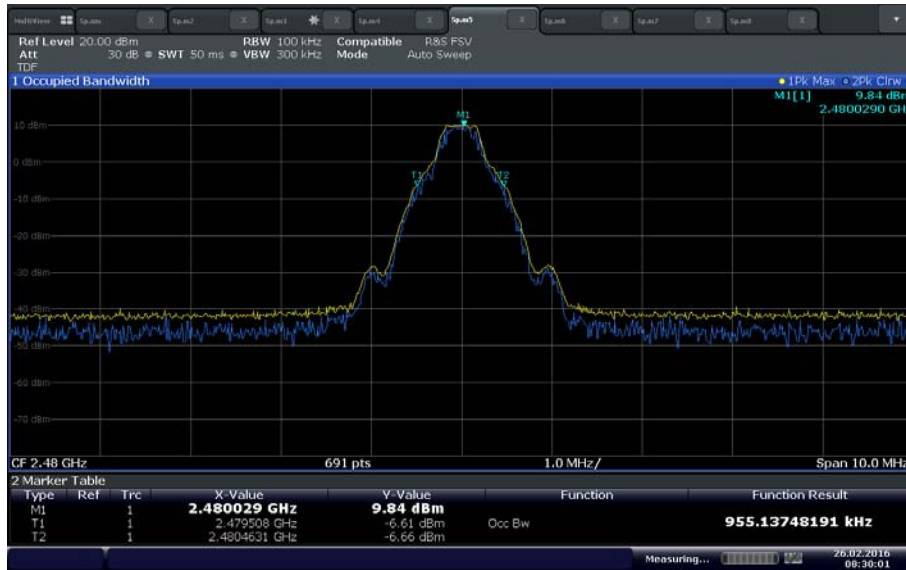

Date: 26.FEB.2016 08:30:01

GFSK High Channel

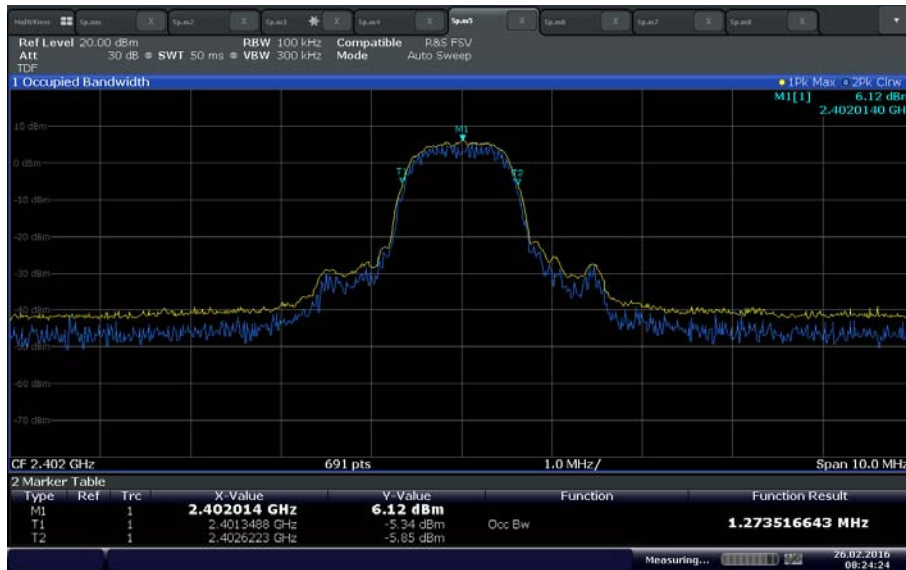

Date: 26.FEB.2016 08:24:24

$\pi/4$ -DQPSK Low Channel

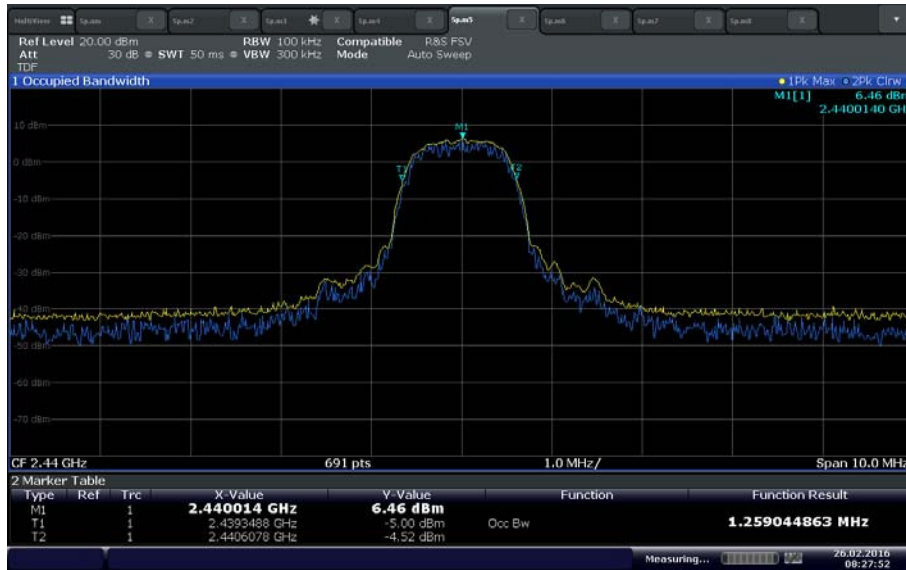

Date: 26.FEB.2016 08:27:52

$\pi/4$ -DQPSK Mid Channel

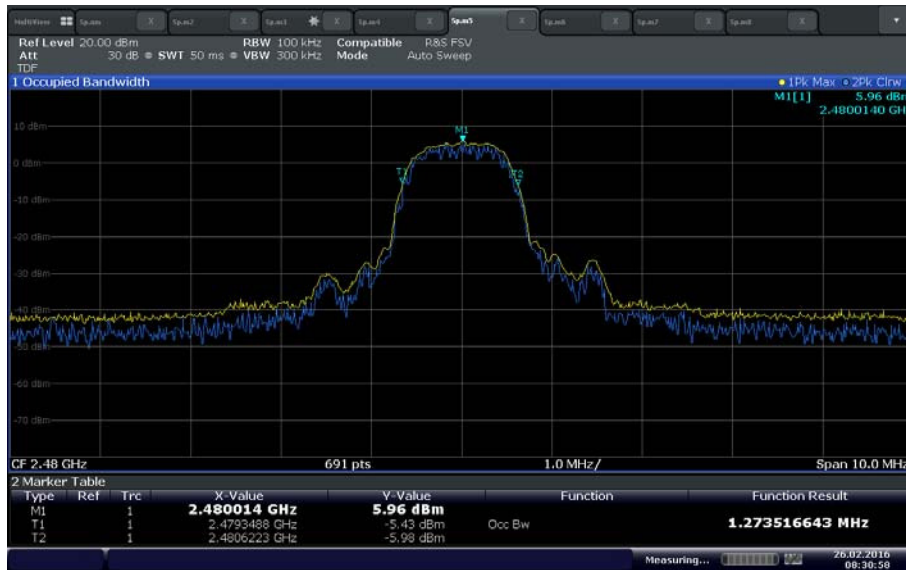

Date: 26.FEB.2016 08:30:58

$\pi/4$ -DQPSK High Channel

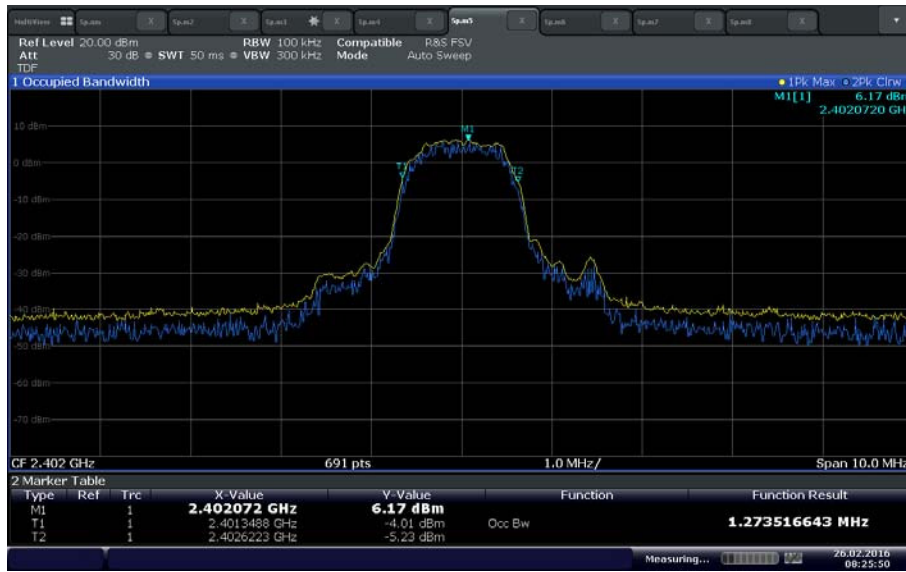

8DPSK Low Channel

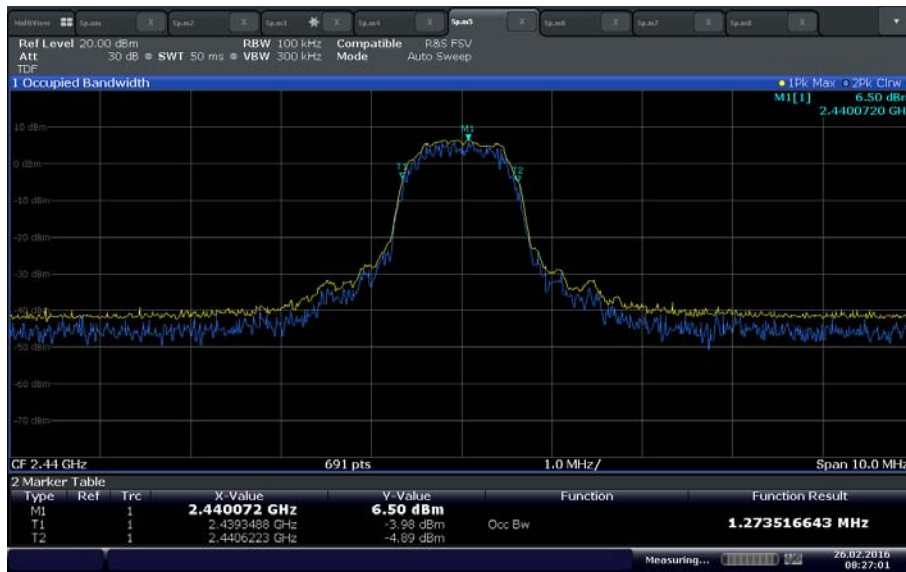

8DPSK Mid Channel

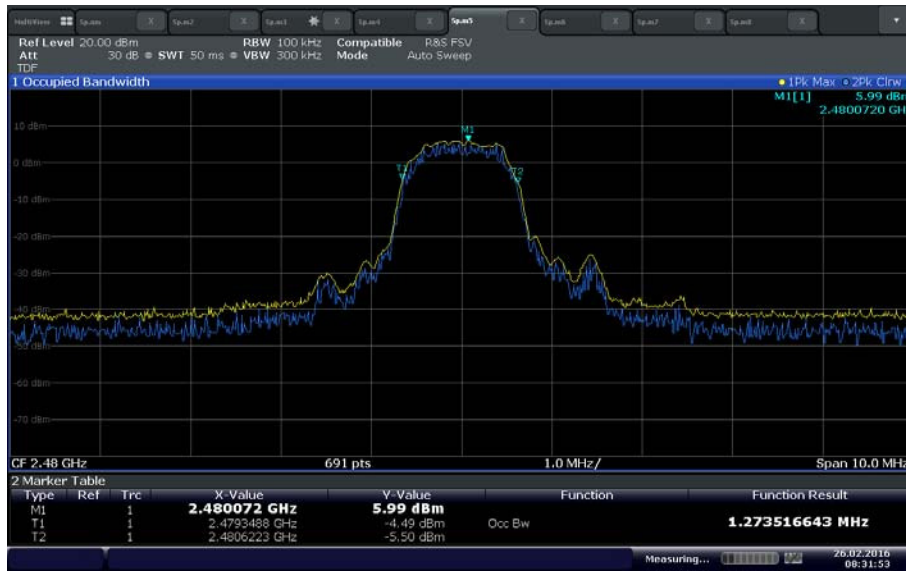

Date: 26.FEB.2016 08:31:53

8DPSK High Channel



2.7 PEAK OUTPUT POWER

2.7.1 Specification Reference

Part 15 Subpart C §15.247(b)(1) and RSS-247 Clause 5.4(2)

2.7.2 Standard Applicable

(1) For frequency hopping systems operating in the 2400–2483.5 MHz band employing at least 75 non-overlapping hopping channels, and all frequency hopping systems in the 5725–5850 MHz band: 1 watt. For all other frequency hopping systems in the 2400–2483.5 MHz band: 0.125 watts.

2.7.3 Equipment Under Test and Modification State

Serial No: N/A /Default Test Configuration

2.7.4 Date of Test/Initial of test personnel who performed the test

February 25, 2016/FSC

2.7.5 Test Equipment Used

The major items of test equipment used for the above tests are identified in Section 3.1.

2.7.6 Environmental Conditions

Test performed at TÜV SÜD America Inc. Rancho Bernardo facility.

Ambient Temperature 27.0 °C
 Relative Humidity 21.7 %
 ATM Pressure 99.2 kPa

2.7.7 Additional Observations

This is a conducted test using a Peak/Average Power Meter.

2.7.8 Test Results (Conducted)

Modulation	Channel	Frequency (MHz)	Measured Average Output Power (dBm)	Measured Peak Output Power (dBm)	Measured Peak Output Power (mW)	Limit (mW)
GFSK	0	2402	10.248	12.029	16.0	1000.0
	38	2440	10.181	11.946	15.7	1000.0
	78	2480	10.063	11.875	15.4	1000.0



$\pi/4$ -DQPSK	0	2402	8.607	12.023	0.0159	1000.0
	38	2440	8.136	11.879	0.0154	1000.0
	78	2480	7.666	11.909	0.0155	1000.0
8DPSK	0	2402	7.863	12.213	0.0166	1000.0
	38	2440	7.733	12.197	0.0166	1000.0
	78	2480	7.654	12.102	0.0162	1000.0

2.7.9 Test Results (*De Facto* EIRP Limit)

Modulation	Channel	Frequency (MHz)	Measured Peak Output Power (dBm)	Antenna Gain (dBi)	Calculated Peak Output Power EIRP (dBm)	Limit (dBm)
GFSK	0	2402	12.029	0	12.029	30
$\pi/4$ -DQPSK	0	2402	12.023	0	12.023	30
8DPSK	0	2402	12.213	0	12.213	30

2.7.10 Sample Test Display

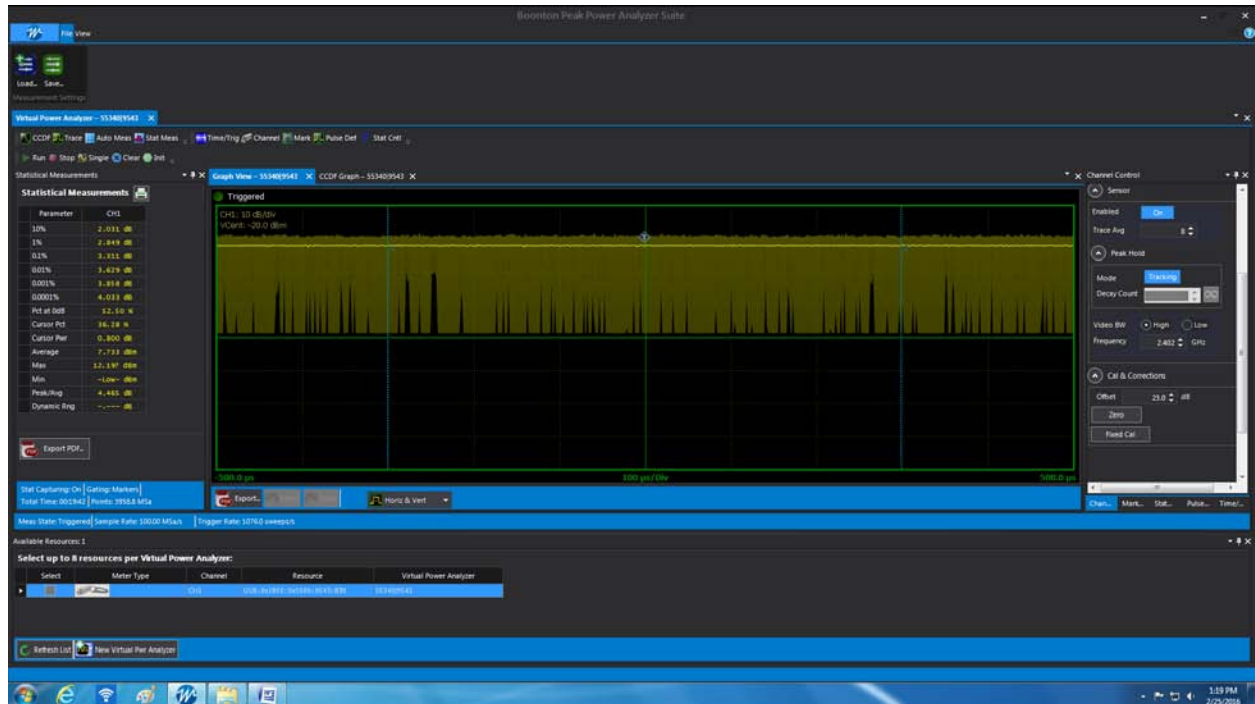

8DPSK mid channel (Channel 38 2440 MHz)



2.8 BAND-EDGE COMPLIANCE OF RF CONDUCTED EMISSIONS

2.8.1 Specification Reference

Part 15 Subpart C §15.247(d) and RSS-247 Clause 5.5

2.8.2 Standard Applicable

(d) In any 100 kHz bandwidth outside the frequency band in which the spread spectrum or digitally modulated intentional radiator is operating, the radio frequency power that is produced by the intentional radiator shall be at least 20 dB below that in the 100 kHz bandwidth within the band that contains the highest level of the desired power, based on either an RF conducted or a radiated measurement, provided the transmitter demonstrates compliance with the peak conducted power limits. If the transmitter complies with the conducted power limits based on the use of RMS averaging over a time interval, as permitted under paragraph (b)(3) of this section, the attenuation required under this paragraph shall be 30 dB instead of 20 dB. Attenuation below the general limits specified in §15.209(a) is not required. In addition, radiated emissions which fall in the restricted bands, as defined in §15.205(a), must also comply with the radiated emission limits specified in §15.209(a) (see §15.205(c)).

2.8.3 Equipment Under Test and Modification State

Serial No: N/A /Default Test Configuration

2.8.4 Date of Test/Initial of test personnel who performed the test

February 26, 2016/FSC

2.8.5 Test Equipment Used

The major items of test equipment used for the above tests are identified in Section 3.1.

2.8.6 Environmental Conditions

Test performed at TÜV SÜD America Inc. Rancho Bernardo facility.

Ambient Temperature	25.0 °C
Relative Humidity	25.3 %
ATM Pressure	99.3 kPa

2.8.7 Additional Observations

- This is a conducted test.
- TDF (transducer factor) was added to compensate for the external attenuator and cable used.
- Span is wide enough to capture the peak level of the emission operating on the channel closest to the band edge.
- RBW is $\geq 1\%$ of the span, VBW is \geq RBW.
- Sweep is auto, detector is peak, trace is max hold.
- Trace allowed to stabilize. Marker-delta function used to verify compliance.

- Limit is 20dBc.
- Both Hopping and Non-Hopping mode verified.

2.8.8 Test Results

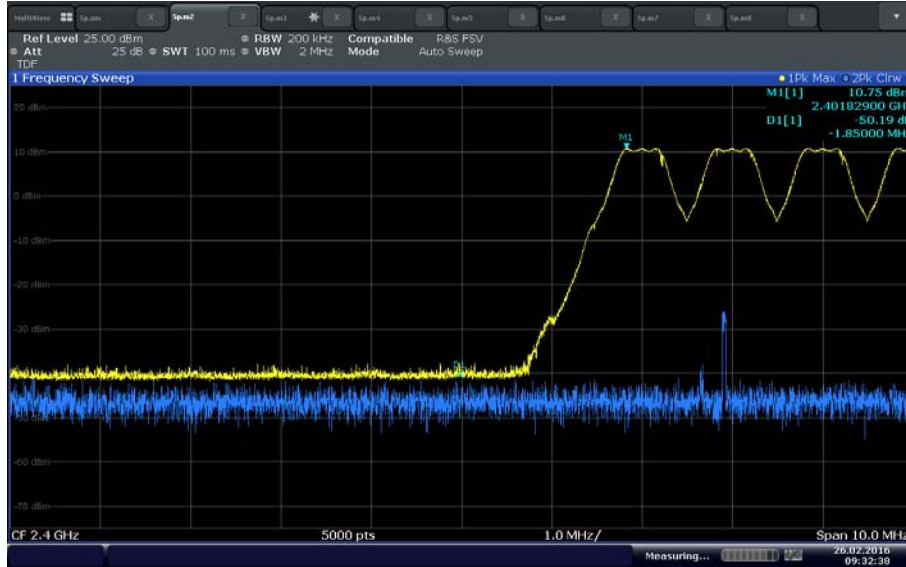

Hopping lower bandedge (GFSK)

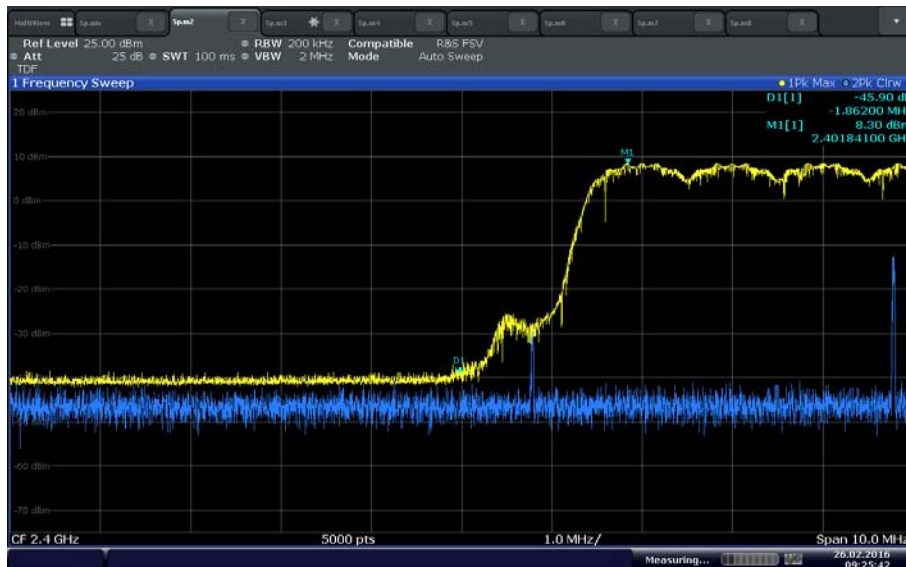

Hopping lower bandedge ($\pi/4$ -DQPSK)

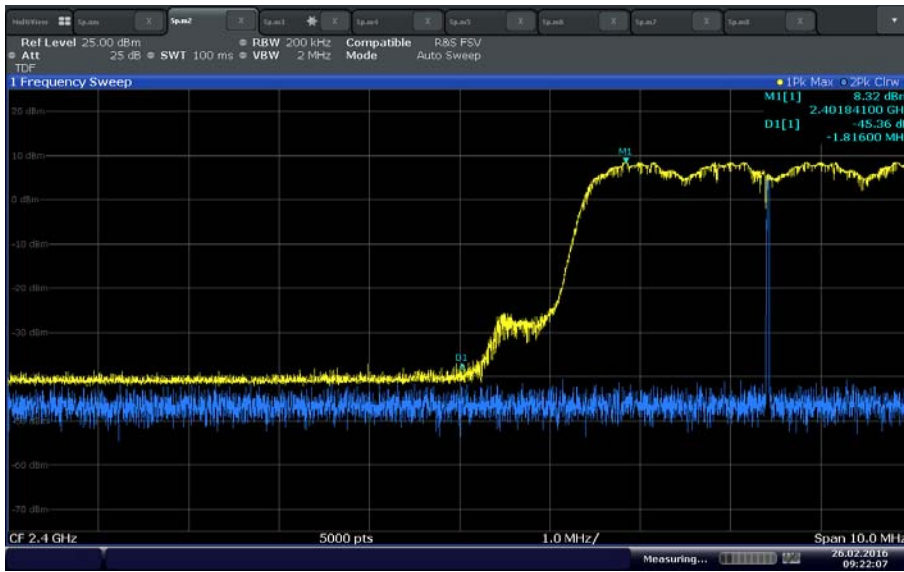

Hopping lower bandedge (8DPSK)

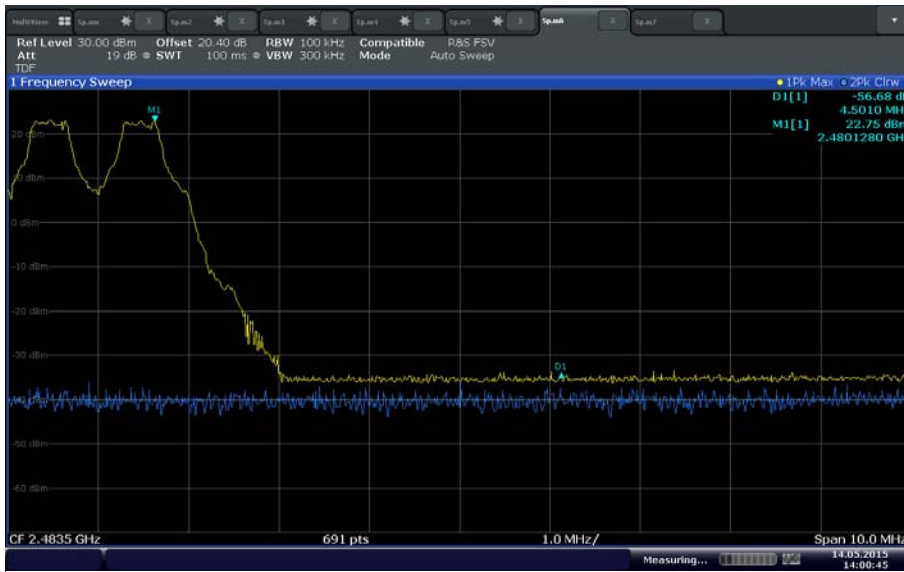

Hopping upper bandedge (GFSK)

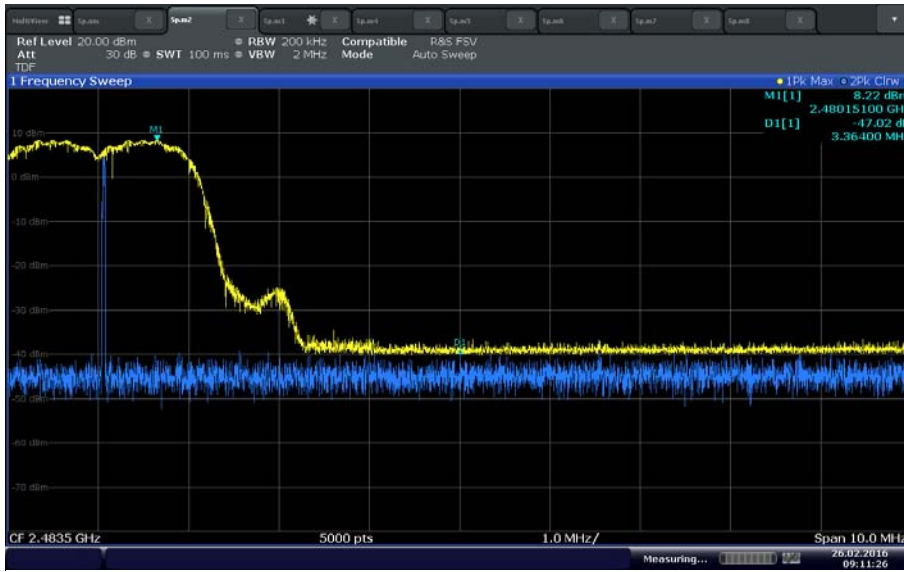

Date: 26.FEB.2016 09:11:26

Hopping upper bandedge ($\pi/4$ -DQPSK)

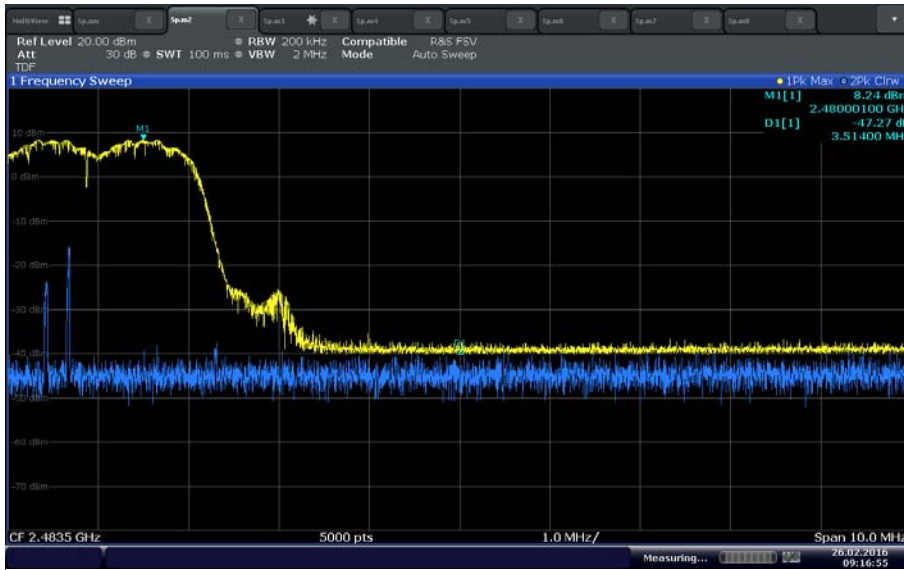

Date: 26.FEB.2016 09:16:52

Hopping upper bandedge (8DPSK)

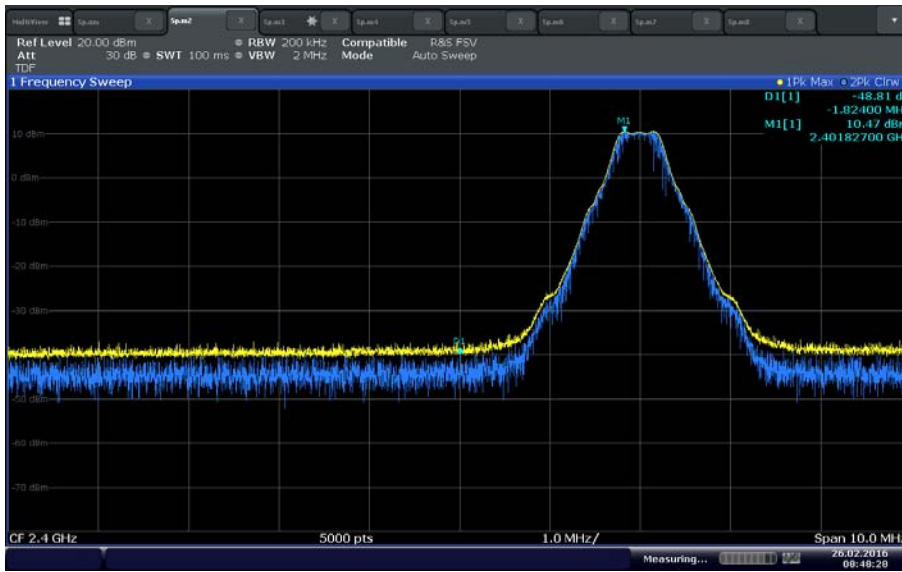

Date: 26.FEB.2016 08:48:28

Non-hopping lower bandedge (GFSK)

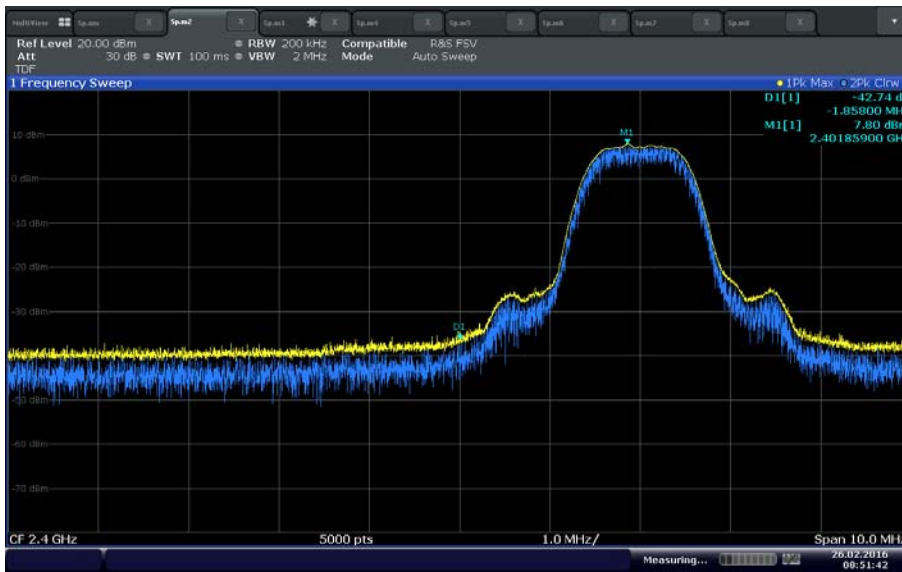

Date: 26.FEB.2016 08:51:42

Non-hopping lower bandedge ($\pi/4$ -DQPSK)

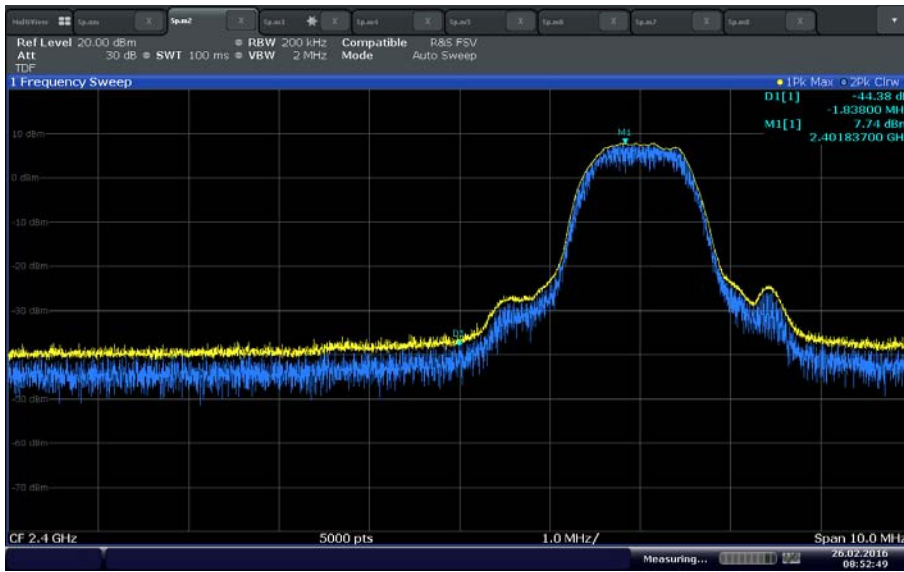

Date: 26.FEB.2016 08:52:50

Non-hopping lower bandedge (8DPSK)

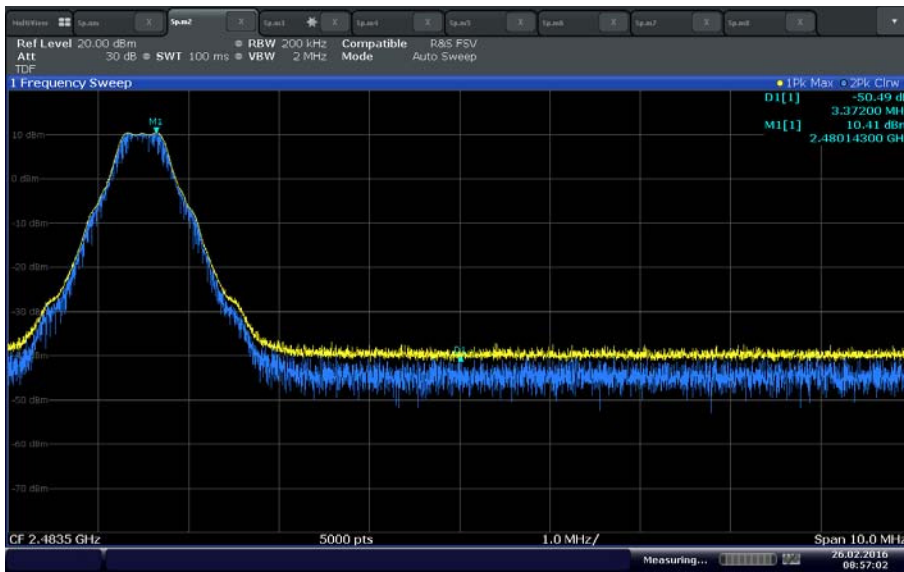

Date: 26.FEB.2016 08:57:02

Non-hopping upper bandedge (GFSK)

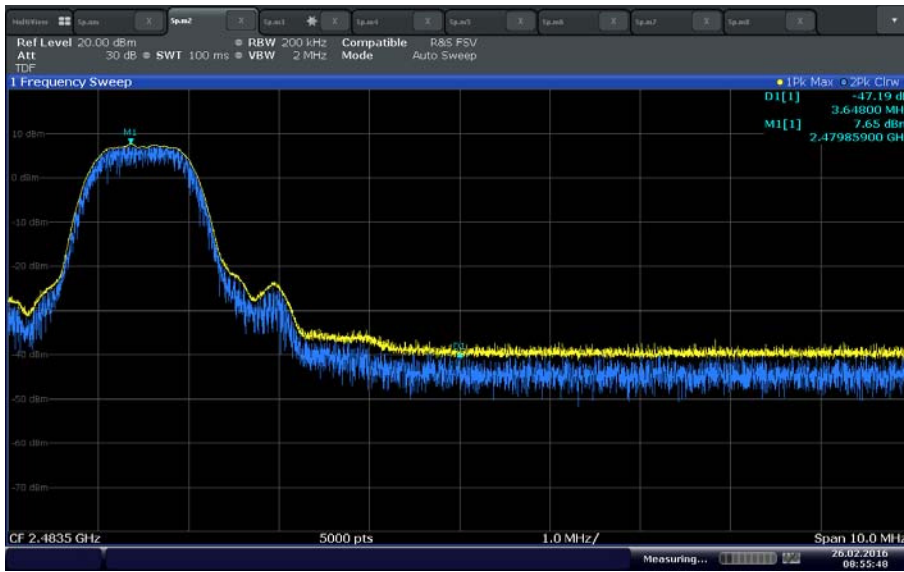

Non-hopping upper bandedge ($\pi/4$ -DQPSK)

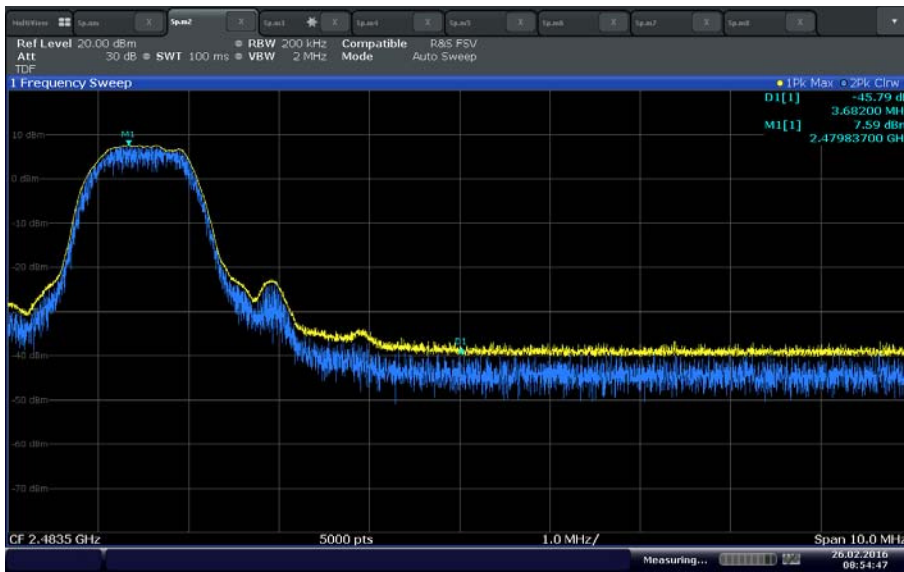

Non-hopping upper bandedge (8DPSK)



2.9 SPURIOUS RF CONDUCTED EMISSIONS

2.9.1 Specification Reference

Part 15 Subpart C §15.247(d) and RSS-247 Clause 5.5

2.9.2 Standard Applicable

(d) In any 100 kHz bandwidth outside the frequency band in which the spread spectrum or digitally modulated intentional radiator is operating, the radio frequency power that is produced by the intentional radiator shall be at least 20 dB below that in the 100 kHz bandwidth within the band that contains the highest level of the desired power, based on either an RF conducted or a radiated measurement, provided the transmitter demonstrates compliance with the peak conducted power limits. If the transmitter complies with the conducted power limits based on the use of RMS averaging over a time interval, as permitted under paragraph (b)(3) of this section, the attenuation required under this paragraph shall be 30 dB instead of 20 dB. Attenuation below the general limits specified in §15.209(a) is not required. In addition, radiated emissions which fall in the restricted bands, as defined in §15.205(a), must also comply with the radiated emission limits specified in §15.209(a) (see §15.205(c)).

2.9.3 Equipment Under Test and Modification State

Serial No: N/A /Default Test Configuration

2.9.4 Date of Test/Initial of test personnel who performed the test

February 26, 2016/FSC

2.9.5 Test Equipment Used

The major items of test equipment used for the above tests are identified in Section 3.1.

2.9.6 Environmental Conditions

Test performed at TÜV SÜD America Inc. Rancho Bernardo facility.

Ambient Temperature	25.0 °C
Relative Humidity	25.3 %
ATM Pressure	99.3 kPa

2.9.7 Additional Observations

- This is a conducted test.
- A TDF factor was used to compensate for the external attenuator and cable used within the frequency band.
- Span is from 9 kHz up to 26.5GHz (to cover 10th harmonic of the High Channel).
- Sweep point setting of the spectrum analyzer is set to maximum (32001).
- RBW is 100 kHz, VBW is ≥ RBW.
- Sweep is auto, detector is peak.

- Trace is max hold.
- Trace allowed to stabilize. Maximum spurious emission compared to limit.
- Limit is 20dBc (30dBc presented, worst case). EUT Complies.

2.9.8 Test Results Plots

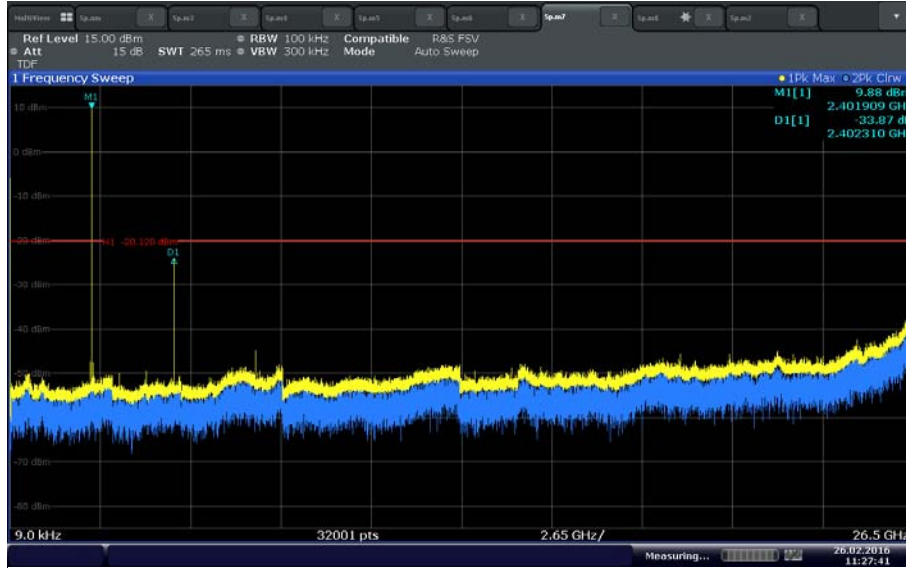

Date: 26.FEB.2016 11:27:41

Low Channel (GFSK)

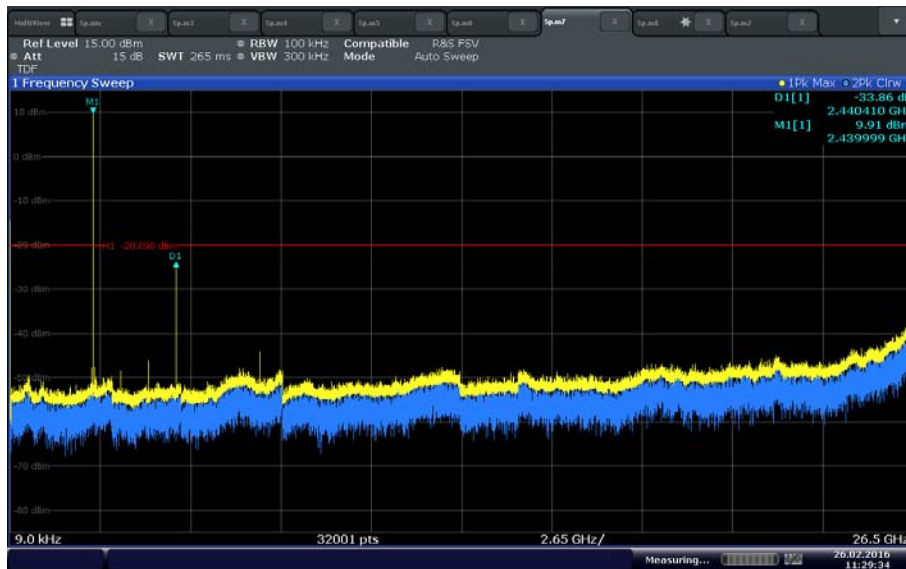

Date: 26.FEB.2016 11:29:35

Mid Channel (GFSK)

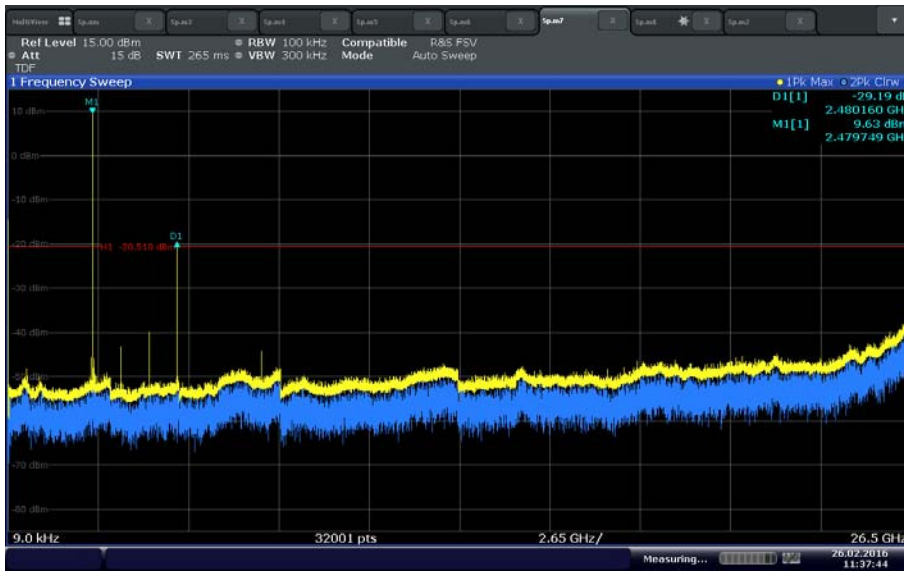

Date: 26.FEB.2016 11:37:44

High Channel (GFSK) – 2nd harmonic complies with 20dBc

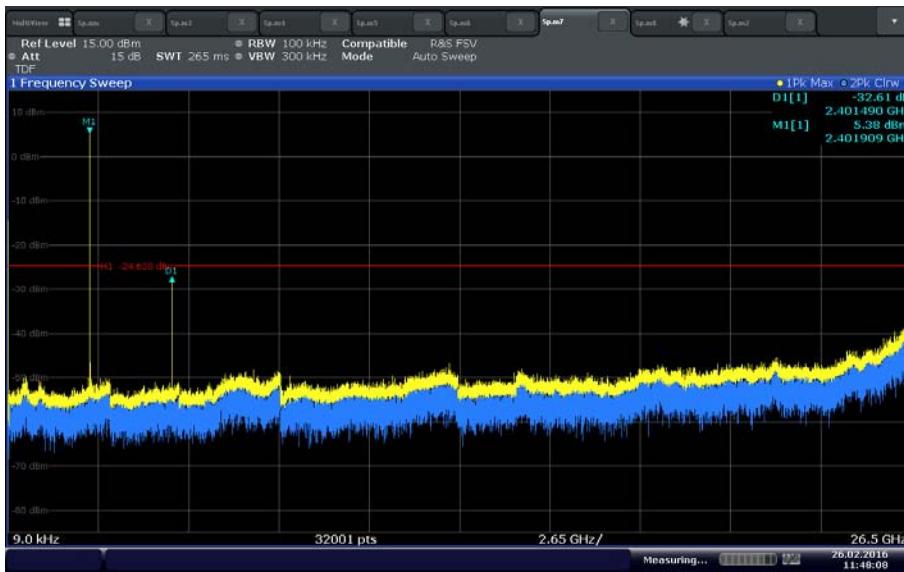

Date: 26.FEB.2016 11:48:08

Low Channel ($\pi/4$ -DQPSK)

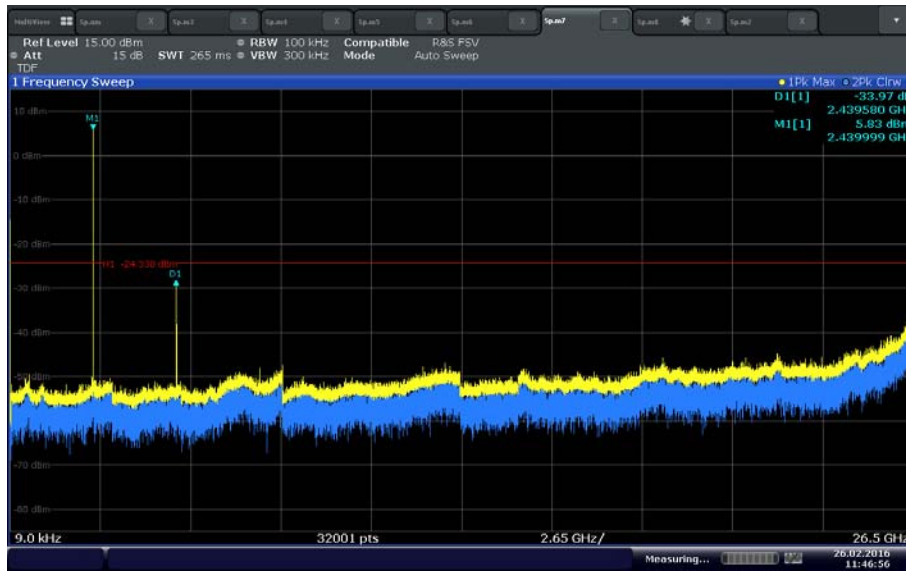

Date: 26.FEB.2016 11:46:56

Mid Channel ($\pi/4$ -DQPSK)

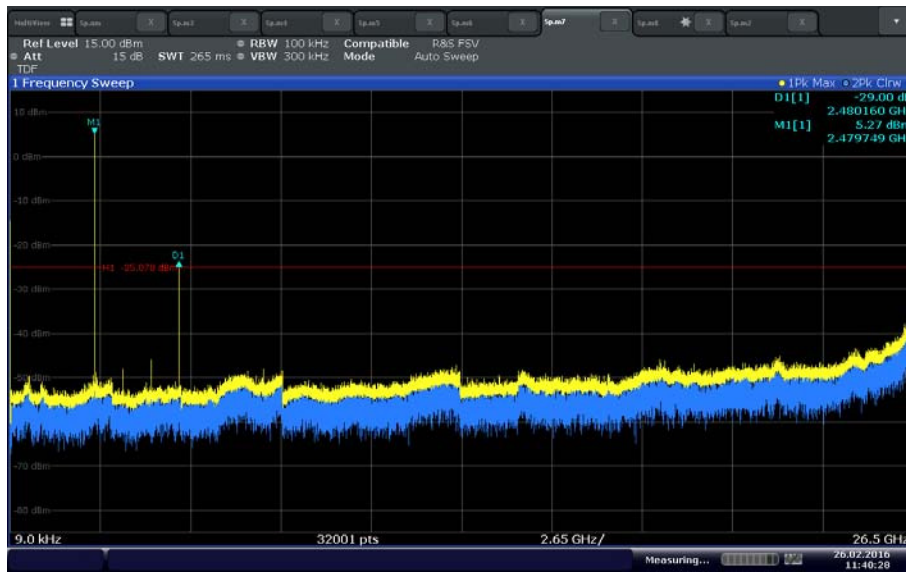

Date: 26.FEB.2016 11:40:29

High Channel ($\pi/4$ -DQPSK) – 2nd harmonic complies with 20dBc

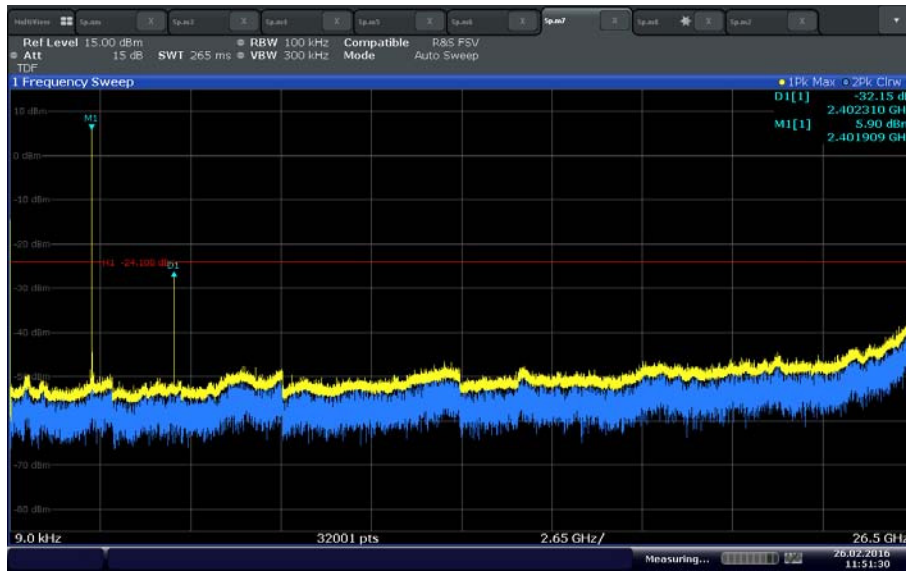

Date: 26.FEB.2016 11:51:29

Low Channel (8DPSK)

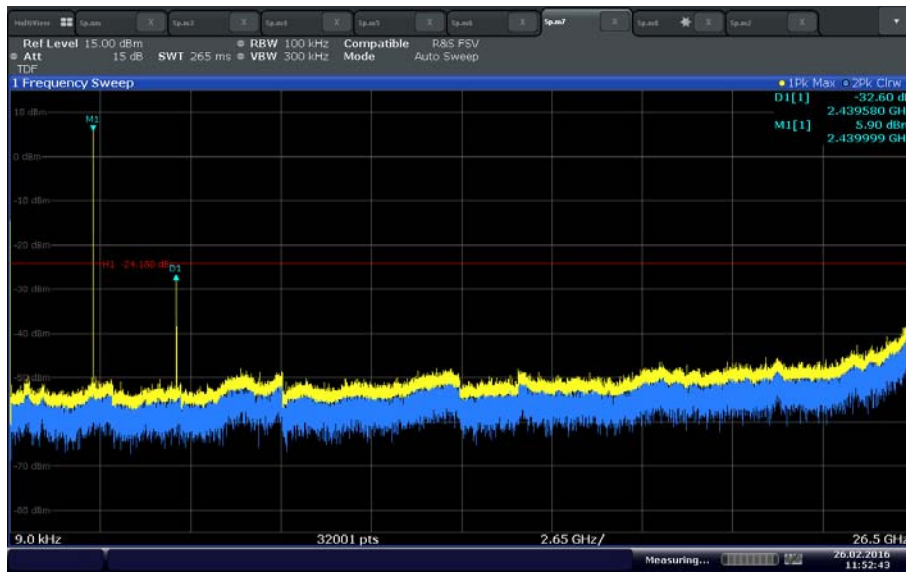

Date: 26.FEB.2016 11:52:43

Mid Channel (8DPSK)

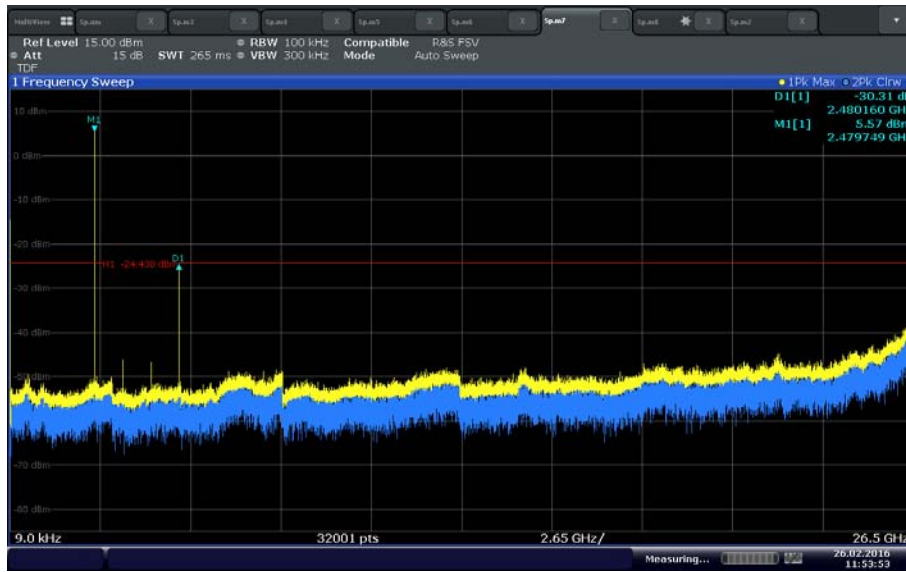

Date: 26.FEB.2016 11:53:52

High Channel (8DPSK)



2.10 SPURIOUS RADIATED EMISSIONS

2.10.1 Specification Reference

Part 15 Subpart C §15.247(d) and RSS-Gen 8.9 and 8.10

2.10.2 Standard Applicable

(d) In any 100 kHz bandwidth outside the frequency band in which the spread spectrum or digitally modulated intentional radiator is operating, the radio frequency power that is produced by the intentional radiator shall be at least 20 dB below that in the 100 kHz bandwidth within the band that contains the highest level of the desired power, based on either an RF conducted or a radiated measurement, provided the transmitter demonstrates compliance with the peak conducted power limits. If the transmitter complies with the conducted power limits based on the use of RMS averaging over a time interval, as permitted under paragraph (b)(3) of this section, the attenuation required under this paragraph shall be 30 dB instead of 20 dB. Attenuation below the general limits specified in §15.209(a) is not required. In addition, radiated emissions which fall in the restricted bands, as defined in §15.205(a), must also comply with the radiated emission limits specified in §15.209(a) (see §15.205(c)).

2.10.3 Equipment Under Test and Modification State

Serial No: N/A / Default Test Configuration

2.10.4 Date of Test/Initial of test personnel who performed the test

March 08, 2016/FSC

2.10.5 Test Equipment Used

The major items of test equipment used for the above tests are identified in Section 3.1.

2.10.6 Environmental Conditions

Test performed at TÜV SÜD America Inc. Rancho Bernardo facility

Ambient Temperature	22.8 °C
Relative Humidity	37.7 %
ATM Pressure	99.0 kPa

2.10.7 Additional Observations

- This is a radiated test. The spectrum was searched from 30MHz to the 10th harmonic.
- There are no emissions found that do not comply to the restricted bands defined in FCC Part 15 Subpart C, 15.205 or Part 15.247(d).
- Only the considered worst case configuration (low channel 8DPSK) presented for radiated emissions when not hopping. There are no significant differences in radiated emissions between the three modulation types.



- Only noise floor measurements observed above 18GHz.
- Measurement was done using EMC32 automated software. Reported level is the actual level with all the correction factors factored in. Correction Factor column is for informational purposes only. See Section 2.10.8 for sample computation.

2.10.8 **Sample Computation (Radiated Emission)**

Measuring equipment raw measurement (db μ V) @ 30 MHz		24.4
Correction Factor (dB)	Asset# 1066 (cable)	0.3
	Asset# 1172 (cable)	0.3
	Asset# 1016 (preamplifier)	-30.7
	Asset# 1175(cable)	0.3
	Asset# 1002 (antenna)	17.2
Reported QuasiPeak Final Measurement (dbμV/m) @ 30MHz		11.8

2.10.9 **Test Results**

See attached plots.



2.10.10 Test Results Below 1GHz (Bluetooth TX Worst Case – Non-hopping)

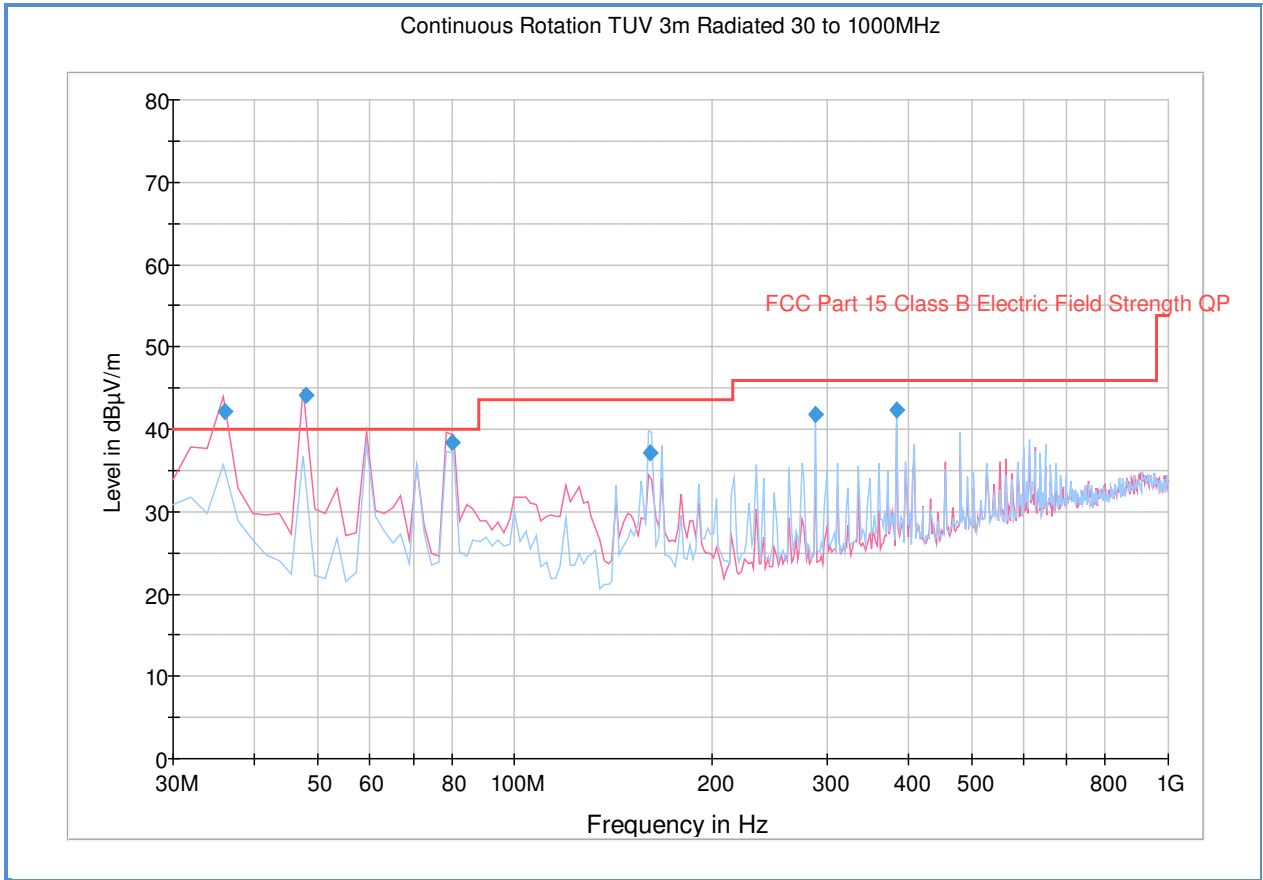

Quasi Peak Data

Frequency (MHz)	QuasiPeak (dBµV/m)	Meas. Time (ms)	Bandwidth (kHz)	Height (cm)	Polarization	Azimuth (deg)	Corr. (dB)	Margin (dB)	Limit (dBµV/m)
35.991663	42.1	1000.0	120.000	100.0	V	348.0	-8.9	-2.1	40.0
48.014990	44.1	1000.0	120.000	100.0	V	71.0	-13.6	-4.1	40.0
79.997194	38.4	1000.0	120.000	108.0	V	292.0	-16.5	1.6	40.0
161.080481	37.2	1000.0	120.000	205.0	H	69.0	-12.8	6.3	43.5
288.017074	41.8	1000.0	120.000	100.0	H	3.0	-7.8	4.2	46.0
384.027575	42.3	1000.0	120.000	100.0	H	332.0	-4.3	3.8	46.0

Test Notes: Only worst case channel presented for spurious emissions below 1GHz (Low Channel 8DPSK). 36MHz and 48MHz are not in restricted band therefore 30dBc limit applies. Since EIRP is 12.213dBm (or 107.44dBµV/m @ 3meters, from Section 2.7 of this test report) therefore the limit at these frequencies is 77 dBµV/m, EUT complies.



2.10.11 Test Results Below 1GHz (Bluetooth TX Worst Case – Hopping)

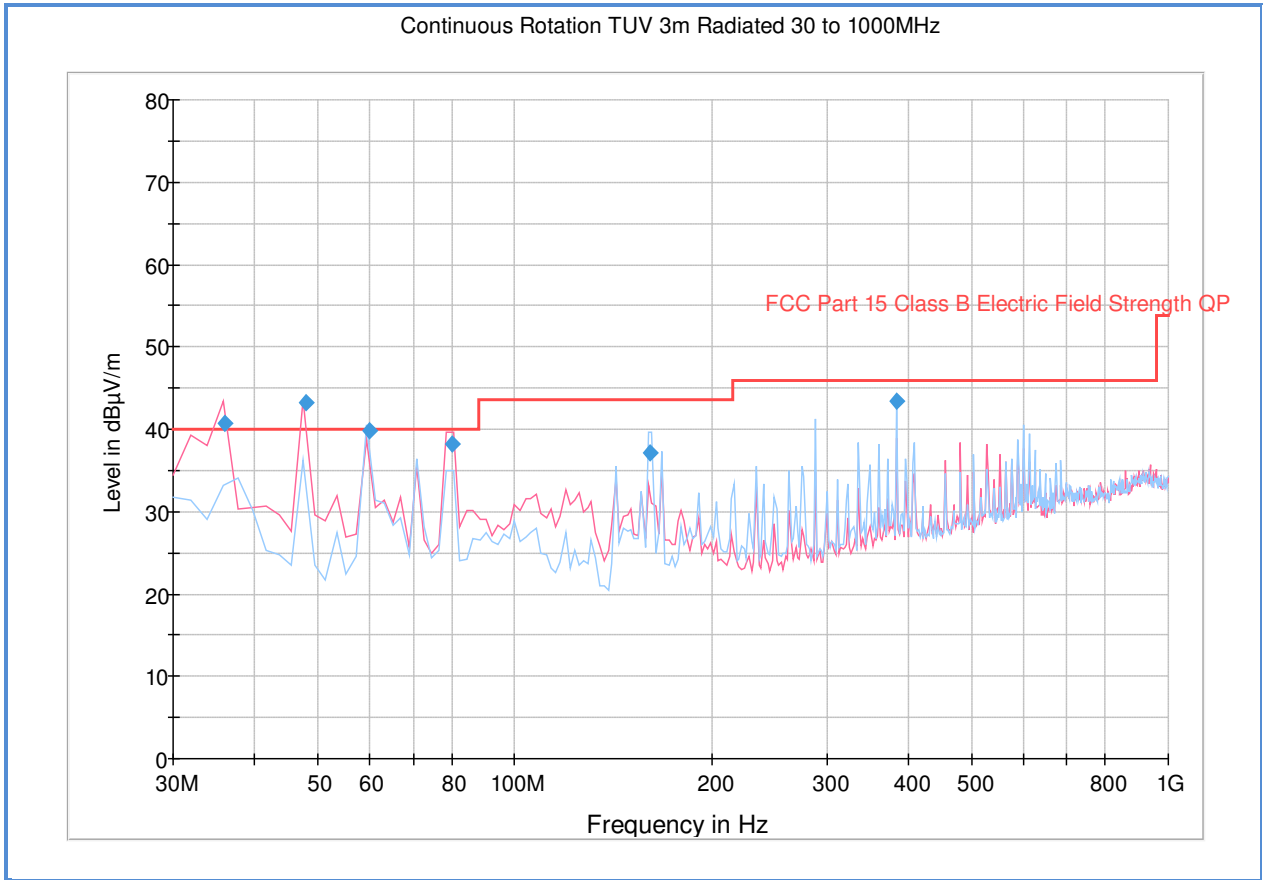

Quasi Peak Data

Frequency (MHz)	QuasiPeak (dBµV/m)	Meas. Time (ms)	Bandwidth (kHz)	Height (cm)	Polarization	Azimuth (deg)	Corr. (dB)	Margin (dB)	Limit (dBµV/m)
35.991663	40.6	1000.0	120.000	106.0	V	15.0	-8.9	-0.6	40.0
48.014990	43.2	1000.0	120.000	100.0	V	60.0	-13.6	-3.2	40.0
59.998317	39.7	1000.0	120.000	326.0	H	-13.0	-16.0	0.3	40.0
79.997194	38.3	1000.0	120.000	106.0	V	277.0	-16.5	1.7	40.0
161.064369	37.1	1000.0	120.000	188.0	H	71.0	-12.8	6.4	43.5
384.027575	43.4	1000.0	120.000	100.0	H	336.0	-4.3	2.6	46.0

Test Notes: 36MHz and 48MHz are not in restricted band therefore 30dBc limit applies. Since EIRP is 12.213dBm (or 107.44dBµV/m @ 3meters, from Section 2.7 of this test report) therefore the limit at these frequencies is 77 dBµV/m, EUT complies.

2.10.12 Test Results Above 1GHz (Bluetooth TX Worst Case – Hopping)

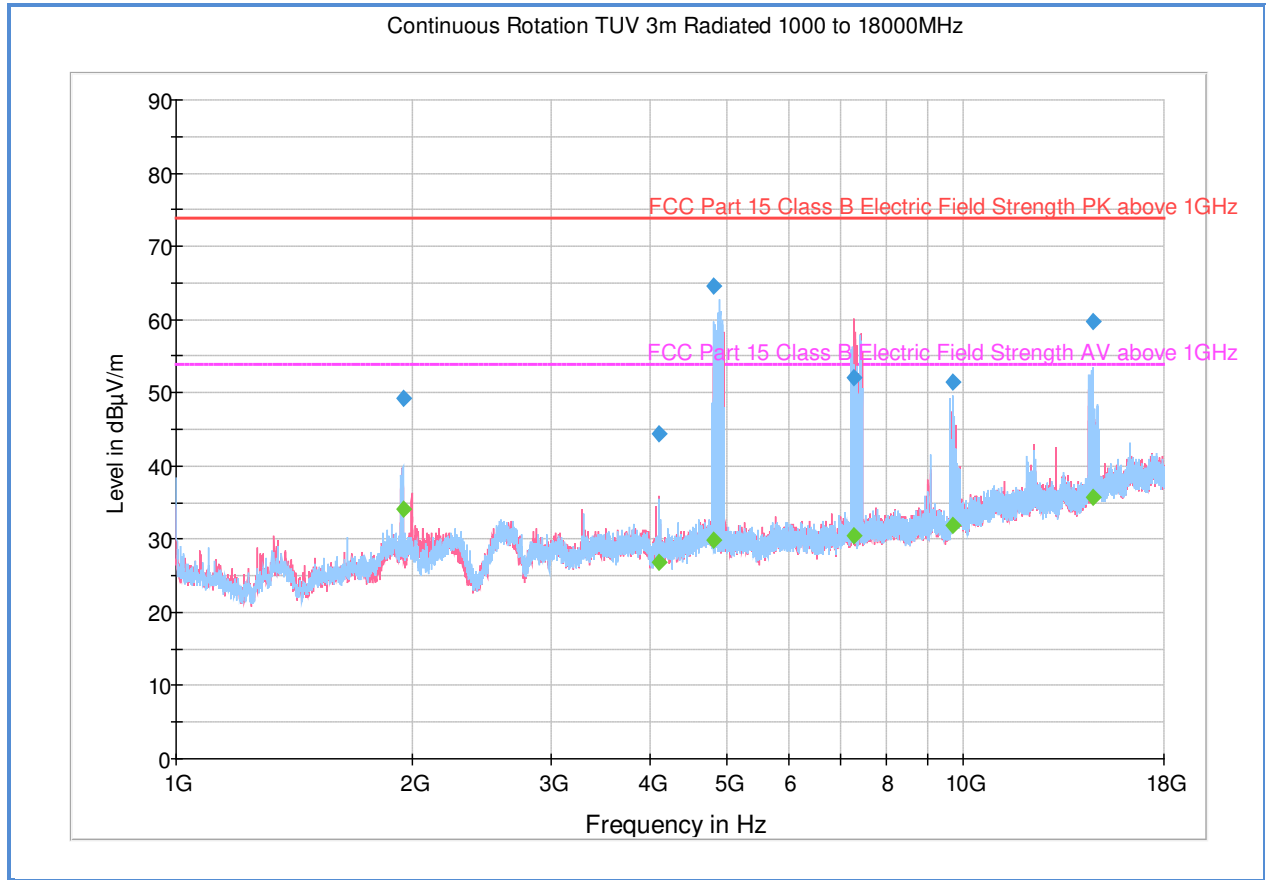

Peak Data

Frequency (MHz)	MaxPeak (dBµV/m)	Meas. Time (ms)	Bandwidth (kHz)	Height (cm)	Polarization	Azimuth (deg)	Corr. (dB)	Margin (dB)	Limit (dBµV/m)
1941.066667	49.2	1000.0	1000.000	403.9	V	10.0	-1.5	24.7	73.9
4106.666667	44.4	1000.0	1000.000	139.7	V	282.0	1.8	29.5	73.9
4820.333333	64.5	1000.0	1000.000	200.5	H	10.0	2.9	9.4	73.9
7256.933333	52.0	1000.0	1000.000	247.3	V	250.0	6.5	21.9	73.9
9688.500000	51.4	1000.0	1000.000	248.3	H	102.0	9.2	22.5	73.9
14599.066667	59.8	1000.0	1000.000	102.7	H	-3.0	14.6	14.1	73.9

Average Data

Frequency (MHz)	Average (dBµV/m)	Meas. Time (ms)	Bandwidth (kHz)	Height (cm)	Polarization	Azimuth (deg)	Corr. (dB)	Margin (dB)	Limit (dBµV/m)
1941.066667	34.0	1000.0	1000.000	403.9	V	10.0	-1.5	19.9	53.9
4106.666667	26.9	1000.0	1000.000	139.7	V	282.0	1.8	27.0	53.9
4820.333333	29.9	1000.0	1000.000	200.5	H	10.0	2.9	24.0	53.9
7256.933333	30.5	1000.0	1000.000	247.3	V	250.0	6.5	23.4	53.9
9688.500000	31.8	1000.0	1000.000	248.3	H	102.0	9.2	22.1	53.9
14599.066667	35.6	1000.0	1000.000	102.7	H	-3.0	14.6	18.3	53.9

Test Notes: Measurement was performed with a 2.4GHz notch filter. No significant emissions observed above 18GHz. Measurements above 18GHz are noise floor figures.



2.10.13 Test Results Above 1GHz Low Channel (Bluetooth TX Worst Case)

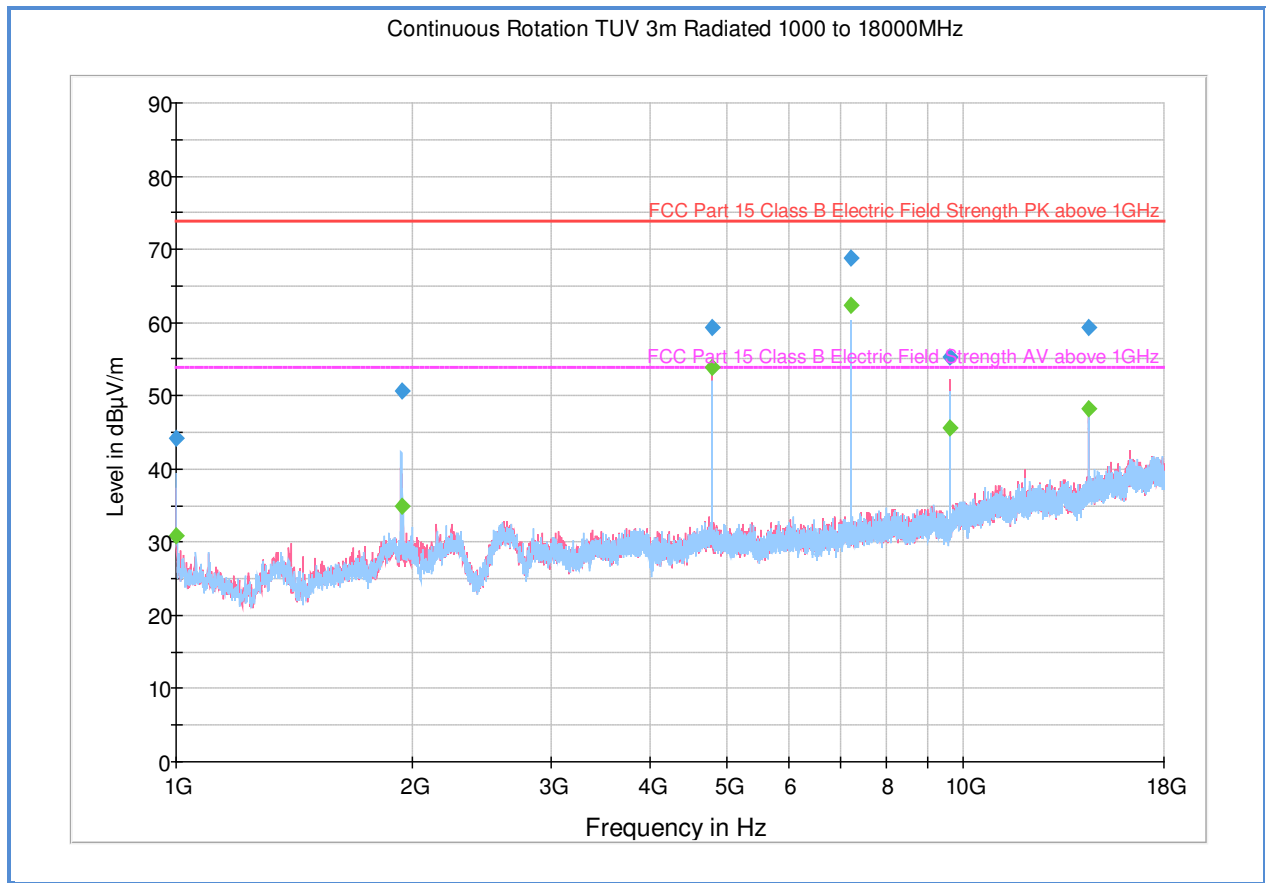

Peak Data

Frequency (MHz)	MaxPeak (dBµV/m)	Meas. Time (ms)	Bandwidth (kHz)	Height (cm)	Polarization	Azimuth (deg)	Corr. (dB)	Margin (dB)	Limit (dBµV/m)
1000.000000	44.2	1000.0	1000.000	202.3	H	100.0	-7.9	29.7	73.9
1932.766667	50.6	1000.0	1000.000	344.1	H	285.0	-1.6	23.3	73.9
4803.833333	59.4	1000.0	1000.000	123.7	V	120.0	2.9	14.5	73.9
7206.000000	68.8	1000.0	1000.000	171.6	H	49.0	6.4	5.1	73.9
9608.033333	55.2	1000.0	1000.000	148.7	V	159.0	9.0	18.7	73.9
14412.400000	59.4	1000.0	1000.000	219.4	V	137.0	14.3	14.5	73.9

Average Data

Frequency (MHz)	Average (dBµV/m)	Meas. Time (ms)	Bandwidth (kHz)	Height (cm)	Polarization	Azimuth (deg)	Corr. (dB)	Margin (dB)	Limit (dBµV/m)
1000.000000	30.9	1000.0	1000.000	202.3	H	100.0	-7.9	23.0	53.9
1932.766667	34.8	1000.0	1000.000	344.1	H	285.0	-1.6	19.1	53.9
4803.833333	53.9	1000.0	1000.000	123.7	V	120.0	2.9	0.0	53.9
7206.000000	62.4	1000.0	1000.000	171.6	H	49.0	6.4	-8.5	53.9
9608.033333	45.5	1000.0	1000.000	148.7	V	159.0	9.0	8.4	53.9
14412.400000	48.1	1000.0	1000.000	219.4	V	137.0	14.3	5.8	53.9

Test Notes: Measurement was performed with a 2.4GHz notch filter. No significant emissions observed above 18GHz. Measurements above 18GHz are noise floor figures. 7206MHz is not in restricted band therefore 30dBc limit applies (worst case). Since EIRP is 12.213dBm (or 107.44dBµV/m @ 3meters, from Section 2.7 of this test report) therefore the limit at this frequency is 77 dBµV/m, EUT complies.



2.10.14 Test Results Above 1GHz Mid Channel (Bluetooth TX Worst Case)

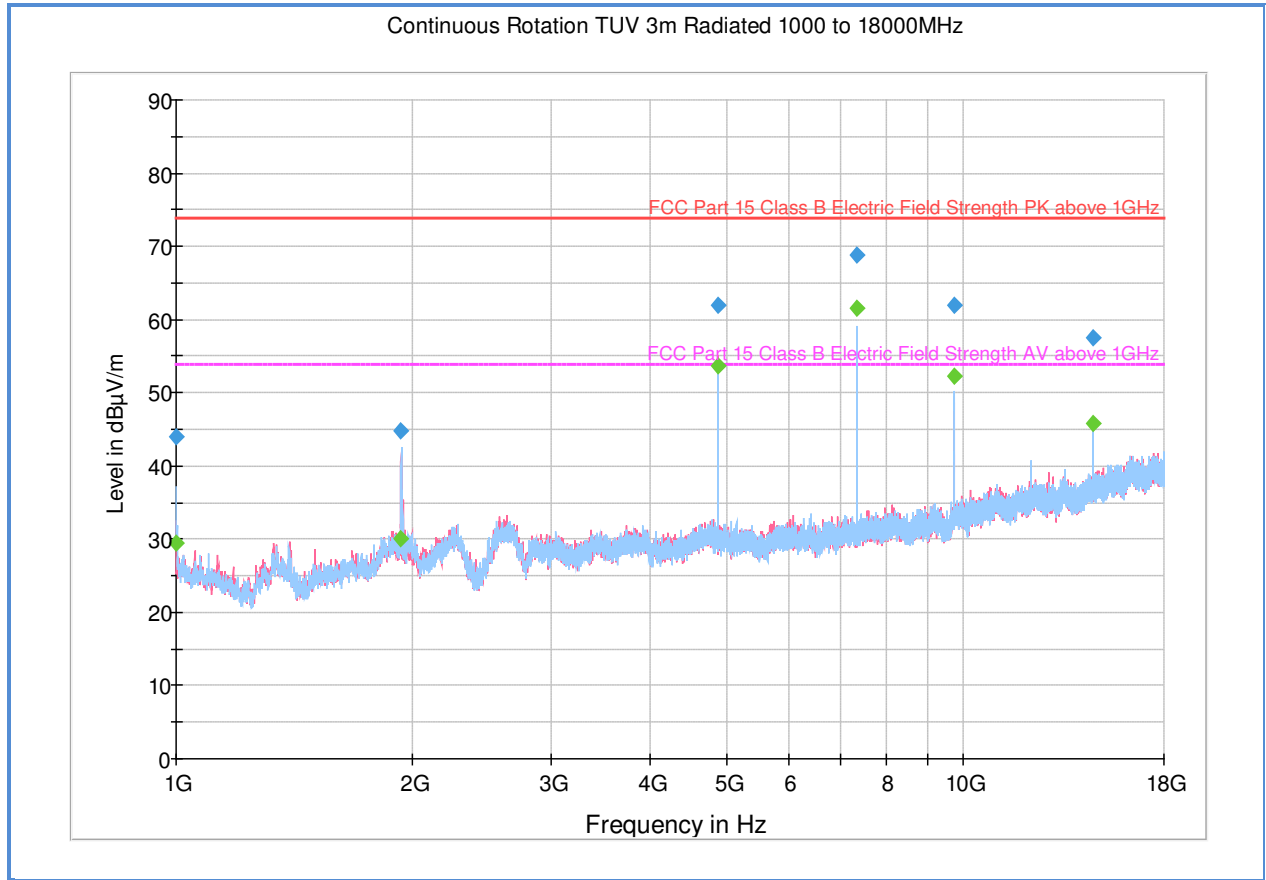

Peak Data

Frequency (MHz)	MaxPeak (dBµV/m)	Meas. Time (ms)	Bandwidth (kHz)	Height (cm)	Polarization	Azimuth (deg)	Corr. (dB)	Margin (dB)	Limit (dBµV/m)
1000.400000	43.9	1000.0	1000.000	201.3	H	-10.0	-7.9	30.0	73.9
1932.533333	44.9	1000.0	1000.000	290.2	H	0.0	-1.6	29.0	73.9
4879.966667	62.0	1000.0	1000.000	116.7	V	57.0	2.8	11.9	73.9
7320.466667	68.8	1000.0	1000.000	218.4	H	140.0	6.6	5.1	73.9
9760.466667	61.9	1000.0	1000.000	197.5	H	128.0	9.5	12.0	73.9
14640.766667	57.5	1000.0	1000.000	312.2	V	123.0	14.8	16.4	73.9

Average Data

Frequency (MHz)	Average (dBµV/m)	Meas. Time (ms)	Bandwidth (kHz)	Height (cm)	Polarization	Azimuth (deg)	Corr. (dB)	Margin (dB)	Limit (dBµV/m)
1000.400000	29.5	1000.0	1000.000	201.3	H	-10.0	-7.9	24.4	53.9
1932.533333	30.0	1000.0	1000.000	290.2	H	0.0	-1.6	23.9	53.9
4879.966667	53.6	1000.0	1000.000	116.7	V	57.0	2.8	0.3	53.9
7320.466667	61.5	1000.0	1000.000	218.4	H	140.0	6.6	-7.6	53.9
9760.466667	52.3	1000.0	1000.000	197.5	H	128.0	9.5	1.6	53.9
14640.766667	45.9	1000.0	1000.000	312.2	V	123.0	14.8	8.0	53.9

Test Notes: Measurement was performed with a 2.4GHz notch filter. No significant emissions observed above 18GHz. Measurements above 18GHz are noise floor figures. Measurement performed using Peak and Average detector at 100% duty cycle. Average measurements not in compliance using this method will be re-assessed by applying Duty Cycle Correction Factor (DCCF see Section 1.4.4 of this test report). Since DCCF is -20dB from Peak measurements, therefore if Peak complies then Average also complies.



2.10.15 Test Results Above 1GHz High Channel (Bluetooth TX Worst Case)

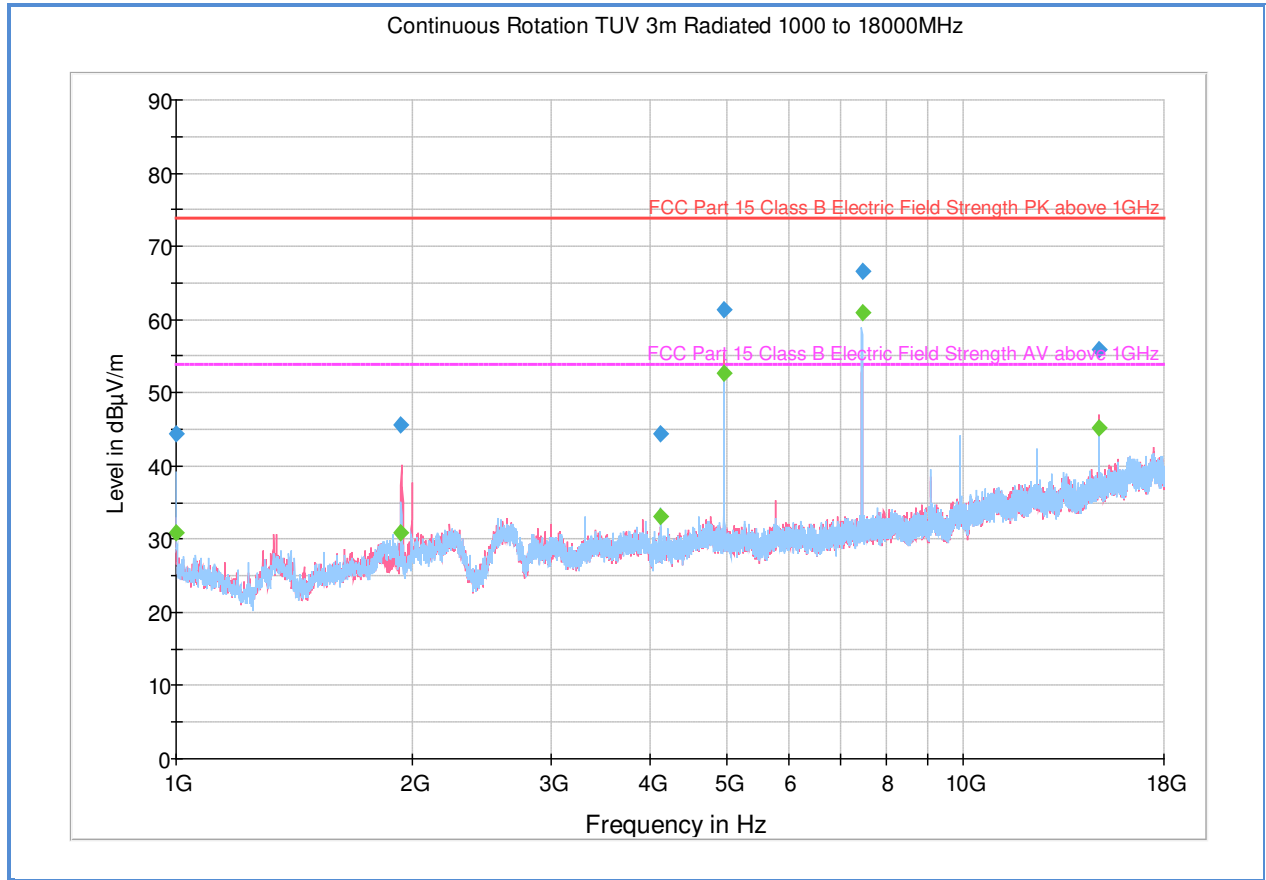

Peak Data

Frequency (MHz)	MaxPeak (dBµV/m)	Meas. Time (ms)	Bandwidth (kHz)	Height (cm)	Polarization	Azimuth (deg)	Corr. (dB)	Margin (dB)	Limit (dBµV/m)
1000.000000	44.4	1000.0	1000.000	201.3	H	120.0	-7.9	29.5	73.9
1932.533333	45.6	1000.0	1000.000	148.7	V	320.0	-1.6	28.3	73.9
4133.466667	44.3	1000.0	1000.000	258.3	H	165.0	1.8	29.6	73.9
4960.066667	61.3	1000.0	1000.000	117.7	V	62.0	2.9	12.6	73.9
7440.000000	66.5	1000.0	1000.000	201.5	H	133.0	6.8	7.4	73.9
14880.300000	55.9	1000.0	1000.000	311.2	V	122.0	15.1	18.0	73.9

Average Data

Frequency (MHz)	Average (dBµV/m)	Meas. Time (ms)	Bandwidth (kHz)	Height (cm)	Polarization	Azimuth (deg)	Corr. (dB)	Margin (dB)	Limit (dBµV/m)
1000.000000	30.9	1000.0	1000.000	201.3	H	120.0	-7.9	23.0	53.9
1932.533333	30.8	1000.0	1000.000	148.7	V	320.0	-1.6	23.1	53.9
4133.466667	33.0	1000.0	1000.000	258.3	H	165.0	1.8	20.9	53.9
4960.066667	52.6	1000.0	1000.000	117.7	V	62.0	2.9	1.3	53.9
7440.000000	60.9	1000.0	1000.000	201.5	H	133.0	6.8	-7.0	53.9
14880.300000	45.1	1000.0	1000.000	311.2	V	122.0	15.1	8.8	53.9

Test Notes: Measurement was performed with a 2.4GHz notch filter. No significant emissions observed above 18GHz. Measurements above 18GHz are noise floor figures. Measurement performed using Peak and Average detector at 100% duty cycle. Average measurements not in compliance using this method will be re-assessed by applying Duty Cycle Correction Factor (DCCF see Section 1.4.4 of this test report). Since DCCF is -20dB from Peak measurements, therefore if Peak complies then Average also complies.



2.11 RADIATED IMMEDIATE RESTRICTED BANDS

2.11.1 Specification Reference

Part 15 Subpart C §15.247(d) and RSS-Gen 8.9 and 8.10

2.11.2 Standard Applicable

(d) In any 100 kHz bandwidth outside the frequency band in which the spread spectrum or digitally modulated intentional radiator is operating, the radio frequency power that is produced by the intentional radiator shall be at least 20 dB below that in the 100 kHz bandwidth within the band that contains the highest level of the desired power, based on either an RF conducted or a radiated measurement, provided the transmitter demonstrates compliance with the peak conducted power limits. If the transmitter complies with the conducted power limits based on the use of RMS averaging over a time interval, as permitted under paragraph (b)(3) of this section, the attenuation required under this paragraph shall be 30 dB instead of 20 dB. Attenuation below the general limits specified in §15.209(a) is not required. In addition, radiated emissions which fall in the restricted bands, as defined in §15.205(a), must also comply with the radiated emission limits specified in §15.209(a) (see §15.205(c)).

2.11.3 Equipment Under Test and Modification State

Serial No: N/A / Default Test Configuration

2.11.4 Date of Test/Initial of test personnel who performed the test

March 08, 2016/FSC

2.11.5 Test Equipment Used

The major items of test equipment used for the above tests are identified in Section 3.1.

2.11.6 Environmental Conditions

Test performed at TÜV SÜD America Inc. Rancho Bernardo facility

Ambient Temperature	22.8 °C
Relative Humidity	37.7 %
ATM Pressure	99.0 kPa

2.11.7 Additional Observations

- This is a radiated test. The spectrum was searched from 2310MHz to 2390MHz for lower immediate restricted band and 2483.5MHz to 2500MHz for the upper immediate restricted band.
- There are no emissions found that do not comply with the restricted bands defined in FCC Part 15 Subpart C, 15.205.
- Both Non-hopping and Hopping modes presented.



- Measurement was done using EMC32 automated software. Reported level is the actual level with all the correction factors factored in. Correction Factor column is for informational purposes only. See Section 2.11.8 for sample computation.

2.11.8 **Sample Computation (Radiated Emission)**

Measuring equipment raw measurement (db μ V) @ 2400 MHz		53.9
Correction Factor (dB)	Asset# 1153 (cable)	3.4
	Asset# 8628(preamplifier)	-36.5
	Asset#7575 (antenna)	32.7
Reported Max Peak Final Measurement (dbμV/m) @ 2400 MHz		53.5

2.11.9 **Test Results**

See attached plots.



2.11.10 Test Results Restricted Band 2310MHz to 2390MHz (Hopping)

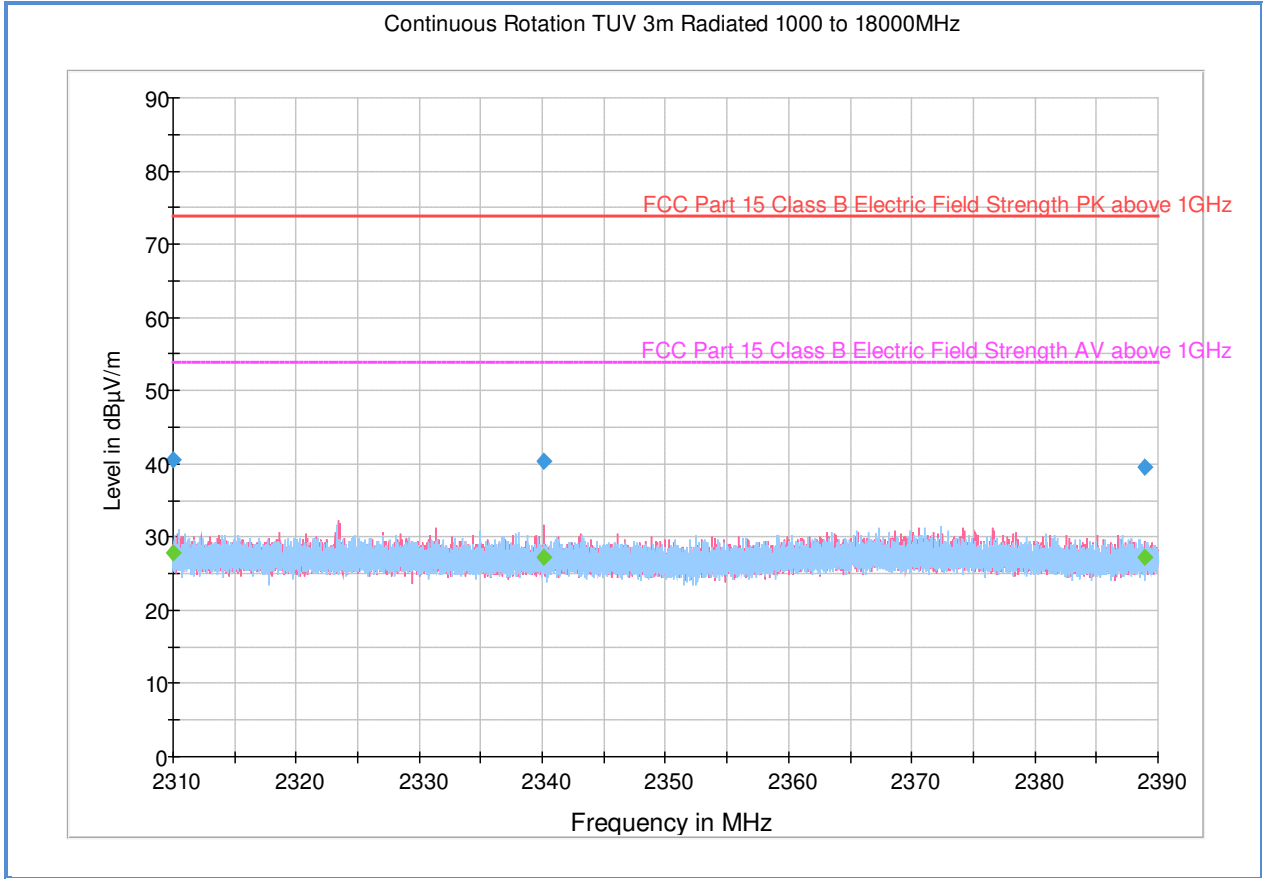

Peak Data

Frequency (MHz)	MaxPeak (dBµV/m)	Meas. Time (ms)	Bandwidth (kHz)	Height (cm)	Polarization	Azimuth (deg)	Corr. (dB)	Margin (dB)	Limit (dBµV/m)
2310.000000	40.7	1000.0	1000.000	201.5	H	156.0	-1.3	33.2	73.9
2340.104000	40.4	1000.0	1000.000	192.5	V	254.0	-1.4	33.5	73.9
2388.896000	39.5	1000.0	1000.000	183.5	V	22.0	-1.3	34.4	73.9

Average Data

Frequency (MHz)	Average (dBµV/m)	Meas. Time (ms)	Bandwidth (kHz)	Height (cm)	Polarization	Azimuth (deg)	Corr. (dB)	Margin (dB)	Limit (dBµV/m)
2310.000000	27.8	1000.0	1000.000	201.5	H	156.0	-1.3	26.1	53.9
2340.104000	27.2	1000.0	1000.000	192.5	V	254.0	-1.4	26.7	53.9
2388.896000	27.2	1000.0	1000.000	183.5	V	22.0	-1.3	26.7	53.9

Test Notes: 2.4GHz notch filter removed for this test.



2.11.11 Test Results Restricted Band 2310MHz to 2390MHz (Non-Hopping)

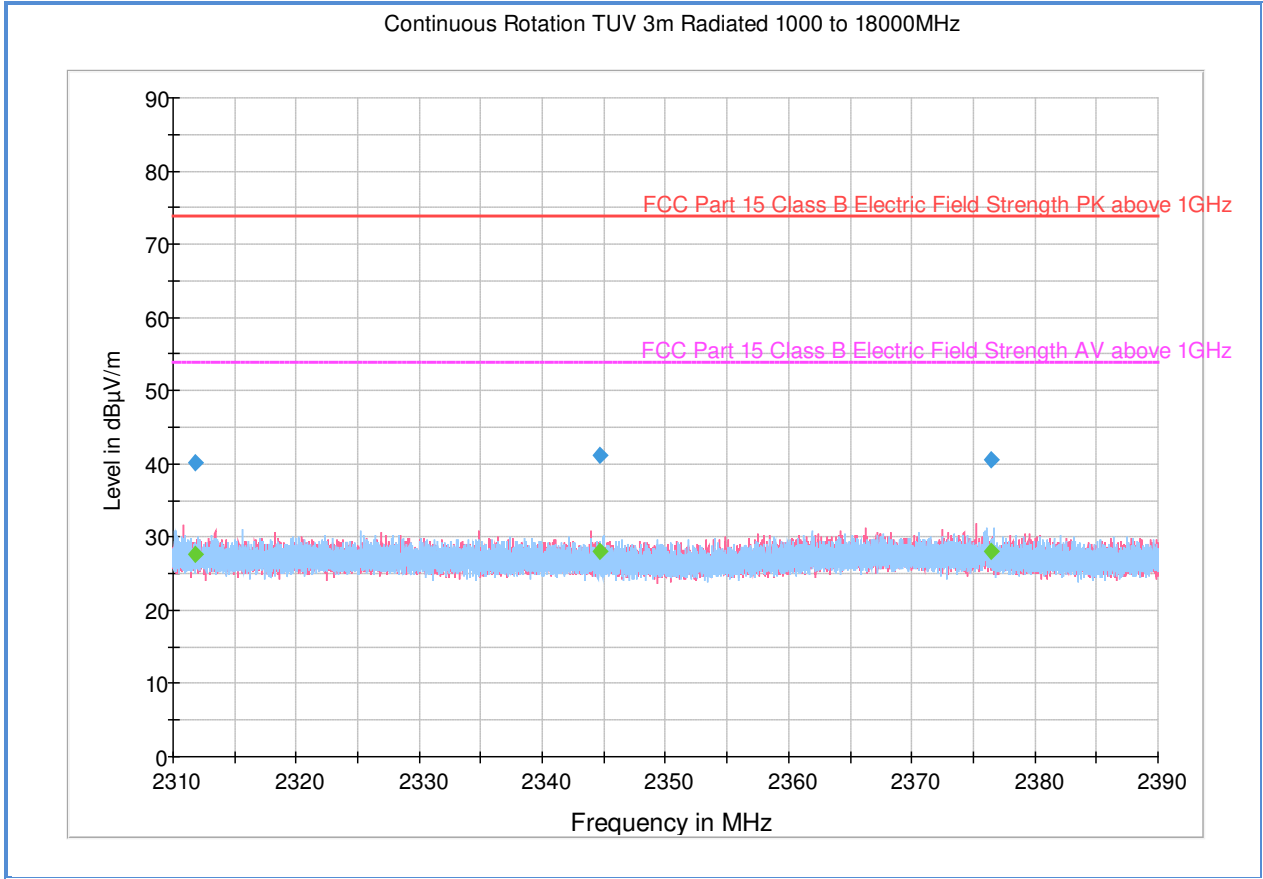

Peak Data

Frequency (MHz)	MaxPeak (dBµV/m)	Meas. Time (ms)	Bandwidth (kHz)	Height (cm)	Polarization	Azimuth (deg)	Corr. (dB)	Margin (dB)	Limit (dBµV/m)
2311.818667	40.1	1000.0	1000.000	131.7	V	18.0	-1.3	33.8	73.9
2344.701333	41.2	1000.0	1000.000	174.6	V	75.0	-1.4	32.7	73.9
2376.458667	40.6	1000.0	1000.000	132.7	H	166.0	-1.4	33.3	73.9

Average Data

Frequency (MHz)	Average (dBµV/m)	Meas. Time (ms)	Bandwidth (kHz)	Height (cm)	Polarization	Azimuth (deg)	Corr. (dB)	Margin (dB)	Limit (dBµV/m)
2311.818667	27.6	1000.0	1000.000	131.7	V	18.0	-1.3	26.3	53.9
2344.701333	28.0	1000.0	1000.000	174.6	V	75.0	-1.4	25.9	53.9
2376.458667	28.1	1000.0	1000.000	132.7	H	166.0	-1.4	25.8	53.9

Test Notes: 2.4GHz notch filter removed for this test.



2.11.12 Test Results Restricted Band 2483.5MHz to 2500MHz (Hopping)

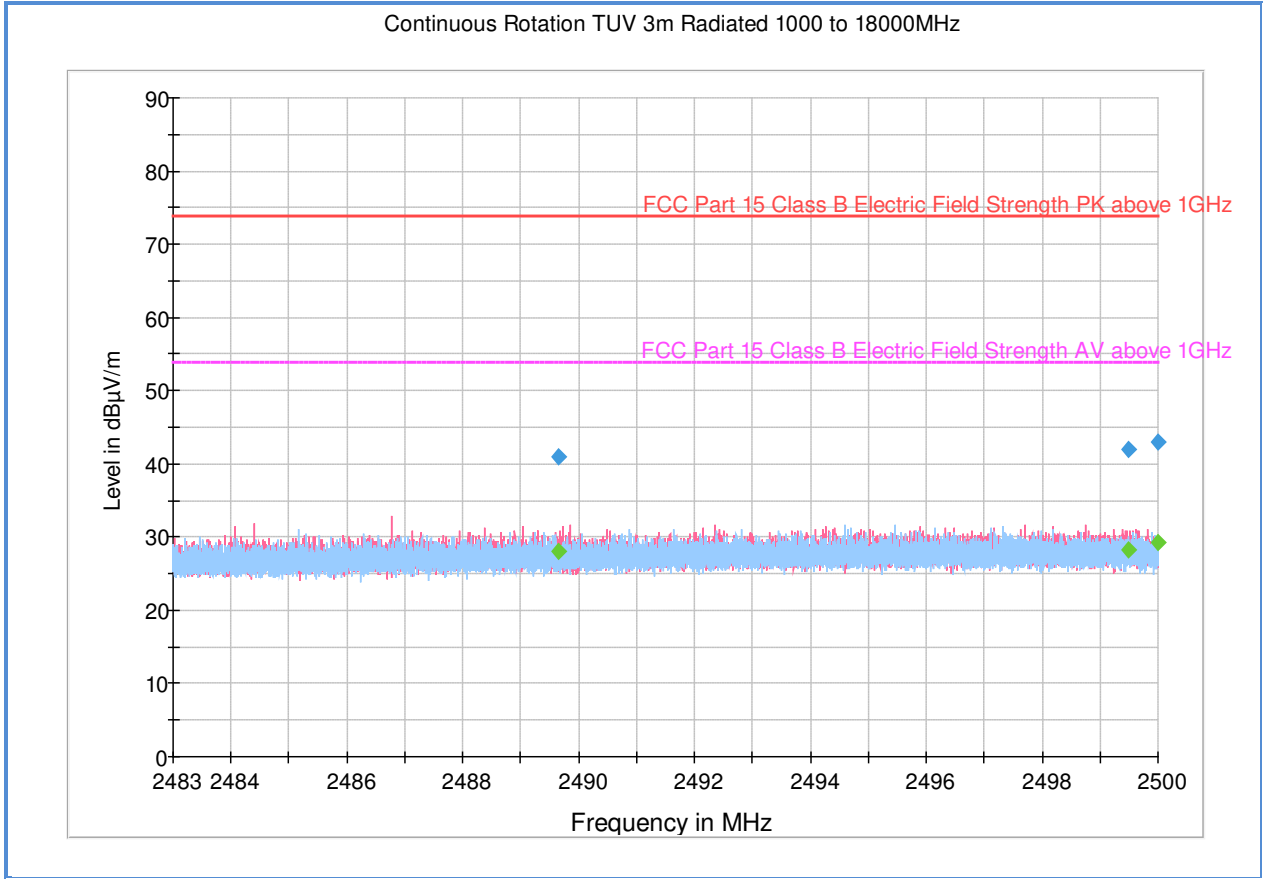

Peak Data

Frequency (MHz)	MaxPeak (dBµV/m)	Meas. Time (ms)	Bandwidth (kHz)	Height (cm)	Polarization	Azimuth (deg)	Corr. (dB)	Margin (dB)	Limit (dBµV/m)
2489.658367	40.9	1000.0	1000.000	191.5	V	20.0	-0.8	33.0	73.9
2499.500000	41.9	1000.0	1000.000	117.7	V	6.0	-0.8	32.0	73.9
2500.000000	43.1	1000.0	1000.000	103.7	V	343.0	-0.8	30.8	73.9

Average Data

Frequency (MHz)	Average (dBµV/m)	Meas. Time (ms)	Bandwidth (kHz)	Height (cm)	Polarization	Azimuth (deg)	Corr. (dB)	Margin (dB)	Limit (dBµV/m)
2489.658367	28.0	1000.0	1000.000	191.5	V	20.0	-0.8	25.9	53.9
2499.500000	28.2	1000.0	1000.000	117.7	V	6.0	-0.8	25.7	53.9
2500.000000	29.3	1000.0	1000.000	103.7	V	343.0	-0.8	24.6	53.9

Test Notes: 2.4GHz notch filter removed for this test.



2.11.13 Test Results Restricted Band 2483.5MHz to 2500MHz (Non-Hopping)

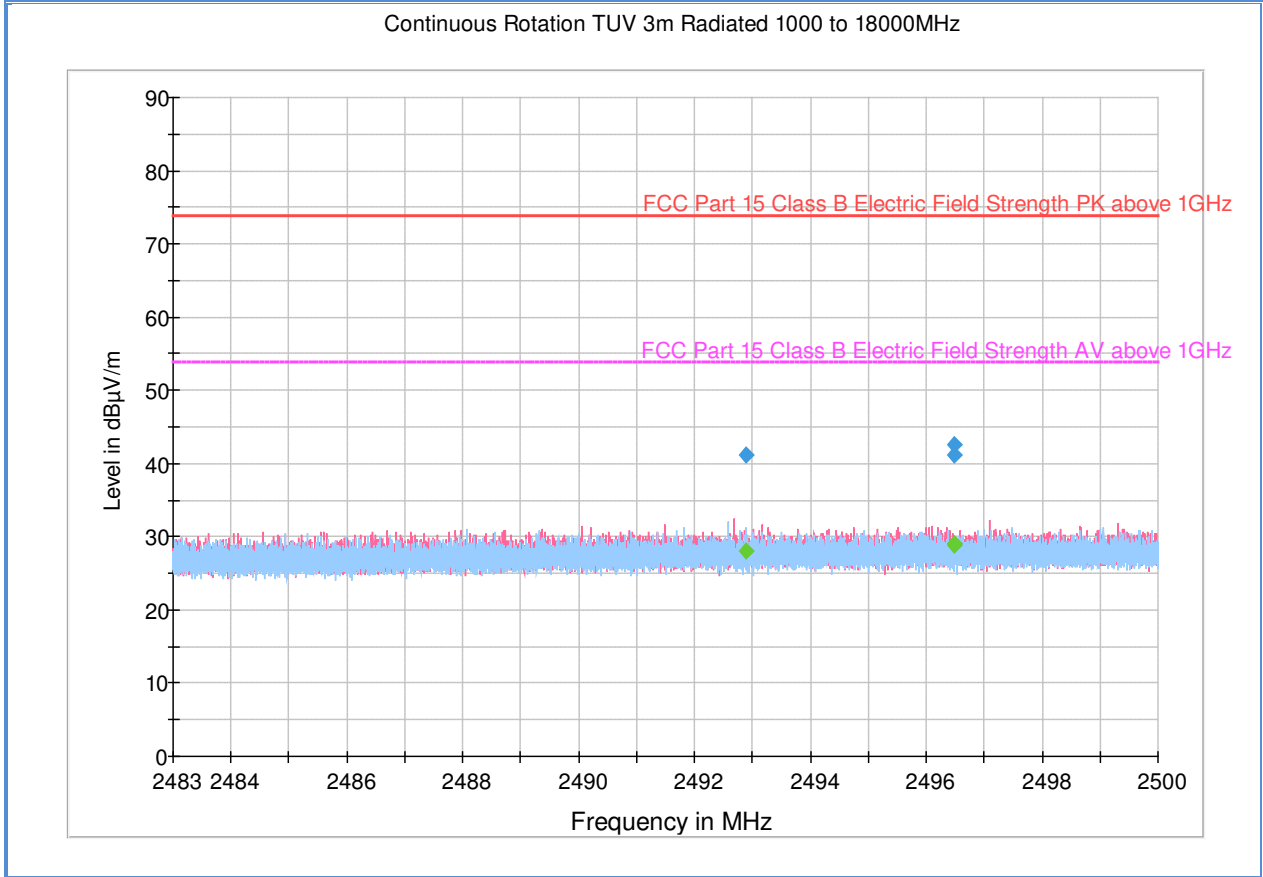

Peak Data

Frequency (MHz)	MaxPeak (dBµV/m)	Meas. Time (ms)	Bandwidth (kHz)	Height (cm)	Polarization	Azimuth (deg)	Corr. (dB)	Margin (dB)	Limit (dBµV/m)
2492.892833	41.1	1000.0	1000.000	124.7	V	191.0	-0.8	32.8	73.9
2496.483367	41.3	1000.0	1000.000	166.6	V	275.0	-0.8	32.6	73.9
2496.483367	42.5	1000.0	1000.000	103.7	V	343.0	-0.8	31.4	73.9

Average Data

Frequency (MHz)	Average (dBµV/m)	Meas. Time (ms)	Bandwidth (kHz)	Height (cm)	Polarization	Azimuth (deg)	Corr. (dB)	Margin (dB)	Limit (dBµV/m)
2492.892833	28.0	1000.0	1000.000	124.7	V	191.0	-0.8	25.9	53.9
2496.483367	28.8	1000.0	1000.000	166.6	V	275.0	-0.8	25.1	53.9
2496.483367	29.1	1000.0	1000.000	103.7	V	343.0	-0.8	24.8	53.9

Test Notes: 2.4GHz notch filter removed for this test.



SECTION 3

TEST EQUIPMENT USED



3.1 TEST EQUIPMENT USED

List of absolute measuring and other principal items of test equipment.

ID Number (SDGE/SDRB)	Test Equipment	Type	Serial Number	Manufacturer	Cal Date	Cal Due Date
Antenna Conducted Port Setup						
7624	USB Wideband Power Sensor	55340	9543	Boonton	02/12/16	02/12/18
7611	Signal/Spectrum Analyzer	FSW26	102017	Rhode & Schwarz	02/01/16	02/01/17
7608	Vector Signal Generator	SMBV100A	259021	Rhode & Schwarz	07/29/15	07/29/16
8825	20dB Attenuator	46-20-34	BK5773	Weinschel Corp.	Verified by 7608 and 7611	
Radiated Test Setup						
1002	Bilog Antenna	3142C	00058717	ETS-Lindgren	01/30/14	01/30/16
1040	EMI Test Receiver	ESIB40	100292	Rhode & Schwarz	08/29/14	08/29/15
1016	Pre-amplifier	PAM-0202	187	PAM	12/10/14	12/10/15
1051	Double-ridged waveguide horn antenna	3115	9408-4329	EMCO	02/28/14	02/28/16
1049	EMI Test Receiver	ESU	100133	Rhode & Schwarz	03/11/15	03/11/16
8628	Pre-amplifier	QLJ 01182835-JO	8986002	QuinStar Technologies Inc.	03/20/15	03/20/16
1150	Horn antenna	3160-09	012054-004	ETS	07/16/15	07/16/17
1151	Pre-amplifier	TS-PR26	100026	Rhode & Schwarz	05/08/15	05/08/16
1153	High-frequency cable	SucoFlex 100 SX	N/A	Suhner	Verified by 7608 and 7611	
8543	High-frequency cable	Micropore 19057793	N/A	United Microwave Products	Verified by 7608 and 7611	
6815	2.4GHz Band Notch Filter	BRM50702	008	Micro-Tronics	Verified by 7608 and 7611	
Miscellaneous						
6792	Multimeter	3478A	2911A70964	Hewlett Packard	08/14/15	08/14/16
7560	Barometer/Temperature/Humidity Transmitter	iBTHX-W	1240476	Omega	10/19/15	10/19/16
	Test Software	EMC32	V8.53	Rhode & Schwarz	N/A	



3.2 MEASUREMENT UNCERTAINTY

For a 95% confidence level, the measurement uncertainties for defined systems are:

3.2.1 Radiated Measurements (Below 1GHz)

Contribution		Probability Distribution Type	Probability Distribution x_i	Standard Uncertainty $u(x_i)$	$[u(x_i)]^2$
1	Receiver/Spectrum Analyzer	Rectangular	0.45	0.26	0.07
2	Cables	Rectangular	0.50	0.29	0.08
3	Preamp	Rectangular	0.50	0.29	0.08
4	Antenna	Rectangular	0.75	0.43	0.19
5	Site	Rectangular	2.70	1.56	2.43
6	EUT Setup	Rectangular	1.00	0.58	0.33
Combined Uncertainty (u_c):					1.78
Coverage Factor (k):					2
Expanded Uncertainty:					3.57

3.2.2 Radiated Emission Measurements (Above 1GHz)

Contribution		Probability Distribution Type	Probability Distribution x_i	Standard Uncertainty $u(x_i)$	$[u(x_i)]^2$
1	Receiver/Spectrum Analyzer	Rectangular	0.57	0.33	0.11
2	Cables	Rectangular	0.70	0.40	0.16
3	Preamp	Rectangular	0.50	0.29	0.08
4	Antenna	Rectangular	0.37	0.21	0.05
5	Site	Rectangular	2.70	1.56	2.43
6	EUT Setup	Rectangular	1.00	0.58	0.33
Combined Uncertainty (u_c):					1.78
Coverage Factor (k):					2
Expanded Uncertainty:					3.56

3.2.3 Conducted Antenna Port Measurement

Contribution		Probability Distribution Type	Probability Distribution x_i	Standard Uncertainty $u(x_i)$	$[u(x_i)]^2$
1	Receiver/Spectrum Analyzer	Rectangular	0.57	0.33	0.11
2	Cables	Rectangular	0.50	0.29	0.08
3	EUT Setup	Rectangular	1.00	0.58	0.33
Combined Uncertainty (u_c):					0.72
Coverage Factor (k):					2
Expanded Uncertainty:					1.45



SECTION 4

DIAGRAM OF TEST SETUP

4.1 TEST SETUP DIAGRAM

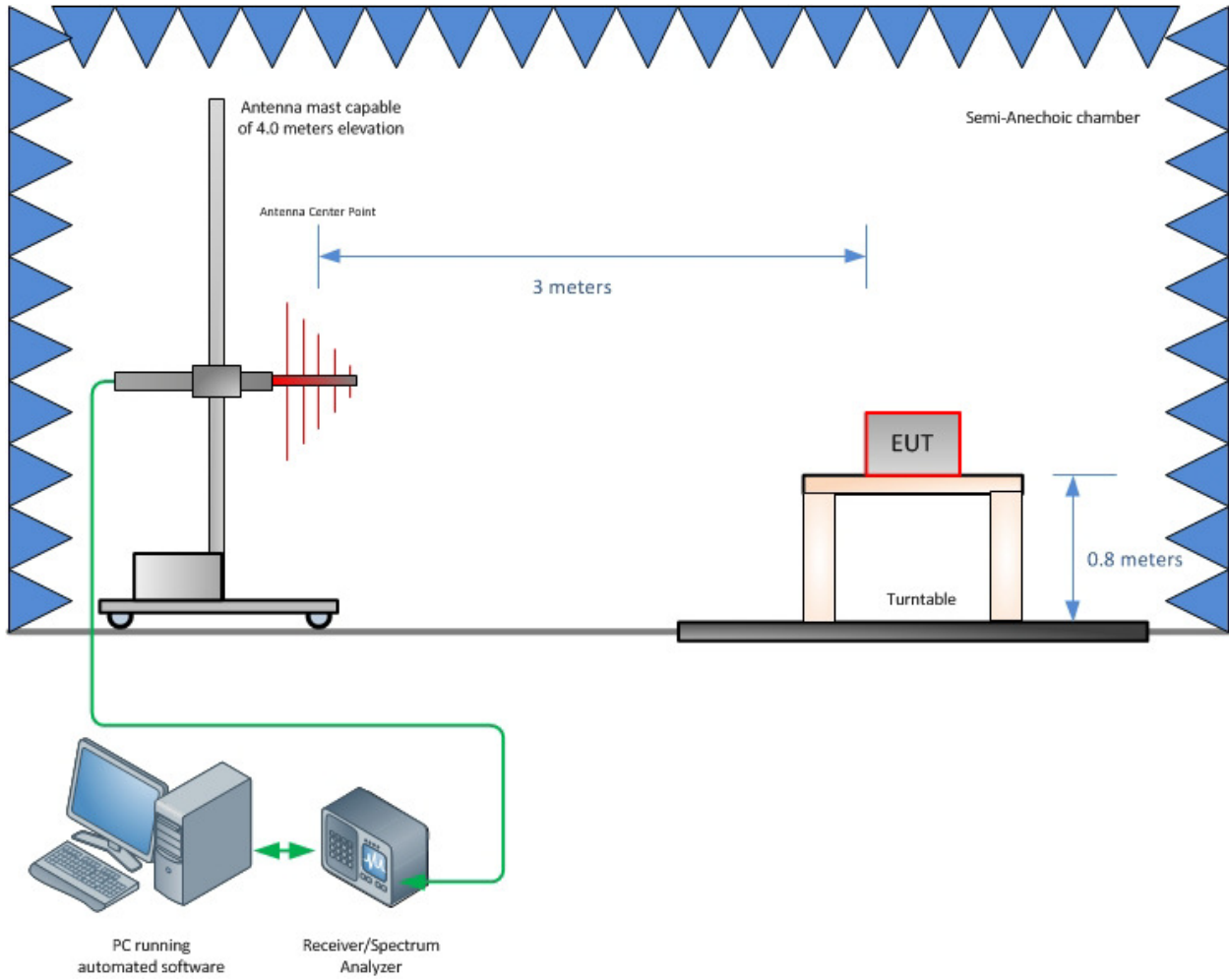

Radiated Emission Test Setup (Below 1GHz)

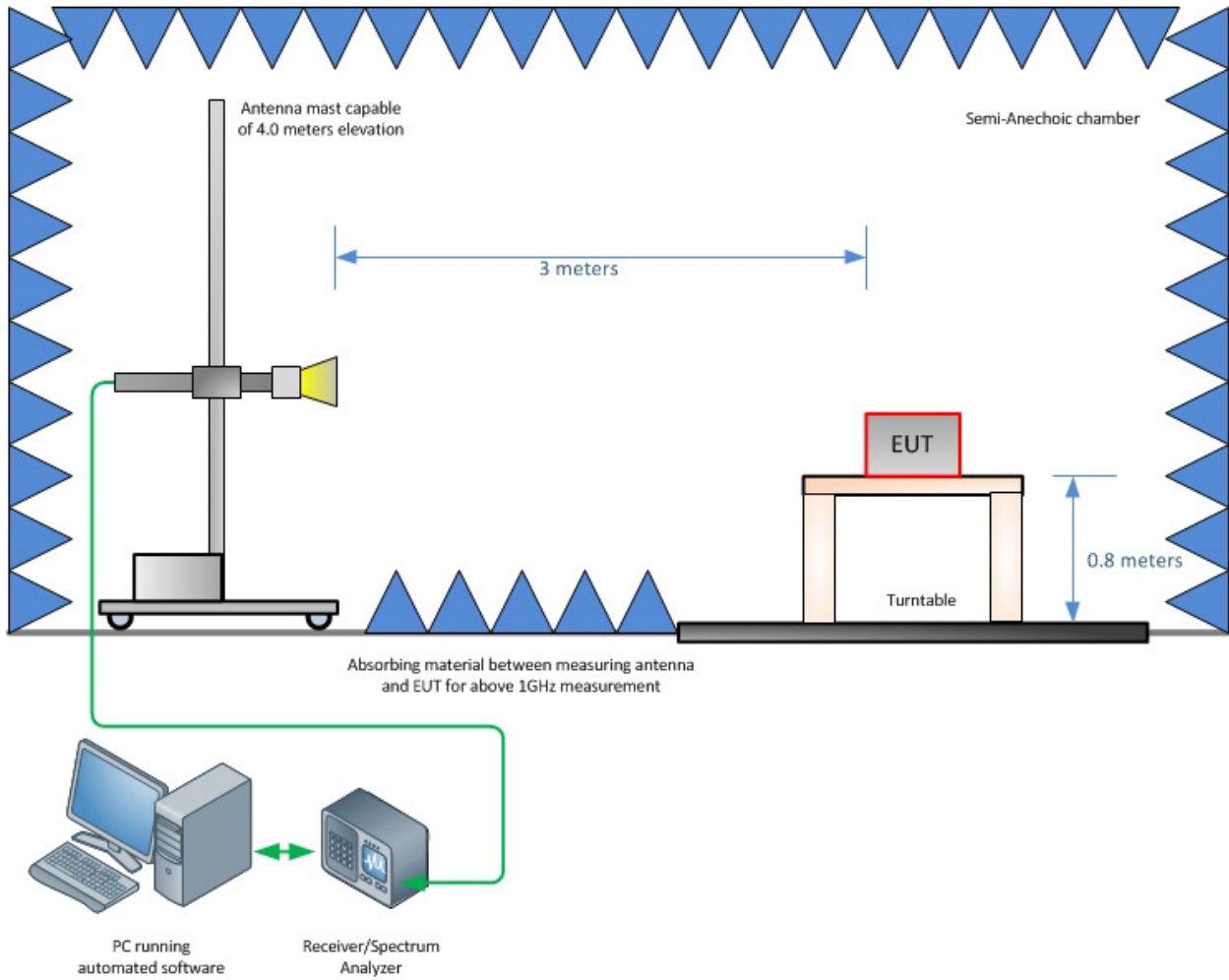

Radiated Emission Test Setup (Above 1GHz)



SECTION 5

ACCREDITATION, DISCLAIMERS AND COPYRIGHT



5.1 **ACCREDITATION, DISCLAIMERS AND COPYRIGHT**

TÜV SÜD America Inc.'s reports apply only to the specific sample tested under stated test conditions. It is the manufacturer's responsibility to assure the continued compliance of production units of this model. TÜV SÜD America, Inc. shall have no liability for any deductions, inferences or generalizations drawn by the client or others from TÜV SÜD America, Inc.'s issued reports.

This report is the confidential property of the client. As a mutual protection to our clients, the public and TÜV SÜD America, Inc., extracts from the test report shall not be reproduced, except in full without TÜV SÜD America, Inc.'s written approval.

This report must not be used to claim product certification, approval, or endorsement by A2LA, NIST, or any agency of the federal government.

TÜV SÜD America, Inc. and its professional staff hold government and professional organization certifications for AAMI, ACIL, AEA, ANSI, IEEE, A2LA, NIST and VCCI.



A2LA Cert. No. 2955.13

