

## PART 27 / RSS-199 MEASUREMENT REPORT

**Applicant Name:**

Telit Communications S.p.A  
Viale Stazione di Prosecco 5/b  
34010, Trieste, Italy

**Date of Testing:**

5/12 - 6/1/2021

**Test Site/Location:**

PCTEST Lab. Columbia, MD, USA

**Test Report Serial No.:**

1M2106040065-07.RI7

<b>FCC ID:</b>	<b>RI7LE910CXWWX</b>
<b>IC:</b>	<b>5131A-LE910CXWWX</b>
<b>Applicant Name:</b>	<b>Telit Communications S.p.A</b>

**Application Type:**

Certification

**Model/HVIN:**

LE910C4-WWX

**Additional Model/HVIN (s):**

LE910C1-WWX

**EUT Type:**

Data Terminal Module

**FCC Classification:**

PCS Licensed Transmitter (PCB)

**FCC Rule Part:**

27

**ISED Specification:**

RSS-199 Issue 3

**Test Procedure(s):**

ANSI C63.26-2015, ANSI/TIA-603-E-2016, KDB 971168 D01 v03r01

This equipment has been shown to be capable of compliance with the applicable technical standards as indicated in the measurement report and was tested in accordance with the measurement procedures specified in §2.947. Test results reported herein relate only to the item(s) tested.

I attest to the accuracy of data. All measurements reported herein were performed by me or were made under my supervision and are correct to the best of my knowledge and belief. I assume full responsibility for the completeness of these measurements and vouch for the qualifications of all persons taking them.



\_\_\_\_\_  
Randy Ortanez  
President



<b>FCC ID:</b> RI7LE910CXWWX <b>IC:</b> 5131A-LE910CXWWX	 <b>PART 27 / RSS-199 MEASUREMENT REPORT</b>	<b>Approved by:</b> Technical Manager
<b>Test Report S/N:</b> 1M2106040065-07.RI7	<b>Test Dates:</b> 5/12 - 6/1/2021	<b>EUT Type:</b> Data Terminal Module
		Page 1 of 42

# TABLE OF CONTENTS

1.0	INTRODUCTION .....	4
1.1	Scope .....	4
1.2	PCTEST Test Location.....	4
1.3	Test Facility / Accreditations.....	4
2.0	PRODUCT INFORMATION.....	5
2.1	Equipment Description .....	5
2.2	Device Capabilities.....	5
2.3	Test Configuration .....	5
2.4	Software and Firmware .....	5
2.5	EMI Suppression Device(s)/Modifications .....	5
3.0	DESCRIPTION OF TESTS .....	6
3.1	Evaluation Procedure .....	6
3.2	BRS/EBS Frequency Block.....	6
3.3	Radiated Power and Radiated Spurious Emissions .....	7
4.0	MEASUREMENT UNCERTAINTY .....	8
5.0	TEST EQUIPMENT CALIBRATION DATA .....	9
6.0	SAMPLE CALCULATIONS .....	10
7.0	TEST RESULTS .....	11
7.1	Summary .....	11
7.2	Transmitter Conducted Output Power/ Equivalent Isotropic Radiated Power .....	12
7.3	Occupied Bandwidth .....	14
7.4	Spurious and Harmonic Emissions at Antenna Terminal .....	19
7.5	Band Edge Emissions at Antenna Terminal .....	25
7.6	Peak-Average Ratio .....	30
7.7	Radiated Spurious Emissions Measurements.....	35
7.8	Frequency Stability / Temperature Variation .....	40
8.0	CONCLUSION.....	42

<b>FCC ID:</b> RI7LE910CXWWX <b>IC:</b> 5131A-LE910CXWWX	 <b>PART 27 / RSS-199 MEASUREMENT REPORT</b>	<b>Approved by:</b> Technical Manager
<b>Test Report S/N:</b> 1M2106040065-07.RI7	<b>Test Dates:</b> 5/12 - 6/1/2021	<b>EUT Type:</b> Data Terminal Module

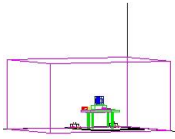

## PART 27 / RSS-199 MEASUREMENT REPORT

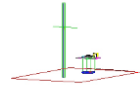

Mode	Bandwidth	Modulation	Tx Frequency Range [MHz]	EIRP		Emission Designator
				Max. Power [W]	Max. Power [dBm]	
LTE Band 7	20 MHz	QPSK	2510.0 - 2560.0	0.351	25.45	18M0G7D
		16QAM	2510.0 - 2560.0	0.272	24.34	18M0W7D
	15 MHz	QPSK	2507.5 - 2562.5	0.357	25.53	13M5G7D
		16QAM	2507.5 - 2562.5	0.291	24.64	13M5W7D
	10 MHz	QPSK	2505.0 - 2565.0	0.365	25.62	8M99G7D
		16QAM	2505.0 - 2565.0	0.286	24.56	9M02W7D
	5 MHz	QPSK	2502.5 - 2567.5	0.353	25.47	4M52G7D
		16QAM	2502.5 - 2567.5	0.256	24.08	4M51W7D

**EUT Overview**

<b>FCC ID:</b> RI7LE910CXWWX <b>IC:</b> 5131A-LE910CXWWX	 <b>PART 27 / RSS-199 MEASUREMENT REPORT</b>	<b>Approved by:</b> Technical Manager
<b>Test Report S/N:</b> 1M2106040065-07.RI7	<b>Test Dates:</b> 5/12 - 6/1/2021	<b>EUT Type:</b> Data Terminal Module
		Page 3 of 42

## 1.0 INTRODUCTION

### 1.1 Scope

Measurement and determination of electromagnetic emissions (EMC) of radio frequency devices including intentional and/or unintentional radiators for compliance with the technical rules and regulations of the Federal Communications Commission and the Innovation, Science and Economic Development Canada.

### 1.2 PCTEST Test Location

These measurement tests were conducted at the PCTEST facility located at 7185 Oakland Mills Road, Columbia, MD 21046. The measurement facility is compliant with the test site requirements specified in ANSI C63.4-2014.

### 1.3 Test Facility / Accreditations

**Measurements were performed at PCTEST Engineering Lab located in Columbia, MD 21046, U.S.A.**

- PCTEST is an ISO 17025-2017 accredited test facility under the American Association for Laboratory Accreditation (A2LA) with Certificate number 2041.01 for Specific Absorption Rate (SAR), Hearing Aid Compatibility (HAC) testing, where applicable, and Electromagnetic Compatibility (EMC) testing for FCC and Innovation, Science, and Economic Development Canada rules.
- PCTEST TCB is a Telecommunication Certification Body (TCB) accredited to ISO/IEC 17065-2012 by A2LA (Certificate number 2041.03) in all scopes of FCC Rules and ISED Standards (RSS).
- PCTEST facility is a registered (2451B) test laboratory with the site description on file with ISED.

<b>FCC ID:</b> RI7LE910CXWWX <b>IC:</b> 5131A-LE910CXWWX	 <b>PART 27 / RSS-199 MEASUREMENT REPORT</b>	<b>Approved by:</b> Technical Manager
<b>Test Report S/N:</b> 1M2106040065-07.RI7	<b>Test Dates:</b> 5/12 - 6/1/2021	<b>EUT Type:</b> Data Terminal Module  Page 4 of 42

## 2.0 PRODUCT INFORMATION

### 2.1 Equipment Description

The Equipment Under Test (EUT) is the **Telit Communications S.p.A Data Terminal Module FCC ID: RI7LE910CXWWX / IC:5131A-LE910CXWWX**. The test data contained in this report pertains only to the emissions due to the EUT's licensed transmitters that operate under the provisions of Part 27 & RSS-199.

This FCC and IC ID covers operations for two different versions of this module. The LE910C4-WWX is the Cat. 4 LTE version module and the LE910C1-WWX is the Cat. 1 LTE version of this module. Cat. 1 and Cat. 4 LTE only differ in the speed/throughput and have not been noted to have any impact on the RF itself. Both modules were investigated and the LE910C4-WWX was tested fully to represent both versions of the module.

**Test Device Serial No.:** 96014, 95001

### 2.2 Device Capabilities

This device contains the following capabilities:

GSM/GPRS/EDGE, WCDMA/HSPA, LTE

### 2.3 Test Configuration

The EUT was tested per the guidance of ANSI/TIA-603-E-2016 and KDB 971168 D01 v03r01. See Section 7.0 of this test report for a description of the radiated and antenna port conducted emissions tests.

### 2.4 Software and Firmware

The test was conducted with firmware version M0F.503003 for LE910C4-WWX and M0F.103003 for LE910C1-WWX installed on the EUT.

### 2.5 EMI Suppression Device(s)/Modifications

No EMI suppression device(s) were added and no modifications were made during testing.

<b>FCC ID:</b> RI7LE910CXWWX <b>IC:</b> 5131A-LE910CXWWX	 <b>PART 27 / RSS-199 MEASUREMENT REPORT</b>	<b>Approved by:</b> Technical Manager
<b>Test Report S/N:</b> 1M2106040065-07.RI7	<b>Test Dates:</b> 5/12 - 6/1/2021	<b>EUT Type:</b> Data Terminal Module  Page 5 of 42

## 3.0 DESCRIPTION OF TESTS

### 3.1 Evaluation Procedure

The measurement procedures described in the “Land Mobile FM or PM – Communications Equipment – Measurements and Performance Standards” (ANSI/TIA-603-E-2016) and “Measurement Guidance for Certification of Licensed Digital Transmitters” (KDB 971168 D01 v03r01) were used in the measurement of the EUT.

Deviation from Measurement Procedure.....None

### 3.2 BRS/EBS Frequency Block

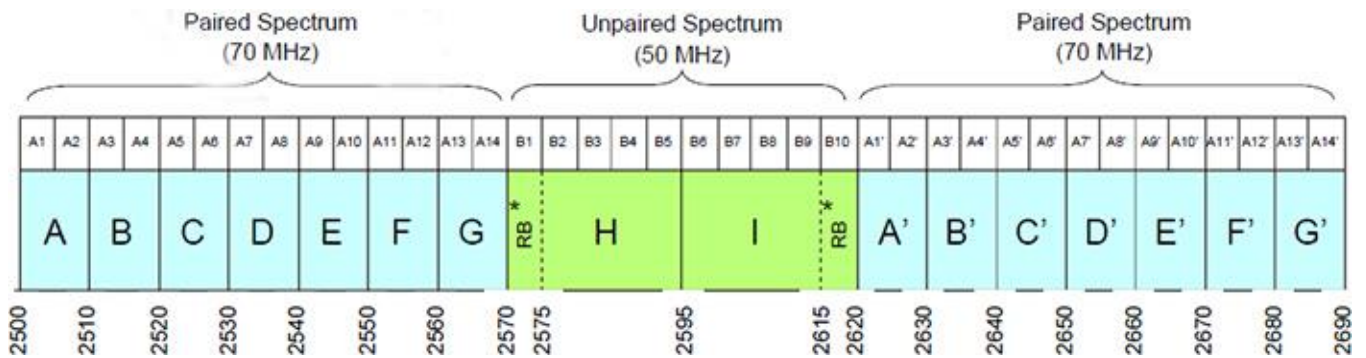

FCC ID: RI7LE910CXWWX IC:5131A-LE910CXWWX	 PCTEST Proud to be part of element	PART 27 / RSS-199 MEASUREMENT REPORT	Approved by: Technical Manager
Test Report S/N: 1M2106040065-07.RI7	Test Dates: 5/12 - 6/1/2021	EUT Type: Data Terminal Module	Page 6 of 42

### 3.3 Radiated Power and Radiated Spurious Emissions

The radiated test facilities consisted of an indoor 3 meter semi-anechoic chamber used for final measurements and exploratory measurements, when necessary. The measurement area is contained within the semi-anechoic chamber which is shielded from any ambient interference. The test site inside the chamber is a 6m x 5.2m elliptical, obstruction-free area in accordance with Figure 5.7 of Clause 5 in ANSI C63.4-2014. Absorbers are arranged on the floor between the turn table and the antenna mast in such a way so as to maximize the reduction of reflections for measurements above 1GHz. For measurements below 1GHz, the absorbers are removed. A raised turntable is used for radiated measurement. The turn table is a continuously rotatable, remote-controlled, metallic turntable and 2 meters (6.56 ft.) in diameter. The turn table is flush with the raised floor of the chamber in order to maintain its function as a ground plane. An 80cm tall test table made of Styrodur is placed on top of the turn table. A Styrodur pedestal is placed on top of the test table to bring the total table height to 1.5m.

The equipment under test was transmitting while connected to its integral antenna and is placed on a turntable 3 meters from the receive antenna. The receive antenna height is adjusted between 1 and 4 meter height, the turntable is rotated through 360 degrees, and the EUT is manipulated through all orthogonal planes representative of its typical use to achieve the highest reading on the receive spectrum analyzer.

For radiated power measurements, substitution method is used per the guidance of ANSI/TIA-603-E-2016. A half-wave dipole is substituted in place of the EUT. For emissions above 1GHz, a horn antenna is substituted in place of the EUT. The substitute antenna is driven by a signal generator with the level of the signal generator being adjusted to obtain the same receive spectrum analyzer level previously recorded from the spurious emission from the EUT. The power of the emission is calculated using the following formula:

$$P_d \text{ [dBm]} = P_g \text{ [dBm]} - \text{cable loss [dB]} + \text{antenna gain [dBd/dBi]};$$

where  $P_d$  is the dipole equivalent power,  $P_g$  is the generator output into the substitution antenna, and the antenna gain is the gain of the substitute antenna used relative to either a half-wave dipole (dBd) or an isotropic source (dBi). The substitute level is equal to  $P_g \text{ [dBm]} - \text{cable loss [dB]}$ .

For radiated spurious emissions measurements and calculations, conversion method is used per the formulas in KDB 971168 Section 5.8.4. Field Strength (EIRP) is calculated using the following formulas:

$$E_{\text{[dB}\mu\text{V/m]}} = \text{Measured amplitude level}_{\text{[dBm]}} + 107 + \text{Cable Loss}_{\text{[dB]}} + \text{Antenna Factor}_{\text{[dB/m]}}$$

And

$$\text{EIRP}_{\text{[dBm]}} = E_{\text{[dB}\mu\text{V/m]}} + 20\log D - 104.8; \text{ where } D \text{ is the measurement distance in meters.}$$

All radiated measurements are performed in a chamber that meets the site requirements per ANSI C63.4-2014. Additionally, radiated emissions below 30MHz are also validated on an Open Area Test Site to assert correlation with the chamber measurements per the requirements of KDB 414788 D01.

Radiated power and radiated spurious emission levels are investigated with the receive antenna horizontally and vertically polarized per ANSI/TIA-603-E-2016.

<b>FCC ID:</b> RI7LE910CXWWX <b>IC:</b> 5131A-LE910CXWWX	 <b>PART 27 / RSS-199 MEASUREMENT REPORT</b>	<b>Approved by:</b> Technical Manager
<b>Test Report S/N:</b> 1M2106040065-07.R17	<b>Test Dates:</b> 5/12 - 6/1/2021	<b>EUT Type:</b> Data Terminal Module  Page 7 of 42

## 4.0 MEASUREMENT UNCERTAINTY

The measurement uncertainties shown below were calculated in accordance with the requirements of ANSI C63.4-2014. All measurement uncertainty values are shown with a coverage factor of  $k = 2$  to indicate a 95% level of confidence. The measurement uncertainty shown below meets or exceeds the  $U_{CISPR}$  measurement uncertainty values specified in CISPR 16-4-2 and, thus, can be compared directly to specified limits to determine compliance.

Contribution	Expanded Uncertainty ( $\pm$ dB)
Conducted Bench Top Measurements	1.13
Radiated Disturbance (<1GHz)	4.98
Radiated Disturbance (>1GHz)	5.07
Radiated Disturbance (>18GHz)	5.09

<b>FCC ID:</b> RI7LE910CXWWX <b>IC:</b> 5131A-LE910CXWWX	 <b>PCTEST</b> Proud to be part of element	<b>PART 27 / RSS-199 MEASUREMENT REPORT</b>	<b>Approved by:</b> Technical Manager
<b>Test Report S/N:</b> 1M2106040065-07.RI7	<b>Test Dates:</b> 5/12 - 6/1/2021	<b>EUT Type:</b> Data Terminal Module	Page 8 of 42



## 5.0 TEST EQUIPMENT CALIBRATION DATA

Test Equipment Calibration is traceable to the National Institute of Standards and Technology (NIST). Measurements antennas used during testing were calibrated in accordance to the requirements of ANSI C63.5-2017.

Manufacturer	Model	Description	Cal Date	Cal Interval	Cal Due	Serial Number
-	AP1	EMC Cable and Switch System	3/9/2021	Annual	3/9/2022	AP1
-	ETS	EMC Cable and Switch System	3/4/2021	Annual	3/4/2022	ETS
-	LTx4	Licensed Transmitter Cable Set	3/12/2021	Annual	3/12/2022	LTx4
-	LTx5	Licensed Transmitter Cable Set	3/3/2021	Annual	3/3/2022	LTx5
Agilent	E5515C	Wireless Communications Test Set	N/A			GB45360985
Anritsu	MT8820C	Radio Communication Analyzer	N/A			6201300731
Anritsu	MT8821C	Radio Communication Analyzer	N/A			6201381794
Emco	3115	Horn Antenna (1-18GHz)	6/18/2020	Biennial	6/18/2022	9704-5182
Emco	3116	Horn Antenna (18 - 40GHz)	8/7/2018	Triennial	8/7/2021	9203-2178
ETS Lindgren	3164-08	Quad Ridge Horn Antenna	3/12/2020	Biennial	3/12/2022	128337
Keysight Technologies	N9020A	MXA Signal Analyzer	9/22/2020	Annual	9/22/2021	MY54500644
Keysight Technologies	N9030A	PXA Signal Analyzer	10/16/2020	Annual	10/16/2021	MY54490576
Mini-Circuits	SSG-4000HP	Synthesized Signal Generator	N/A			11403100002
Rohde & Schwarz	CMU200	Base Station Simulator	N/A			836536/0005
Rohde & Schwarz	CMW500	Radio Communication Tester	N/A			112347
Rohde & Schwarz	ESU26	EMI Test Receiver (26.5GHz)	7/15/2020	Annual	7/15/2021	100342
Rohde & Schwarz	ESU40	EMI Test Receiver (40GHz)	9/9/2020	Annual	9/9/2021	100348
Rohde & Schwarz	ESW44	EMI Test Receiver 2Hz to 44 GHz	1/21/2021	Annual	1/21/2022	101716
Sunol	JB5	Bi-Log Antenna (30M - 5GHz)	7/27/2020	Biennial	7/27/2022	A051107

**Table 5-1. Test Equipment**

**Notes:**

1. For equipment listed above that has a calibration date or calibration due date that falls within the test date range, care was taken to ensure that this equipment was used after the calibration date and before the calibration due date.
2. Equipment with a calibration date of "N/A" shown in this list was not used to make direct calibrated measurements.

FCC ID: RI7LE910CXWWX IC:5131A-LE910CXWWX		<b>PART 27 / RSS-199 MEASUREMENT REPORT</b>	<b>Approved by:</b> Technical Manager
<b>Test Report S/N:</b> 1M2106040065-07.RI7	<b>Test Dates:</b> 5/12 - 6/1/2021	<b>EUT Type:</b> Data Terminal Module	Page 9 of 42

## 6.0 SAMPLE CALCULATIONS

### QPSK Modulation

#### Emission Designator = 8M62G7D

LTE BW = 8.62 MHz

G = Phase Modulation

7 = Quantized/Digital Info

D = Data transmission, telemetry, telecommand

### QAM Modulation

#### Emission Designator = 8M45W7D

LTE BW = 8.45 MHz

W = Amplitude/Angle Modulated

7 = Quantized/Digital Info

D = Data transmission, telemetry, telecommand

### Spurious Radiated Emission

#### Example: Spurious emission at 3700.40 MHz

The receive spectrum analyzer reading at 3 meters with the EUT on the turntable was  $-81.0$  dBm. The gain of the substituted antenna is  $8.1$  dBi. The signal generator connected to the substituted antenna terminals is adjusted to produce a reading of  $-81.0$  dBm on the spectrum analyzer. The loss of the cable between the signal generator and the terminals of the substituted antenna is  $2.0$  dB at  $3700.40$  MHz. So  $6.1$  dB is added to the signal generator reading of  $-30.9$  dBm yielding  $-24.80$  dBm. The fundamental EIRP was  $25.50$  dBm so this harmonic was  $25.50$  dBm  $- (-24.80) = 50.3$  dBc.

FCC ID: RI7LE910CXWWX IC:5131A-LE910CXWWX	 PCTEST Proud to be part of element	PART 27 / RSS-199 MEASUREMENT REPORT	Approved by: Technical Manager
Test Report S/N: 1M2106040065-07.RI7	Test Dates: 5/12 - 6/1/2021	EUT Type: Data Terminal Module	Page 10 of 42

## 7.0 TEST RESULTS

### 7.1 Summary

Company Name: Telit Communications S.p.A  
 FCC ID: RI7LE910CXWWX  
 IC: 5131A-LE910CXWWX  
 FCC Classification: PCS Licensed Transmitter (PCB)  
 Mode(s): LTE BAND7

Test Condition	Test Description	FCC Part Section(s)	RSS Section(s)	Test Limit	Test Result	Reference
<b>CONDUCTED</b>	Transmitter Conducted Output Power / Equivalent Isotropic Radiated Power (LTE BAND 7)	2.1046, 27.50(h)(2)	RSS-199(4.4)	< 2 Watts max. EIRP	PASS	Section 7.2
	Occupied Bandwidth	2.1049	RSS-Gen(6.7)	N/A	PASS	Section 7.3
	Conducted Band Edge / Spurious Emissions (LTE Band 7)	2.1051, 27.53(m)	RSS-199(4.5)	Undesirable emissions must meet the limits detailed in 27.53(m) & RSS-199(4.5)	PASS	Sections 7.4, 7.5
	Peak-Average Ratio	N/A	RSS-199(4.4)	< 13 dB	PASS	Section 7.6
	Frequency Stability	2.1055, 27.54	RSS-199(4.3)	Fundamental emissions stay within authorized frequency block	PASS	Section 7.8
<b>RADIATED</b>	Radiated Spurious Emissions (LTE Band 7)	2.1053, 27.53(m)	RSS-199(4.5)	Undesirable emissions must meet the limits detailed in 27.53(m) & RSS-199(4.5)	PASS	Section 7.7

**Table 7-1. Summary of Test Results**

#### Notes:

- 1) All modes of operation and data rates were investigated. The test results shown in the following sections represent the worst case emissions.
- 2) The analyzer plots were all taken with a correction table loaded into the analyzer. The correction table was used to account for the losses of the cables, directional couplers, and attenuators used as part of the system to maintain a link between the call box and the EUT at all frequencies of interest.
- 3) All antenna port conducted emissions testing was performed on a test bench with the antenna port of the EUT connected to the spectrum analyzer through calibrated cables, attenuators, and couplers.
- 4) All conducted emissions measurements are performed with automated test software to capture the corresponding plots necessary to show compliance. The measurement software utilized is PCTEST EMC Software Tool V1.1.

FCC ID: RI7LE910CXWWX IC:5131A-LE910CXWWX	 PCTEST Proud to be part of element	PART 27 / RSS-199 MEASUREMENT REPORT	Approved by: Technical Manager
Test Report S/N: 1M2106040065-07.RI7	Test Dates: 5/12 - 6/1/2021	EUT Type: Data Terminal Module	Page 11 of 42

## 7.2 Transmitter Conducted Output Power/ Equivalent Isotropic Radiated Power

### Test Overview

The transmitter conducted output power is a measure of the total average power contained within an allocated channel bandwidth. All modes of operation were investigated and the worst case configuration results are reported in this section.

### Test Procedure Used

ANSI C63.26-2015 – Section 5.2.4.2

### Test Settings

All conducted powers were measured using the R&S CMW500's Channel Measurement function.

### Test Setup

The EUT and measurement equipment were set up as shown in the diagram below.



**Figure 7-1. Test Instrument & Measurement Setup**

### Test Notes

The Maximum Effective Isotropic Radiated Power (EIRP) is calculated by adding the declared maximum antenna gain(dBi)

$$\text{EIRP} = \text{Conducted Power(dBm)} + \text{Antenna Gain(dBi)}$$

<b>FCC ID:</b> RI7LE910CXWWX <b>IC:</b> 5131A-LE910CXWWX	 <b>PART 27 / RSS-199 MEASUREMENT REPORT</b>	<b>Approved by:</b> Technical Manager
<b>Test Report S/N:</b> 1M2106040065-07.RI7	<b>Test Dates:</b> 5/12 - 6/1/2021	<b>EUT Type:</b> Data Terminal Module

Bandwidth	Modulation	Channel	Frequency [MHz]	RB Size/Offset	Conducted Power [dBm]	Ant Gain [dBi]	EIRP [dBm]	EIRP [Watts]	EIRP Limit [dBm]	Margin [dB]
20 MHz	QPSK	20850	2510.0	1 / 50	23.11	1.82	24.93	0.311	33.01	-8.08
		21100	2535.0	1 / 50	23.63	1.82	25.45	0.351	33.01	-7.56
		21350	2560.0	1 / 50	23.37	1.82	25.19	0.331	33.01	-7.82
	16-QAM	20850	2510.0	1 / 50	22.36	1.82	24.18	0.262	33.01	-8.83
		21100	2535.0	1 / 50	22.52	1.82	24.34	0.272	33.01	-8.67
15 MHz	QPSK	20825	2507.5	1 / 37	23.54	1.82	25.36	0.344	33.01	-7.65
		21100	2535.0	1 / 37	23.71	1.82	25.53	0.357	33.01	-7.48
		21375	2562.5	1 / 37	23.33	1.82	25.14	0.327	33.01	-7.87
	16-QAM	20825	2507.5	1 / 37	22.82	1.82	24.64	0.291	33.01	-8.37
		21100	2535.0	1 / 37	22.70	1.82	24.52	0.283	33.01	-8.49
		21375	2562.5	1 / 37	22.20	1.82	24.02	0.252	33.01	-8.99
10 MHz	QPSK	20800	2505.0	1 / 25	23.66	1.82	25.48	0.353	33.01	-7.53
		21100	2535.0	1 / 25	23.81	1.82	25.62	0.365	33.01	-7.39
		21400	2565.0	1 / 0	23.12	1.82	24.93	0.311	33.01	-8.08
	16-QAM	20800	2505.0	1 / 25	22.53	1.82	24.35	0.272	33.01	-8.66
		21100	2535.0	1 / 25	22.74	1.82	24.56	0.286	33.01	-8.45
5 MHz	QPSK	20775	2502.5	1 / 12	23.66	1.82	25.47	0.353	33.01	-7.54
		21100	2535.0	1 / 12	23.34	1.82	25.16	0.328	33.01	-7.85
		21425	2567.5	1 / 12	23.04	1.82	24.85	0.306	33.01	-8.16
	16-QAM	20775	2502.5	1 / 12	22.26	1.82	24.08	0.256	33.01	-8.93
		21100	2535.0	1 / 12	22.23	1.82	24.05	0.254	33.01	-8.96
		21425	2567.5	1 / 12	22.00	1.82	23.82	0.241	33.01	-9.19

Table 7-2. EIRP Data (LTE Band 7)

FCC ID: RI7LE910CXWWX IC:5131A-LE910CXWWX	 PCTEST Proud to be part of element	PART 27 / RSS-199 MEASUREMENT REPORT	Approved by: Technical Manager
Test Report S/N: 1M2106040065-07.RI7	Test Dates: 5/12 - 6/1/2021	EUT Type: Data Terminal Module	Page 13 of 42

## 7.3 Occupied Bandwidth

### Test Overview

The occupied bandwidth, that is the frequency bandwidth such that, below its lower and above its upper frequency limits, the mean powers radiated are each equal to 0.5 percent of the total mean power radiated by a given emission shall be measured. All modes of operation were investigated and the worst case configuration results are reported in this section.

### Test Procedure Used

KDB 971168 D01 v03r01 – Section 4.2

### Test Settings

1. The signal analyzer's automatic bandwidth measurement capability was used to perform the 99% occupied bandwidth and the 26dB bandwidth. The bandwidth measurement was not influenced by any intermediate power nulls in the fundamental emission.
2. RBW = 1 – 5% of the expected OBW
3. VBW  $\geq$  3 x RBW
4. Detector = Peak
5. Trace mode = max hold
6. Sweep = auto couple
7. The trace was allowed to stabilize
8. If necessary, steps 2 – 7 were repeated after changing the RBW such that it would be within 1 – 5% of the 99% occupied bandwidth observed in Step 7.

### Test Setup

The EUT and measurement equipment were set up as shown in the diagram below.

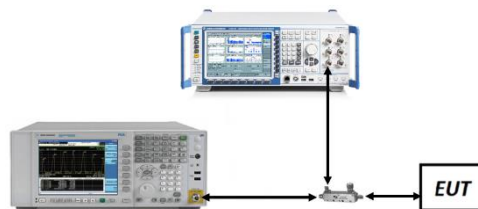



Figure 7-2. Test Instrument & Measurement Setup

### Test Notes

None.

FCC ID: RI7LE910CXWWX IC:5131A-LE910CXWWX	 PCTEST Proud to be part of element	PART 27 / RSS-199 MEASUREMENT REPORT	Approved by: Technical Manager
Test Report S/N: 1M2106040065-07.R17	Test Dates: 5/12 - 6/1/2021	EUT Type: Data Terminal Module	Page 14 of 42

## LTE Band 7

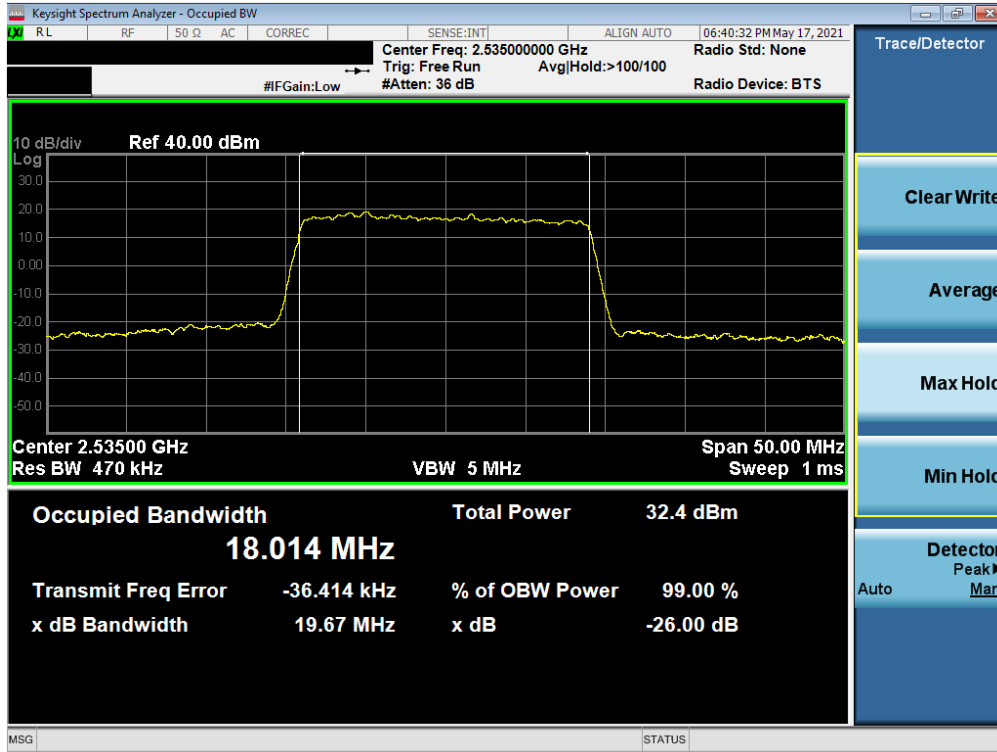

Plot 7-1. Occupied Bandwidth Plot (LTE Band 7 - 20MHz QPSK - Full RB)

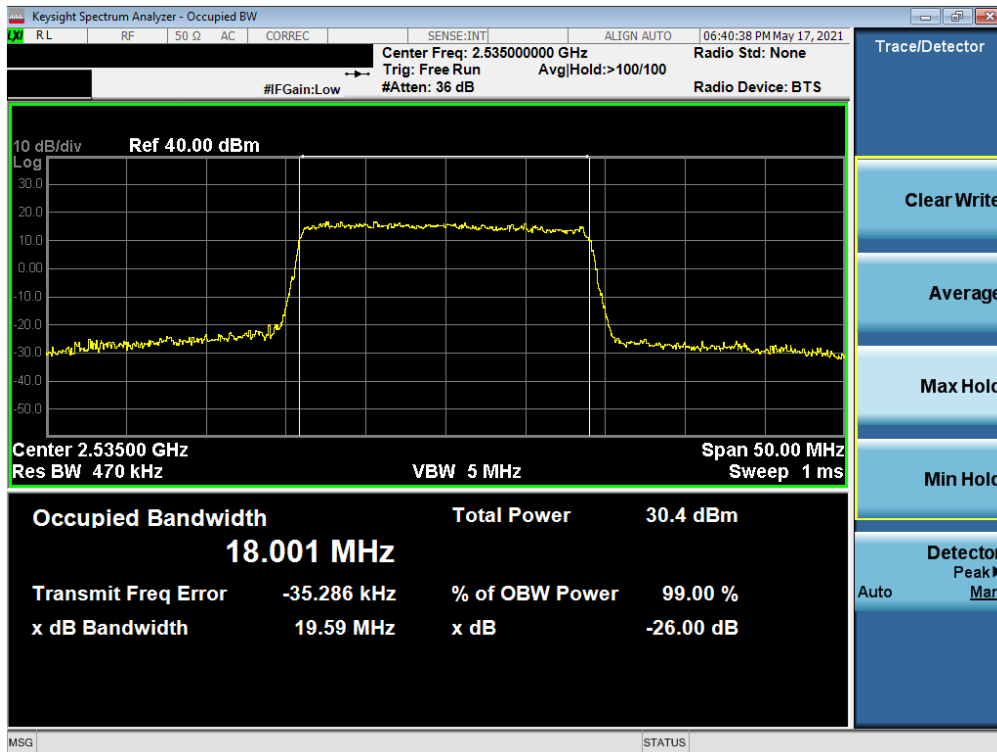

Plot 7-2. Occupied Bandwidth Plot (LTE Band 7 - 20MHz 16-QAM - Full RB)

FCC ID: RI7LE910CXWWX IC:5131A-LE910CXWWX		PART 27 / RSS-199 MEASUREMENT REPORT	Approved by: Technical Manager
Test Report S/N: 1M2106040065-07.R17	Test Dates: 5/12 - 6/1/2021	EUT Type: Data Terminal Module	Page 15 of 42

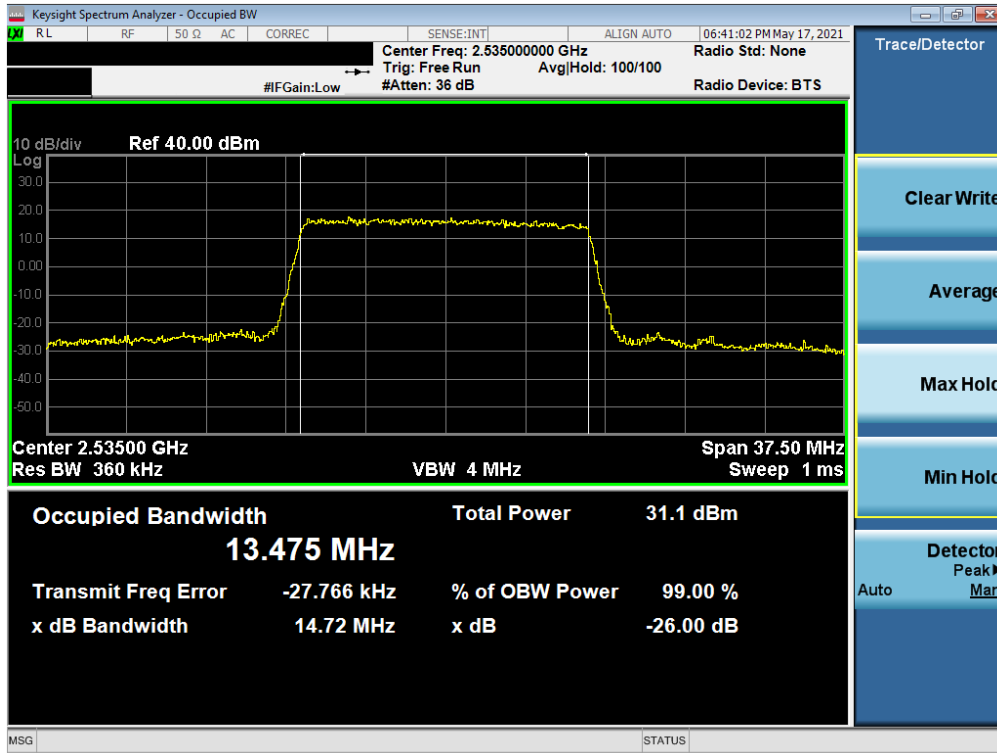

Plot 7-3. Occupied Bandwidth Plot (LTE Band 7 - 15MHz QPSK - Full RB)

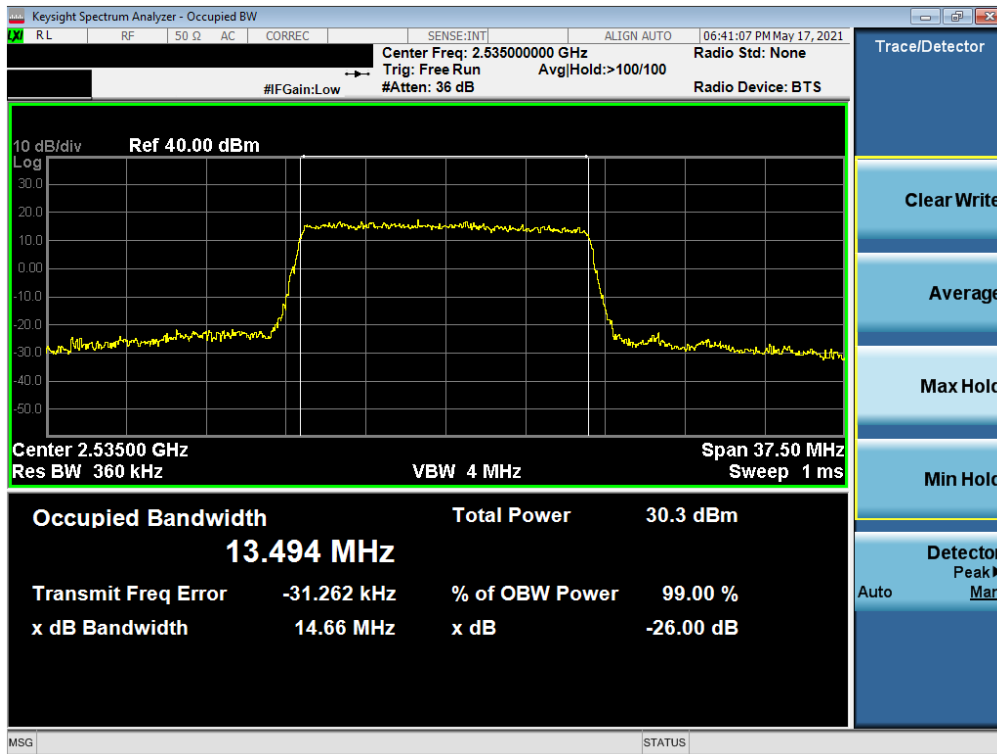

Plot 7-4. Occupied Bandwidth Plot (LTE Band 7 - 15MHz 16-QAM - Full RB)

FCC ID: RI7LE910CXWWX IC:5131A-LE910CXWWX	<b>PCTEST</b> Proud to be part of element	<b>PART 27 / RSS-199 MEASUREMENT REPORT</b>	<b>Approved by:</b> Technical Manager
<b>Test Report S/N:</b> 1M2106040065-07.RI7	<b>Test Dates:</b> 5/12 - 6/1/2021	<b>EUT Type:</b> Data Terminal Module	Page 16 of 42



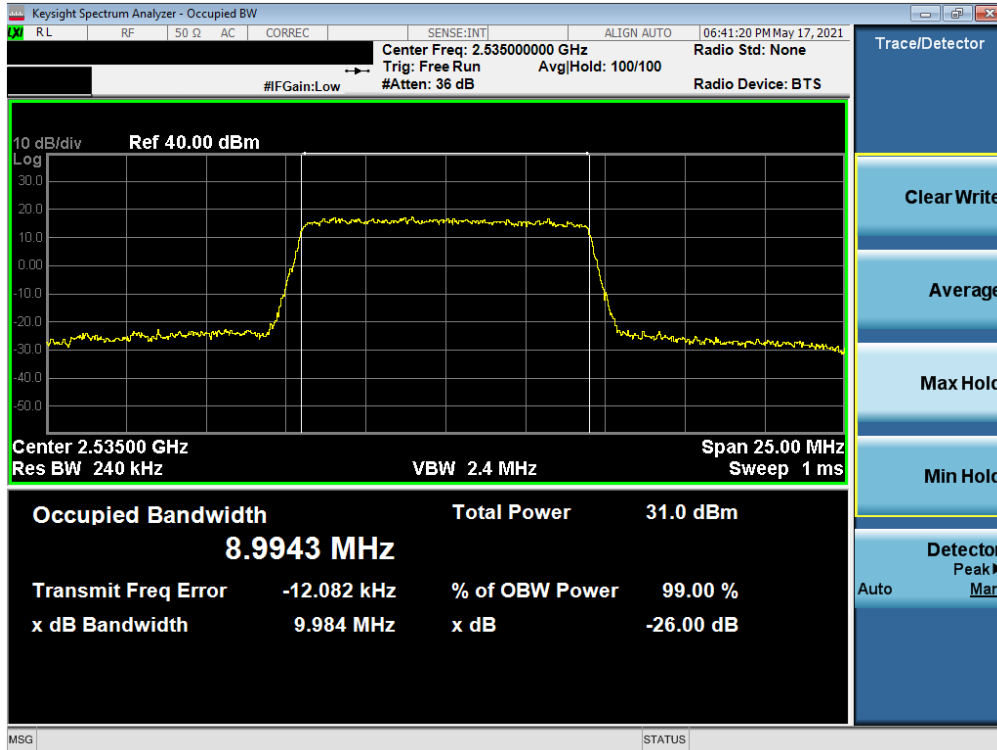

Plot 7-5. Occupied Bandwidth Plot (LTE Band 7 - 10MHz QPSK - Full RB)

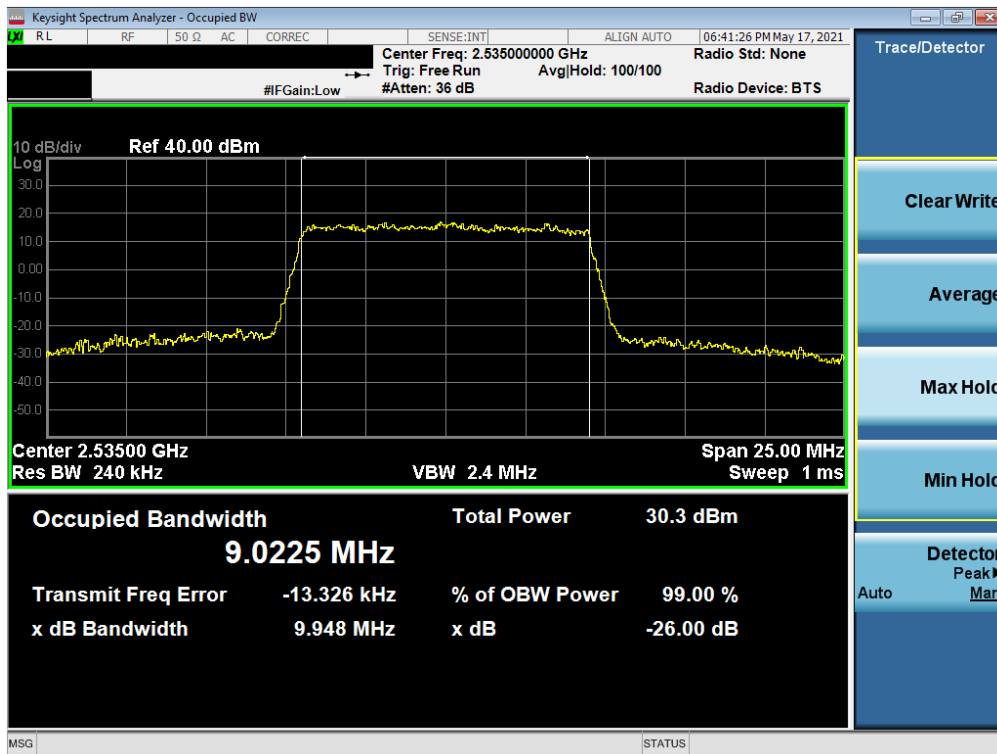

Plot 7-6. Occupied Bandwidth Plot (LTE Band 7 - 10MHz 16-QAM - Full RB)

FCC ID: RI7LE910CXWWX IC:5131A-LE910CXWWX		PART 27 / RSS-199 MEASUREMENT REPORT	Approved by: Technical Manager
Test Report S/N: 1M2106040065-07.RI7	Test Dates: 5/12 - 6/1/2021	EUT Type: Data Terminal Module	Page 17 of 42

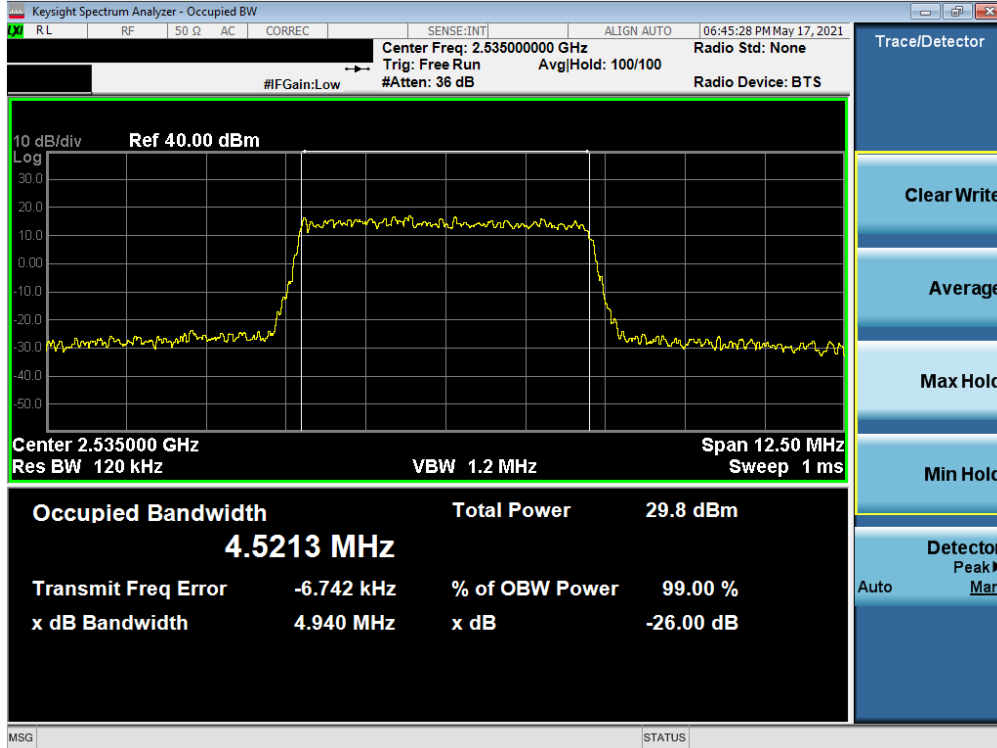

Plot 7-7. Occupied Bandwidth Plot (LTE Band 7 - 5MHz QPSK - Full RB)

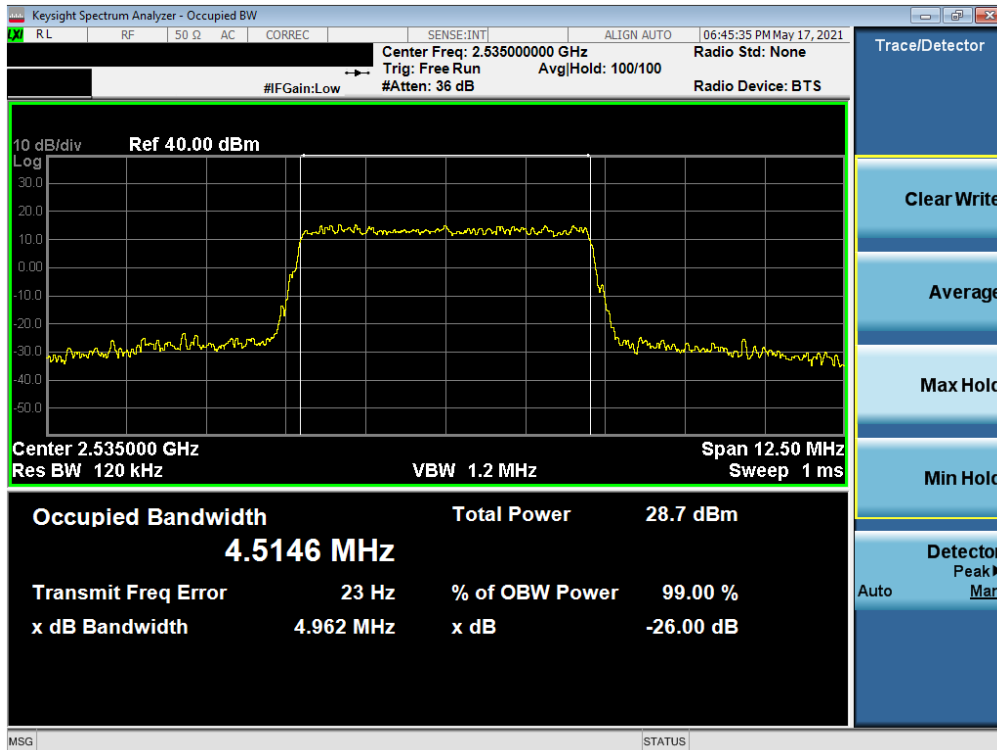

Plot 7-8. Occupied Bandwidth Plot (LTE Band 7 - 5MHz 16-QAM - Full RB)

FCC ID: RI7LE910CXWWX IC:5131A-LE910CXWWX	<b>PCTEST</b> Proud to be part of element	PART 27 / RSS-199 MEASUREMENT REPORT	Approved by: Technical Manager
Test Report S/N: 1M2106040065-07.RI7	Test Dates: 5/12 - 6/1/2021	EUT Type: Data Terminal Module	Page 18 of 42

## 7.4 Spurious and Harmonic Emissions at Antenna Terminal

### Test Overview

The level of the carrier and the various conducted spurious and harmonic frequencies is measured by means of a calibrated spectrum analyzer. The spectrum is scanned from the lowest frequency generated in the equipment up to a frequency including its 10<sup>th</sup> harmonic. All out of band emissions are measured with a spectrum analyzer connected to the antenna terminal of the EUT while the EUT is operating at maximum power, and at the appropriate frequencies. All data rates were investigated to determine the worst case configuration. All modes of operation were investigated and the worst case configuration results are reported in this section.

***For Band 7, the minimum permissible attenuation level of any spurious emission is  $55 + 10\log_{10}(P_{[Watts]})$ .***

### Test Procedure Used

KDB 971168 D01 v03r01 – Section 6.0

### Test Settings

1. Start frequency was set to 30MHz and stop frequency was set to 10GHz (separated into at least two plots per channel)
2. Detector = RMS
3. Trace mode = trace average for continuous emissions, max hold for pulse emissions
4. Sweep time = auto couple
5. The trace was allowed to stabilize
6. Please see test notes below for RBW and VBW settings

### Test Setup

The EUT and measurement equipment were set up as shown in the diagram below.

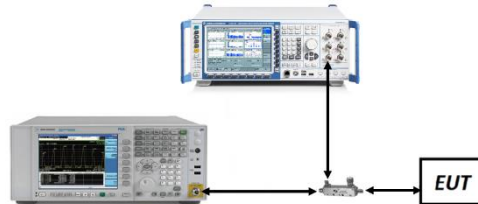

**Figure 7-3. Test Instrument & Measurement Setup**

### Test Notes

Per Part 27 and RSS-199, compliance with the applicable limits is based on the use of measurement instrumentation employing a resolution bandwidth of 1MHz for measurements above 1GHz. However, in the 1 MHz bands immediately outside and adjacent to the frequency block a resolution bandwidth of at least one percent of the emission bandwidth of the fundamental emission of the transmitter may be employed. The emission bandwidth is defined as the width of the signal between two points, one below the carrier center frequency and one above the carrier center frequency, outside of which all emission is attenuated at least 26 dB below the transmitter power.

FCC ID: RI7LE910CXWWX IC:5131A-LE910CXWWX	 <b>PCTEST</b> Proud to be part of element	<b>PART 27 / RSS-199 MEASUREMENT REPORT</b>	<b>Approved by:</b> Technical Manager
<b>Test Report S/N:</b> 1M2106040065-07.RI7	<b>Test Dates:</b> 5/12 - 6/1/2021	<b>EUT Type:</b> Data Terminal Module	Page 19 of 42

### LTE Band 7



Plot 7-9. Conducted Spurious Plot (LTE Band 7 - 20MHz QPSK - RB Size 1, RB Offset 0 - Low Channel)

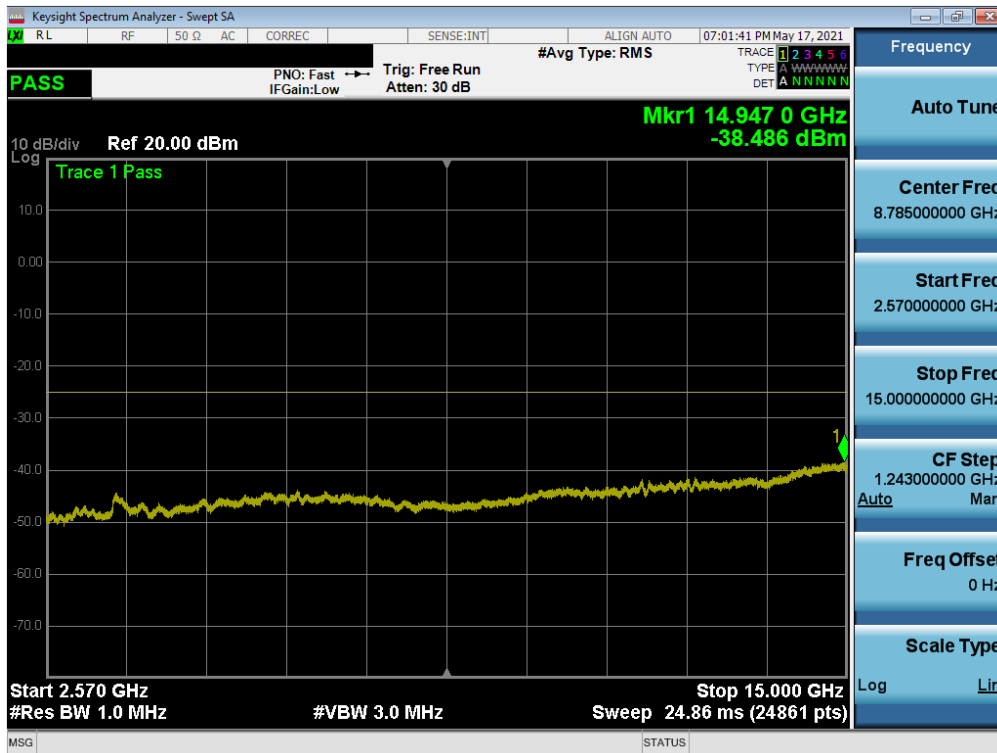

Plot 7-10. Conducted Spurious Plot (LTE Band 7 - 20MHz QPSK - RB Size 1, RB Offset 0 - Low Channel)

FCC ID: RI7LE910CXWWX IC:5131A-LE910CXWWX	<b>PCTEST</b> Proud to be part of element	PART 27 / RSS-199 MEASUREMENT REPORT	Approved by: Technical Manager
Test Report S/N: 1M2106040065-07.RI7	Test Dates: 5/12 - 6/1/2021	EUT Type: Data Terminal Module	Page 20 of 42

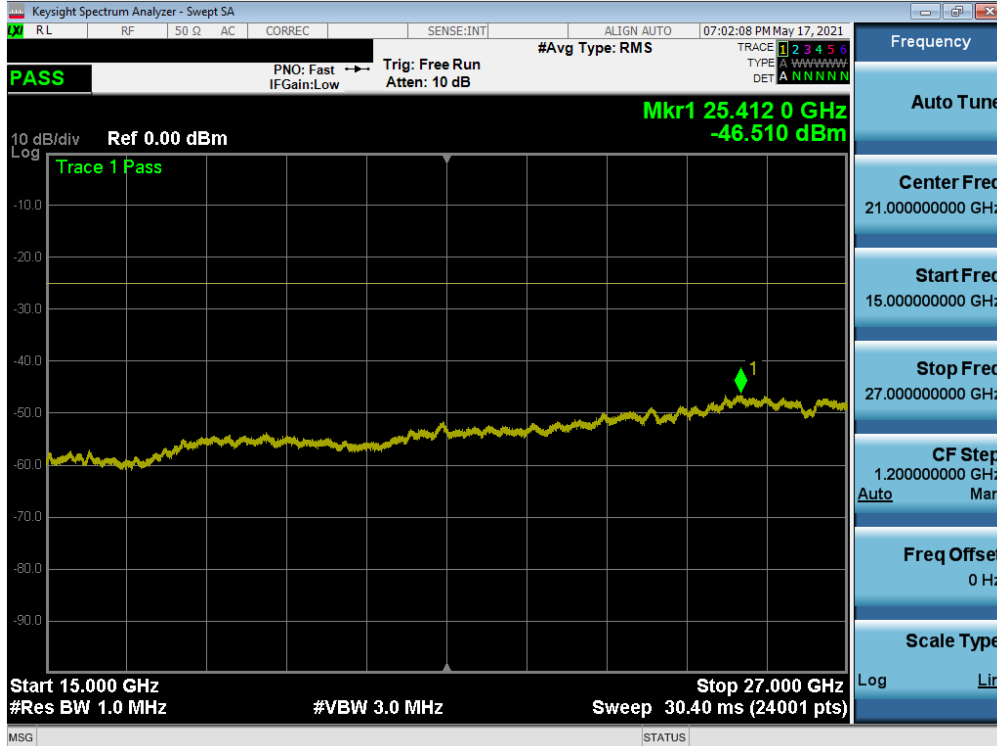

Plot 7-11. Conducted Spurious Plot (LTE Band 7 - 20MHz QPSK - RB Size 1, RB Offset 0 - Low Channel)



Plot 7-12. Conducted Spurious Plot (LTE Band 7 - 20MHz QPSK - RB Size 1, RB Offset 0 - Mid Channel)

FCC ID: RI7LE910CXWWX IC:5131A-LE910CXWWX	<b>PCTEST</b> Proud to be part of  element	PART 27 / RSS-199 MEASUREMENT REPORT	Approved by: Technical Manager
Test Report S/N: 1M2106040065-07.RI7	Test Dates: 5/12 - 6/1/2021	EUT Type: Data Terminal Module	Page 21 of 42

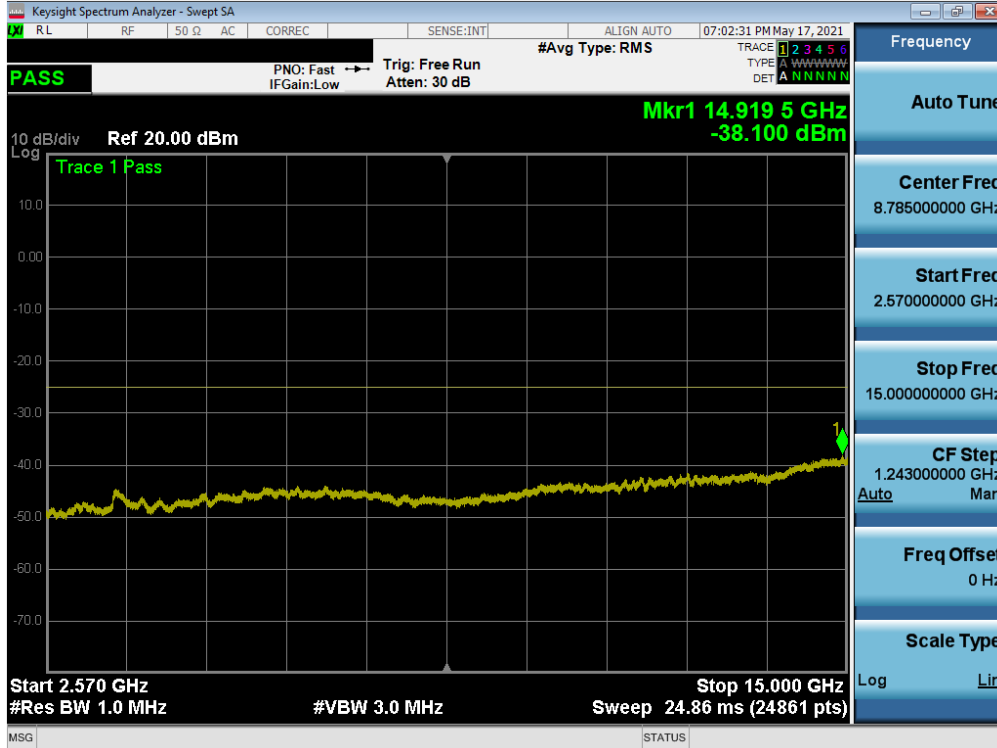

Plot 7-13. Conducted Spurious Plot (LTE Band 7 - 20MHz QPSK - RB Size 1, RB Offset 0 - Mid Channel)

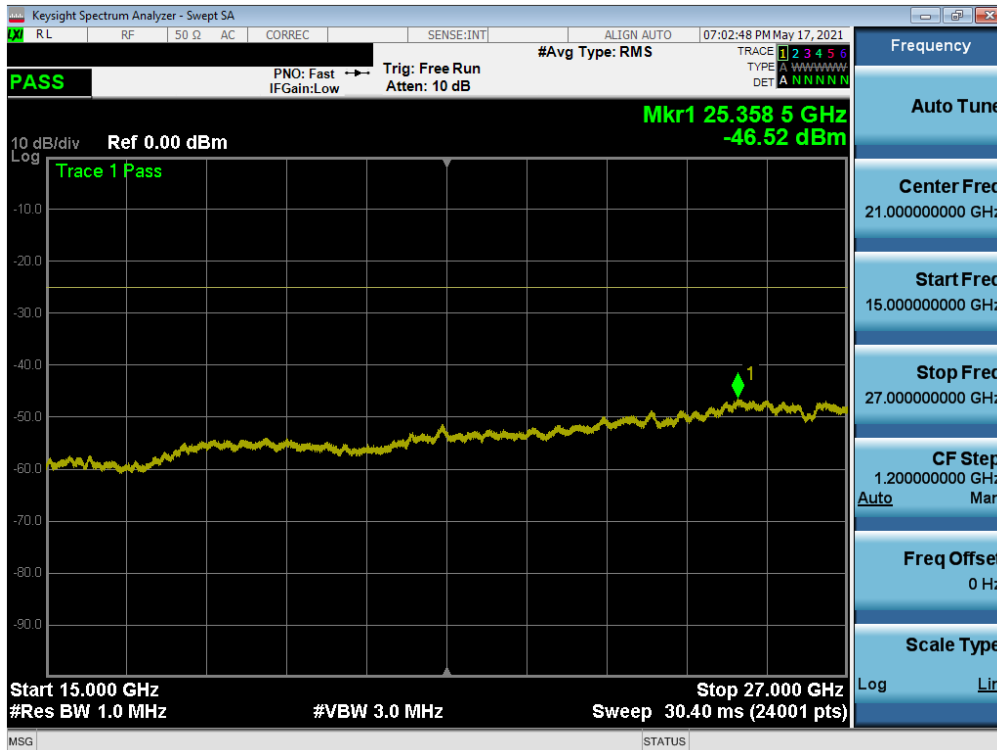

Plot 7-14. Conducted Spurious Plot (LTE Band 7 - 20MHz QPSK - RB Size 1, RB Offset 0 - Mid Channel)

FCC ID: RI7LE910CXWWX IC:5131A-LE910CXWWX	<b>PCTEST</b> Proud to be part of element	PART 27 / RSS-199 MEASUREMENT REPORT	Approved by: Technical Manager
Test Report S/N: 1M2106040065-07.RI7	Test Dates: 5/12 - 6/1/2021	EUT Type: Data Terminal Module	Page 22 of 42



Plot 7-15. Conducted Spurious Plot (LTE Band 7 - 20MHz QPSK - RB Size 1, RB Offset 0 - High Channel)



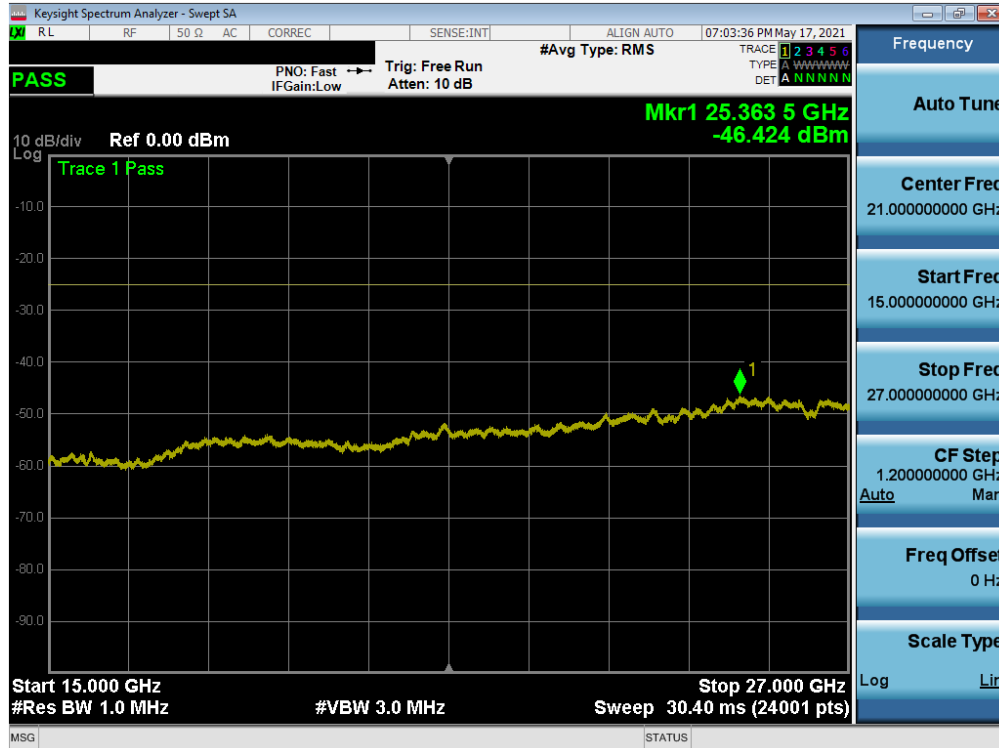

Plot 7-16. Conducted Spurious Plot (LTE Band 7 - 20MHz QPSK - RB Size 1, RB Offset 0 - High Channel)

FCC ID: RI7LE910CXWWX IC:5131A-LE910CXWWX	PCTEST Proud to be part of  element	PART 27 / RSS-199 MEASUREMENT REPORT	Approved by: Technical Manager
Test Report S/N: 1M2106040065-07.RI7	Test Dates: 5/12 - 6/1/2021	EUT Type: Data Terminal Module	Page 23 of 42



Plot 7-17. Conducted Spurious Plot (LTE Band 7 - 20MHz QPSK - RB Size 1, RB Offset 0 - High Channel)

FCC ID: RI7LE910CXWWX IC:5131A-LE910CXWWX	 <b>PCTEST</b> Proud to be part of 	PART 27 / RSS-199 MEASUREMENT REPORT	Approved by: Technical Manager
Test Report S/N: 1M2106040065-07.RI7	Test Dates: 5/12 - 6/1/2021	EUT Type: Data Terminal Module	Page 24 of 42



## 7.5 Band Edge Emissions at Antenna Terminal

### Test Overview

All out of band emissions are measured with a spectrum analyzer connected to the antenna terminal of the EUT while the EUT is operating at maximum power, and at the appropriate frequencies. All data rates were investigated to determine the worst case configuration. All modes of operation were investigated and the worst case configuration results are reported in this section.

*The minimum permissible attenuation level for Band 7 is as noted in the Test Notes on the following page.*

### Test Procedure Used

KDB 971168 D01 v03r01 – Section 6.0

### Test Settings

1. Start and stop frequency were set such that the band edge would be placed in the center of the plot
2. Span was set large enough so as to capture all out of band emissions near the band edge
3. RBW  $\geq$  1% of the emission bandwidth
4. VBW  $\geq$  3 x RBW
5. Detector = RMS
6. Number of sweep points  $\geq$  2 x Span/RBW
7. Trace mode = trace average for continuous emissions, max hold for pulse emissions
8. Sweep time = auto couple
9. The trace was allowed to stabilize

### Test Setup

The EUT and measurement equipment were set up as shown in the diagram below.

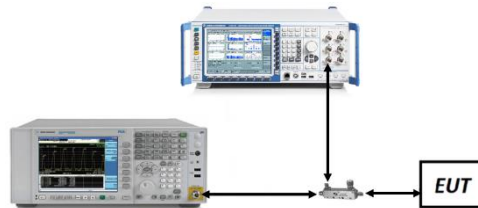

**Figure 7-4. Test Instrument & Measurement Setup**

### Test Notes

Per 27.53(m) and RSS-199 for operations in LTE Band 7, the attenuation factor shall be not less than  $40 + 10 \log (P)$  dB on all frequencies between the channel edge and 5 megahertz from the channel edge,  $43 + 10 \log (P)$  dB on all frequencies between 5 megahertz and X megahertz from the channel edge, and  $55 + 10 \log (P)$  dB on all frequencies more than X megahertz from the channel edge, where X is the greater of 6 megahertz or the actual emission bandwidth. In addition, the attenuation factor shall not be less that  $43 + 10 \log (P)$  dB on all frequencies between 2490.5 MHz and 2496 MHz and  $55 + 10 \log (P)$  dB at or below 2490.5 MHz.

FCC ID: RI7LE910CXWWX IC:5131A-LE910CXWWX	 <b>PCTEST</b> Proud to be part of element	<b>PART 27 / RSS-199 MEASUREMENT REPORT</b>	<b>Approved by:</b> Technical Manager
<b>Test Report S/N:</b> 1M2106040065-07.R17	<b>Test Dates:</b> 5/12 - 6/1/2021	<b>EUT Type:</b> Data Terminal Module	Page 25 of 42

# LTE Band 7

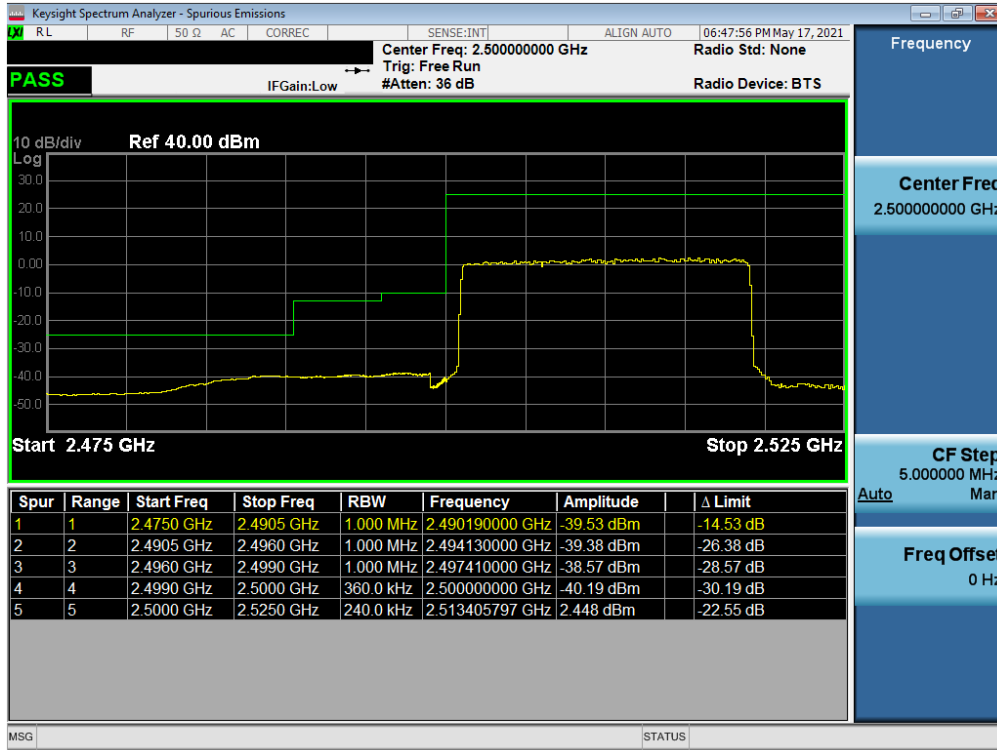

Plot 7-18. Lower ACP Plot (LTE Band 7 - 20MHz QPSK – Full RB)

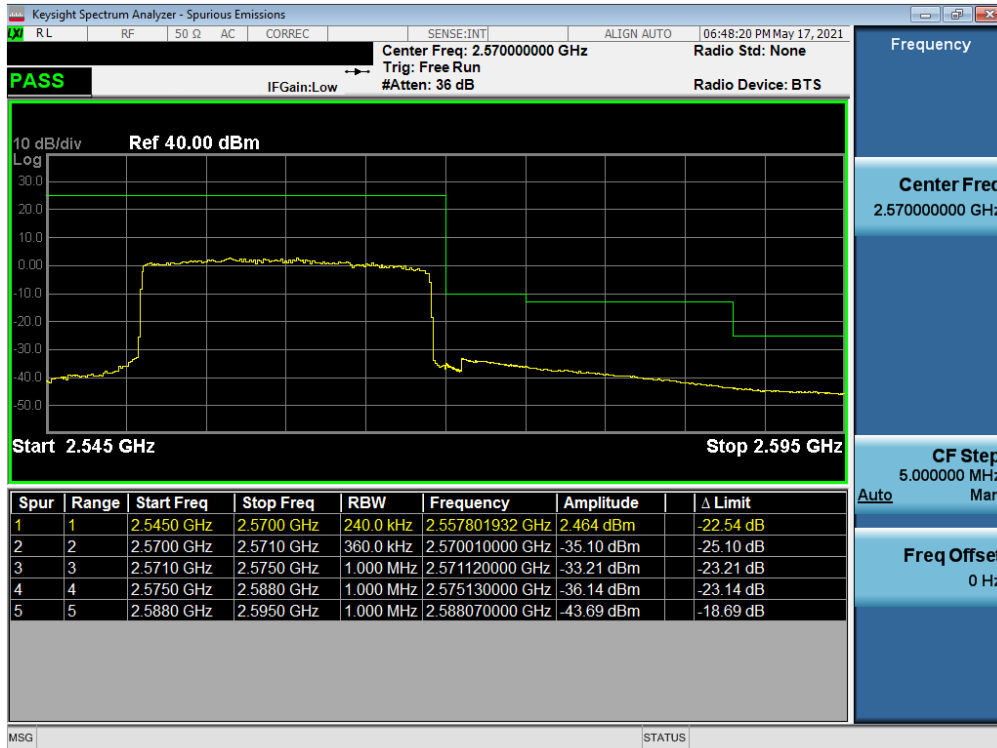

Plot 7-19. Upper ACP Plot (LTE Band 7 - 20MHz QPSK – Full RB)

FCC ID: RI7LE910CXWWX IC:5131A-LE910CXWWX	<b>PCTEST</b> Proud to be part of element	PART 27 / RSS-199 MEASUREMENT REPORT	Approved by: Technical Manager
Test Report S/N: 1M2106040065-07.RI7	Test Dates: 5/12 - 6/1/2021	EUT Type: Data Terminal Module	Page 26 of 42

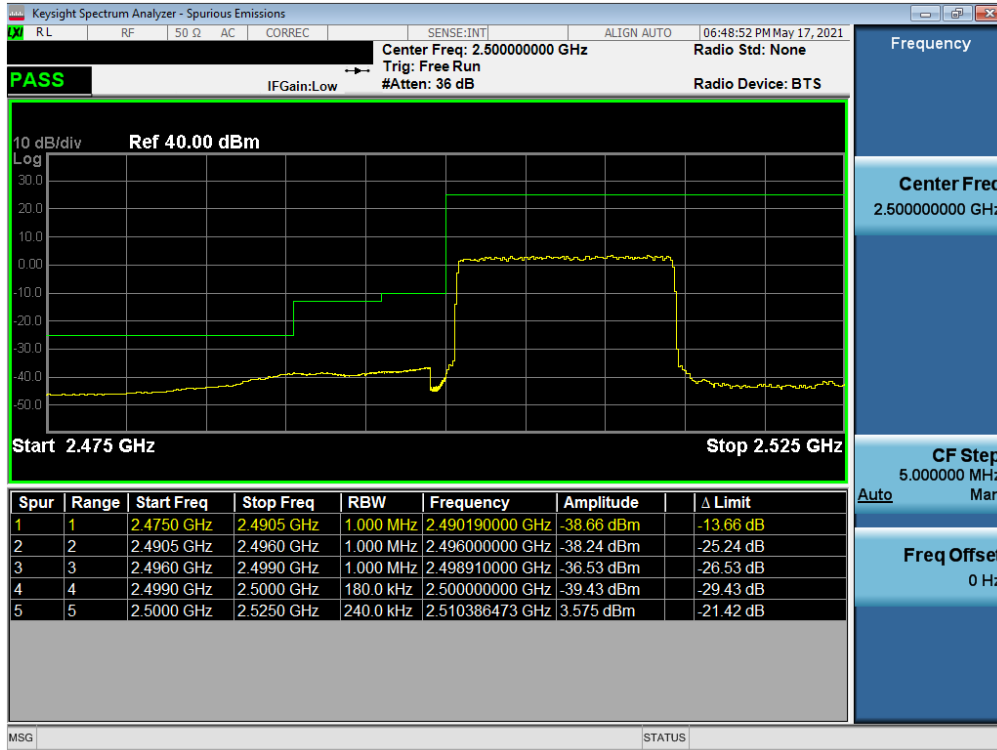

Plot 7-20. Lower ACP Plot (LTE Band 7 - 15MHz QPSK – Full RB)



Plot 7-21. Upper ACP Plot (LTE Band 7 - 15MHz QPSK – Full RB)

FCC ID: RI7LE910CXWWX IC:5131A-LE910CXWWX	<b>PCTEST</b> Proud to be part of element	PART 27 / RSS-199 MEASUREMENT REPORT	Approved by: Technical Manager
Test Report S/N: 1M2106040065-07.RI7	Test Dates: 5/12 - 6/1/2021	EUT Type: Data Terminal Module	Page 27 of 42

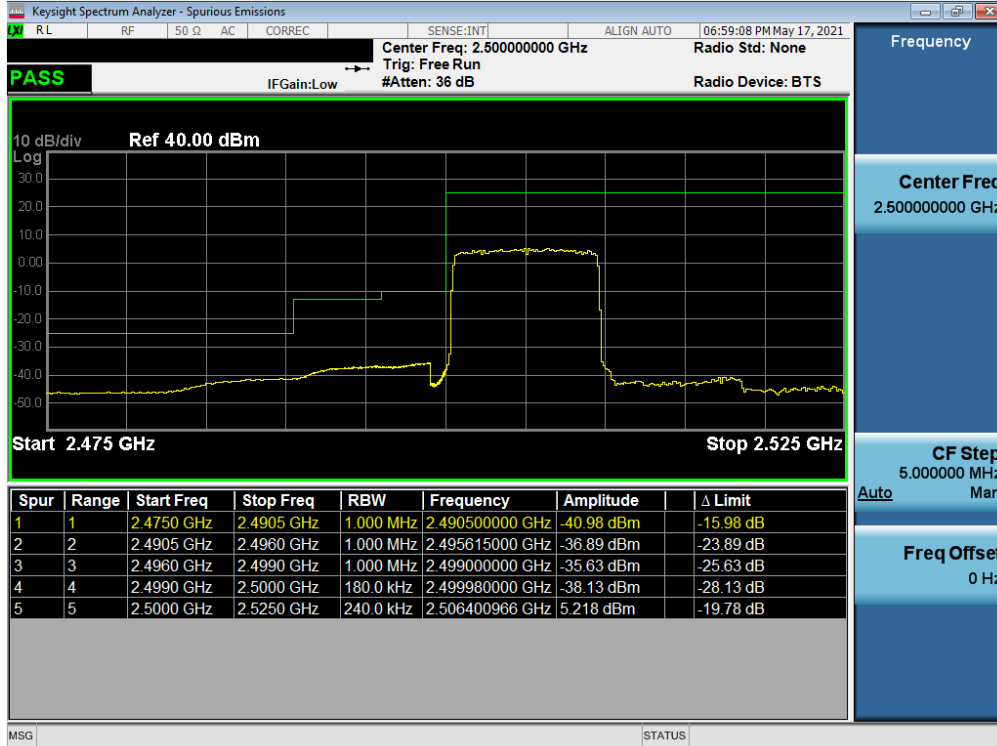

Plot 7-22. Lower ACP Plot (LTE Band 7 - 10MHz QPSK – Full RB)

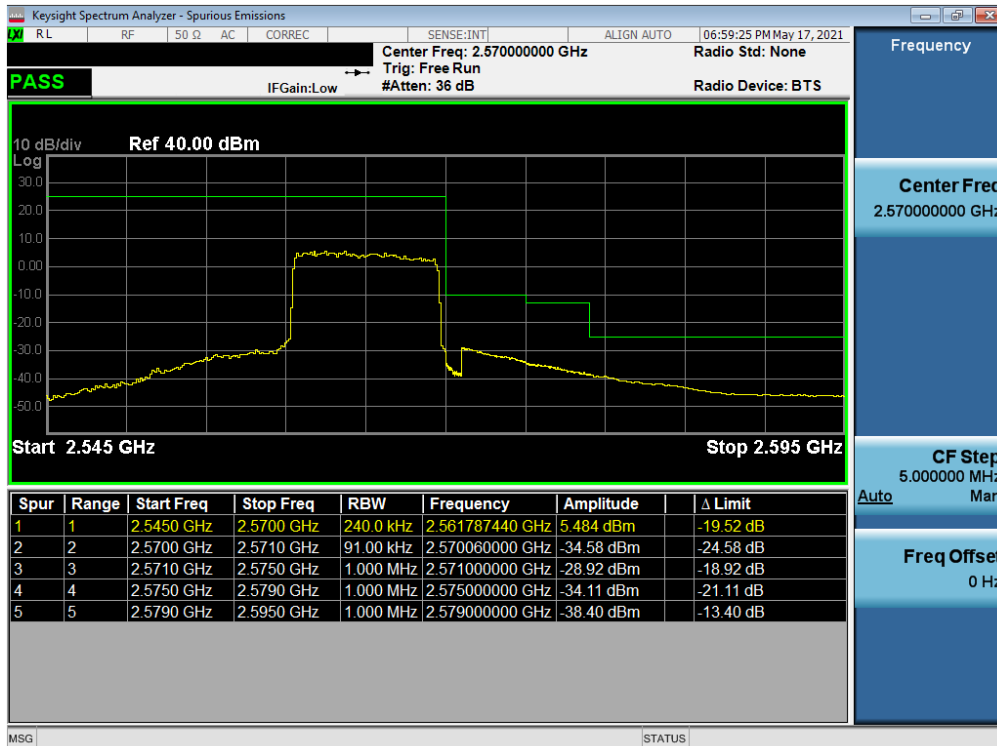

Plot 7-23. Upper ACP Plot (LTE Band 7 - 10MHz QPSK – Full RB)

FCC ID: RI7LE910CXWWX IC:5131A-LE910CXWWX	<b>PCTEST</b> Proud to be part of element	PART 27 / RSS-199 MEASUREMENT REPORT	Approved by: Technical Manager
Test Report S/N: 1M2106040065-07.RI7	Test Dates: 5/12 - 6/1/2021	EUT Type: Data Terminal Module	Page 28 of 42

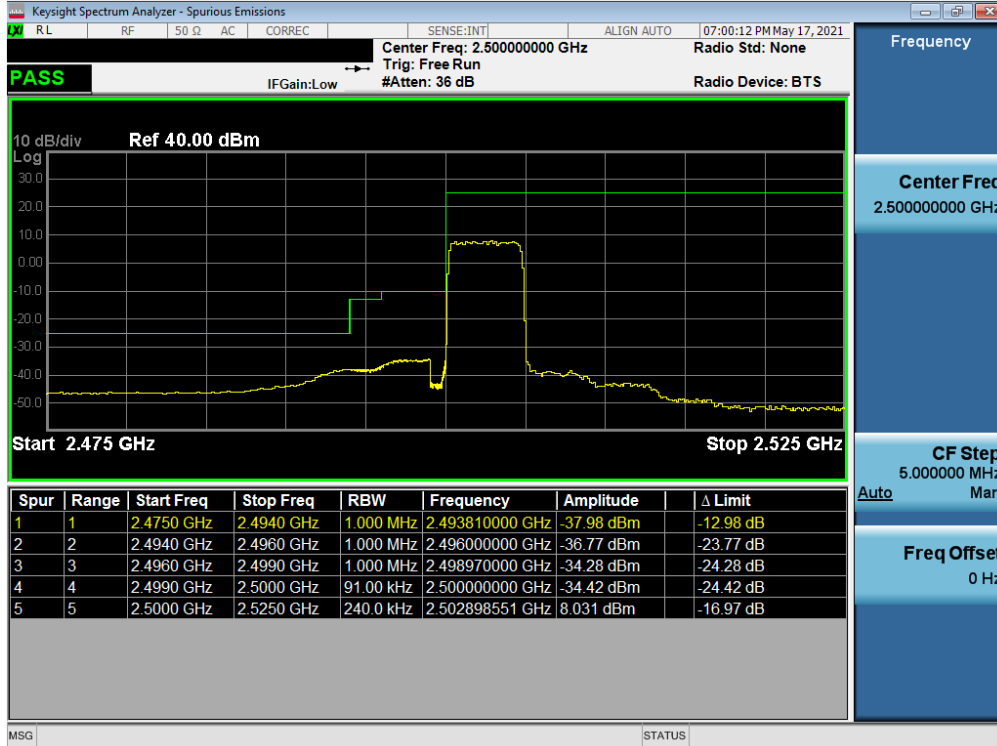

Plot 7-24. Lower ACP Plot (LTE Band 7 - 5MHz QPSK – Full RB)

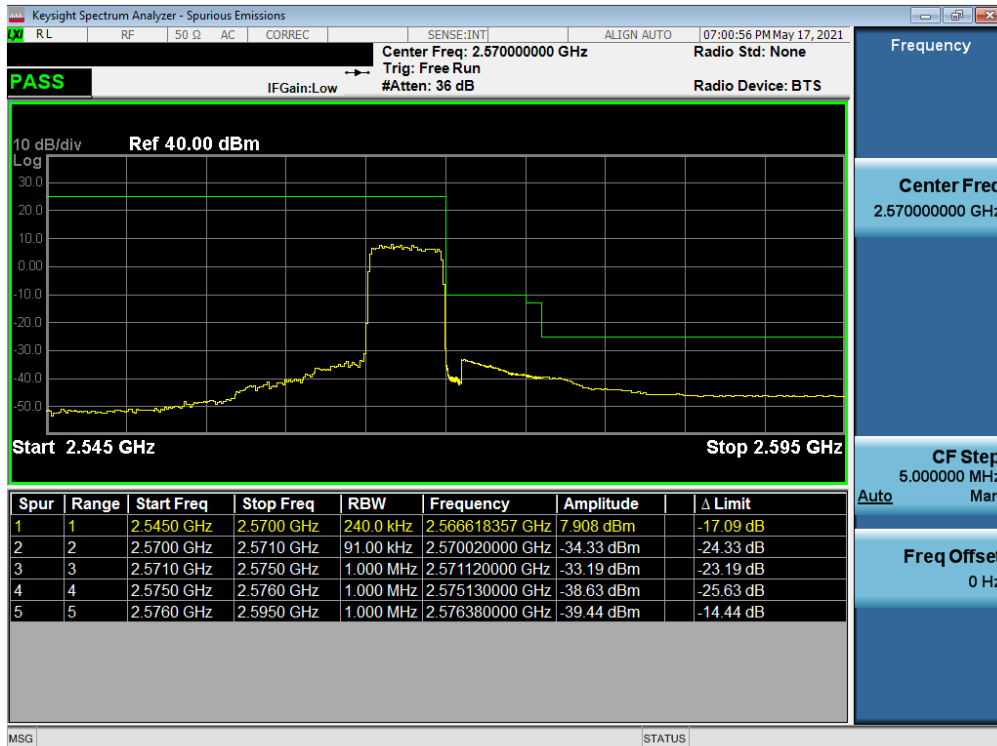

Plot 7-25. Upper ACP Plot (LTE Band 7 - 5MHz QPSK – Full RB)

FCC ID: RI7LE910CXWWX IC:5131A-LE910CXWWX	<b>PCTEST</b> Proud to be part of element	PART 27 / RSS-199 MEASUREMENT REPORT	Approved by: Technical Manager
Test Report S/N: 1M2106040065-07.RI7	Test Dates: 5/12 - 6/1/2021	EUT Type: Data Terminal Module	Page 29 of 42

## 7.6 Peak-Average Ratio

### Test Overview

A peak to average ratio measurement is performed at the conducted port of the EUT. The spectrum analyzers Complementary Cumulative Distribution Function (CCDF) measurement profile is used to determine the largest deviation between the average and the peak power of the EUT in a given bandwidth. The CCDF curve shows how much time the peak waveform spends at or above a given average power level. The percent of time the signal spends at or above the level defines the probability for that particular power level.

### Test Procedure Used

KDB 971168 D01 v03r01 – Section 5.7.1

### Test Settings

1. The signal analyzer’s CCDF measurement profile is enabled
2. Frequency = carrier center frequency
3. Measurement BW  $\geq$  OBW or specified reference bandwidth
4. The signal analyzer was set to collect one million samples to generate the CCDF curve
5. The measurement interval was set depending on the type of signal analyzed. For continuous signals (>98% duty cycle), the measurement interval was set to 1ms. For burst transmissions, the spectrum analyzer is set to use an internal “RF Burst” trigger that is synced with an incoming pulse and the measurement interval is set to less than the duration of the “on time” of one burst to ensure that energy is only captured during a time in which the transmitter is operating at maximum power

### Test Setup

The EUT and measurement equipment were set up as shown in the diagram below.

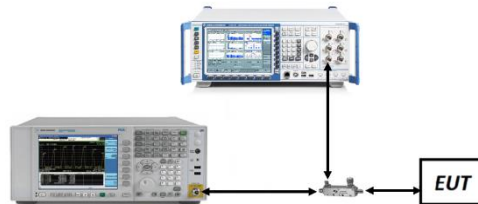

**Figure 7-5. Test Instrument & Measurement Setup**

### Test Notes

None.

FCC ID: RI7LE910CXWWX IC:5131A-LE910CXWWX	PCTEST Proud to be part of element	PART 27 / RSS-199 MEASUREMENT REPORT	Approved by: Technical Manager
Test Report S/N: 1M2106040065-07.RI7	Test Dates: 5/12 - 6/1/2021	EUT Type: Data Terminal Module	Page 30 of 42

## LTE Band 7

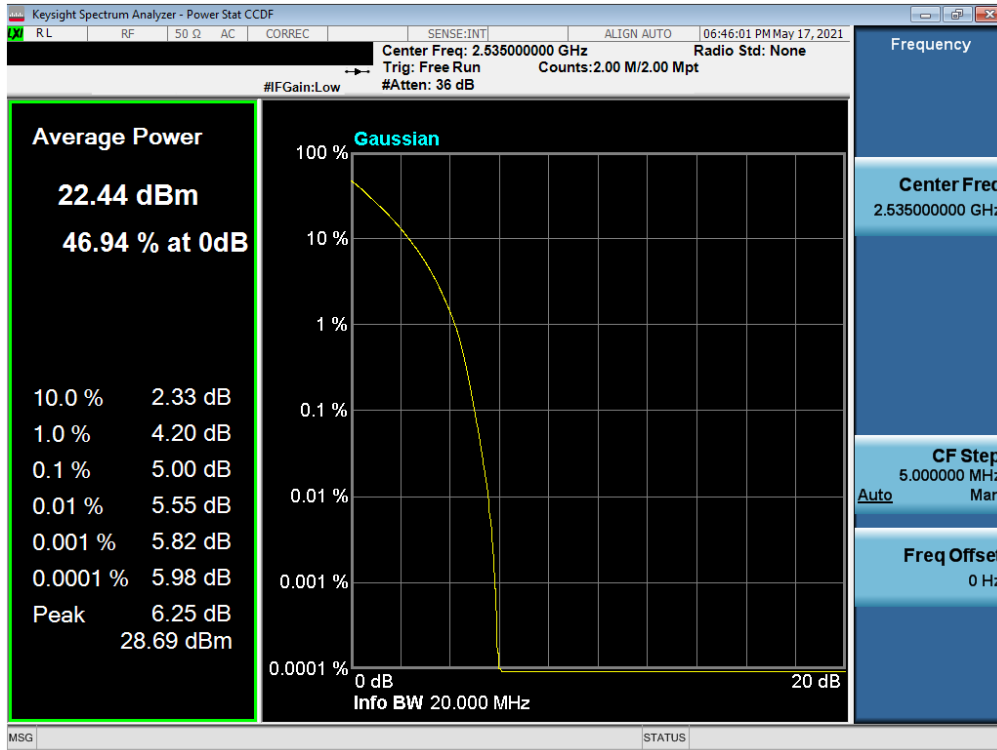

Plot 7-26. PAR Plot (LTE Band 7 - 20MHz QPSK - Full RB)

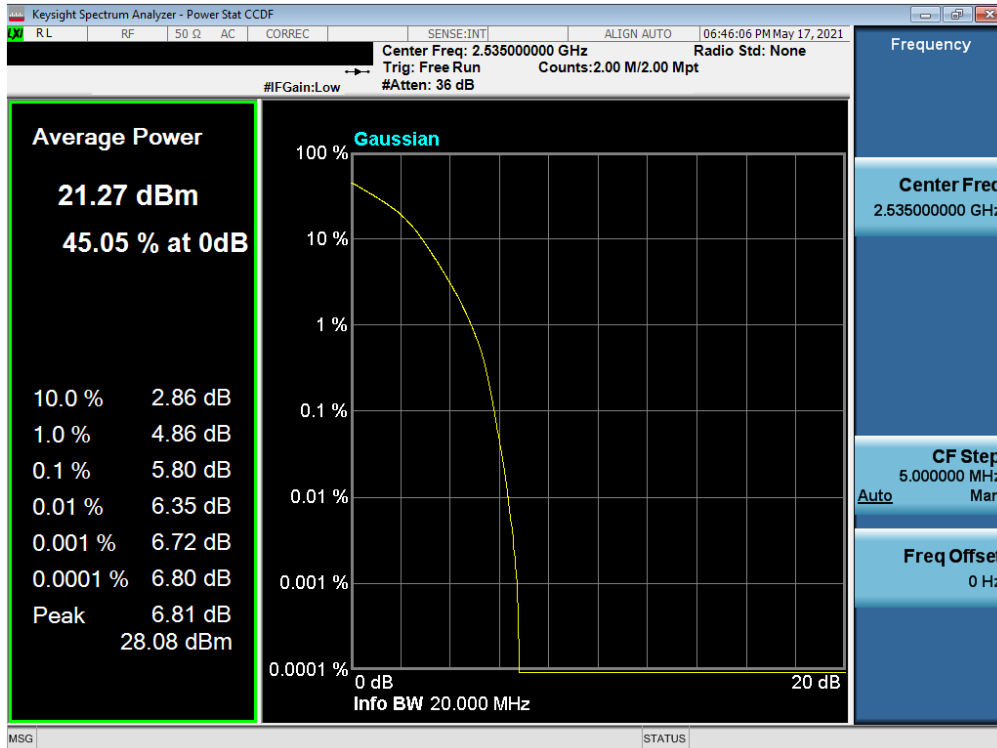

Plot 7-27. PAR Plot (LTE Band 7 - 20MHz 16-QAM - Full RB)

FCC ID: RI7LE910CXWWX IC:5131A-LE910CXWWX	<b>PCTEST</b> Proud to be part of element	PART 27 / RSS-199 MEASUREMENT REPORT	Approved by: Technical Manager
Test Report S/N: 1M2106040065-07.RI7	Test Dates: 5/12 - 6/1/2021	EUT Type: Data Terminal Module	Page 31 of 42

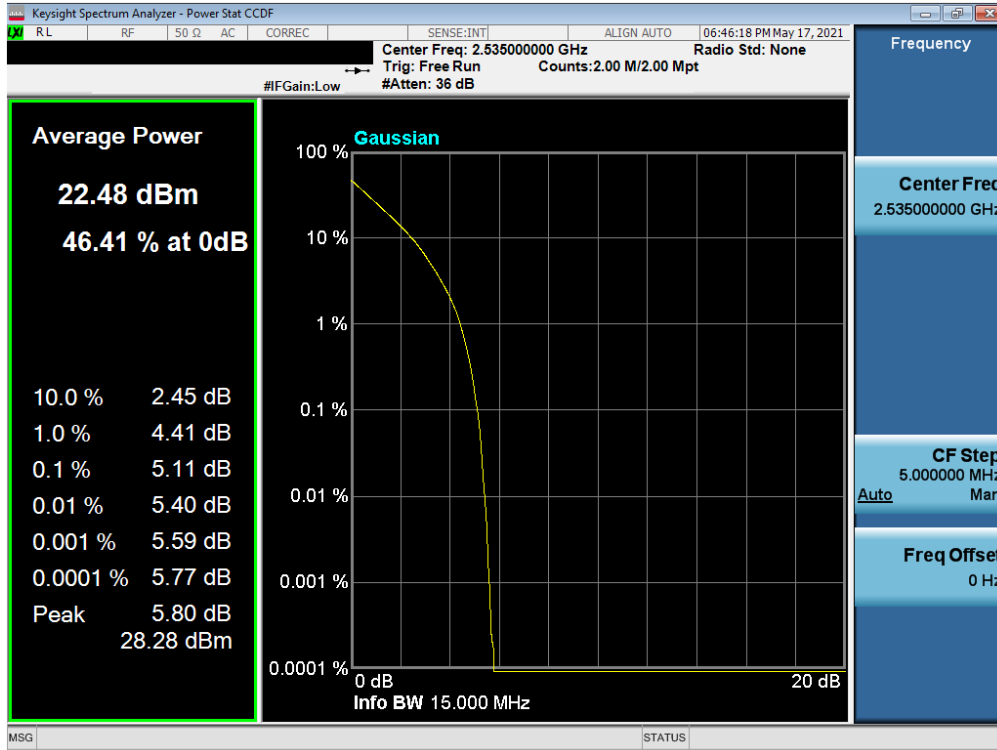

Plot 7-28. PAR Plot (LTE Band 7 - 15MHz QPSK - Full RB)

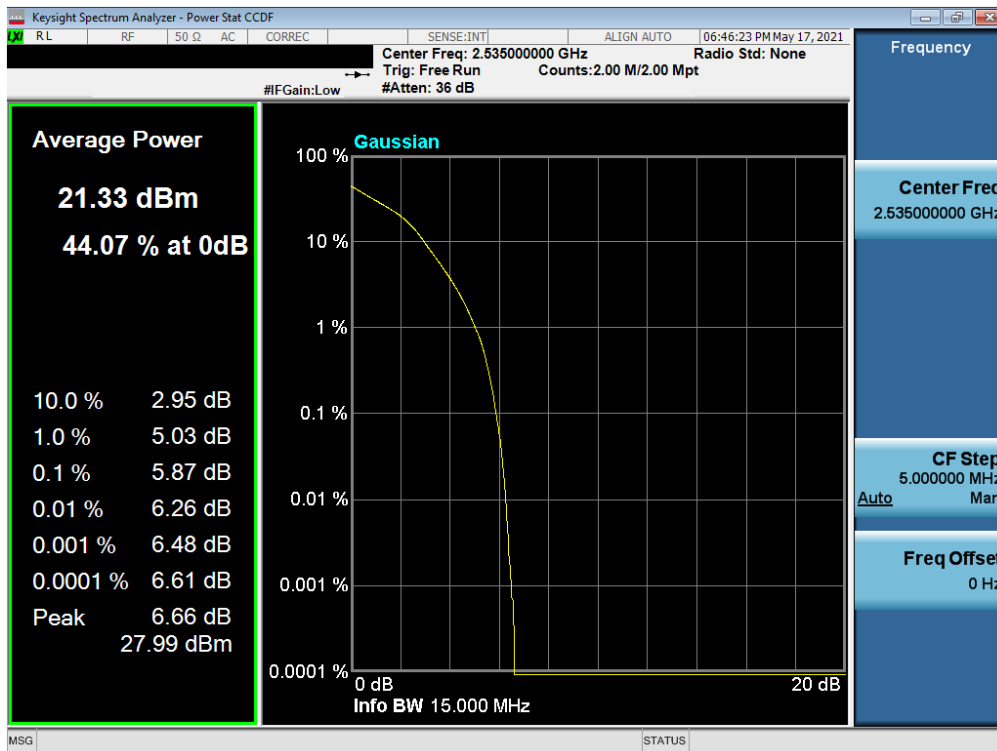

Plot 7-29. PAR Plot (LTE Band 7 - 15MHz 16-QAM - Full RB)

FCC ID: RI7LE910CXWWX IC:5131A-LE910CXWWX	<b>PCTEST</b> Proud to be part of element	PART 27 / RSS-199 MEASUREMENT REPORT	Approved by: Technical Manager
Test Report S/N: 1M2106040065-07.RI7	Test Dates: 5/12 - 6/1/2021	EUT Type: Data Terminal Module	Page 32 of 42



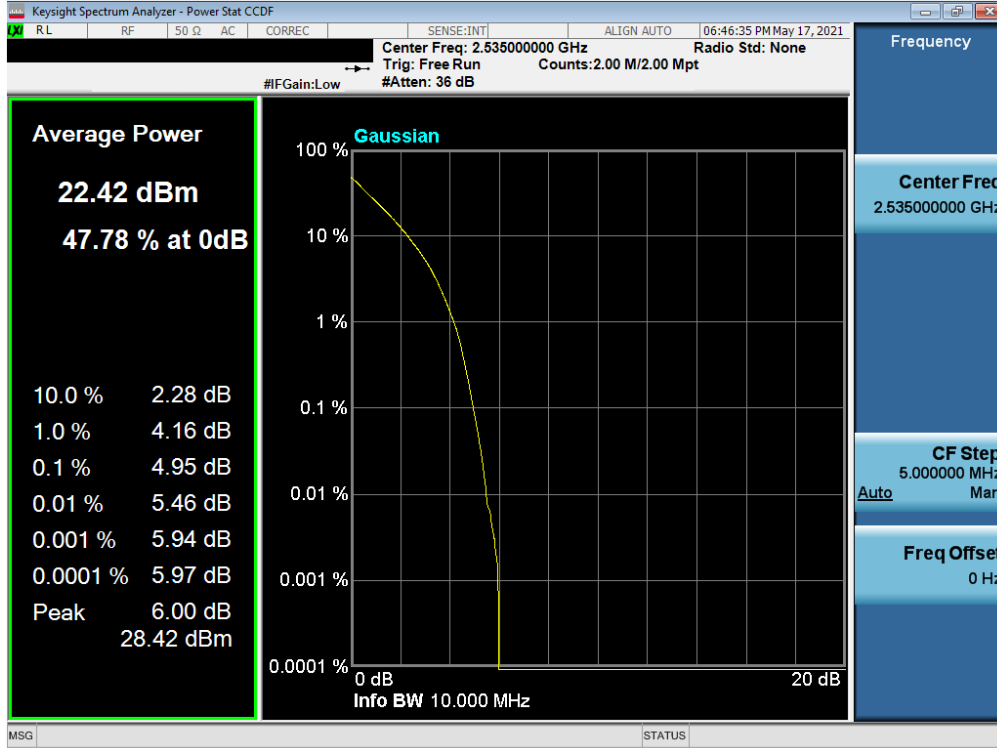

Plot 7-30. PAR Plot (LTE Band 7 - 10MHz QPSK - Full RB)

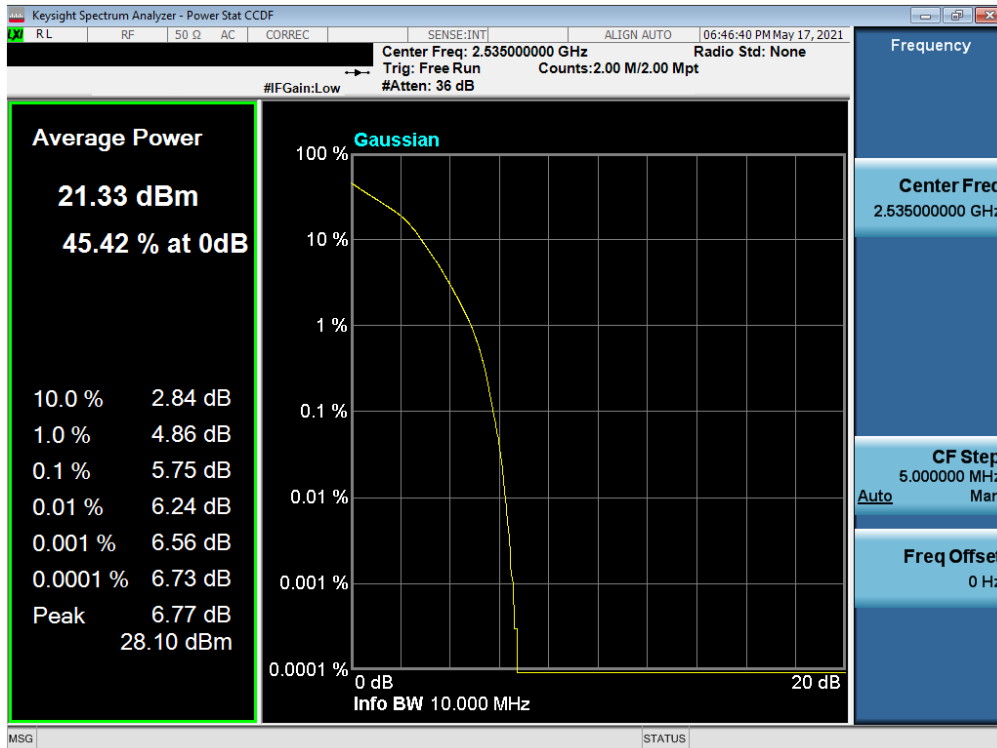

Plot 7-31. PAR Plot (LTE Band 7 - 10MHz 16-QAM - Full RB)

FCC ID: RI7LE910CXWWX IC:5131A-LE910CXWWX	<b>PCTEST</b> Proud to be part of element	PART 27 / RSS-199 MEASUREMENT REPORT	Approved by: Technical Manager
Test Report S/N: 1M2106040065-07.RI7	Test Dates: 5/12 - 6/1/2021	EUT Type: Data Terminal Module	Page 33 of 42

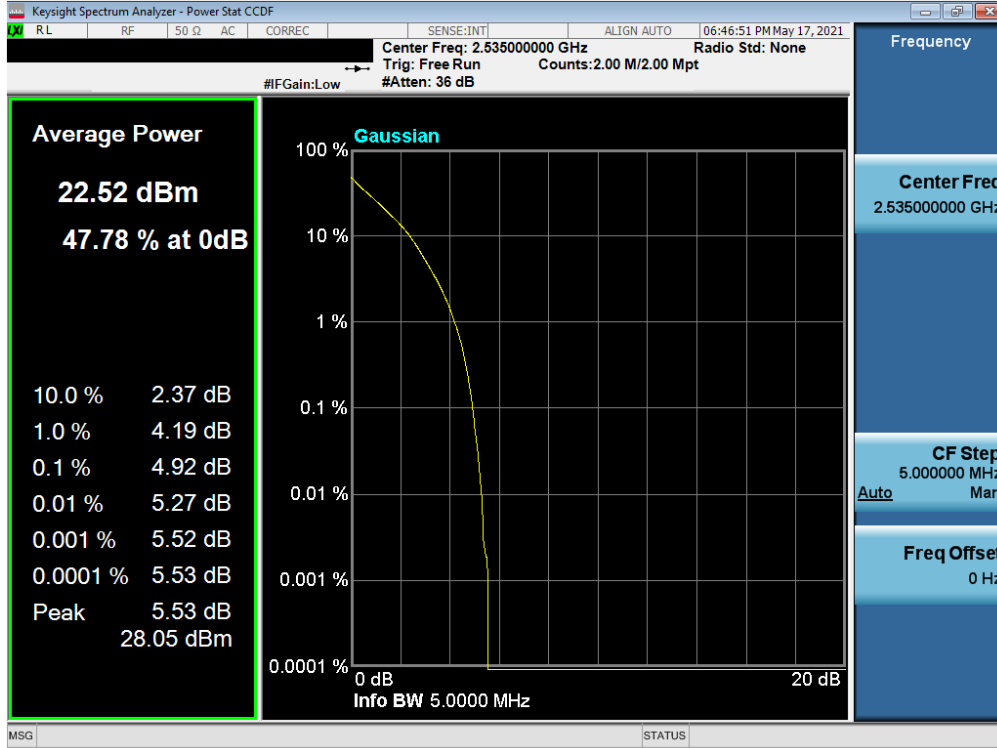

Plot 7-32. PAR Plot (LTE Band 7 - 5MHz QPSK - Full RB)

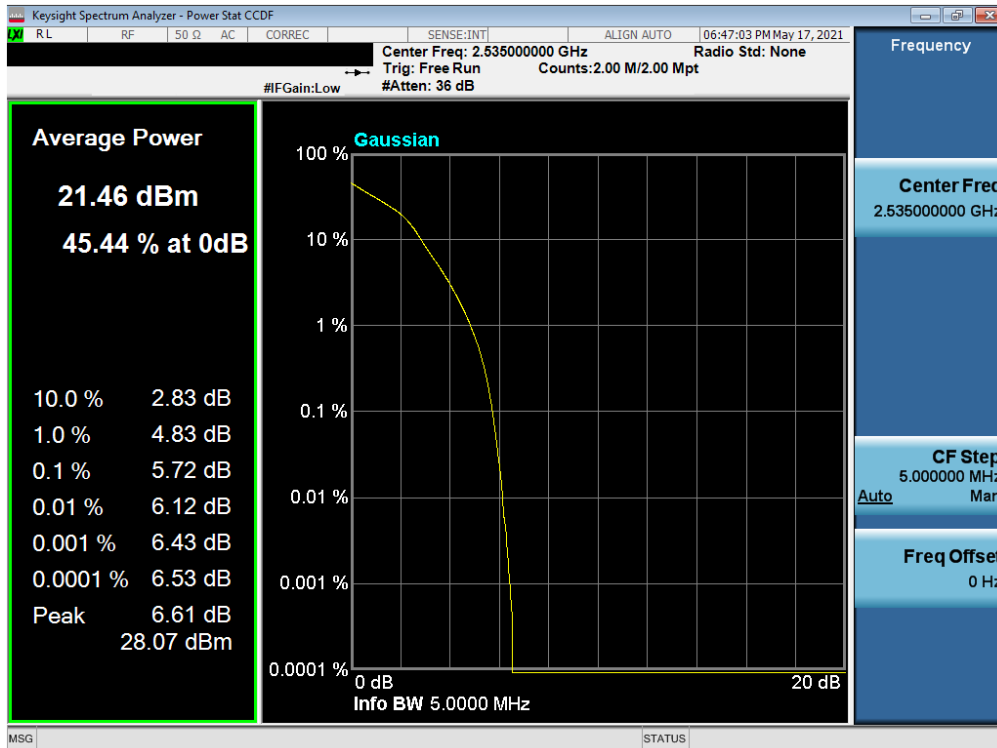

Plot 7-33. PAR Plot (LTE Band 7 - 5MHz 16-QAM - Full RB)

FCC ID: RI7LE910CXWWX IC:5131A-LE910CXWWX	<b>PCTEST</b> Proud to be part of element	<b>PART 27 / RSS-199 MEASUREMENT REPORT</b>	Approved by: Technical Manager
Test Report S/N: 1M2106040065-07.RI7	Test Dates: 5/12 - 6/1/2021	EUT Type: Data Terminal Module	Page 34 of 42

## 7.7 Radiated Spurious Emissions Measurements

### Test Overview

Radiated spurious emissions measurements are performed using the field strength conversion method described in KDB 971168 with the EUT transmitting into an integral antenna. Measurements on signals operating below 1GHz are performed using horizontally and vertically polarized tuned dipole antennas. Measurements on signals operating above 1GHz are performed using vertically and horizontally polarized broadband horn antennas. All measurements are performed as peak measurements while the EUT is operating at maximum power, and at the appropriate frequencies.

### Test Procedures Used

KDB 971168 D01 v03r01 – Section 5.8

### Test Settings

1. RBW = 100kHz for emissions below 1GHz and 1MHz for emissions above 1GHz
2. VBW  $\geq 3 \times$  RBW
3. Span = 1.5 times the OBW
4. No. of sweep points  $\geq 2 \times$  span / RBW
5. Detector = RMS
6. Trace mode = Average (Max Hold for pulsed emissions)
7. The trace was allowed to stabilize

<b>FCC ID:</b> RI7LE910CXWWX <b>IC:</b> 5131A-LE910CXWWX	 <b>PART 27 / RSS-199 MEASUREMENT REPORT</b>	<b>Approved by:</b> Technical Manager
<b>Test Report S/N:</b> 1M2106040065-07.RI7	<b>Test Dates:</b> 5/12 - 6/1/2021	<b>EUT Type:</b> Data Terminal Module  Page 35 of 42

**Test Setup**

The EUT and measurement equipment were set up as shown in the diagram below.

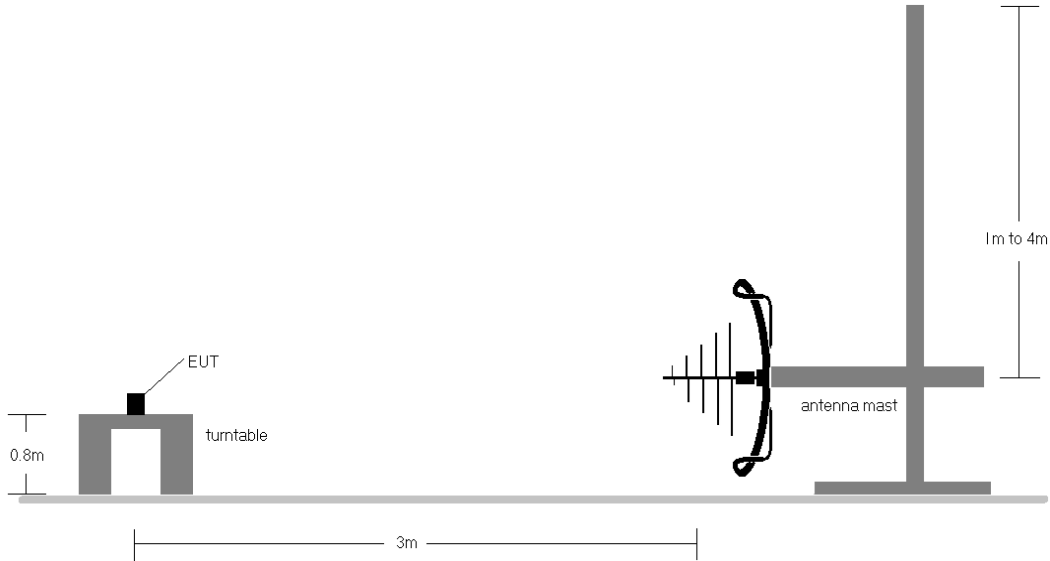

**Figure 7-6. Test Instrument & Measurement Setup < 1GHz**

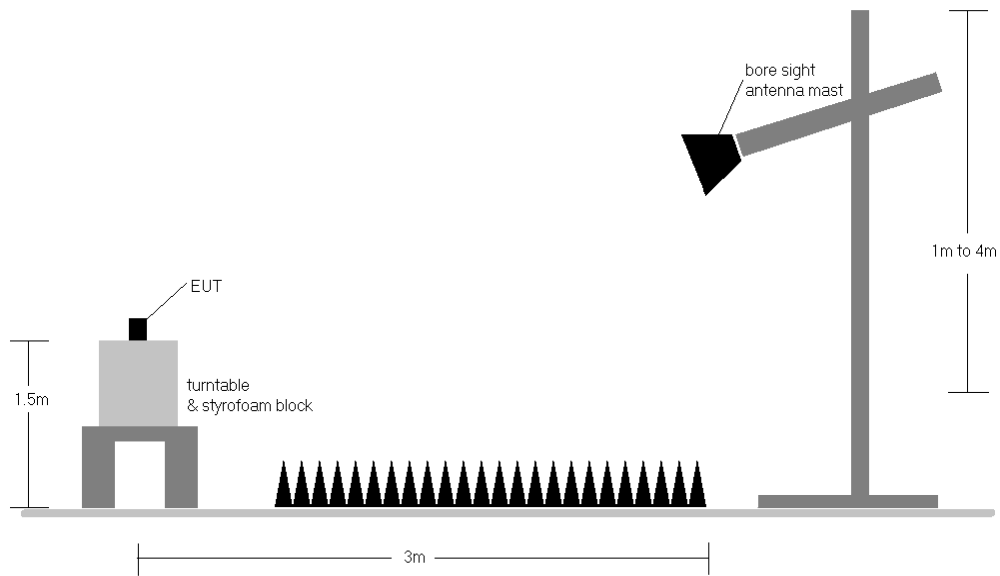

**Figure 7-7. Test Instrument & Measurement Setup >1 GHz**

<b>FCC ID:</b> RI7LE910CXWWX <b>IC:</b> 5131A-LE910CXWWX		<b>PART 27 / RSS-199 MEASUREMENT REPORT</b>	<b>Approved by:</b> Technical Manager
<b>Test Report S/N:</b> 1M2106040065-07.RI7	<b>Test Dates:</b> 5/12 - 6/1/2021	<b>EUT Type:</b> Data Terminal Module	Page 36 of 42

## Test Notes

- 1) Field strengths are calculated using the Measurement quantity conversions in KDB 971168 Section 5.8.4.
  - b)  $E(\text{dB}\mu\text{V}/\text{m}) = \text{Measured amplitude level (dBm)} + 107 + \text{Cable Loss (dB)} + \text{Antenna Factor (dB/m)}$
  - d)  $\text{EIRP (dBm)} = E(\text{dB}\mu\text{V}/\text{m}) + 20\log D - 104.8$ ; where D is the measurement distance in meters.
- 2) The EUT was tested in three orthogonal planes and in all possible test configurations and positioning. The worst case emissions are reported with the EUT positioning, modulations, RB sizes and offsets, and channel bandwidth configurations shown in the tables below.
- 3) This unit was tested while powered by an DC power source.
- 4) The EUT was tested in three orthogonal planes and in all possible test configurations and positioning. The worst case setup is reported in the tables below.
- 5) The spectrum is measured from 9kHz to the 10th harmonic of the fundamental frequency of the transmitter. The worst-case emissions are reported.
- 6) Emissions below 18GHz were measured at a 3 meter test distance while emissions above 18GHz were measured at a 1 meter test distance with the application of a distance correction factor.
- 7) The "-" shown in the following RSE tables are used to denote a noise floor measurement.

<b>FCC ID:</b> RI7LE910CXWWX <b>IC:</b> 5131A-LE910CXWWX	 <b>PART 27 / RSS-199 MEASUREMENT REPORT</b>	<b>Approved by:</b> Technical Manager
<b>Test Report S/N:</b> 1M2106040065-07.RI7	<b>Test Dates:</b> 5/12 - 6/1/2021	<b>EUT Type:</b> Data Terminal Module

## LTE Band 7

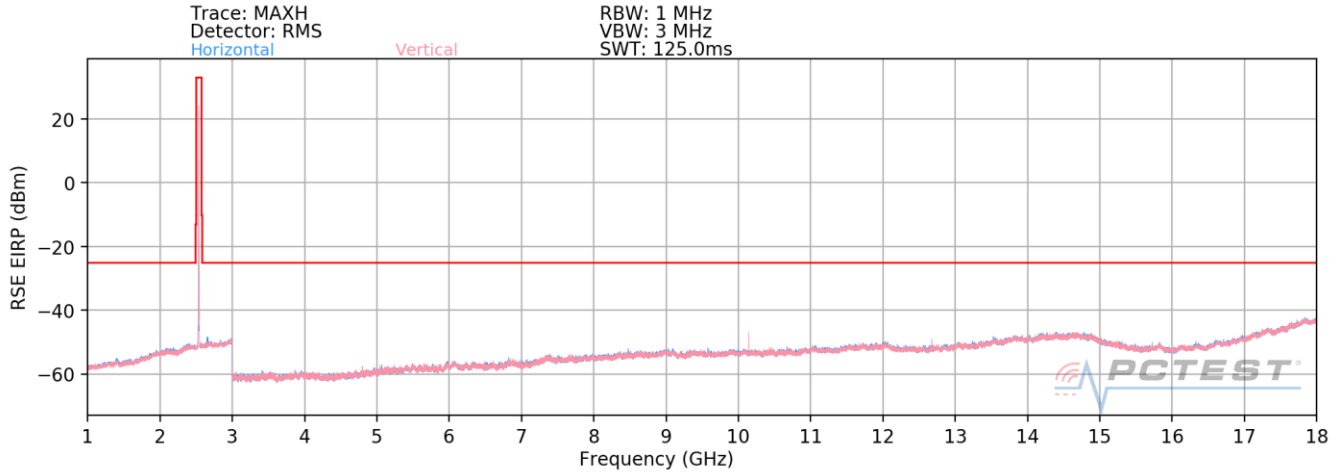

Plot 7-34. Radiated Spurious Plot (LTE Band 7)

Bandwidth (MHz):	20
Frequency (MHz):	2510.0
RB / Offset:	1 / 50

Frequency [MHz]	Ant. Pol. [H/V]	Antenna Height [cm]	Turntable Azimuth [degree]	Analyzer Level [dBm]	AFCL [dB/m]	Field Strength [dBμV/m]	EIRP Spurious Emission Level [dBm]	Limit [dBm]	Margin [dB]
5020.0	V	129	284	-75.76	4.33	35.57	-59.69	-25.00	-34.69
7530.0	V	398	74	-78.42	8.99	37.57	-57.69	-25.00	-32.69
10040.0	V	342	357	-66.84	11.47	51.63	-43.63	-25.00	-18.63
12550.0	V	396	151	-63.95	13.60	56.65	-38.61	-25.00	-13.61
15060.0	V	368	109	-76.92	15.38	45.46	-49.80	-25.00	-24.80
17570.0	V	-	-	-80.76	19.31	45.55	-49.70	-25.00	-24.70

cTable 7-3. Radiated Spurious Data (LTE Band 7 – Low Channel)

Bandwidth (MHz):	20
Frequency (MHz):	2535.0
RB / Offset:	1 / 50

Frequency [MHz]	Ant. Pol. [H/V]	Antenna Height [cm]	Turntable Azimuth [degree]	Analyzer Level [dBm]	AFCL [dB/m]	Field Strength [dBμV/m]	EIRP Spurious Emission Level [dBm]	Limit [dBm]	Margin [dB]
5070.0	V	384	286	-74.52	4.67	37.15	-58.11	-25.00	-33.11
7605.0	V	398	68	-77.58	8.80	38.22	-57.04	-25.00	-32.04
10140.0	V	384	3	-65.08	11.51	53.43	-41.83	-25.00	-16.83
12675.0	V	252	170	-61.96	13.33	58.37	-36.89	-25.00	-11.89
15210.0	V	385	272	-77.76	14.92	44.16	-51.10	-25.00	-26.10
17745.0	V	-	-	-80.83	21.30	47.47	-47.78	-25.00	-22.78



Table 7-4. Radiated Spurious Data (LTE Band 7 – Mid Channel)

FCC ID: RI7LE910CXWWX IC:5131A-LE910CXWWX	 PCTEST Proud to be part of element	PART 27 / RSS-199 MEASUREMENT REPORT	Approved by: Technical Manager
Test Report S/N: 1M2106040065-07.RI7	Test Dates: 5/12 - 6/1/2021	EUT Type: Data Terminal Module	Page 38 of 42

<b>Bandwidth (MHz):</b>	20
<b>Frequency (MHz):</b>	2560.0
<b>RB / Offset:</b>	1 / 50

Frequency [MHz]	Ant. Pol. [H/V]	Antenna Height [cm]	Turntable Azimuth [degree]	Analyzer Level [dBm]	AFCL [dB/m]	Field Strength [dBμV/m]	EIRP Spurious Emission Level [dBm]	Limit [dBm]	Margin [dB]
5120.00	V	111	23	-75.88	4.65	35.77	-59.49	-25.00	-34.49
7680.00	V	207	73	-75.64	9.39	40.75	-54.51	-25.00	-29.51
10240.00	V	328	358	-64.49	11.79	54.30	-40.95	-25.00	-15.95
12800.00	V	334	319	-64.82	13.45	55.63	-39.63	-25.00	-14.63
15360.00	V	233	116	-77.58	13.87	43.29	-51.97	-25.00	-26.97
17920.00	V	-	-	-80.85	21.82	47.97	-47.29	-25.00	-22.29

**Table 7-5. Radiated Spurious Data (LTE Band 7 – High Channel)**

<b>FCC ID:</b> RI7LE910CXWWX <b>IC:</b> 5131A-LE910CXWWX	 <b>PCTEST</b> Proud to be part of 	<b>PART 27 / RSS-199 MEASUREMENT REPORT</b>	<b>Approved by:</b> Technical Manager
<b>Test Report S/N:</b> 1M2106040065-07.RI7	<b>Test Dates:</b> 5/12 - 6/1/2021	<b>EUT Type:</b> Data Terminal Module	Page 39 of 42

## 7.8 Frequency Stability / Temperature Variation

### Test Overview and Limit

Frequency stability testing is performed in accordance with the guidelines of ANSI/TIA-603-E-2016. The frequency stability of the transmitter is measured by:

- a.) **Temperature:** The temperature is varied from -30°C to +50°C in 10°C increments using an environmental chamber.
- b.) **Primary Supply Voltage:** The primary supply voltage is varied from 85% to 115% of the nominal value for non hand-carried battery and AC powered equipment. For hand-carried, battery-powered equipment, primary supply voltage is reduced to the battery operating end point which shall be specified by the manufacturer.

### Test Procedure Used

ANSI/TIA-603-E-2016

### Test Settings

1. The carrier frequency of the transmitter is measured at room temperature (20°C to provide a reference).
2. The equipment is turned on in a “standby” condition for fifteen minutes before applying power to the transmitter. Measurement of the carrier frequency of the transmitter is made within one minute after applying power to the transmitter.
3. Frequency measurements are made at 10°C intervals ranging from -30°C to +50°C. A period of at least one half-hour is provided to allow stabilization of the equipment at each temperature level.

### Test Setup

The EUT was connected via an RF cable to a spectrum analyzer with the EUT placed inside an environmental chamber.

### Test Notes

None

<b>FCC ID:</b> RI7LE910CXWWX <b>IC:</b> 5131A-LE910CXWWX	 <b>PART 27 / RSS-199 MEASUREMENT REPORT</b>	<b>Approved by:</b> Technical Manager
<b>Test Report S/N:</b> 1M2106040065-07.RI7	<b>Test Dates:</b> 5/12 - 6/1/2021	<b>EUT Type:</b> Data Terminal Module  Page 40 of 42



**LTE Band 7**

<b>LTE Band 7</b>					
Operating Frequency (Hz):		2,535,000,000			
Ref. Voltage (VDC):		3.80			
Voltage (%)	Power (VDC)	Temp (°C)	Frequency (Hz)	Freq. Dev. (Hz)	Deviation (%)
100 %	3.80	- 30	2,534,989,209	-650	-0.0000256
		- 20	2,534,988,511	-1,348	-0.0000532
		- 10	2,534,989,414	-444	-0.0000175
		0	2,534,990,562	704	0.0000278
		+ 10	2,534,989,385	-473	-0.0000187
		+ 20 (Ref)	2,534,989,858	0	0.0000000
		+ 30	2,534,991,861	2,003	0.0000790
		+ 40	2,534,990,049	191	0.0000075
85 %	3.23	+ 20	2,534,988,912	-947	-0.0000373
115 %	4.37	+ 20	2,534,990,342	483	0.0000191

**Table 7-6. LTE Band 7 Frequency Stability Data**

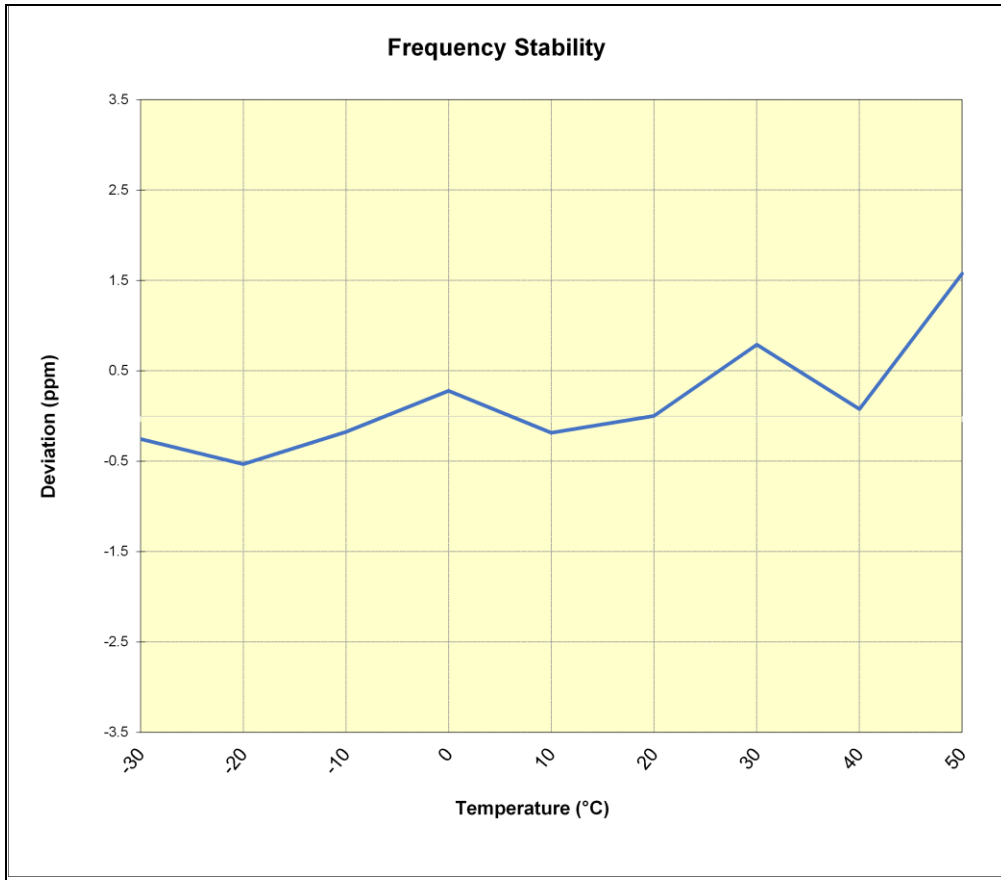

**Plot 7-35. LTE Band 7 Frequency Stability Chart**

FCC ID: RI7LE910CXWWX IC:5131A-LE910CXWWX	<b>PCTEST</b> Proud to be part of element	PART 27 / RSS-199 MEASUREMENT REPORT	Approved by: Technical Manager
Test Report S/N: 1M2106040065-07.RI7	Test Dates: 5/12 - 6/1/2021	EUT Type: Data Terminal Module	Page 41 of 42

## 8.0 CONCLUSION

The data collected relate only to the item(s) tested and show that the **Telit Communications S.p.A Data Terminal Module FCC ID: RI7LE910CXWWX / IC:5131A-LE910CXWWX** complies with all the requirements of Part 27 of the FCC rules and RSS-199 rules.

<b>FCC ID:</b> RI7LE910CXWWX <b>IC:</b> 5131A-LE910CXWWX	 <b>PART 27 / RSS-199 MEASUREMENT REPORT</b>	<b>Approved by:</b> Technical Manager
<b>Test Report S/N:</b> 1M2106040065-07.RI7	<b>Test Dates:</b> 5/12 - 6/1/2021	<b>EUT Type:</b> Data Terminal Module  Page 42 of 42