



Datasheet

Optimus

Part No:
MA220.LB.001

Description:
MA220 2in1 GPS/GLONASS/Galileo and LTE External Adhesive Antenna
for Glass & Plastic Mount

Features:
GPS-GLONASS-GALILEO - High gain LNA up to 32dB
4G LTE band – 698 MHz to 6000MHz
IP67 Rated
Manufactured in an IATF16949 Certified Facility
Height 12mm Diameter 62.8mm
Cable: 3m RG-174
Connector: SMA(M) Straight
RoHS and REACH Compliant

1. Introduction	3
2. Specifications	4
3. Antenna Characteristics - LTE	7
4. Antenna Characteristics - GNSS	9
5. Radiation Patterns - LTE	12
6. Radiation Patterns - GNSS	53
7. Mechanical Drawing	56
<hr/>	
8. Packaging	57
<hr/>	
Changelog	58

Taoglas makes no warranties based on the accuracy or completeness of the contents of this document and reserves the right to make changes to specifications and product descriptions at any time without notice. Taoglas reserves all rights to this document and the information contained herein. Reproduction, use or disclosure to third parties without express permission is strictly prohibited.



1. Introduction



The Optimus MA220 is a combination high performance GPS-GLONASS-GALILEO and 4G/3G/2G LTE (plus GSM /CDMA/PCS/DCS/UMTS/GPRS/EDGE/HSPA) antenna to simplify Automotive Telematic and Fleet management systems worldwide. Its high quality low profile covert housing can be attached onto the glass or even out of sight under the dashboard. This combination of a high gain GPS/GLONASS/GALILEO antenna and a LTE antenna is ideal for those applications that require durability, small size and covert installation, and reliable reception and transmission crossing through different mobile networks.

The LTE cellular antenna function covers all main LTE and 3G/2G cellular bands worldwide. It has been designed to work equally well when mounted on glass or on plastic. It is not suitable for mounting on metal.

The GPS/GLONASS/GALILEO function means increased accuracy and reliability of location. A front-end SAW protects the LNA from burnout by nearby out of band cellular transmissions and also significantly reduces any compression and consequent reduction of sensitivity.

The standard version has 3 metres RG174 cable and SMA(M) connector on both GPS/GLONASS/GALILEO and LTE. For even higher gain and efficiency we recommend if you can to use shorter cable lengths, as shown in the charts below. The cable lengths and connector types are completely customizable according to customer request, subject to a minimum order quantity.

The slim housing is fully IP67 waterproof. A separate automotive approved 3M adhesive pad is provided, allowing the antenna to be mounted correctly facing through glass, or directly onto a plastic surface like the dashboard of a vehicle.

This antenna has been Manufactured in an IATF16949 Certified Facility.

Note if US LTE network certification is required contact Taoglas for advice on correct antenna choice.

2. Specifications

GNSS Frequency Bands Covered							
GPS/QZSS	L1 1575.42MHz	L2 1227.6MHz	L5 1176.45MHz	L6 1278.75MHz			
	■	□	□	□			
GLONASS	L5R 1176.45MHz	L3PT 1201.5MHz	L2PT 1246MHz	L1CR 1575.42MHz	L1PT 1602MHz		
	□	□	□	□	■		
Galileo	E5a 1176.45MHz	E5b 1201.5MHz	E4 1215MHz	E3 1256MHz	E6 1278.75MHz	E2 1561MHz	L1 1575.42MHz
	□	□	□	□	□	□	■
BeiDou	B1 1561MHz	B2 1207.14MHz	B3 1268.52MHz				
	□	□	□				
Compass	E5B(B2)/ E6(B3) 1268.56MHz	E2(B1) 1561MHz					
	□	□					
SBAS	Omnistar 1542.5MHz	WAAS/EGN OS 1575.42MHz					
	□	■					

GNSS Electrical		
Frequency (MHz)	1575.42	1602
VSWR (max.)	1.92:1	1.92:1
Return Loss	5 dB Min.	
Gain	31 dB Min. @3.3V	
DC Power Input	3.3V	
Noise Figure @3.3V	1.5dB	
Power Consumption	12mA	
Polarization	Linear	
Impedance	50Ω	
Cable	3m RG174 standard, fully customizable	
Connector	SMA(M)	

LTE								
Band	Frequency (MHz)		Efficiency (%)	Average Gain (dB)	Peak Gain (dBi)	VSWR	Impedance	Polarization
5G NR/4G Band 5,8,12,13,14,17,18,20, 26,27,28, 29,71	617~960	Free Space	24.1	-6.7	1.4	3 Max	50Ω	Linear
		2mm ABS GroundPlane	19.3	-7.5	1.2			
		12x12cm Glass Groundplane	24.0	-6.8	1.7			
5G NR/4G Band 21,32,74,75,76	1427~1518	Free Space	7.6	-11.2	-4.5			
		2mm ABS GroundPlane	6.7	-11.8	-4.5			
		12x12cm Glass Groundplane	10.2	-9.9	-3.2			
4G/3G Band 1,2,3,4,9,23,25,35,39,66	1710~2200	Free Space	23.1	-6.4	2.0			
		2mm ABS GroundPlane	24.5	-6.1	2.1			
		12x12cm Glass Groundplane	25.9	-6.0	2.0			
Wi-Fi 2400	2400~2500	Free Space	7.8	-11.2	-2.7			
		2mm ABS GroundPlane	7.3	-11.5	-3.7			
		12x12cm Glass Groundplane	5.9	-12.6	-1.2			
4G/3G Band 7,38,41	2490~2690	Free Space	12.1	-9.3	-3.0			
		2mm ABS GroundPlane	11.6	-9.5	-1.7			
		12x12cm Glass Groundplane	10.1	-10.1	-0.9			
5G NR/4G Band 22,42,43,48,77,78,79	3300~5000	Free Space	19.3	-7.3	1.3			
		2mm ABS GroundPlane	18.5	-7.5	1.4			
		12x12cm Glass Groundplane	18.6	-7.4	1.9			
LTE5200/ Wi-Fi 5800	5150~5925	Free Space	12.2	-9.2	-0.7			
		2mm ABS GroundPlane	11.4	-9.4	-0.6			
		12x12cm Glass Groundplane	11.1	-9.5	-1.7			

*Tested with 3m RG-174

Mechanical	
Dimensions	62.8mm x 68mm x 12mm
Casing	ABS
Cable	3m RG174 standard, fully customizable
Connector	SMA(M)
Environmental	
Protection	IP67
Temperature Range	-40°C to 85°C
Humidity	Non-condensing 65°C 95% RH

5G/4G Bands			
Band Number	5G NR / FR1 / LTE / LTE-Advanced / WCDMA / HSPA / HSPA+ / TD-SCDMA		
	Uplink	Downlink	Covered
1	UL: 1920 to 1980	DL: 2110 to 2170	✓
2	UL: 1850 to 1910	DL: 1930 to 1990	✓
3	UL: 1710 to 1785	DL: 1805 to 1880	✓
4	UL: 1710 to 1755	DL: 2110 to 2155	✓
5	UL: 824 to 849	DL: 869 to 894	✓
7	UL: 2500 to 2570	DL: 2620 to 2690	✓
8	UL: 880 to 915	DL: 925 to 960	✓
9	UL: 1749.9 to 1784.9	DL: 1844.9 to 1879.9	✓
11	UL: 1427.9 to 1447.9	DL: 1475.9 to 1495.9	✓
12	UL: 699 to 716	DL: 729 to 746	✓
13	UL: 777 to 787	DL: 746 to 756	✓
14	UL: 788 to 798	DL: 758 to 768	✓
17	UL: 704 to 716	DL: 734 to 746	✓
18	UL: 815 to 830	DL: 860 to 875	✓
19	UL: 830 to 845	DL: 875 to 890	✓
20	UL: 832 to 862	DL: 791 to 821	✓
21	UL: 1447.9 to 1462.9	DL: 1495.9 to 1510.9	✗
22	UL: 3410 to 3490	DL: 3510 to 3590	✓
23	UL: 2000 to 2020	DL: 2180 to 2200	✓
24	UL: 1625.5 to 1660.5	DL: 1525 to 1559	✓
25	UL: 1850 to 1915	DL: 1930 to 1995	✓
26	UL: 814 to 849	DL: 859 to 894	✓
27	UL: 807 to 824	DL: 852 to 869	✓
28	UL: 703 to 748	DL: 758 to 803	✓
29	UL: -	DL: 717 to 728	✓
30	UL: 2305 to 2315	DL: 2350 to 2360	✗
31	UL: 452.5 to 457.5	DL: 462.5 to 467.5	✗
32	UL: -	DL: 1452 - 1496	✗
35		1850 to 1910	✓
38		2570 to 2620	✓
39		1880 to 1920	✓
40		2300 to 2400	✗
41		2496 to 2690	✓
42		3400 to 3600	✓
43		3600 to 3800	✓
48		3550 to 3700	✓
66	UL: 1710-1780	DL: 2110-2200	✓
71		617 to 698	✓
74/75/76		1427 to 1518	✗
78		3300 to 3800	✓
79		4400 to 5000	✓
85	698-716	728-746	✓

3. Antenna Characteristics - LTE

3.1 Return Loss - LTE

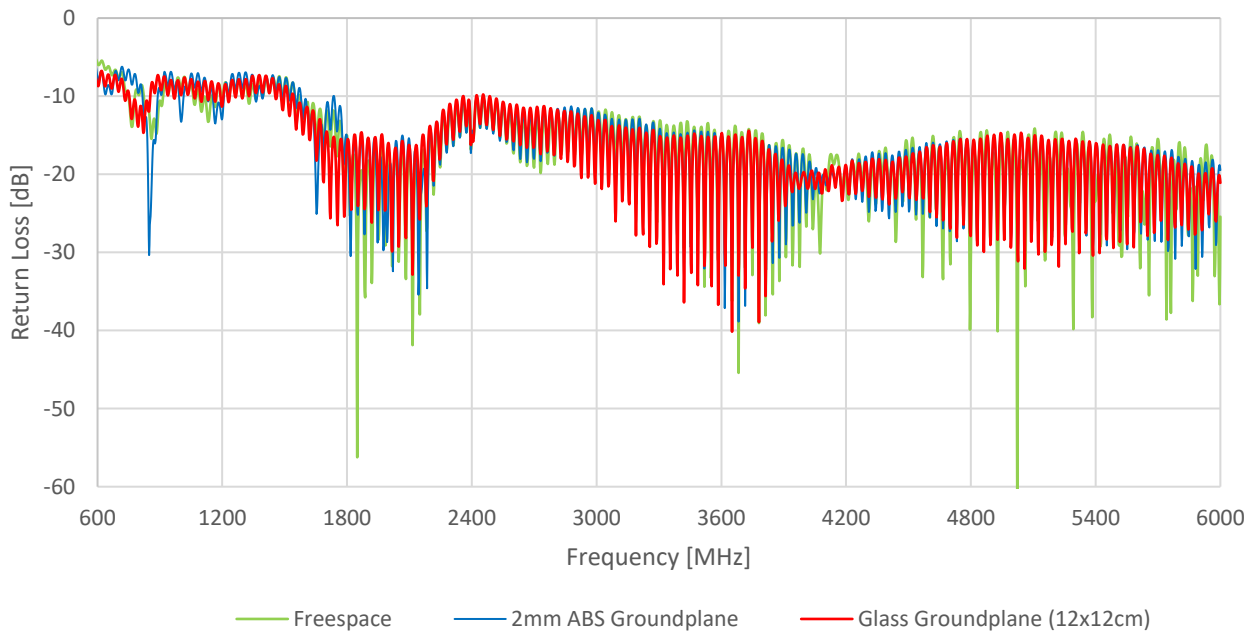

3.2 Efficiency - LTE

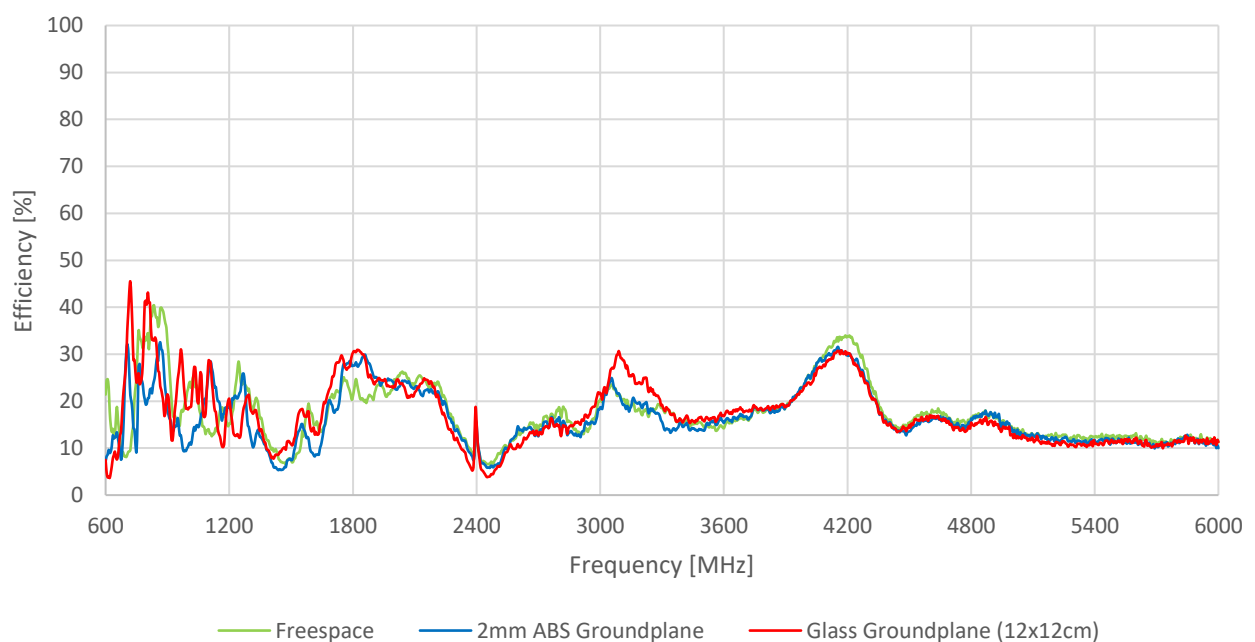

3.3 Average Gain - LTE

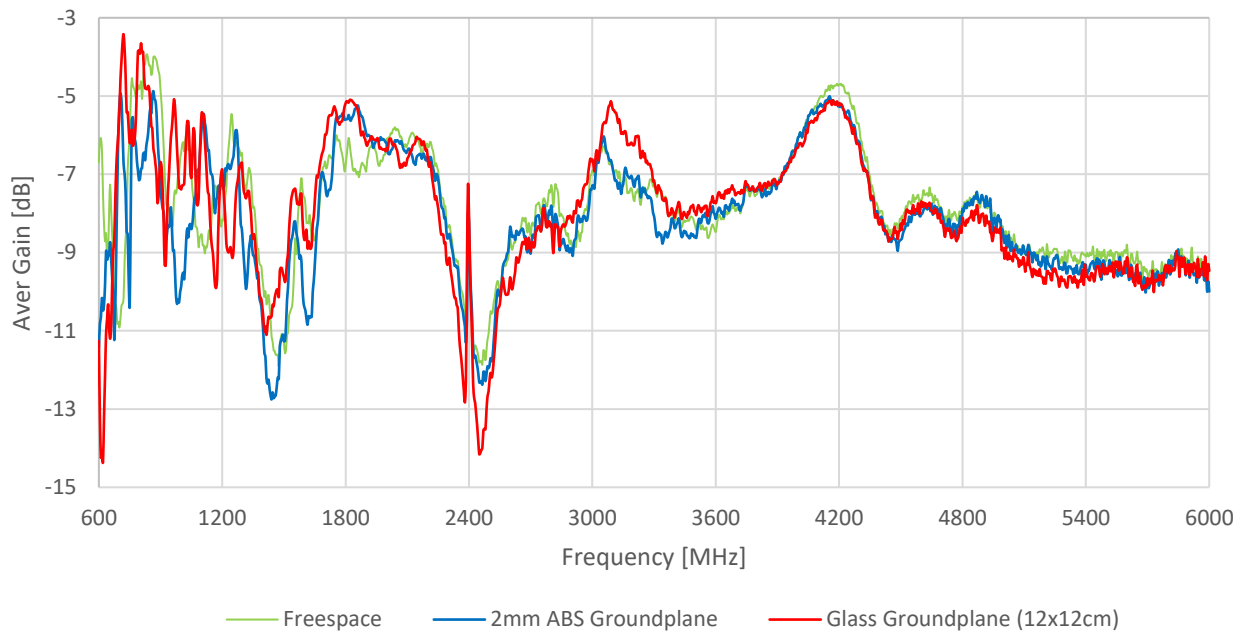

3.4 Peak Gain - LTE

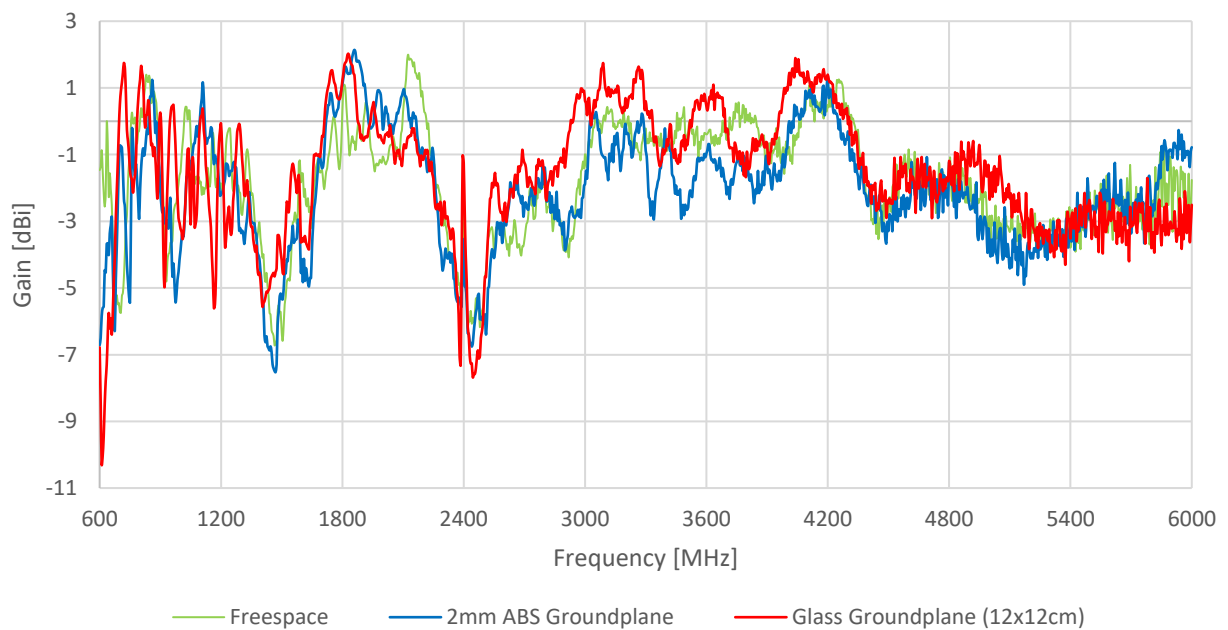

4. Antenna Characteristics - GNSS

4.1 Return Loss - GNSS

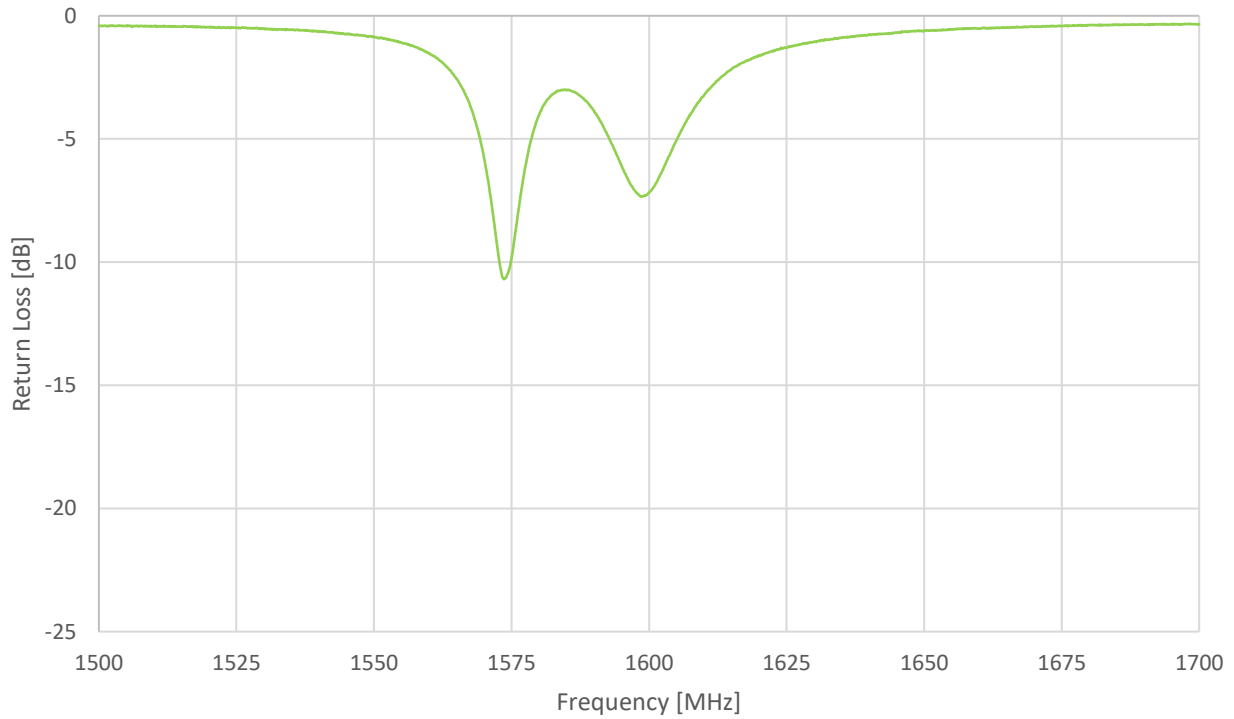

4.2 Efficiency - GNSS

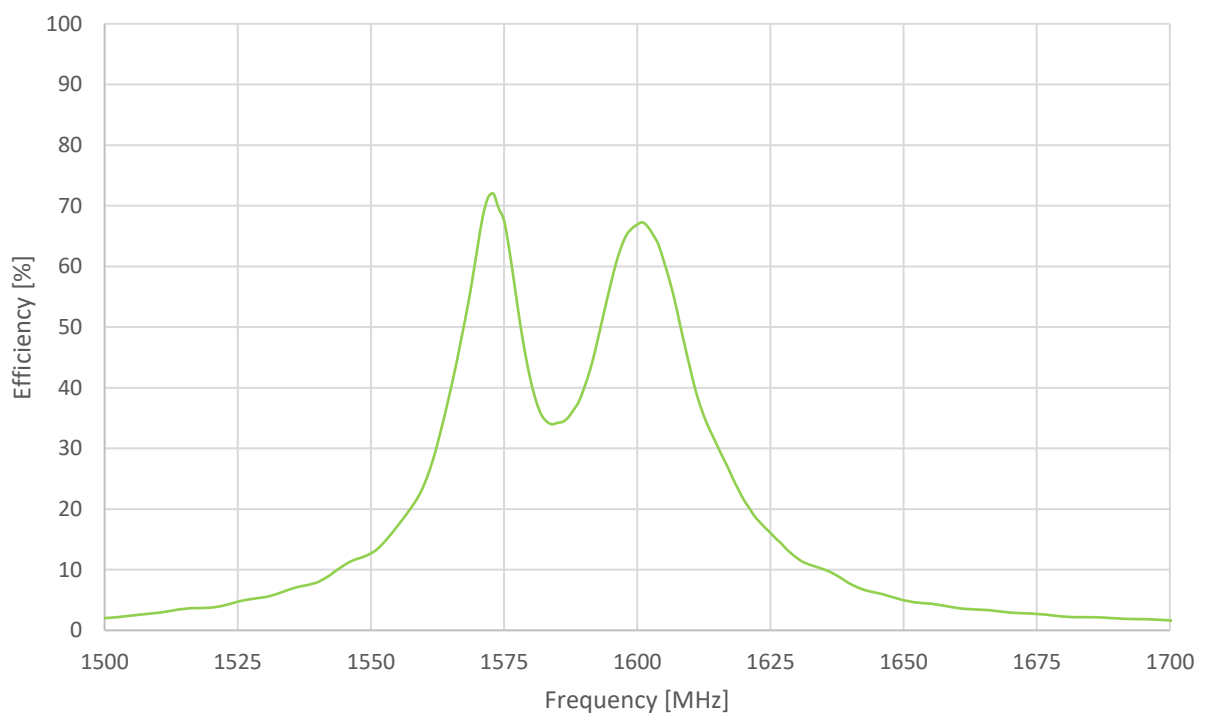

4.3 Peak Gain - GNSS

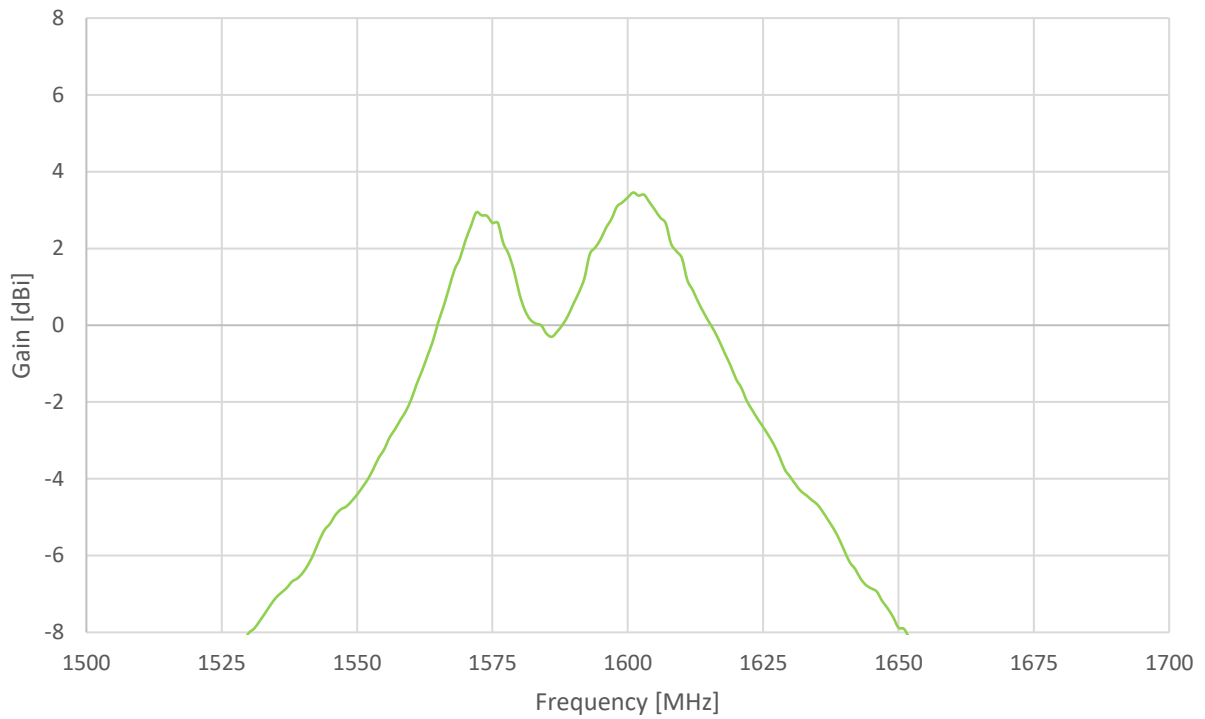

4.4 Average Gain - GNSS

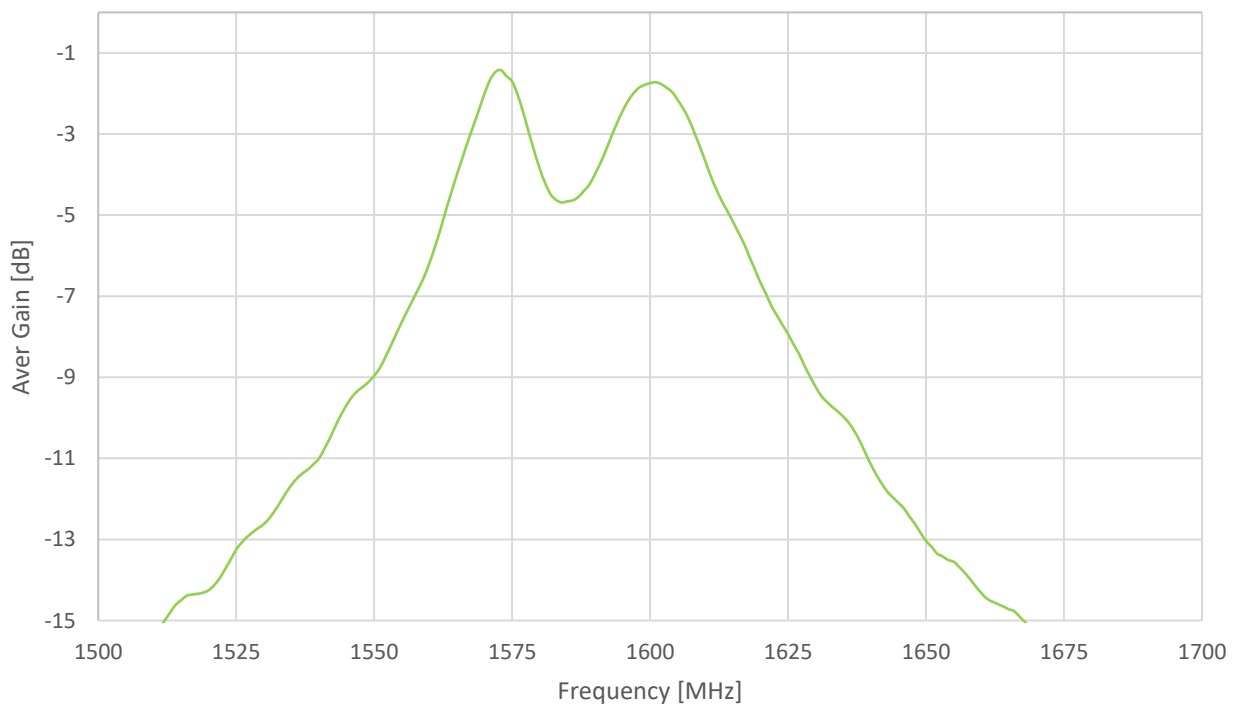

4.5 LNA Gain (Narrow band plot) - GNSS

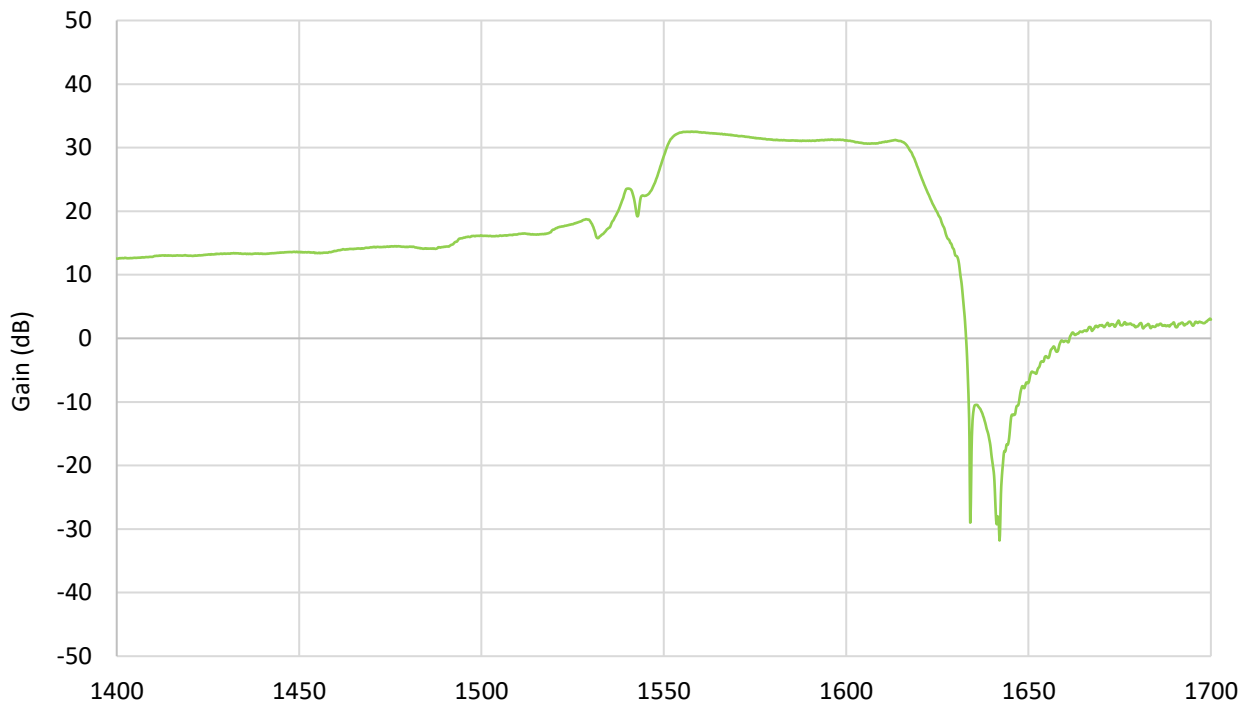

4.6 LNA Gain (Wide band plot) - GNSS

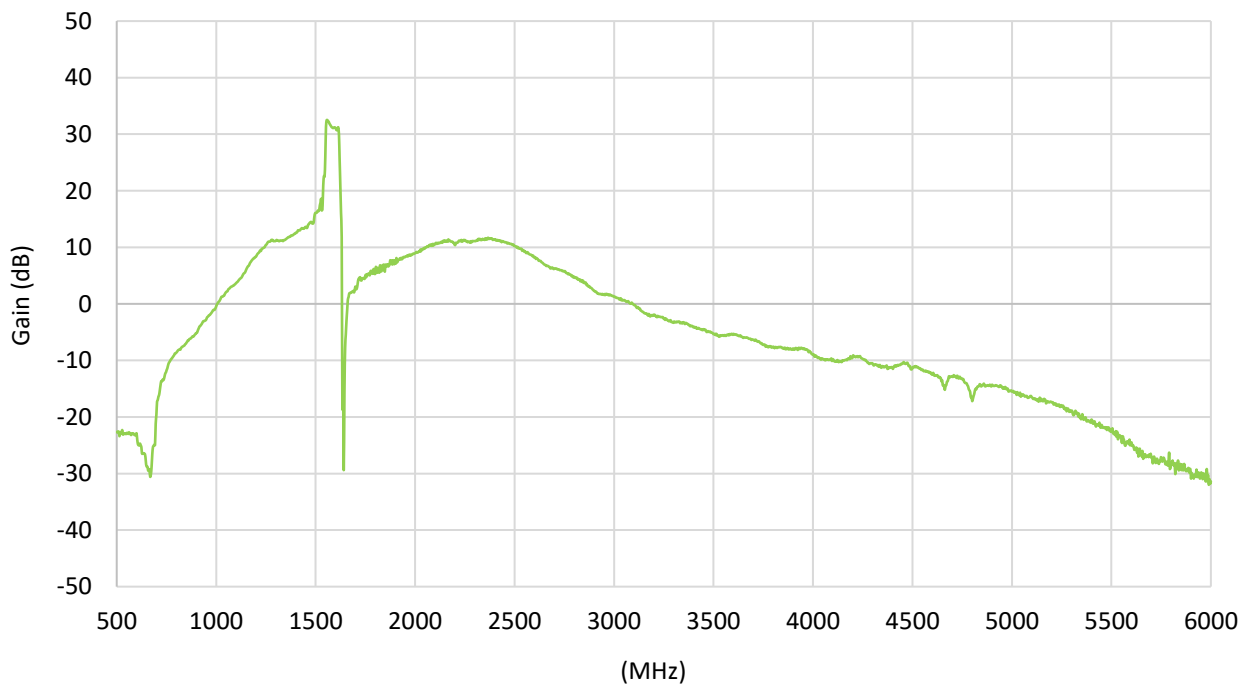

5. Radiation Patterns - LTE

5.1 Test Setup

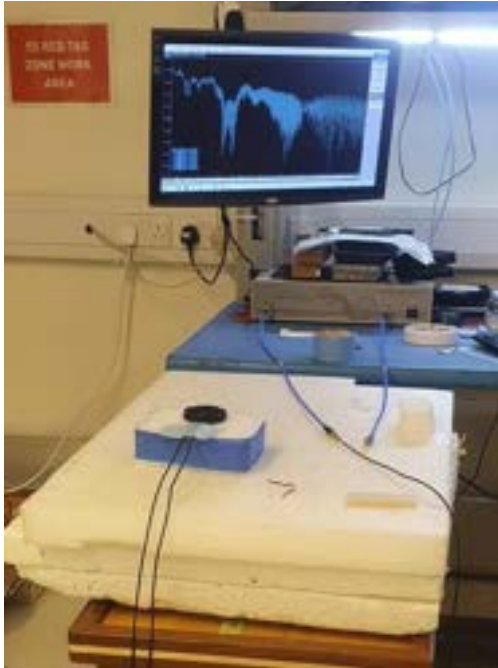

Free space

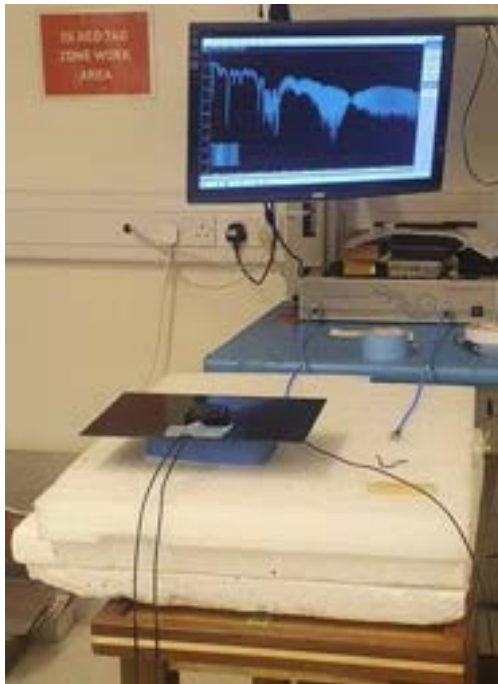

2mm ABS Groundplane

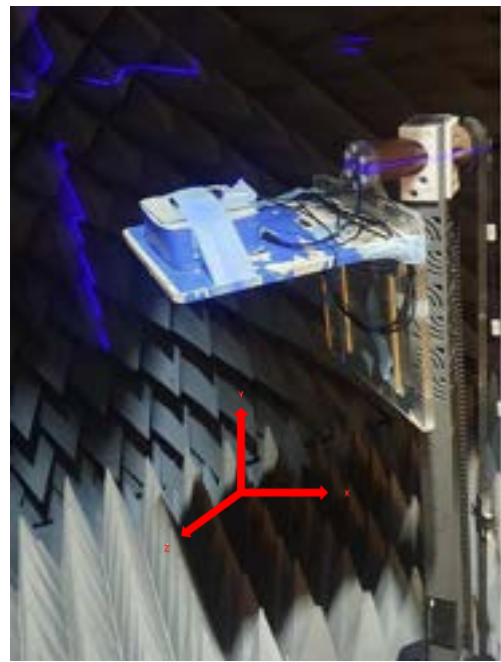
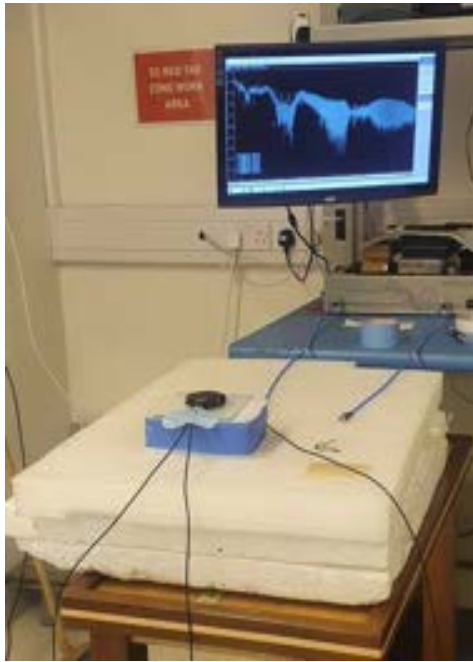

On Glass

5.2 705MHz – LTE Freespace 2D & 3D Radiation Patterns

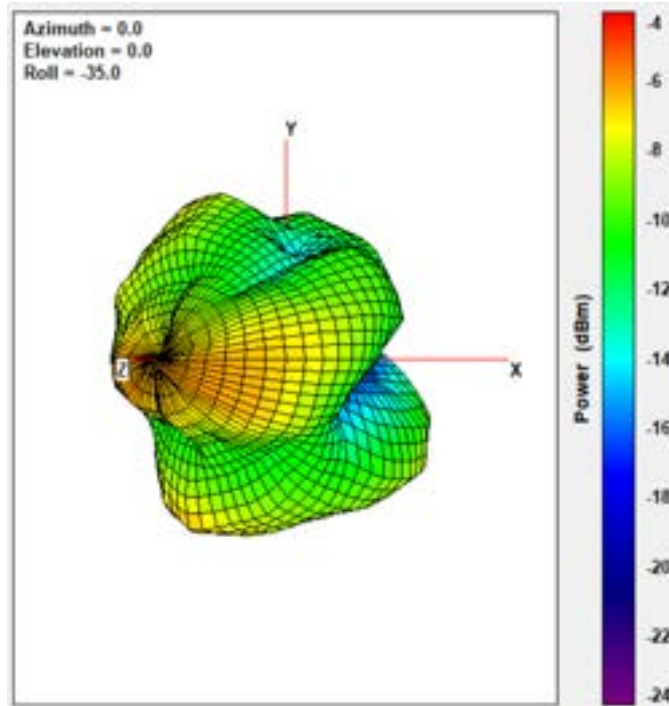

XY Plane

XZ Plane

YZ Plane

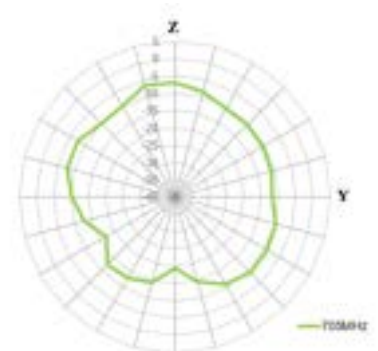
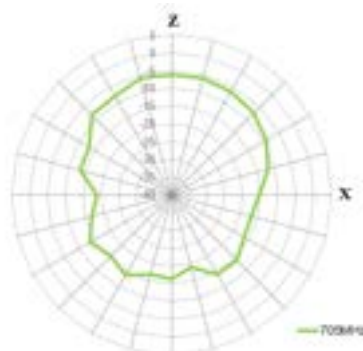
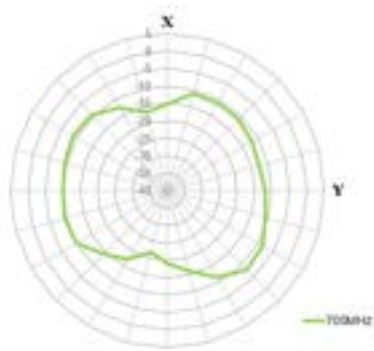

750MHz

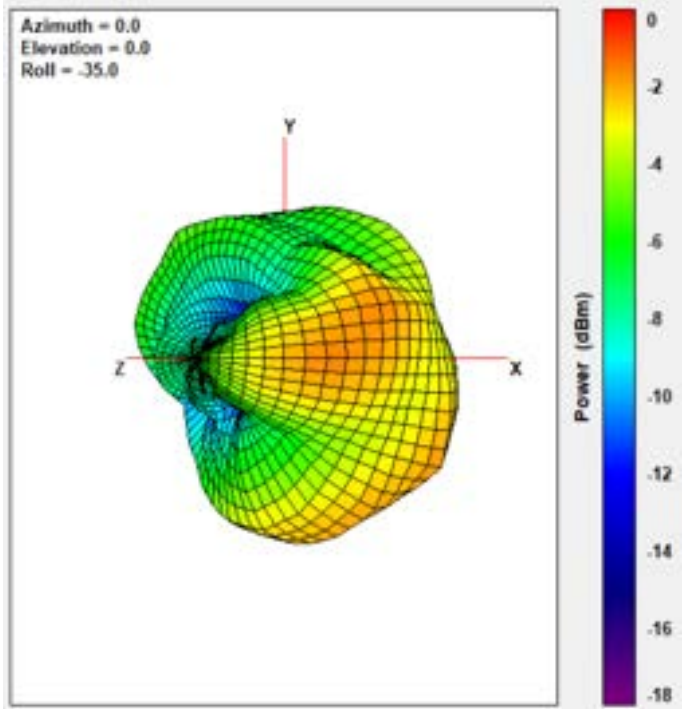

XY Plane

XZ Plane

YZ Plane

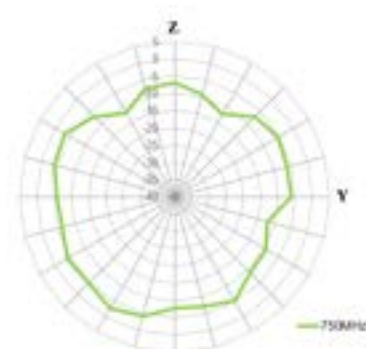
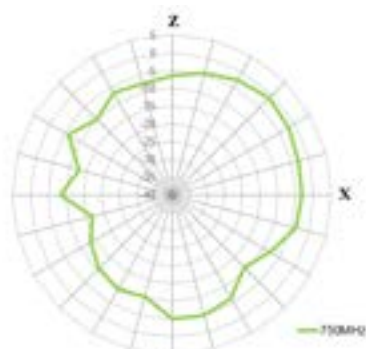
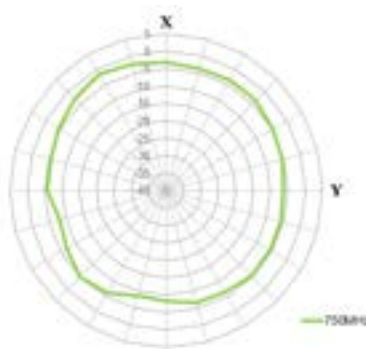

825MHz

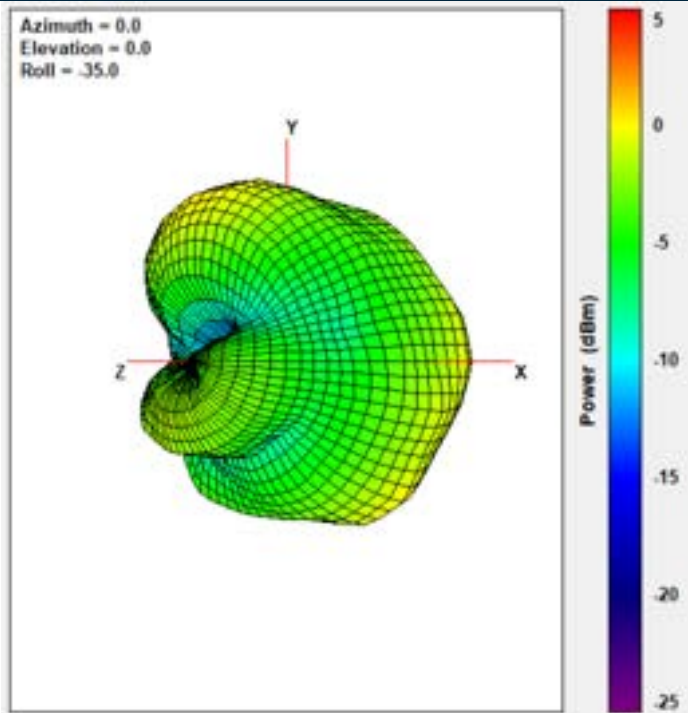

XY Plane

XZ Plane

YZ Plane

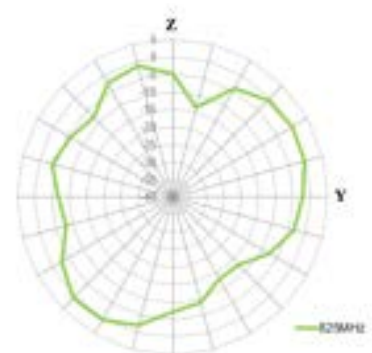
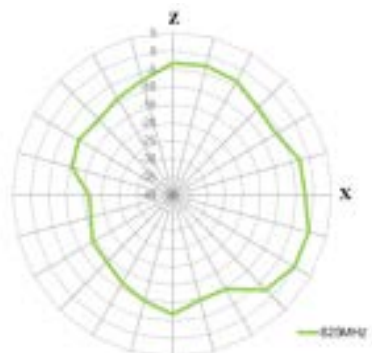
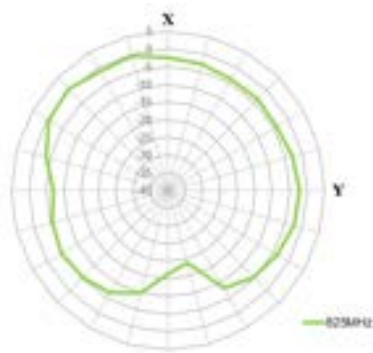

880MHz

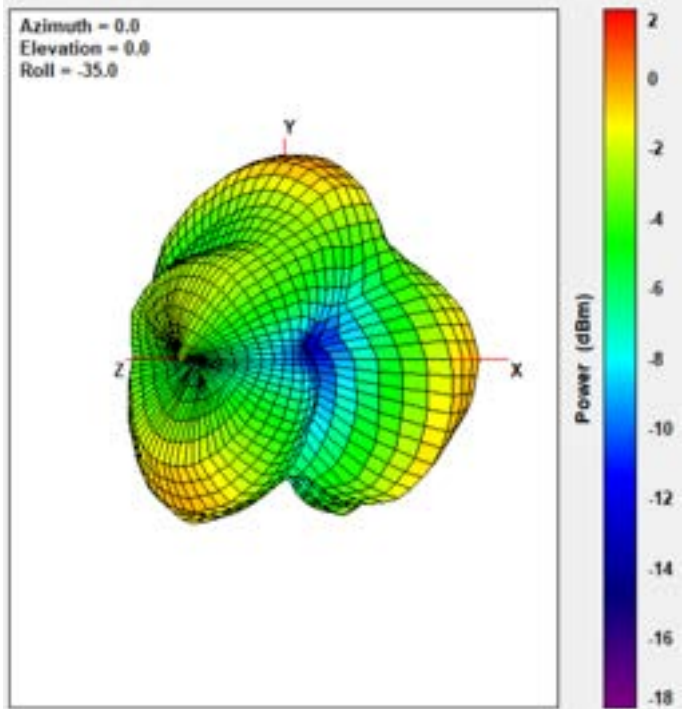

XY Plane

XZ Plane

YZ Plane

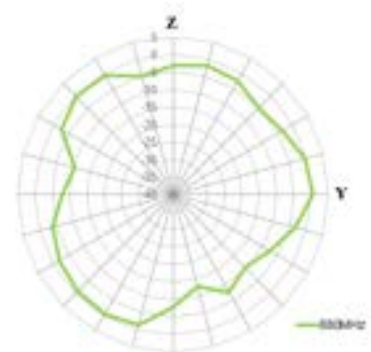
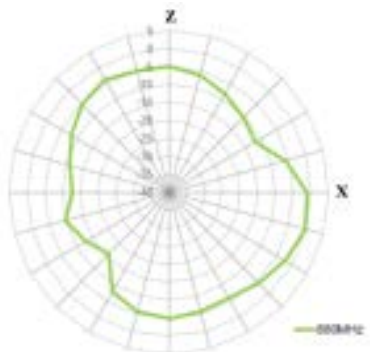
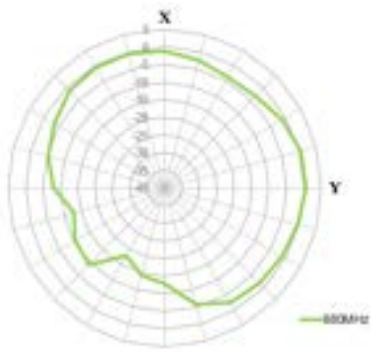

960MHz

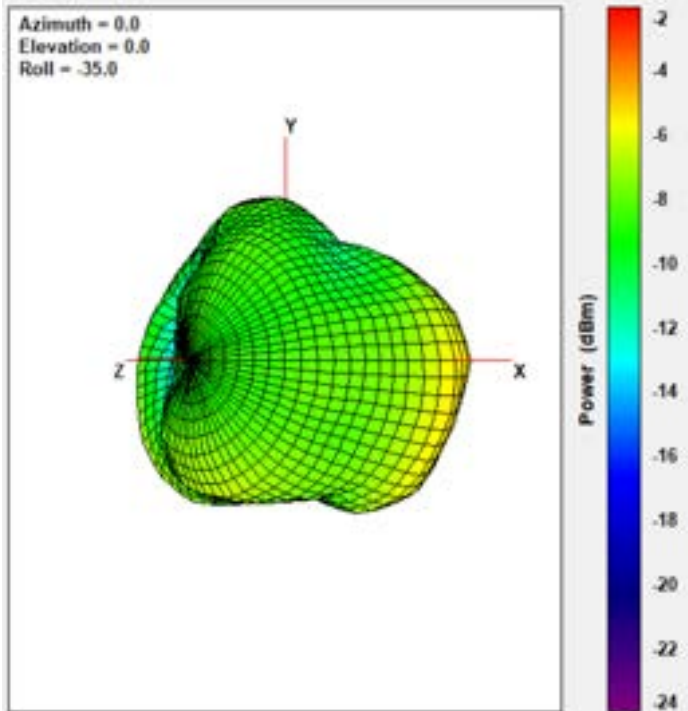

XY Plane

XZ Plane

YZ Plane

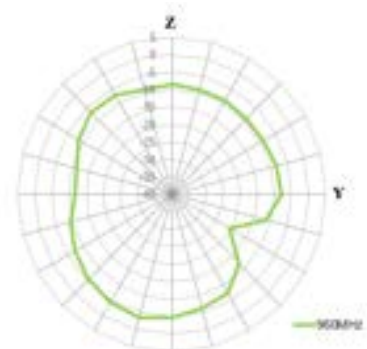
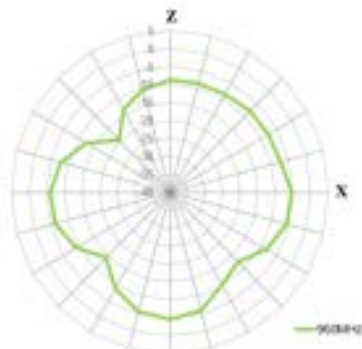
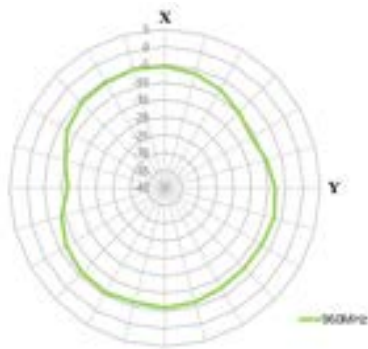

1710MHz

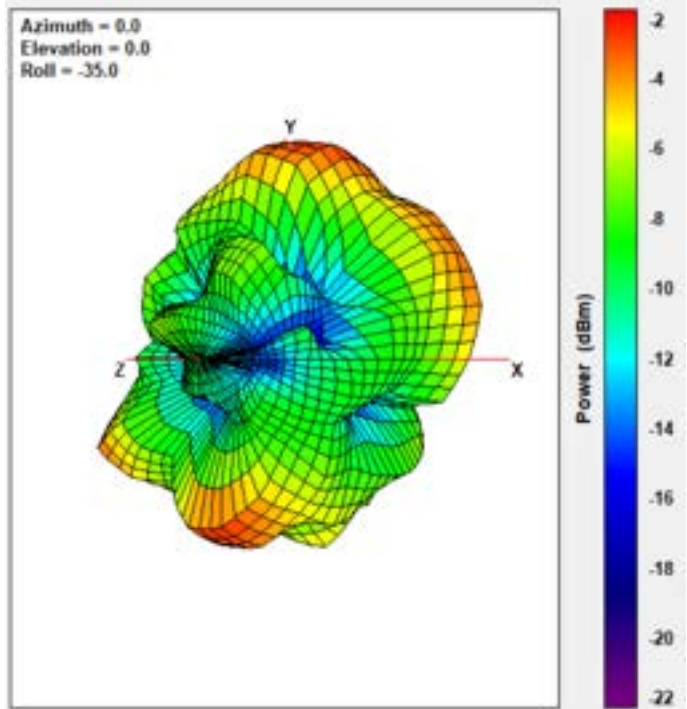

XY Plane

XZ Plane

YZ Plane

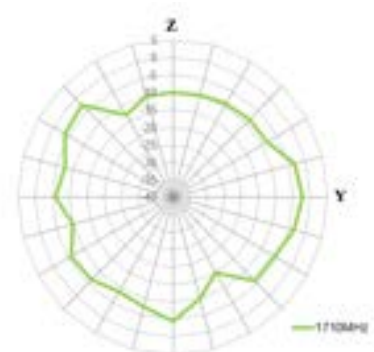
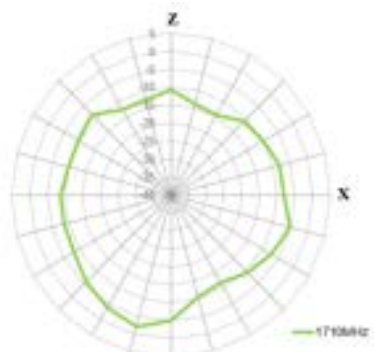
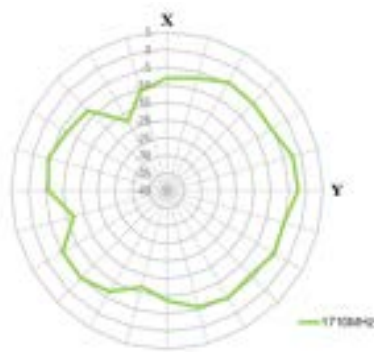

1800MHz

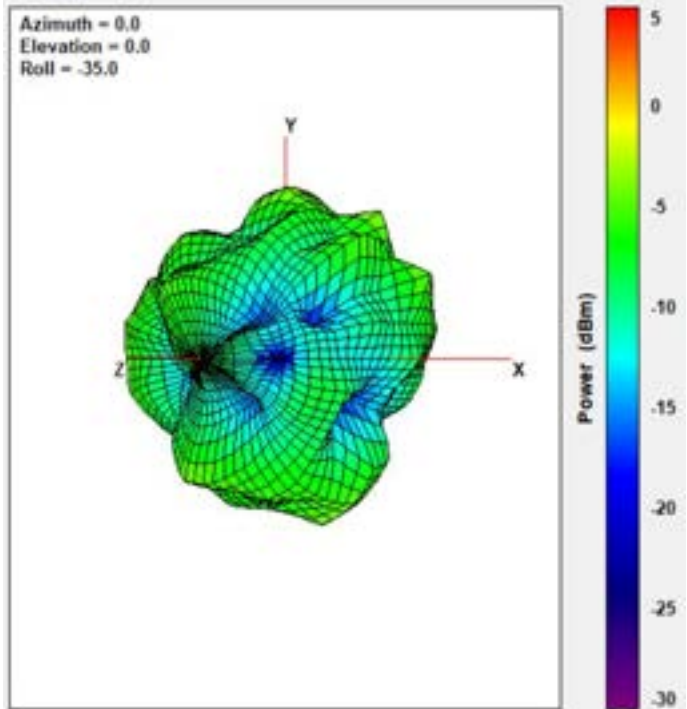

XY Plane

XZ Plane

YZ Plane

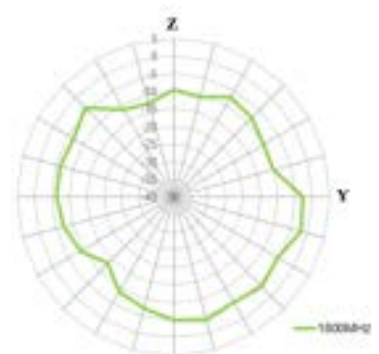
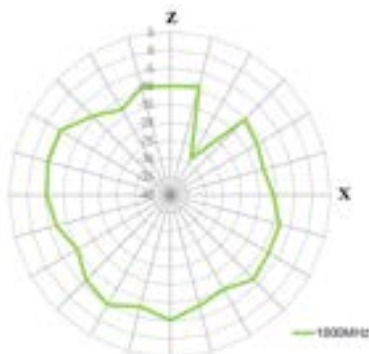
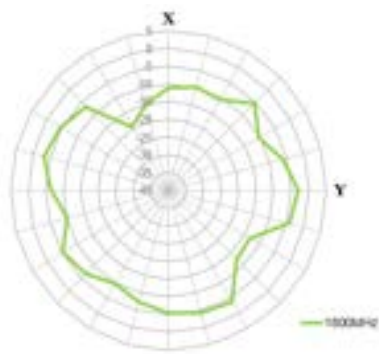

1990MHz

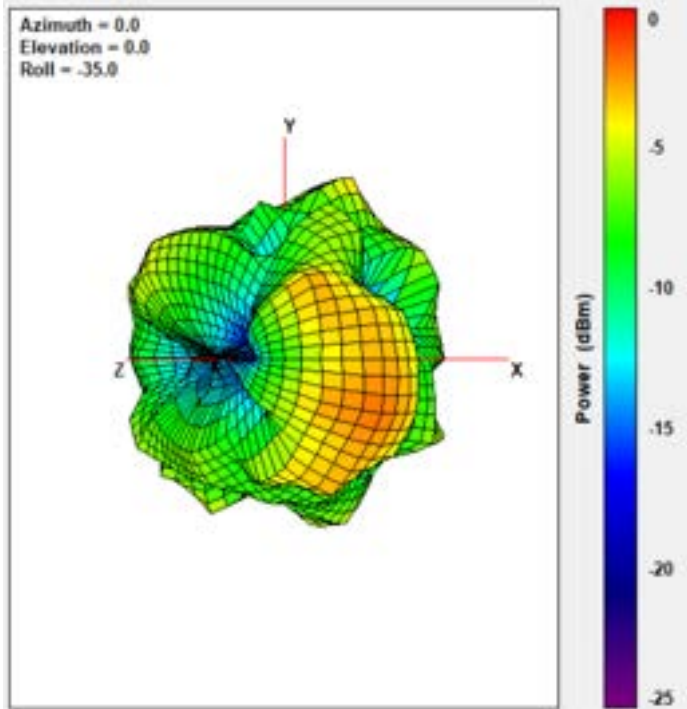

XY Plane

XZ Plane

YZ Plane

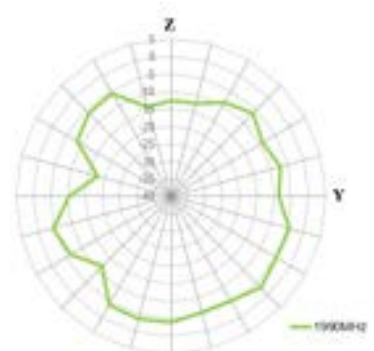
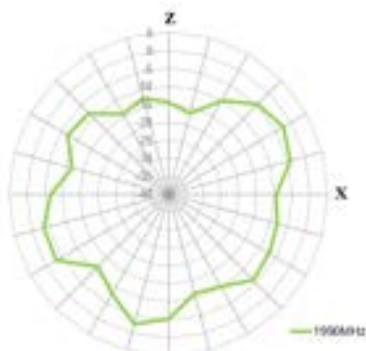
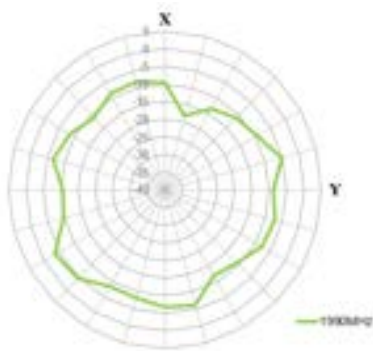

2170MHz

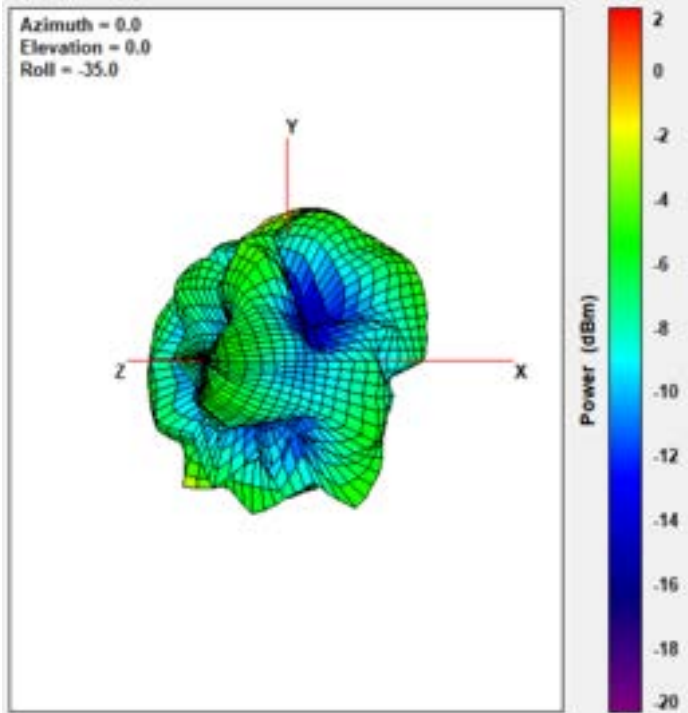

XY Plane

XZ Plane

YZ Plane

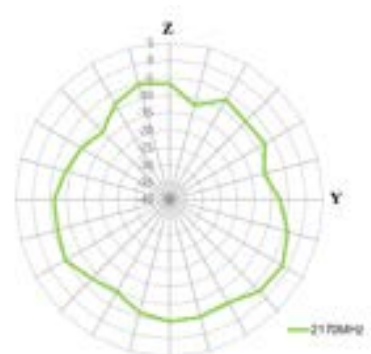
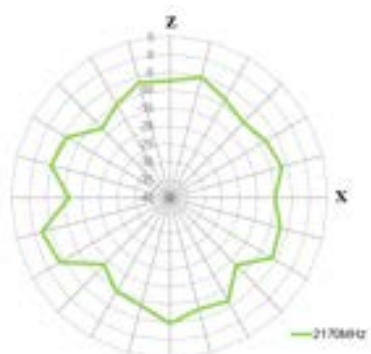
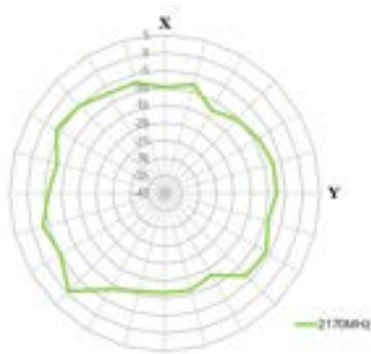

2400MHz

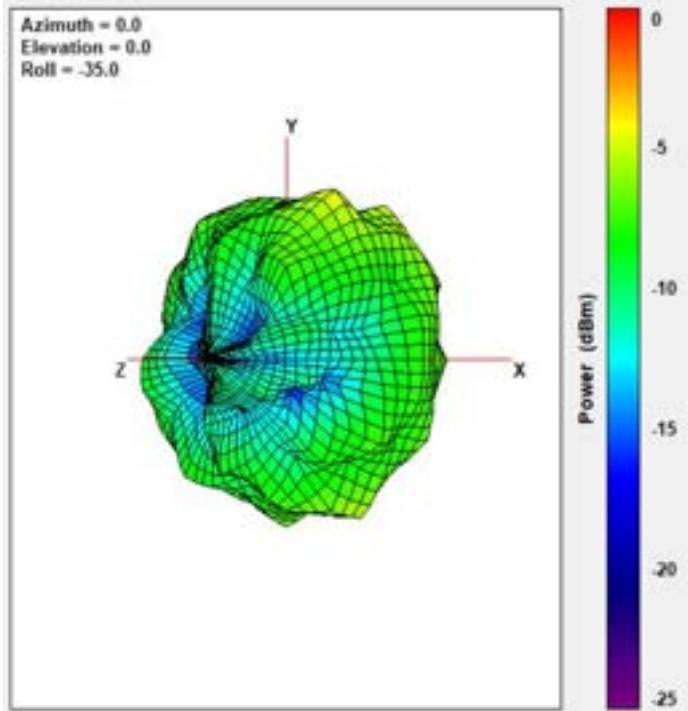

XY Plane

XZ Plane

YZ Plane

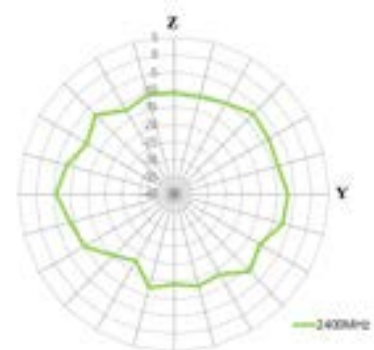
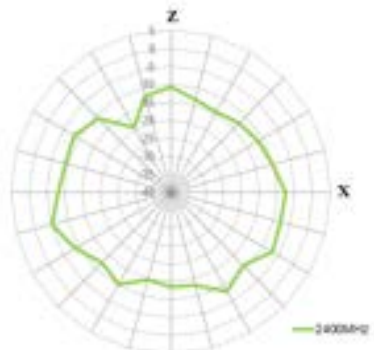
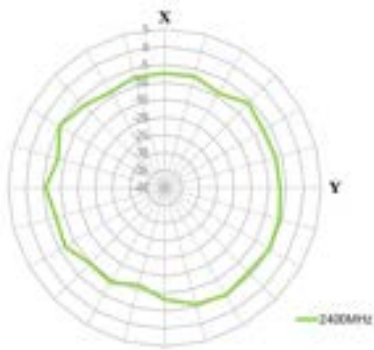

2500MHz

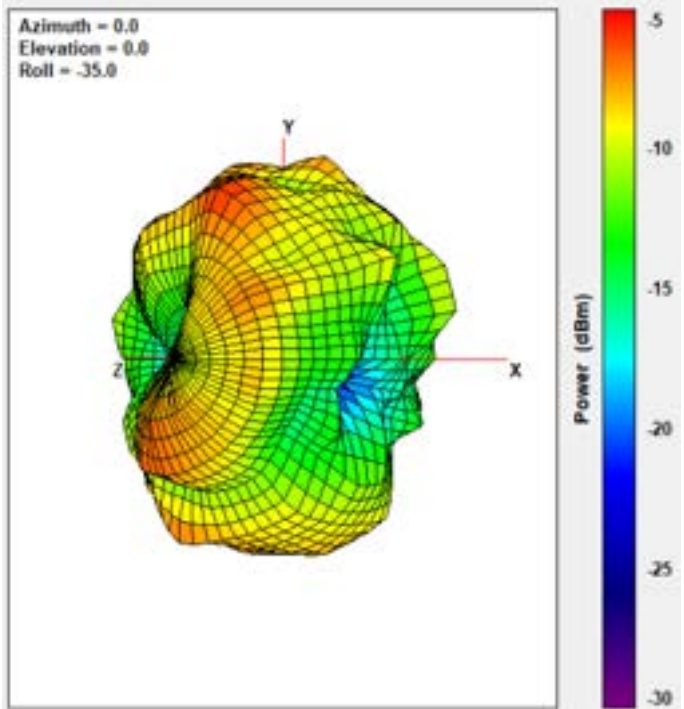

XY Plane

XZ Plane

YZ Plane

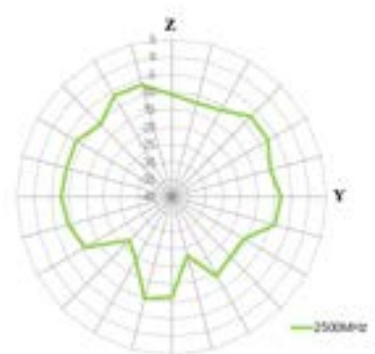
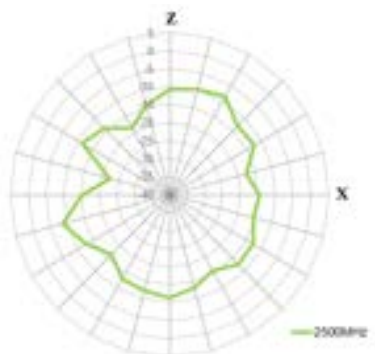
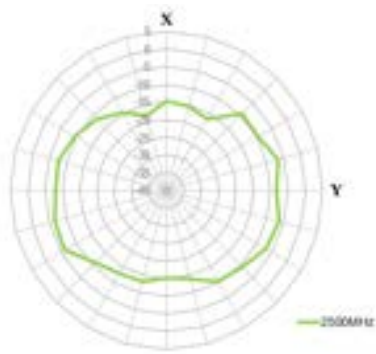

2570MHz

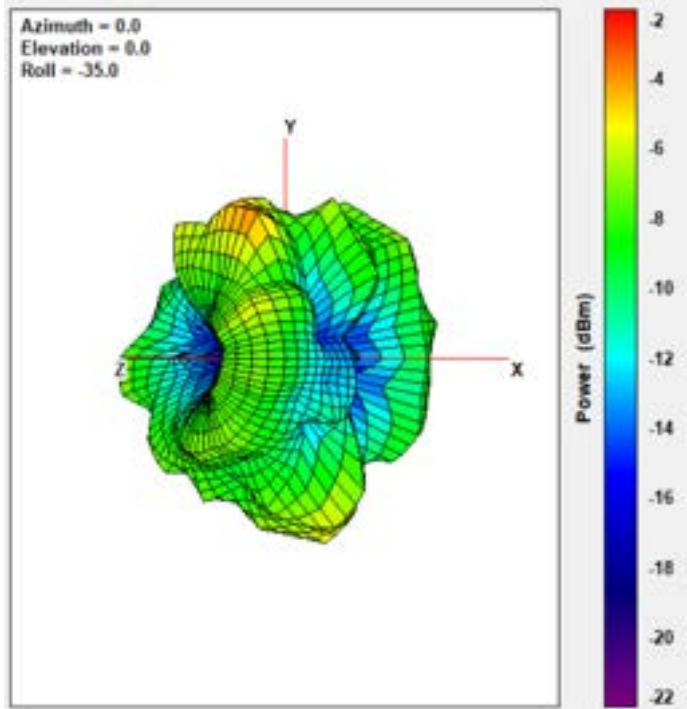

XY Plane

XZ Plane

YZ Plane

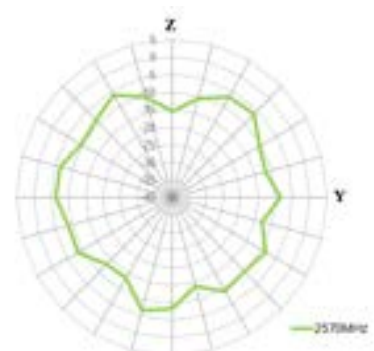
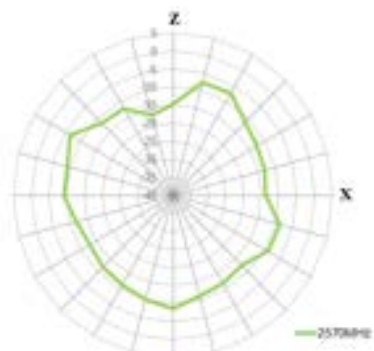
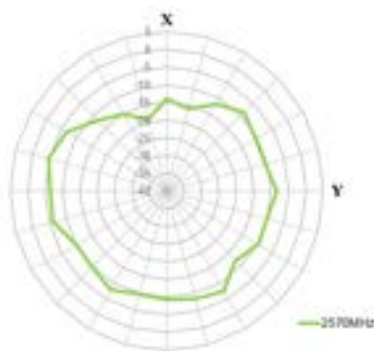

2690MHz

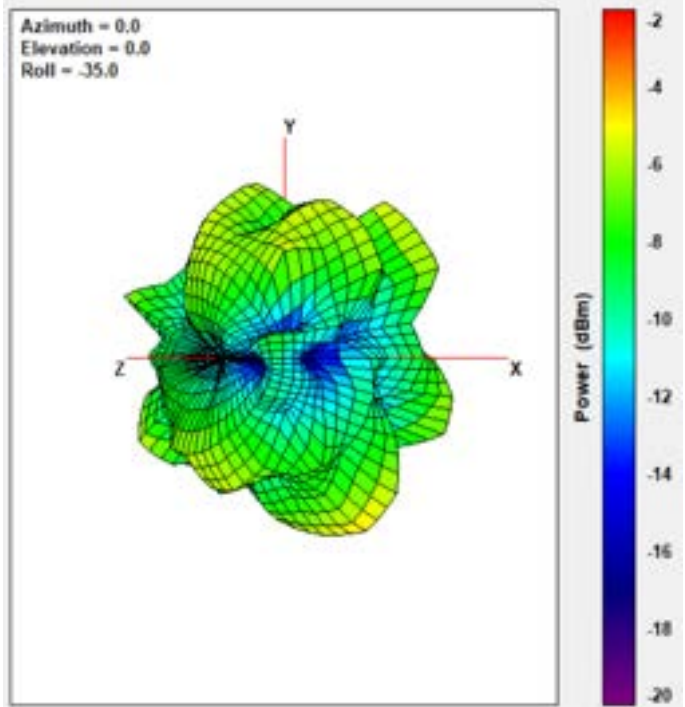

XY Plane

XZ Plane

YZ Plane

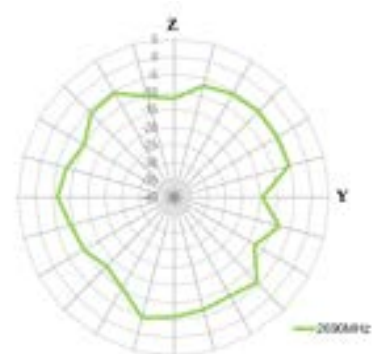
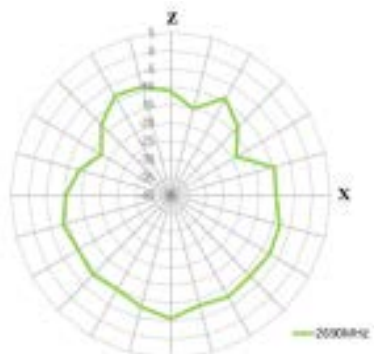
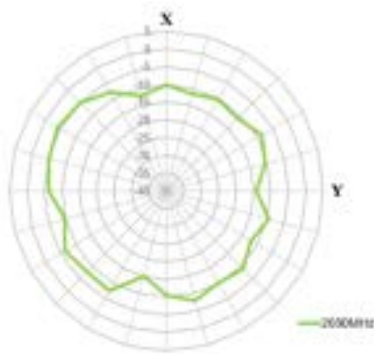

5.3 705MHz – LTE 2mm ABS Groundplane 2D & 3D Radiation Patterns

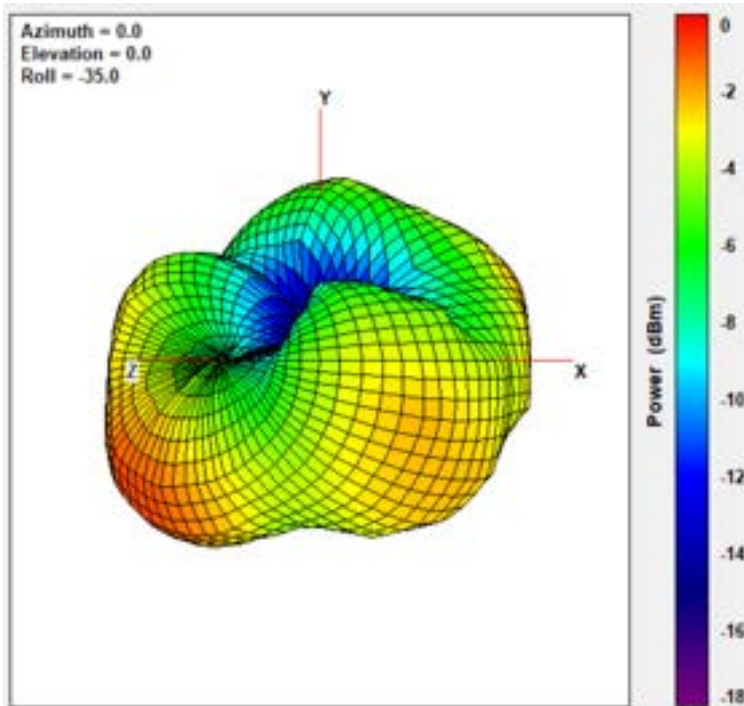

XY Plane

XZ Plane

YZ Plane

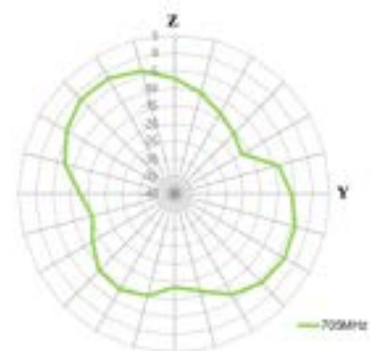
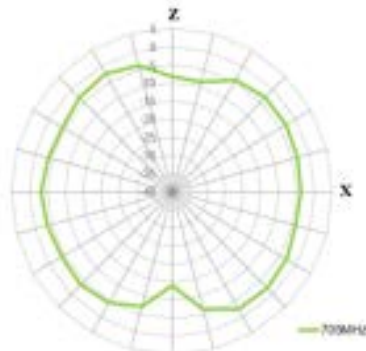
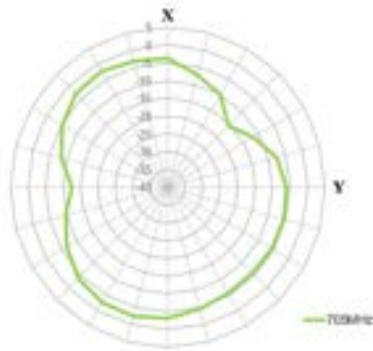

750MHz

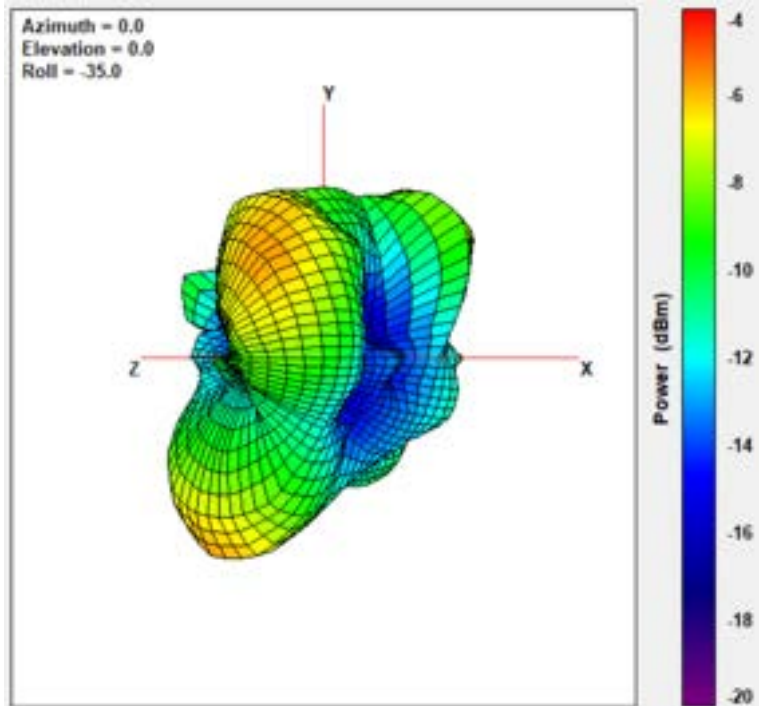

XY Plane

XZ Plane

YZ Plane

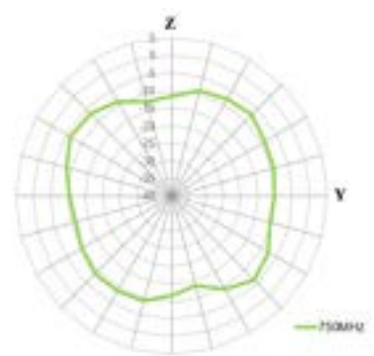
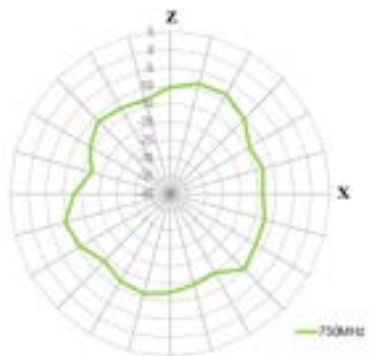
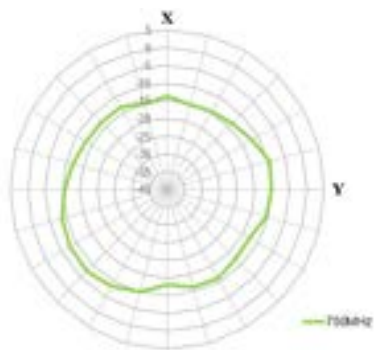

825MHz

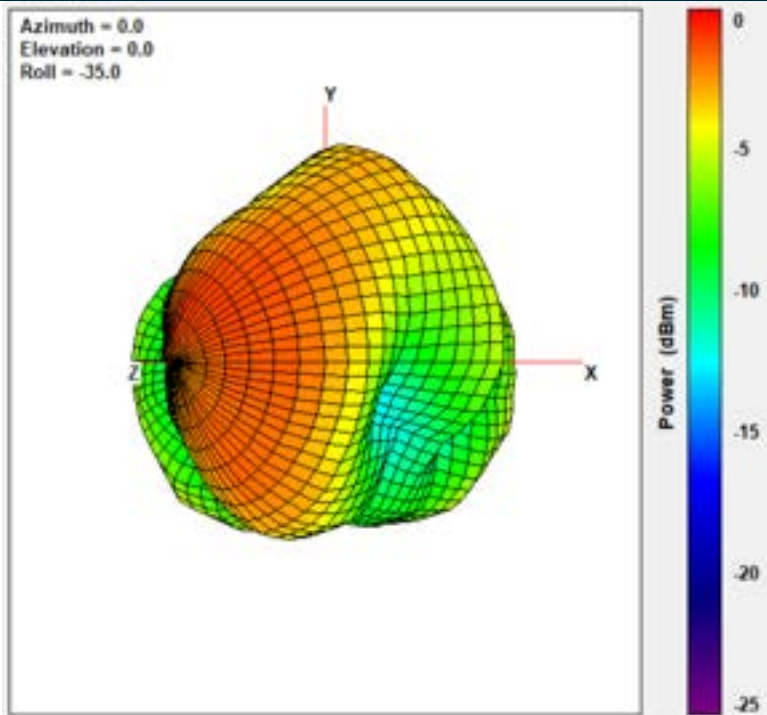

XY Plane

XZ Plane

YZ Plane

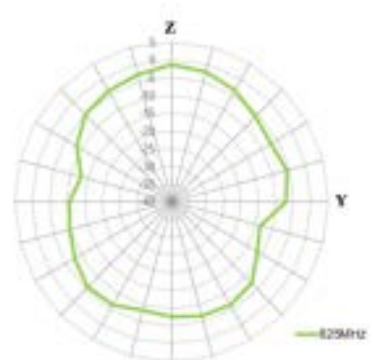
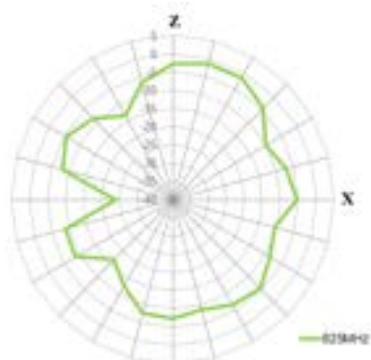
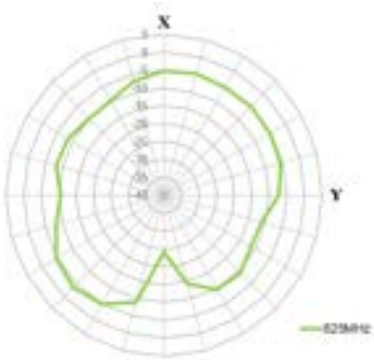

880MHz

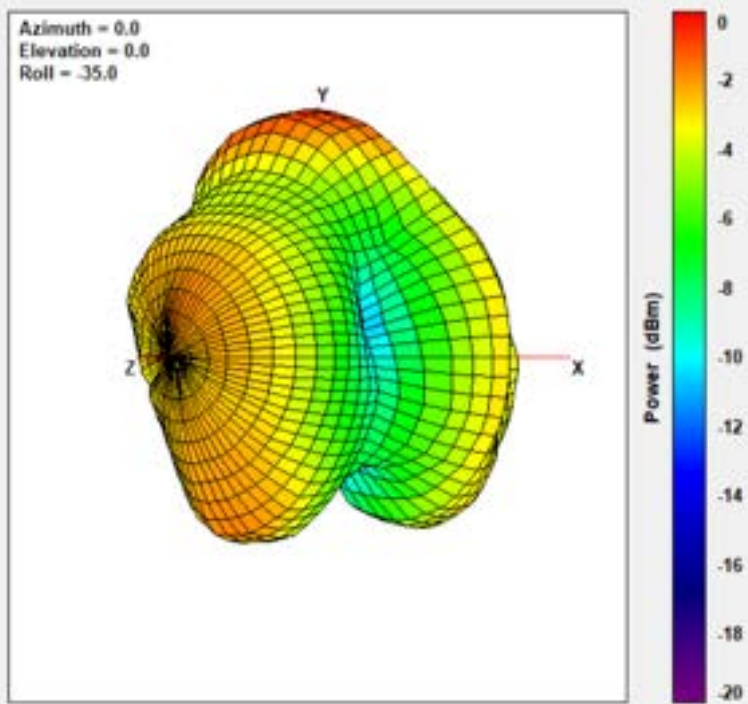

XY Plane

XZ Plane

YZ Plane

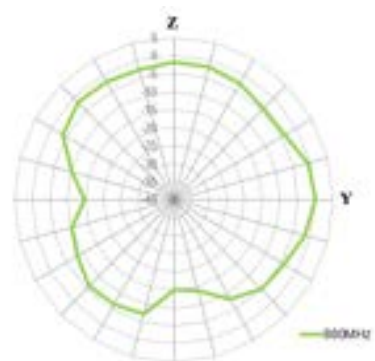
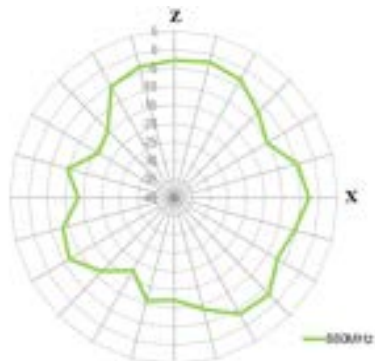
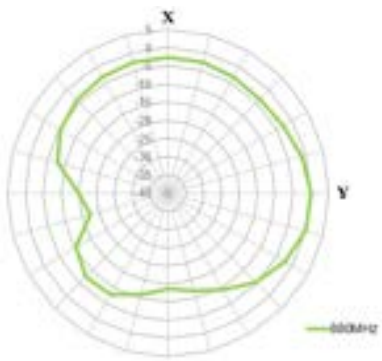

960MHz

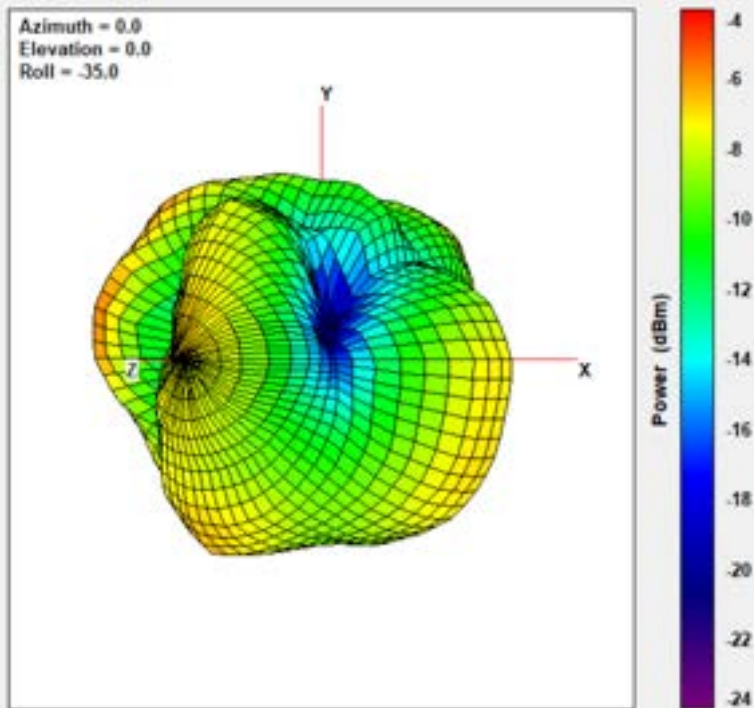

XY Plane

XZ Plane

YZ Plane

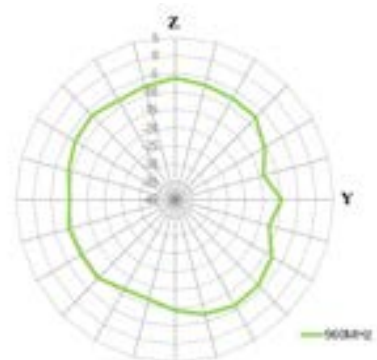
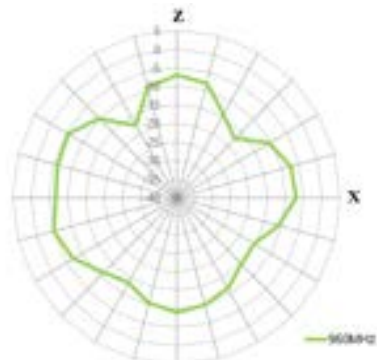
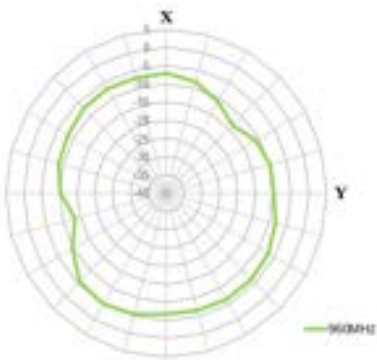

1710MHz

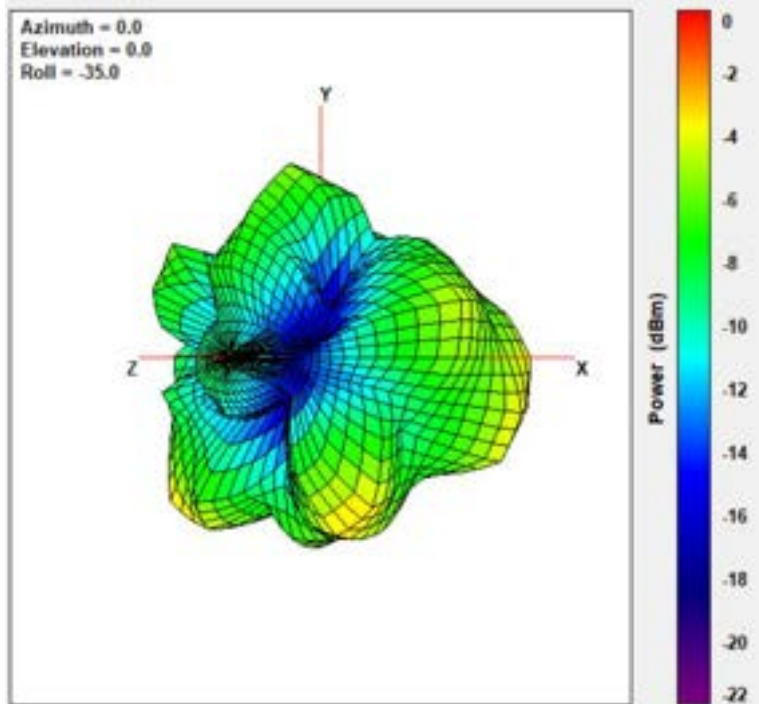

XY Plane

XZ Plane

YZ Plane

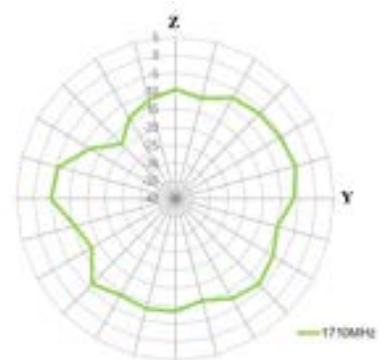
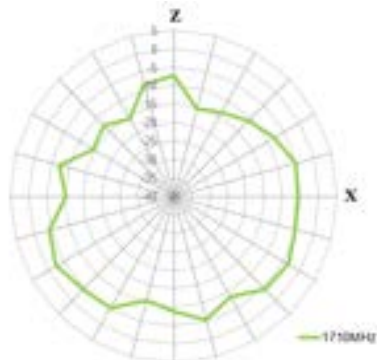
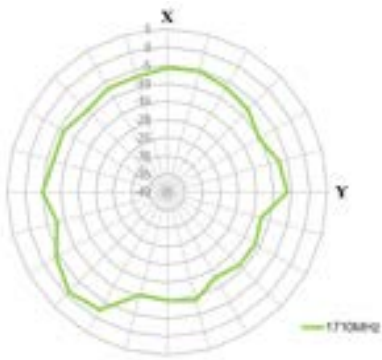

1800MHz

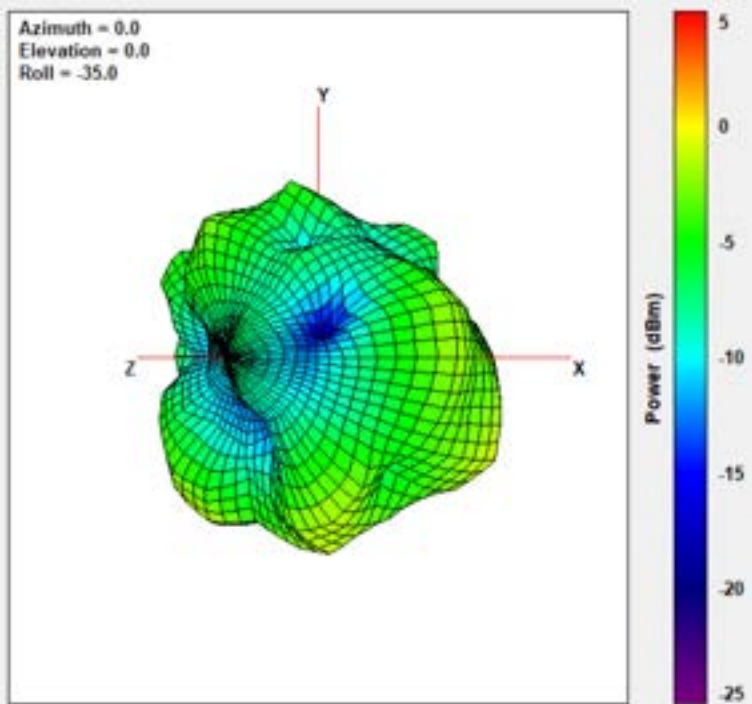

XY Plane

XZ Plane

YZ Plane

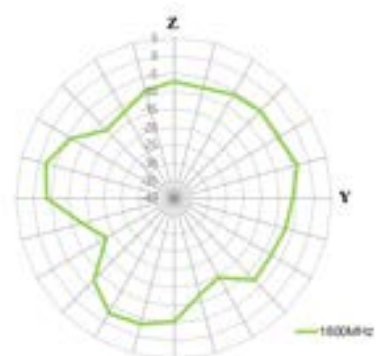
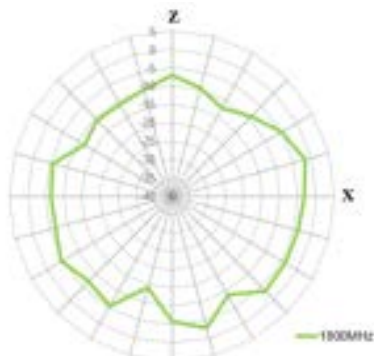
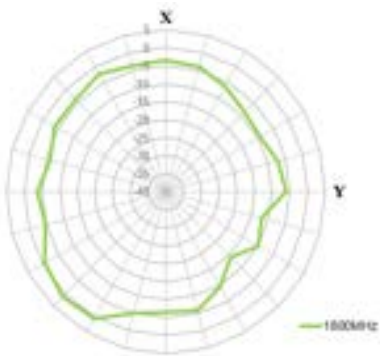

1990MHz

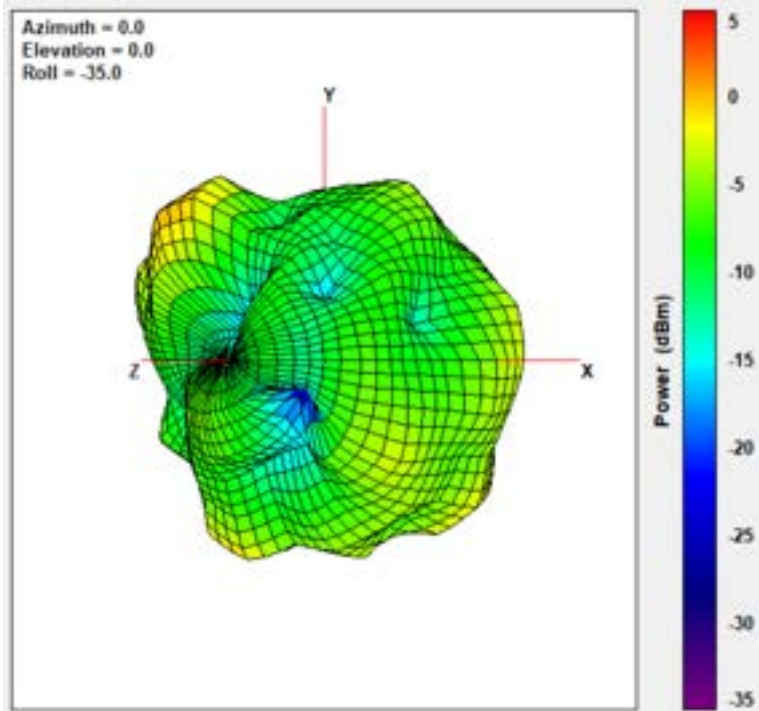

XY Plane

XZ Plane

YZ Plane

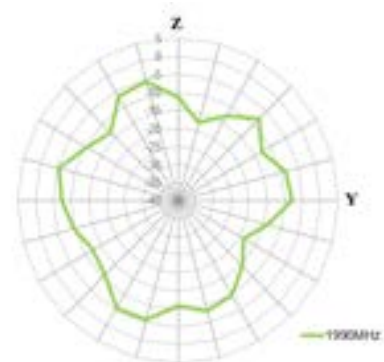
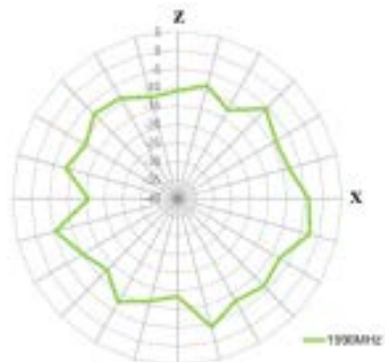
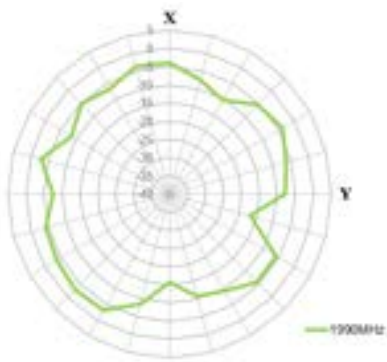

2170MHz

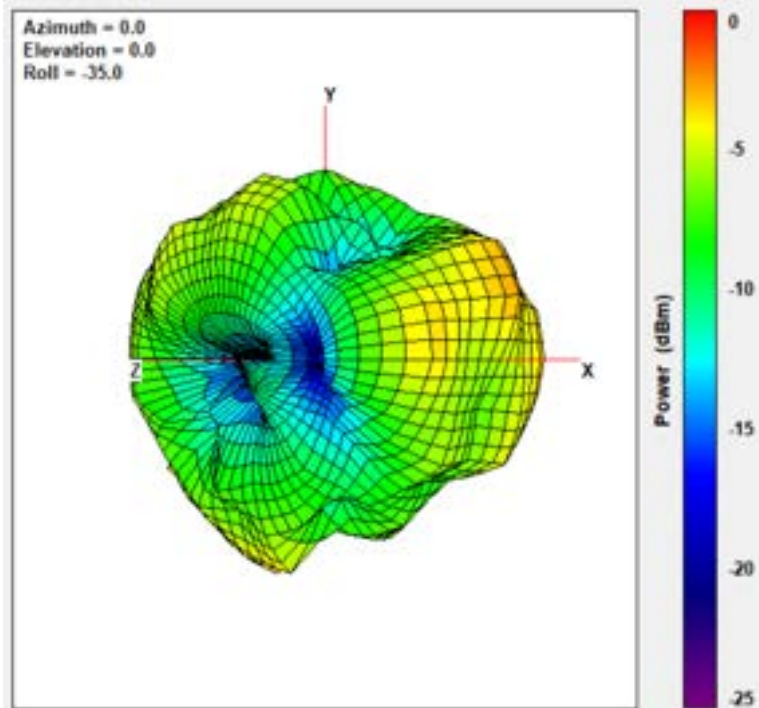

XY Plane

XZ Plane

YZ Plane

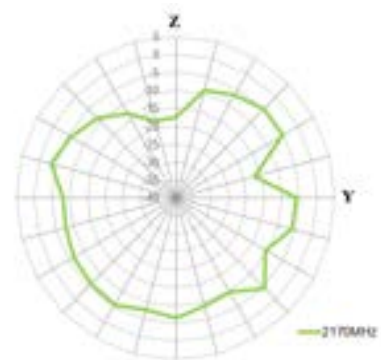
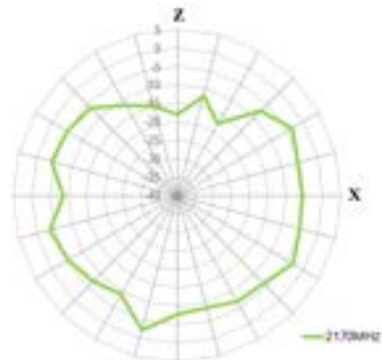
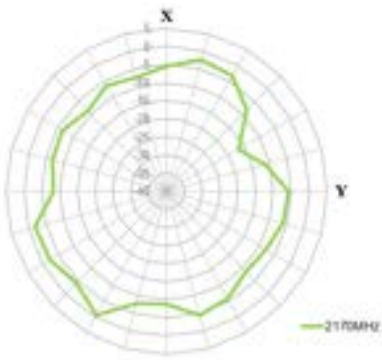

2400MHz

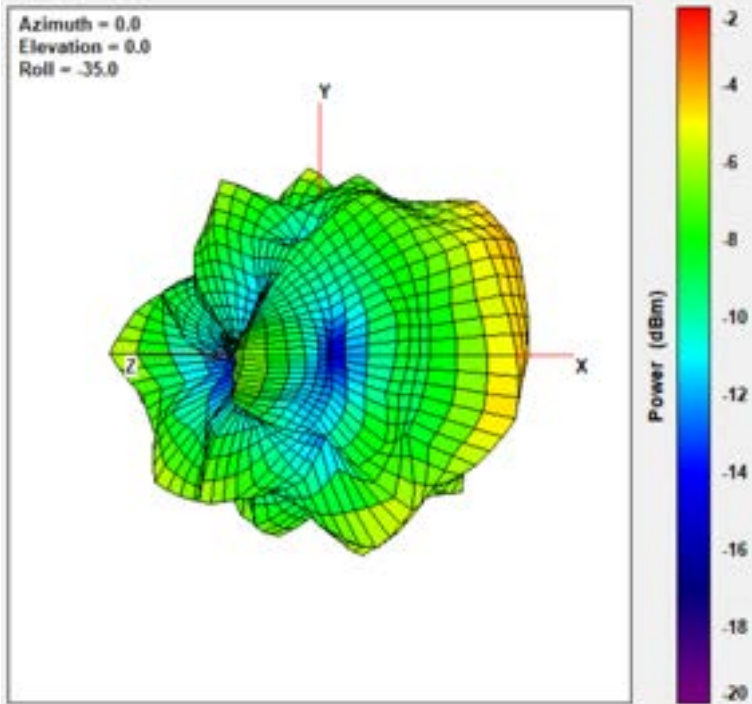

XY Plane

XZ Plane

YZ Plane

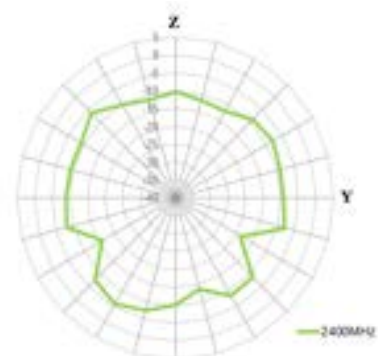
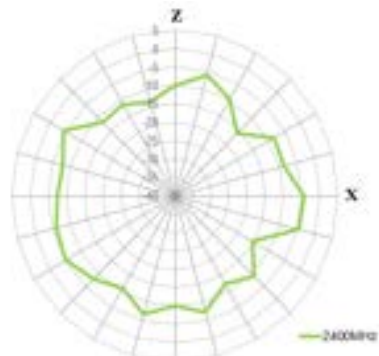
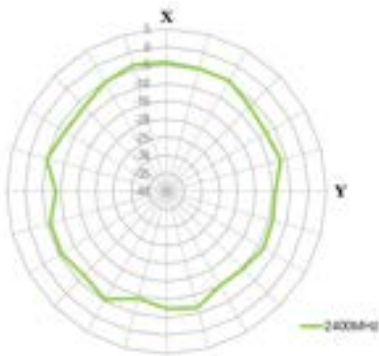

2500MHz

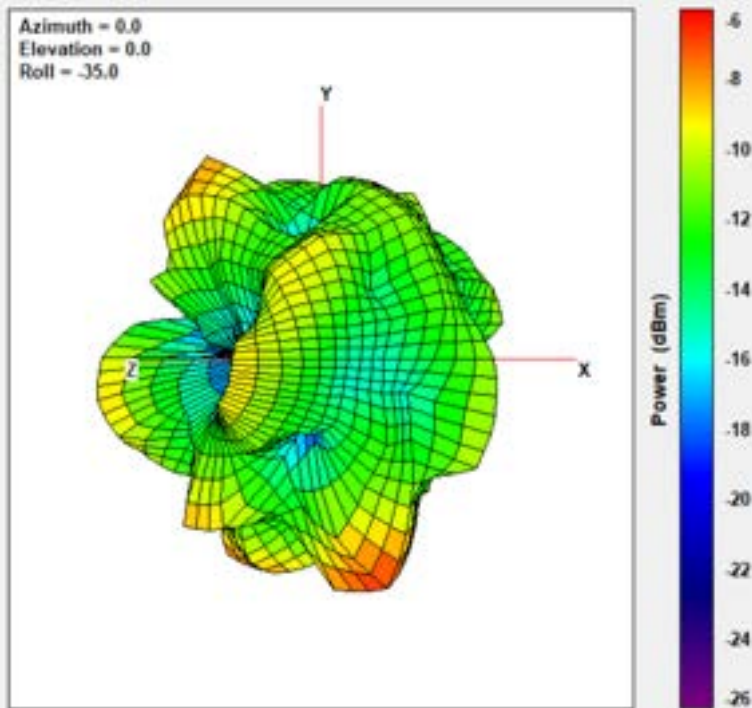

XY Plane

XZ Plane

YZ Plane

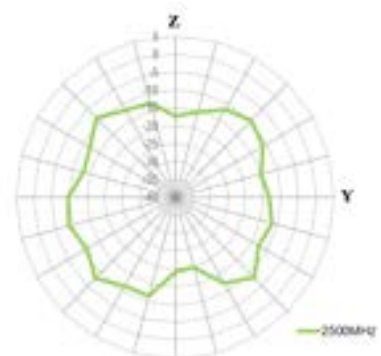
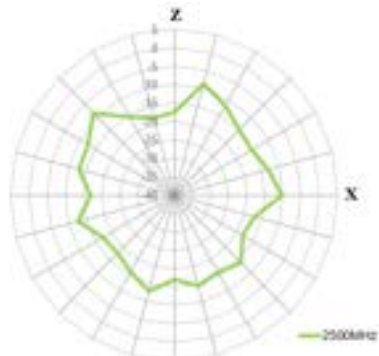
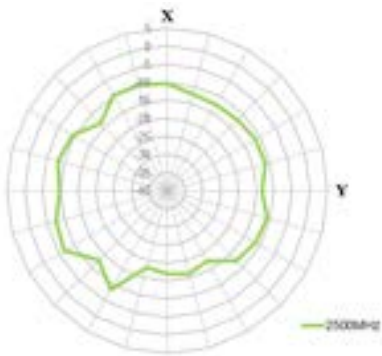

2570MHz

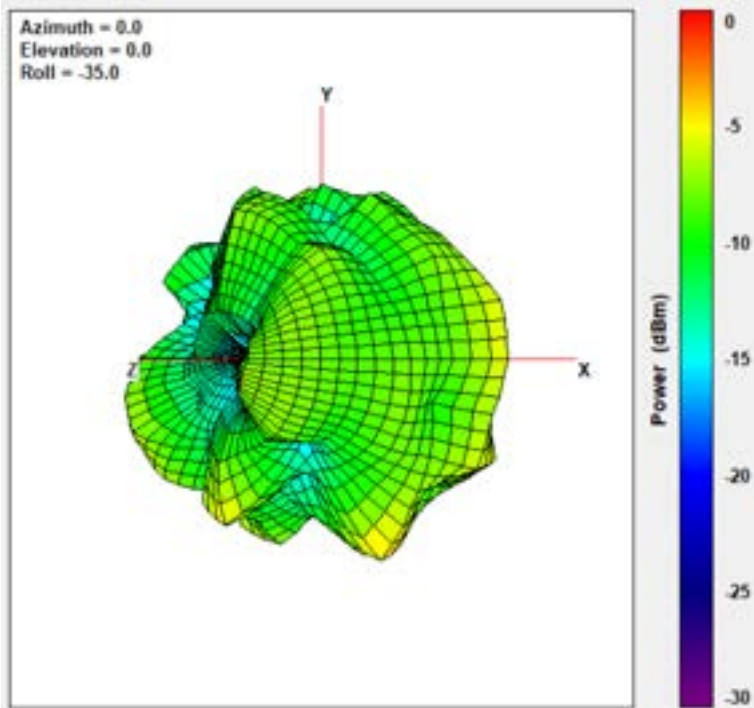

XY Plane

XZ Plane

YZ Plane

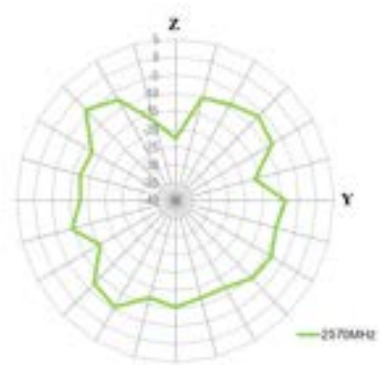
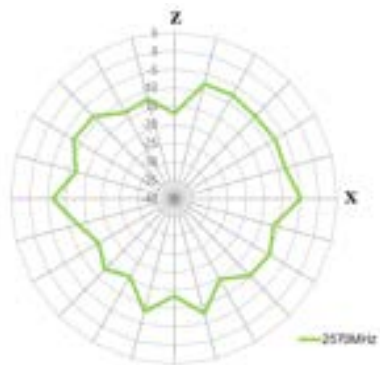
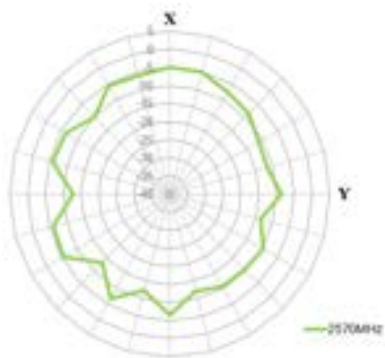

2690MHz

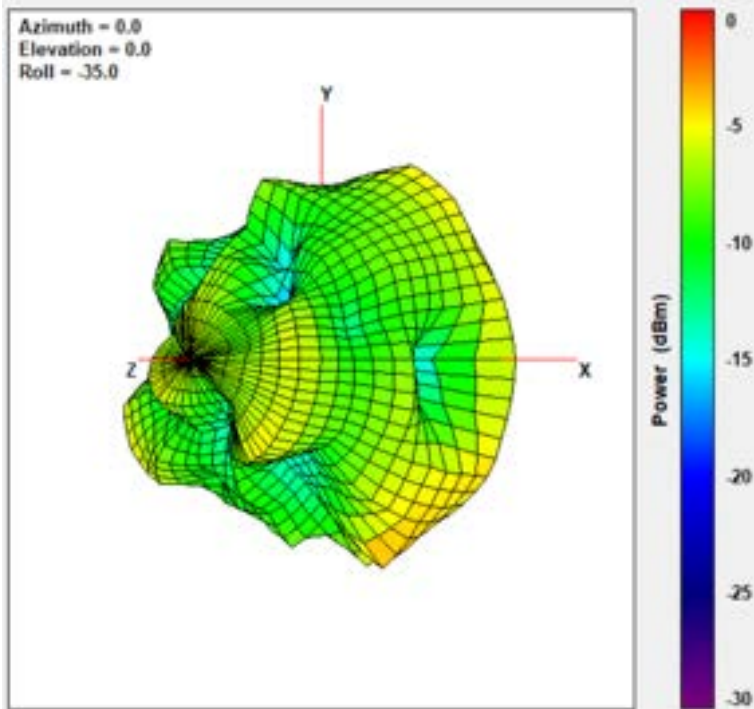

XY Plane

XZ Plane

YZ Plane

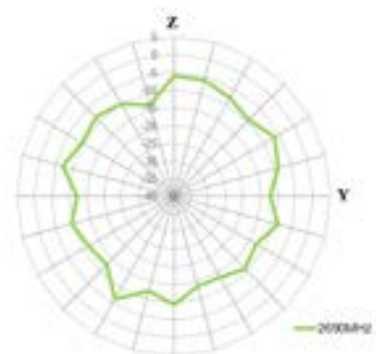
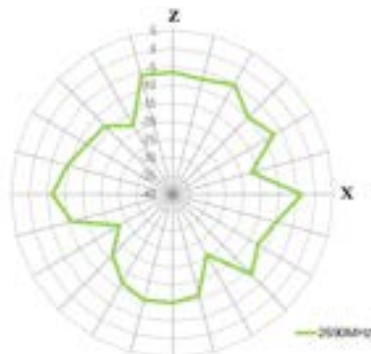
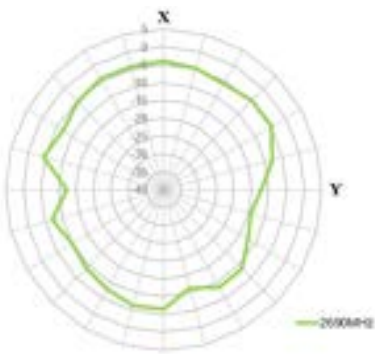

5.4 705MHz – LTE 12x12cm Glass Groundplane 2D & 3D Radiation Patterns

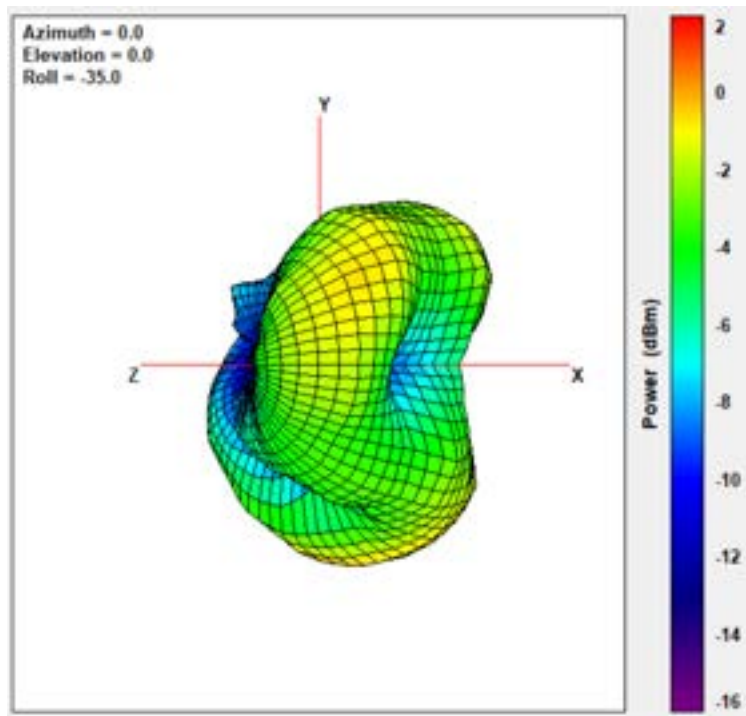

XY Plane XZ Plane YZ Plane

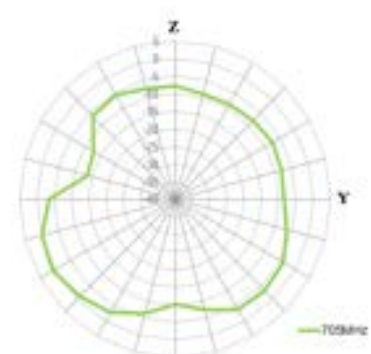
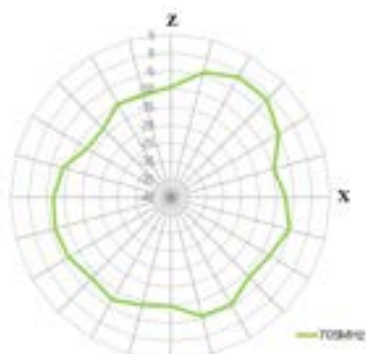
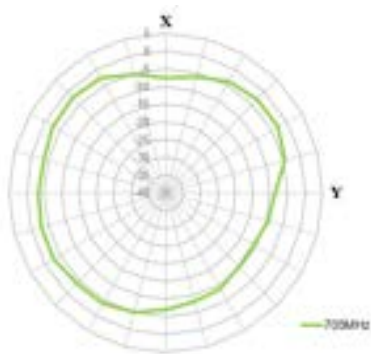

750MHz

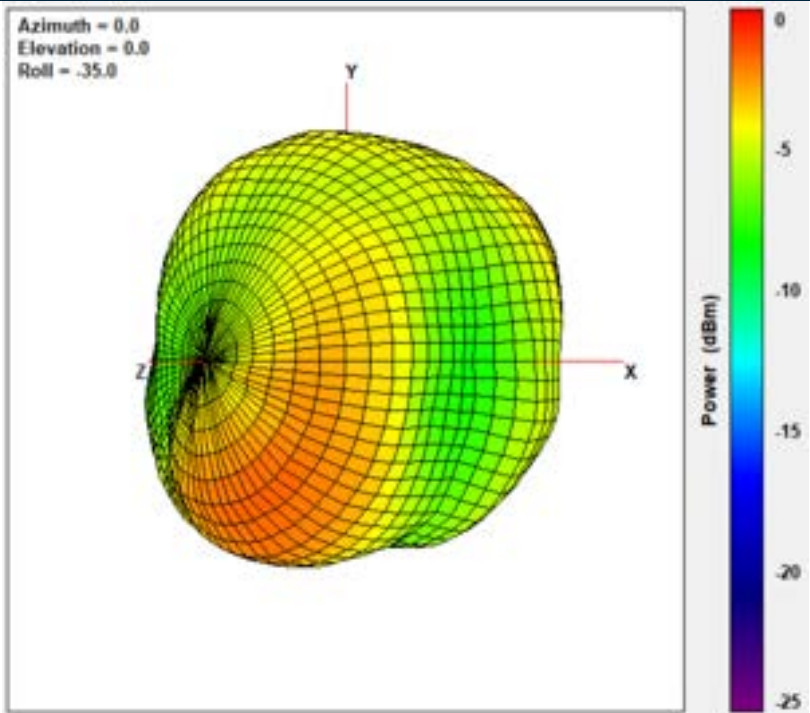

XY Plane

XZ Plane

YZ Plane

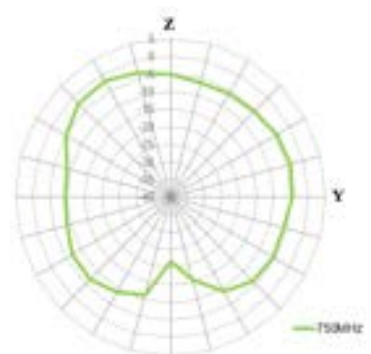
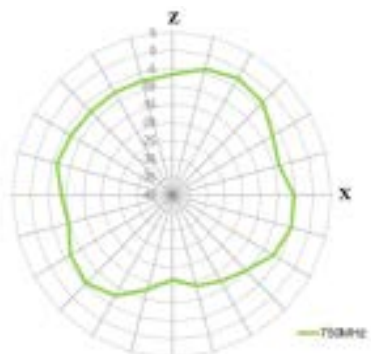
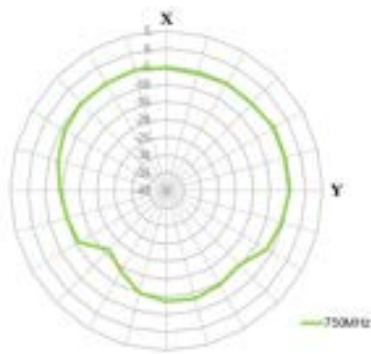

825MHz

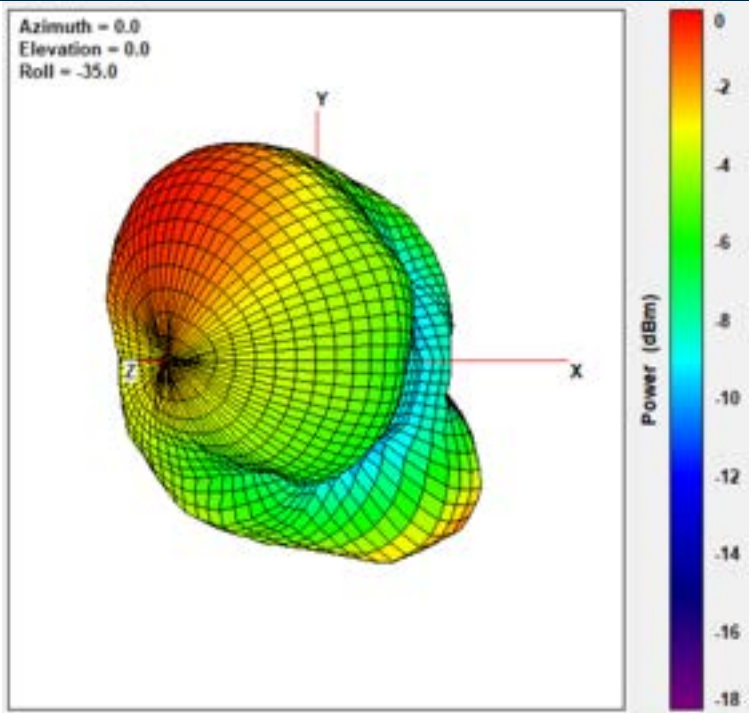

XY Plane

XZ Plane

YZ Plane

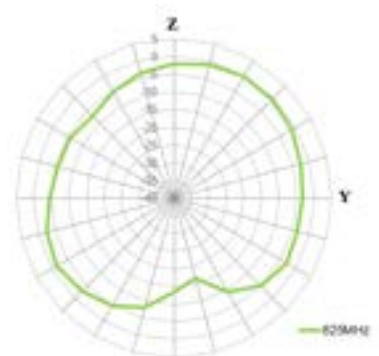
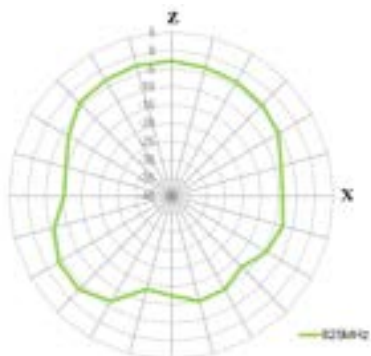
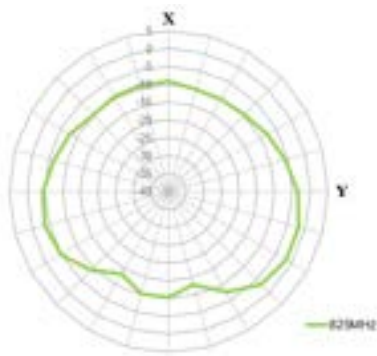

880MHz

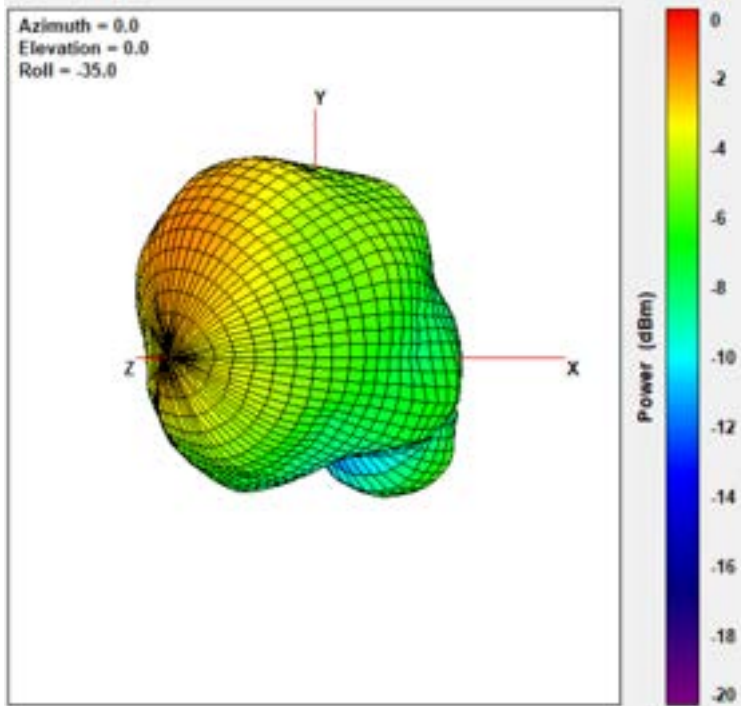

XY Plane

XZ Plane

YZ Plane

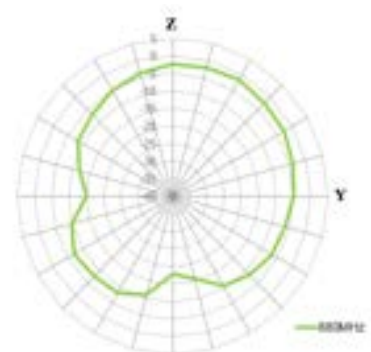
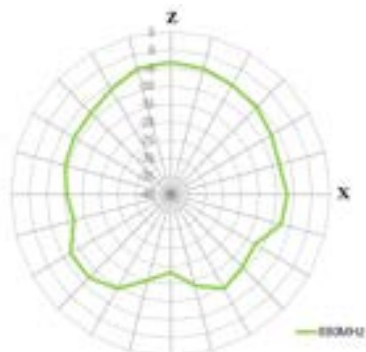
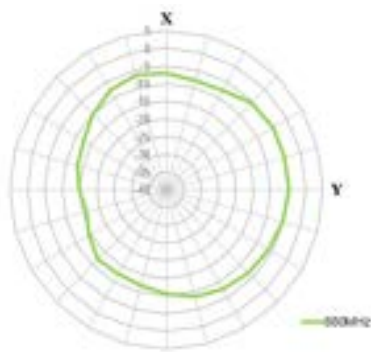

960MHz

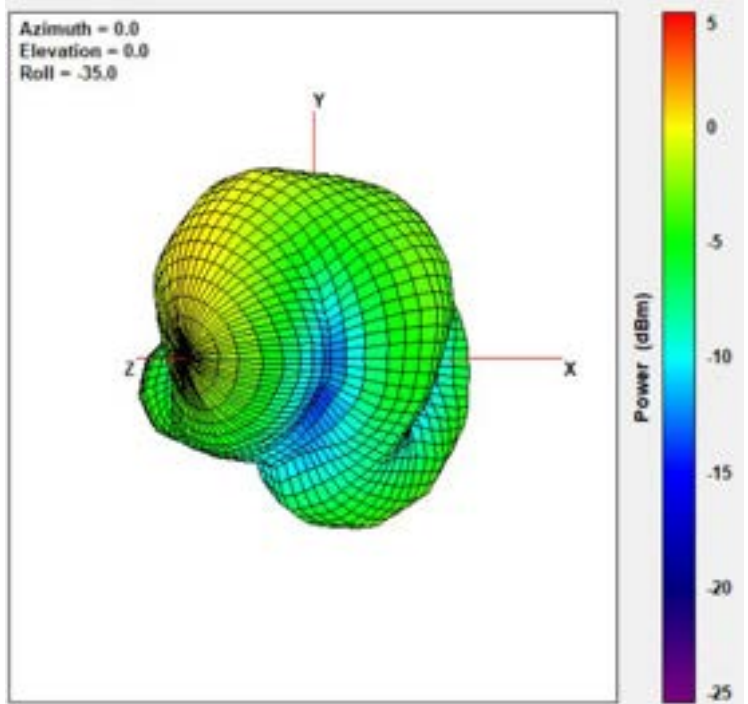

XY Plane

XZ Plane

YZ Plane

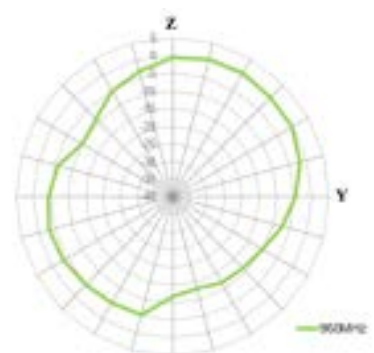
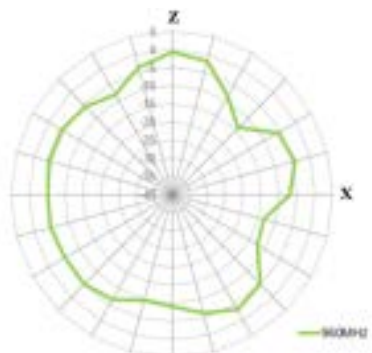
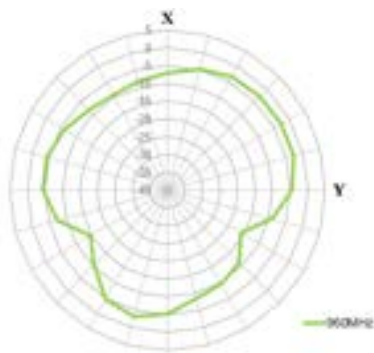

1710MHz

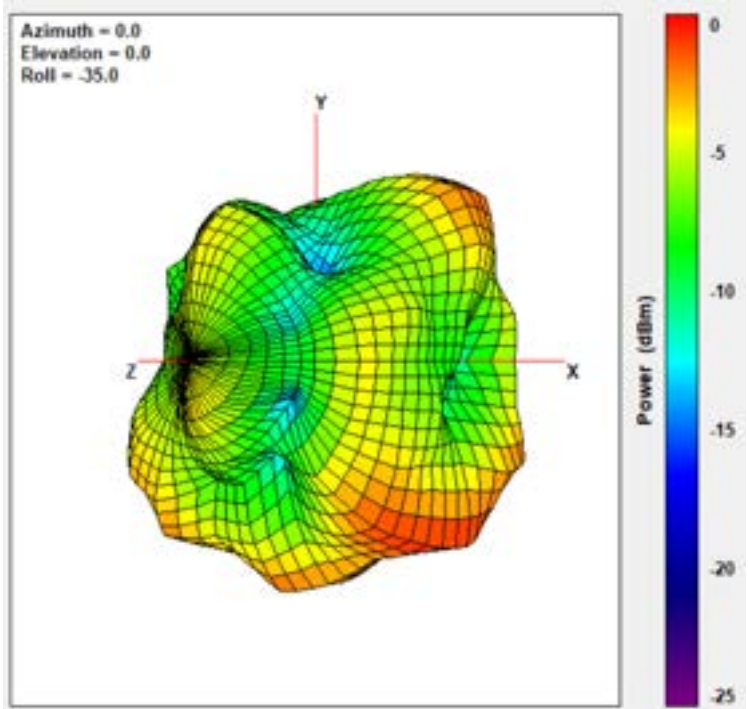

XY Plane

XZ Plane

YZ Plane

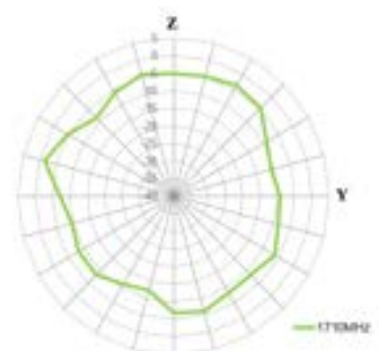
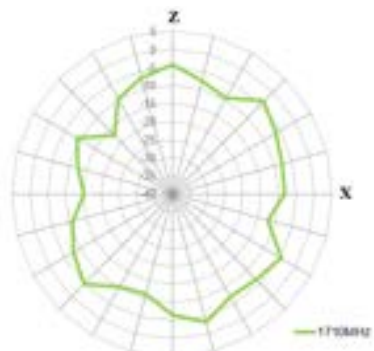

1800MHz

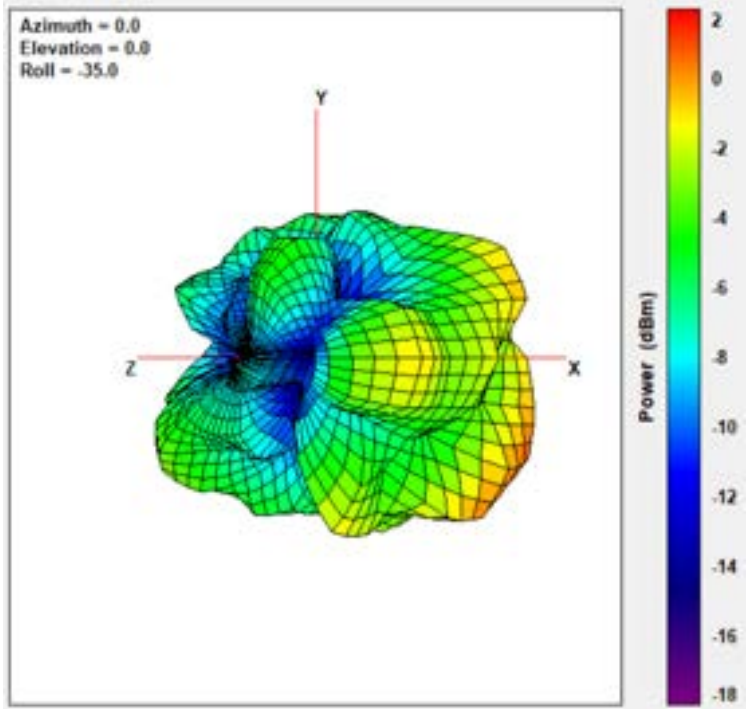

XY Plane

XZ Plane

YZ Plane

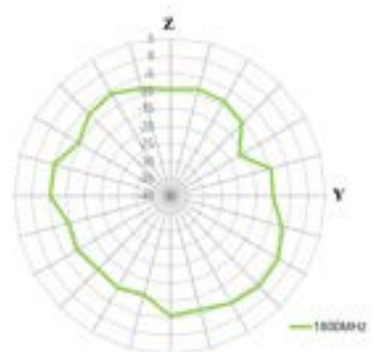
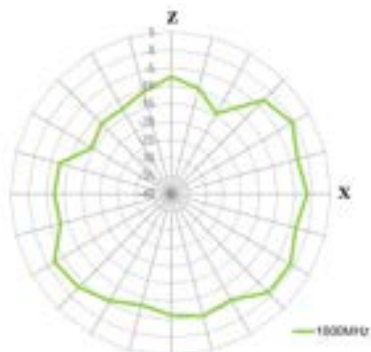
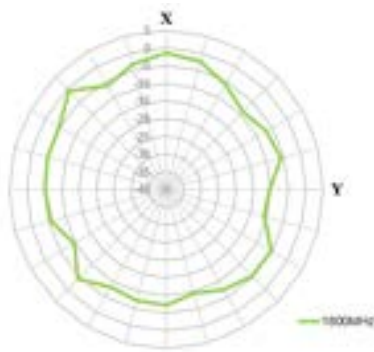

1990MHz

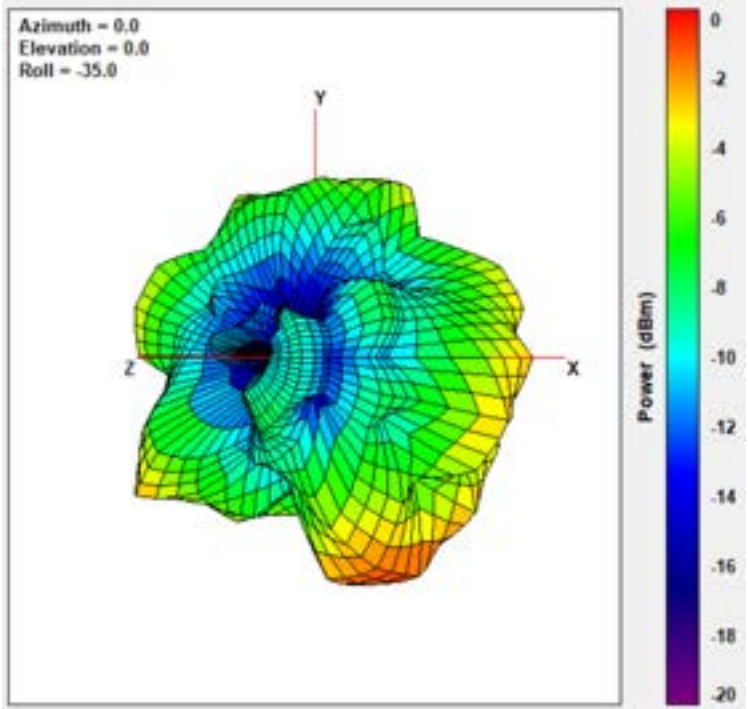

XY Plane

XZ Plane

YZ Plane

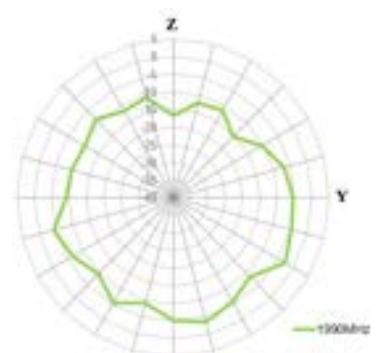
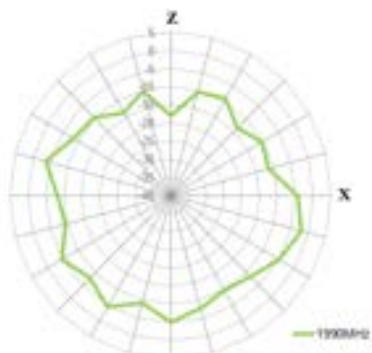
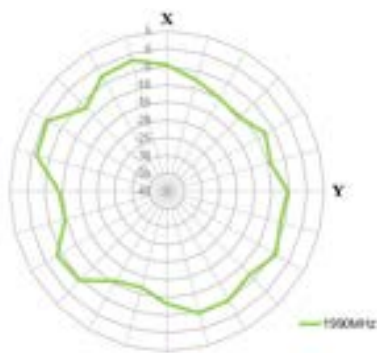

2170MHz

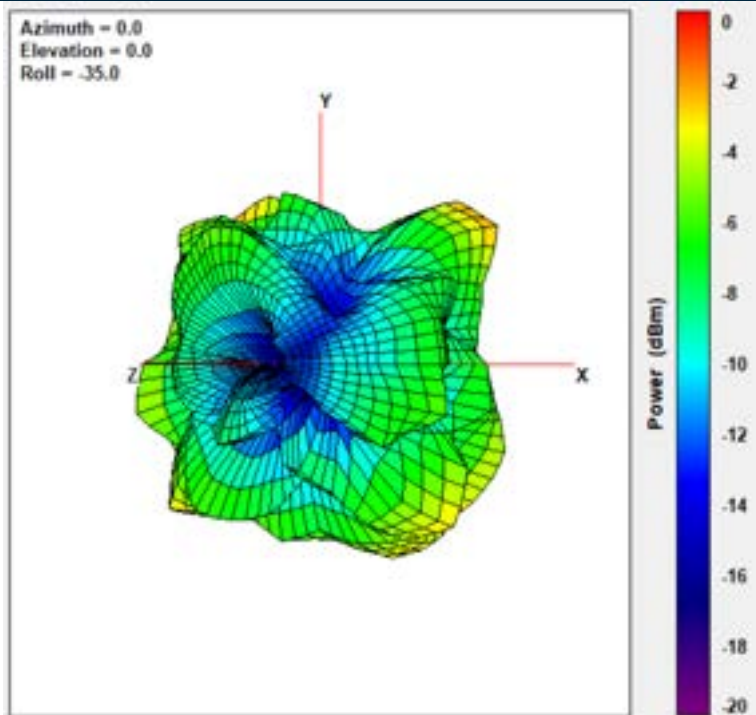

XY Plane

XZ Plane

YZ Plane

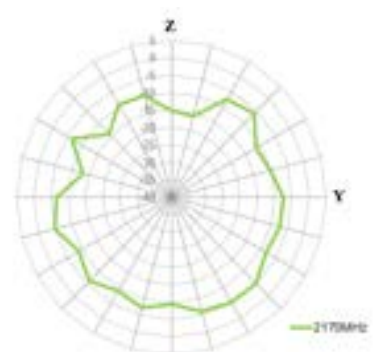
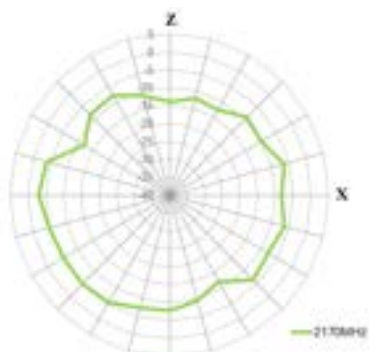
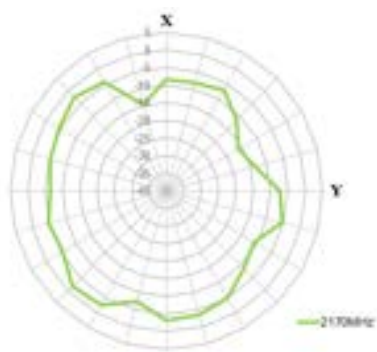

2400MHz

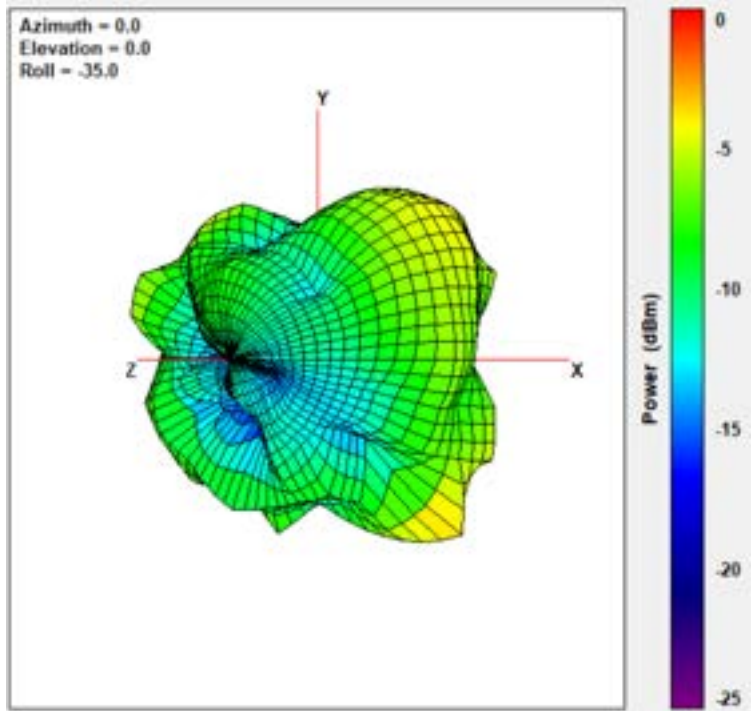

XY Plane

XZ Plane

YZ Plane

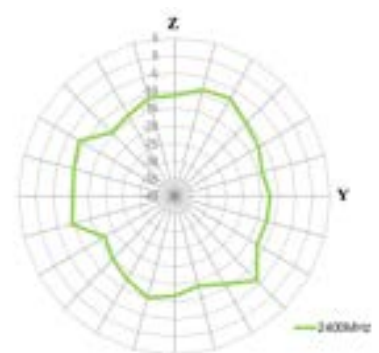
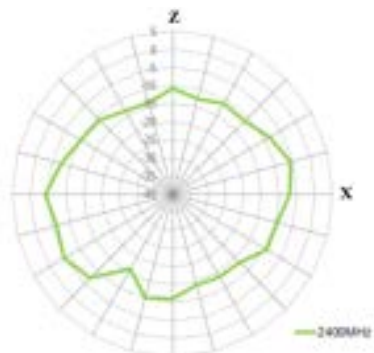
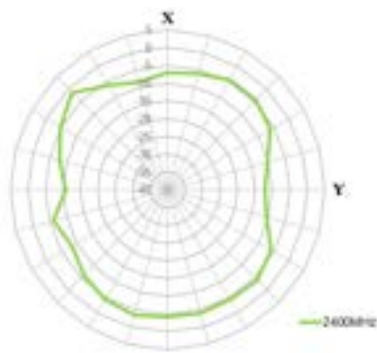

2500MHz

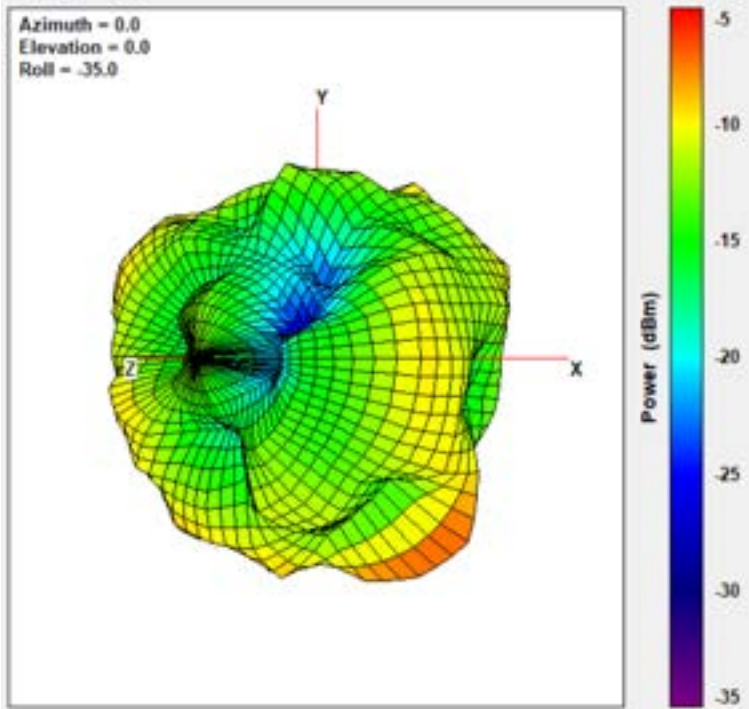

XY Plane

XZ Plane

YZ Plane

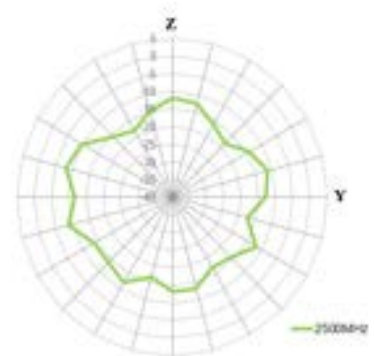
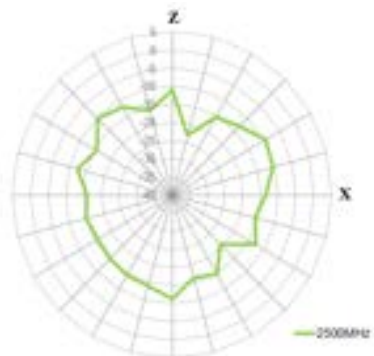
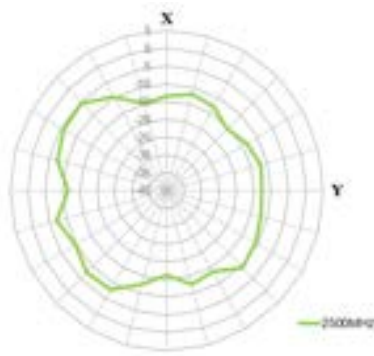

2570MHz

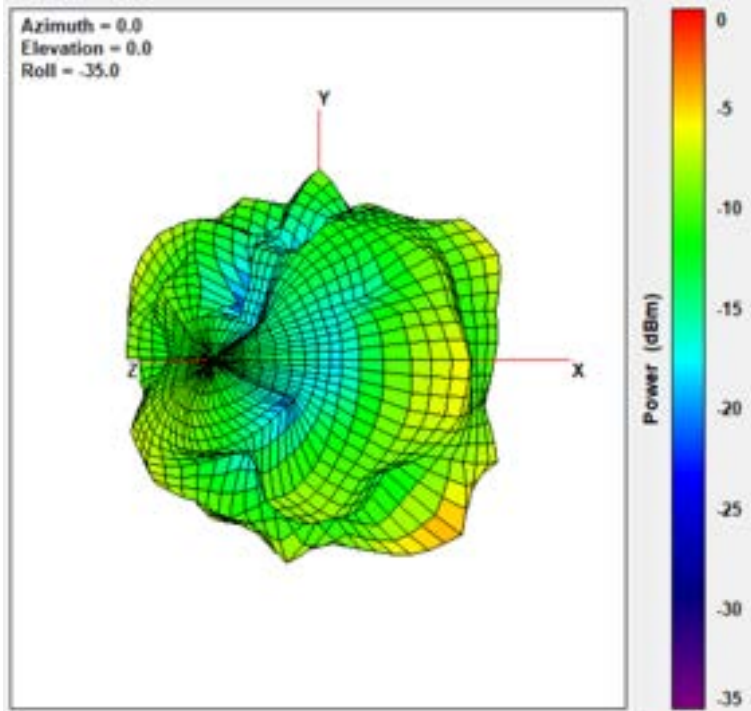

XY Plane

XZ Plane

YZ Plane

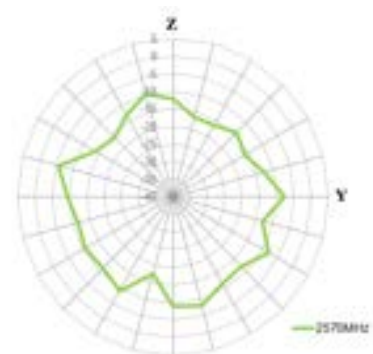
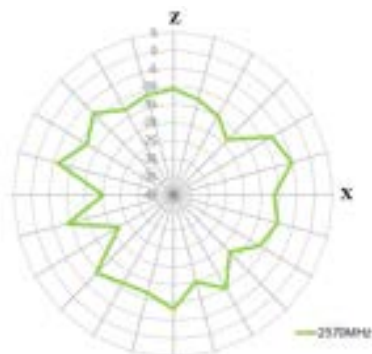
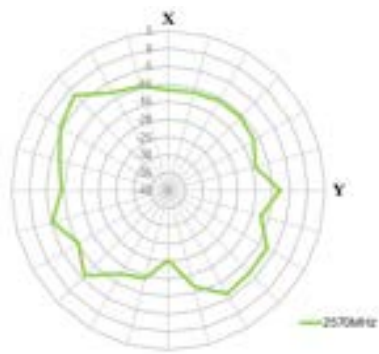

2690MHz

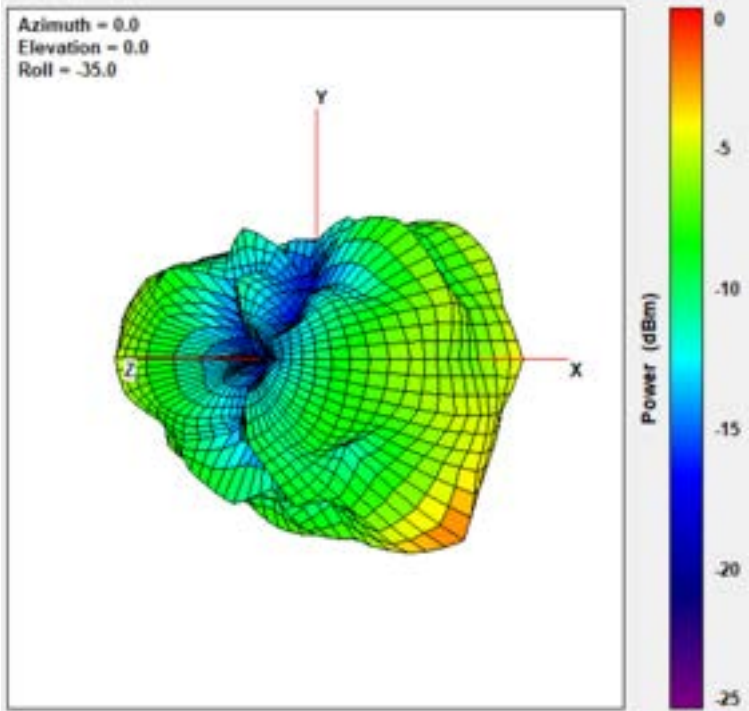

XY Plane

XZ Plane

YZ Plane

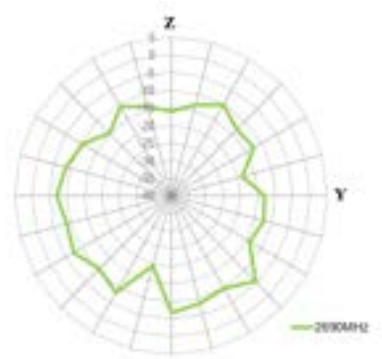
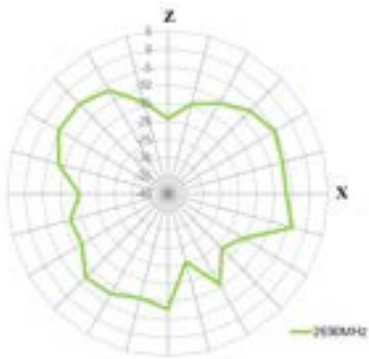
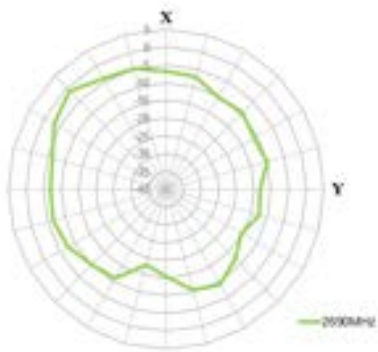

6. Radiation Patterns - GNSS

6.1 Test Setup

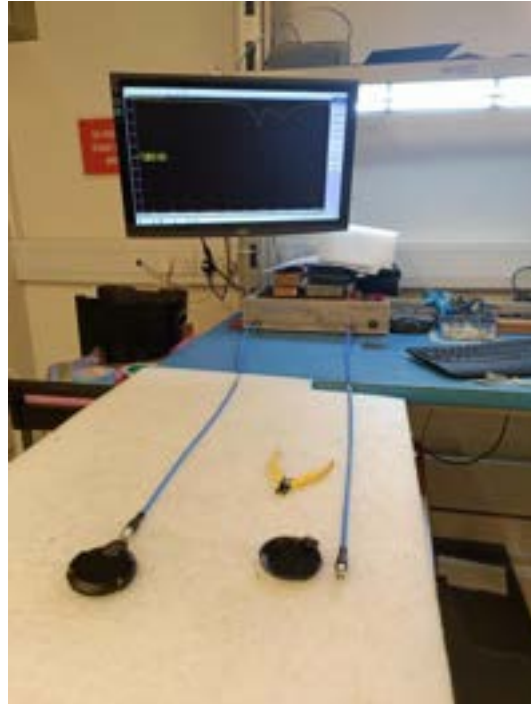

Free space

6.1 1575MHz – GNSS Freespace2D & 3D Radiation Patterns

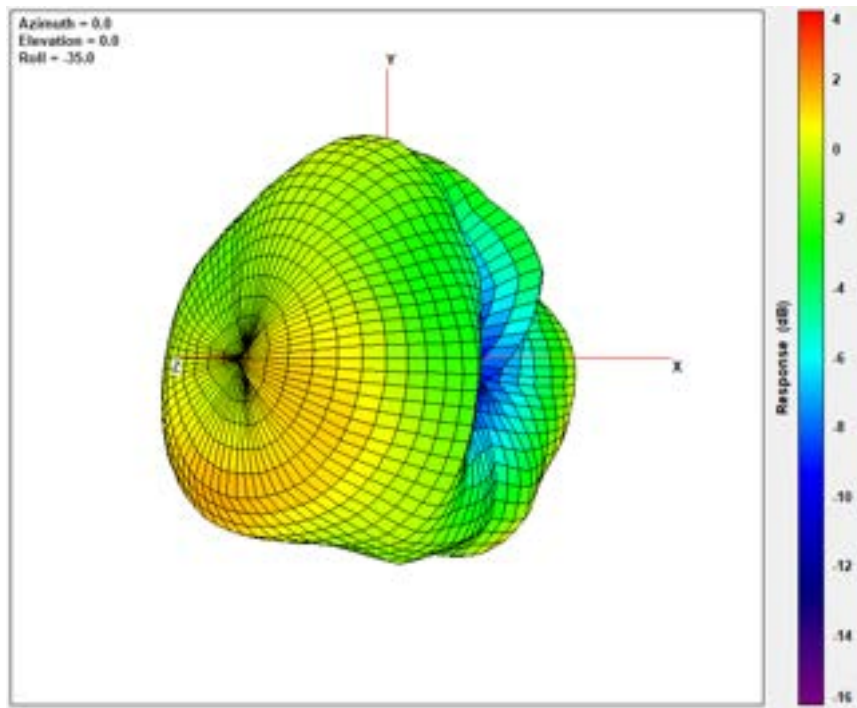

XY Plane

XZ Plane

YZ Plane

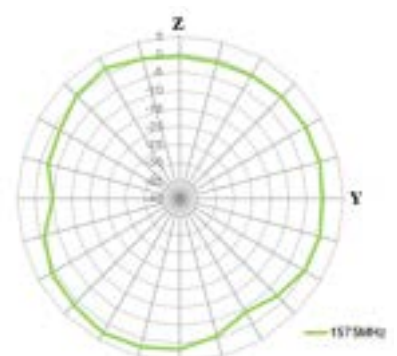
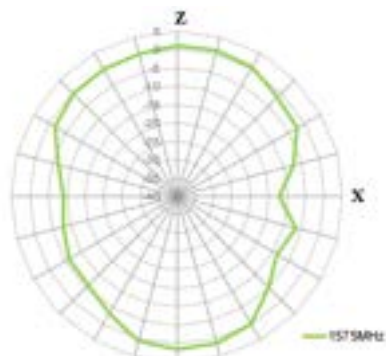
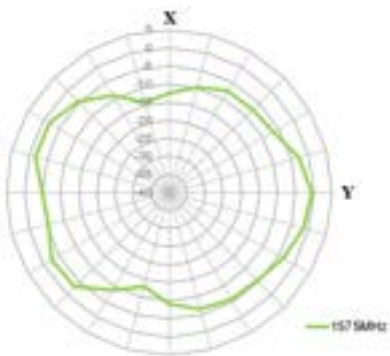

1602MHz

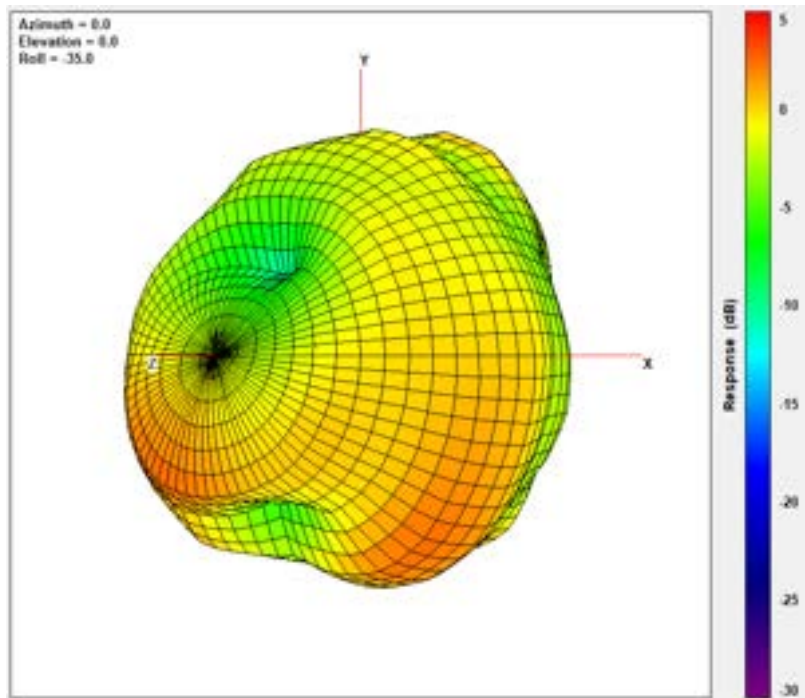

XY Plane

XZ Plane

YZ Plane

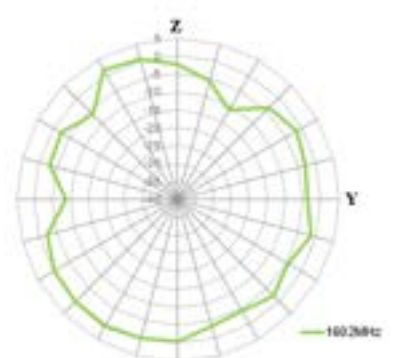
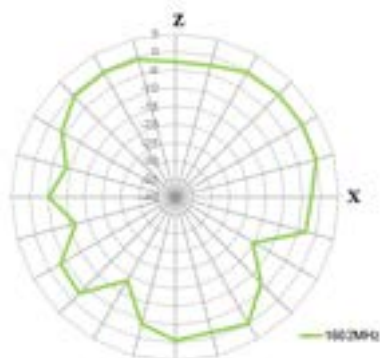
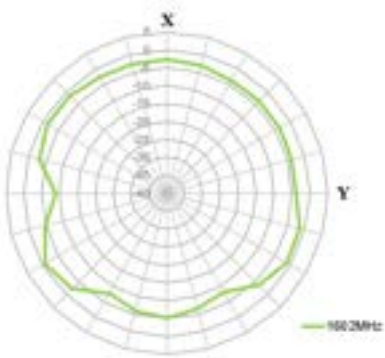

7. Mechanical Drawing (Units: mm)

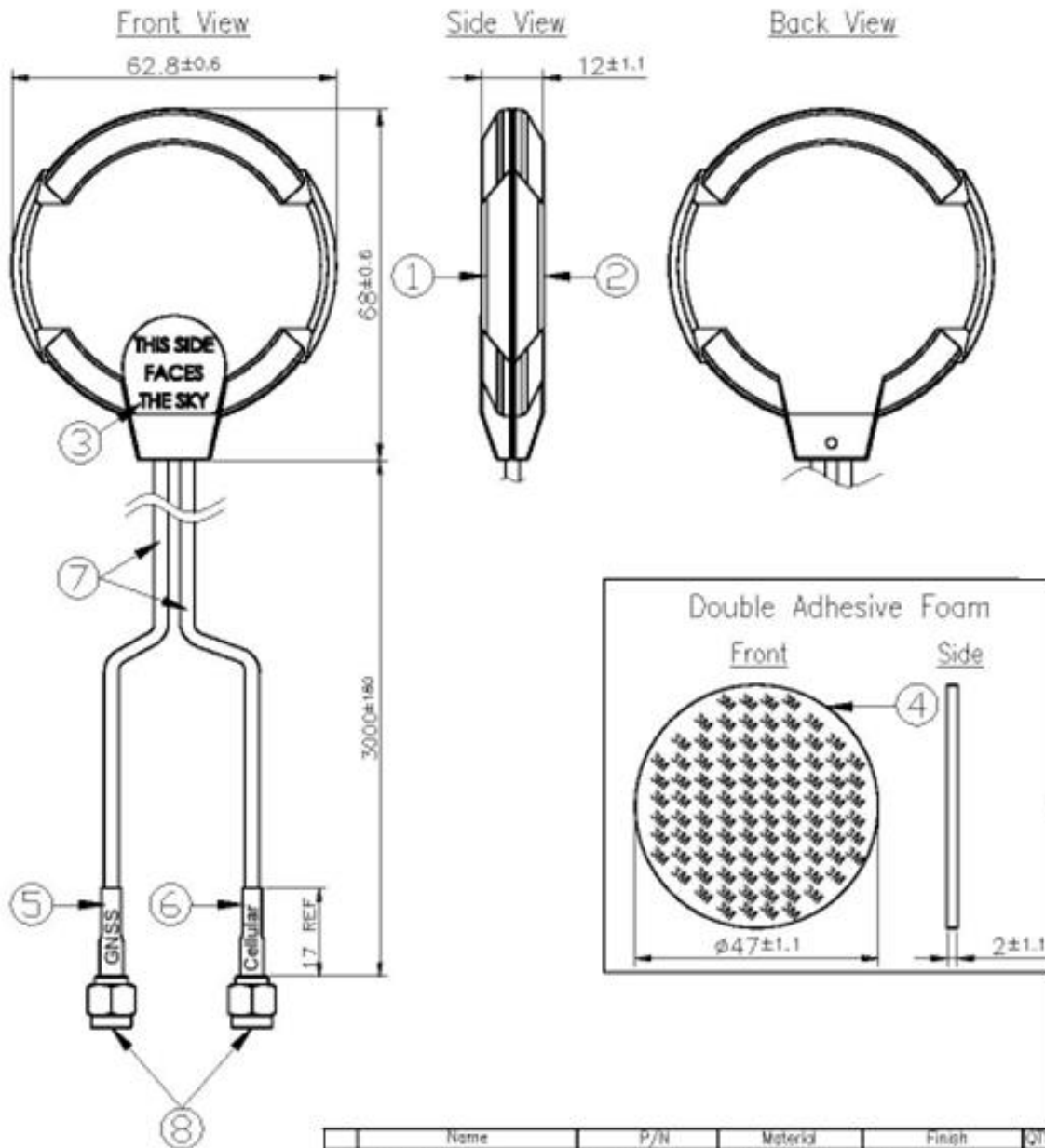

	Name	P/N	Material	Finish	QTY
1	Housing Top	000113ED00066A	PC+ABS	Black	1
2	Housing Bottom	000113ED10066A	PC+ABS	Black	1
3	Clear Label	001013ED00051A	PET	White	1
4	Double Adhesive Black Foam	001013ED00039A	3M 9448HK+CR4305	White Liner	1
5	Heat Shrink Tube (GNSS)	001316C000000A	PE	Blue Tube/White Text	1
6	Heat Shrink Tube (Cellular)	001316D100000A	PE	Blue Tube/White Text	1
7	RG174 Coaxial Cable	301315C000000A	PVC	Black	2
8	SMA/MIST	200216D000098A	Brass	Au Plated	2

Download Drawing

Download 3D Model

8. Packaging

1 pcs MA220.LB.001 per PE Bag
 Bag Dimensions - 600 x 450 mm
 Weight - 1200g

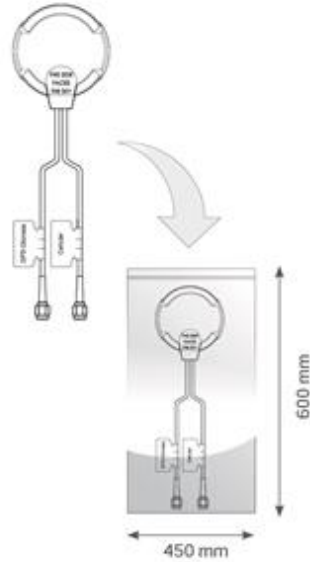

100 pcs MA220.LB.001 per carton
 Carton - 730 x 390 x 250mm
 Weight - 13.7Kg

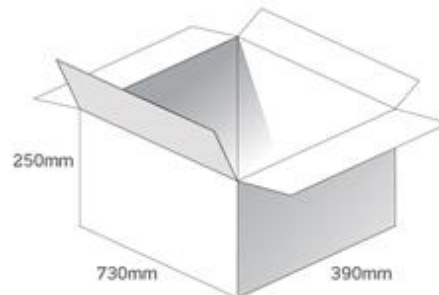

Pallet Dimensions 1200 x 1000 x 1450mm
 12 Cartons per Pallet
 4 Cartons per layer
 5 Layers

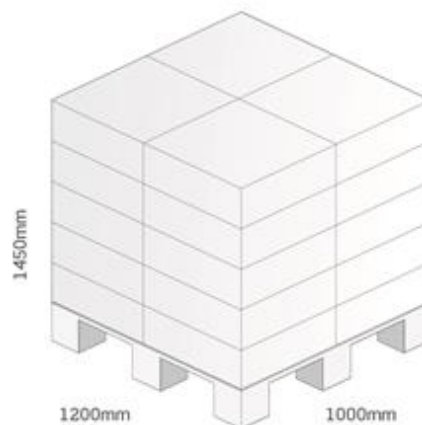

Changelog for the datasheet

SPE-14-8-016-G – MA220.LB.001

Revision: G (Current Version)

Date:	2022-07-28
Changes:	Full Datasheet update
Changes Made by:	Evan Murphy

Previous Revisions

Revision: F

Date:	2019-02-05
Changes:	
Changes Made by:	Jack Conroy

Revision: A (Original First Release)

Date:	2014-02-27
Notes:	
Author:	Technical Writer

Revision: E

Date:	2018-11-29
Changes:	
Changes Made by:	Technical Writer

Revision: D

Date:	2017-06-19
Changes:	
Changes Made by:	Technical Writer

Revision: C

Date:	2017-06-19
Changes:	
Changes Made by:	Technical Writer

Revision: B

Date:	2014-08-19
Changes:	
Changes Made by:	Technical Writer

Previous Revisions (Continued)



TAOGLAS®

www.taoglas.com

