



RF TEST REPORT

Applicant Quectel Wireless Solutions Co., Ltd.

FCC ID XMR201707BG96

Product LTE Cat M1 & Cat NB1 & EGPRS Module

Brand Quectel

Model BG96, BG96 MINIPCIE

Marketing Quectel BG96, Quectel BG96 MINIPCIE

Report No. R1811A0536-R6

Issue Date February 26, 2019

TA Technology (Shanghai) Co., Ltd. tested the above equipment in accordance with the requirements in **FCC CFR47 Part 2 (2018)/ FCC CFR47 Part 27C (2018)**. The test results show that the equipment tested is capable of demonstrating compliance with the requirements as documented in this report.

Performed by: Peng Tao

Approved by: Kai Xu

TA Technology (Shanghai) Co., Ltd.

No.145, Jintang Rd, Tangzhen Industry Park, Pudong Shanghai, China

TEL: +86-021-50791141/2/3

FAX: +86-021-50791141/2/3-8000

Table of Contents

1	Test Laboratory	4
1.1	Notes of the Test Report	4
1.2	Test facility	4
1.3	Testing Location	5
2	General Description of Equipment under Test	6
3	Applied Standards	7
4	Test Configuration	8
5	Test Case Results	9
5.1	RF Power Output	9
5.2	Effective Isotropic Radiated Power	11
5.3	Occupied Bandwidth	15
5.4	Band Edge Compliance	23
5.5	Peak-to-Average Power Ratio (PAPR)	29
5.6	Frequency Stability.....	31
5.7	Spurious Emissions at Antenna Terminals	34
5.8	Radiates Spurious Emission	39
6	Main Test Instruments	45
ANNEX A: EUT Appearance and Test Setup		46
A.1	EUT Appearance	46
A.2	Test Setup	48
ANNEX B: Product Change Description		49

Summary of Measurement Results

Number	Test Case	Clause in FCC rules	Verdict
1	RF power output	2.1046	PASS
2	Effective Isotropic Radiated power	27.50(b)(10) /27.50(c)(10)	PASS
3	Occupied Bandwidth	2.1049	PASS
4	Band Edge Compliance	27.53(g)	PASS
5	Peak-to-Average Power Ratio	27.50(d)/KDB971168 D01(5.7)	PASS
6	Frequency Stability	2.1055 / 27.54	PASS
7	Spurious Emissions at Antenna Terminals	2.1051 /27.53(g) /27.53(f)	PASS
8	Radiates Spurious Emission	2.1053 /27.53(g) /27.53(f)	PASS
Date of Testing: August 4, 2017 ~ August 18, 2017			
Note: PASS: The EUT complies with the essential requirements in the standard. FAIL: The EUT does not comply with the essential requirements in the standard.			

BG96, BG96 MINIPCIE (Report No: R1811A0536-R6) is a variant model of BG96 (Report No: RXA1706-0199RF07). Test values duplicated from Original for variant. There is no test for variant in this report. The detailed product change description please refers to the ANNEX B.

1 Test Laboratory

1.1 Notes of the Test Report

This report shall not be reproduced in full or partial, without the written approval of **TA technology (shanghai) co., Ltd.** The results documented in this report apply only to the tested sample, under the conditions and modes of operation as described herein .Measurement Uncertainties were not taken into account and are published for informational purposes only. This report is written to support regulatory compliance of the applicable standards stated above. This report must not be used by the client to claim product certification, approval, or endorsement by any government agencies.

1.2 Test facility

CNAS (accreditation number: L2264)

TA Technology (Shanghai) Co., Ltd. has obtained the accreditation of China National Accreditation Service for Conformity Assessment (CNAS).

FCC (Designation number: CN1179, Test Firm Registration Number: 446626)

TA Technology (Shanghai) Co., Ltd. has been listed on the US Federal Communications Commission list of test facilities recognized to perform electromagnetic emissions measurements.

IC (recognition number is 8510A)

TA Technology (Shanghai) Co., Ltd. has been listed by industry Canada to perform electromagnetic emission measurement.

VCCI (recognition number is C-4595, T-2154, R-4113, G-10766)

TA Technology (Shanghai) Co., Ltd. has been listed by industry Japan to perform electromagnetic emission measurement.

A2LA (Certificate Number: 3857.01)

TA Technology (Shanghai) Co., Ltd. has been listed by American Association for Laboratory Accreditation to perform electromagnetic emission measurement.

1.3 Testing Location

Company: TA Technology (Shanghai) Co., Ltd.
Address: No.145, Jintang Rd, Tangzhen Industry Park, Pudong Shanghai, China
City: Shanghai
Post code: 201201
Country: P. R. China
Contact: Xu Kai
Telephone: +86-021-50791141/2/3
Fax: +86-021-50791141/2/3-8000
Website: <http://www.ta-shanghai.com>
E-mail: xukai@ta-shanghai.com

2 General Description of Equipment under Test

Client Information

Applicant	Quectel Wireless Solutions Co., Ltd.
Applicant address	7th Floor, Hongye Building, No. 1801 Hongmei Road, Xuhui District, Shanghai, China
Manufacturer	Quectel Wireless Solutions Co., Ltd.
Manufacturer address	7th Floor, Hongye Building, No. 1801 Hongmei Road, Xuhui District, Shanghai, China

General information

EUT Description			
Model:	BG96, BG96 MINIPCIE		
IMEI:	866425038291656		
Hardware Version:	R1.2		
Software Version:	BG96MAR04A01M1G		
Power Supply:	External power supply		
Antenna Type:	The EUT don't have standard Antenna, The Antenna used for testing in this report is the after-market accessory (Dipole Antenna)		
Test Mode(s):	NB-IOT Band 12; NB-IOT Band 13;		
Test Modulation	BPSK, QPSK		
NB-IOT Category	NB1		
Deployment:	stand-alone		
Sub-carrier spacing:	3.75KHz, 15KHz		
Ntones:	single, multi-tone		
Maximum E.R.P.	NB-IOT Band 12:	27.21 dBm	
	NB-IOT Band 13:	26.40 dBm	
Rated Power Supply Voltage:	3.8V		
Extreme Voltage:	Minimum: 3.3V Maximum: 4.3V		
Extreme Temperature:	Lowest: -40°C Highest: +85°C		
Operating Frequency Range(s)	Mode	Tx (MHz)	Rx (MHz)
	NB-IOT Band 12	699 ~ 716	729 ~ 746
	NB-IOT Band 13	777 ~ 787	746 ~ 756
Note: 1. The information of the EUT is declared by the manufacturer.			

The series model number is: BG96 MINIPCIE. The difference of these models are have different marketing requirement.

Accessory equipment	
Evaluation Board	RF Cable
RS232-to-USB Cable	Antenna: Dipole Antenna
Headset	USB Cable



3 Applied Standards

According to the specifications of the manufacturer, it must comply with the requirements of the following standards:

Test standards

FCC CFR47 Part 2 (2018)

FCC CFR47 Part 27C (2018)

ANSI C63.26 (2015)

KDB 971168 D01 Power Meas License Digital Systems v03r01

4 Test Configuration

Radiated measurements are performed by rotating the EUT in three different orthogonal test planes. EUT lie-down stand-up position (X, Y axis), lie-down position (Z axis),. Receiver antenna polarization (horizontal and vertical), the worst emission was found in position (Z axis, vertical polarization) and the worst case was recorded.

All mode and data rates and positions and RB size and modulations were investigated.

Subsequently, only the worst case emissions are reported.

The following testing in NB-IOT is set based on the maximum RF Output Power.

The following testing in different Bandwidth is set to detailin the following table:

Test modes are chosen to be reported as the worst case configuration below for NB-IOT Band 12/13:

Test items	Modes	Deployment mode	Subcarrier Spacing (kHz)		Modulation		Test Channel		
		Stand-alone	3	15	BPSK	QPSK	L	M	H
RF power output	NB-IOT B12	O	O	O	O	O	O	O	O
	NB-IOT B13	O	O	O	O	O	O	O	O
Effective Isotropic Radiated power	NB-IOT B12	O	O	O	O	O	O	O	O
	NB-IOT B13	O	O	O	O	O	O	O	O
Occupied Bandwidth	NB-IOT B12	O	O	O	O	O	O	O	O
	NB-IOT B13	O	O	O	O	O	O	O	O
Band Edge Compliance	NB-IOT B12	O	O	O	O	O	O	-	O
	NB-IOT B13	O	O	O	O	O	O	-	O
Peak-to-Average Power Ratio	NB-IOT B12	O	O	O	O	O	-	O	-
	NB-IOT B13	O	O	O	O	O	-	O	-
Frequency Stability	NB-IOT B12	O	O	O	O	O	-	O	-
	NB-IOT B13	O	O	O	O	O	-	O	-
Spurious Emissions at Antenna Terminals	NB-IOT B12	O	-	O	-	O	O	O	O
	NB-IOT B13	O	-	O	-	O	O	O	O
Radiates Spurious Emission	NB-IOT B12	O	-	O	-	O	O	O	O
	NB-IOT B13	O	-	O	-	O	O	O	O
Note 1. The mark "O" means that this configuration is chosen for testing. 2. The mark "-" means that this configuration is not testing.									

5 Test Case Results

5.1 RF Power Output

Ambient condition

Temperature	Relative humidity	Pressure
23°C ~25°C	45%~50%	101.5kPa

Methods of Measurement

During the process of the testing, The EUT is controlled by the Base Station Simulator to ensure max power transmission and proper modulation.

Test Setup

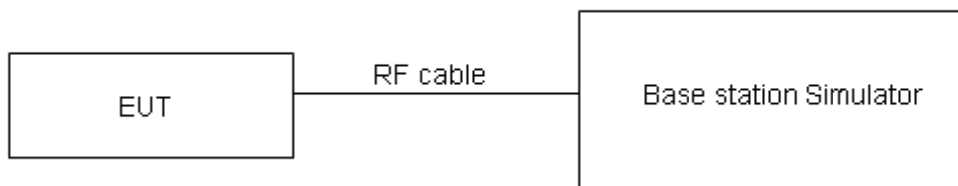

The loss between RF output port of the EUT and the input port of the tester has been taken into consideration.

Limits

No specific RF power output requirements in part 2.1046.

Measurement Uncertainty

The assessed measurement uncertainty to ensure 95% confidence level for the normal distribution is with the coverage factor $k = 2$, $U=0.4$ dB.

**Test Results**

NB-IOT Band 12				Conducted Power(dBm)		
Deployment mode	Sub-carrier spacing (kHz)	Modulation	Ntones	Channel/Frequency(MHz)		
				23011/699.1	23095/707.5	23179/715.9
Stand-alone	3.75	BPSK	1@0	22.47	22.85	23.17
		BPSK	1@47	22.45	22.95	23.16
	15	BPSK	1@0	23.05	22.92	23.71
		BPSK	1@11	23.08	23.14	23.70
	3.75	QPSK	1@0	22.48	22.89	23.15
		QPSK	1@47	22.46	22.98	23.18
	15	QPSK	1@0	23.02	23.33	23.69
		QPSK	1@11	23.09	23.14	23.74
		QPSK	12@0	23.26	23.62	23.78

NB-IOT Band 13				Conducted Power(dBm)		
Deployment mode	Sub-carrier spacing (kHz)	Modulation	Ntones	Channel/Frequency(MHz)		
				23181/777.1	23230/782	23279/786.9
Stand-alone	3.75	BPSK	1@0	22.36	22.53	22.53
		BPSK	1@47	22.34	22.34	22.51
	15	BPSK	1@0	22.68	22.69	22.90
		BPSK	1@11	22.67	22.67	22.94
	3.75	QPSK	1@0	22.32	22.51	22.54
		QPSK	1@47	22.35	22.36	22.52
	15	QPSK	1@0	22.60	22.69	22.87
		QPSK	1@11	22.66	22.71	22.91
		QPSK	12@0	22.81	23.02	23.13

5.2 Effective Isotropic Radiated Power

Ambient condition

Temperature	Relative humidity	Pressure
23°C ~25°C	45%~50%	101.5kPa

Methods of Measurement

1. The testing follows FCC KDB 971168 D01 v03r01 Section 5.8 and ANSI C63.26 (2015).
 - a) Connect the equipment as illustrated. Mount the equipment with the manufacturer specified antenna in a vertical orientation on a manufacturer specified mounting surface located on a non-conducting rotating platform of a RF anechoic chamber (preferred) or a standard radiation site.
 - b) Key the transmitter, then rotate the EUT 360° azimuthally and record spectrum analyzer power level (LVL) measurements at angular increments that are sufficiently small to permit resolution of all peaks. If a standard radiation test site is used, raise and lower the test antenna to obtain a maximum reading at each angular increment. (Note: several batteries may be needed to offset the effect of battery voltage droop, which should not exceed 5% of the manufactured specified battery voltage during transmission).
 - c) Replace the transmitter under test with a vertically polarized half-wave dipole (or an antenna whose gain is known relative to an ideal half-wave dipole). The center of the antenna should be at the same location as the center of the antenna under test.
 - d) Connect the antenna to a signal generator with a known output power and record the path loss (in dB) as LOSS. If a standard radiation test site is used, raise and lower the test antenna to obtain a maximum reading. $LOSS = \text{Generator Output Power (dBm)} - \text{Analyzer reading (dBm)}$
 - e) Determine the effective radiated output power at each angular position from the readings in steps b) and d) using the following equation: $ERP \text{ (dBm)} = LVL \text{ (dBm)} + LOSS \text{ (dB)}$
 - f) The maximum ERP is the maximum value determined in the preceding step.
 - g) When calculating ERP, in addition to knowing the antenna radiation and matching characteristics, it is necessary to know the loss values of all elements (e.g. transmission line attenuation, mismatches, filters, combiners) interposed between the point where transmitter output power is measured, and the point where power is applied to the antenna. ERP can then be calculated as follows:
 $EIRP \text{ (dBm)} = \text{Output Power (dBm)} - \text{Losses (dB)} + \text{Antenna Gain (dBi)}$
 where: dBd refers to gain relative to an ideal dipole.
 $EIRP \text{ (dBm)} = ERP \text{ (dBm)} + 2.15 \text{ (dB.)}$

The RB allocation refers to section 5.1, using the maximum output power configuration.

Test setup

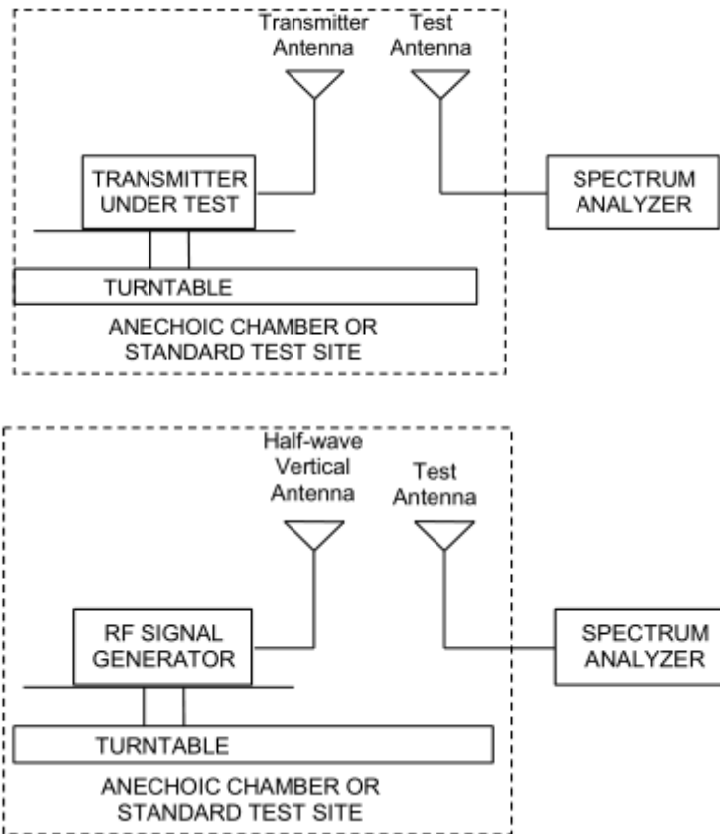

Note: Area side:2.4mX3.6m

The radiated emission was measured in the following position: EUT stand-up position (Z axis), lie-down position (X, Y axis). The worst emission was found in stand-up position (Z axis) and the worst case was recorded.

Limits

Rule Part 27.50(b) (10) specifies that “Portable stations (hand-held devices) transmitting in the 746-757 MHz, 776-788 MHz, and 805-806 MHz bands are limited to 3 watts ERP”

Rule Part 27.50(c) (10) specifies that “Portable stations (hand-held devices) in the 600 MHz uplink band and the 698-746 MHz band, and fixed and mobile stations in the 600 MHz uplink band are limited to 3 watts ERP”

Rule Part 27.50(d) (4) specifies that “Fixed, mobile and portable (hand-held) stations operating in the 1710–1755 MHz band are limited to 1 watt EIRP”

Rule Part 27.50(h) (2) specifies that “Mobile and other user stations. Mobile stations are limited to 2.0 watts EIRP. All user stations are limited to 2.0 watts transmitter output power.”

Rule Part 27.50(a) (3) specifies that “(i) For mobile and portable stations transmitting in the 2305-2315 MHz band or the 2350-2360 MHz band, the average EIRP must not exceed 50 milliwatts within any 1 megahertz of authorized bandwidth, except that for mobile and portable stations compliant with 3GPP LTE standards or another advanced mobile broadband protocol that avoids concentrating energy at the edge of the operating band the average EIRP must not exceed 250 milliwatts within any 5 megahertz of authorized bandwidth but may exceed 50 milliwatts within any 1 megahertz of authorized bandwidth. ”

Part 27.50(b)(10)Limit	≤ 3 W (34.77 dBm)
Part 27.50(c)(10)Limit	≤ 3 W (34.77 dBm)
Part 27.50(d)(4)Limit	≤ 1 W (30 dBm)

Measurement Uncertainty

The assessed measurement uncertainty to ensure 95% confidence level for the normal distribution is with the coverage factor $k = 2$, $U = 1.19$ dB

Test Results

The measurement is performed for both of horizontal and vertical antenna Polarization, and only the data of worst mode is recorded in this report.

NB-IOT Band 12 Standalone						
Frequency (MHz)	Modulation	Polarization	Sub-carrier spacing (kHz)	ERP (dBm)	Limit (dBm)	Conclusion
699.1	BPSK	Horizontal	3.75	25.97	34.77	Pass
	QPSK	Horizontal	3.75	25.98	34.77	Pass
	BPSK	Horizontal	15	26.55	34.77	Pass
	QPSK	Horizontal	15	26.52	34.77	Pass
707.5	BPSK	Horizontal	3.75	26.35	34.77	Pass
	QPSK	Horizontal	3.75	26.39	34.77	Pass
	BPSK	Horizontal	15	26.42	34.77	Pass
	QPSK	Horizontal	15	26.83	34.77	Pass
715.9	BPSK	Horizontal	3.75	26.67	34.77	Pass
	QPSK	Horizontal	3.75	26.65	34.77	Pass
	BPSK	Horizontal	15	27.21	34.77	Pass
	QPSK	Horizontal	15	27.19	34.77	Pass

NB-IOT Band 13 Standalone						
Frequency (MHz)	Modulation	Polarization	Sub-carrier spacing (kHz)	ERP (dBm)	Limit (dBm)	Conclusion
777.1	BPSK	Horizontal	3.75	25.86	34.77	Pass
	QPSK	Horizontal	3.75	25.82	34.77	Pass
	BPSK	Horizontal	15	26.18	34.77	Pass
	QPSK	Horizontal	15	26.10	34.77	Pass
782	BPSK	Horizontal	3.75	26.03	34.77	Pass
	QPSK	Horizontal	3.75	26.01	34.77	Pass
	BPSK	Horizontal	15	26.19	34.77	Pass
	QPSK	Horizontal	15	25.92	34.77	Pass
786.9	BPSK	Horizontal	3.75	26.03	34.77	Pass
	QPSK	Horizontal	3.75	26.04	34.77	Pass
	BPSK	Horizontal	15	26.40	34.77	Pass
	QPSK	Horizontal	15	26.37	34.77	Pass

Note: 1. EIRP= E.R.P+2.15

5.3 Occupied Bandwidth

Ambient condition

Temperature	Relative humidity	Pressure
23°C ~25°C	45%~50%	101.5kPa

Method of Measurement

The EUT was connected to Spectrum Analyzer and Base Station Simulator via power Splitter. The occupied bandwidth is measured using spectrum analyzer.

RBW is set to 2kHz, VBW is set to 6.2kHz for NB-IOT Band 12/13.

99% power and -26dBc occupied bandwidths are recorded. Spectrum analyzer plots are included on the following pages.

Test Setup

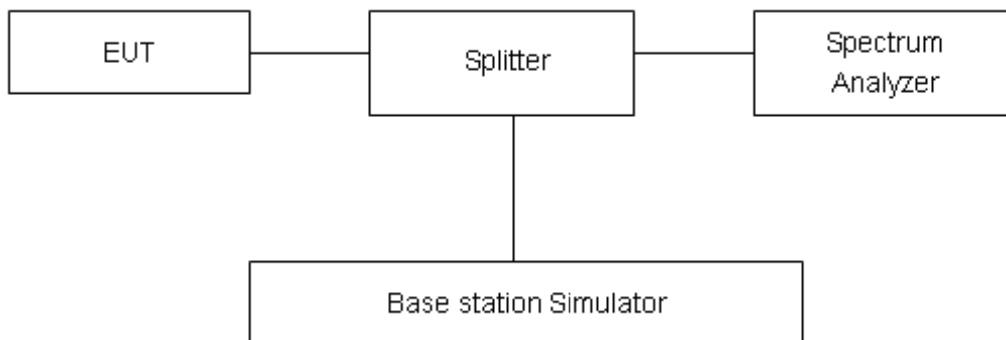

Limits

No specific occupied bandwidth requirements in part 2.1049.

Measurement Uncertainty

The assessed measurement uncertainty to ensure 95% confidence level for the normal distribution is with the coverage factor $k = 2$, $U=624\text{Hz}$.



Test Result

NB-IOT Band 12 Standalone					
Channel/ Frequency (MHz)	Modulation	Sub-carrier spacing (kHz)	Ntones	99% Power Bandwidth(kHz)	-26dBc Bandwidth(kHz)
23011/ 699.1	BPSK	3.75	1@0	49.128	35.470
	QPSK	3.75	1@0	162.730	134.100
	BPSK	15	1@0	59.688	39.570
	QPSK	15	1@0	132.830	129.800
	QPSK	15	12@0	199.470	304.700
23095/ 707.5	BPSK	3.75	1@0	51.215	38.060
	QPSK	3.75	1@0	148.180	107.500
	BPSK	15	1@0	56.256	39.580
	QPSK	15	1@0	141.800	130.400
	QPSK	15	12@0	197.860	276.100
23179/ 715.9	BPSK	3.75	1@0	47.805	36.310
	QPSK	3.75	1@0	162.520	132.600
	BPSK	15	1@0	61.578	41.580
	QPSK	15	1@0	141.860	116.100
	QPSK	15	12@0	199.830	319.400



NB-IOT Band 13 Standalone					
Channel/ Frequency (MHz)	Modulation	Sub-carrier spacing (kHz)	Ntones	99% Power Bandwidth(kHz)	-26dBc Bandwidth(kHz)
23181/ 777.1	BPSK	3.75	1@0	54.004	38.290
	QPSK	3.75	1@0	150.670	114.000
	BPSK	15	1@0	61.886	43.310
	QPSK	15	1@0	146.580	117.600
	QPSK	15	12@0	195.410	279.900
23230/ 782	BPSK	3.75	1@0	53.659	38.370
	QPSK	3.75	1@0	157.480	119.600
	BPSK	15	1@0	63.697	42.090
	QPSK	15	1@0	140.750	130.700
	QPSK	15	12@0	198.660	279.800
23279/ 786.9	BPSK	3.75	1@0	53.451	38.540
	QPSK	3.75	1@0	149.430	117.400
	BPSK	15	1@0	62.282	40.380
	QPSK	15	1@0	146.250	142.000
	QPSK	15	12@0	194.960	275.700



NB-IOT Band 12 BPSK 3.75kHz 1@0 CH-Low



NB-IOT Band 12 BPSK 15kHz 1@0 CH-Low

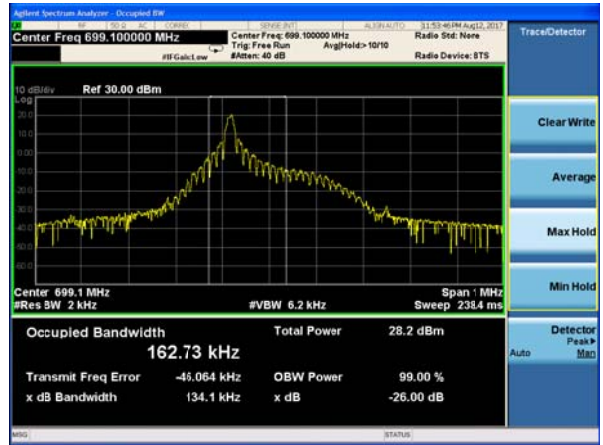

NB-IOT Band 12 BPSK 3.75kHz 1@0 CH-Middle



NB-IOT Band 12 BPSK 15kHz 1@0 CH-Middle

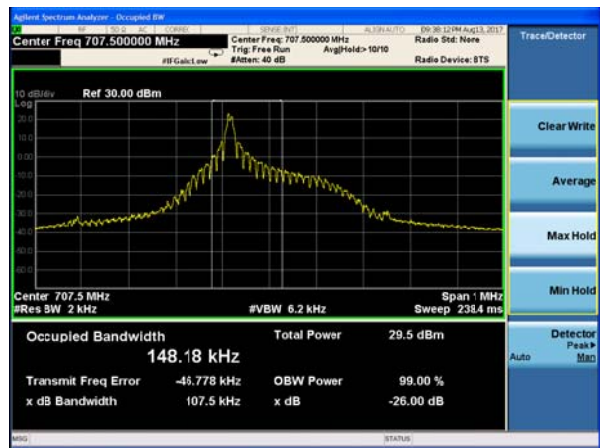

NB-IOT Band 12 BPSK 3.75kHz 1@0 CH-High

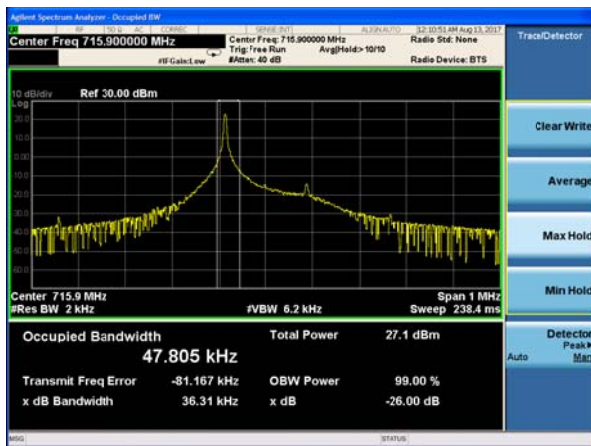

NB-IOT Band 12 BPSK 15kHz 1@0 CH-High

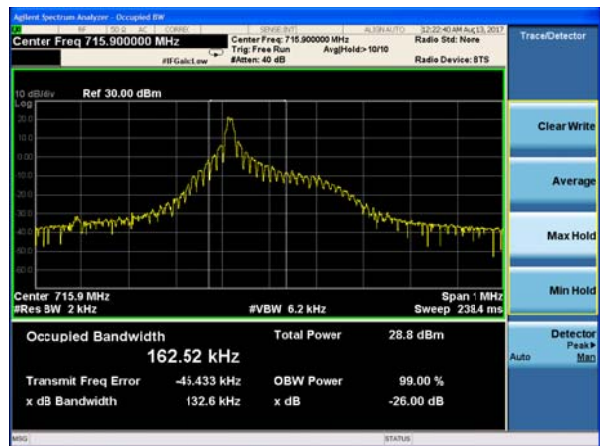



NB-IOT Band 12 QPSK 3.75kHz 1@0 CH-Low

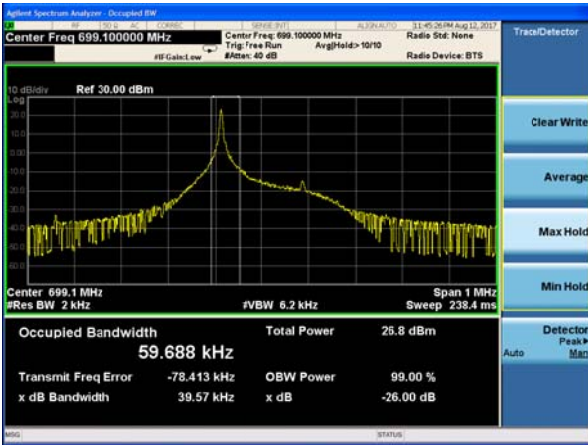

NB-IOT Band 12 QPSK 15kHz 1@0 CH-Low

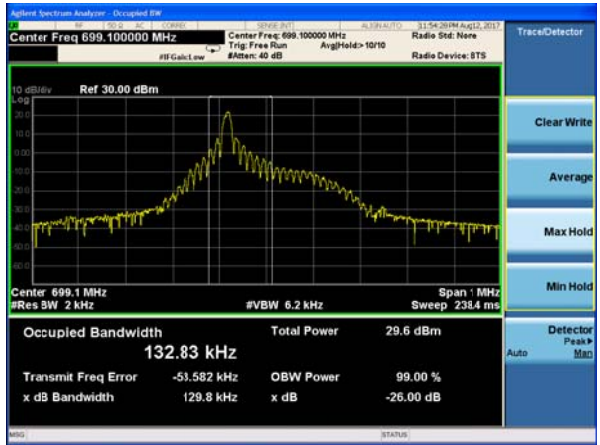

NB-IOT Band 12 QPSK 3.75kHz 1@0 CH-Middle

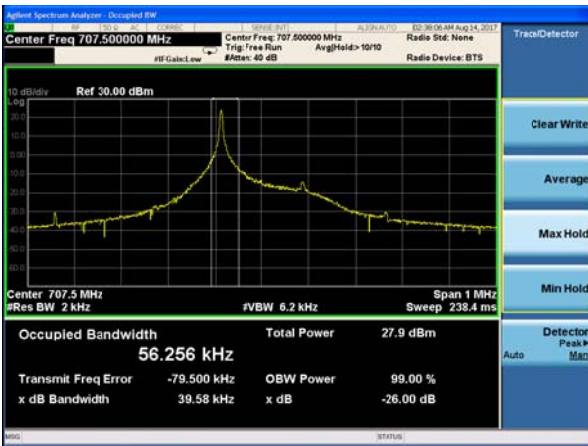

NB-IOT Band 12 QPSK 15kHz 1@0 CH-Middle



NB-IOT Band 12 QPSK 3.75kHz 1@0 CH-High

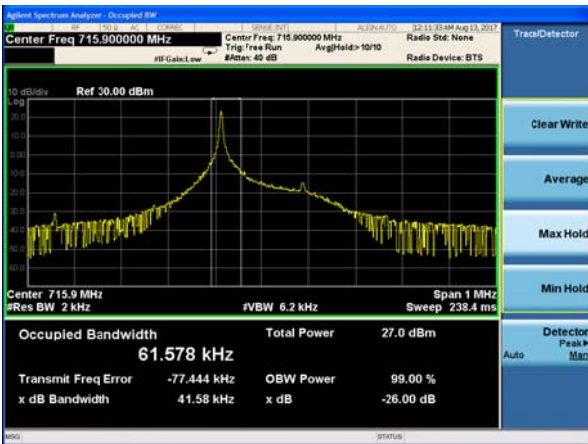

NB-IOT Band 12 QPSK 15kHz 1@0 CH-High

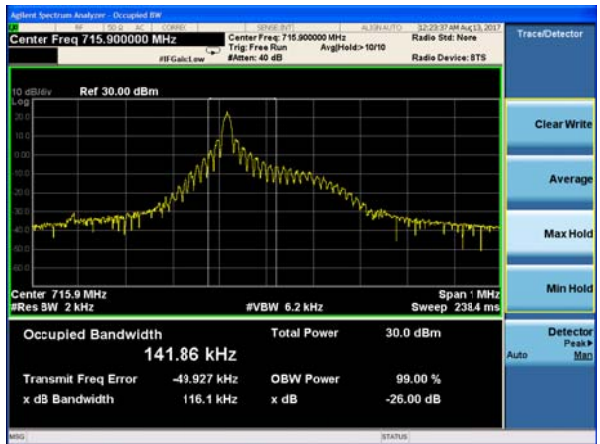



NB-IOT Band 12 QPSK 15kHz 12@0 CH-Low

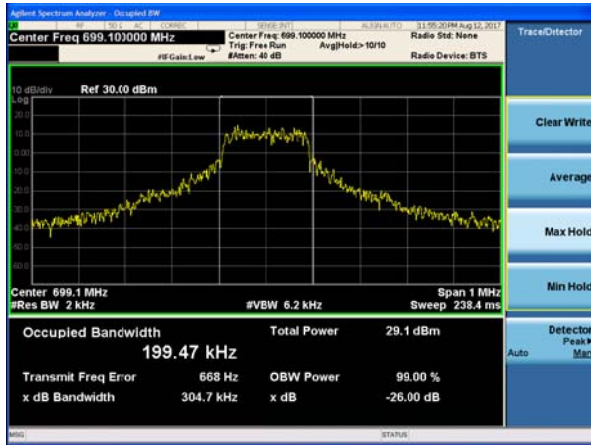

NB-IOT Band 13 BPSK 3.75kHz 1@0 CH-Low

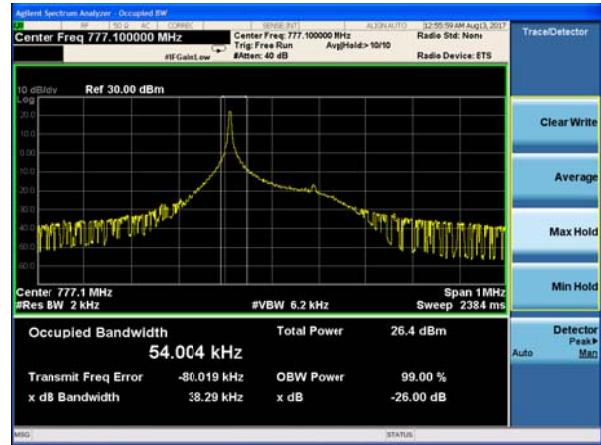

NB-IOT Band 12 QPSK 15kHz 12@0 CH-Middle



NB-IOT Band 13 BPSK 3.75kHz 1@0 CH-Middle

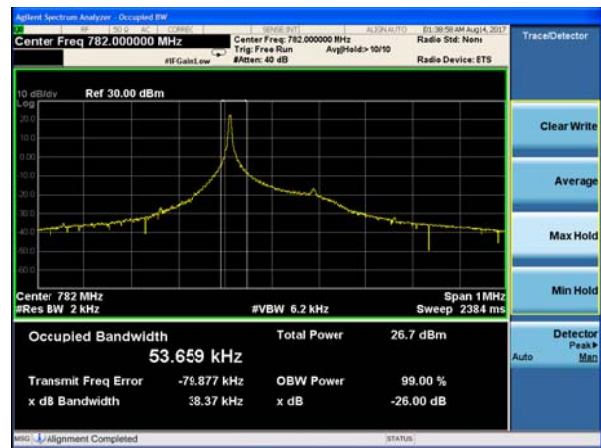

NB-IOT Band 12 QPSK 15kHz 12@0 CH-High

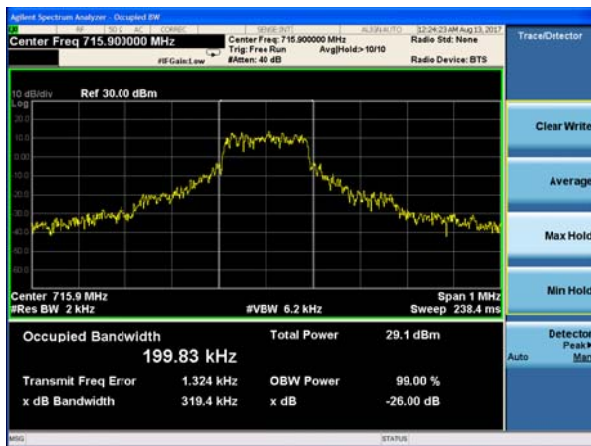

NB-IOT Band 13 BPSK 3.75kHz 1@0 CH-High

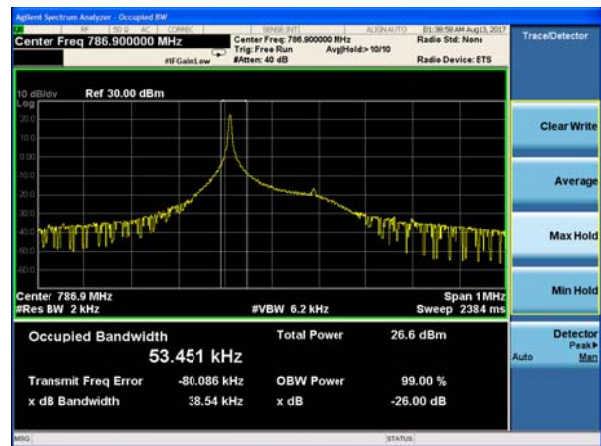



NB-IOT Band 13 BPSK 15kHz 1@0 CH-Low

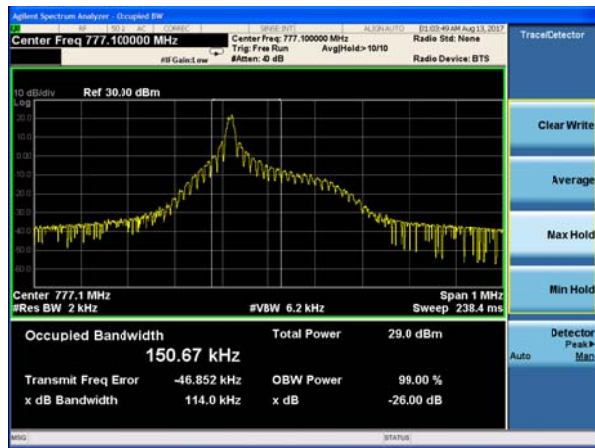

NB-IOT Band 13 QPSK 3.75kHz 1@0 CH-Low

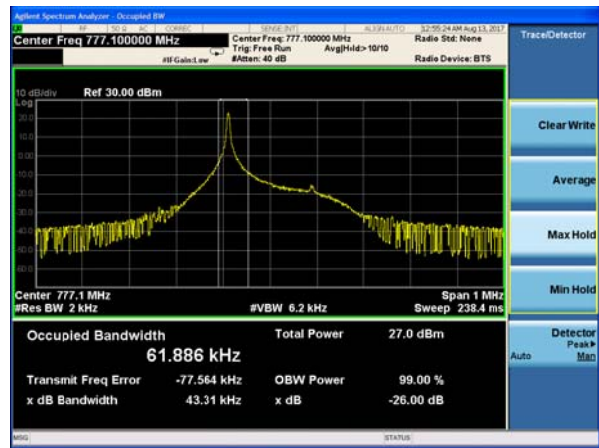

NB-IOT Band 13 BPSK 15kHz 1@0 CH-Middle

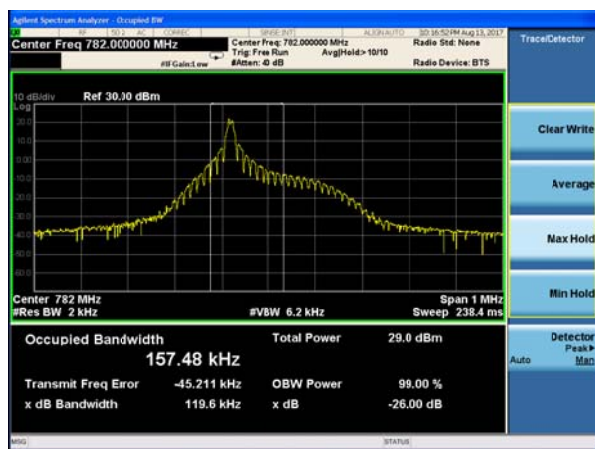

NB-IOT Band 13 QPSK 3.75kHz 1@0 CH-Middle

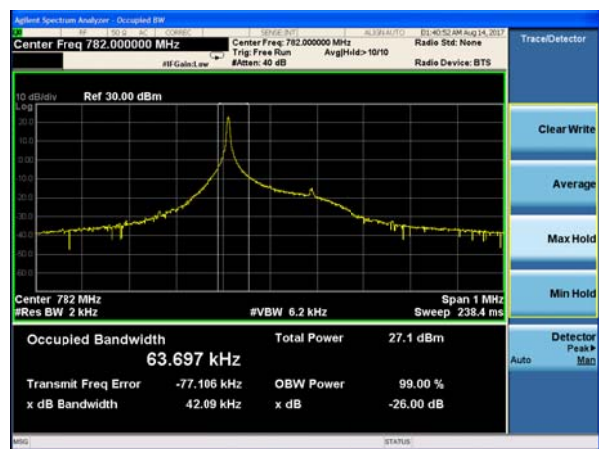

NB-IOT Band 13 BPSK 15kHz 1@0 CH-High

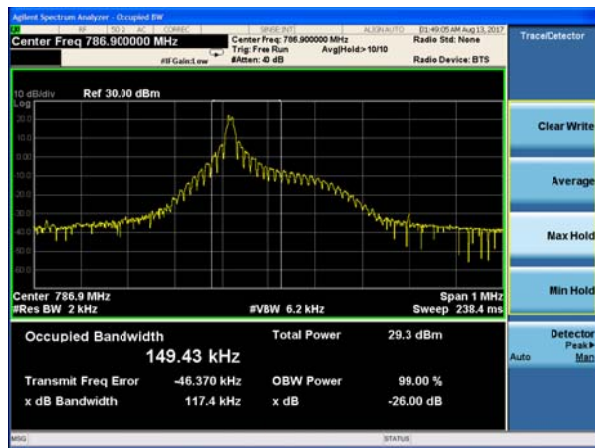

NB-IOT Band 13 QPSK 3.75kHz 1@0 CH-High

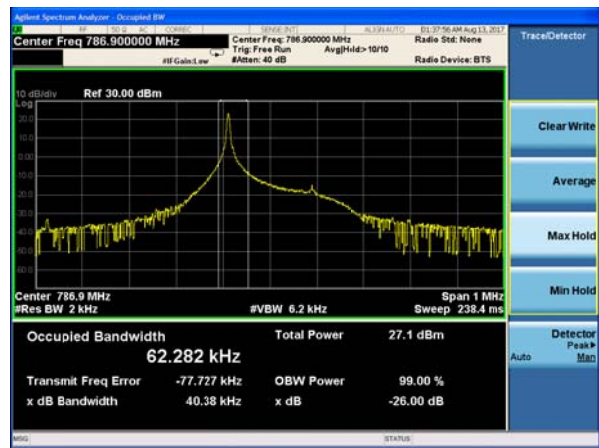



NB-IOT Band 13 QPSK 15kHz 1@0 CH-Low

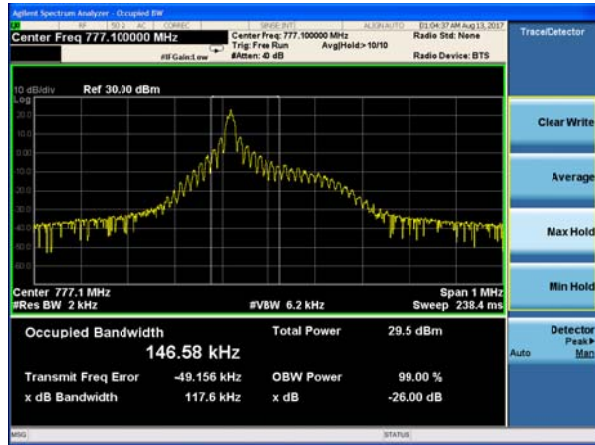

NB-IOT Band 13 QPSK 15kHz 12@0 CH-Low

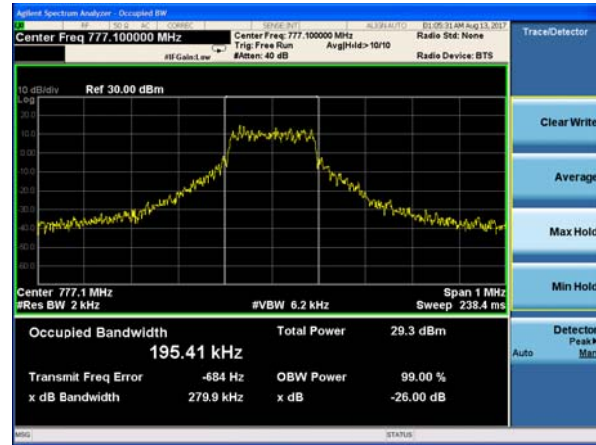

NB-IOT Band 13 QPSK 15kHz 1@0 CH-Middle

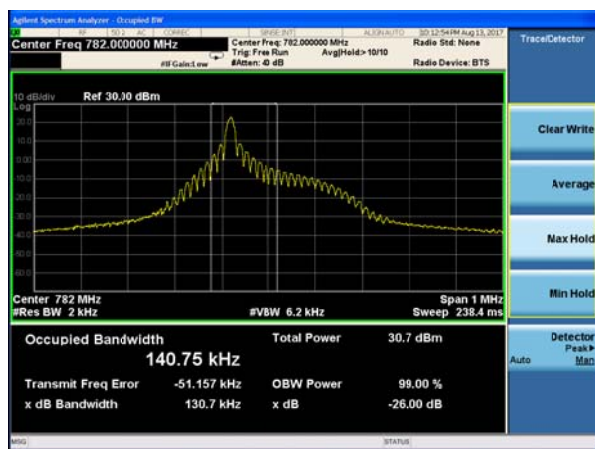

NB-IOT Band 13 QPSK 15kHz 12@0 CH-Middle

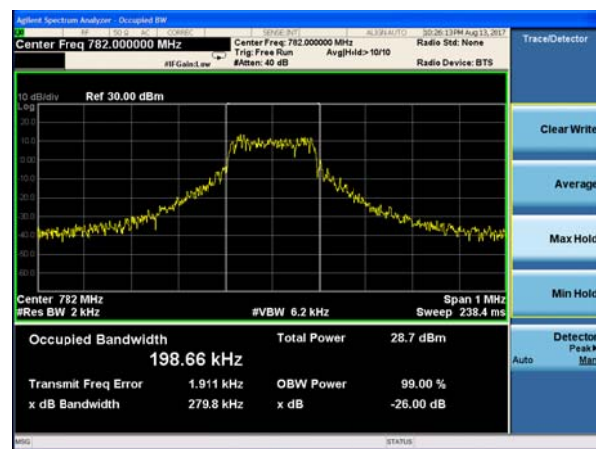

NB-IOT Band 13 QPSK 15kHz 1@0 CH-High

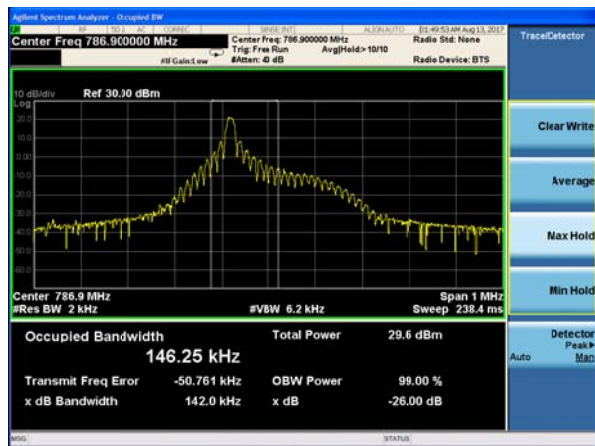

NB-IOT Band 13 QPSK 15kHz 12@0 CH-High

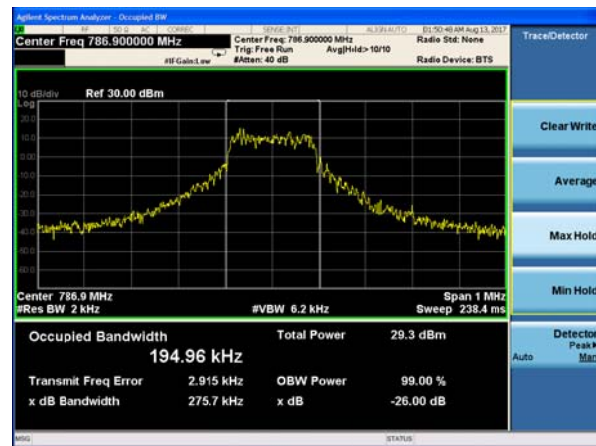

5.4 Band Edge Compliance

Ambient condition

Temperature	Relative humidity	Pressure
23°C ~25°C	45%~50%	101.5kPa

Method of Measurement

The EUT was connected to Spectrum Analyzer and Base Station Simulator via power Splitter. The band edge of the lowest and highest channels were measured.

The testing follows KDB 971168 v02r02 Section 6.0

- 1.The EUT was connected to spectrum analyzer and system simulator via a power divider.
2. The band edges of low and high channels for the highest RF powers were measured.
3. RBW is set to 51Hz, VBW is set to 160Hz for 3.75KHz single carrier, RBW is set to 200Hz, VBW is set to 620Hz for 15KHz single carrier, RBW is set to 2kHz, VBW is set to 6.2KHz for 15KHz full carrier on spectrum analyzer.
4. Set spectrum analyzer with RMS detector.
5. The RF fundamental frequency should be excluded against the limit line in the operating frequency band.
6. Checked that all the results comply with the emission limit line.

Test Setup

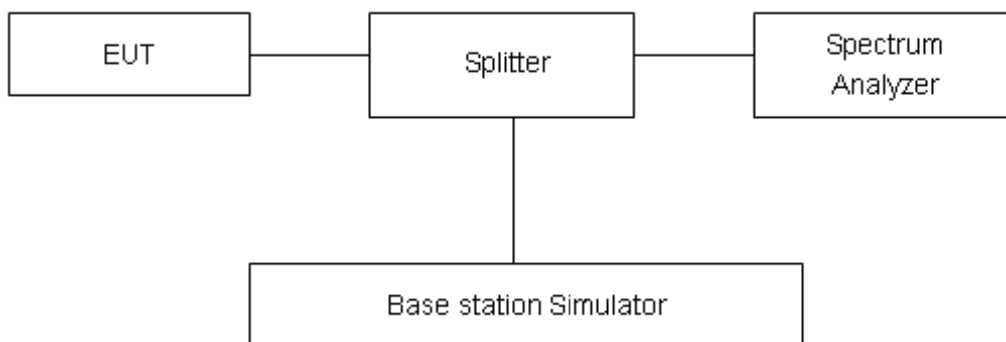

**Limits**

Part 27.53(g) specifies that “ For operations in the 600 MHz band and the 698-746 MHz band, the power of any emission outside a licensee's frequency block shall be attenuated below the transmitter power (P) within the licensed band(s) of operation, measured in watts, by at least $43 + 10 \log_{10} (P)$ dB.”

Measurement Uncertainty

The assessed measurement uncertainty to ensure 95% confidence level for the normal distribution is with the coverage factor $k = 1.96$, $U=0.684\text{dB}$.

Test Result

NB-IOT Band 12 BPSK 3.75kHz 1@0 CH-Low

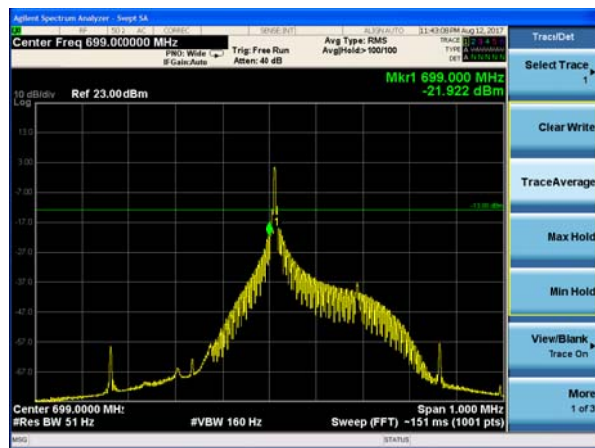

NB-IOT Band 12 BPSK 3.75kHz 1@47 CH-High

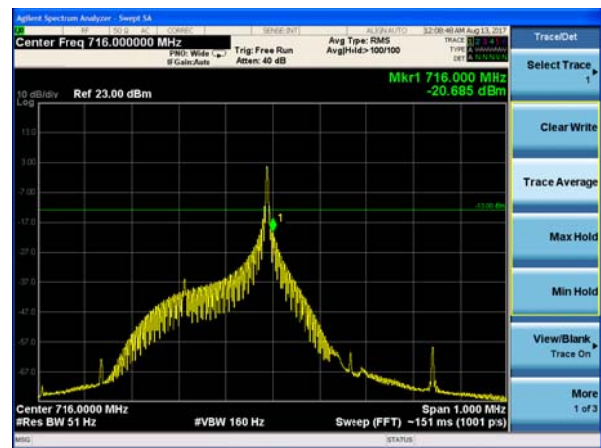

NB-IOT Band 12 BPSK 15kHz 1@0 CH-Low

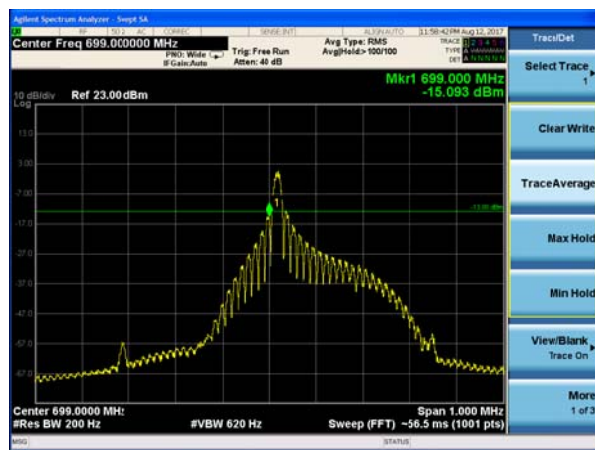

NB-IOT Band 12 BPSK 15kHz 1@11 CH-High

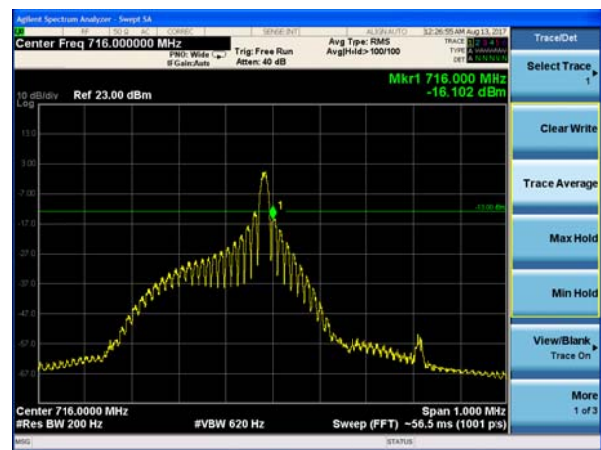

NB-IOT Band 12 QPSK 3.75kHz 1@0 CH-Low

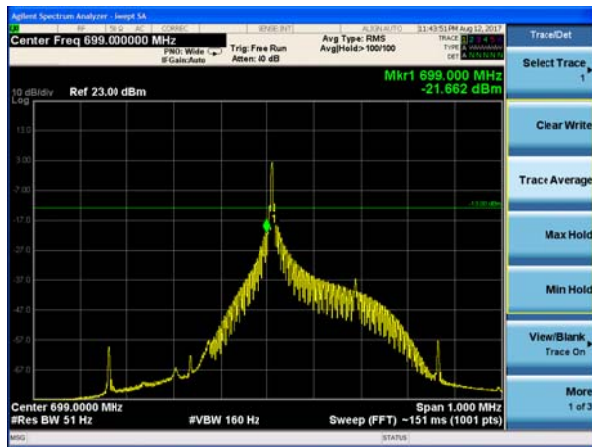

NB-IOT Band 12 QPSK 3.75kHz 1@47 CH-High

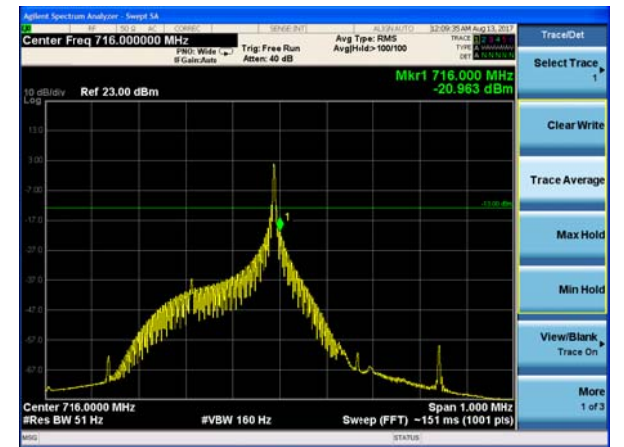

NB-IOT Band 12 QPSK 15kHz 1@0 CH-Low

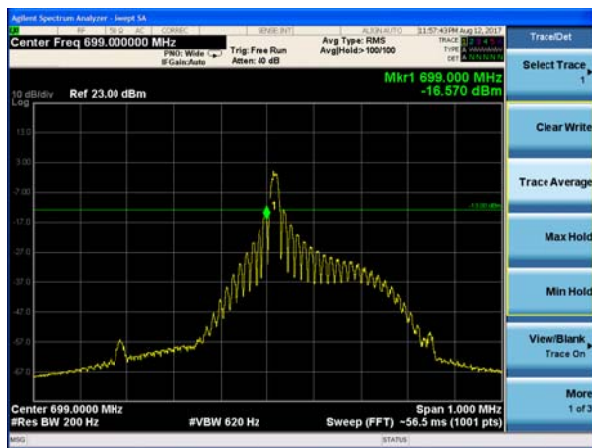

NB-IOT Band 12 QPSK 15kHz 1@11 CH-High

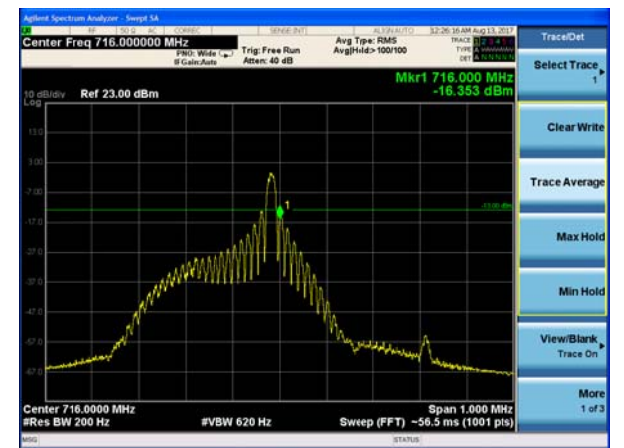

NB-IOT Band 12 QPSK 15kHz 12@0 CH-Low

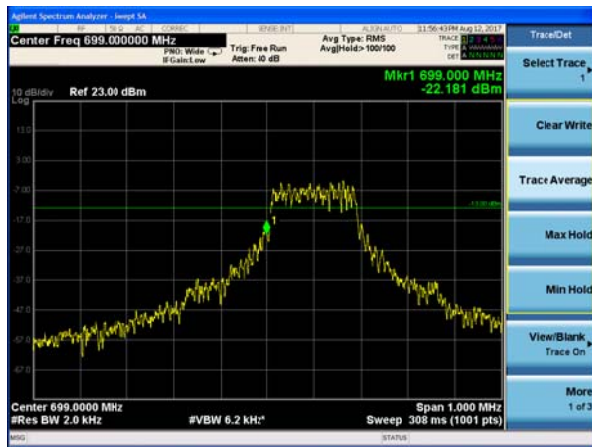

NB-IOT Band 12 QPSK 15kHz 12@0 CH-High





NB-IOT Band 13 BPSK 3.75kHz 1@0 CH-Low

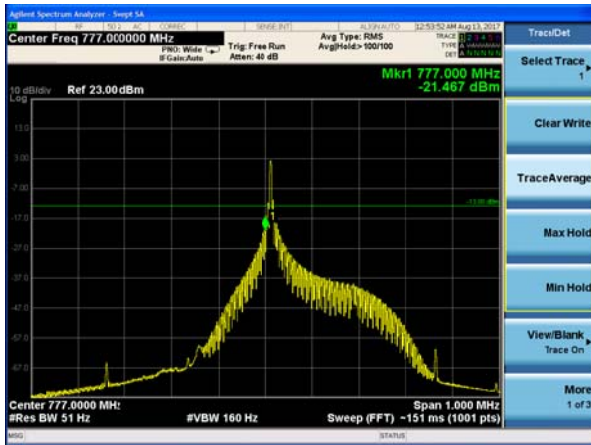

NB-IOT Band 13 BPSK 3.75kHz 1@47 CH-High

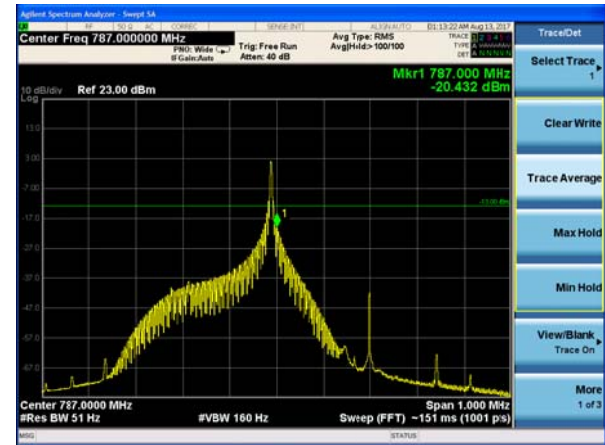

NB-IOT Band 13 BPSK 15kHz 1@0 CH-Low

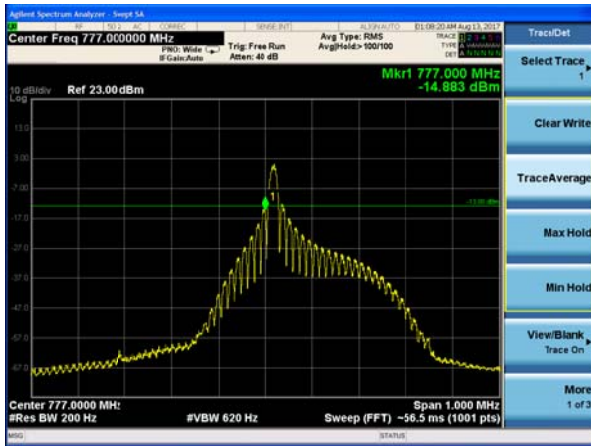

NB-IOT Band 13 BPSK 15kHz 1@11 CH-High

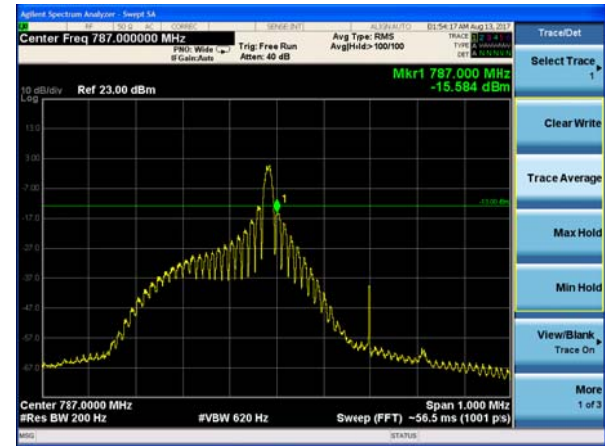



NB-IOT Band 13 QPSK 3.75kHz 1@0 CH-Low

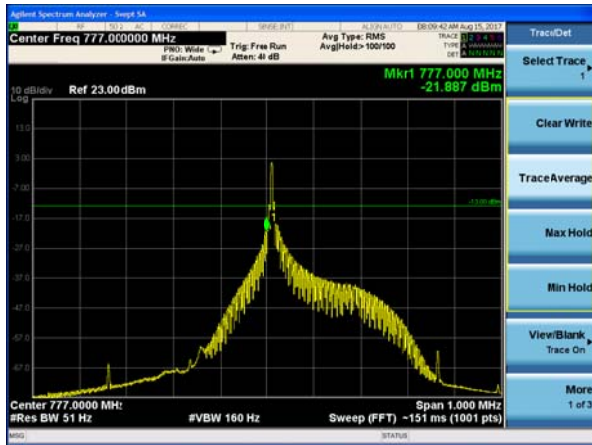

NB-IOT Band 13 QPSK 3.75kHz 1@47 CH-High

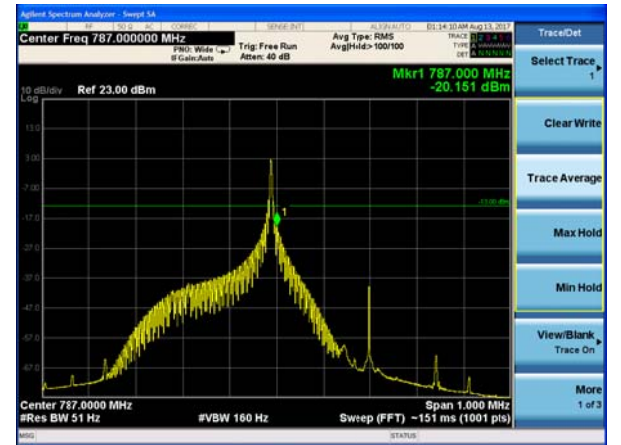

NB-IOT Band 13 QPSK 15kHz 1@0 CH-Low

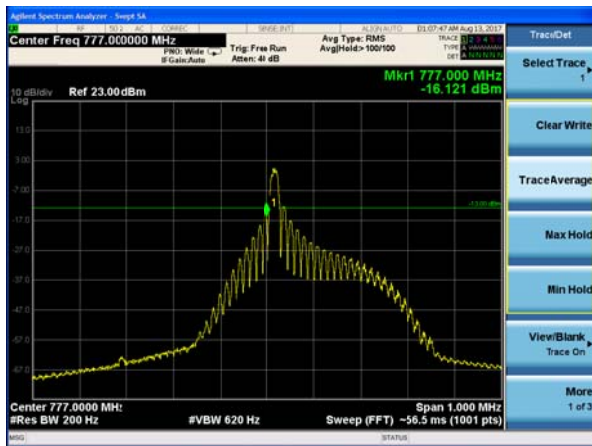

NB-IOT Band 13 QPSK 15kHz 1@11 CH-High

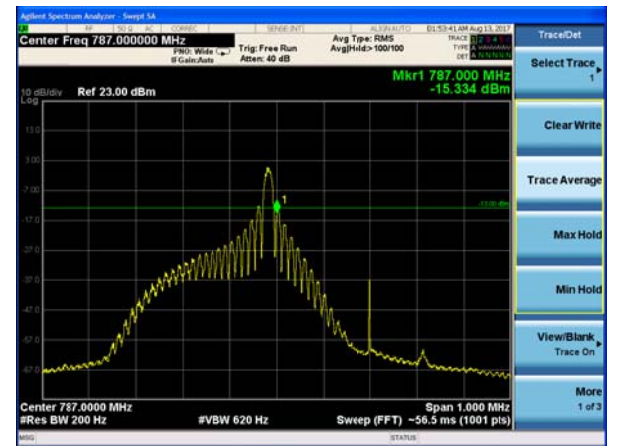

NB-IOT Band 13 QPSK 15kHz 12@0 CH-Low

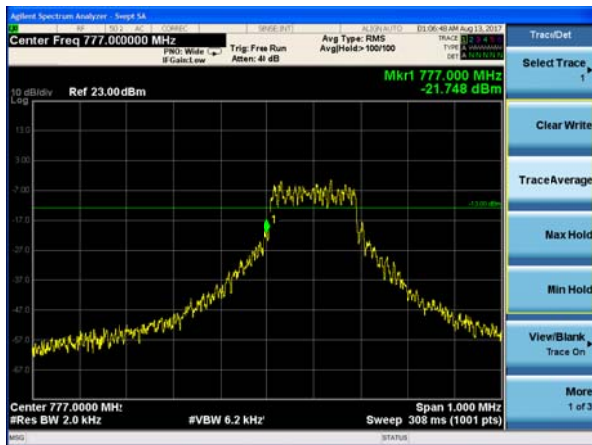

NB-IOT Band 13 QPSK 15kHz 12@0 CH-High

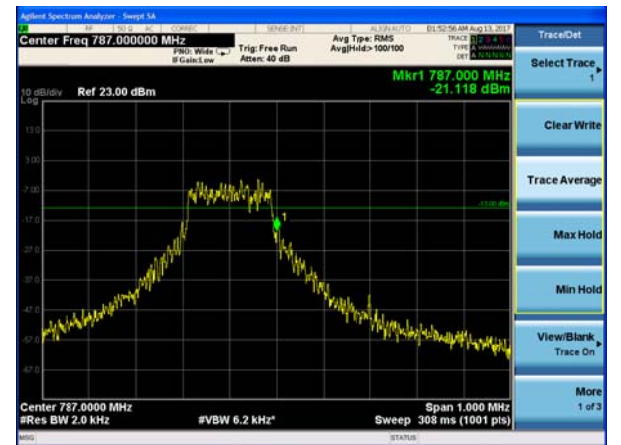

5.5 Peak-to-Average Power Ratio (PAPR)

Ambient condition

Temperature	Relative humidity	Pressure
23°C ~25°C	45%~50%	101.5kPa

Methods of Measurement

Measure the total peak power and record as Ppk. And measure the total average power and record as PAvg. Both the peak and average power levels must be expressed in the same logarithmic units (e.g., dBm). Determine the PAPR from:

$$PAPR (dB) = Ppk (dBm) - PAvg (dBm).$$

Test Setup

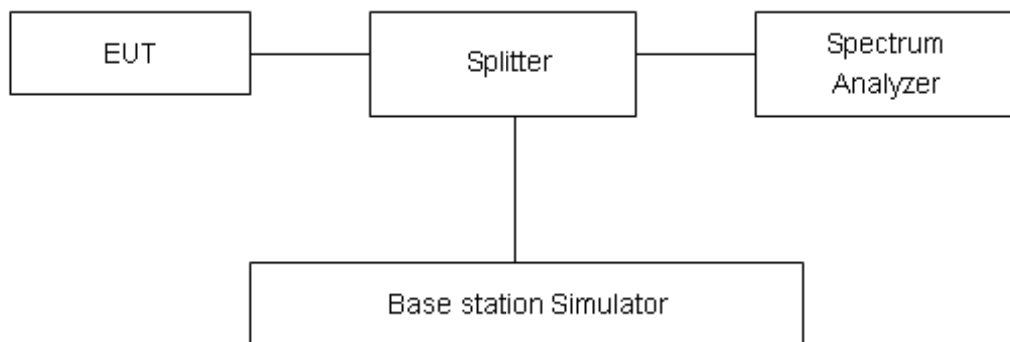

Limits

Rule Part 27.50(d)(5) Equipment employed must be authorized in accordance with the provisions of 24.51. Power measurements for transmissions by stations authorized under this section may be made either in accordance with a Commission-approved average power technique or in compliance with paragraph (d)(6) of this section. In measuring transmissions in this band using an average power technique, the peak-to-average ratio (PAR) of the transmission may not exceed 13 dB.

Measurement Uncertainty

The assessed measurement uncertainty to ensure 95% confidence level for the normal distribution is with the coverage factor k = 2, U= 0.4 dB.

Test Results

NB-IOT Band 12 Standalone							
Modulation	Sub-carrier spacing (kHz)	Channel/Frequency (MHz)	Peak (dBm)	Avg (dBm)	PAPR (dB)	Limit (dB)	Conclusion
BPSK	3.75	23095/707.5	26.39	22.85	3.54	≤13	PASS
QPSK	3.75	23095/707.5	29.56	22.92	6.64	≤13	PASS
BPSK	15	23095/707.5	26.48	22.89	3.59	≤13	PASS
QPSK	15	23095/707.5	29.99	23.33	6.66	≤13	PASS

NB-IOT Band 13 Standalone							
Modulation	Sub-carrier spacing (kHz)	Channel/Frequency (MHz)	Peak (dBm)	Avg (dBm)	PAPR (dB)	Limit (dB)	Conclusion
BPSK	3.75	23230/782	25.83	22.53	3.30	≤13	PASS
QPSK	3.75	23230/782	28.76	22.69	6.07	≤13	PASS
BPSK	15	23230/782	25.72	22.51	3.21	≤13	PASS
QPSK	15	23230/782	28.84	22.69	6.15	≤13	PASS

5.6 Frequency Stability

Ambient condition

Temperature	Relative humidity	Pressure
23°C ~25°C	45%~50%	101.5kPa

Method of Measurement

1. Frequency Stability (Temperature Variation)

The temperature inside the climate chamber is varied from -40°C to +85°C in 10°C step size.

(1)With all power removed, the temperature was decreased to -10°C and permitted to stabilize for three hours.

(2)Measure the carrier frequency with the test equipment in a “call mode”. These measurements should be made within 1 minute of powering up the mobile station, to prevent significant self warming.

(3) Repeat the above measurements at 10°C increments from -40°C to +85°C. Allow at least 1.5 hours at each temperature, un-powered, before making measurements.

2. Frequency Stability (Voltage Variation)

The frequency stability shall be measured with variation of primary supply voltage as follows:

(1) Vary primary supply voltage from 85 to 115 percent of the nominal value for other than hand carried battery equipment.

(2) For hand carried, battery powered equipment, reduce primary supply voltage to the battery-operating end point which shall be specified by the manufacturer.

This transceiver is specified to operate with an input voltage of between 3.3 V and 4.3 V, with a nominal voltage of 3.8V.

Test setup

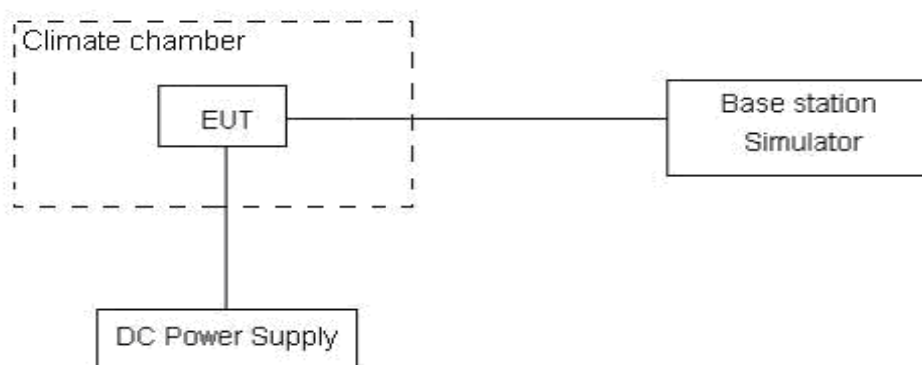

Limits

No specific frequency stability requirements in part 27.54

Measurement Uncertainty

The assessed measurement uncertainty to ensure 99.75% confidence level for the normal distribution is with the coverage factor $k = 3, U=0.01\text{ppm}$.

Test Result

NB-IOT Band 12 Standalone CH23095 Test Results (ppm)				
Sub-carrier spacing (kHz)	Test status	BPSK	QPSK	
3.75	-40°C/Normal Voltage	-0.00459	-0.00035	
	-30°C/Normal Voltage	-0.00274	-0.00177	
	-20°C/Normal Voltage	-0.00568	-0.00220	
	-10°C/Normal Voltage	-0.00356	-0.00117	
	0°C/Normal Voltage	-0.00168	-0.00353	
	10°C/Normal Voltage	-0.00243	-0.00076	
	20°C/Normal Voltage	-0.00308	-0.00045	
	30°C/Normal Voltage	-0.00095	0.00010	
	40°C/Normal Voltage	-0.00112	-0.00103	
	50°C/Normal Voltage	0.00734	-0.00201	
	60°C/Normal Voltage	-0.00461	-0.00041	
	70°C/Normal Voltage	-0.00083	-0.00175	
	80°C/Normal Voltage	-0.00284	-0.00414	
	85°C/Normal Voltage	-0.00216	-0.00078	
	20°C/Minimum Voltage	-0.00220	-0.00211	
	20°C/Maximum Voltage	-0.00372	-0.00124	
	15	-40°C/Normal Voltage	-0.00331	-0.00095
		-30°C/Normal Voltage	0.00027	-0.00082
-20°C/Normal Voltage		-0.00148	0.00109	
-10°C/Normal Voltage		-0.00064	0.00110	
0°C/Normal Voltage		0.00167	-0.00247	
10°C/Normal Voltage		-0.00171	0.00147	
20°C/Normal Voltage		0.00038	0.00073	
30°C/Normal Voltage		-0.00163	-0.00034	
40°C/Normal Voltage		-0.00189	-0.00131	
50°C/Normal Voltage		-0.00348	0.00150	
60°C/Normal Voltage		-0.00180	-0.00041	
70°C/Normal Voltage		-0.00076	-0.00192	
80°C/Normal Voltage		-0.00425	-0.00284	
85°C/Normal Voltage		-0.00506	-0.00327	
20°C/Minimum Voltage		-0.00129	-0.00161	
20°C/Maximum Voltage		-0.00250	-0.00100	

NB-IOT Band 13 Standalone Channel 23230			
Test Results (ppm)			
Sub-carrier spacing (kHz)	Test status	BPSK	QPSK
3.75	-40°C/Normal Voltage	0.00306	-0.00334
	-30°C/Normal Voltage	0.00425	-0.00230
	-20°C/Normal Voltage	0.00095	0.00084
	-10°C/Normal Voltage	-0.00104	0.00162
	0°C/Normal Voltage	-0.00050	0.00040
	10°C/Normal Voltage	-0.00338	0.00015
	20°C/Normal Voltage	-0.00313	-0.00215
	30°C/Normal Voltage	-0.00191	-0.00165
	40°C/Normal Voltage	-0.00193	-0.00059
	50°C/Normal Voltage	-0.00274	0.00074
	60°C/Normal Voltage	-0.00032	-0.00162
	70°C/Normal Voltage	-0.00176	-0.00302
	80°C/Normal Voltage	-0.00301	-0.00248
	85°C/Normal Voltage	-0.00098	-0.00225
	20°C/Minimum Voltage	0.00302	0.00175
	20°C/Maximum Voltage	0.00367	0.00191
	15	-40°C/Normal Voltage	-0.00169
-30°C/Normal Voltage		-0.00339	-0.00215
-20°C/Normal Voltage		-0.00120	-0.00312
-10°C/Normal Voltage		-0.00191	-0.00133
0°C/Normal Voltage		-0.00155	0.00022
10°C/Normal Voltage		-0.00202	-0.00137
20°C/Normal Voltage		-0.00157	-0.00088
30°C/Normal Voltage		-0.00267	-0.00159
40°C/Normal Voltage		-0.00262	0.00026
50°C/Normal Voltage		0.00024	-0.00275
60°C/Normal Voltage		0.00074	-0.00249
70°C/Normal Voltage		-0.00161	-0.00175
80°C/Normal Voltage		-0.00075	-0.00082
85°C/Normal Voltage		-0.00086	-0.00097
20°C/Minimum Voltage		0.00139	-0.00142
20°C/Maximum Voltage		-0.00156	-0.00060

5.7 Spurious Emissions at Antenna Terminals

Ambient condition

Temperature	Relative humidity	Pressure
23°C ~25°C	45%~50%	101.5kPa

Method of Measurement

The EUT was connected to Spectrum Analyzer and Base Station Simulator via power Splitter. The measurement is carried out using a spectrum analyzer. The spectrum analyzer scans from 30MHz to the 10th harmonic of the carrier. The peak detector is used. Set RBW 1MHz and VBW3MHz, Sweep is set to ATUO.

Of those disturbances below (limit – 20 dB), the mark is not required for the EUT.

Test setup

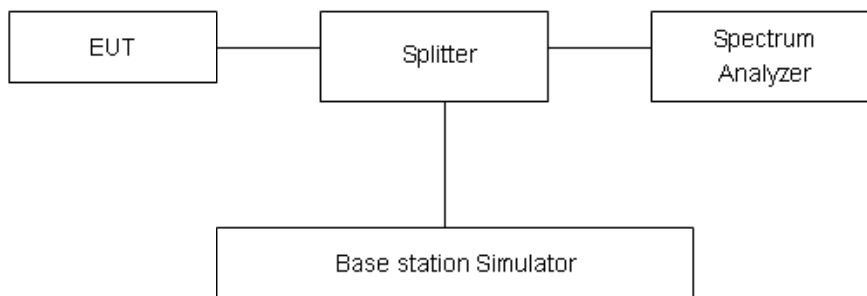

Limits

Rule Part 27.53 (g) For operations in the 600 MHz band and the 698-746 MHz band, the power of any emission outside a licensee's frequency band(s) of operation shall be attenuated below the transmitter power (P) within the licensed band(s) of operation, measured in watts, by at least $43 + 10 \log (P)$ dB. Compliance with this provision is based on the use of measurement instrumentation employing a resolution bandwidth of 100 kilohertz or greater. However, in the 100 kilohertz bands immediately outside and adjacent to a licensee's frequency block, a resolution bandwidth of at least 30 kHz may be employed.

Rule Part 27.53(f) For operations in the 746-758 MHz, 775-788 MHz, and 805-806 MHz bands, emissions in the band 1559-1610 MHz shall be limited to -70 dBW/MHz equivalent isotropically radiated power (EIRP) for wideband signals, and -80 dBW EIRP for discrete emissions of less than 700 Hz bandwidth. For the purpose of equipment authorization, a transmitter shall be tested with an antenna that is representative of the type that will be used with the equipment in normal operation.

**NB-IOT B12 Limit**

Limit	-13 dBm
-------	---------

NB-IOT B13 Limit

Limit out of the band 1559-1610 MHz	-13 dBm
Limit in the band 1559-1610 MHz	-40 dBm

Measurement Uncertainty

The assessed measurement uncertainty to ensure 99.75% confidence level for the normal distribution is with the coverage factor $k = 1.96$.

Frequency	Uncertainty
100kHz-2GHz	0.684 dB
2GHz-12.75GHz	1.407 dB

Test Result

Sweep from 9 kHz to 30MHz, and the emissions more than 20 dB below the permissible value are not reported.

If disturbances were found more than 20dB below limit line, the mark is not required for the EUT. The signal beyond the limit is carrier.

Standalone deployment with 15 KHz subcarrier spacing and QPSK mode for CAT NB1:

Test Data File Name	Frequency (MHz)	Peak (dBm)	Limit (dBm)	Margin (dB)
CSE_ NB-IOT B12_CHLOW_1-8GHz	1398.1	-16.24	-13.00	3.24
CSE_ NB-IOT B12_CHMID_1-8GHz	1417.8	-17.30	-13.00	4.30
CSE_ NB-IOT B12_CHHIGH_1-8GHz	1431.6	-17.48	-13.00	4.48



NB-IOT Band 12 CH-Low 30MHz~1GHz

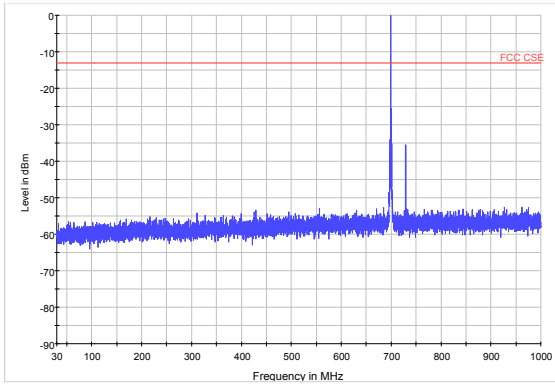

NB-IOT Band 12 CH-Low 1GHz~8GHz

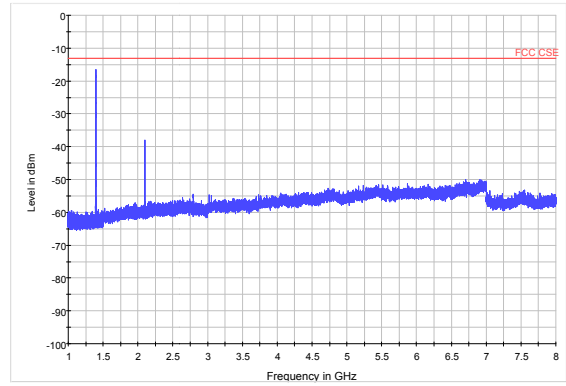

NB-IOT Band 12 CH-Middle 30MHz~1GHz

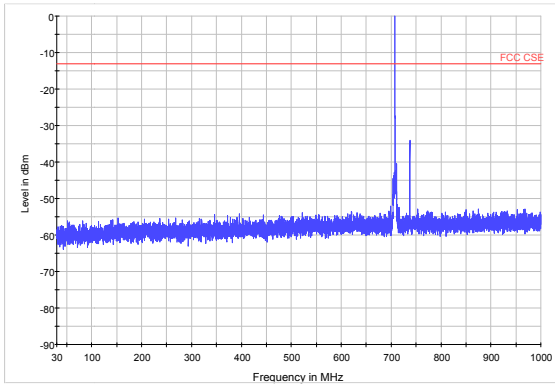

NB-IOT Band 12 CH-Middle 1GHz~8GHz

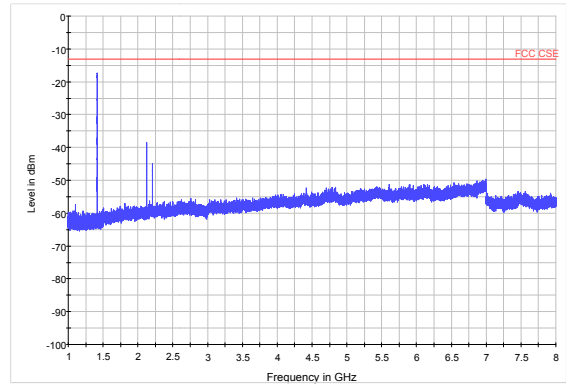

NB-IOT Band 12 CH-High 30MHz~1GHz

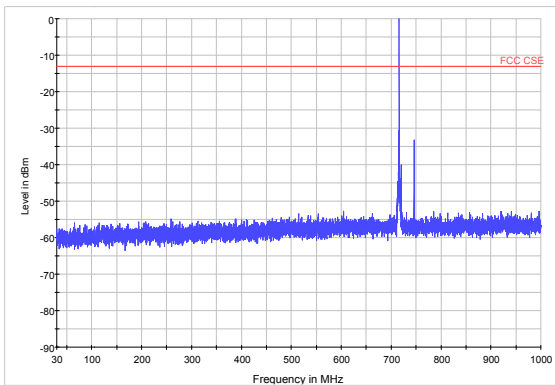

NB-IOT Band 12 CH-High 1GHz~8GHz

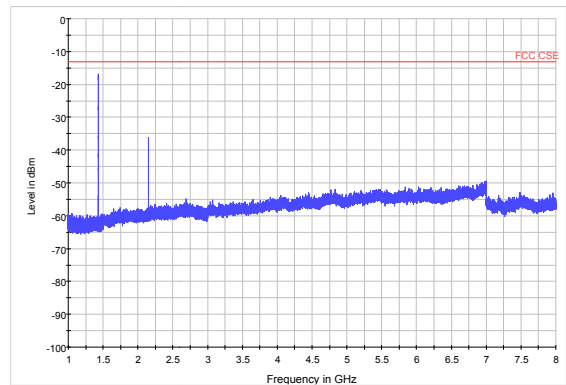



NB-IOT Band 13 CH-Low 30MHz~1GHz

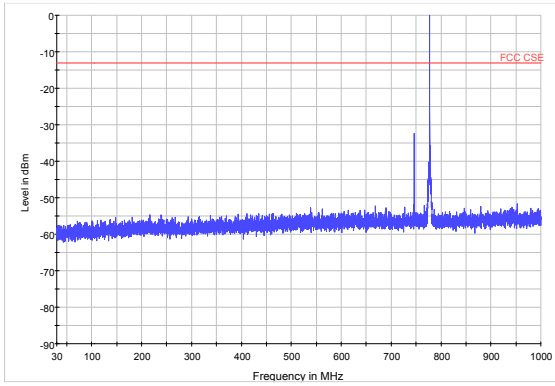

NB-IOT Band 13 CH-Low 1GHz~8GHz

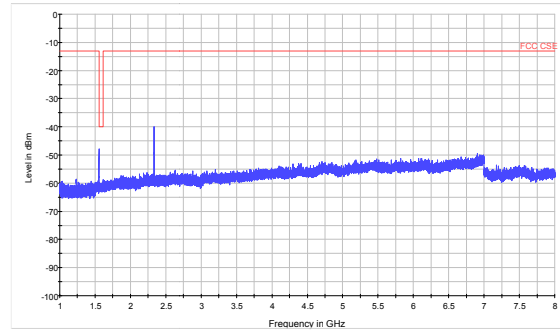

NB-IOT Band 13 CH-Middle 30MHz~1GHz

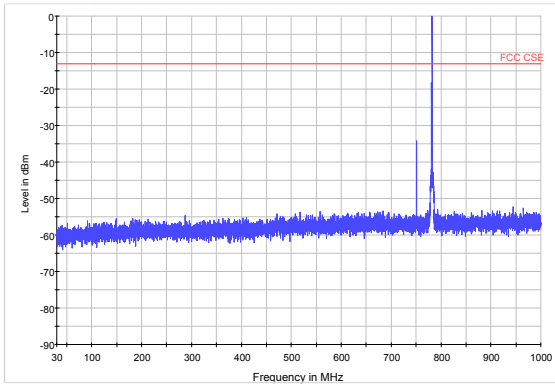

NB-IOT Band 13 CH-Middle 1GHz~8GHz

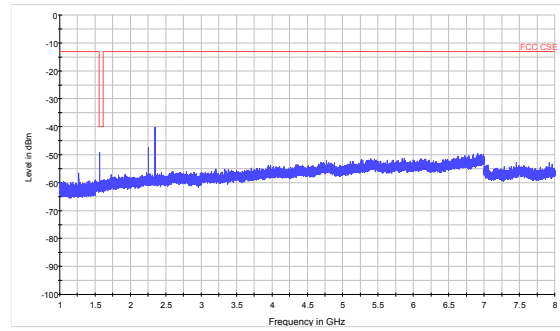

NB-IOT Band 13 CH-High 30MHz~1GHz

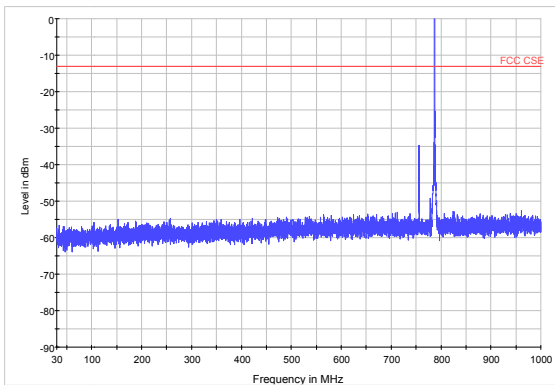

NB-IOT Band 13 CH-High 1GHz~8GHz

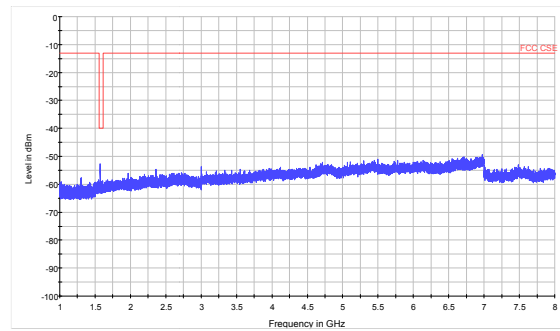

5.8 Radiates Spurious Emission

Ambient condition

Temperature	Relative humidity	Pressure
23°C ~25°C	45%~50%	101.5kPa

Method of Measurement

- The testing follows FCC KDB 971168 D01 v03r01 Section 5.8 and ANSI C63.26 (2015).
- Below 1GHz: The EUT is placed on a turntable 0.8 meters above the ground in the chamber, 3 meter away from the antenna. The maximal emission value is acquired by adjusting the antenna height, polarisation and turntable azimuth. Normally, the height range of antenna is 1 m to 4 m, the azimuth range of turntable is 0° to 360°, and the receive antenna has two polarizations Vertical (V) and Horizontal (H). Above 1GHz: (Note: the FCC's permission to use 1.5m as an alternative per TCBC Conf call of Dec. 2, 2014.) The EUT is placed on a turntable 1.5 meters above the ground in the chamber, 3 meter away from the antenna. The maximal emission value is acquired by adjusting the antenna height, polarisation and turntable azimuth. Normally, the height range of antenna is 1 m to 4 m, the azimuth range of turntable is 0° to 360°, and the receive antenna has two polarizations Vertical (V) and Horizontal (H).
- A loop antenna, A log-periodic antenna or horn antenna shall be substituted in place of the EUT. The log-periodic antenna will be driven by a signal generator and the level will be adjusted till the same power value on the spectrum analyzer or receiver. The level of the spurious emissions can be calculated through the level of the signal generator, cable loss, the gain of the substitution antenna and the reading of the spectrum analyzer or receiver.
- The EUT is then put into continuously transmitting mode at its maximum power level during the test. Set Test Receiver or Spectrum RBW=200Hz,VBW=600Hz for 9kHz150kHz , RBW=10kHz, VBW=30kHz 150kHz-30MHz ,RBW=100kHz,VBW=300kHz for 30MHz to 1GHz and RBW=1MHz, VBW=3MHz for above 1GHz And the maximum value of the receiver should be recorded as (Pr).
- The EUT shall be replaced by a substitution antenna. In the chamber, an substitution antenna for the frequency band of interest is placed at the reference point of the chamber. An RF Signal source for the frequency band of interest is connected to the substitution antenna with a cable that has been constructed to not interfere with the radiation pattern of the antenna. A power (PMea) is applied to the input of the substitution antenna, and adjust the level of the signal generator output until the value of the receiver reach the previously recorded (Pr). The power of signal source (PMea) is recorded. The test should be performed by rotating the test item and adjusting the receiving antenna polarization.
- A amplifier should be connected to the Signal Source output port. And the cable should be connect between the Amplifier and the Substitution Antenna. The cable loss (Pcl) ,the Substitution Antenna Gain (Ga) and the Amplifier Gain (PAg) should be recorded after test.
- The measurement results are obtained as described below:
 $Power(EIRP)=PMea- PAg - Pcl + Ga$
 The measurement results are amend as described below:
 $Power(EIRP)=PMea- Pcl + Ga$
- This value is EIRP since the measurement is calibrated using an antenna of known gain (2.15 dBi) and known input power. ERP can be calculated from EIRP by subtracting the gain of the dipole, ERP

= EIRP-2.15dBi.

The modulation mode and RB allocation refer to section 5.1, using the maximum output power configuration.

Test setup

9KHz ~ 30MHz

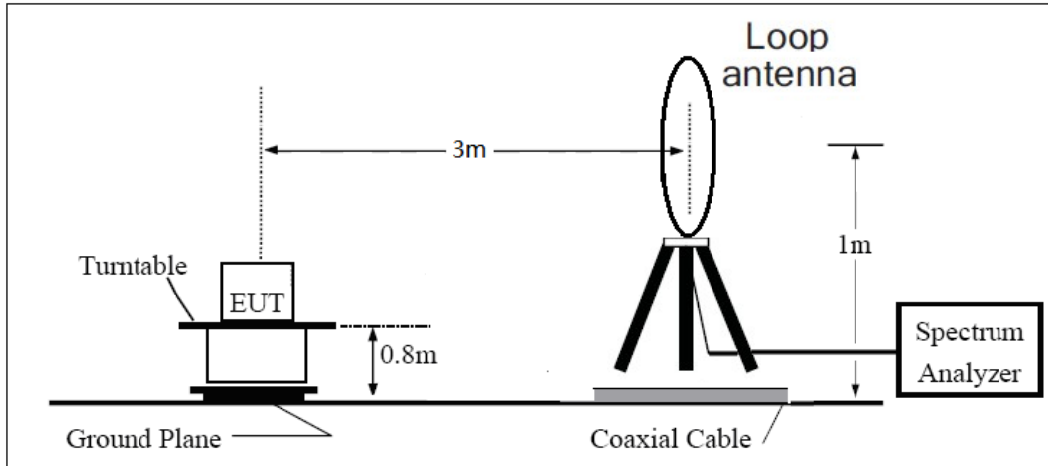

30MHz ~ 1GHz

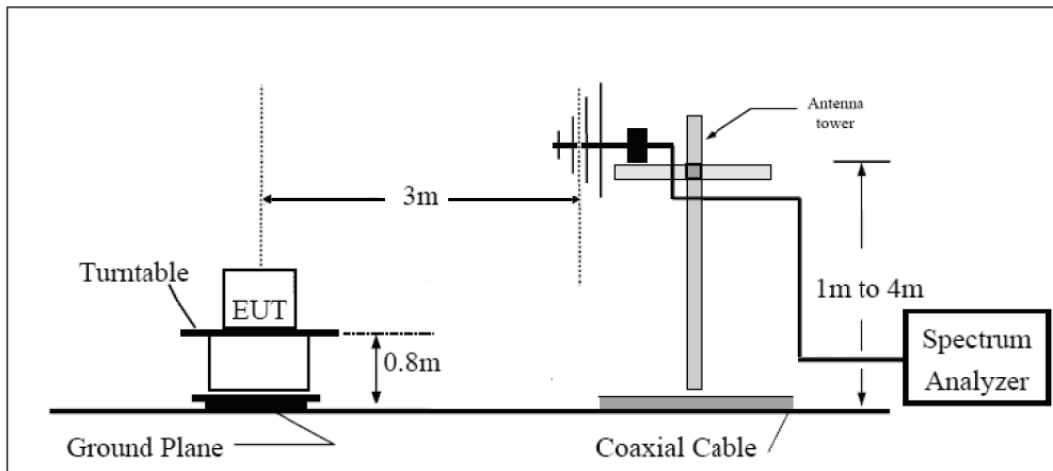

Above 1GHz

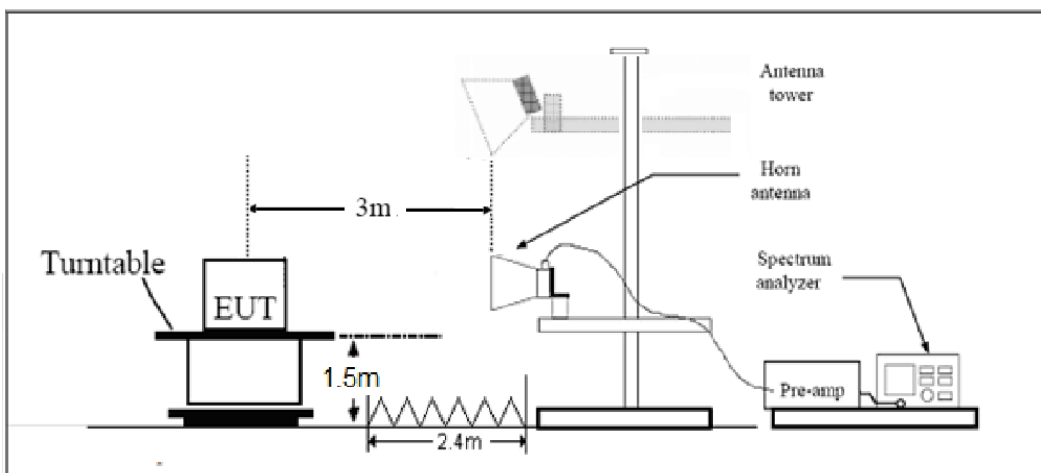

Note: Area side:2.4mX3.6m

Limits

LTE -12 Rule Part 27.53 (g) For operations in the 600 MHz band and the 698-746 MHz band, the power of any emission outside a licensee's frequency band(s) of operation shall be attenuated below the transmitter power (P) within the licensed band(s) of operation, measured in watts, by at least $43 + 10 \log (P)$ dB. Compliance with this provision is based on the use of measurement instrumentation employing a resolution bandwidth of 100 kilohertz or greater. However, in the 100 kilohertz bands immediately outside and adjacent to a licensee's frequency block, a resolution bandwidth of at least 30 kHz may be employed.

LTE -13 Rule Part 27.53(f) For operations in the 746-758 MHz, 775-788 MHz, and 805-806 MHz bands, emissions in the band 1559-1610 MHz shall be limited to -70 dBW/MHz equivalent isotropically radiated power (EIRP) for wideband signals, and -80 dBW EIRP for discrete emissions of less than 700 Hz bandwidth. For the purpose of equipment authorization, a transmitter shall be tested with an antenna that is representative of the type that will be used with the equipment in normal operation.

Part 27.53(g) Limit		-13 dBm
Part 27.53(f) Limit	Limit out of the band 1559-1610 MHz	-13 dBm
	Limit in the band 1559-1610 MHz	-40 dBm

Measurement Uncertainty

The assessed measurement uncertainty to ensure 95% confidence level for the normal distribution is with the coverage factor $k = \pm 1.96$, $U = \pm 3.55$ dB.

Test Result

The other Spurious RF Radiated emissions level is no more than noise floor.

The worst emission was found in the antenna is vertical position.

Standalone deployment with 15 KHz subcarrier spacing and QPSK mode for CAT NB1:

NB-IOT Band 12 QPSK CH-Low, RB 1

Harmonic	Frequency (MHz)	SG (dBm)	Cable Loss (dB)	Gain (dBi)	Antenna Polarization	ERP Level (dBm)	Limit (dBm)	Margin (dB)	Azimuth (deg)
2	1398.2	-50.31	2.00	10.15	Vertical	-44.31	-13.00	31.31	135
3	2097.3	-56.51	2.50	11.35	Vertical	-49.81	-13.00	36.81	225
4	2796.4	-54.04	4.20	10.85	Vertical	-49.54	-13.00	36.54	45
5	3495.5	-53.92	5.20	11.35	Vertical	-49.92	-13.00	36.92	180
6	4194.6	-52.38	5.50	11.95	Vertical	-48.08	-13.00	35.08	315
7	4893.7	-50.84	5.70	13.55	Vertical	-45.14	-13.00	32.14	45
8	5592.8	-49.93	6.30	13.75	Vertical	-44.63	-13.00	31.63	180
9	6291.9	-48.37	6.80	13.85	Vertical	-43.47	-13.00	30.47	315
10	6991.0	-46.90	6.90	14.25	Vertical	-41.70	-13.00	28.70	135

NB-IOT Band 12 QPSK CH-Middle, RB 1

Harmonic	Frequency (MHz)	SG (dBm)	Cable Loss (dB)	Gain (dBi)	Antenna Polarization	ERP Level (dBm)	Limit (dBm)	Margin (dB)	Azimuth (deg)
2	1415.0	-55.61	2.00	10.75	Vertical	-49.01	-13.00	36.01	225
3	2122.5	-56.87	2.51	11.05	Vertical	-50.48	-13.00	37.48	90
4	2830.0	-54.29	4.20	11.15	Vertical	-49.49	-13.00	36.49	180
5	3537.5	-54.30	5.20	11.15	Vertical	-50.50	-13.00	37.50	45
6	4245.0	-52.44	5.50	11.95	Vertical	-48.14	-13.00	35.14	180
7	4952.5	-49.98	5.70	13.55	Vertical	-44.28	-13.00	31.28	45
8	5660.0	-50.48	6.30	13.75	Vertical	-45.18	-13.00	32.18	0
9	6367.5	-48.06	6.80	13.85	Vertical	-43.16	-13.00	30.16	135
10	7075.0	-47.18	6.90	14.25	Vertical	-41.98	-13.00	28.98	225

NB-IOT Band 12 QPSK CH-High, RB 1

Harmonic	Frequency (MHz)	SG (dBm)	Cable Loss (dB)	Gain (dBi)	Antenna Polarization	ERP Level (dBm)	Limit (dBm)	Margin (dB)	Azimuth (deg)
2	1431.8	-58.45	2.00	10.15	Vertical	-52.45	-13.00	39.45	90
3	2147.7	-53.95	2.51	11.05	Vertical	-47.56	-13.00	34.56	225
4	2863.6	-55.13	4.20	11.15	Vertical	-50.33	-13.00	37.33	180
5	3579.5	-53.91	5.20	11.15	Vertical	-50.11	-13.00	37.11	270
6	4295.4	-52.74	5.50	11.95	Vertical	-48.44	-13.00	35.44	135
7	5011.3	-50.04	5.70	13.55	Vertical	-44.34	-13.00	31.34	45
8	5727.2	-50.21	6.30	13.75	Vertical	-44.91	-13.00	31.91	180
9	6443.1	-48.38	6.80	13.85	Vertical	-43.48	-13.00	30.48	315
10	7159.0	-47.32	6.90	14.25	Vertical	-42.12	-13.00	29.12	135

NB-IOT Band 13 QPSK CH-Low, RB 1

Harmonic	Frequency (MHz)	SG (dBm)	Cable Loss (dB)	Gain (dBi)	Antenna Polarization	ERP Level (dBm)	Limit (dBm)	Margin (dB)	Azimuth (deg)
2	1554.2	-59.12	2.00	10.15	Vertical	-53.12	-40.00	13.12	225
3	2331.3	-50.55	2.50	11.35	Vertical	-43.85	-13.00	30.85	90
4	3108.4	-55.25	4.20	10.85	Vertical	-50.75	-13.00	37.75	180
5	3885.5	-52.86	5.20	11.35	Vertical	-48.86	-13.00	35.86	45
6	4662.6	-51.24	5.50	11.95	Vertical	-46.94	-13.00	33.94	180
7	5439.7	-50.65	5.70	13.55	Vertical	-44.95	-13.00	31.95	45
8	6216.8	-50.18	6.30	13.75	Vertical	-44.88	-13.00	31.88	0
9	6993.9	-48.64	6.80	13.85	Vertical	-43.74	-13.00	30.74	135
10	7771.0	-46.08	6.90	14.25	Vertical	-40.88	-13.00	27.88	225

NB-IOT Band 13 QPSK CH-Middle, RB 1

Harmonic	Frequency (MHz)	SG (dBm)	Cable Loss (dB)	Gain (dBi)	Antenna Polarization	ERP Level (dBm)	Limit (dBm)	Margin (dB)	Azimuth (deg)
2	1564.0	-59.31	2.00	10.75	Vertical	-52.71	-40.00	12.71	90
3	2346.0	-50.01	2.51	11.05	Vertical	-43.62	-13.00	30.62	225
4	3128.0	-54.55	4.20	11.15	Vertical	-49.75	-13.00	36.75	180
5	3910.0	-52.16	5.20	11.15	Vertical	-48.36	-13.00	35.36	270
6	4692.0	-51.25	5.50	11.95	Vertical	-46.95	-13.00	33.95	135
7	5474.0	-50.56	5.70	13.55	Vertical	-44.86	-13.00	31.86	45
8	6256.0	-49.95	6.30	13.75	Vertical	-44.65	-13.00	31.65	180
9	7038.0	-48.28	6.80	13.85	Vertical	-43.38	-13.00	30.38	315
10	7820.0	-45.08	6.90	14.25	Vertical	-39.88	-13.00	26.88	135

NB-IOT Band 13 QPSK CH-High, RB 1

Harmonic	Frequency (MHz)	SG (dBm)	Cable Loss (dB)	Gain (dBi)	Antenna Polarization	ERP Level (dBm)	Limit (dBm)	Margin (dB)	Azimuth (deg)
2	1573.8	-60.27	2.00	10.15	Vertical	-54.27	-40.00	14.27	225
3	2360.7	-49.96	2.51	11.05	Vertical	-43.57	-13.00	30.57	90
4	3147.6	-54.03	4.20	11.15	Vertical	-49.23	-13.00	36.23	180
5	3934.5	-51.84	5.20	11.15	Vertical	-48.04	-13.00	35.04	45
6	4721.4	-51.17	5.50	11.95	Vertical	-46.87	-13.00	33.87	180
7	5508.3	-50.57	5.70	13.55	Vertical	-44.87	-13.00	31.87	45
8	6295.2	-49.67	6.30	13.75	Vertical	-44.37	-13.00	31.37	0
9	7082.1	-47.97	6.80	13.85	Vertical	-43.07	-13.00	30.07	135
10	7869.0	-44.89	6.90	14.25	Vertical	-39.69	-13.00	26.69	225

6 Main Test Instruments

Name	Manufacturer	Type	Serial Number	Calibration Date	Expiration Time
Base Station Simulator	R&S	CMW500	150415	2017-05-14	2018-05-13
Power Splitter	Hua Xiang	SHX-GF2-2-13	10120101	2017-05-14	2018-05-13
Universal Radio Communication Tester	Agilent	E5515C	MY48367192	2017-05-14	2018-05-13
Spectrum Analyzer	Agilent	N9010A	MY47191109	2017-05-14	2018-05-13
Signal Analyzer	R&S	FSV30	100815	2016-12-16	2017-12-15
Signal generator	R&S	SMB 100A	102594	2017-05-14	2018-05-13
EMI Test Receiver	R&S	ESCI	100948	2017-05-20	2018-05-19
Trilog Antenna	SCHWARZBECK	VUBL 9163	9163-201	2014-12-06	2017-12-05
Horn Antenna	R&S	HF907	100126	2014-12-06	2017-12-05
Horn Antenna	ETS-Lindgren	3160-09	00102643	2015-01-30	2018-01-29
Climatic Chamber	Re Ce	PT-30B	20101891	2015-07-18	2018-07-17
RF Cable	Agilent	SMA 15cm	0001	2017-02-06	2017-08-05
Preamplifier	R&S	SCU18	102327	2017-06-18	2018-06-17

ANNEX A: EUT Appearance and Test Setup

A.1 EUT Appearance



shielding



No shielding
Front Side

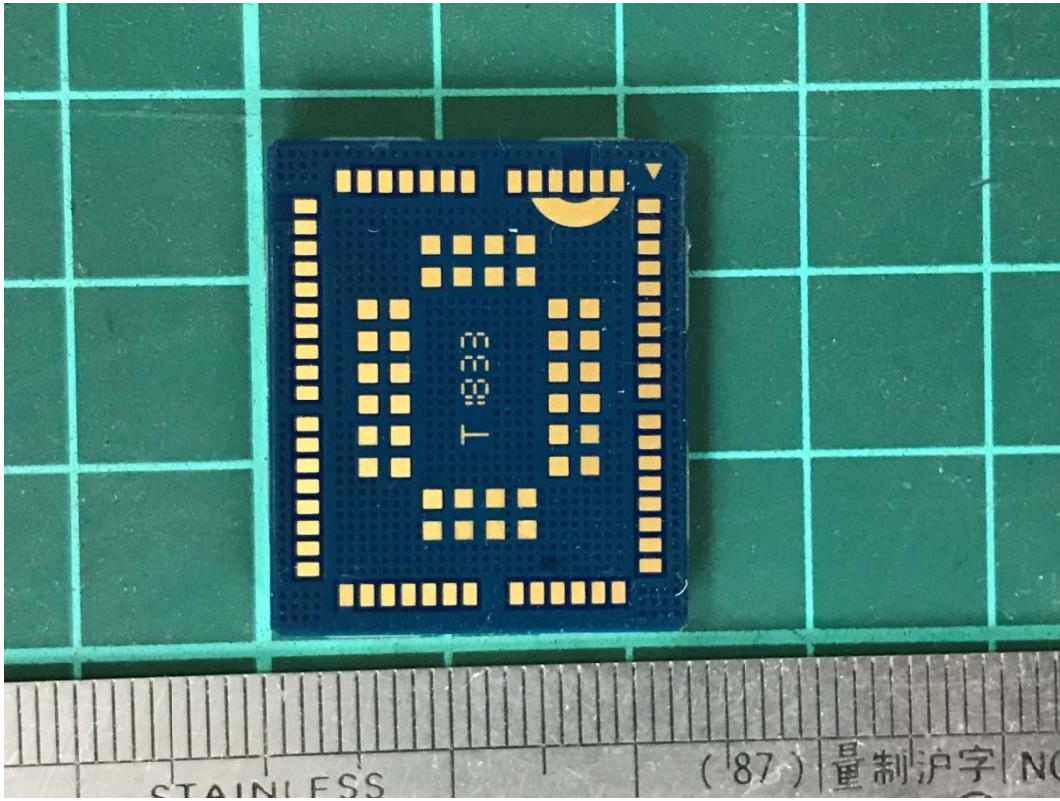

Back Side
a: EUT
Picture 1 EUT

A.2 Test Setup

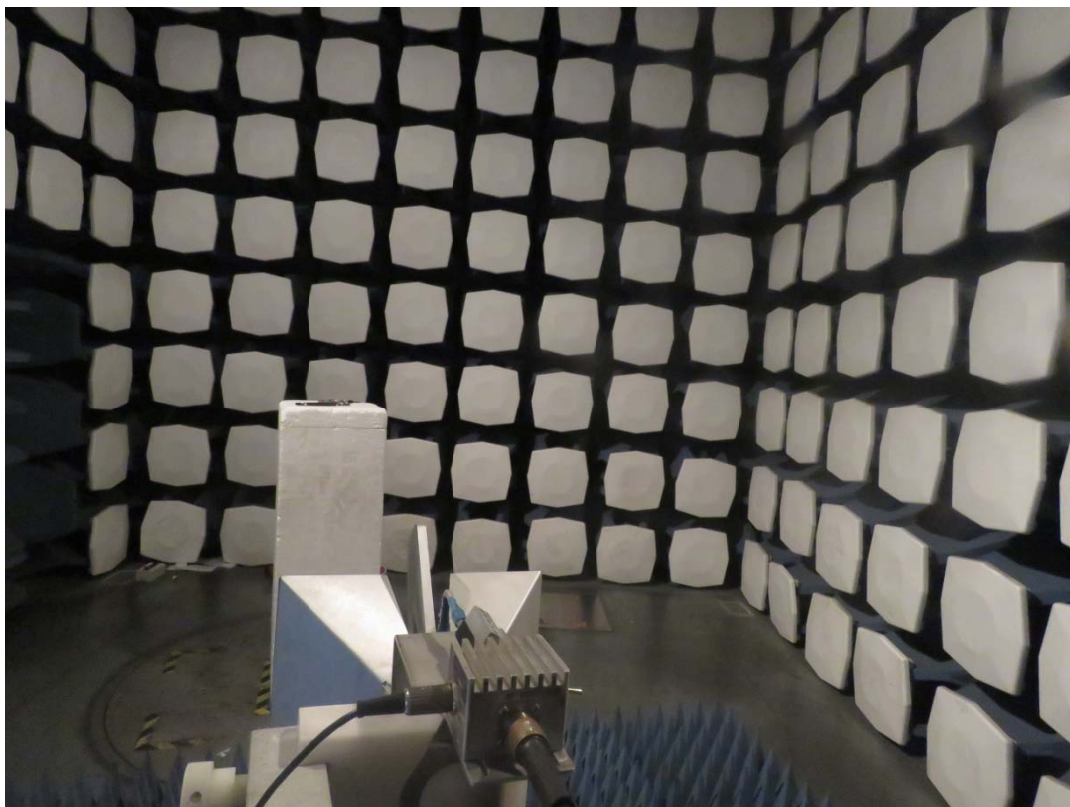
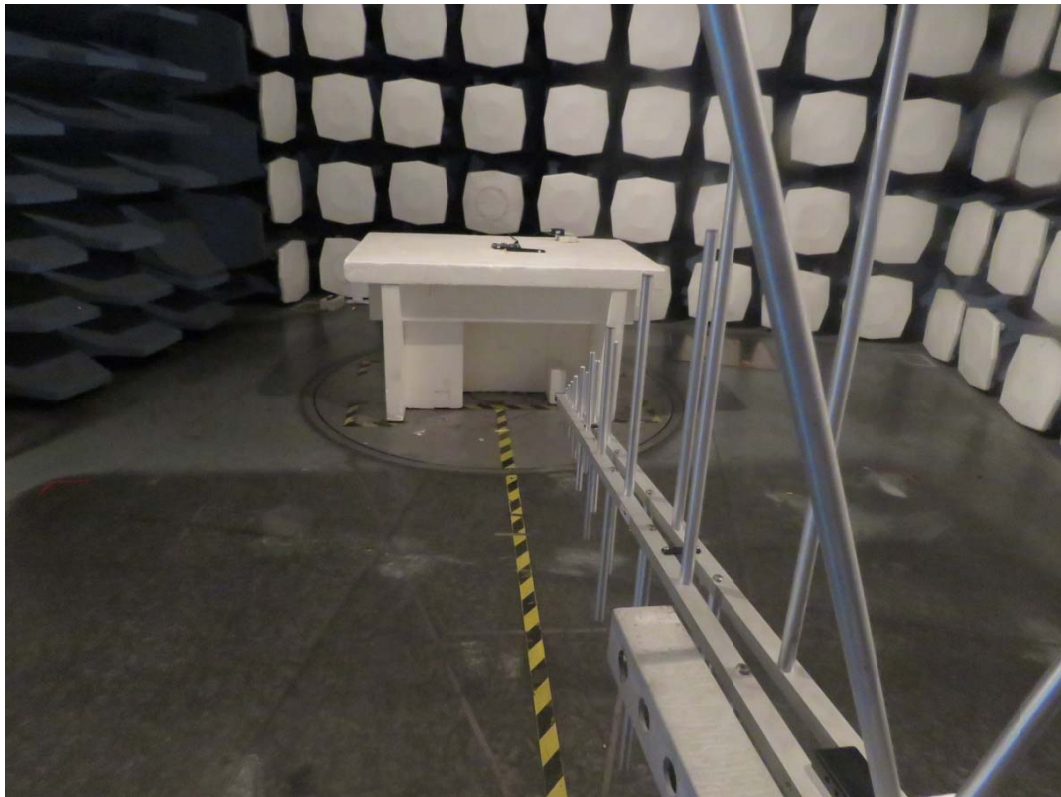

Picture 2: Radiated Spurious Emissions Test setup

ANNEX B: Product Change Description



BG96 R1.1 & BG96 R1.2 Differences Statement

LTE Module Series

PCB Rev.: R1.2

Date: 2018-10-08



www.quectel.com

Build a Smarter World



Based on BG96 R1.1, BG96 R1.2 has enabled VDD_QFPROM_PRG hardware interface, which is connected to ground directly in BG96 R1.1, so as to support secure boot feature.

Some points are highlighted as below:

- BG96 R1.1 and R1.2 versions share the same hardware architecture and key components.
- BG96 R1.1 and R1.2 versions share the same pinout placements.
- Secure boot is enabled through a set of hardware fuses in BG96 R1.2. For the code to be executed, it must be signed by the trusted entity identified in the hardware fuses, so we have to enable VDD_QFPROM_PRG hardware interface.
- The new hardware will be used with the new software baseline TX3.0, and the software version is R04Axx.

The details are illustrated as below:

1. What's Secure Boot

Secure boot refers to the bootup sequence that establishes a trusted platform for secure applications. It starts as an immutable sequence that validates the origin of the code using cryptographic authentication so only authorized software can be executed. The bootup sequence places the device in a known security state and protects against binary manipulation of software and reflashing attacks.

A secure boot system adds cryptographic checks to each stage of the boot up process. This process asserts the authenticity of all secure software images that are executed by the device. This additional check prevents any unauthorized or maliciously modified software from running on the device. Secure boot is enabled through a set of hardware fuses. For the code to be executed, it must be signed by the trusted entity identified in the hardware fuses.

In simple terms, secure boot ensures running of signed/authorized software on the module, and unsigned/unauthorized software will not be allowed to run.

2. Enabled VDD_QFPROM_PRG Hardware Interface

A. BG96 R1.1 does not support secure boot function

The VDD_QFPROM_PRG (N19) pin of baseband chip is for secure boot function. In BG96 R1.1, this pin is connected to ground directly, which means secure boot function is disabled.

B. BG96 R1.2 supports secure boot function

According to Qualcomm's suggestion and our customers' requirements, the VDD_QFPROM_PRG pin is connected to VREG_L3_1P8(1.8V) in BG96 R1.2 so as to enable secure boot function.

The following pictures show the schematic and PCB designs of BG96 R1.1 and R1.2.

Build a Smarter World



Figure 1: Schematic Designs of BG96 R1.1 and R1.2

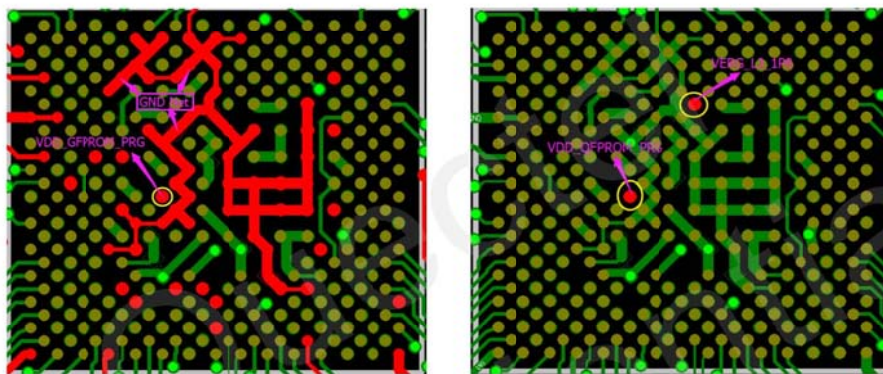

Figure 2: PCB Designs of BG96 R1.1 and R1.2

3. TX2.0 vs TX3.0

The biggest difference of TX3.0 as compared with TX2.0 lies in the adding of VoLTE and handover features. Since VoLTE environment has not been built so maturely yet, the main concern of customers is the handover function.

For TX2.0, re-selection is supported, while handover is not supported.

BG96 supports re-selection mechanism, which means when disconnection happens during cell handover, the module will reconnect automatically. This process lasts for about 1 (or 2) seconds, and the data transmitted (may happen by coincidence) will be buffered and resent once the reconnection established. So, the disconnection is generally imperceptible to customers.

- If the data transmission occurs at the moment that cell handover occurs coincidentally, the connection is kept with handover function; the connection is broken and re-connection established in about 1 (or 2) seconds with re-selection. This causes nearly no difference for data telematics because users even cannot feel this disconnection, whereas VoLTE might be affected because of the short time disconnection.



Build a Smarter World



- If the data transmission occurs in the period that no cell alternates, then no any influence will be caused.

Quectel
Confidential

