

LTE Band 25 1.4MHz 16QAM 1RB CH-Low

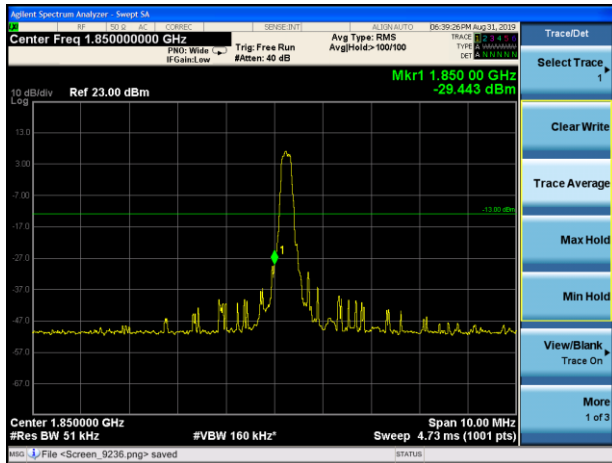

LTE Band 25 1.4MHz 16QAM 1RB CH-High

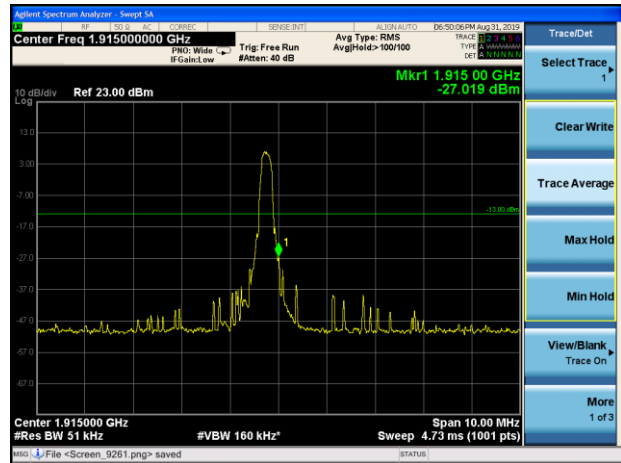

LTE Band 25 1.4MHz 16QAM 100%RB CH-Low

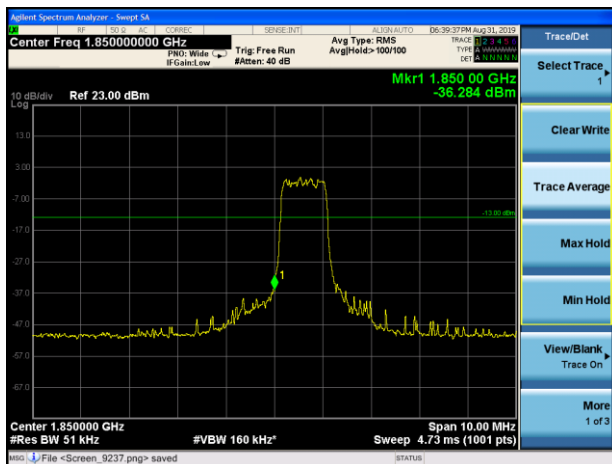

LTE Band 25 1.4MHz 16QAM 100%RB CH-High

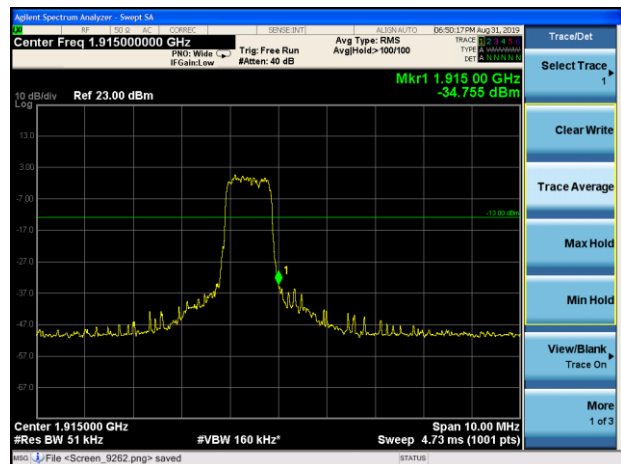

LTE Band 25 3MHz 16QAM 1RB CH-Low

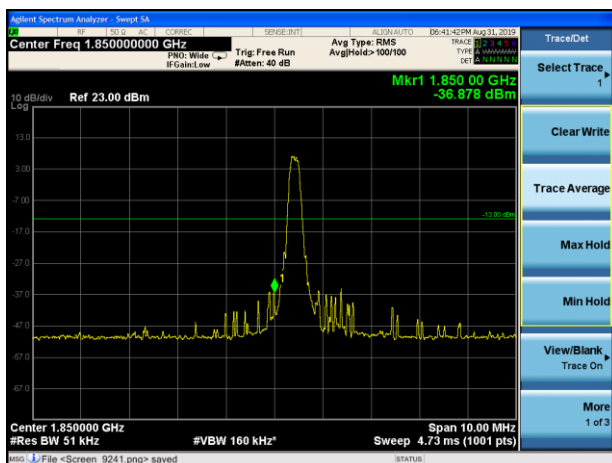

LTE Band 25 3MHz 16QAM 1RB CH-High

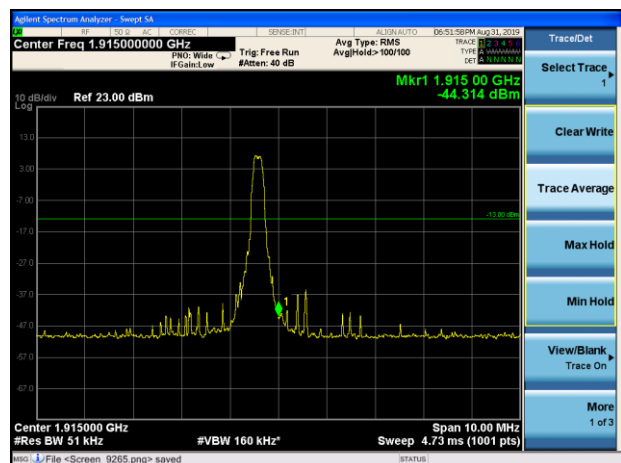



LTE Band 25 3MHz 16QAM 100%RB CH-Low

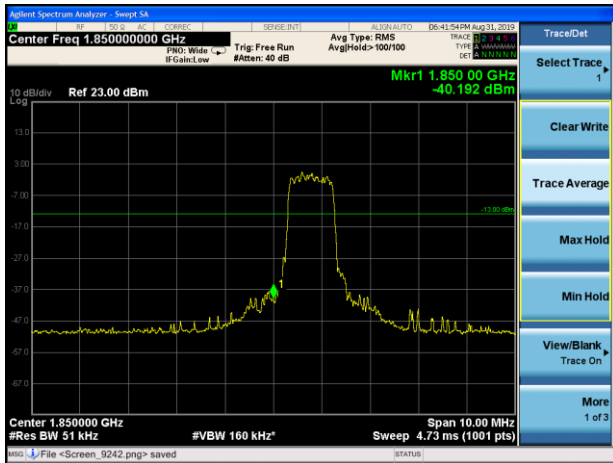

LTE Band 25 3MHz 16QAM 100%RB CH-High

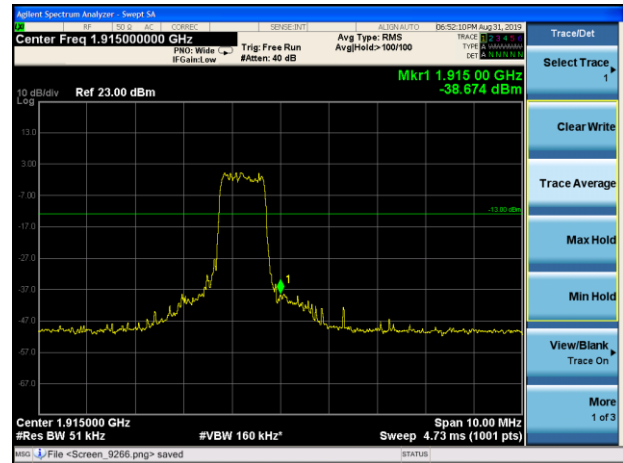

LTE Band 25 5MHz 16QAM 1RB CH-Low

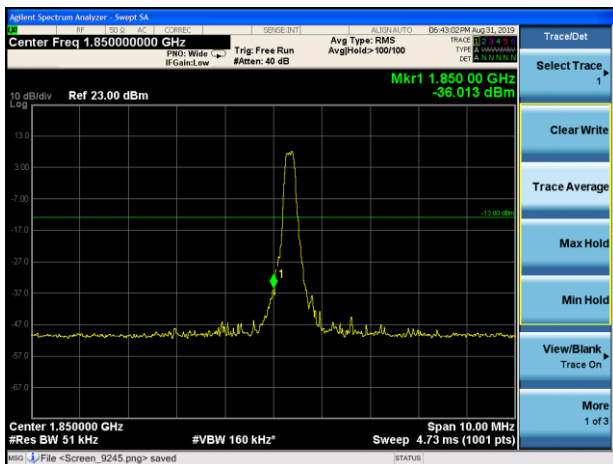

LTE Band 25 5MHz 16QAM 1RB CH-High

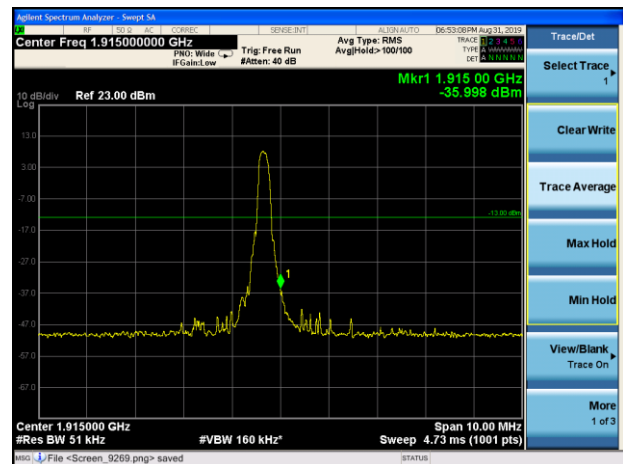

LTE Band 25 5MHz 16QAM 100%RB CH-Low

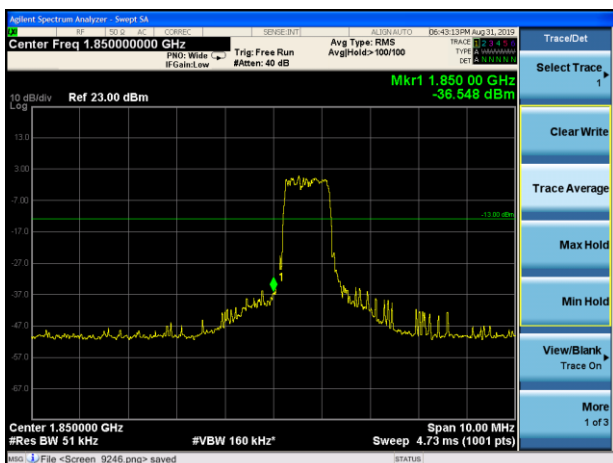

LTE Band 25 5MHz 16QAM 100%RB CH-High

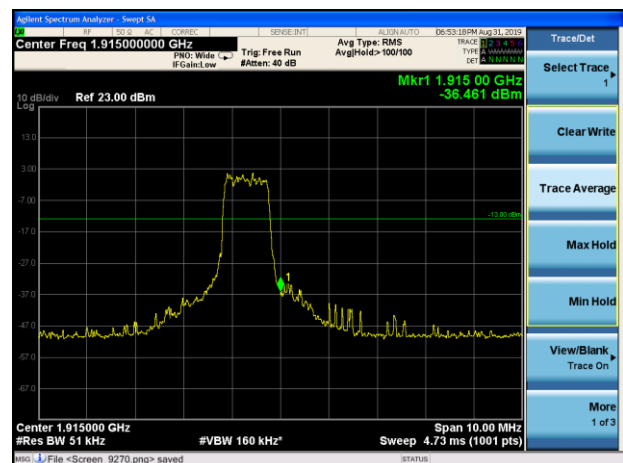



LTE Band 25 10MHz 16QAM 1RB CH-Low

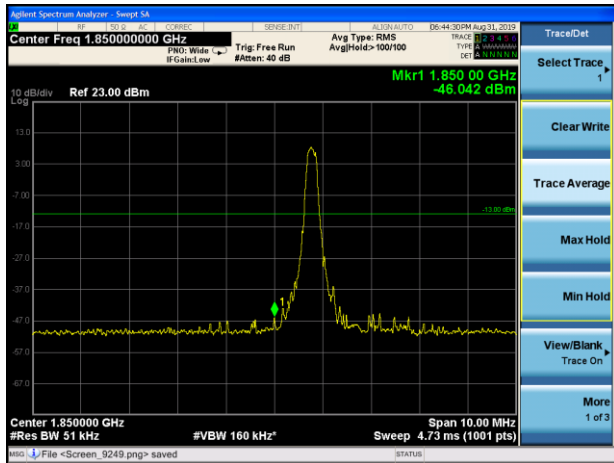

LTE Band 25 10MHz 16QAM 1RB CH-High

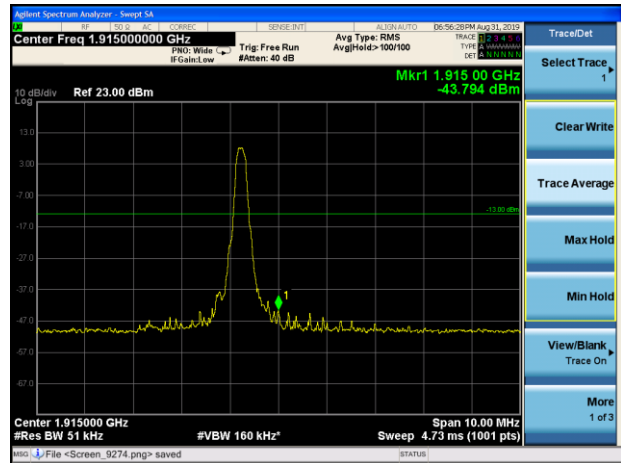

LTE Band 25 10MHz 16QAM 100%RB CH-Low

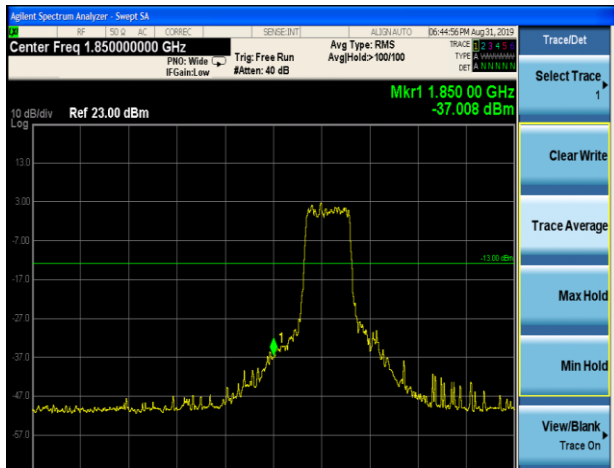

LTE Band 25 10MHz 16QAM 100%RB CH-High

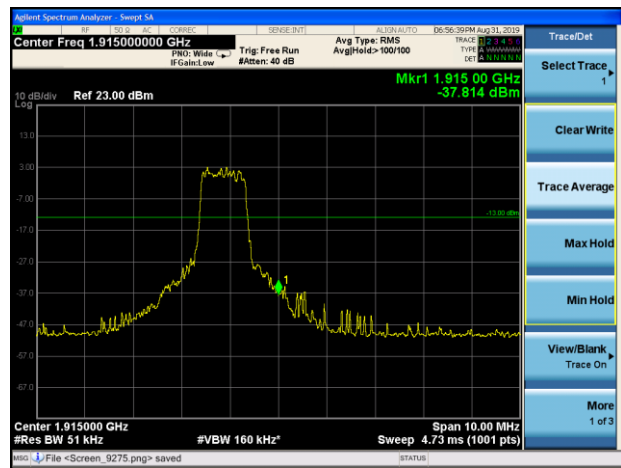

LTE Band 25 15MHz 16QAM 1RB CH-Low

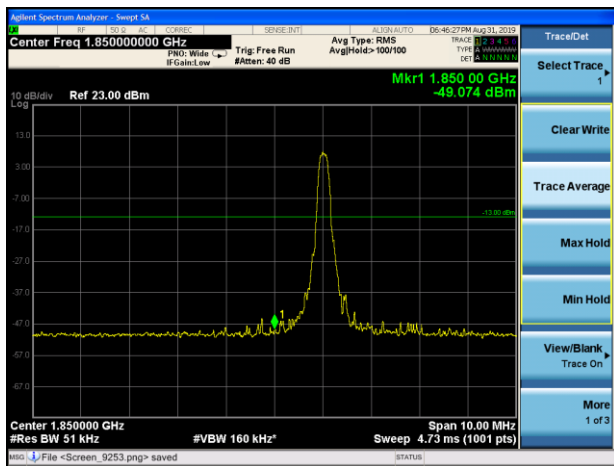

LTE Band 25 15MHz 16QAM 1RB CH-High

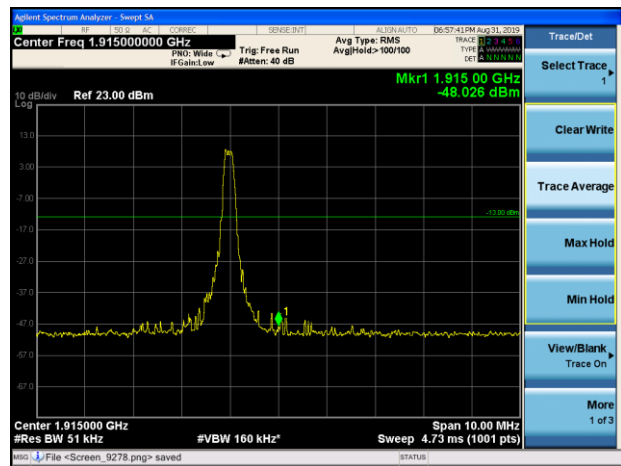



LTE Band 25 15MHz 16QAM 100%RB CH-Low

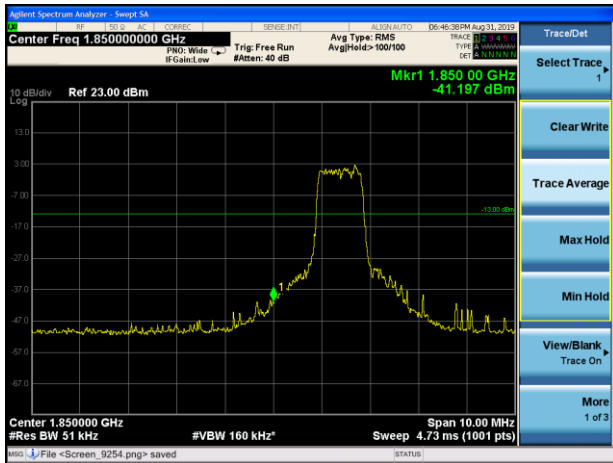

LTE Band 25 15MHz 16QAM 100%RB CH-High

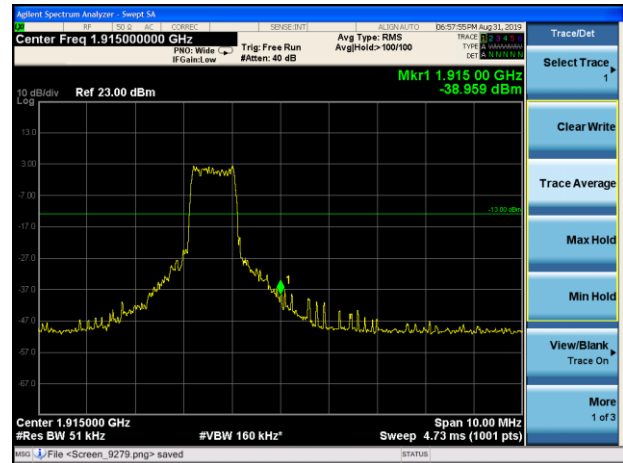

LTE Band 25 20MHz 16QAM 1RB CH-Low

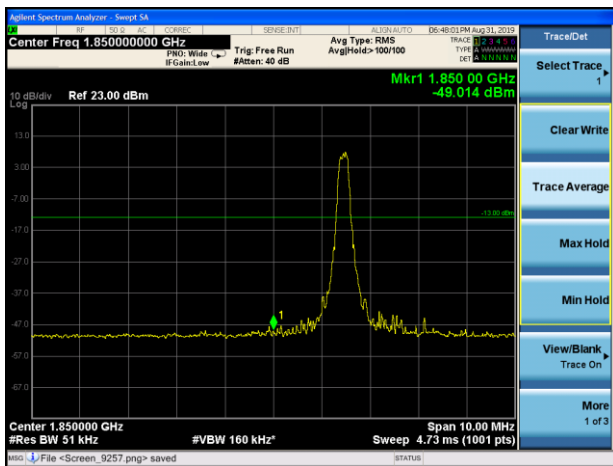

LTE Band 25 20MHz 16QAM 1RB CH-High

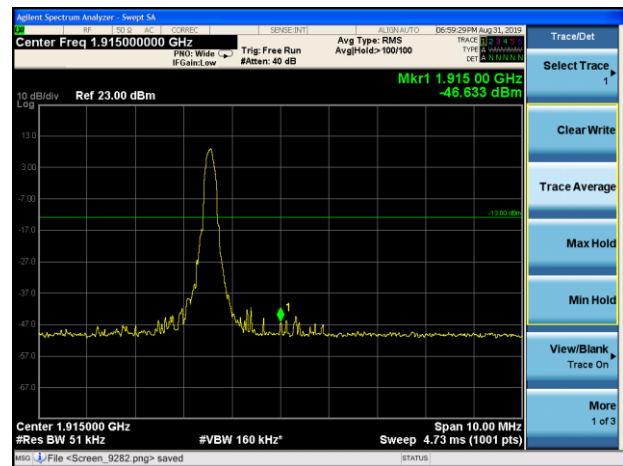

LTE Band 25 20MHz 16QAM 100%RB CH-Low

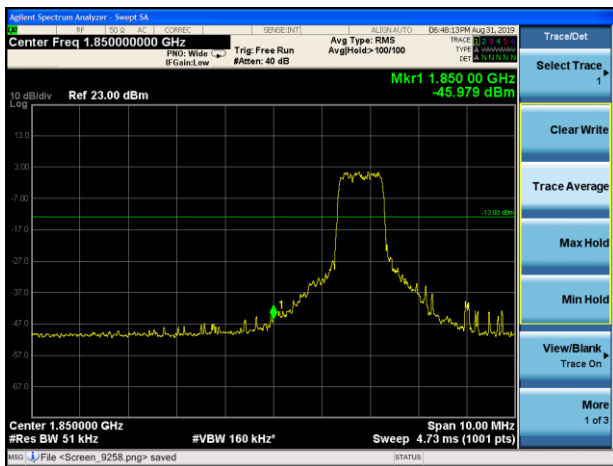

LTE Band 25 20MHz 16QAM 100%RB CH-High

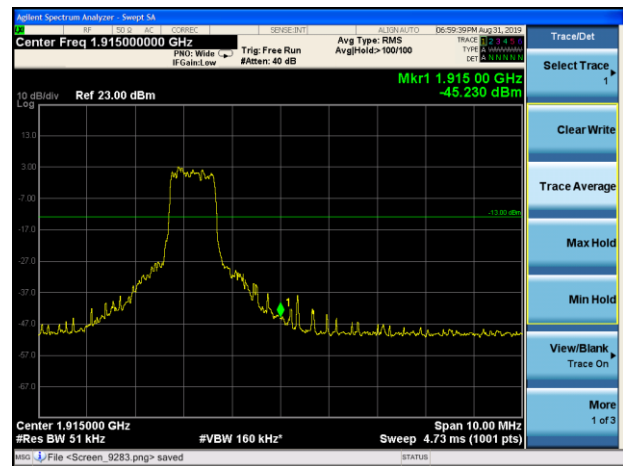

5.5. Peak-to-Average Power Ratio (PAPR)

Ambient condition

Temperature	Relative humidity	Pressure
23°C ~25°C	45%~50%	101.5kPa

Methods of Measurement

Measure the total peak power and record as PPk. And measure the total average power and record as PAvg. Both the peak and average power levels must be expressed in the same logarithmic units (e.g., dBm). Determine the PAPR from:

$$PAPR (dB) = PPk (dBm) - PAvg (dBm).$$

Test Setup

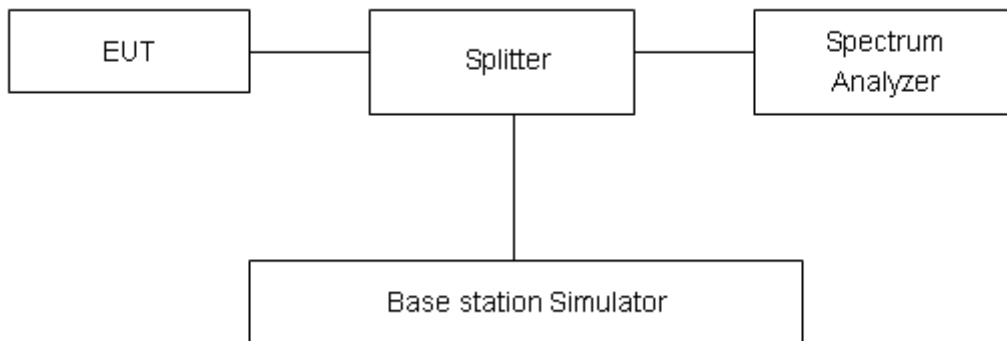

Limits

In measuring transmissions in this band using an average power technique, the peak-to-average ratio (PAR) of the transmission may not exceed 13 dB in 24.232(d).

Measurement Uncertainty

The assessed measurement uncertainty to ensure 95% confidence level for the normal distribution is with the coverage factor $k = 2$, $U = 0.4$ dB.



Test Results

Mode	Channel	Frequency (MHz)	Peak(dBm)	Avg(dBm)	PAPR(dB)	Limit(dB)	Conclusion
GSM 1900 (GMSK)	512	1850.2	30.40	28.73	1.67	≤13	PASS
	661	1880	30.21	28.62	1.59	≤13	PASS
	810	1909.8	30.15	28.41	1.74	≤13	PASS
GPRS 1900 (GMSK)	512	1850.2	30.43	28.71	1.72	≤13	PASS
	661	1880	30.23	28.55	1.68	≤13	PASS
	810	1909.8	29.92	28.28	1.64	≤13	PASS
EGPRS 1900 (8-PSK)	512	1850.2	27.67	25.14	2.53	≤13	PASS
	661	1880	27.85	25.21	2.64	≤13	PASS
	810	1909.8	27.68	25.01	2.67	≤13	PASS

Mode	Bandwidth	Modulation	Channel/ Frequency(MHz)	Peak-to-Average Power Ratio (PAPR)		
				Peak(dBm)	Avg(dBm)	PAPR(dB)
Band2	1.4MHz	QPSK	18900/1880	23.36	13.73	9.63
		16QAM	18900/1880	23.92	13.75	10.17
	3MHz	QPSK	18900/1880	23.26	13.74	9.52
		16QAM	18900/1880	23.88	13.03	10.85
	5MHz	QPSK	18900/1880	24.05	14.56	9.49
		16QAM	18900/1880	24.62	14.54	10.08
	10MHz	QPSK	18900/1880	23.99	14.37	9.62
		16QAM	18900/1880	25.06	16.22	8.84
	15MHz	QPSK	18900/1880	24.59	15.69	8.90
		16QAM	18900/1880	24.99	15.36	9.63
	20MHz	QPSK	18900/1880	24.60	15.11	9.49
		16QAM	18900/1880	25.02	16.11	8.91

Mode	Bandwidth	Modulation	Channel/ Frequency(MHz)	Peak-to-Average Power Ratio (PAPR)		
				Peak(dBm)	Avg(dBm)	PAPR(dB)
Ban25	1.4MHz	QPSK	26365/1882.5	23.50	13.88	9.62
		16QAM	26365/1882.5	24.03	13.62	10.41
	3MHz	QPSK	26365/1882.5	23.24	11.62	11.62
		16QAM	26365/1882.5	23.97	11.71	12.26
	5MHz	QPSK	26365/1882.5	24.06	14.27	9.79
		16QAM	26365/1882.5	24.62	14.80	9.82
	10MHz	QPSK	26365/1882.5	23.99	14.60	9.39
		16QAM	26365/1882.5	24.95	15.52	9.43



	15MHz	QPSK	26365/1882.5	24.56	14.95	9.61
		16QAM	26365/1882.5	24.96	15.05	9.91
	20MHz	QPSK	26365/1882.5	24.43	15.57	8.86
		16QAM	26365/1882.5	24.84	15.30	9.54

5.6. Frequency Stability

Ambient condition

Temperature	Relative humidity	Pressure
23°C ~25°C	45%~50%	101.5kPa

Method of Measurement

Frequency Stability (Temperature Variation)

The temperature inside the climate chamber is varied from -40°C to +85°C in 10°C step size,

(1) With all power removed, the temperature was decreased to 0°C and permitted to stabilize for three hours.

(2) Measure the carrier frequency with the test equipment in a “call mode”. These measurements should be made within 1 minute of powering up the mobile station, to prevent significant self warming.

(3) Repeat the above measurements at 10°C increments from -40°C to +85°C. Allow at least 1.5 hours at each temperature, un-powered, before making measurements.

Frequency Stability (Voltage Variation)

The frequency stability shall be measured with variation of primary supply voltage as follows:

(1) Vary primary supply voltage from 85 to 115 percent of the nominal value for other than hand carried battery equipment.

(2) For hand carried, battery powered equipment, reduce primary supply voltage to the battery-operating end point which shall be specified by the manufacturer.

This transceiver is specified to operate with an input voltage of between 3.3 V and 4.3 V, with a nominal voltage of 3.8V.

Test setup

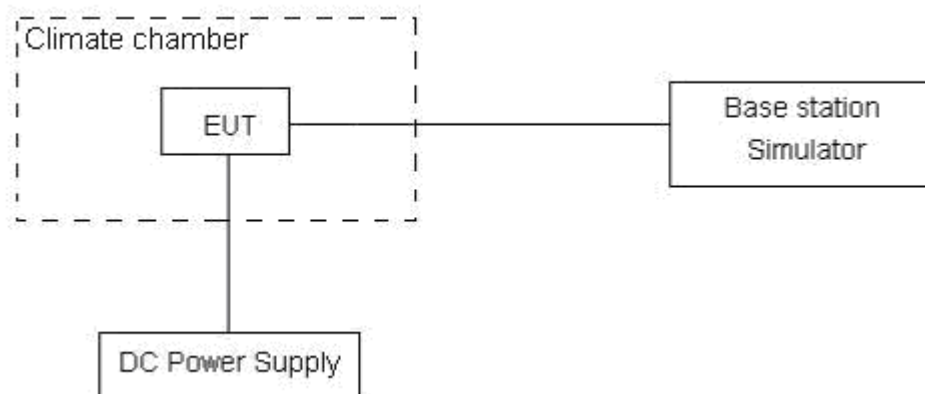

Limits

The frequency stability shall be sufficient to ensure that the fundamental emission stays within the authorized frequency block

Measurement Uncertainty

The assessed measurement uncertainty to ensure 99.75% confidence level for the normal distribution is with the coverage factor $k = 3$, $U = 0.01\text{ppm}$.

Test Result

GSM1900						
Condition		Freq.Error (Hz)	Freq.Error (Hz)	Frequency Stability (ppm)	Frequency Stability (ppm)	Verdict
Temperature	Voltage	GMSK	8PSK	GMSK	8PSK	
Normal (25°C)	Normal	7.96	11.67	0.00424	0.00621	PASS
Extreme (85°C)		2.59	7.86	0.00138	0.00418	PASS
Extreme (80°C)		7.62	13.45	0.00405	0.00715	PASS
Extreme (70°C)		7.72	3.88	0.00411	0.00206	PASS
Extreme (60°C)		11.31	14.29	0.00602	0.00760	PASS
Extreme (50°C)		16.67	10.91	0.00886	0.00581	PASS
Extreme (40°C)		4.44	2.90	0.00236	0.00154	PASS
Extreme (30°C)		16.38	7.16	0.00871	0.00381	PASS
Extreme (20°C)		13.06	4.76	0.00695	0.00253	PASS
Extreme (10°C)		7.24	7.71	0.00385	0.00410	PASS
Extreme (0°C)		16.08	17.30	0.00855	0.00920	PASS
Extreme (-10°C)		1.85	6.64	0.00099	0.00353	PASS
Extreme (-20°C)		5.91	11.66	0.00314	0.00620	PASS
Extreme (-30°C)		14.94	12.70	0.00795	0.00676	PASS
Extreme (-40°C)		1.68	3.52	0.00089	0.00187	PASS
25°C	LV	4.16	13.90	0.00221	0.00740	PASS
	HV	3.31	2.62	0.00176	0.00139	PASS

LTE Band 2						
Condition		Freq.Error (Hz)	Freq.Error (Hz)	Frequency Stability (ppm)	Frequency Stability (ppm)	Verdict
BANDWIDTH	20MHz					
Temperature	Voltage	16QAM	QPSK	16QAM	QPSK	
Normal (25°C)	Normal	8.75	1.16	0.00465	0.00062	PASS
Extreme (85°C)		3.01	2.15	0.00160	0.00114	PASS
Extreme (80°C)		5.60	17.72	0.00298	0.00942	PASS
Extreme (70°C)		1.21	15.85	0.00064	0.00843	PASS
Extreme (60°C)		13.32	2.66	0.00708	0.00141	PASS
Extreme (50°C)		17.90	13.21	0.00952	0.00703	PASS
Extreme (40°C)		17.38	10.04	0.00924	0.00534	PASS
Extreme (30°C)		6.20	1.75	0.00330	0.00093	PASS
Extreme (20°C)		16.72	12.64	0.00889	0.00672	PASS
Extreme (10°C)		5.22	1.40	0.00278	0.00074	PASS
Extreme (0°C)		14.28	11.08	0.00760	0.00589	PASS
Extreme (-10°C)		7.16	2.02	0.00381	0.00107	PASS



Extreme (-20°C)		2.20	11.62	0.00117	0.00618	PASS
Extreme (-30°C)		5.59	3.38	0.00297	0.00180	PASS
Extreme (-40°C)		2.24	15.61	0.00119	0.00830	PASS
25°C	LV	1.99	14.97	0.00106	0.00796	PASS
	HV	5.45	10.06	0.00290	0.00535	PASS

LTE Band 25						
Condition		Freq.Error (Hz)	Freq.Error (Hz)	Frequency Stability (ppm)	Frequency Stability (ppm)	Verdict
BANDWIDTH	20MHz					
Temperature	Voltage	16QAM	QPSK	16QAM	QPSK	
Normal (25°C)	Normal	12.24	9.82	0.00651	0.00522	PASS
Extreme (85°C)		9.78	1.98	0.00520	0.00105	PASS
Extreme (80°C)		6.14	11.34	0.00326	0.00603	PASS
Extreme (70°C)		1.72	8.51	0.00091	0.00453	PASS
Extreme (60°C)		5.32	2.65	0.00283	0.00141	PASS
Extreme (50°C)		15.72	13.77	0.00836	0.00732	PASS
Extreme (40°C)		1.48	17.95	0.00079	0.00955	PASS
Extreme (30°C)		1.00	1.18	0.00053	0.00063	PASS
Extreme (20°C)		4.05	15.02	0.00215	0.00799	PASS
Extreme (10°C)		15.05	1.07	0.00800	0.00057	PASS
Extreme (0°C)		4.29	6.01	0.00228	0.00320	PASS
Extreme (-10°C)		1.80	11.80	0.00096	0.00628	PASS
Extreme (-20°C)		11.65	6.45	0.00620	0.00343	PASS
Extreme (-30°C)		5.29	11.53	0.00282	0.00613	PASS
Extreme (-40°C)		9.61	15.16	0.00511	0.00806	PASS
25°C	LV	8.93	8.97	0.00475	0.00477	PASS
	HV	3.20	1.90	0.00170	0.00101	PASS

5.7. Spurious Emissions at Antenna Terminals

Ambient condition

Temperature	Relative humidity	Pressure
23°C ~25°C	45%~50%	101.5kPa

Method of Measurement

The EUT was connected to Spectrum Analyzer and Base Station Simulator via power Splitter. The measurement is carried out using a spectrum analyzer. The spectrum analyzer scans from 9kHz to the 10th harmonic of the carrier. The peak detector is used.

RBW is set to 100kHz, VBW is set to 300kHz for 30MHz~1GHz

RBW is set to 1MHz, VBW is set to 3MHz for above 1GHz, Sweep is set to ATUO.

The modulation mode and RB allocation refer to section 5.1, using the maximum output power configuration.

Test setup

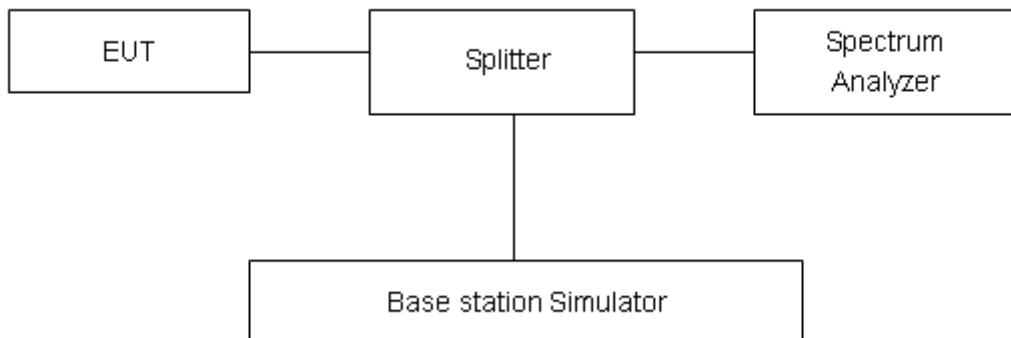

Limits

Rule Part 24.238(a) specifies that “on any frequency outside a licensee's frequency block, the power of any emission shall be attenuated below the transmitter power (P) by at least 43 + 10 log₁₀ (P) dB.”

Limit	-13 dBm
-------	---------

Measurement Uncertainty

The assessed measurement uncertainty to ensure 99.75% confidence level for the normal distribution is with the coverage factor $k = 1.96$.

Frequency	Uncertainty
30MHz-1GHz	0.684 dB
1GHz-20GHz	1.407 dB



Test Result

Sweep the whole frequency band through the range from 9kHz to the 10th harmonic of the carrier, the emissions more than 20 dB below the limit are not reported.

The signal beyond the limit is carrier.

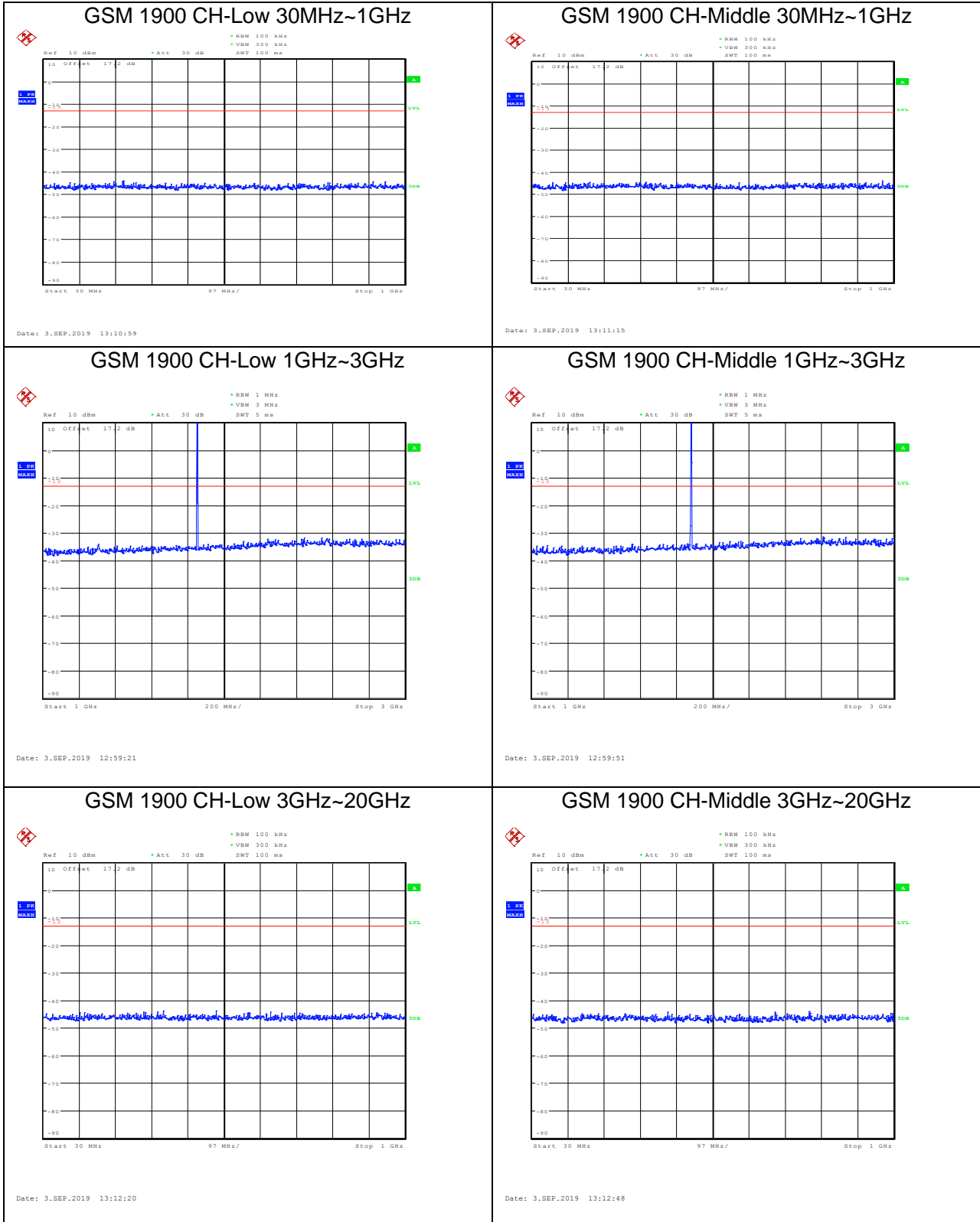



GSM 1900 CH-High 30MHz~1GHz

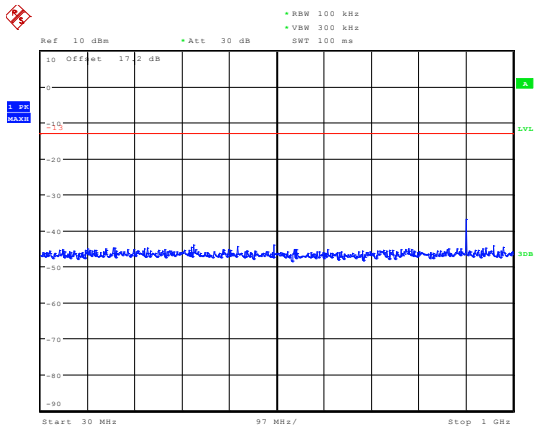

Date: 3.SEP.2019 13:11:38

GSM 1900 CH-High 1GHz~3GHz

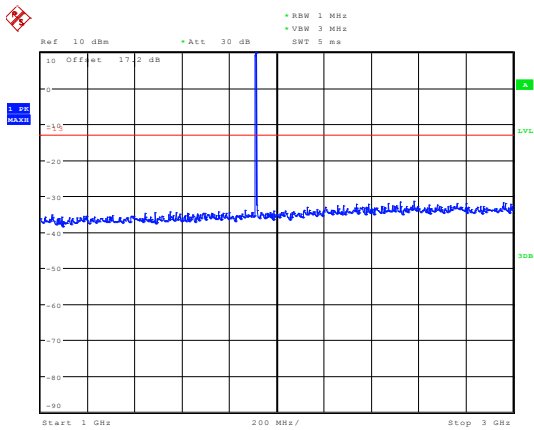

Date: 3.SEP.2019 13:00:31

GSM 1900 CH-High 3GHz~20GHz

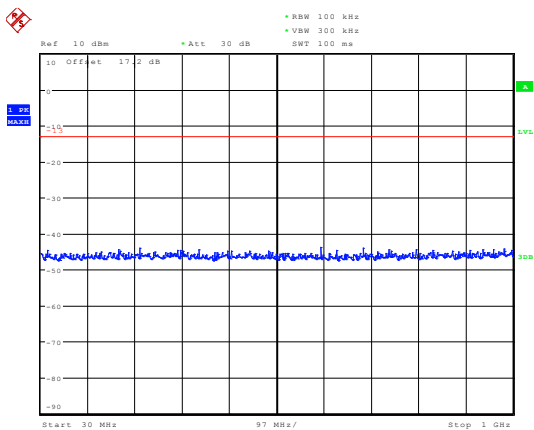

Date: 3.SEP.2019 13:13:18



LTE Band 2 1.4MHz CH-Low 30MHz~1GHz

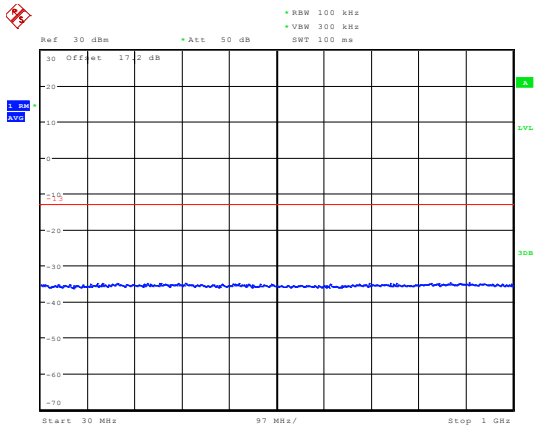

Date: 19.AUG.2019 16:04:48

LTE Band 2 1.4MHz CH-Middle 30MHz~1GHz

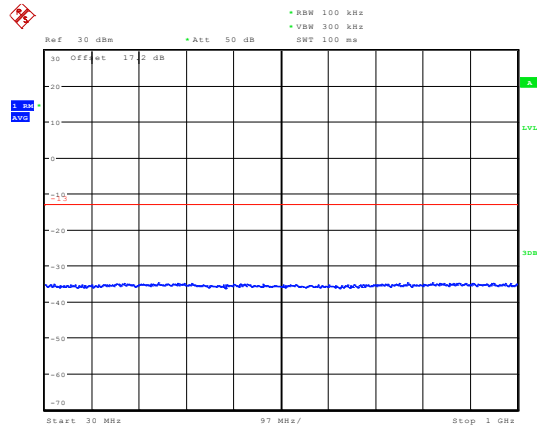

Date: 19.AUG.2019 16:09:56

LTE Band 2 1.4MHz CH-Low 1GHz~3GHz

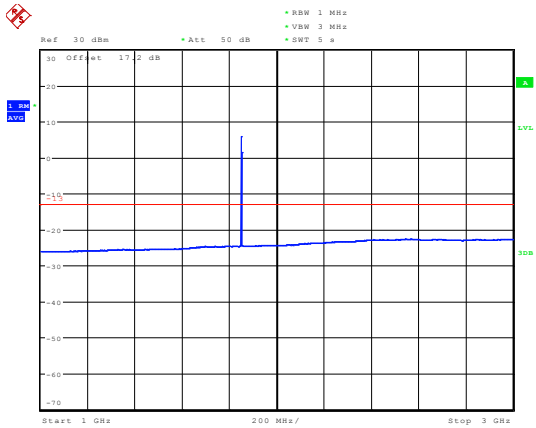

Date: 21.AUG.2019 16:36:19

LTE Band 2 1.4MHz CH-Middle 1GHz~3GHz

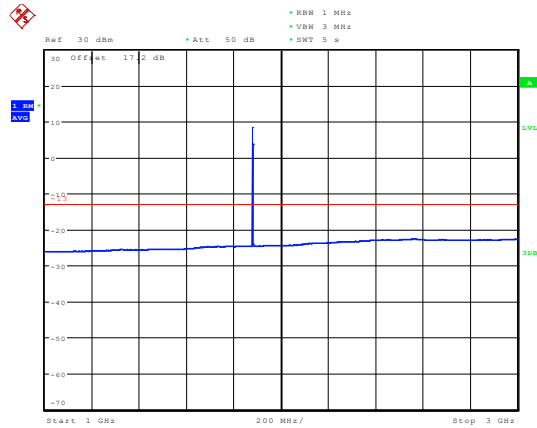

Date: 21.AUG.2019 16:39:59

LTE Band 2 1.4MHz CH-Low 3GHz~20GHz

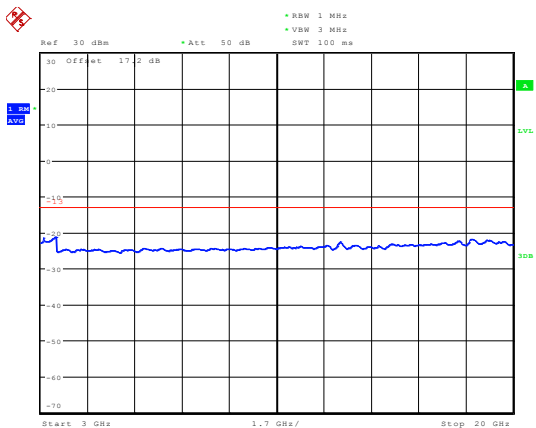

Date: 19.AUG.2019 16:41:05

LTE Band 2 1.4MHz CH-Middle 3GHz~20GHz

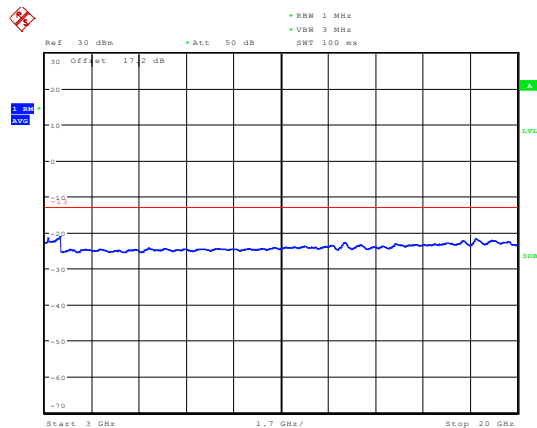

Date: 19.AUG.2019 16:41:33



LTE Band 2 1.4MHz CH-High 30MHz~1GHz

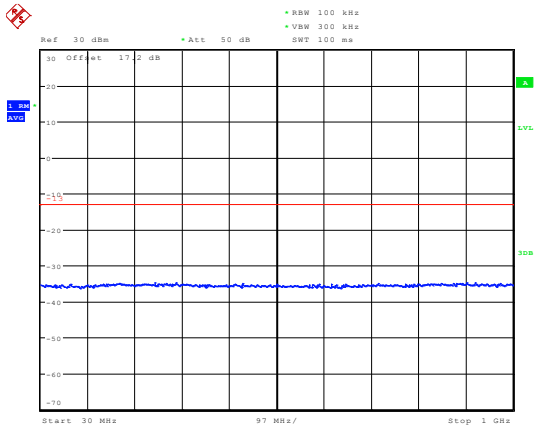

Date: 19.AUG.2019 16:19:28

LTE Band 2 3MHz CH-Low 30MHz~1GHz

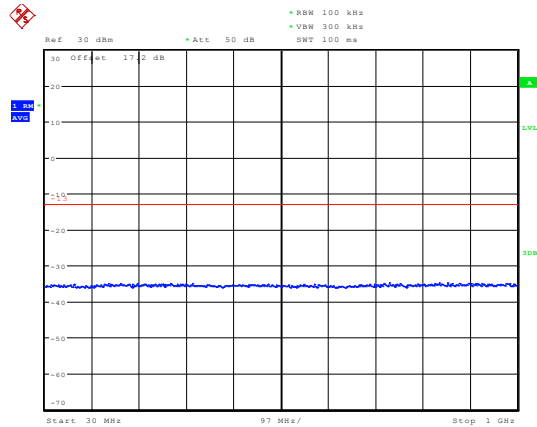

Date: 19.AUG.2019 16:19:54

LTE Band 2 1.4MHz CH-High 1GHz~3GHz

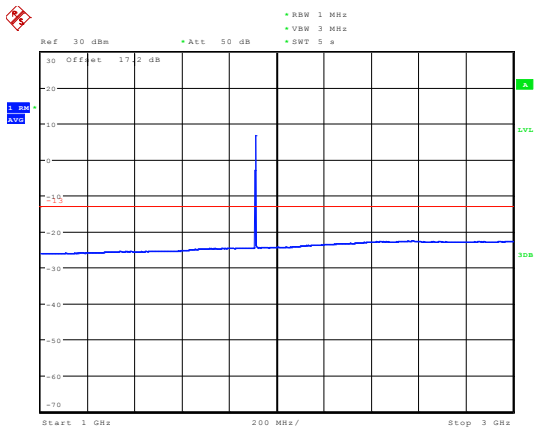

Date: 21.AUG.2019 16:41:47

LTE Band 2 3MHz CH-Low 1GHz~3GHz

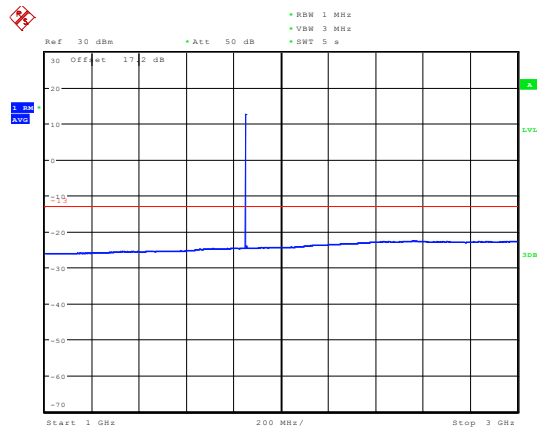

Date: 21.AUG.2019 16:43:25

LTE Band 2 1.4MHz CH-High 3GHz~20GHz

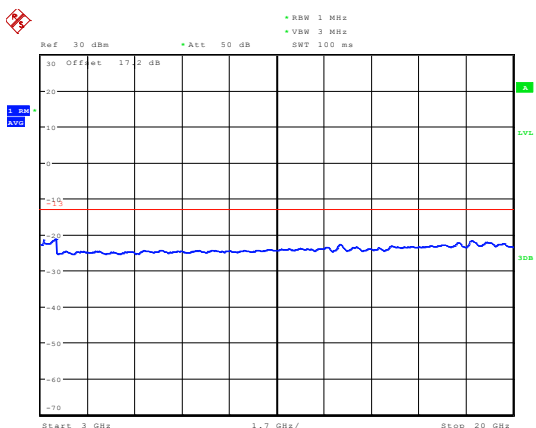

Date: 19.AUG.2019 16:43:12

LTE Band 2 3MHz CH-Low 3GHz~20GHz

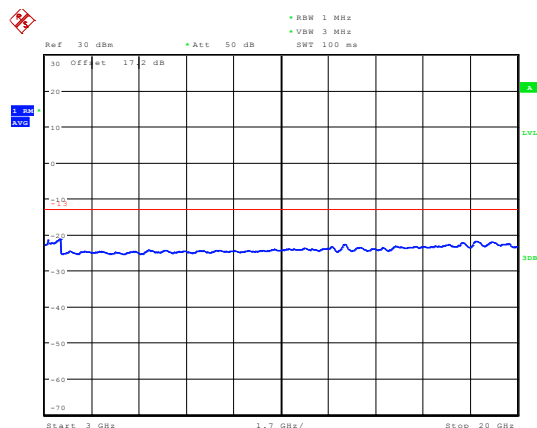

Date: 19.AUG.2019 16:44:25



LTE Band 2 3MHz CH-Middle 30MHz~1GHz

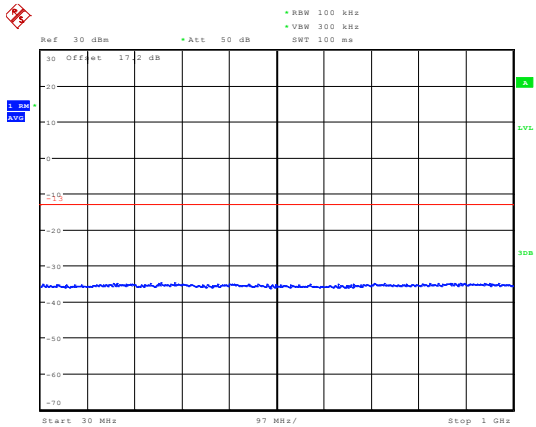

Date: 19.AUG.2019 16:20:15

LTE Band 2 3MHz CH-High 30MHz~1GHz

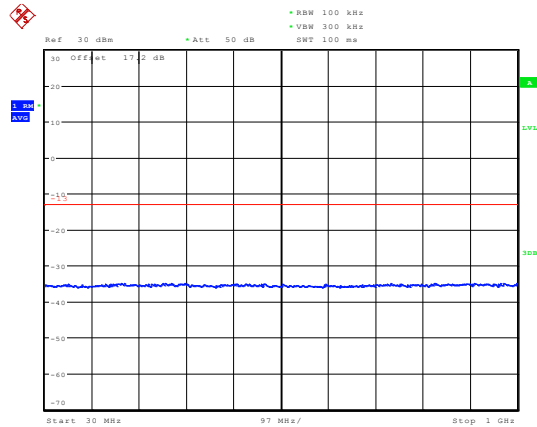

Date: 19.AUG.2019 16:21:21

LTE Band 2 3MHz CH-Middle 1GHz~3GHz

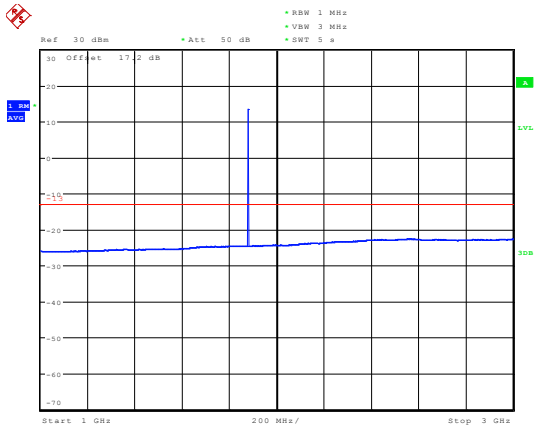

Date: 21.AUG.2019 16:45:19

LTE Band 2 3MHz CH-High 1GHz~3GHz

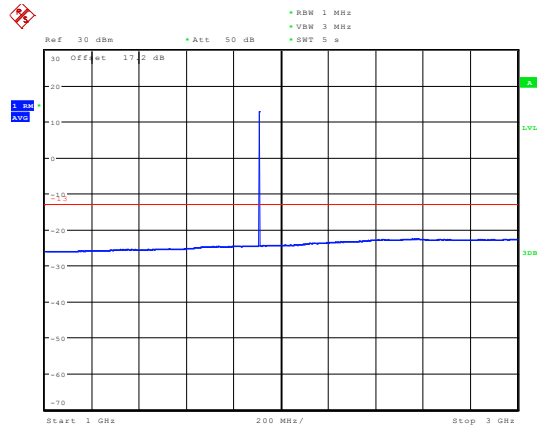

Date: 21.AUG.2019 16:47:27

LTE Band 2 3MHz CH-Middle 3GHz~20GHz

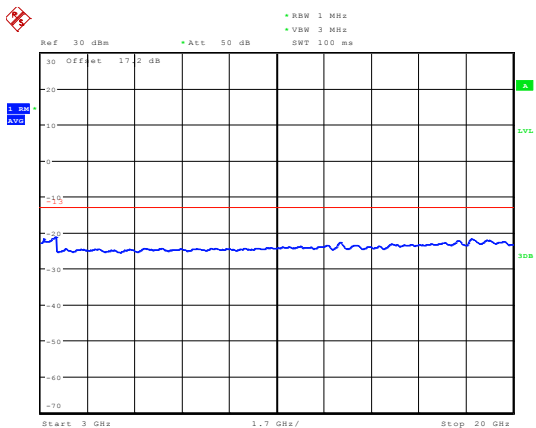

Date: 19.AUG.2019 16:44:44

LTE Band 2 3MHz CH-High 3GHz~20GHz

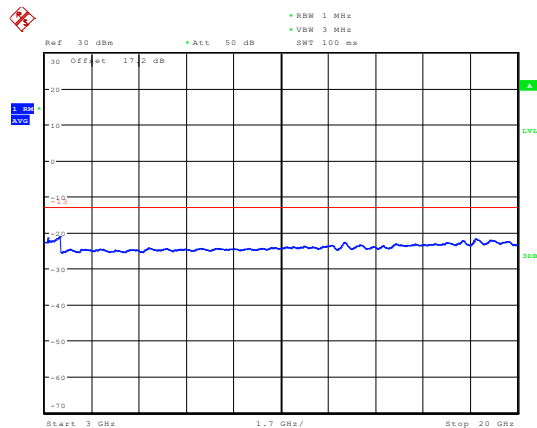

Date: 19.AUG.2019 16:45:46



LTE Band 2 5MHz CH-Low 30MHz~1GHz

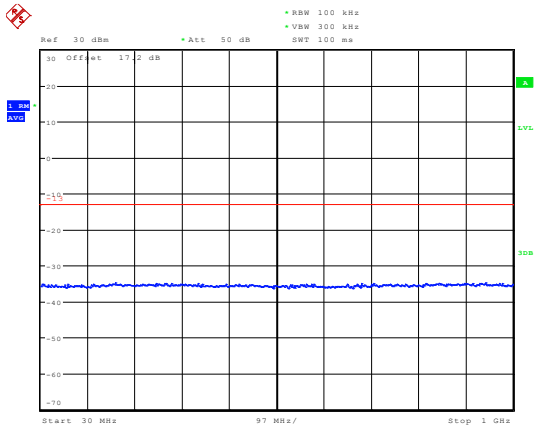

Date: 19.AUG.2019 16:21:32

LTE Band 2 5MHz CH-Middle 30MHz~1GHz

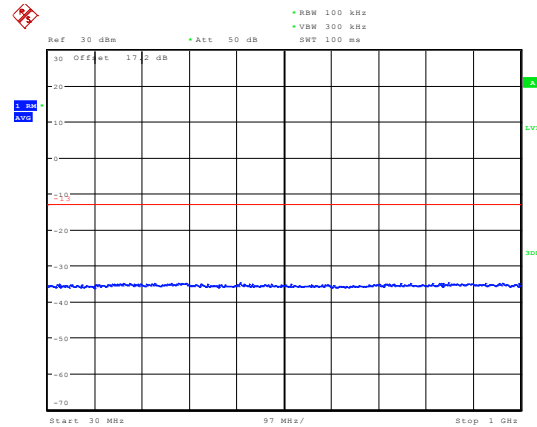

Date: 19.AUG.2019 16:23:29

LTE Band 2 5MHz CH-Low 1GHz~3GHz

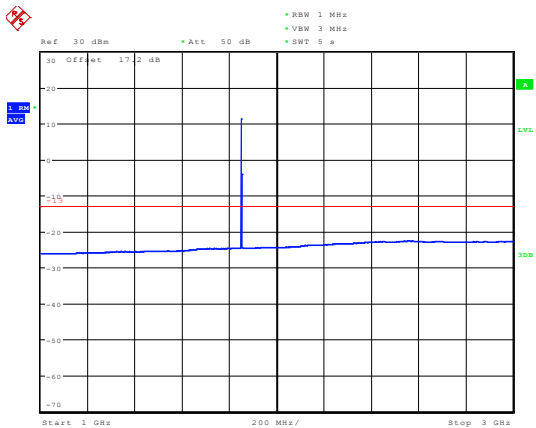

Date: 21.AUG.2019 16:49:07

LTE Band 2 5MHz CH-Middle 1GHz~3GHz

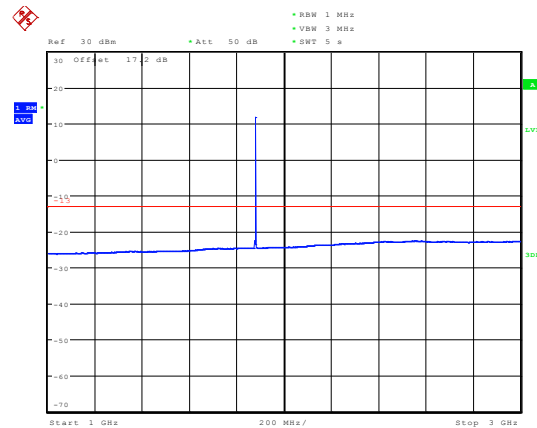

Date: 21.AUG.2019 16:50:31

LTE Band 2 5MHz CH-Low 3GHz~20GHz

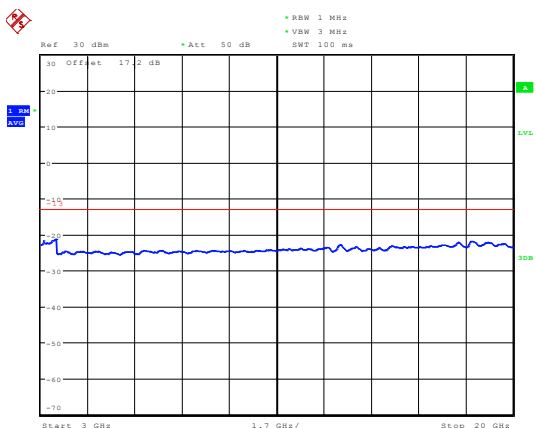

Date: 19.AUG.2019 16:46:58

LTE Band 2 5MHz CH-Middle 3GHz~20GHz

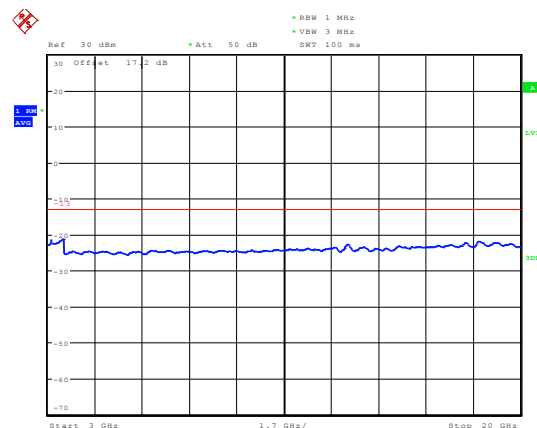

Date: 19.AUG.2019 16:48:15



LTE Band 2 5MHz CH-High 30MHz~1GHz

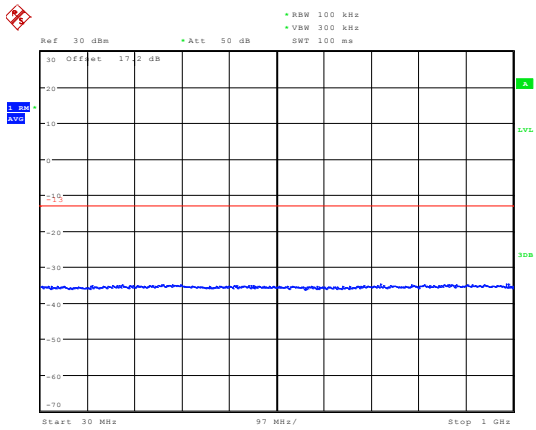

Date: 19.AUG.2019 16:13:20

LTE Band 2 10MHz CH-Low 30MHz~1GHz

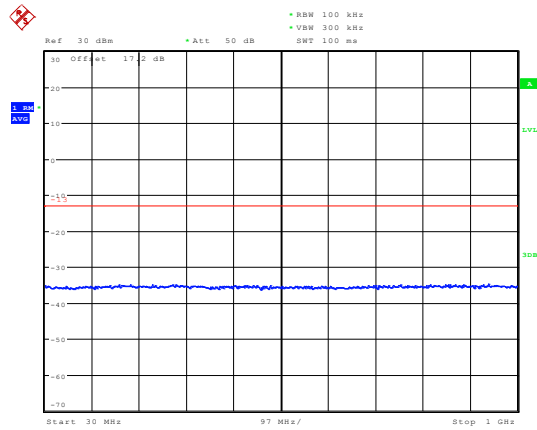

Date: 19.AUG.2019 16:24:02

LTE Band 2 5MHz CH-High 1GHz~3GHz

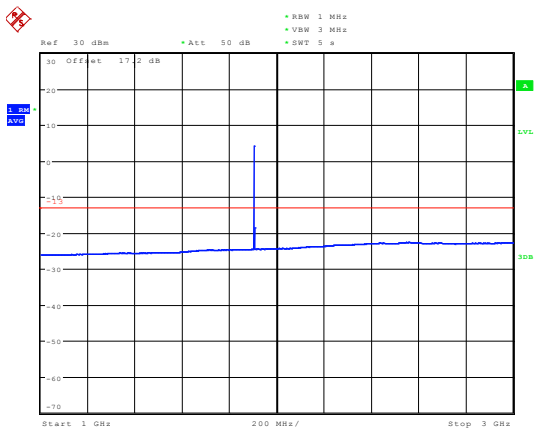

Date: 21.AUG.2019 16:52:57

LTE Band 2 10MHz CH-Low 1GHz~3GHz

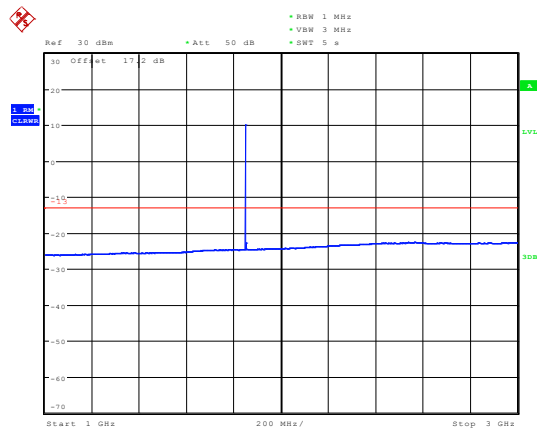

Date: 21.AUG.2019 16:54:46

LTE Band 2 5MHz CH-High 3GHz~20GHz

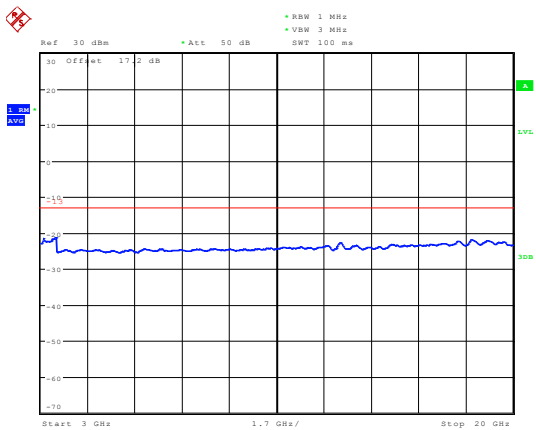

Date: 19.AUG.2019 16:48:33

LTE Band 2 10MHz CH-Low 3GHz~20GHz

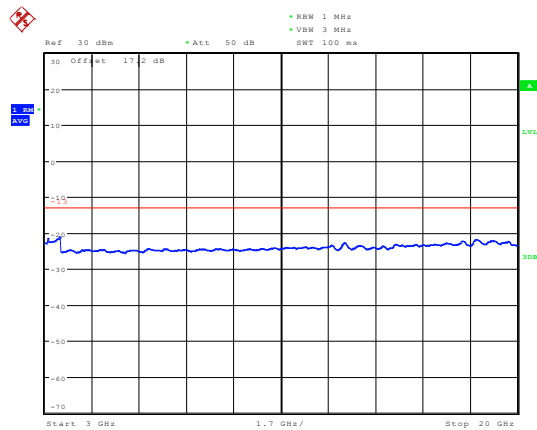

Date: 19.AUG.2019 16:48:51



LTE Band 2 10MHz CH-Middle 30MHz~1GHz

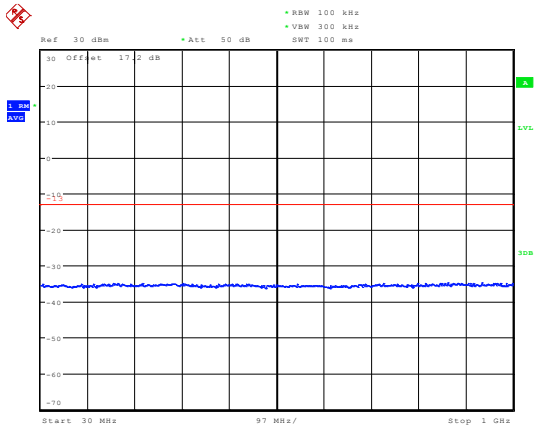

Date: 19.AUG.2019 16:24:38

LTE Band 2 10MHz CH-High 30MHz~1GHz

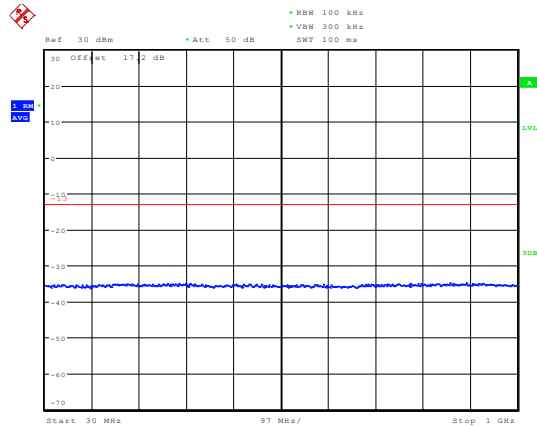

Date: 19.AUG.2019 16:25:34

LTE Band 2 10MHz CH-Middle 1GHz~3GHz

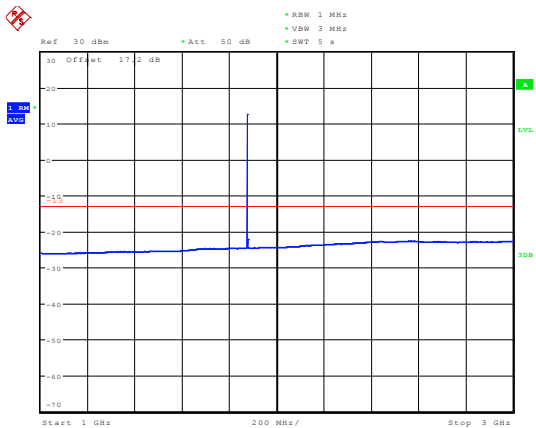

Date: 21.AUG.2019 16:56:52

LTE Band 2 10MHz CH-High 1GHz~3GHz

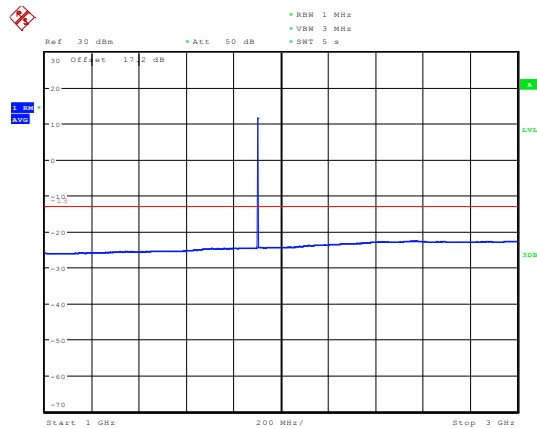

Date: 21.AUG.2019 16:58:22

LTE Band 2 10MHz CH-Middle 3GHz~20GHz

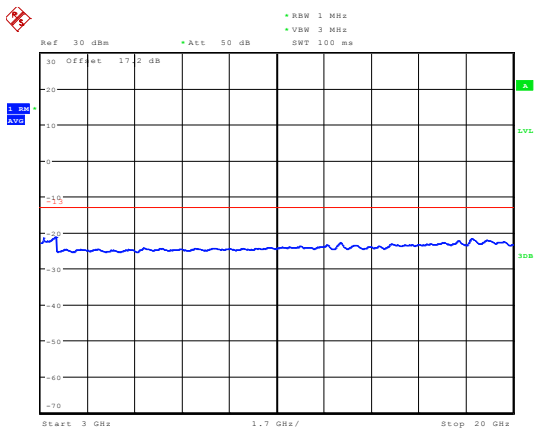

Date: 19.AUG.2019 16:50:49

LTE Band 2 10MHz CH-High 3GHz~20GHz

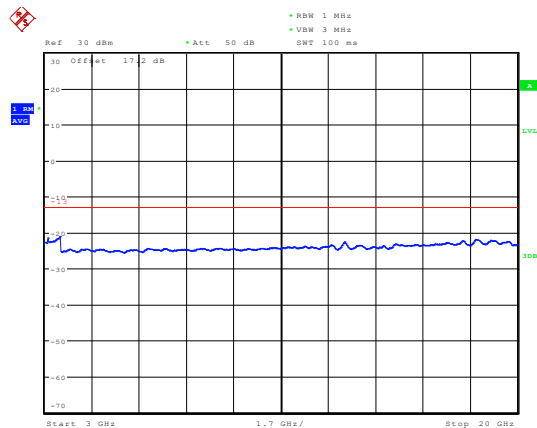

Date: 19.AUG.2019 16:52:43



LTE Band 2 15MHz CH-Low 30MHz~1GHz

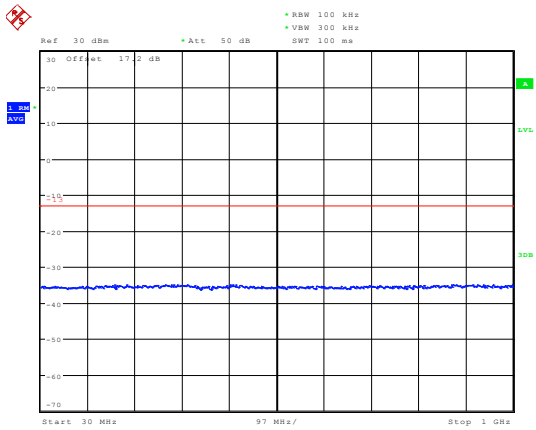

Date: 19.AUG.2019 16:18:44

LTE Band 2 15MHz CH-Middle 30MHz~1GHz

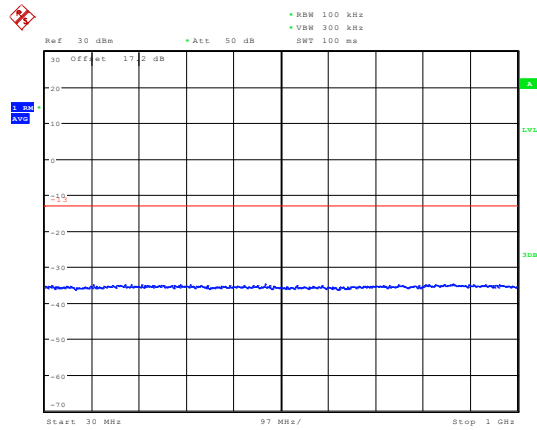

Date: 19.AUG.2019 16:27:13

LTE Band 2 15MHz CH-Low 1GHz~3GHz

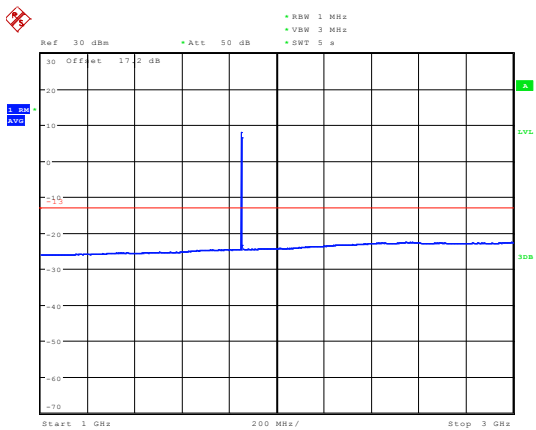

Date: 21.AUG.2019 17:08:15

LTE Band 2 15MHz CH-Middle 1GHz~3GHz

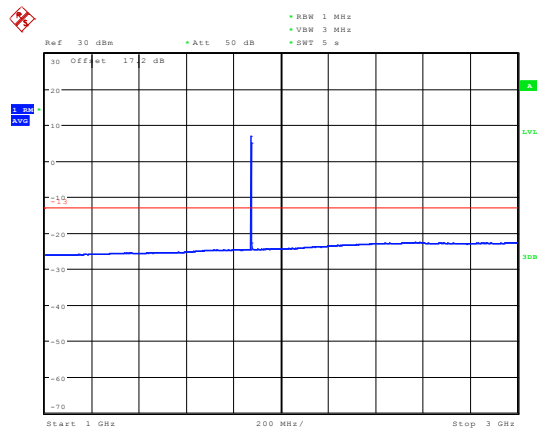

Date: 21.AUG.2019 17:06:35

LTE Band 2 15MHz CH-Low 3GHz~20GHz

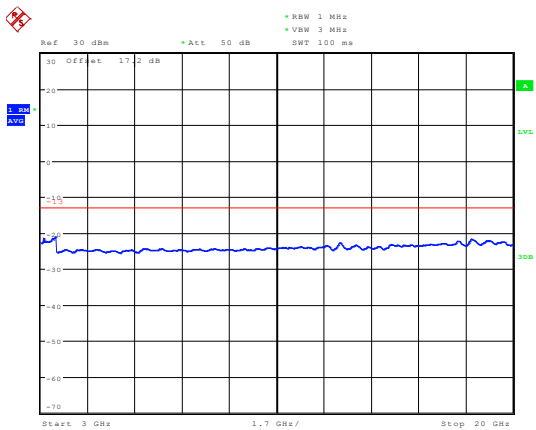

Date: 19.AUG.2019 16:53:27

LTE Band 2 15MHz CH-Middle 3GHz~20GHz

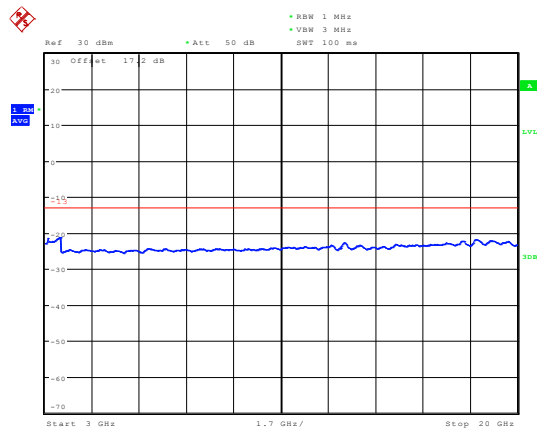

Date: 19.AUG.2019 16:53:59



LTE Band 2 15MHz CH-High 30MHz~1GHz

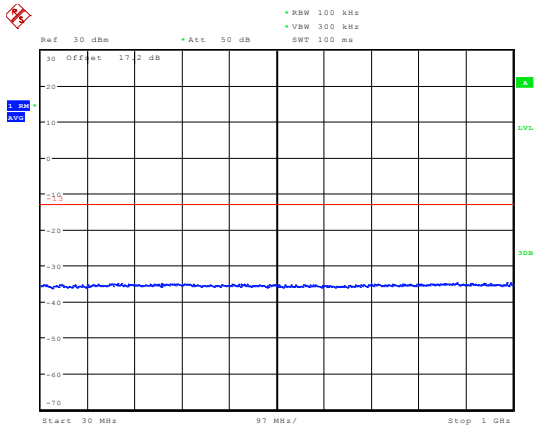

Date: 19.AUG.2019 16:30:50

LTE Band 2 20MHz CH-Low 30MHz~1GHz

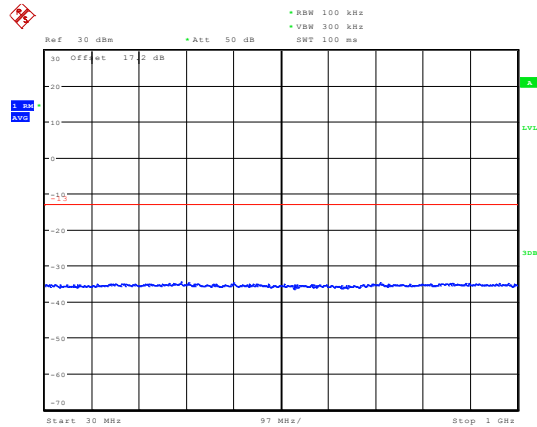

Date: 19.AUG.2019 16:31:39

LTE Band 2 15MHz CH-High 1GHz~3GHz

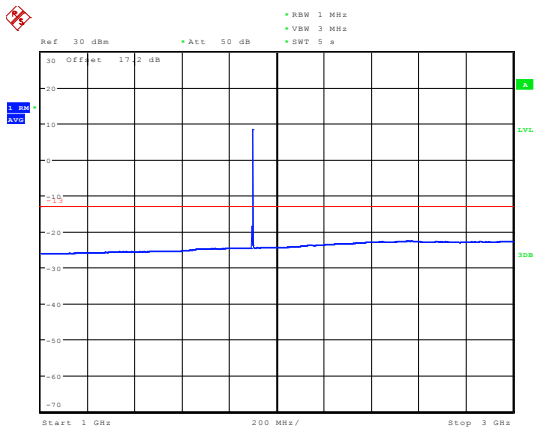

Date: 21.AUG.2019 17:04:42

LTE Band 2 20MHz CH-Low 1GHz~3GHz

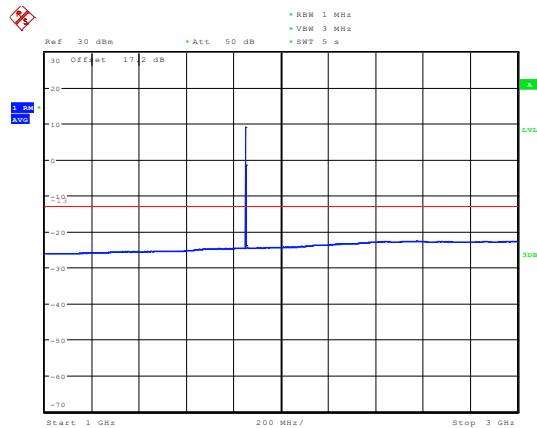

Date: 21.AUG.2019 17:09:44

LTE Band 2 15MHz CH-High 3GHz~20GHz

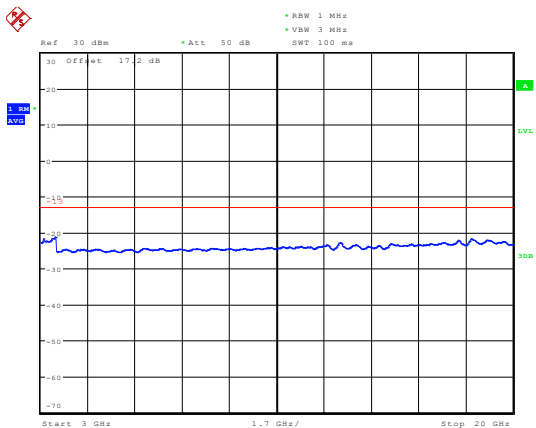

Date: 19.AUG.2019 16:56:26

LTE Band 2 20MHz CH-Low 3GHz~20GHz

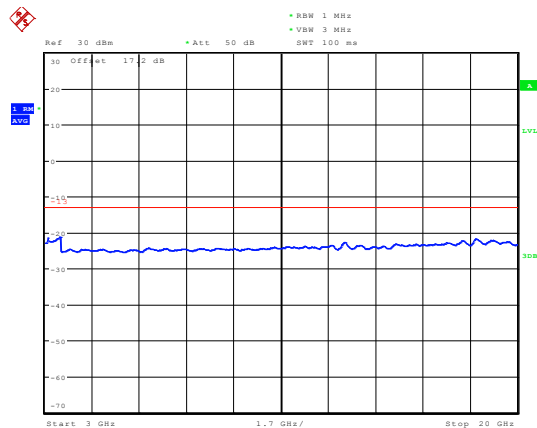

Date: 19.AUG.2019 16:57:45



LTE Band 2 20MHz CH-Middle 30MHz~1GHz

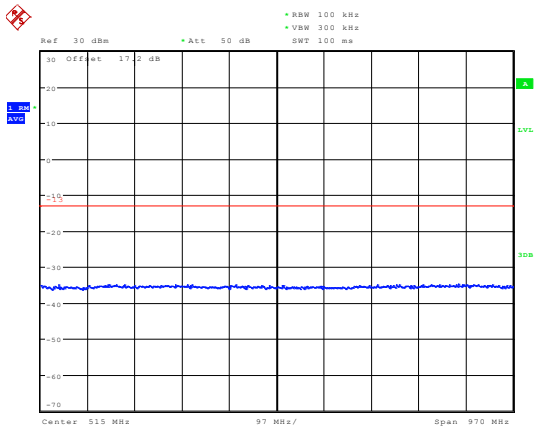

Date: 19.AUG.2019 16:16:43

LTE Band 2 20MHz CH-High 30MHz~1GHz

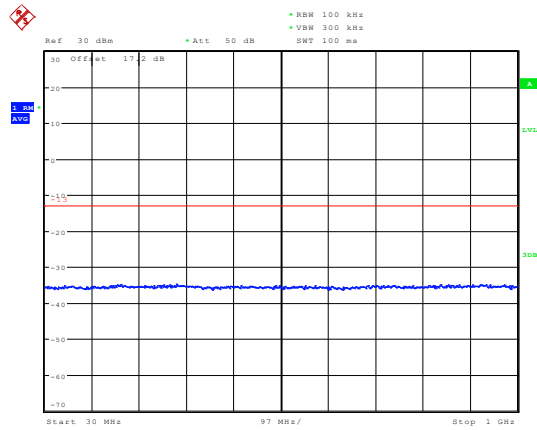

Date: 19.AUG.2019 16:31:56

LTE Band 2 20MHz CH-Middle 1GHz~3GHz

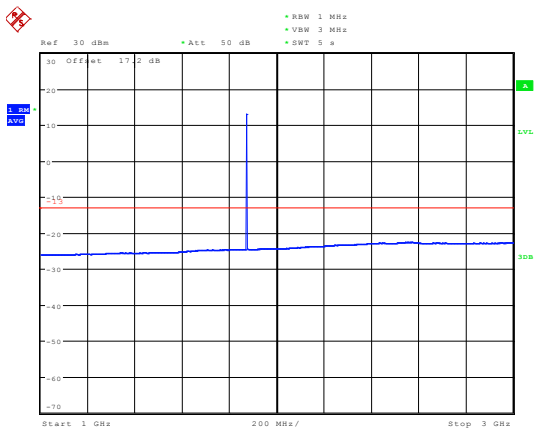

Date: 21.AUG.2019 17:11:31

LTE Band 2 20MHz CH-High 1GHz~3GHz

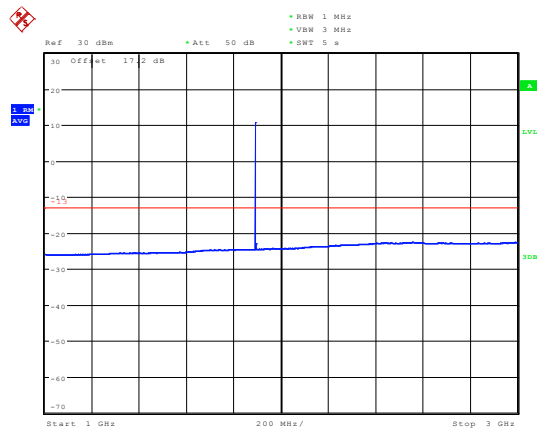

Date: 21.AUG.2019 17:13:48

LTE Band 2 20MHz CH-Middle 3GHz~20GHz

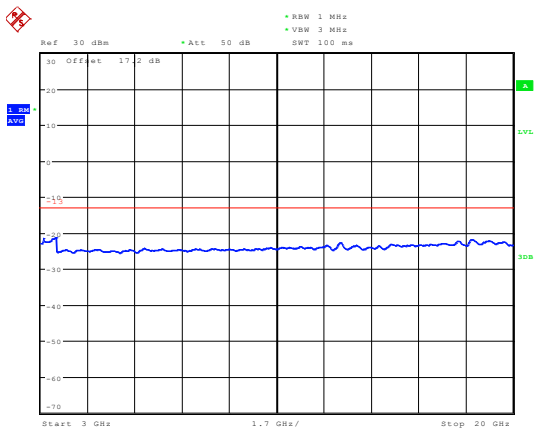

Date: 19.AUG.2019 16:58:02

LTE Band 2 20MHz CH-High 3GHz~20GHz

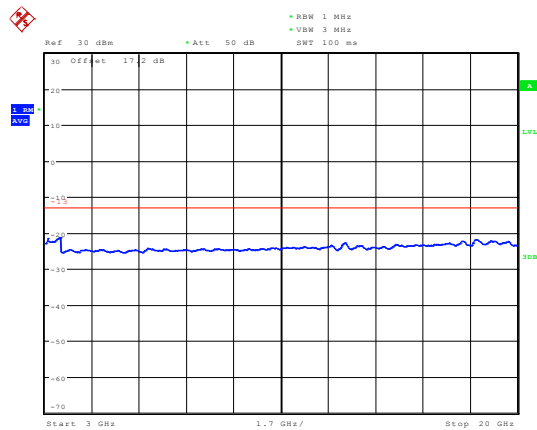

Date: 19.AUG.2019 16:58:46



LTE Band 25 1.4MHz CH-Low 30MHz~1GHz

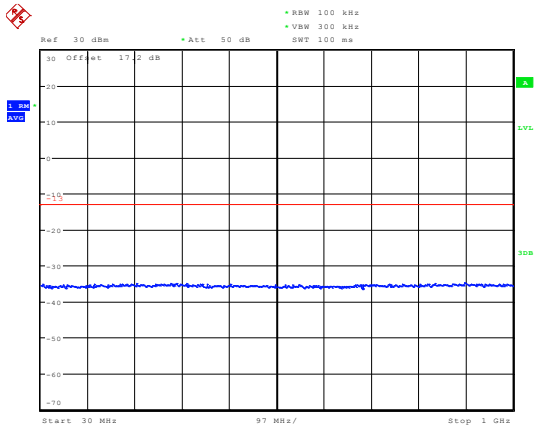

Date: 26.AUG.2019 10:53:54

LTE Band 25 1.4MHz CH-Middle 30MHz~1GHz

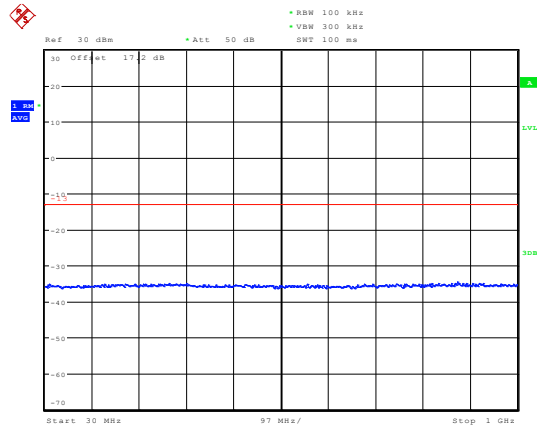

Date: 26.AUG.2019 10:54:17

LTE Band 25 1.4MHz CH-Low 1GHz~3GHz

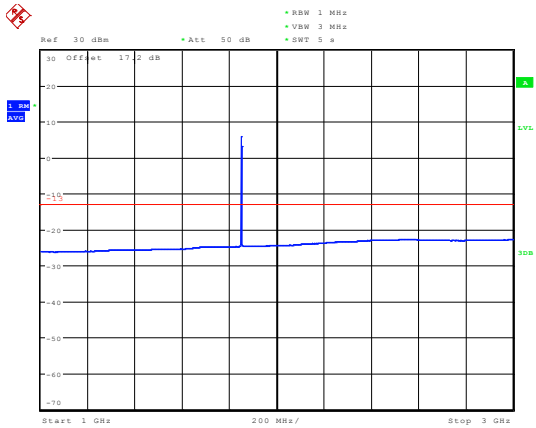

Date: 26.AUG.2019 11:05:00

LTE Band 25 1.4MHz CH-Middle 1GHz~3GHz

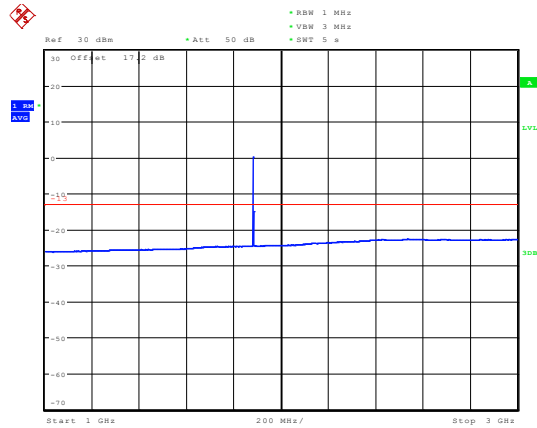

Date: 21.AUG.2019 17:56:23

LTE Band 25 1.4MHz CH-Low 3GHz~20GHz

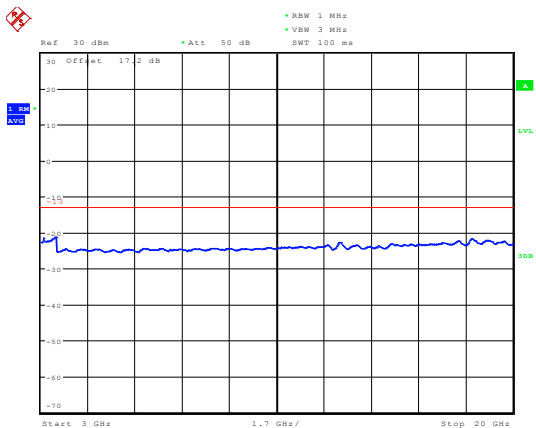

Date: 19.AUG.2019 20:50:21

LTE Band 25 1.4MHz CH-Middle 3GHz~20GHz

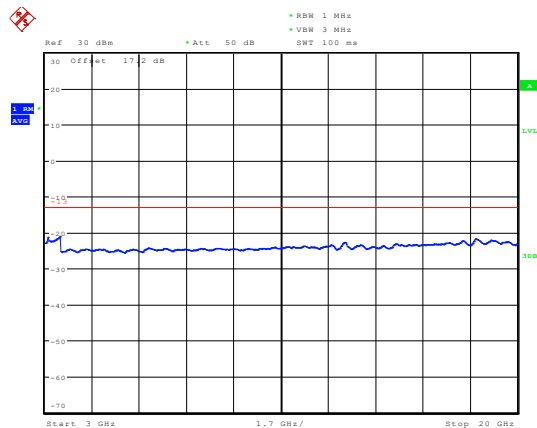

Date: 19.AUG.2019 20:50:32



LTE Band 25 1.4MHz CH-High 30MHz~1GHz

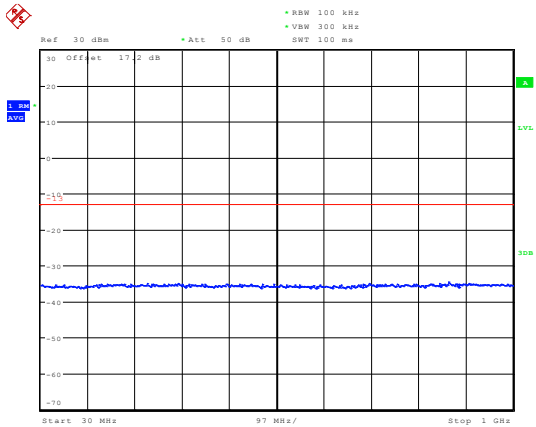

Date: 26.AUG.2019 10:54:46

LTE Band 25 3MHz CH-Low 30MHz~1GHz

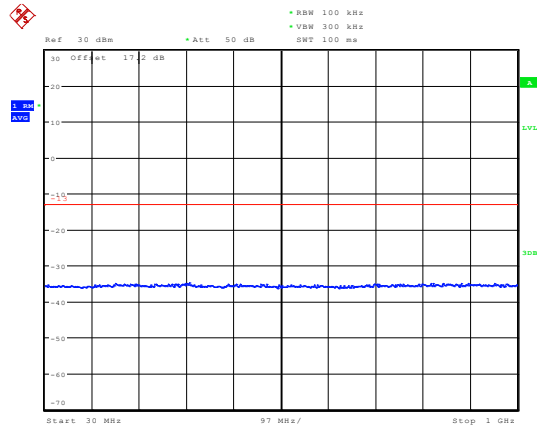

Date: 26.AUG.2019 10:55:23

LTE Band 25 1.4MHz CH-High 1GHz~3GHz

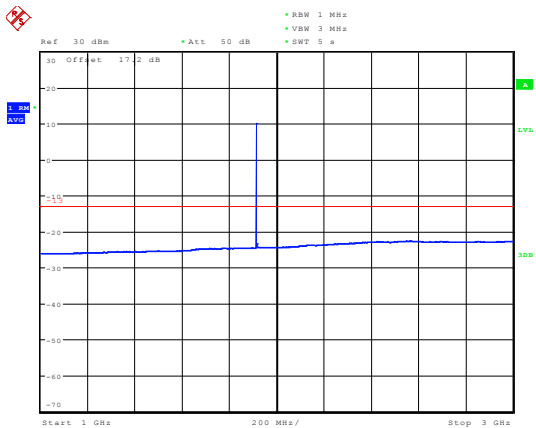

Date: 21.AUG.2019 17:57:57

LTE Band 25 3MHz CH-Low 1GHz~3GHz

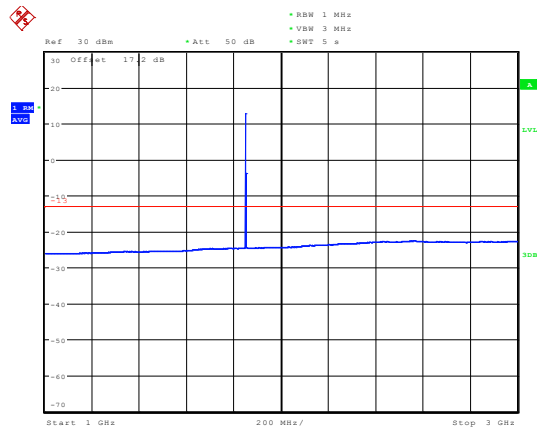

Date: 21.AUG.2019 18:00:04

LTE Band 25 1.4MHz CH-High 3GHz~20GHz

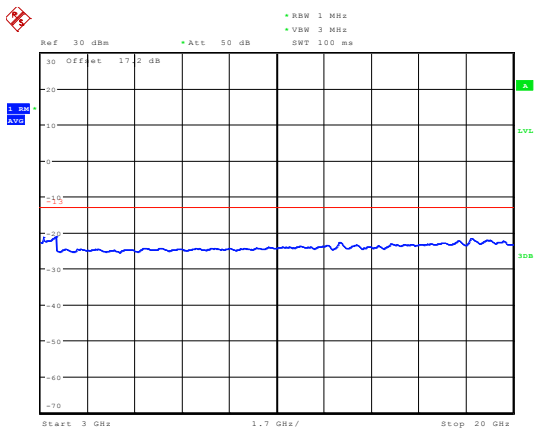

Date: 19.AUG.2019 20:51:00

LTE Band 25 3MHz CH-Low 3GHz~20GHz

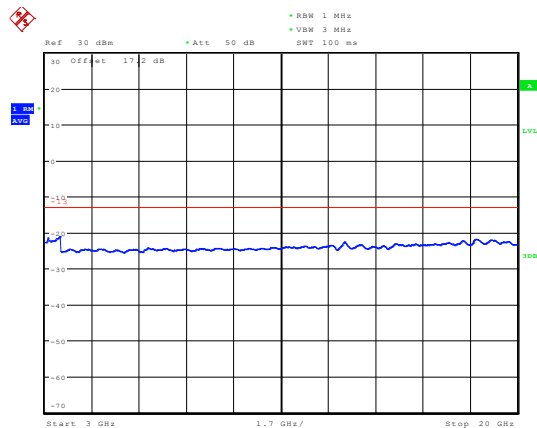

Date: 19.AUG.2019 20:51:13



LTE Band 25 3MHz CH-Middle 30MHz~1GHz

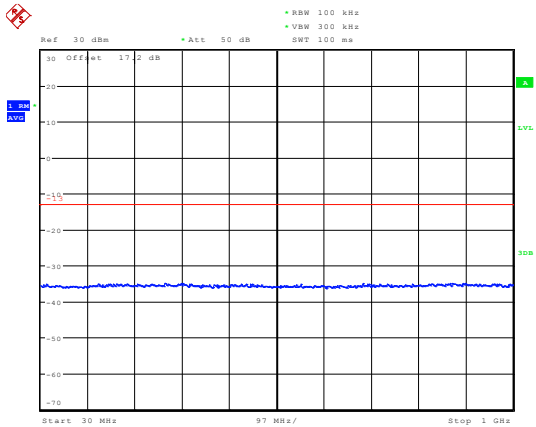

Date: 26.AUG.2019 10:55:48

LTE Band 25 3MHz CH-High 30MHz~1GHz

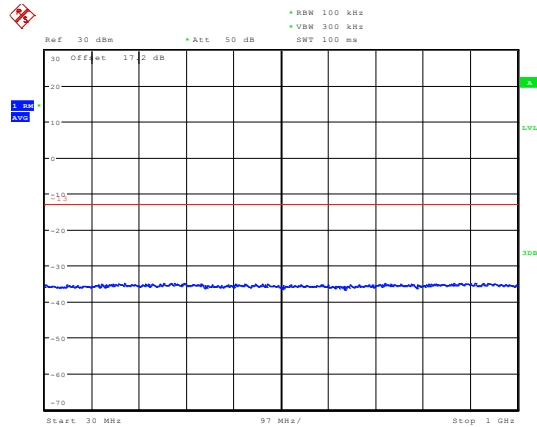

Date: 26.AUG.2019 10:56:57

LTE Band 25 3MHz CH-Middle 1GHz~3GHz

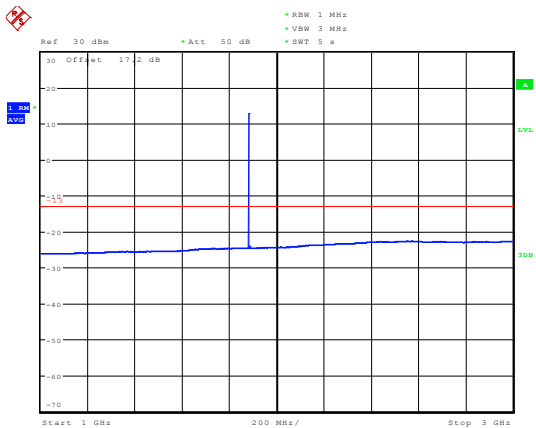

Date: 21.AUG.2019 18:01:50

LTE Band 25 3MHz CH-High 1GHz~3GHz

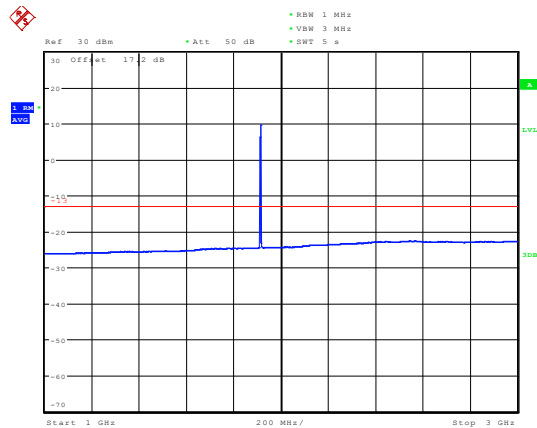

Date: 21.AUG.2019 18:03:11

LTE Band 25 3MHz CH-Middle 3GHz~20GHz

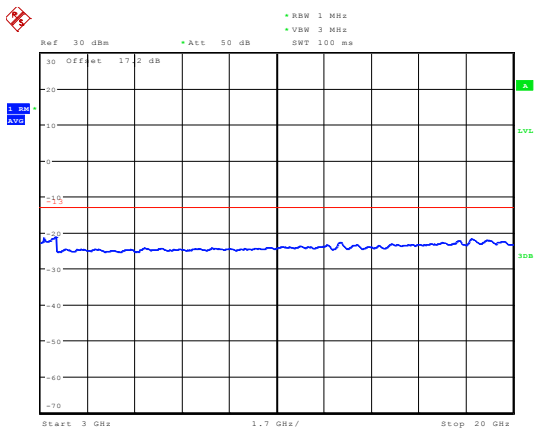

Date: 19.AUG.2019 20:51:28

LTE Band 25 3MHz CH-High 3GHz~20GHz

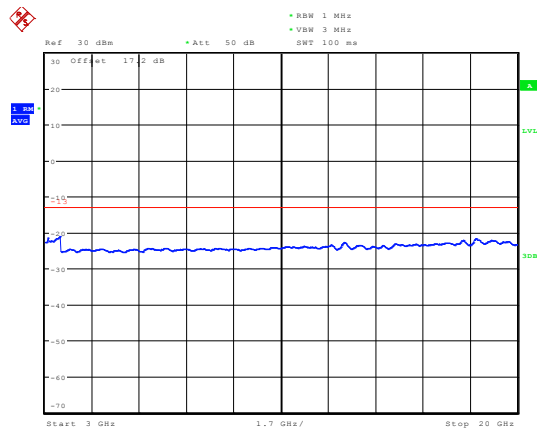

Date: 19.AUG.2019 20:51:40



LTE Band 25 5MHz CH-Low 30MHz~1GHz

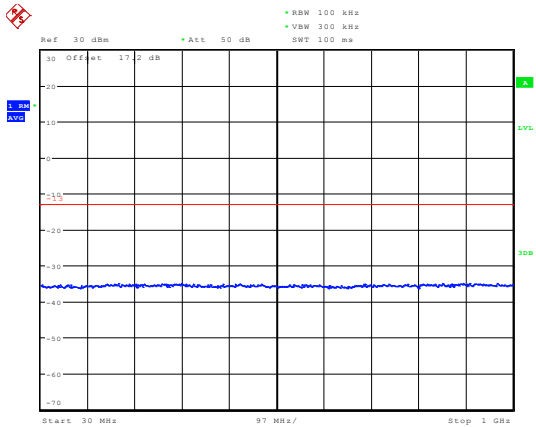

Date: 26.AUG.2019 10:57:20

LTE Band 25 5MHz CH-Middle 30MHz~1GHz

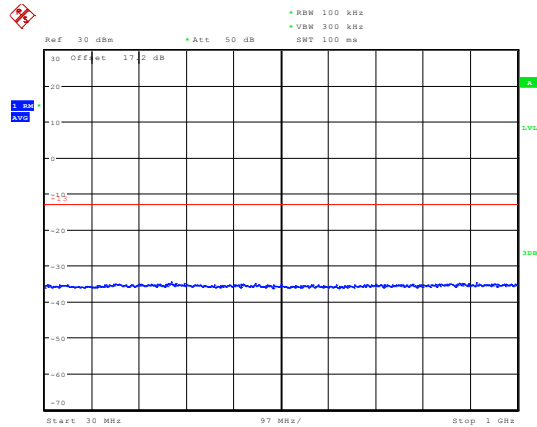

Date: 26.AUG.2019 10:57:46

LTE Band 25 5MHz CH-Low 1GHz~3GHz

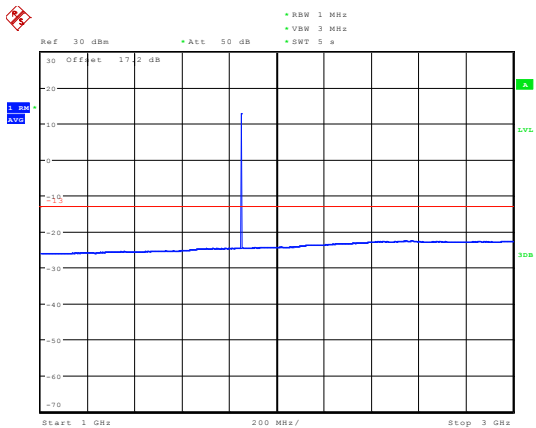

Date: 21.AUG.2019 18:04:14

LTE Band 25 5MHz CH-Middle 1GHz~3GHz

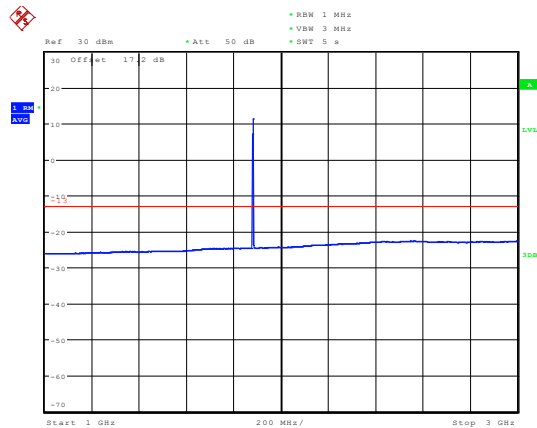

Date: 21.AUG.2019 18:05:32

LTE Band 25 5MHz CH-Low 3GHz~20GHz

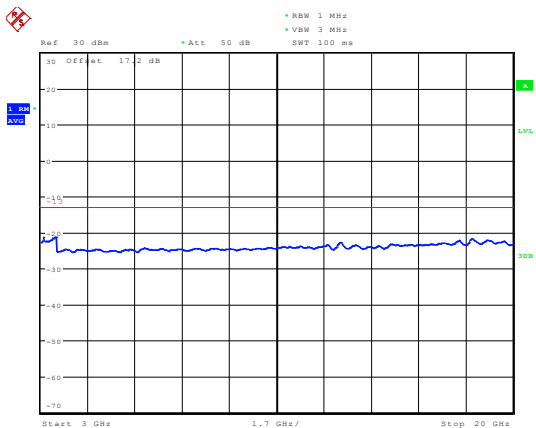

Date: 19.AUG.2019 20:51:49

LTE Band 25 5MHz CH-Middle 3GHz~20GHz

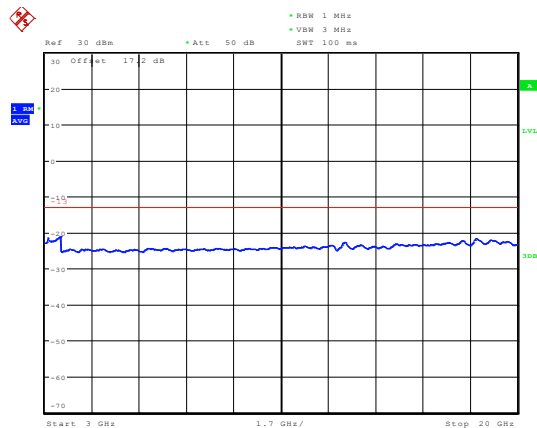

Date: 19.AUG.2019 20:52:03



LTE Band 25 5MHz CH-High 30MHz~1GHz

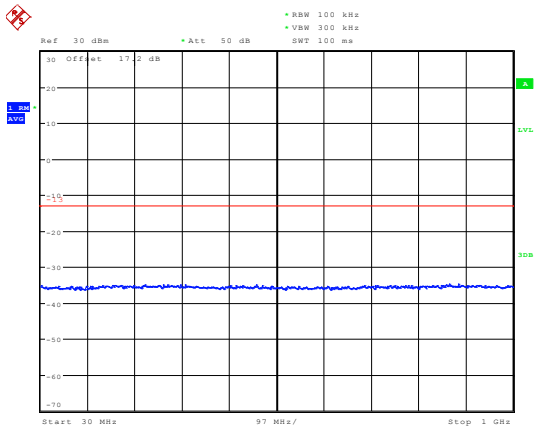

Date: 26.AUG.2019 10:58:06

LTE Band 25 10MHz CH-Low 30MHz~1GHz

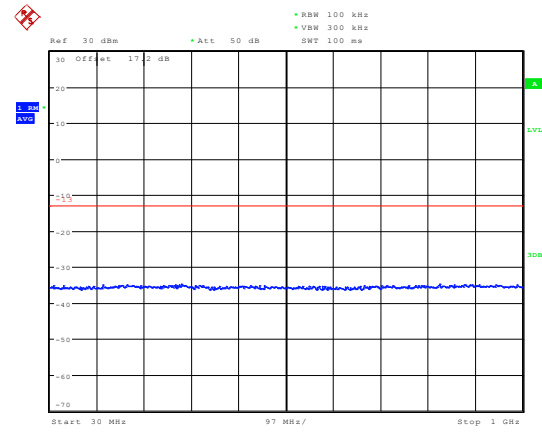

Date: 26.AUG.2019 10:58:38

LTE Band 25 5MHz CH-High 1GHz~3GHz

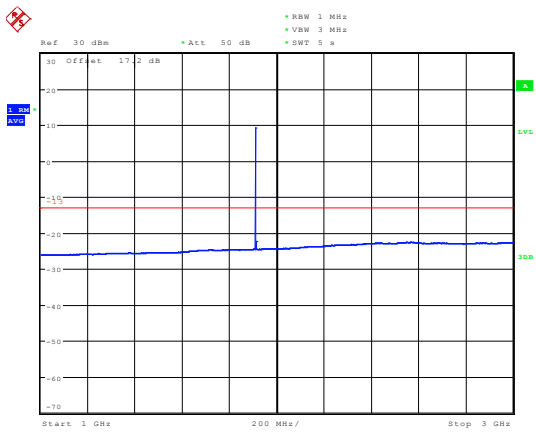

Date: 21.AUG.2019 18:07:07

LTE Band 25 10MHz CH-Low 1GHz~3GHz

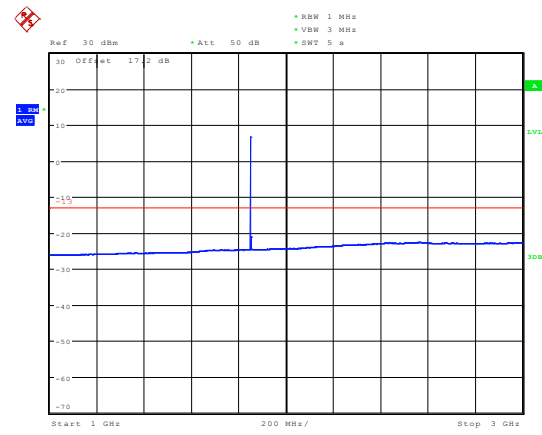

Date: 21.AUG.2019 18:07:56

LTE Band 25 5MHz CH-High 3GHz~20GHz

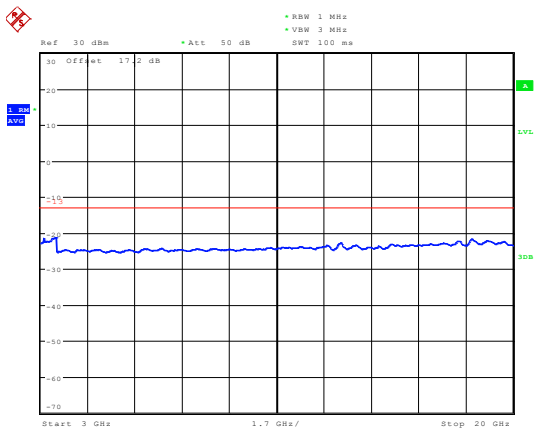

Date: 19.AUG.2019 20:52:14

LTE Band 25 10MHz CH-Low 3GHz~20GHz

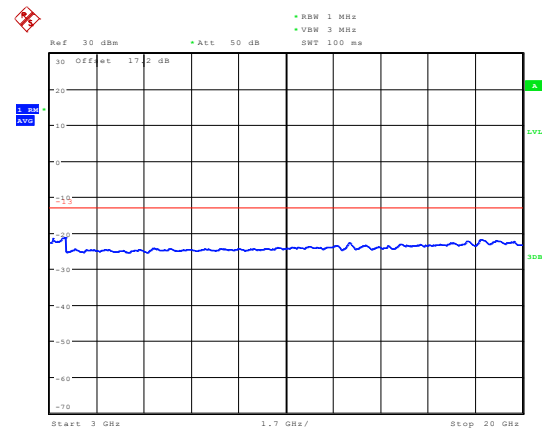

Date: 19.AUG.2019 20:52:39



LTE Band 25 10MHz CH-Middle 30MHz~1GHz

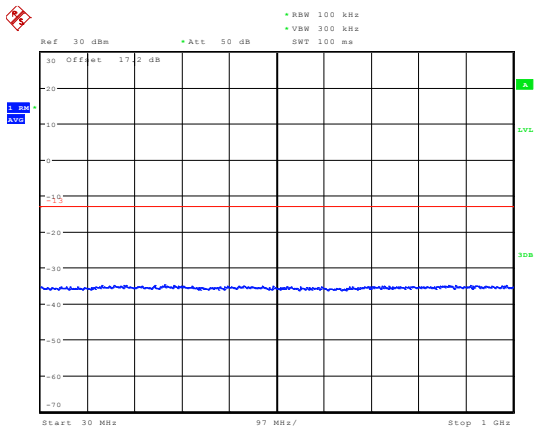

Date: 26.AUG.2019 10:59:07

LTE Band 25 10MHz CH-High 30MHz~1GHz

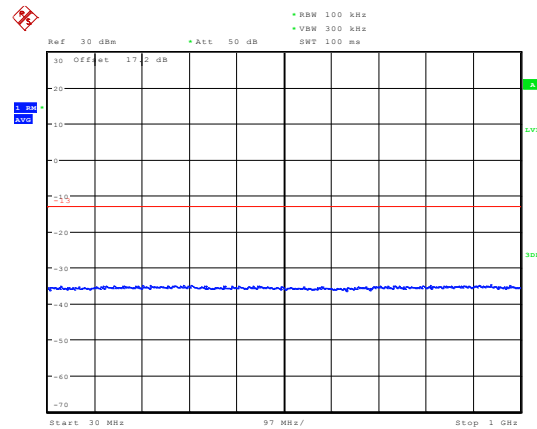

Date: 26.AUG.2019 10:59:58

LTE Band 25 10MHz CH-Middle 1GHz~3GHz

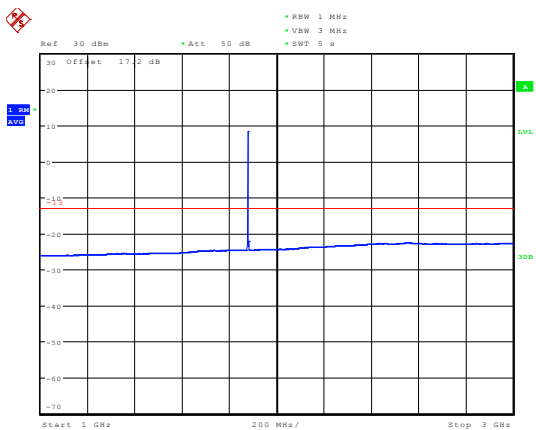

Date: 21.AUG.2019 18:09:30

LTE Band 25 10MHz CH-High 1GHz~3GHz

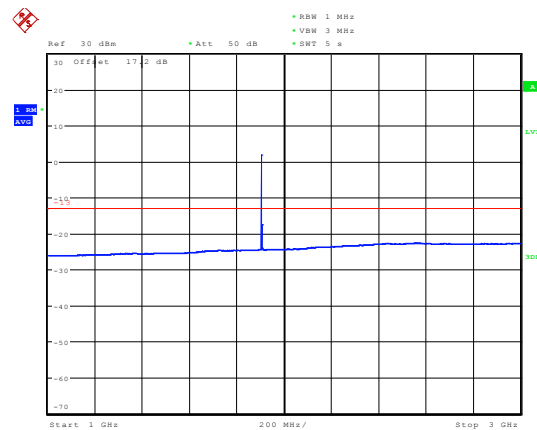

Date: 21.AUG.2019 18:10:29

LTE Band 25 10MHz CH-Middle 3GHz~20GHz

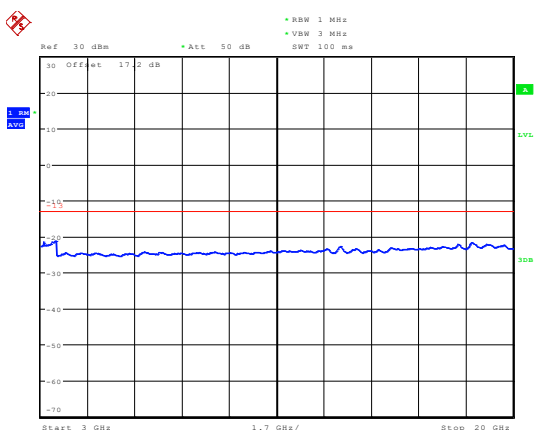

Date: 19.AUG.2019 20:53:17

LTE Band 25 10MHz CH-High 3GHz~20GHz

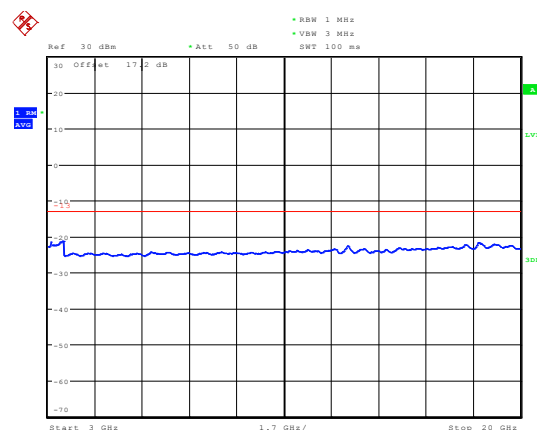

Date: 19.AUG.2019 20:53:52



LTE Band 25 15MHz CH-Low 30MHz~1GHz

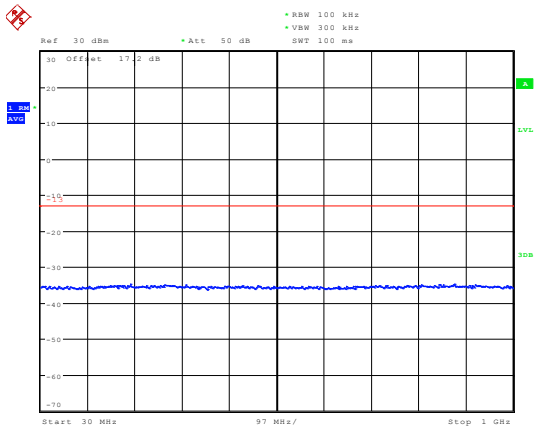

Date: 26.AUG.2019 11:00:37

LTE Band 25 15MHz CH-Middle 30MHz~1GHz

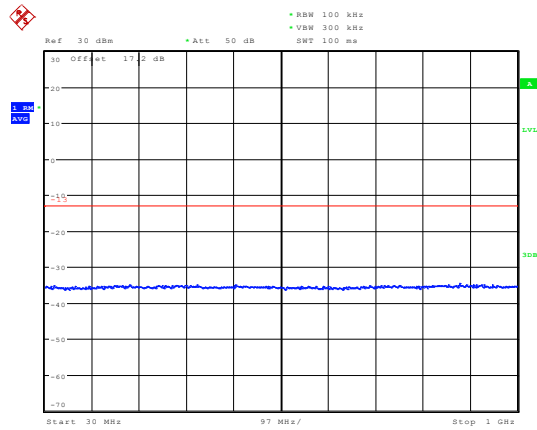

Date: 26.AUG.2019 11:00:57

LTE Band 25 15MHz CH-Low 1GHz~3GHz

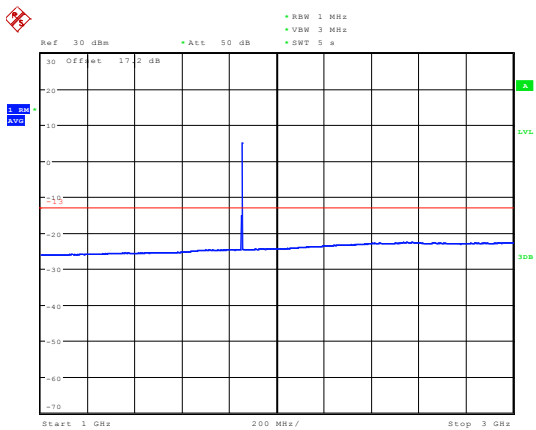

Date: 21.AUG.2019 18:11:33

LTE Band 25 15MHz CH-Middle 1GHz~3GHz

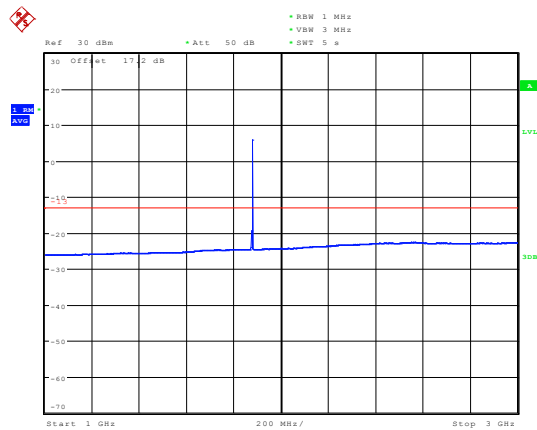

Date: 21.AUG.2019 18:12:17

LTE Band 25 15MHz CH-Low 3GHz~20GHz

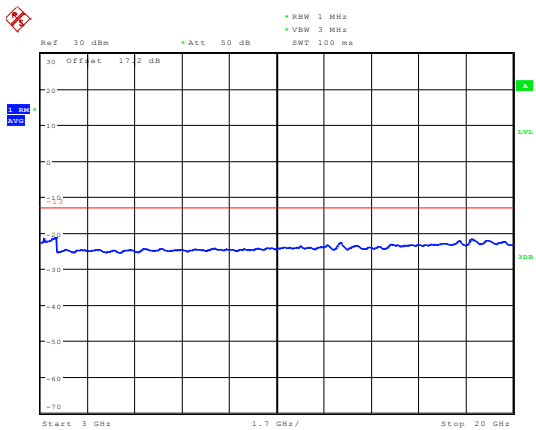

Date: 19.AUG.2019 20:54:42

LTE Band 25 15MHz CH-Middle 3GHz~20GHz

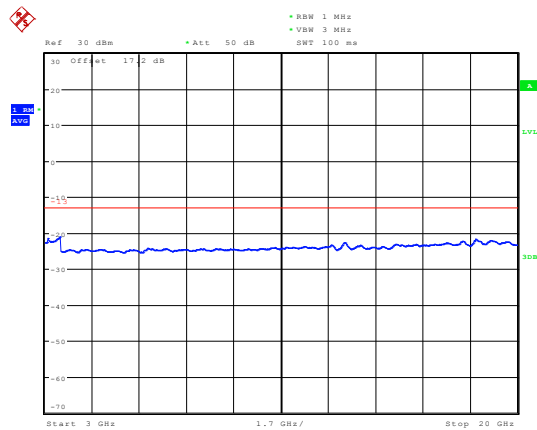

Date: 19.AUG.2019 20:55:02



LTE Band 25 15MHz CH-High 30MHz~1GHz

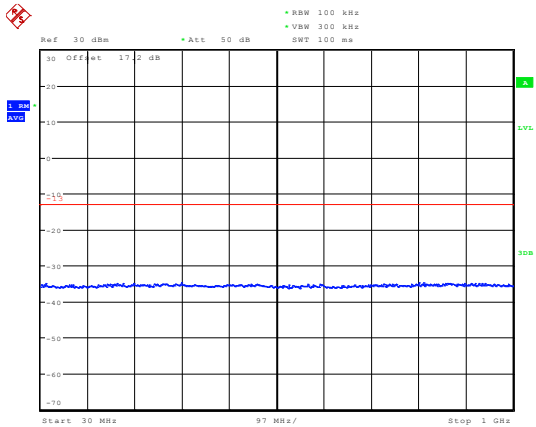

Date: 26.AUG.2019 11:01:20

LTE Band 25 20MHz CH-Low 30MHz~1GHz

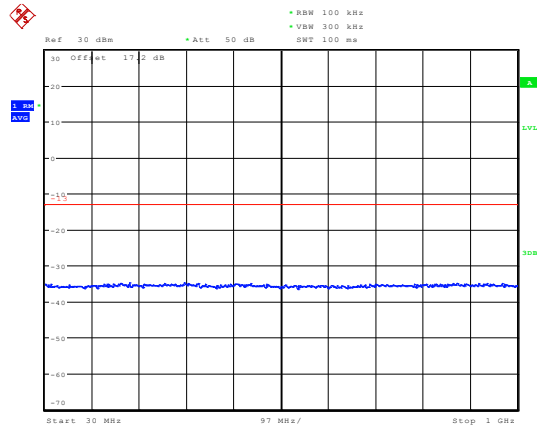

Date: 26.AUG.2019 11:01:50

LTE Band 25 15MHz CH-High 1GHz~3GHz

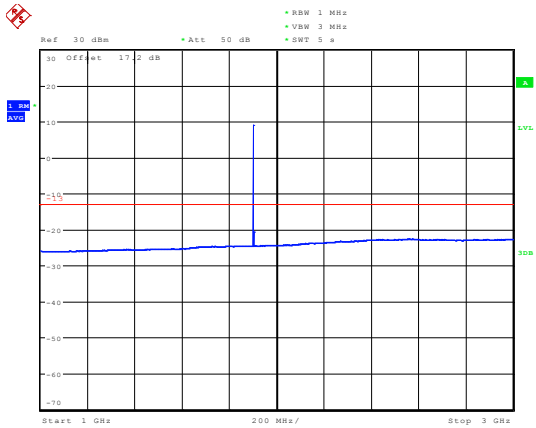

Date: 21.AUG.2019 18:13:24

LTE Band 25 20MHz CH-Low 1GHz~3GHz

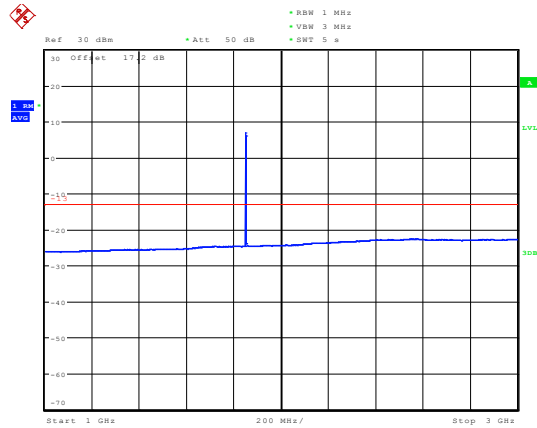

Date: 21.AUG.2019 18:16:49

LTE Band 25 15MHz CH-High 3GHz~20GHz

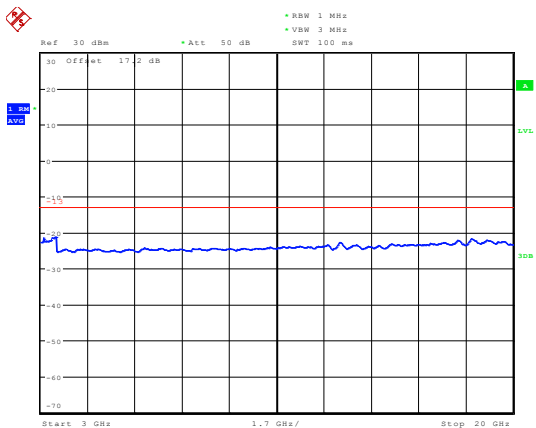

Date: 19.AUG.2019 20:55:29

LTE Band 25 20MHz CH-Low 3GHz~20GHz

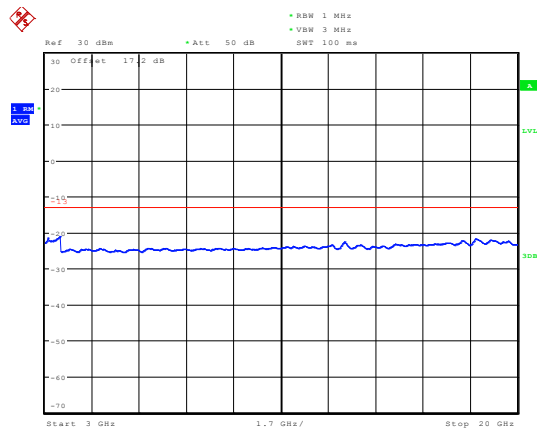

Date: 19.AUG.2019 20:55:54



LTE Band 25 20MHz CH-Middle 30MHz~1GHz

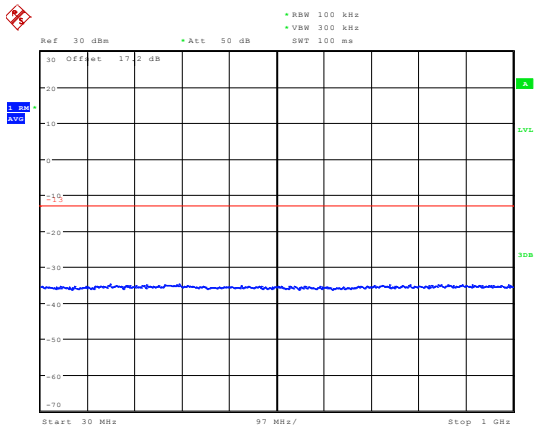

Date: 26.AUG.2019 11:02:27

LTE Band 25 20MHz CH-High 30MHz~1GHz

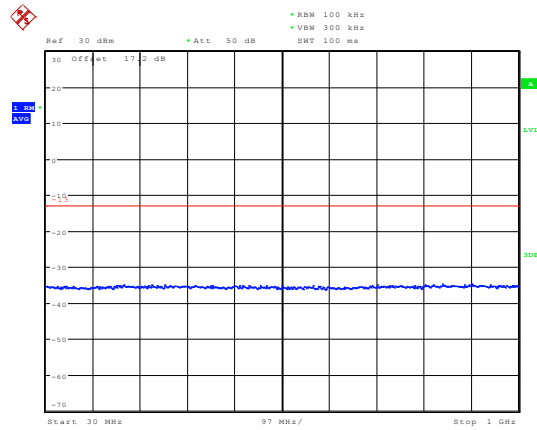

Date: 26.AUG.2019 11:02:56

LTE Band 25 20MHz CH-Middle 1GHz~3GHz

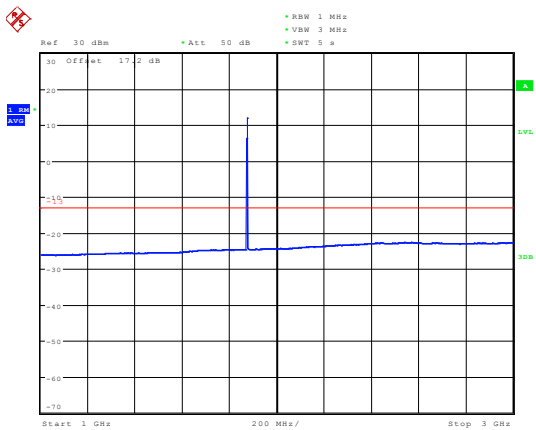

Date: 21.AUG.2019 18:17:43

LTE Band 25 20MHz CH-High 1GHz~3GHz

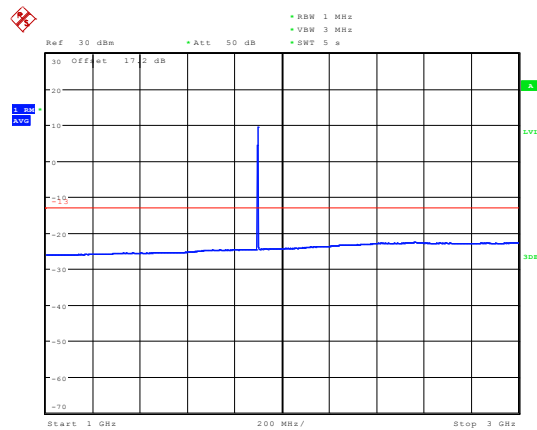

Date: 21.AUG.2019 18:18:35

LTE Band 25 20MHz CH-Middle 3GHz~20GHz

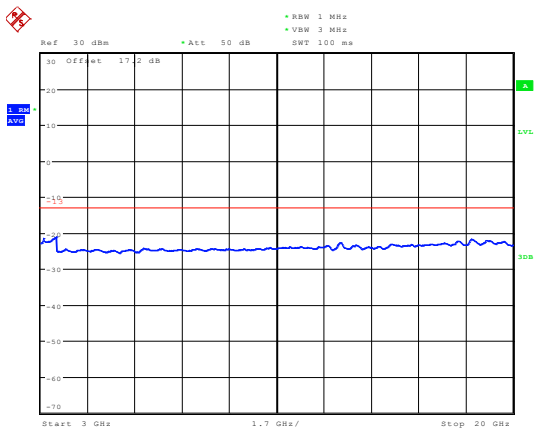

Date: 19.AUG.2019 20:56:08

LTE Band 25 20MHz CH-High 3GHz~20GHz

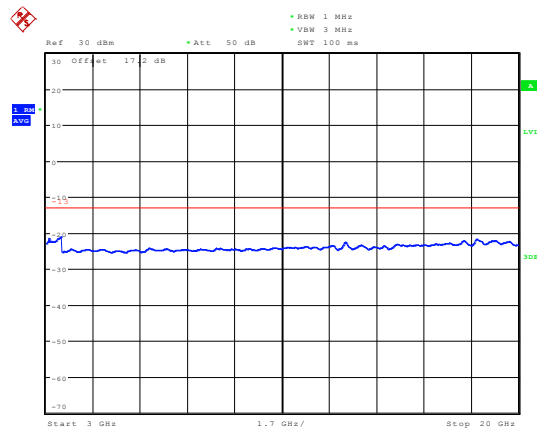

Date: 19.AUG.2019 20:56:22

5.8. Radiates Spurious Emission

Ambient condition

Temperature	Relative humidity	Pressure
23°C ~25°C	45%~50%	101.5kPa

Method of Measurement

1. The testing follows FCC KDB 971168 v03r01 Section 5.8 and ANSI C63.26 (2015).
2. Below 1GHz: The EUT is placed on a turntable 0.8 meters above the ground in the chamber, 3 meter away from the antenna. The maximal emission value is acquired by adjusting the antenna height, polarisation and turntable azimuth. Normally, the height range of antenna is 1 m to 4 m, the azimuth range of turntable is 0° to 360°, and the receive antenna has two polarizations Vertical (V) and Horizontal (H). Above 1GHz: (Note: the FCC's permission to use 1.5m as an alternative per TCBC Conf call of Dec. 2, 2014.) The EUT is placed on a turntable 1.5 meters above the ground in the chamber, 3 meter away from the antenna. The maximal emission value is acquired by adjusting the antenna height, polarisation and turntable azimuth. Normally, the height range of antenna is 1 m to 4 m, the azimuth range of turntable is 0° to 360°, and the receive antenna has two polarizations Vertical (V) and Horizontal (H).
3. A loop antenna, A log-periodic antenna or horn antenna shall be substituted in place of the EUT. The log-periodic antenna will be driven by a signal generator and the level will be adjusted till the same power value on the spectrum analyzer or receiver. The level of the spurious emissions can be calculated through the level of the signal generator, cable loss, the gain of the substitution antenna and the reading of the spectrum analyzer or receiver.
4. The EUT is then put into continuously transmitting mode at its maximum power level during the test. Set Test Receiver or Spectrum RBW=200Hz,VBW=600Hz for 9kHz150kHz , RBW=10kHz, VBW=30kHz 150kHz-30MHz , RBW=100kHz,VBW=300kHz for 30MHz to 1GHz and RBW=1MHz, VBW=3MHz for above 1GHz, And the maximum value of the receiver should be recorded as (Pr).
5. The EUT shall be replaced by a substitution antenna. In the chamber, an substitution antenna for the frequency band of interest is placed at the reference point of the chamber. An RF Signal source for the frequency band of interest is connected to the substitution antenna with a cable that has been constructed to not interfere with the radiation pattern of the antenna. A power (PMea) is applied to the input of the substitution antenna, and adjust the level of the signal generator output until the value of the receiver reach the previously recorded (Pr). The power of signal source (PMea) is recorded. The test should be performed by rotating the test item and adjusting the receiving antenna polarization.
6. A amplifier should be connected to the Signal Source output port. And the cable should be connect between the Amplifier and the Substitution Antenna. The cable loss (Pcl) ,the Substitution Antenna Gain (Ga) and the Amplifier Gain (PAg) should be recorded after test.
7. The measurement results are obtained as described below:
Power(EIRP)=PMea- PAg - Pcl + Ga
The measurement results are amend as described below:
Power(EIRP)=PMea- Pcl + Ga
8. This value is EIRP since the measurement is calibrated using an antenna of known gain (2.15 dBi)

and known input power. ERP can be calculated from EIRP by subtracting the gain of the dipole, $ERP = EIRP - 2.15\text{dBi}$.

The modulation mode and RB allocation refer to section 5.1, using the maximum output power configuration.

Test setup

9KHz ~ 30MHz

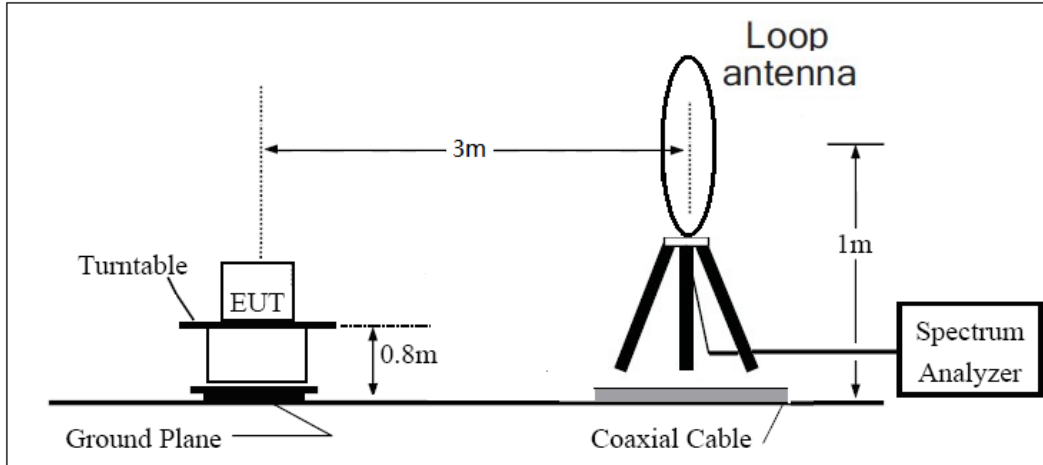

30MHz ~ 1GHz

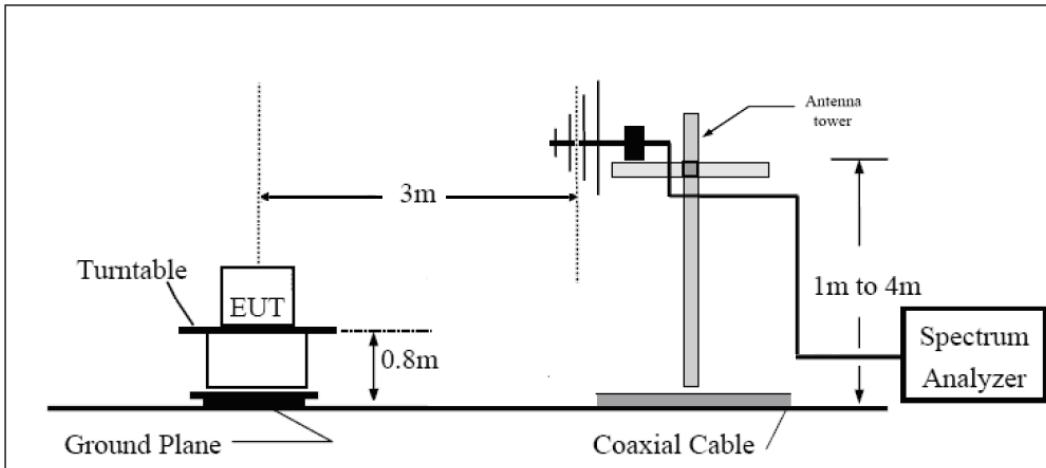

Above 1GHz

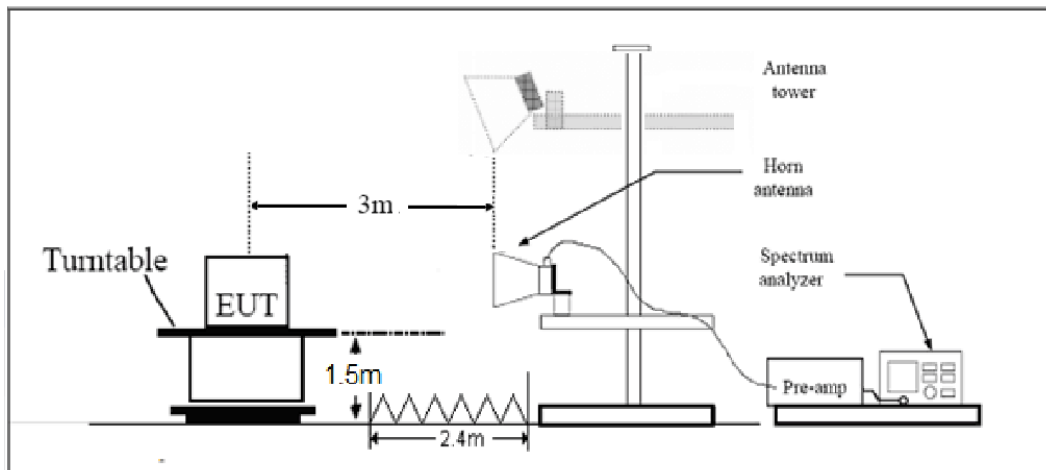



Note: Area side: 2.4mX3.6m

Limits

Rule Part 24.238(a) specifies that “on any frequency outside a licensee's frequency block, the power of any emission shall be attenuated below the transmitter power (P) by at least $43 + 10 \log_{10}(P)$ dB.”

Limit	-13 dBm
-------	---------

Measurement Uncertainty

The assessed measurement uncertainty to ensure 95% confidence level for the normal distribution is with the coverage factor $k = 1.96$, $U = 3.55$ dB.

Test Result

Sweep the whole frequency band through the range from 9kHz to the 10th harmonic of the carrier, the emissions below the noise floor will not be recorded in the report.

GSM 1900 CH-Middle

Harmonic	Frequency (MHz)	SG (dBm)	Cable Loss (dB)	Gain (dBi)	Antenna Polarization	EIRP Level (dBm)	Limit (dBm)	Margin (dB)	Azimuth (deg)
2	3759.9	-57.30	5.10	11.05	Horizontal	-51.35	-13.00	38.35	45
3	5640.2	-55.34	5.42	12.65	Horizontal	-48.11	-13.00	35.11	90
4	7519.5	-53.64	6.70	13.85	Horizontal	-46.49	-13.00	33.49	315
5	9402.8	-53.55	7.01	14.75	Horizontal	-45.81	-13.00	32.81	225
6	11279.3	-51.25	7.48	15.95	Horizontal	-42.78	-13.00	29.78	90
7	13159.1	-51.41	7.51	16.55	Horizontal	-42.37	-13.00	29.37	0
8	15041.3	-49.30	8.24	15.35	Horizontal	-42.19	-13.00	29.19	45
9	16922.3	-44.12	8.41	14.95	Horizontal	-37.58	-13.00	24.58	135
10	18800.0	-	-	-	-	-	-	-	-

Note: 1.The other Spurious RF Radiated emissions level is no more than noise floor.
 2. The worst emission was found in the antenna is Horizontal position.

LTE Band 2 1.4MHz CH-Middle

Harmonic	Frequency (MHz)	SG (dBm)	Cable Loss (dB)	Gain (dBi)	Antenna Polarization	EIRP Level (dBm)	Limit (dBm)	Margin (dB)	Azimuth (deg)
2	3759.0	-56.14	5.10	11.05	Horizontal	-50.19	-13.00	37.19	45
3	5638.9	-55.93	5.42	12.65	Horizontal	-48.70	-13.00	35.70	90
4	7520.0	-54.16	6.70	13.85	Horizontal	-47.01	-13.00	34.01	180
5	9400.0	-52.46	7.01	14.75	Horizontal	-44.72	-13.00	31.72	135
6	11280.0	-50.77	7.48	15.95	Horizontal	-42.30	-13.00	29.30	225
7	13160.0	-50.74	7.51	16.55	Horizontal	-41.70	-13.00	28.70	180
8	15040.0	-49.28	8.24	15.35	Horizontal	-42.17	-13.00	29.17	315
9	16920.0	-45.63	8.41	14.95	Horizontal	-39.09	-13.00	26.09	90
10	18800.0	-	-	-	-	-	-	-	-

Note: 1.The other Spurious RF Radiated emissions level is no more than noise floor.
 2. The worst emission was found in the antenna is Horizontal position.

LTE Band 2 5MHz CH-Middle

Harmonic	Frequency (MHz)	SG (dBm)	Cable Loss (dB)	Gain (dBi)	Antenna Polarization	EIRP Level (dBm)	Limit (dBm)	Margin (dB)	Azimuth (deg)
2	3760.0	-57.27	5.10	11.05	Horizontal	-51.32	-13.00	38.32	45
3	5640.0	-55.43	5.42	12.65	Horizontal	-48.20	-13.00	35.20	90
4	7520.0	-54.15	6.70	13.85	Horizontal	-47.00	-13.00	34.00	135
5	9400.0	-51.24	7.01	14.75	Horizontal	-43.50	-13.00	30.50	225
6	11280.0	-50.47	7.48	15.95	Horizontal	-42.00	-13.00	29.00	90
7	13160.0	-50.64	7.51	16.55	Horizontal	-41.60	-13.00	28.60	315
8	15040.0	-48.61	8.24	15.35	Horizontal	-41.50	-13.00	28.50	225
9	16920.0	-46.44	8.41	14.95	Horizontal	-39.90	-13.00	26.90	315
10	18800.0	-	-	-	-	-	-	-	-

Note: 1.The other Spurious RF Radiated emissions level is no more than noise floor.
 2. The worst emission was found in the antenna is Horizontal position.

LTE Band 2 20MHz CH-Middle

Harmonic	Frequency (MHz)	SG (dBm)	Cable Loss (dB)	Gain (dBi)	Antenna Polarization	EIRP Level (dBm)	Limit (dBm)	Margin (dB)	Azimuth (deg)
2	3760.0	-56.30	5.10	11.05	Horizontal	-50.35	-13.00	37.35	90
3	5640.0	-54.43	5.42	12.65	Horizontal	-47.20	-13.00	34.20	45
4	7520.0	-54.25	6.70	13.85	Horizontal	-47.10	-13.00	34.10	315
5	9400.0	-51.24	7.01	14.75	Horizontal	-43.50	-13.00	30.50	90
6	11280.0	-51.16	7.48	15.95	Horizontal	-42.69	-13.00	29.69	135
7	13160.0	-50.94	7.51	16.55	Horizontal	-41.90	-13.00	28.90	45
8	15040.0	-48.01	8.24	15.35	Horizontal	-40.90	-13.00	27.90	90
9	16920.0	-45.64	8.41	14.95	Horizontal	-39.10	-13.00	26.10	225
10	18800.0	-	-	-	-	-	-	-	-

Note: 1.The other Spurious RF Radiated emissions level is no more than noise floor.
 2. The worst emission was found in the antenna is Horizontal position.



LTE Band 25 1.4MHz CH-Middle

Harmonic	Frequency (MHz)	SG (dBm)	Cable Loss (dB)	Gain (dBi)	Antenna Polarization	EIRP Level (dBm)	Limit (dBm)	Margin (dB)	Azimuth (deg)
2	3759.0	-56.61	5.10	11.05	Horizontal	-50.66	-13.00	37.66	0
3	5638.9	-56.59	5.42	12.65	Horizontal	-49.36	-13.00	36.36	135
4	7520.0	-54.33	6.70	13.85	Horizontal	-47.18	-13.00	34.18	45
5	9400.0	-52.82	7.01	14.75	Horizontal	-45.08	-13.00	32.08	0
6	11280.0	-50.74	7.48	15.95	Horizontal	-42.27	-13.00	29.27	180
7	13160.0	-50.79	7.51	16.55	Horizontal	-41.75	-13.00	28.75	135
8	15040.0	-48.43	8.24	15.35	Horizontal	-41.32	-13.00	28.32	45
9	16920.0	-45.90	8.41	14.95	Horizontal	-39.36	-13.00	26.36	270
10	18800.0	-	-	-	-	-	-	-	-

Note: 1.The other Spurious RF Radiated emissions level is no more than noise floor.

2. The worst emission was found in the antenna is Horizontal position.

LTE Band 25 5MHz CH-Middle

Harmonic	Frequency (MHz)	SG (dBm)	Cable Loss (dB)	Gain (dBi)	Antenna Polarization	EIRP Level (dBm)	Limit (dBm)	Margin (dB)	Azimuth (deg)
2	3760.0	-57.59	5.10	11.05	Horizontal	-51.64	-13.00	34.02	90
3	5640.0	-56.73	5.42	12.65	Horizontal	-49.50	-13.00	32.05	45
4	7520.0	-54.17	6.70	13.85	Horizontal	-47.02	-13.00	29.35	0
5	9400.0	-52.79	7.01	14.75	Horizontal	-45.05	-13.00	28.25	180
6	11280.0	-50.82	7.48	15.95	Horizontal	-42.35	-13.00	28.52	90
7	13160.0	-50.29	7.51	16.55	Horizontal	-41.25	-13.00	26.51	270
8	15040.0	-48.63	8.24	15.35	Horizontal	-41.52	-13.00	28.52	45
9	16920.0	-46.05	8.41	14.95	Horizontal	-39.51	-13.00	26.51	90
10	18800.0	-	-	-	-	-	-	-	-

Note: 1.The other Spurious RF Radiated emissions level is no more than noise floor.

2. The worst emission was found in the antenna is Horizontal position.



LTE Band 25 20MHz CH-Middle

Harmonic	Frequency (MHz)	SG (dBm)	Cable Loss (dB)	Gain (dBi)	Antenna Polarization	EIRP Level (dBm)	Limit (dBm)	Margin (dB)	Azimuth (deg)
2	3760.0	-57.59	5.10	11.05	Horizontal	-51.64	-13.00	34.35	270
3	5640.0	-56.54	5.42	12.65	Horizontal	-49.31	-13.00	32.33	135
4	7520.0	-54.50	6.70	13.85	Horizontal	-47.35	-13.00	29.32	315
5	9400.0	-53.07	7.01	14.75	Horizontal	-45.33	-13.00	28.00	0
6	11280.0	-50.79	7.48	15.95	Horizontal	-42.32	-13.00	28.25	90
7	13160.0	-50.04	7.51	16.55	Horizontal	-41.00	-13.00	26.00	45
8	15040.0	-48.36	8.24	15.35	Horizontal	-41.25	-13.00	28.25	180
9	16920.0	-45.54	8.41	14.95	Horizontal	-39.00	-13.00	26.00	90
10	18800.0	-	-	-	-	-	-	-	-

Note: 1. The other Spurious RF Radiated emissions level is no more than noise floor.

2. The worst emission was found in the antenna is Horizontal position.

6. Main Test Instruments

Name	Manufacturer	Type	Serial Number	Calibration Date	Expiration Date
Base Station Simulator	R&S	CMU200	118133	2019-05-19	2020-05-18
Base Station Simulator	R&S	CMW500	113824	2019-05-19	2020-05-18
Power Splitter	Hua Xiang	SHX-GF2-2-13	10120101	/	/
Spectrum Analyzer	Key sight	N9010A	MY50210259	2019-05-19	2020-05-18
Universal Radio Communication Tester	Key sight	E5515C	MY48367192	2019-05-19	2020-05-18
Signal Analyzer	R&S	FSV30	100815	2018-12-16	2019-12-15
Loop Antenna	SCHWARZBECK	FMZB1519	1519-047	2017-09-26	2019-09-25
Trilog Antenna	SCHWARZBECK	VUBL 9163	9163-201	2017-11-18	2019-11-17
Horn Antenna	R&S	HF907	100126	2018-07-07	2020-07-06
Horn Antenna	ETS-Lindgren	3160-09	00102643	2018-06-20	2020-06-19
Signal generator	R&S	SMB 100A	102594	2019-05-19	2020-05-18
Climatic Chamber	ESPEC	SU-242	93000506	2017-12-17	2020-12-16
Preampflifier	R&S	SCU18	102327	2019-05-19	2020-05-18
MOB COMMS DC SUPPLY	Keysight	66319D	MY43004105	2019-05-19	2020-05-18
RF Cable	Agilent	SMA 15cm	0001	2019-06-14	2019-09-13
Software	R&S	EMC32	9.26.0	/	/

*****END OF REPORT *****