



RF TEST REPORT

Applicant Quectel Wireless Solutions Co., Ltd
FCC ID XMR201910BG95M3
Product LTE Cat M1 & Cat NB2 & EGPRS Module
Brand Quectel
Model BG95-M3
Report No. R2003A0152-R2
Issue Date May 22, 2020

TA Technology (Shanghai) Co., Ltd. tested the above equipment in accordance with the requirements in **FCC CFR47 Part 2 (2019)/ FCC CFR 47 Part 24E (2019)**. The test results show that the equipment tested is capable of demonstrating compliance with the requirements as documented in this report.

Performed by: Peng Tao

Approved by: Kai Xu

TA Technology (Shanghai) Co., Ltd.

No.145, Jintang Rd, Tangzhen Industry Park, Pudong Shanghai, China

TEL: +86-021-50791141/2/3

FAX: +86-021-50791141/2/3-8000



TABLE OF CONTENT

1. Test Laboratory	4
1.1. Notes of the test report.....	4
1.2. Test facility.....	4
1.3. Testing Location	4
2. General Description of Equipment under Test.....	5
3. Applied Standards.....	6
4. Test Configuration.....	7
5. Test Case Results.....	9
5.1. RF Power Output.....	9
5.2. Effective Isotropic Radiated Power	13
5.3. Occupied Bandwidth	18
5.4. Band Edge Compliance.....	27
5.5. Peak-to-Average Power Ratio (PAPR)	45
5.6. Frequency Stability.....	48
5.7. Spurious Emissions at Antenna Terminals	52
5.8. Radiates Spurious Emission	73
6. Main Test Instruments	80

Summary of measurement results

No.	Test Case	Clause in FCC rules	Verdict
1	RF power output	2.1046	PASS
2	Effective Isotropic Radiated power	24.232(c)	PASS
3	Occupied Bandwidth	2.1049	PASS
4	Band Edge Compliance	2.1051 /24.238(a)	PASS
5	Peak-to-Average Power Ratio	24.232/KDB 971168 D01(5.7)	PASS
6	Frequency Stability	2.1055 / 24.235	PASS
7	Spurious Emissions at Antenna Terminals	2.1051 / 24.238(a)	PASS
8	Radiates Spurious Emission	2.1053 / 24.238(a)	PASS

Date of Testing: August 20, 2019 ~ September 5, 2019

Note: PASS: The EUT complies with the essential requirements in the standard.

FAIL: The EUT does not comply with the essential requirements in the standard.

All indications of Pass/Fail in this report are opinions expressed by TA Technology (Shanghai) Co., Ltd. based on interpretations and/or observations of test results. Measurement Uncertainties were not taken into account and are published for informational purposes only.

There is no test for BG95-M3 in this report(Report No.:R2003A0152-R2).All test values duplicated from the BG95-M3 report (Report No. : R1907A0446-R2). The detailed product change description please refers to the *Statement letter*.



1. Test Laboratory

1.1. Notes of the test report

This report shall not be reproduced in full or partial, without the written approval of **TA technology (shanghai) co., Ltd.** The results documented in this report apply only to the tested sample, under the conditions and modes of operation as described herein. Measurement Uncertainties were not taken into account and are published for informational purposes only. This report is written to support regulatory compliance of the applicable standards stated above.

1.2. Test facility

FCC (Designation number: CN1179, Test Firm Registration Number: 446626)

TA Technology (Shanghai) Co., Ltd. has been listed on the US Federal Communications Commission list of test facilities recognized to perform electromagnetic emissions measurements.

A2LA (Certificate Number: 3857.01)

TA Technology (Shanghai) Co., Ltd. has been listed by American Association for Laboratory Accreditation to perform electromagnetic emission measurement.

1.3. Testing Location

Company: TA Technology (Shanghai) Co., Ltd.
Address: No.145, Jintang Rd, Tangzhen Industry Park, Pudong
City: Shanghai
Post code: 201201
Country: P. R. China
Contact: Xu Kai
Telephone: +86-021-50791141/2/3
Fax: +86-021-50791141/2/3-8000
Website: <http://www.ta-shanghai.com>
E-mail: xukai@ta-shanghai.com

2. General Description of Equipment under Test

Client Information

Applicant	Quectel Wireless Solutions Co., Ltd
Applicant address	Building 5, Shanghai Business Park Phase III (Area B), No.1016 Tianlin Road, Minhang District, Shanghai, China 200233
Manufacturer	Quectel Wireless Solutions Co., Ltd
Manufacturer address	Building 5, Shanghai Business Park Phase III (Area B), No.1016 Tianlin Road, Minhang District, Shanghai, China 200233

General information

EUT Description			
Model	BG95-M3		
IMEI	864475040001736		
Hardware Version	R2.1		
Software Version	BG95MR3LAR02A03		
Power Supply	External power supply		
Antenna Type	The EUT don't have standard Antenna, The Antenna used for testing in this report is the after-market accessory (Dipole Antenna)		
Antenna Gain	GSM 1900:1.6dBi LTE Band 2:1.6dBi LTE Band 25:1.7dBi		
Test Mode(s)	GSM1900; LTE Band 2/25;		
Test Modulation	(GSM)GMSK,8PSK; (LTE)QPSK,16QAM		
GPRS Multislot Class	33		
EGPRS Multislot Class	33		
LTE Category	M1		
Maximum E.I.R.P	GSM 1900:	31.43dBm	
	LTE Band 2:	22.52dBm	
	LTE Band 25:	22.21dBm	
Rated Power Supply Voltage	3.8V		
Extreme Voltage	Minimum: 3.3V Maximum: 4.3V		
Extreme Temperature	Lowest: -40°C Highest: +85°C		
Frequency Range(s)	Band	Tx (MHz)	Rx (MHz)
	GSM1900	1850 ~ 1910	1930 ~ 1990
	LTE Band 2	1850 ~ 1910	1930 ~ 1990
	LTE Band 25	1850 ~ 1915	1930 ~ 1995
Note: 1. The EUT is sent from the applicant to TA and the information of the EUT is declared by the applicant.			

3. Applied Standards

According to the specifications of the manufacturer, it must comply with the requirements of the following standards:

Test standards:

FCC CFR 47 Part 24E (2019)

ANSI C63.26 (2015)

Reference standard:

FCC CFR47 Part 2 (2019)

KDB 971168 D01 Power Meas License Digital Systems v03r01

4. Test Configuration

Radiated measurements are performed by rotating the EUT in three different orthogonal test planes. EUT stand-up position (Z axis), lie-down position (X, Y axis). Receiver antenna polarization (horizontal and vertical), the worst emission was found in position (X axis, horizontal polarization) and the worst case was recorded.

All mode and data rates and positions and RB size and modulations were investigated.

Subsequently, only the worst case emissions are reported.

The following testing in GSM/ LTE is set based on the maximum RF Output Power.

Test modes are chosen to be reported as the worst case configuration below:

Test items	Modes/Modulation
	GSM 1900
RF power output	GSM GPRS EGPRS
Effective Isotropic Radiated power	GSM GPRS(1Tx slot) EGPRS(1Tx slot)
Occupied Bandwidth	GSM GPRS(1Tx slot) EGPRS(1Tx slot)
Band Edge Compliance	GSM GPRS(1Tx slot) EGPRS(1Tx slot)
Peak-to-Average Power Ratio	GSM GPRS(1Tx slot) EGPRS(1Tx slot)
Frequency Stability	GSM GPRS(1Tx slot) EGPRS(1Tx slot)
Spurious Emissions at Antenna Terminals	GSM
Radiates Spurious Emission	GSM



Test modes are chosen to be reported as the worst case configuration below for LTE Band 2/25:

Test items	Modes	Bandwidth (MHz)						Modulation		RB			Test Channel			
		1.4	3	5	10	15	20	QPSK	16QAM	1	50%	100%	L	M	H	
RF power output	LTE 2	O	O	O	O	O	O	O	O	O	O	O	O	O	O	O
	LTE 25	O	O	O	O	O	O	O	O	O	O	O	O	O	O	O
Effective Isotropic Radiated power	LTE 2	O	O	O	O	O	O	O	O	O	O	O	O	O	O	O
	LTE 25	O	O	O	O	O	O	O	O	O	O	O	O	O	O	O
Occupied Bandwidth	LTE 2	O	O	O	O	O	O	O	O	-	-	O	-	O	-	-
	LTE 25	O	O	O	O	O	O	O	O	-	-	O	-	O	-	-
Band Edge Compliance	LTE 2	O	O	O	O	O	O	O	O	O	-	O	O	-	O	-
	LTE 25	O	O	O	O	O	O	O	O	O	-	O	O	-	O	-
Peak-to-Average Power Ratio	LTE 2	O	O	O	O	O	O	O	O	-	-	O	-	O	-	-
	LTE 25	O	O	O	O	O	O	O	O	-	-	O	-	O	-	-
Frequency Stability	LTE 2	O	O	O	O	O	O	O	O	O	O	O	O	O	O	O
	LTE 25	O	O	O	O	O	O	O	O	O	O	O	O	O	O	O
Conducted Spurious Emissions	LTE 2	O	O	O	O	O	O	O	-	O	-	-	O	O	O	O
	LTE 25	O	O	O	O	O	O	O	-	O	-	-	O	O	O	O
Radiates Spurious Emission	LTE 2	O	-	O	-	-	O	O	-	O	-	-	O	O	O	O
	LTE 25	O	-	O	-	-	O	O	-	O	-	-	O	O	O	O
Note	1. The mark "O" means that this configuration is chosen for testing. 2. The mark "-" means that this configuration is not testing.															

5. Test Case Results

5.1.RF Power Output

Ambient condition

Temperature	Relative humidity	Pressure
23°C ~25°C	45%~50%	101.5kPa

Methods of Measurement

During the process of the testing, The EUT is controlled by the Base Station Simulator to ensure max power transmission and proper modulation.

Test Setup

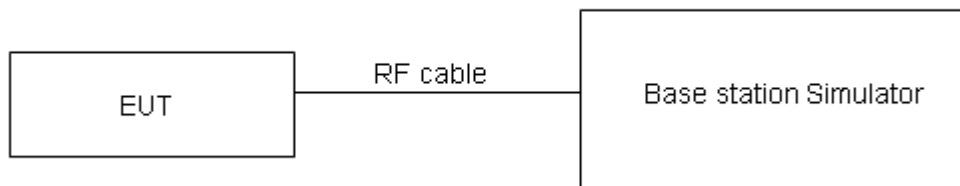

The loss between RF output port of the EUT and the input port of the tester has been taken into consideration.

Limits

No specific RF power output requirements in part 2.1046.

Measurement Uncertainty

The assessed measurement uncertainty to ensure 95% confidence level for the normal distribution is with the coverage factor $k = 2$, $U = 0.4$ dB.



Test Results

GSM 1900		Conducted Power(dBm)		
		Channel 512	Channel 661	Channel 810
		1850.2(MHz)	1880(MHz)	1909.8(MHz)
GSM	Results	29.83	29.74	29.71
GPRS/EGPRS (GMSK)	1TXslot	29.80	29.66	29.59
	2TXslots	28.56	28.71	28.50
	3TXslots	27.90	27.53	27.22
	4TXslots	26.26	25.87	25.56
EGPRS (8PSK)	1TXslot	25.23	25.17	24.78
	2TXslots	24.20	24.04	24.01
	3TXslots	22.45	22.01	21.94
	4TXslots	21.23	21.02	20.74

LTE Band 2	Channel/ Frequency(MHz)	Index	RB# RBstart	Conducted Power (dBm)	
				QPSK	16QAM
1.4MHz	18607/1850.7	0	1#0	20.92	19.64
		0	6#0	18.71	19.02
	18900/1880	0	1#0	19.87	19.61
		0	6#0	18.38	18.19
	19193/1909.3	0	1#5	20.17	19.08
		0	6#0	18.35	18.68
3MHz	18615/1851.5	0	1#0	20.38	19.68
		0	6#0	18.78	18.91
	18900/1880	0	1#0	20.21	19.27
		0	6#0	18.45	18.73
	19185/1908.5	1	1#5	20.02	19.11
		1	6#0	18.41	18.74
5MHz	18625/1852.5	0	1#0	20.08	20.29
		0	6#0	19.47	19.66
	18900/1880	0	1#0	20.05	19.71
		0	6#0	19.24	19.38
	19175/1907.5	0	1#5	19.68	20.02
		3	6#0	19.28	19.40
10MHz	18650/1855	3	1#0	19.92	20.19
		0	4#0	20.07	19.83
	18900/1880	0	1#0	19.96	19.53
		0	4#0	19.78	20.11
	19150/1905	4	1#5	19.88	19.51
		7	4#2	20.01	20.14



15MHz	18675/1857.5	3	1#0	20.22	20.11
		0	6#0	20.13	20.26
	18900/1880	0	1#0	20.14	19.81
		0	6#0	20.05	19.95
	19125/1902.5	8	1#5	19.95	19.51
		11	6#0	19.88	19.87
20MHz	18700/1860	3	1#0	20.17	19.96
		0	6#0	20.08	20.01
	18900/1880	0	1#0	19.90	19.59
		0	6#0	19.86	19.97
	19100/1900	12	1#5	19.76	19.34
		15	6#0	19.83	20.04

LTE Band 25	Channel/ Frequency(MHz)	Index	RB# RBstart	Conducted Power (dBm)	
				QPSK	16QAM
1.4MHz	26047/1850.7	0	1#0	20.51	19.47
		0	6#0	18.36	18.71
	26365/1882.5	0	1#0	19.61	19.32
		0	6#0	17.95	17.89
	26683/1914.3	0	1#5	19.55	19.71
		0	6#0	18.31	18.13
3MHz	26055/1851.5	0	1#0	19.90	19.63
		0	6#0	18.24	18.21
	26365/1882.5	0	1#0	19.68	19.44
		0	6#0	18.13	18.02
	26675/1913.5	1	1#5	19.72	19.58
		1	6#0	18.21	18.19
5MHz	26065/1852.5	0	1#0	19.89	20.03
		0	6#0	19.31	19.45
	26365/1882.5	0	1#0	19.67	19.96
		0	6#0	19.13	19.21
	26665/1912.5	0	1#5	19.66	19.88
		3	6#0	19.33	19.48
10MHz	26090/1855	3	1#0	19.78	19.93
		0	4#0	19.79	19.63
	26365/1882.5	0	1#0	19.68	19.98
		0	4#0	19.67	19.47
	26640/1910	4	1#5	19.64	19.94
		7	4#2	19.78	19.52
15MHz	26115/1857.5	3	1#0	19.88	19.97
		0	6#0	19.81	19.91
	26365/1882.5	0	1#0	19.71	19.98
		0	6#0	19.75	19.84



	26615/1907.5	8	1#5	19.68	19.89
		11	6#0	19.78	19.89
20MHz	26140/1860	3	1#0	19.71	19.94
		0	6#0	19.87	19.93
	26365/1882.5	0	1#0	19.67	19.85
		0	6#0	19.76	19.84
	26590/1905	12	1#5	19.73	19.87
		15	6#0	19.81	19.93

5.2. Effective Isotropic Radiated Power

Ambient condition

Temperature	Relative humidity	Pressure
23°C ~25°C	45%~50%	101.5kPa

Methods of Measurement

The testing follows FCC KDB 971168 v03r01 Section 5.8 and ANSI C63.26 (2015).

- a) Connect the equipment as illustrated. Mount the equipment with the manufacturer specified antenna in a vertical orientation on a manufacturer specified mounting surface located on a non-conducting rotating platform of a RF anechoic chamber (preferred) or a standard radiation site.
- b) Key the transmitter, then rotate the EUT 360° azimuthally and record spectrum analyzer power level (LVL) measurements at angular increments that are sufficiently small to permit resolution of all peaks. If a standard radiation test site is used, raise and lower the test antenna to obtain a maximum reading at each angular increment. (Note: several batteries may be needed to offset the effect of battery voltage droop, which should not exceed 5% of the manufactured specified battery voltage during transmission).
- c) Replace the transmitter under test with a vertically polarized half-wave dipole (or an antenna whose gain is known relative to an ideal half-wave dipole). The center of the antenna should be at the same location as the center of the antenna under test.
- d) Connect the antenna to a signal generator with a known output power and record the path loss (in dB) as LOSS. If a standard radiation test site is used, raise and lower the test antenna to obtain a maximum reading. $LOSS = \text{Generator Output Power (dBm)} - \text{Analyzer reading (dBm)}$
- e) Determine the effective radiated output power at each angular position from the readings in steps b) and d) using the following equation: $ERP \text{ (dBm)} = \text{LVL (dBm)} + \text{LOSS (dB)}$
- f) The maximum ERP is the maximum value determined in the preceding step.
- g) When calculating ERP, in addition to knowing the antenna radiation and matching characteristics, it is necessary to know the loss values of all elements (e.g. transmission line attenuation, mismatches, filters, combiners) interposed between the point where transmitter output power is measured, and the point where power is applied to the antenna. ERP can then be calculated as follows:
 $EIRP \text{ (dBm)} = \text{Output Power (dBm)} - \text{Losses (dB)} + \text{Antenna Gain (dBi)}$
where: dBi refers to gain relative to an ideal dipole.
 $EIRP \text{ (dBm)} = ERP \text{ (dBm)} + 2.15 \text{ (dB)}$

The RB allocation refers to section 5.1, using the maximum output power configuration.

Test setup

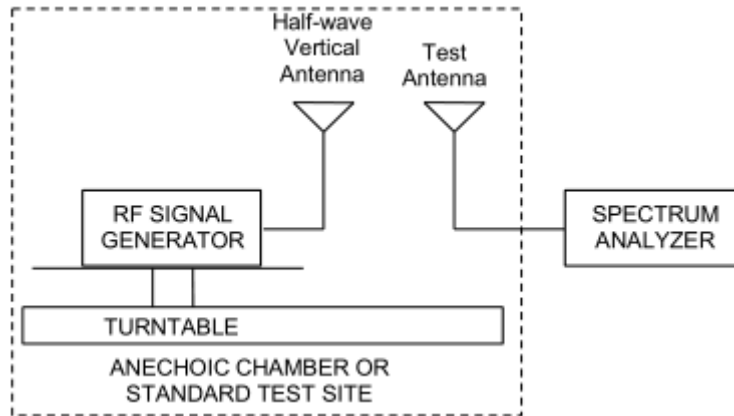
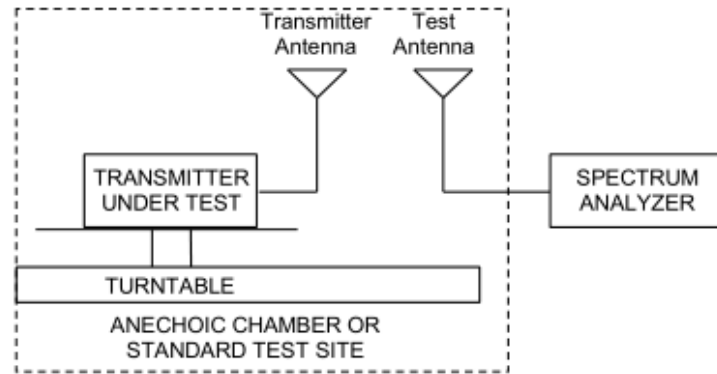

Limits

Rule Part 24.232(c) Mobile and portable stations are limited to 2 watts EIRP.

Rule Part 24.232(e) Peak transmit power must be measured over any interval of continuous transmission using instrumentation calibrated in terms of an rms-equivalent voltage.

Limit	$\leq 2 \text{ W}$ (33 dBm)
-------	-----------------------------

Measurement Uncertainty

The assessed measurement uncertainty to ensure 95% confidence level for the normal distribution is with the coverage factor $k = 2$, $U = 1.19 \text{ dB}$

**Test Results:**

The measurement is performed for both of horizontal and vertical antenna Polarization, and only the data of worst mode is recorded in this report.

Mode	Channel	Frequency (MHz)	Polarization	EIRP (dBm)	Limit (dBm)	Conclusion
GSM 1900	Low	1850.2	Horizontal	31.43	33	Pass
	Mid	1880	Horizontal	31.34	33	Pass
	High	1909.8	Horizontal	31.31	33	Pass
GPRS 1900	Low	1850.2	Horizontal	31.40	33	Pass
	Mid	1880	Horizontal	31.26	33	Pass
	High	1909.8	Horizontal	31.19	33	Pass
EGPRS 1900	Low	1850.2	Horizontal	26.83	33	Pass
	Mid	1880	Horizontal	26.77	33	Pass
	High	1909.8	Horizontal	26.38	33	Pass

LTE Band 2							
Band2	Channel/ Frequency(MHz)	Index	RB# RBstart	EIRP(dBm)		Limit (dBm)	Conclusion
				QPSK	16QAM		
1.4MHz	18607/1850.7	0	1#0	22.52	21.24	33	Pass
		0	6#0	20.31	20.62	33	Pass
	18900/1880	0	1#0	21.47	21.21	33	Pass
		0	6#0	19.98	19.79	33	Pass
	19193/1909.3	0	1#5	21.77	20.68	33	Pass
		0	6#0	19.95	20.28	33	Pass
3MHz	18615/1851.5	0	1#0	21.98	21.28	33	Pass
		0	6#0	20.38	20.51	33	Pass
	18900/1880	0	1#0	21.81	20.87	33	Pass
		0	6#0	20.05	20.33	33	Pass
	19185/1908.5	1	1#5	21.62	20.71	33	Pass
		1	6#0	20.01	20.34	33	Pass
5MHz	18625/1852.5	0	1#0	21.68	21.89	33	Pass
		0	6#0	21.07	21.26	33	Pass
	18900/1880	0	1#0	21.65	21.31	33	Pass
		0	6#0	20.84	20.98	33	Pass
	19175/1907.5	0	1#5	21.28	21.62	33	Pass
		3	6#0	20.88	21.00	33	Pass
10MHz	18650/1855	3	1#0	21.52	21.79	33	Pass
		0	4#0	21.67	21.43	33	Pass
	18900/1880	0	1#0	21.56	21.13	33	Pass
		0	4#0	21.38	21.71	33	Pass



	19150/1905	4	1#5	21.48	21.11	33	Pass
		7	4#2	21.61	21.74	33	Pass
15MHz	18675/1857.5	3	1#0	21.82	21.71	33	Pass
		0	6#0	21.73	21.86	33	Pass
	18900/1880	0	1#0	21.74	21.41	33	Pass
		0	6#0	21.65	21.55	33	Pass
	19125/1902.5	8	1#5	21.55	21.11	33	Pass
		11	6#0	21.48	21.47	33	Pass
20MHz	18700/1860	3	1#0	21.77	21.56	33	Pass
		0	6#0	21.68	21.61	33	Pass
	18900/1880	0	1#0	21.50	21.19	33	Pass
		0	6#0	21.46	21.57	33	Pass
	19100/1900	12	1#5	21.36	20.94	33	Pass
		15	6#0	21.43	21.64	33	Pass

LTE Band 25							
Band2	Channel/ Frequency(MHz)	Index	RB# RBstart	EIRP(dBm)		Limit (dBm)	Conclusion
				QPSK	16QAM		
1.4MHz	26047/1850.7	0	1#0	22.21	21.17	33	Pass
		0	6#0	20.06	20.41	33	Pass
	26365/1882.5	0	1#0	21.31	21.02	33	Pass
		0	6#0	19.65	19.59	33	Pass
	26683/1914.3	0	1#5	21.25	21.41	33	Pass
		0	6#0	20.01	19.83	33	Pass
3MHz	26055/1851.5	0	1#0	21.60	21.33	33	Pass
		0	6#0	19.94	19.91	33	Pass
	26365/1882.5	0	1#0	21.38	21.14	33	Pass
		0	6#0	19.83	19.72	33	Pass
	26675/1913.5	1	1#5	21.42	21.28	33	Pass
		1	6#0	19.91	19.89	33	Pass
5MHz	26065/1852.5	0	1#0	21.59	21.73	33	Pass
		0	6#0	21.01	21.15	33	Pass
	26365/1882.5	0	1#0	21.37	21.66	33	Pass
		0	6#0	20.83	20.91	33	Pass
	26665/1912.5	0	1#5	21.36	21.58	33	Pass
		3	6#0	21.03	21.18	33	Pass
10MHz	26090/1855	3	1#0	21.48	21.63	33	Pass
		0	4#0	21.49	21.33	33	Pass
	26365/1882.5	0	1#0	21.38	21.68	33	Pass
		0	4#0	21.37	21.17	33	Pass
	26640/1910	4	1#5	21.34	21.64	33	Pass



		7	4#2	21.48	21.22	33	Pass
15MHz	26115/1857.5	3	1#0	21.58	21.67	33	Pass
		0	6#0	21.51	21.61	33	Pass
	26365/1882.5	0	1#0	21.41	21.68	33	Pass
		0	6#0	21.45	21.54	33	Pass
	26615/1907.5	8	1#5	21.38	21.59	33	Pass
		11	6#0	21.48	21.59	33	Pass
20MHz	26140/1860	3	1#0	21.41	21.64	33	Pass
		0	6#0	21.57	21.63	33	Pass
	26365/1882.5	0	1#0	21.37	21.55	33	Pass
		0	6#0	21.46	21.54	33	Pass
	26590/1905	12	1#5	21.43	21.57	33	Pass
		15	6#0	21.51	21.63	33	Pass

5.3.Occupied Bandwidth

Ambient condition

Temperature	Relative humidity	Pressure
23°C ~25°C	45%~50%	101.5kPa

Method of Measurement

The EUT was connected to Spectrum Analyzer and Base Station Simulator via power Splitter. The occupied bandwidth is measured using spectrum analyzer.

RBW is set to 3kHz, VBW is set to 10kHz for GSM 1900,

RBW is set to 51kHz, VBW is set to 160kHz for LTE Band 2/25

99% power and -26dBc occupied bandwidths are recorded. Spectrum analyzer plots are included on the following pages.

Test Setup

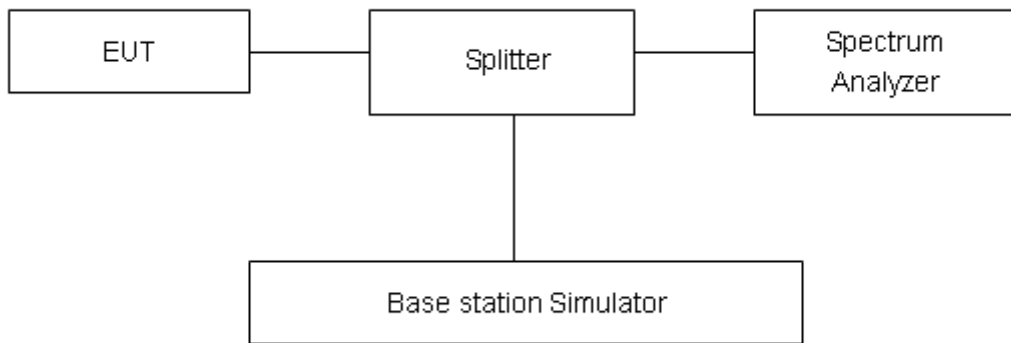

Limits

No specific occupied bandwidth requirements in part 2.1049.

Measurement Uncertainty

The assessed measurement uncertainty to ensure 95% confidence level for the normal distribution is with the coverage factor $k = 2$, $U = 624\text{Hz}$.

Test Result

Mode	Channel	Frequency (MHz)	99% Power Bandwidth (MHz)	-26dBc Bandwidth(MHz)
GSM 1900 (GMSK)	512	1850.2	0.24588	0.2997
	661	1880.0	0.24074	0.2996
	810	1909.8	0.24657	0.3002
GPRS 1900 (GMSK)	512	1850.2	0.24343	0.3139
	661	1880.0	0.24206	0.305
	810	1909.8	0.24476	0.3112
EGPRS 1900 (8-PSK)	512	1850.2	0.24864	0.3152
	661	1880.0	0.24666	0.3106
	810	1909.8	0.24646	0.3178

Mode	Bandwidth	Modulation	Channel/ Frequency(MHz)	RB	Index	Bandwidth(MHz)	
						99% Power	-26dBc
Band2	1.4MHz	QPSK	18900/1880	6#0	0	1.1068	1.361
		16QAM	18900/1880	6#0	0	0.9417	1.167
	3MHz	QPSK	18900/1880	6#0	0	1.1172	1.453
		16QAM	18900/1880	6#0	0	0.9577	1.432
	5MHz	QPSK	18900/1880	6#0	0	1.1239	1.363
		16QAM	18900/1880	6#0	0	0.9488	1.183
	10MHz	QPSK	18900/1880	6#0	0	1.1139	1.325
		16QAM	18900/1880	6#0	0	0.9723	1.212
	15MHz	QPSK	18900/1880	6#0	0	1.1262	1.349
		16QAM	18900/1880	6#0	0	0.9697	1.253
	20MHz	QPSK	18900/1880	6#0	0	1.1323	1.355
		16QAM	18900/1880	6#0	0	0.965	1.247

Mode	Bandwidth	Modulation	Channel/ Frequency(MHz)	RB	Index	Bandwidth(MHz)	
						99% Power	-26dBc
Band25	1.4MHz	QPSK	26365/1882.5	6#0	0	1.1056	1.359
		16QAM	26365/1882.5	6#0	0	0.9446	1.162
	3MHz	QPSK	26365/1882.5	6#0	0	1.1135	1.327
		16QAM	26365/1882.5	6#0	0	0.9518	1.172



5MHz	QPSK	26365/1882.5	6#0	0	1.1132	1.33
	16QAM	26365/1882.5	6#0	0	0.9514	1.1216
10MHz	QPSK	26365/1882.5	6#0	0	1.1223	1.334
	16QAM	26365/1882.5	6#0	0	0.966	1.222
15MHz	QPSK	26365/1882.5	6#0	0	1.1283	1.375
	16QAM	26365/1882.5	6#0	0	0.9671	1.243
20MHz	QPSK	26365/1882.5	6#0	0	1.124	1.369
	16QAM	26365/1882.5	6#0	0	0.9653	1.255

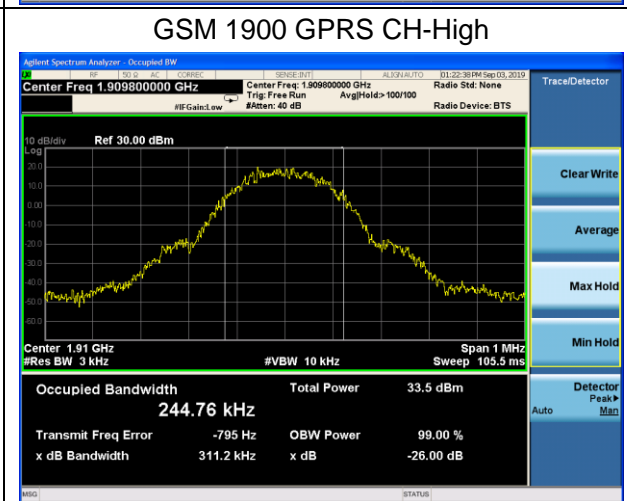
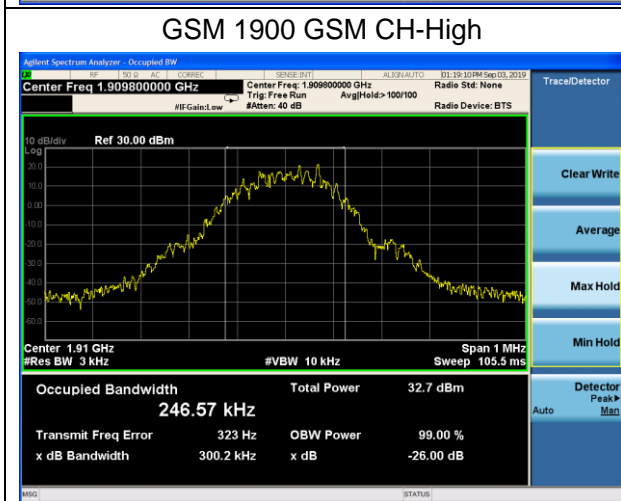
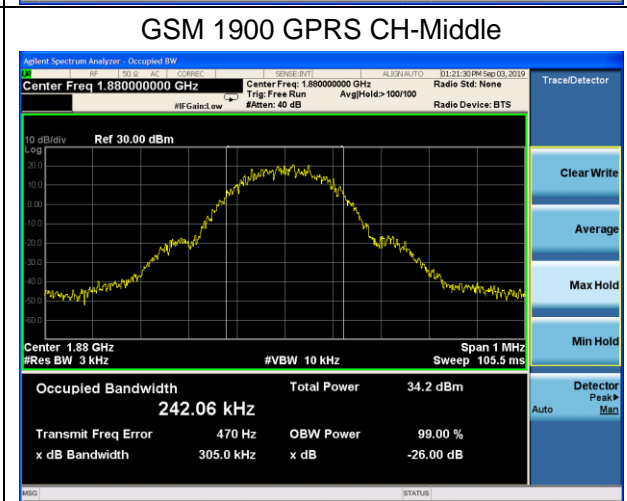
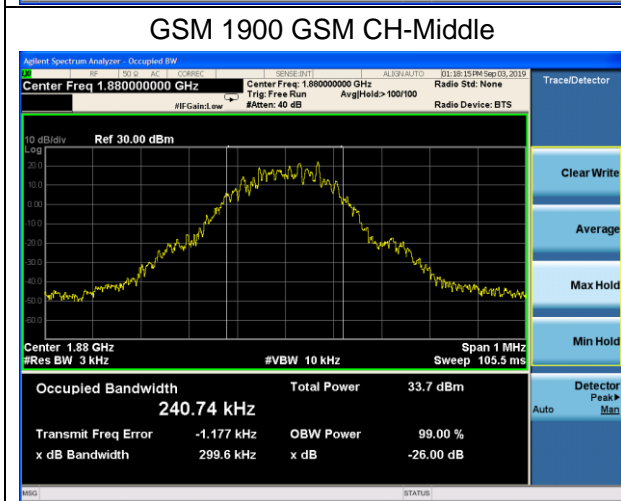
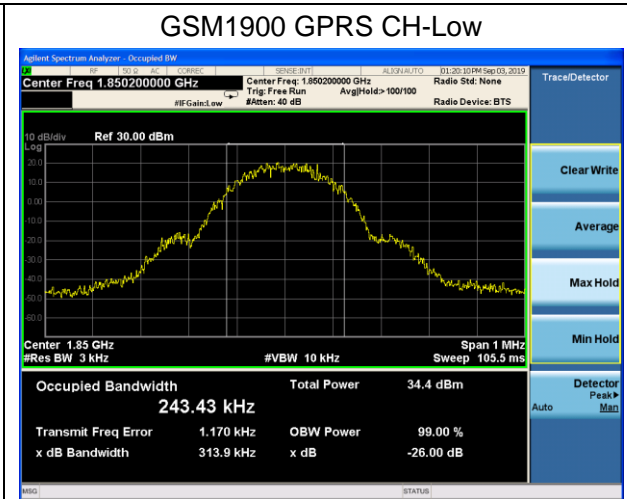
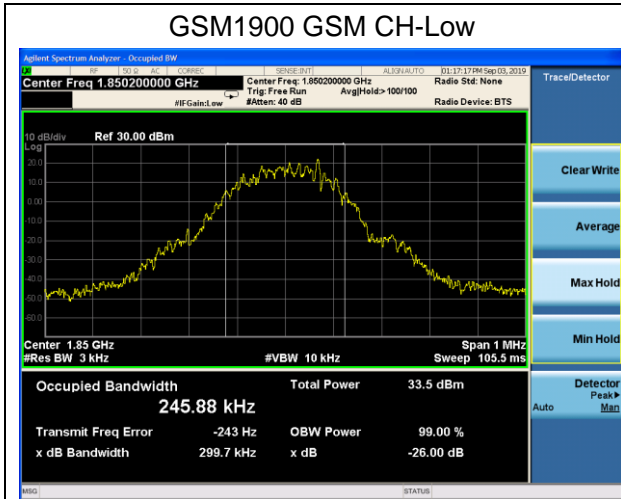

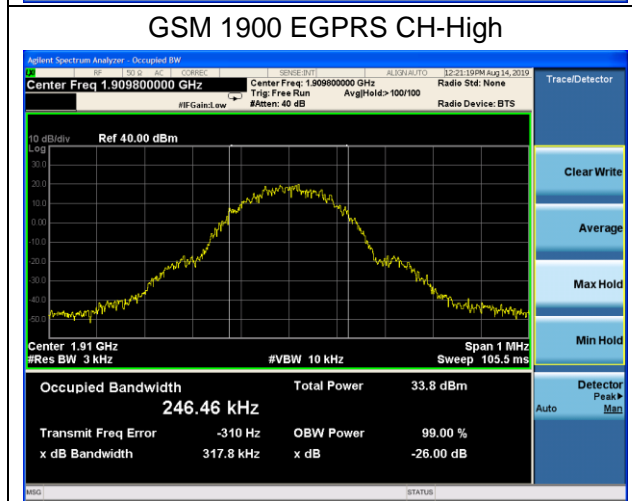
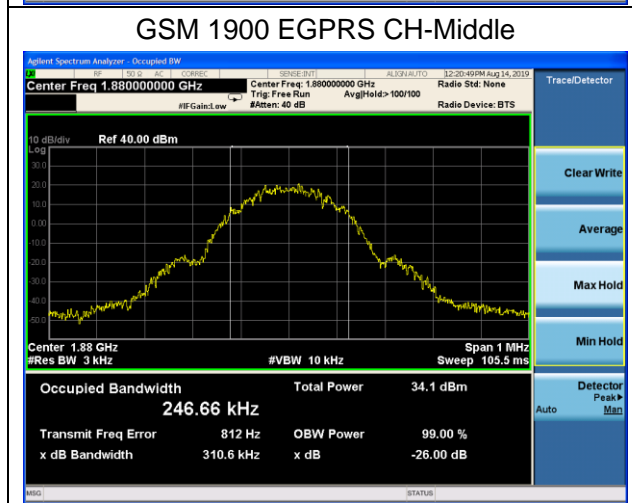
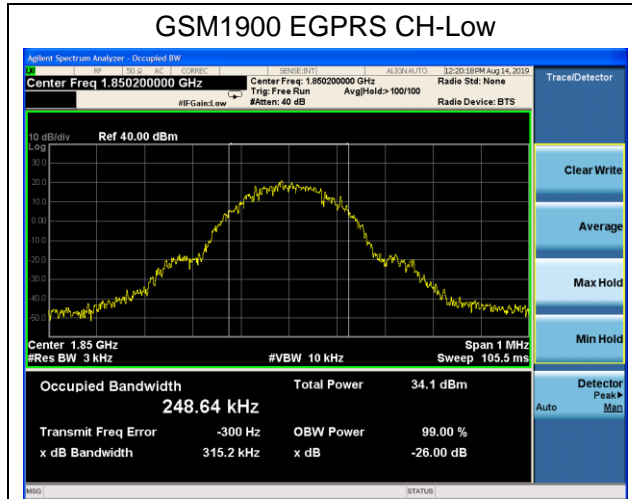

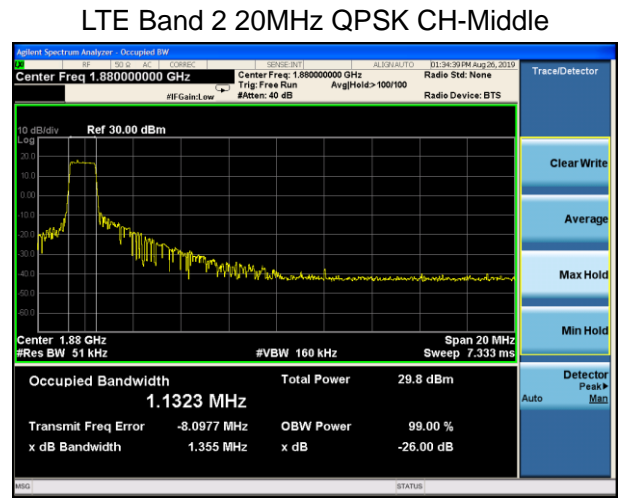
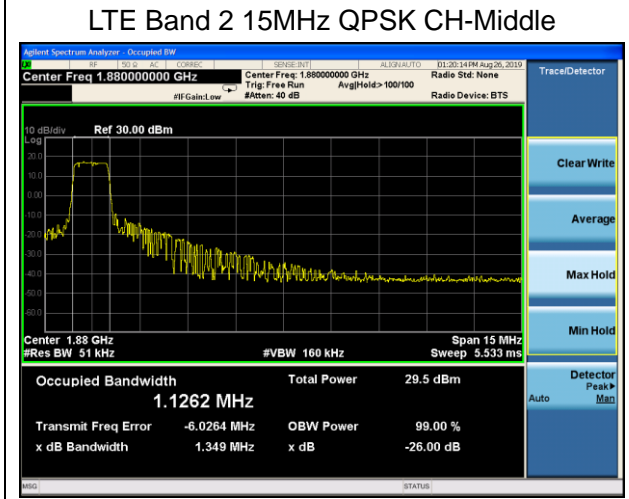
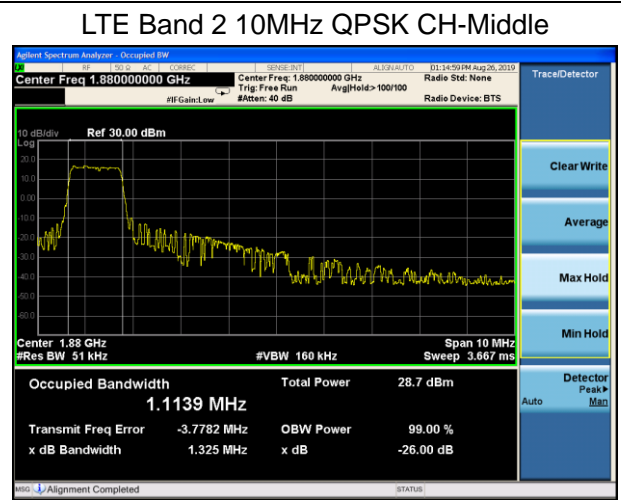
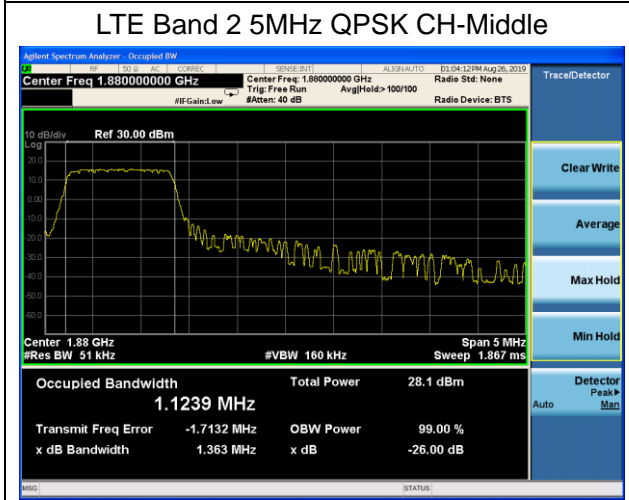
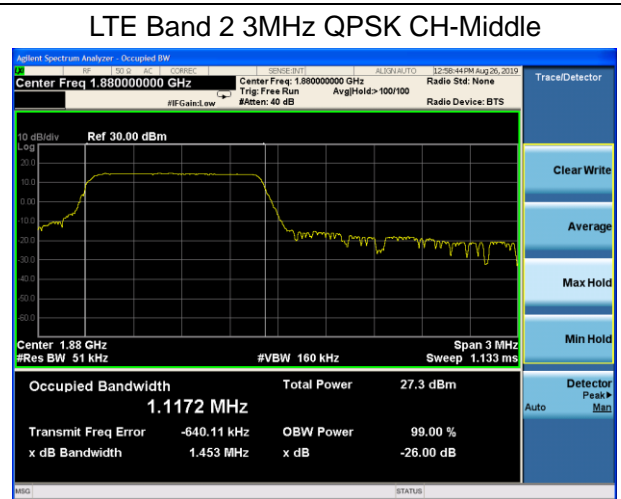
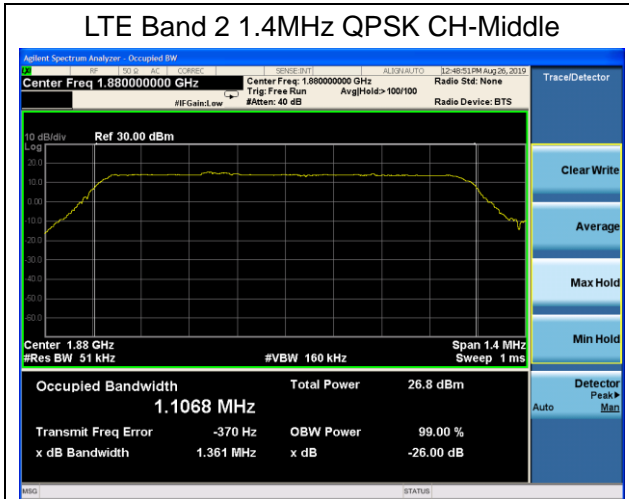

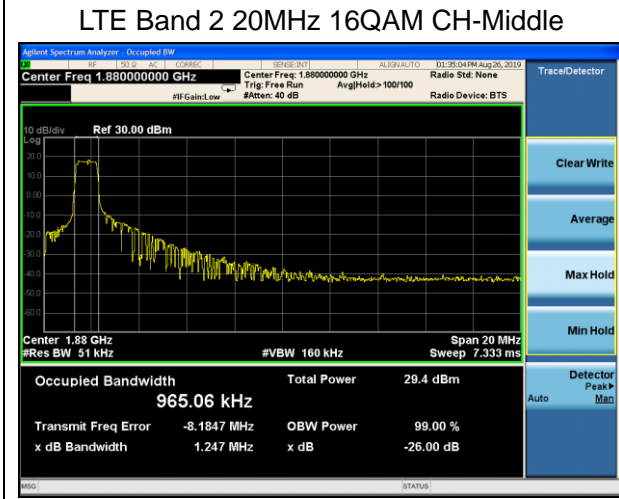
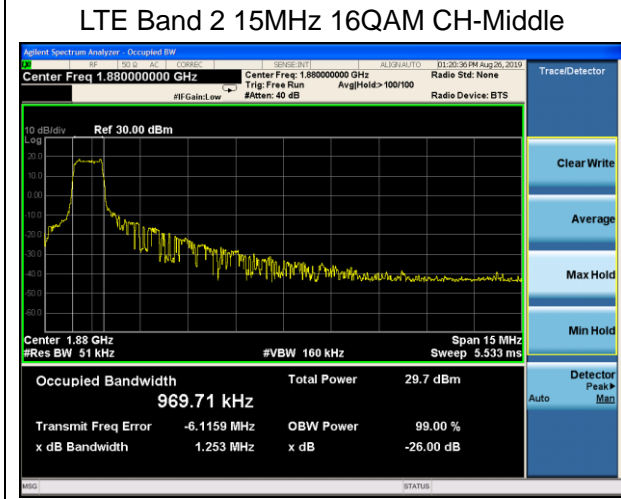
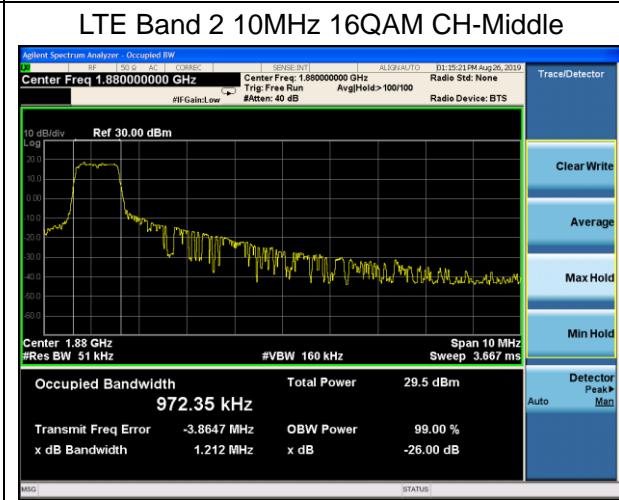
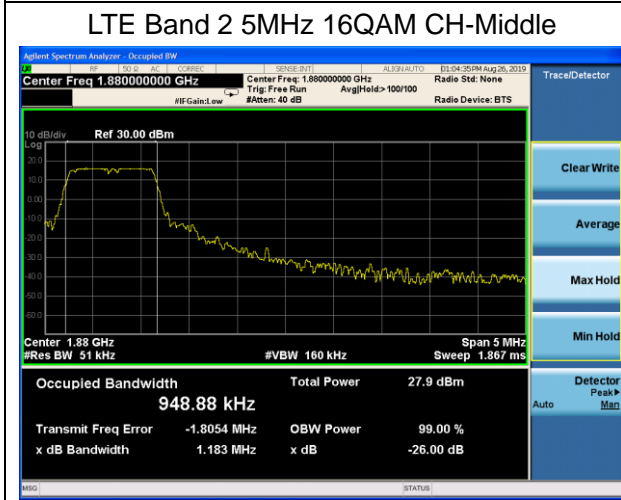
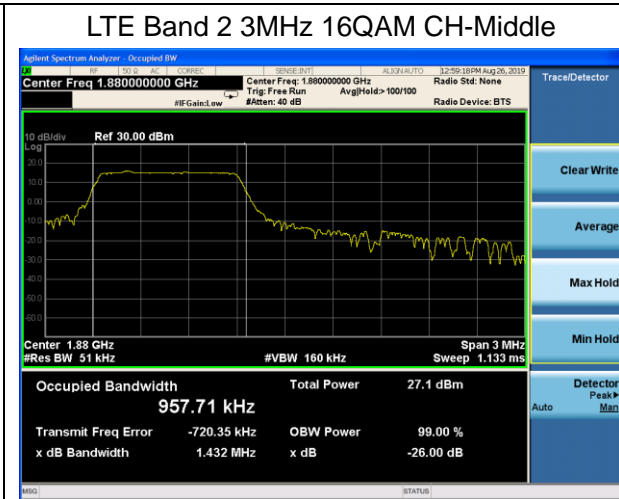
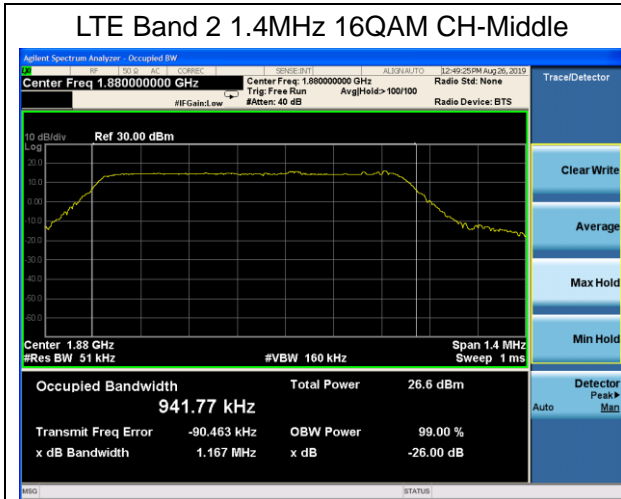

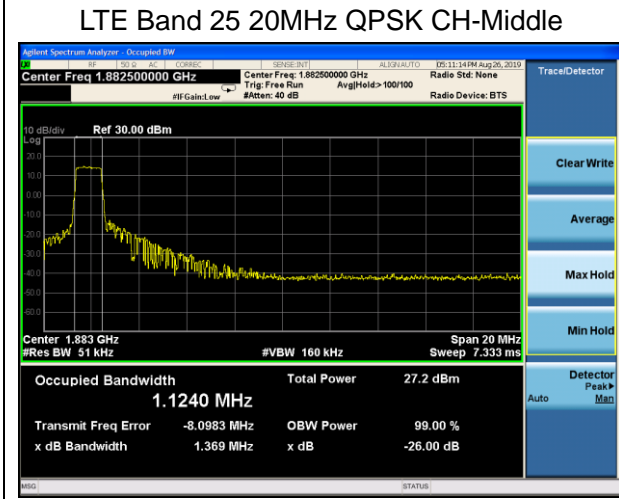
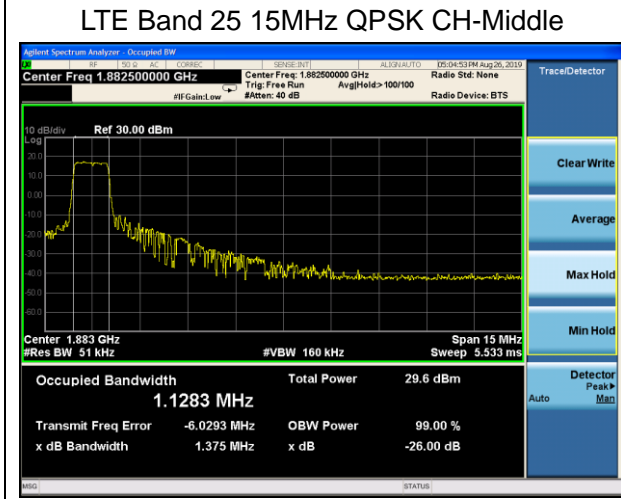
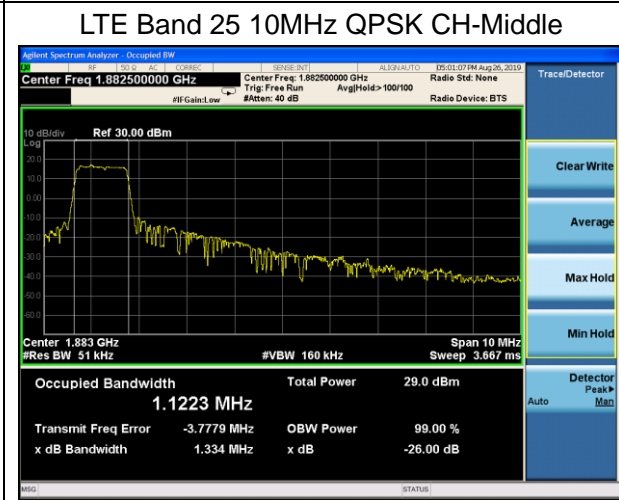
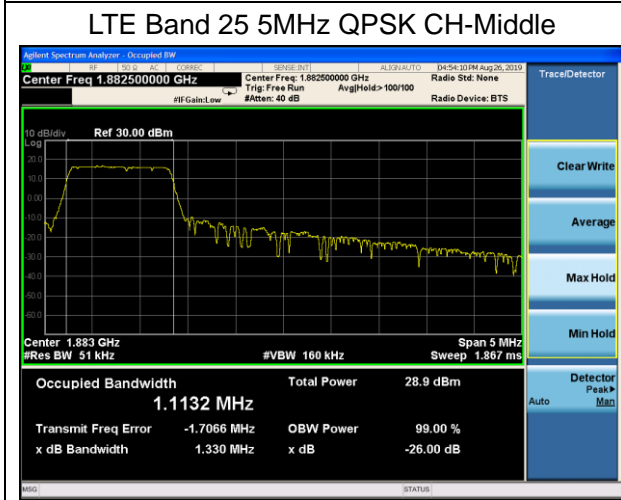
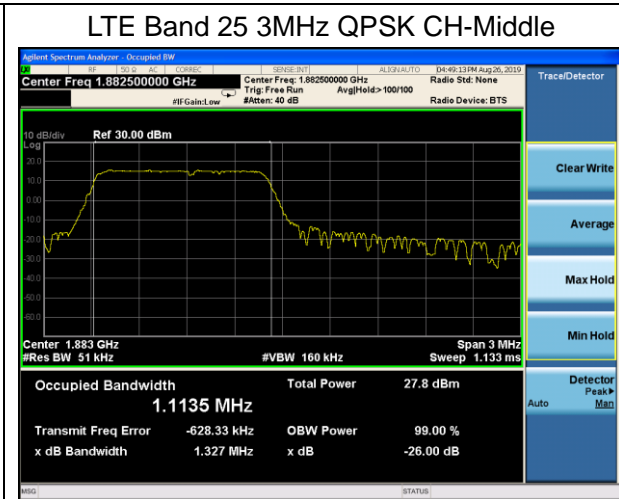
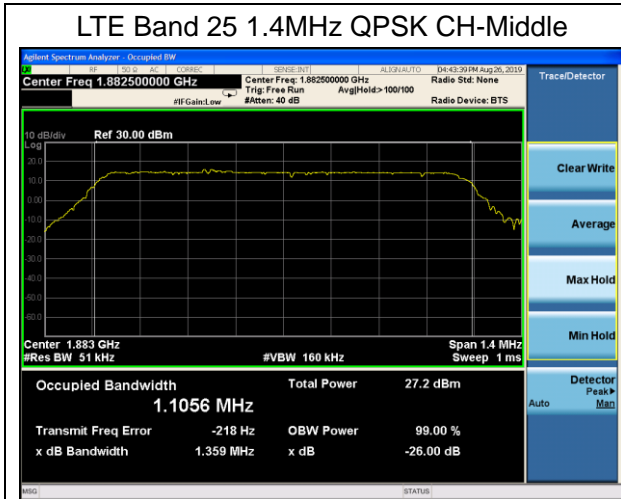

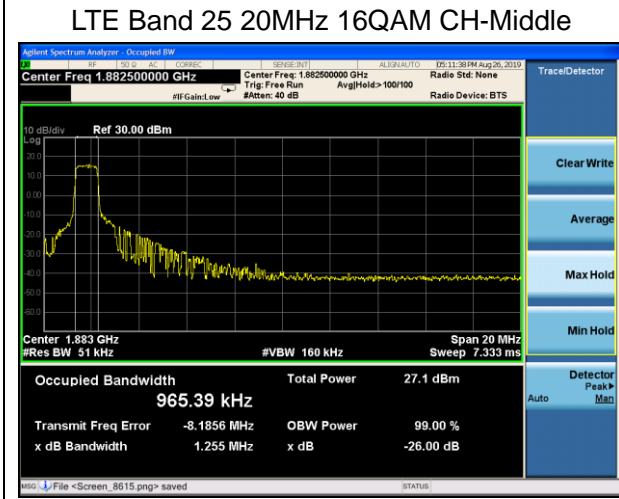
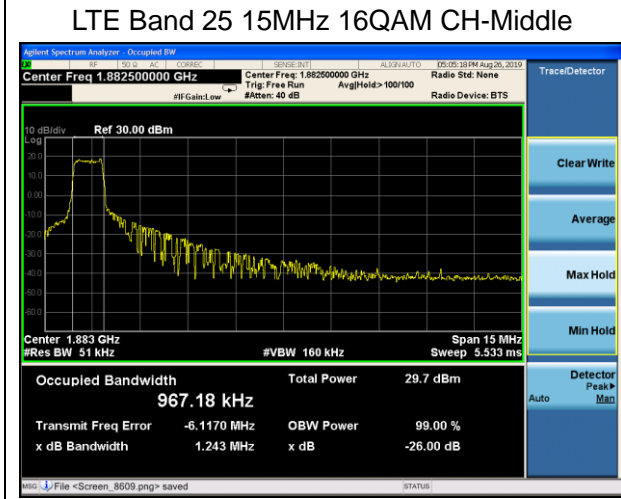
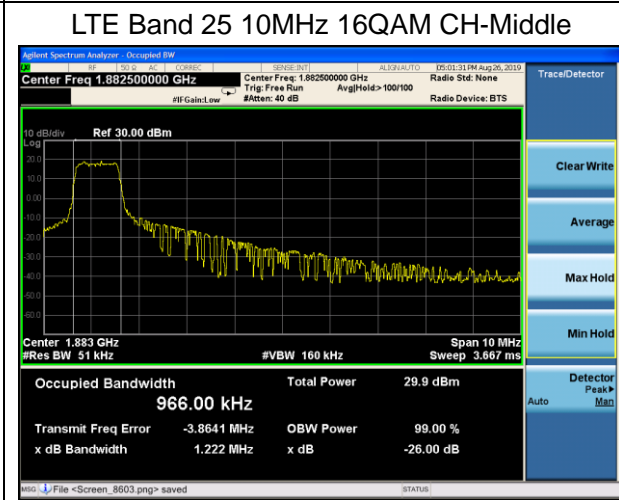
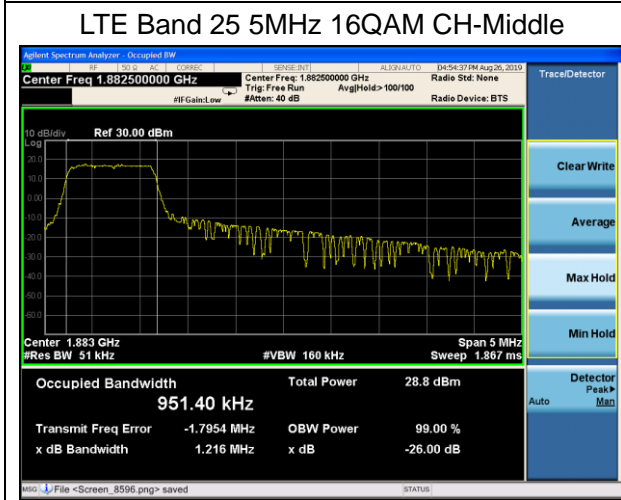
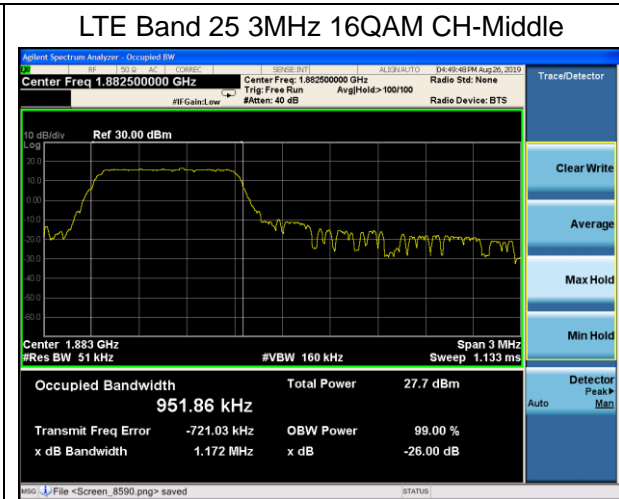
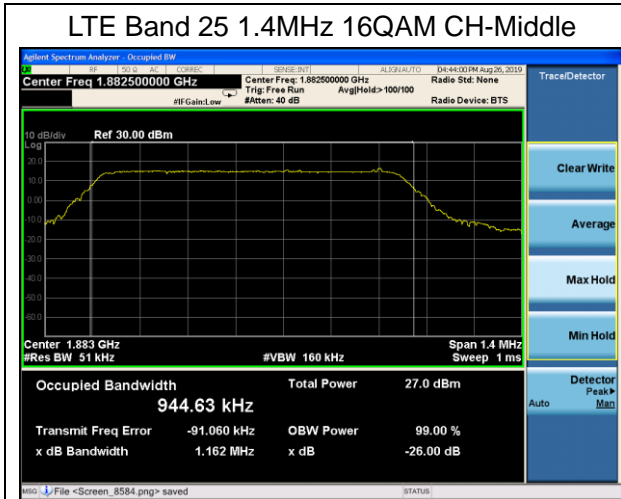

5.4. Band Edge Compliance

Ambient condition

Temperature	Relative humidity	Pressure
23°C ~25°C	45%~50%	101.5kPa

Method of Measurement

The EUT was connected to Spectrum Analyzer and Base Station Simulator via power Splitter. The band edge of the lowest and highest channels were measured. The Average detector is used and RBW is set to 3kHz, VBW is set to 10kHz for GSM 1900, RBW is set to 51kHz, VBW is set to 160kHz for LTE Band 2/25 Spectrum analyzer plots are included on the following pages.

Test Setup

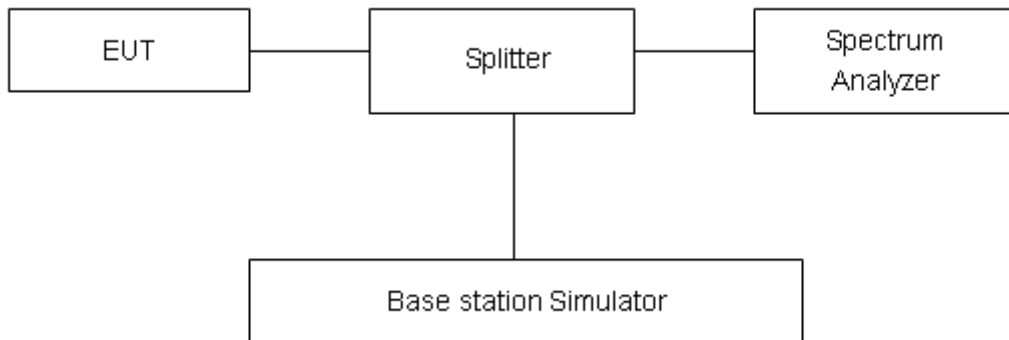

Limits

Rule Part 24.238(a) specifies that “on any frequency outside a licensee's frequency block, the power of any emission shall be attenuated below the transmitter power (P) by at least 43 + 10 log10 (P) dB.”

Limit	-13 dBm
-------	---------

Measurement Uncertainty

The assessed measurement uncertainty to ensure 95% confidence level for the normal distribution is with the coverage factor $k = 1.96$, $U=0.684$ dB.



Test Result:

