

2DH5_ANT1_HOP

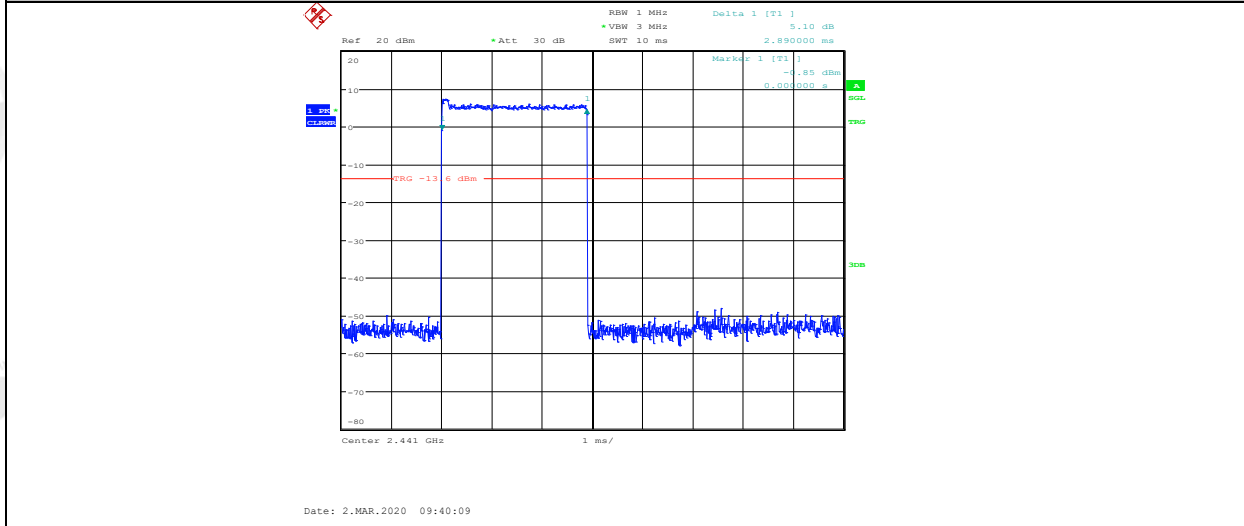

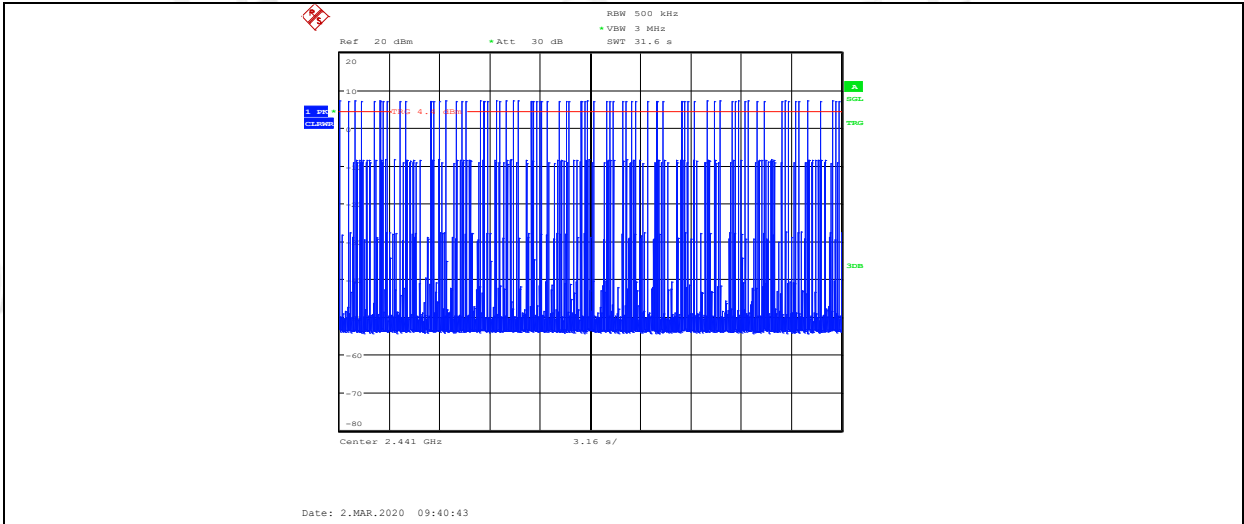

3DH1_ANT1_HOP

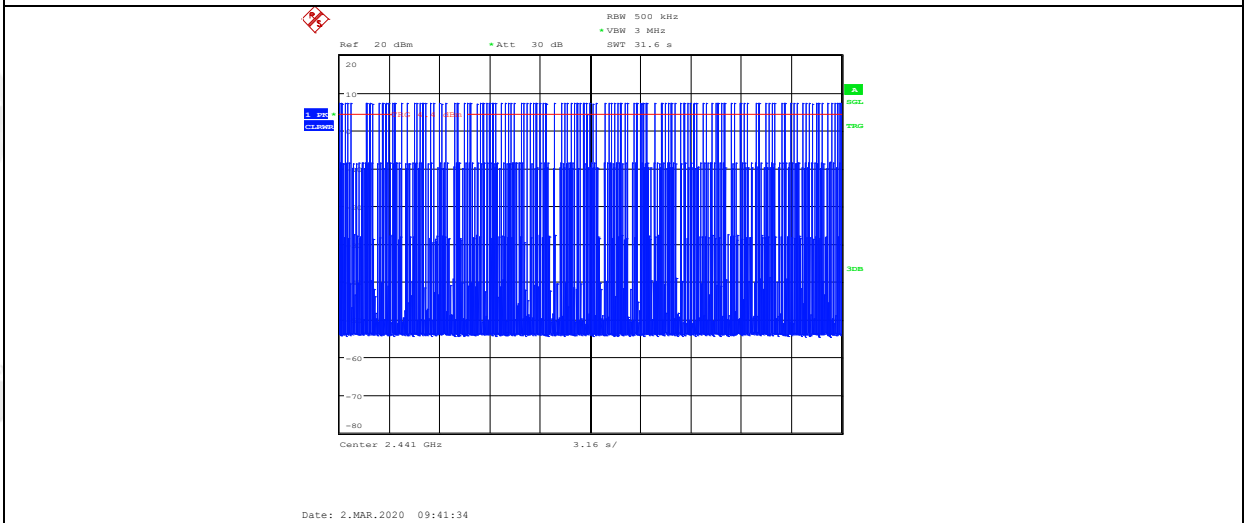
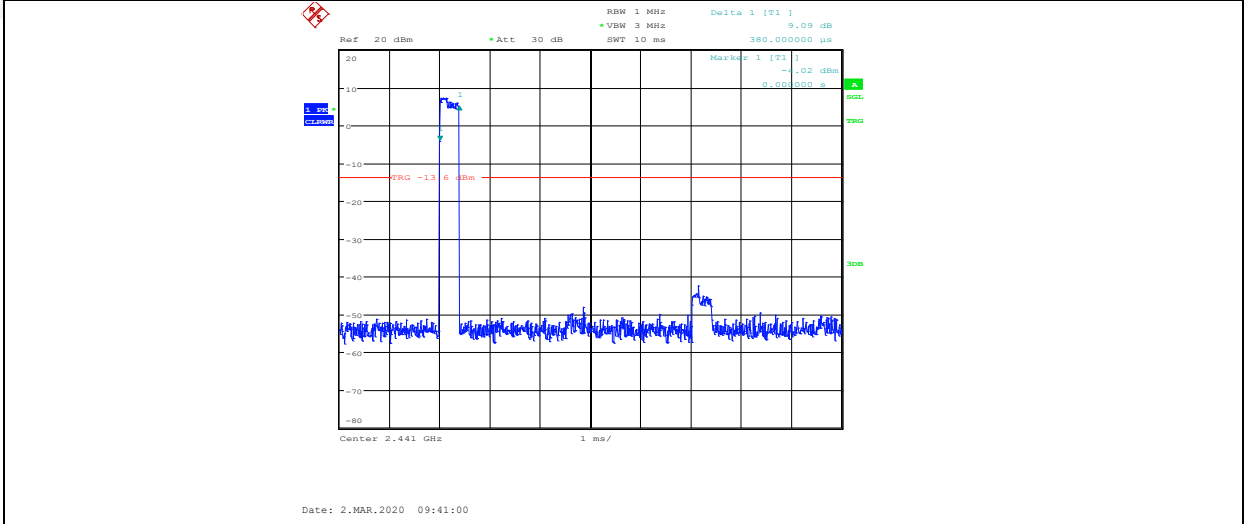

3DH3_ANT1_HOP

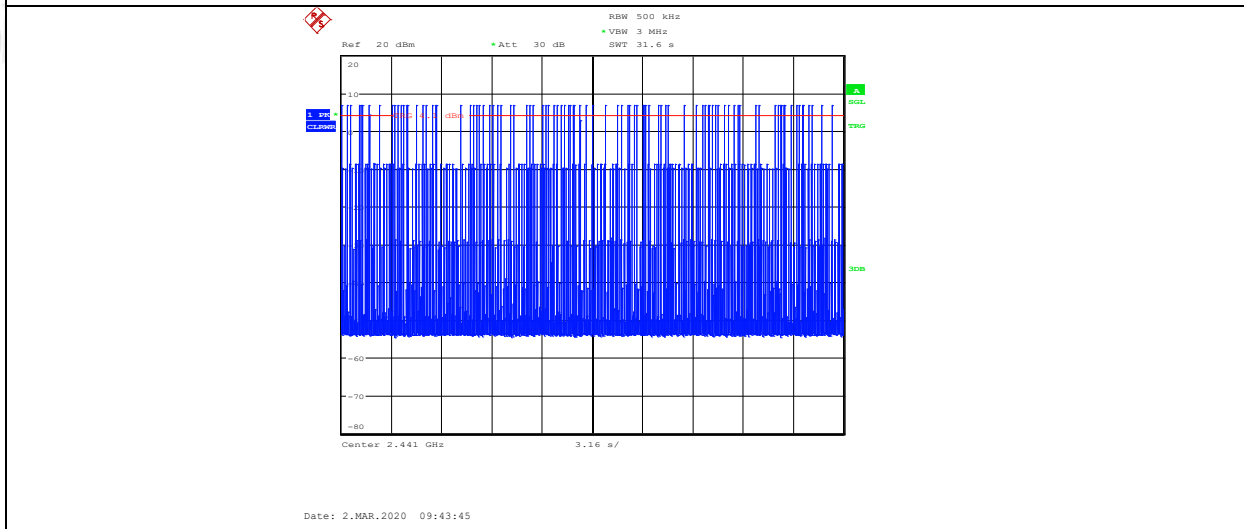
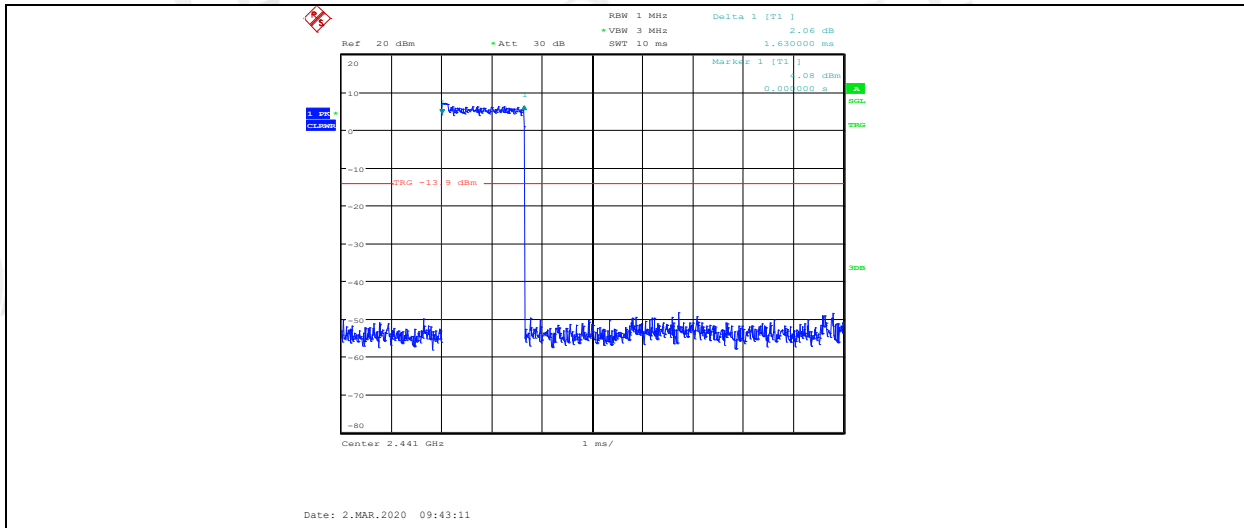

3DH5_ANT1_HOP

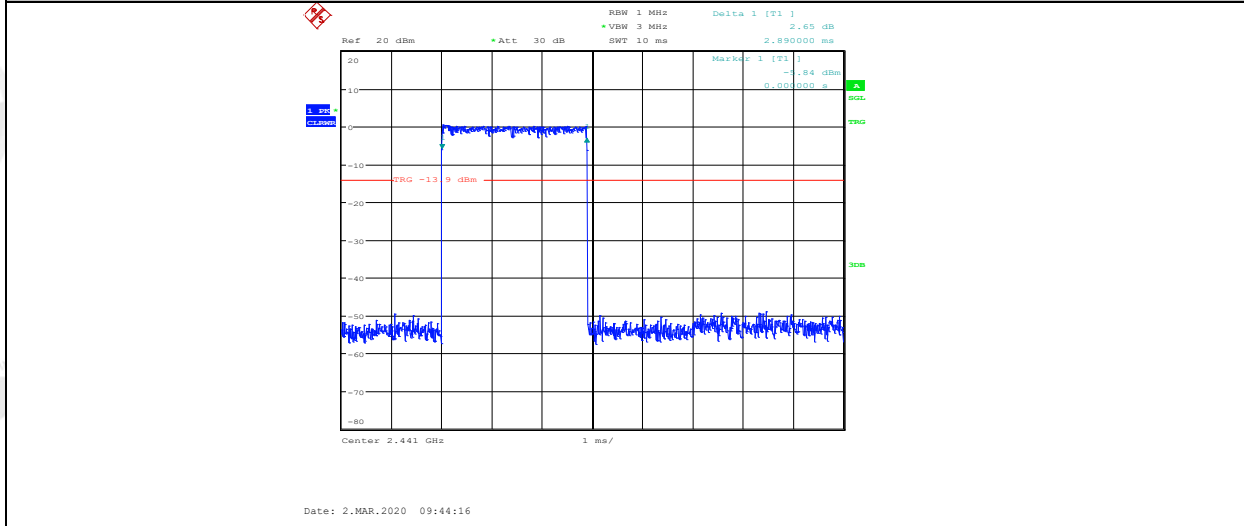

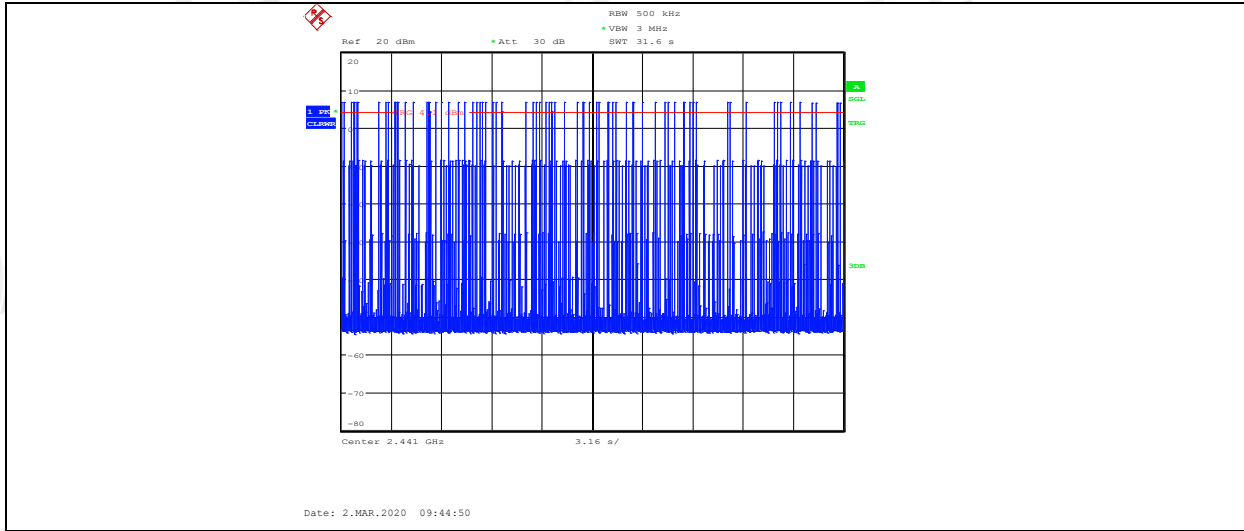

Right side:

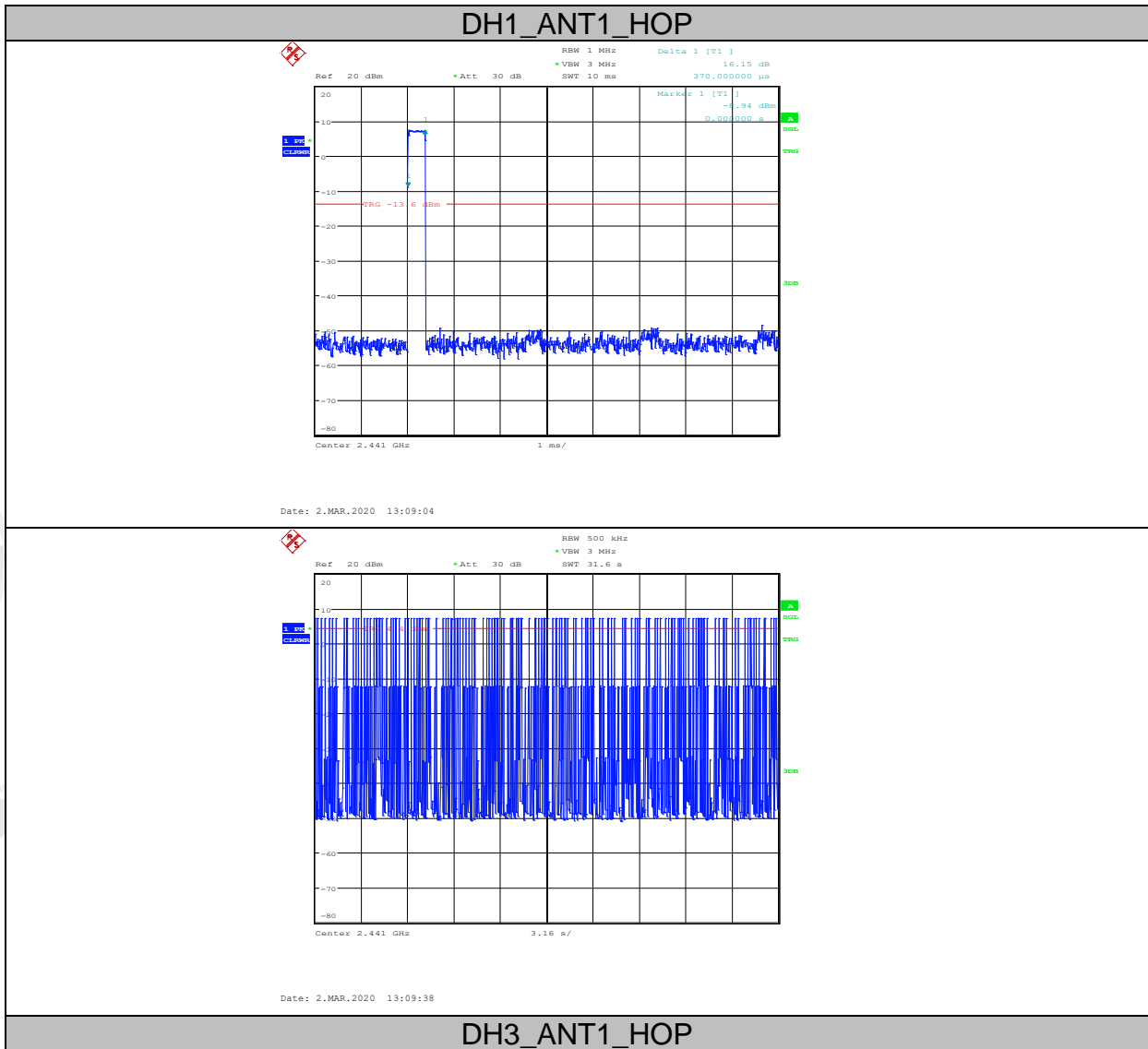

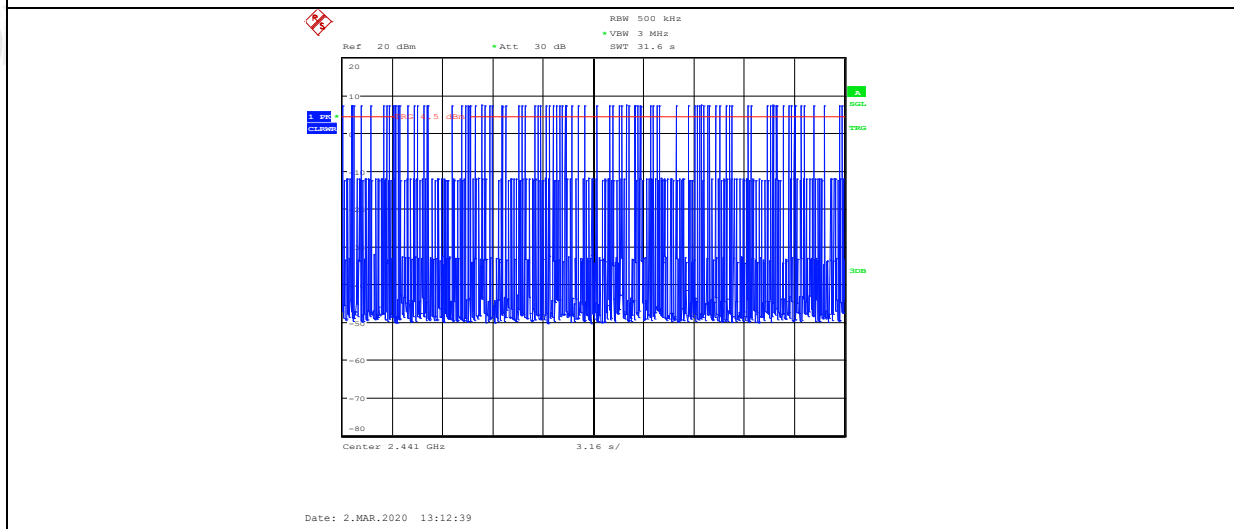
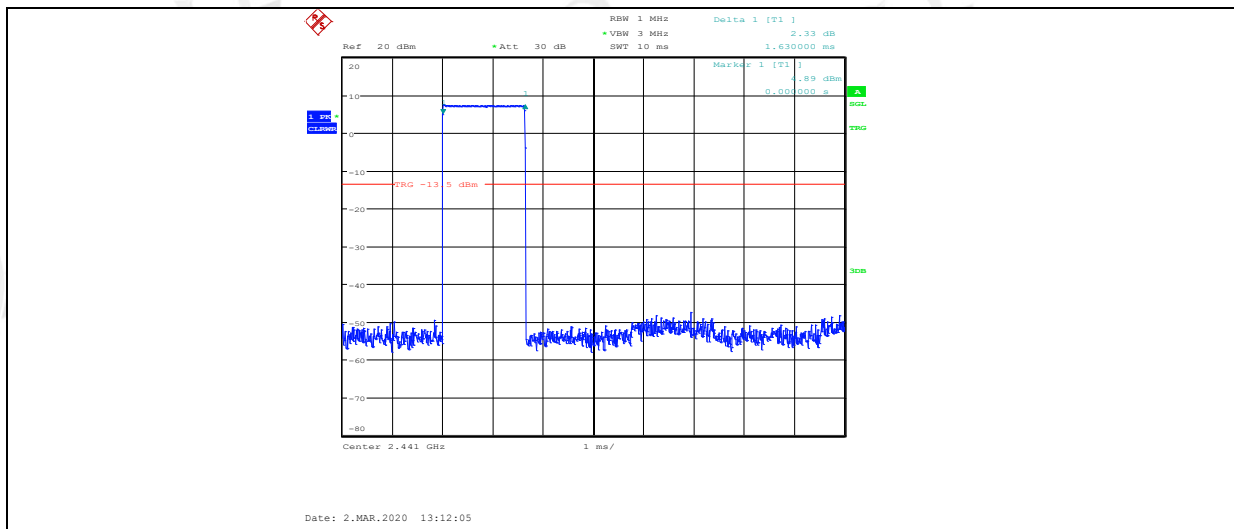

DH5_ANT1_HOP

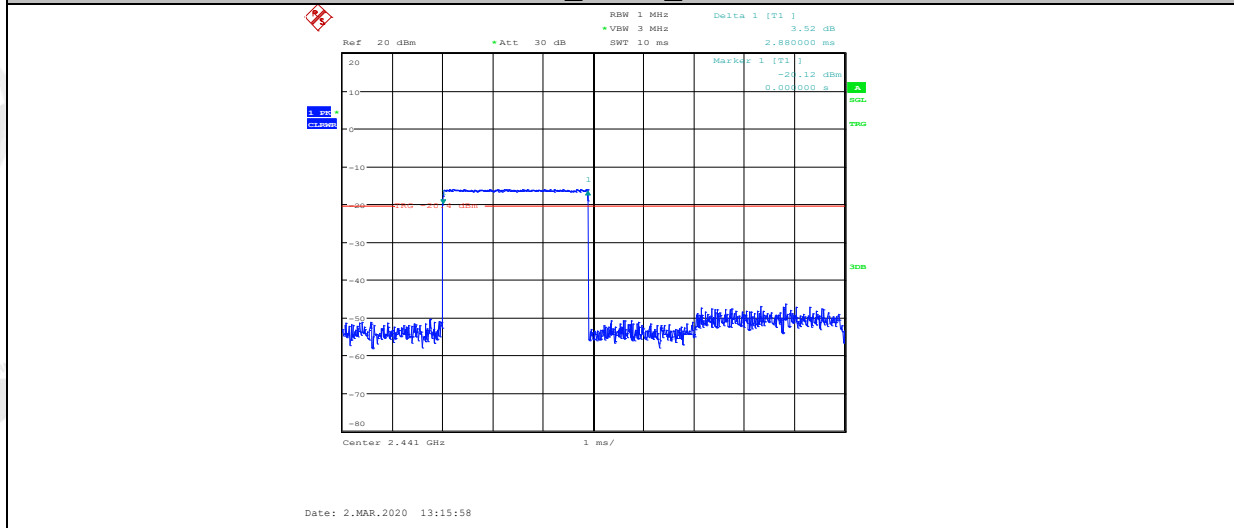

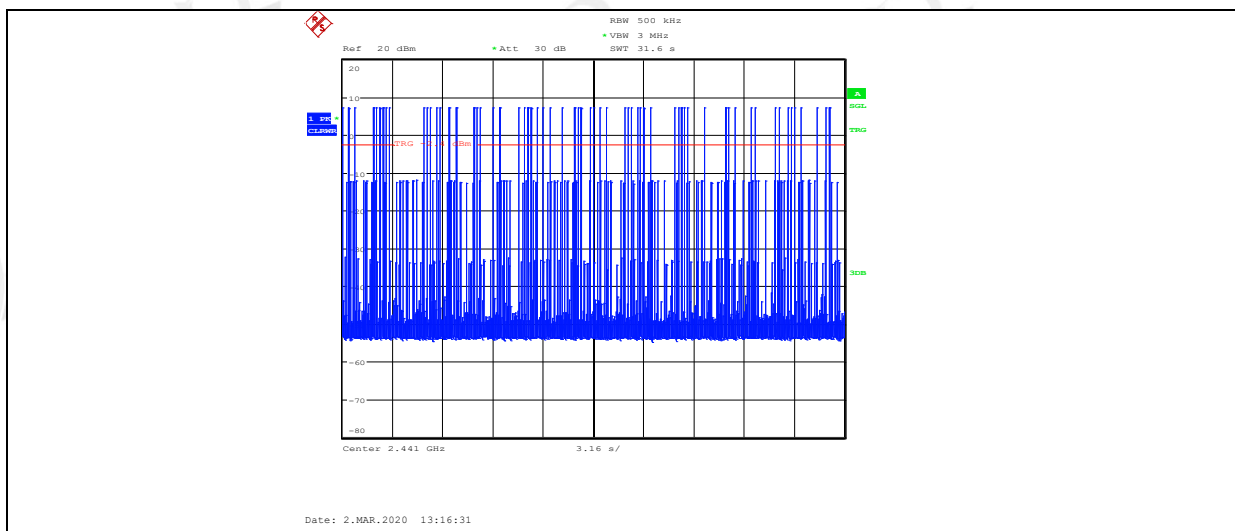

2DH1_ANT1_HOP

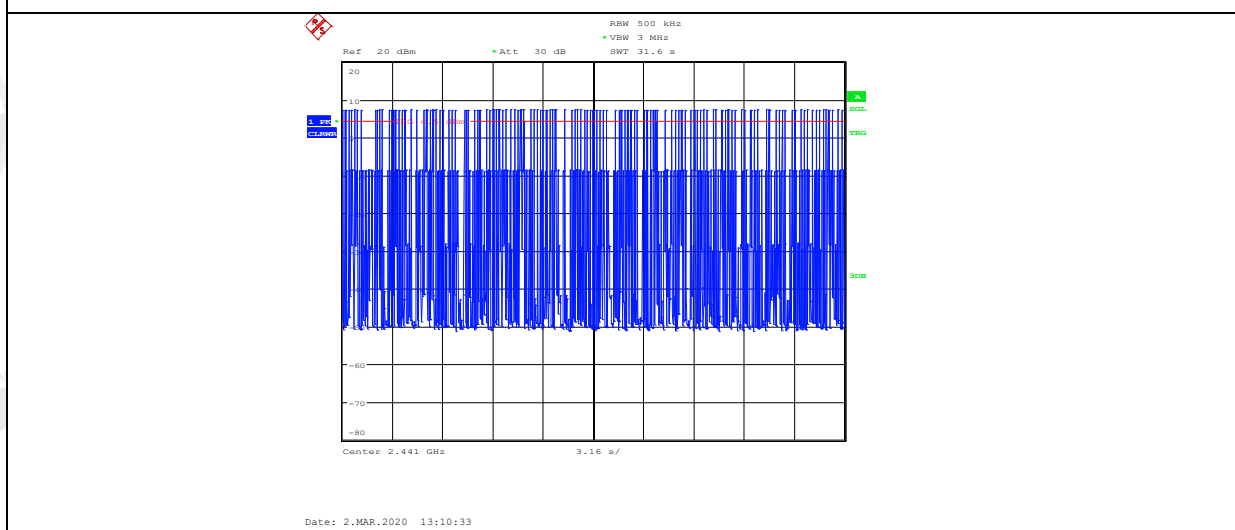
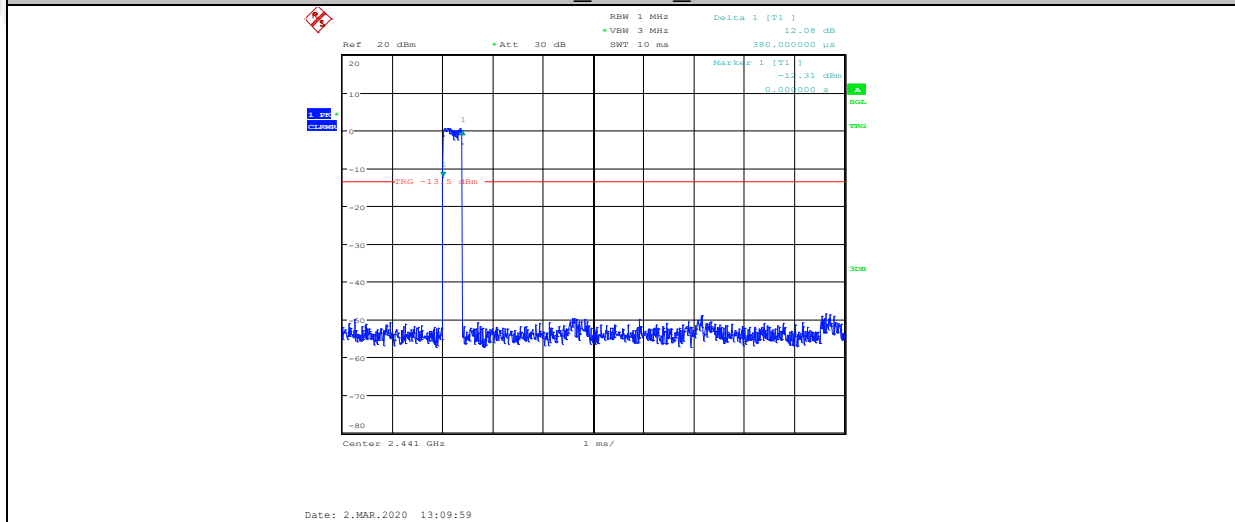

2DH3_ANT1_HOP

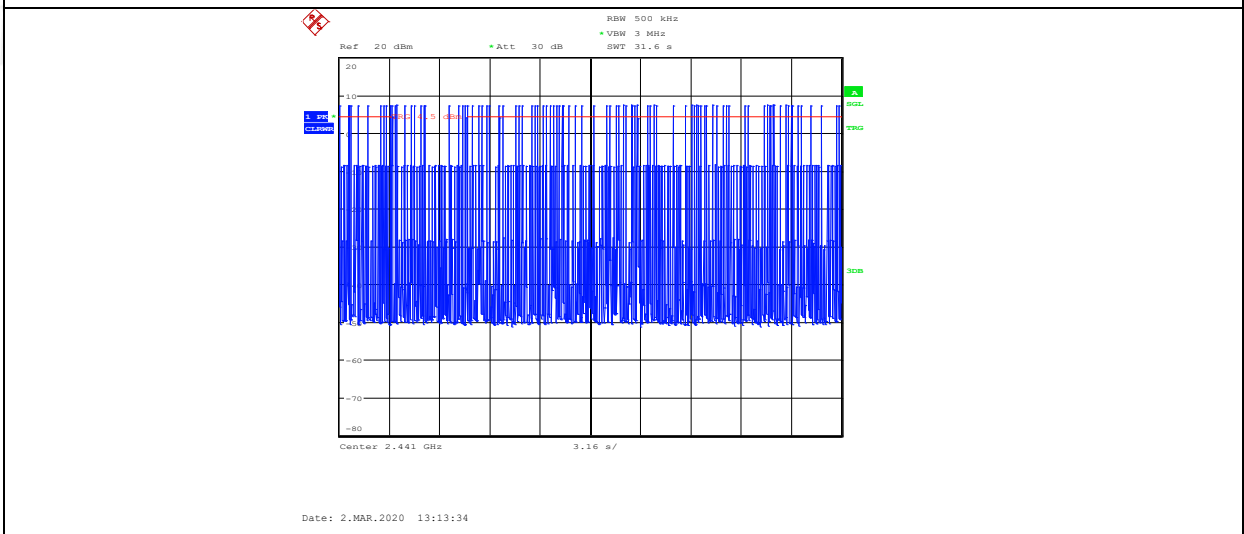
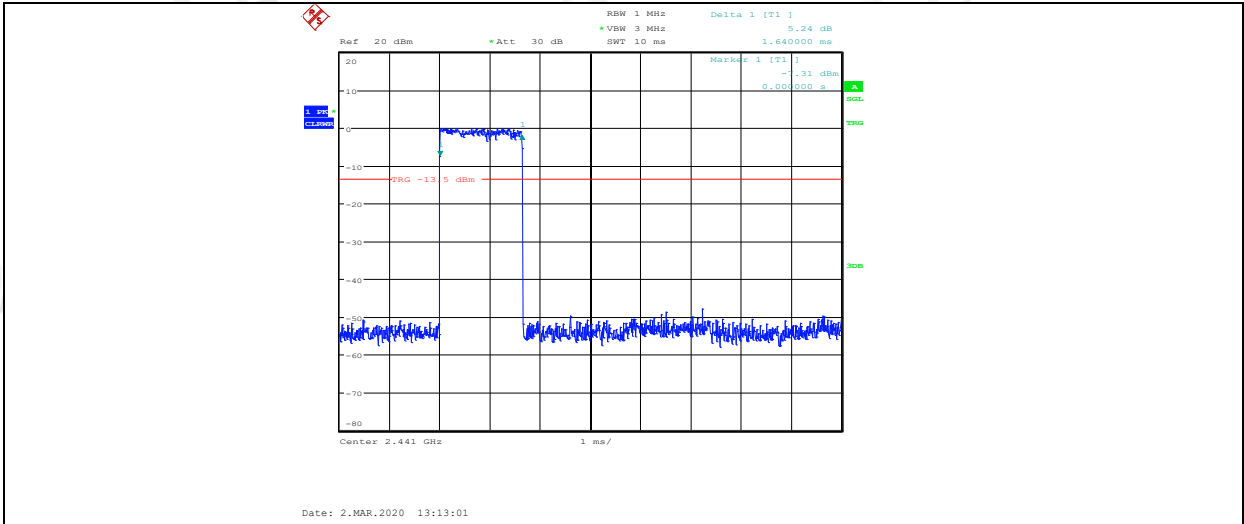

2DH5_ANT1_HOP

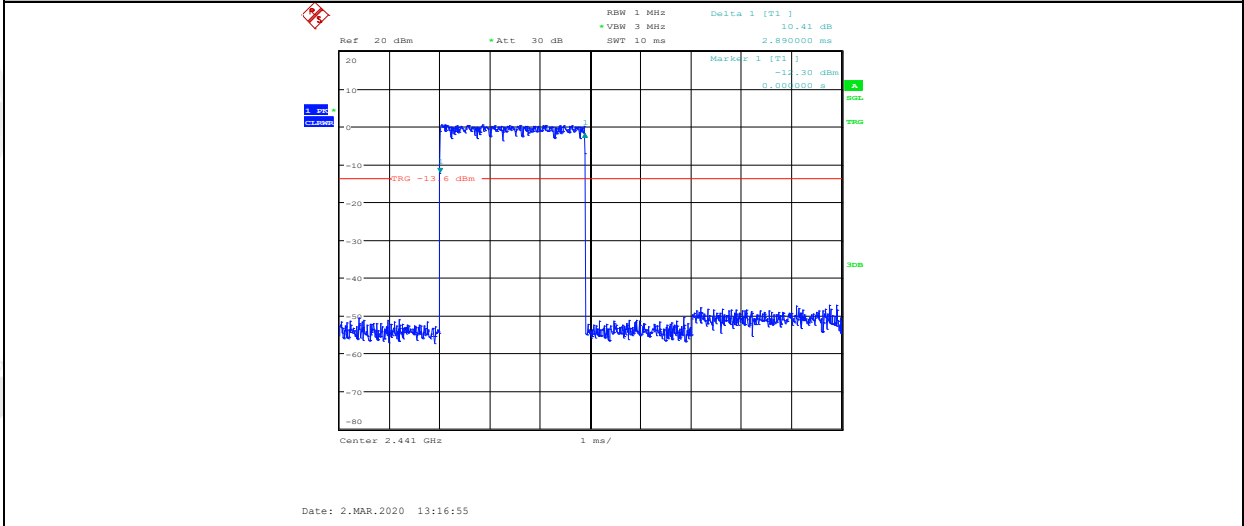

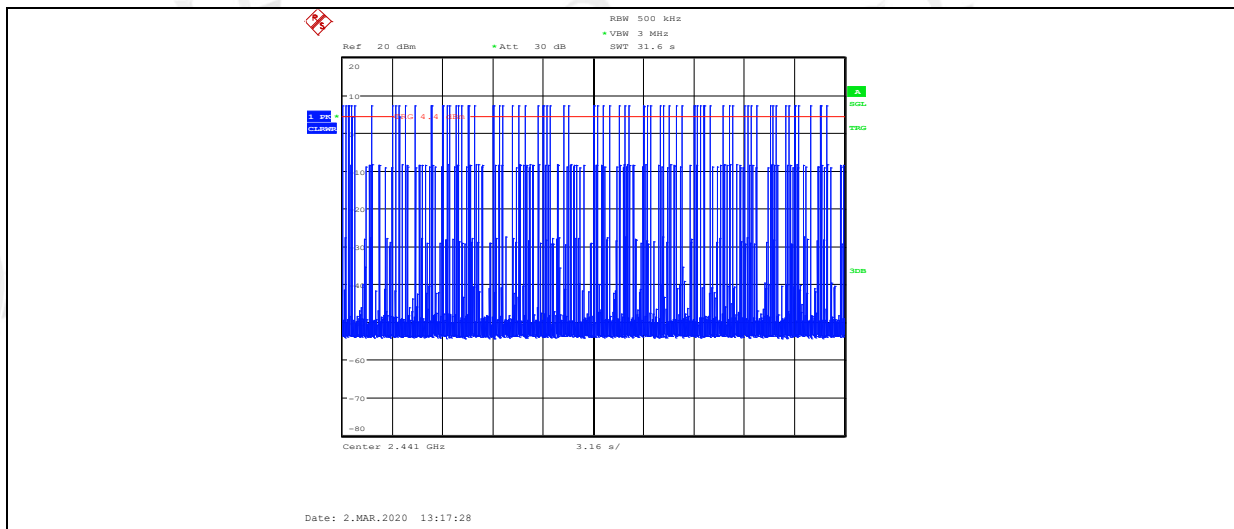

3DH1_ANT1_HOP

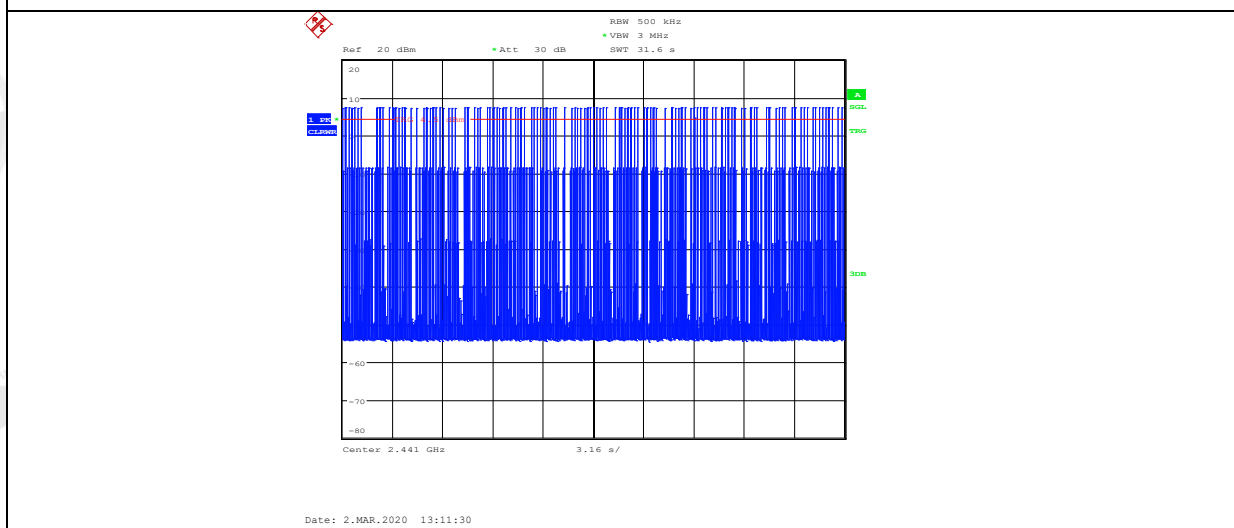
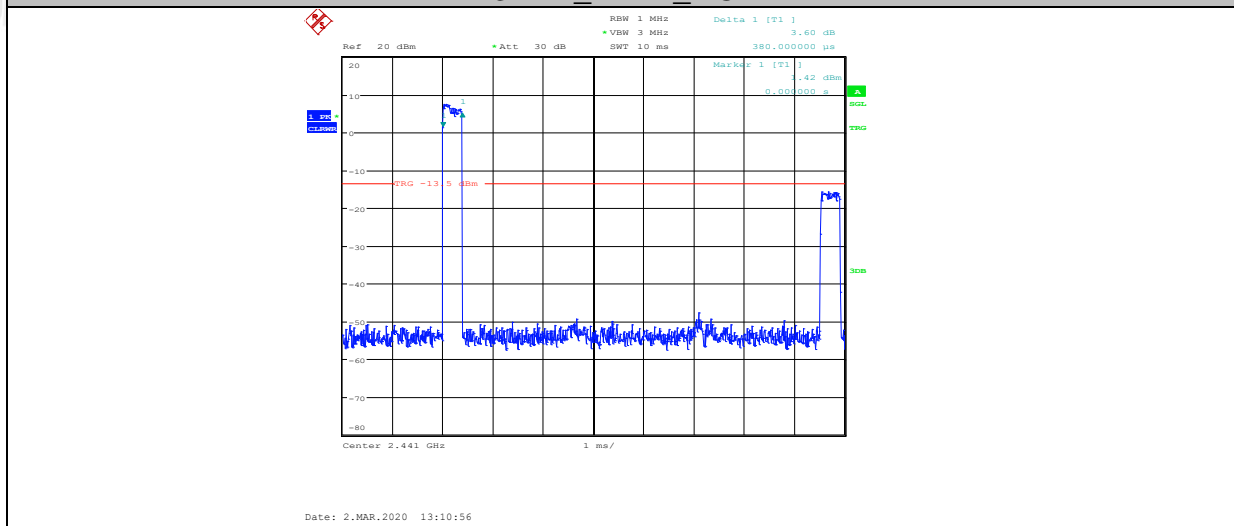

3DH3_ANT1_HOP

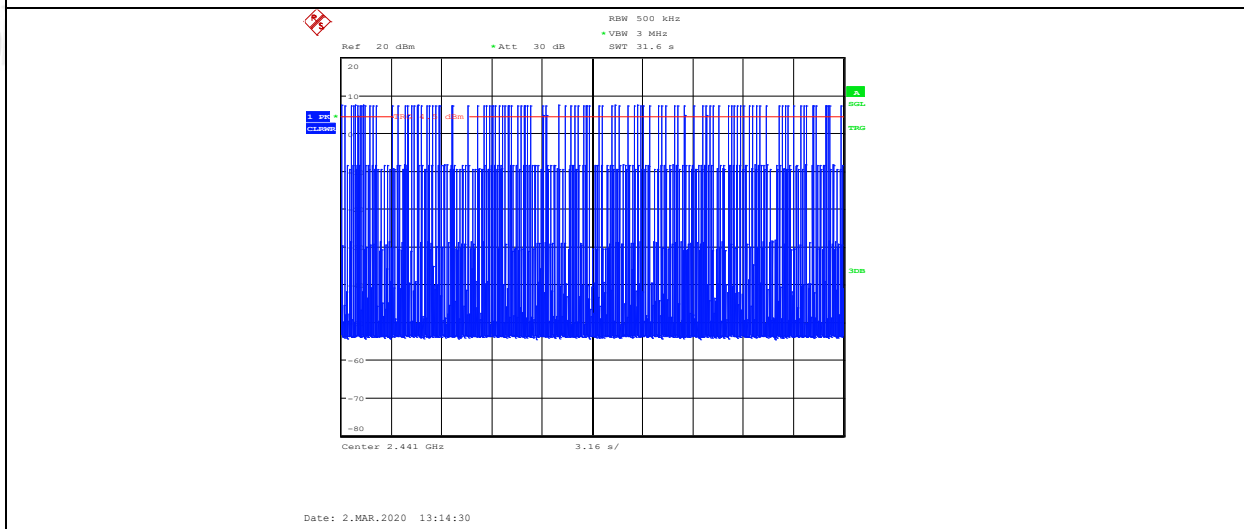
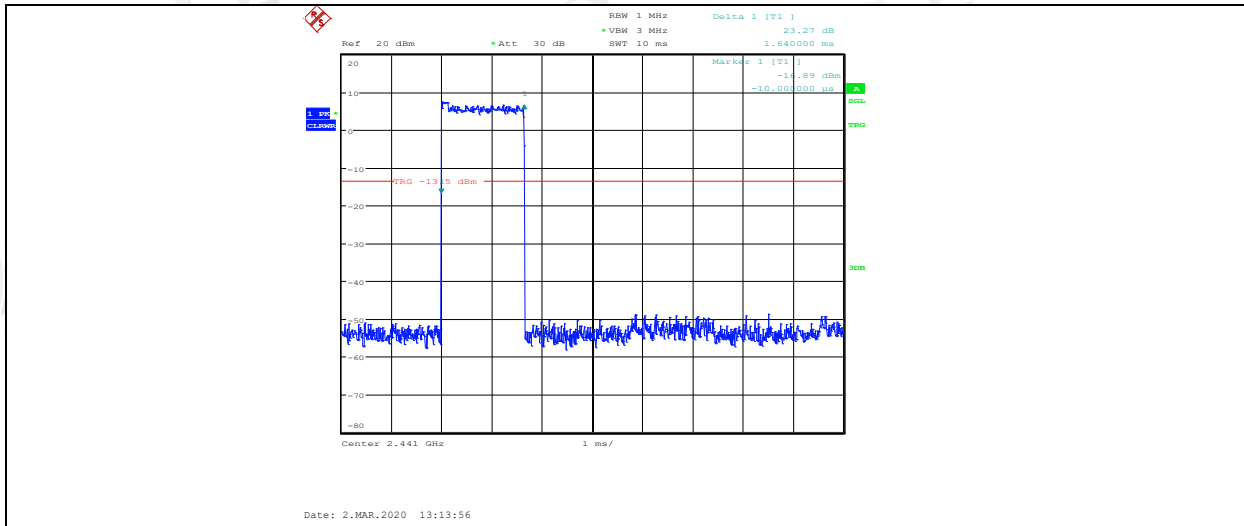

3DH5_ANT1_HOP

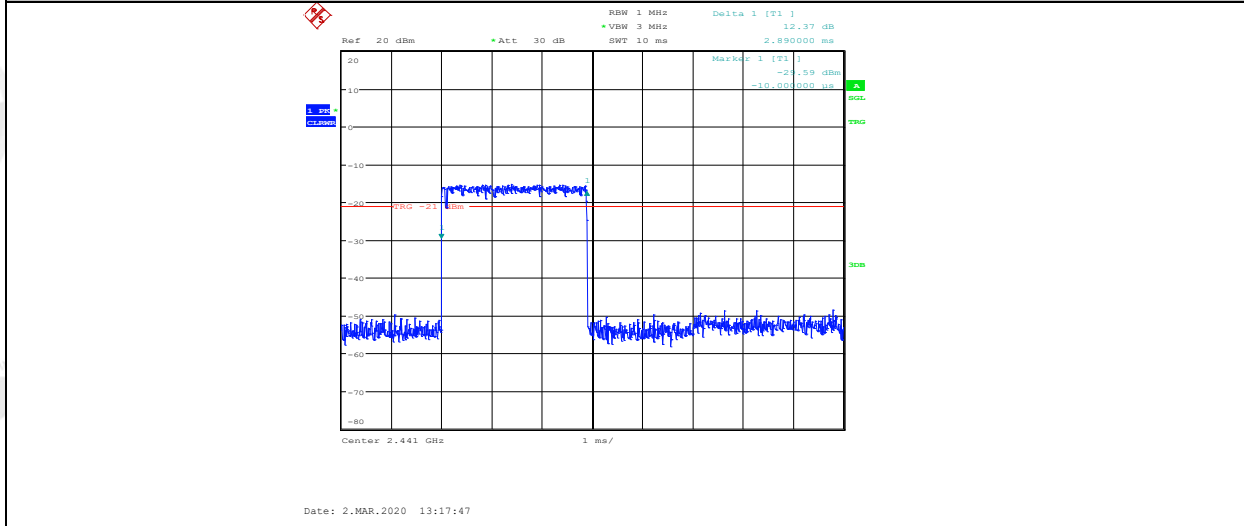

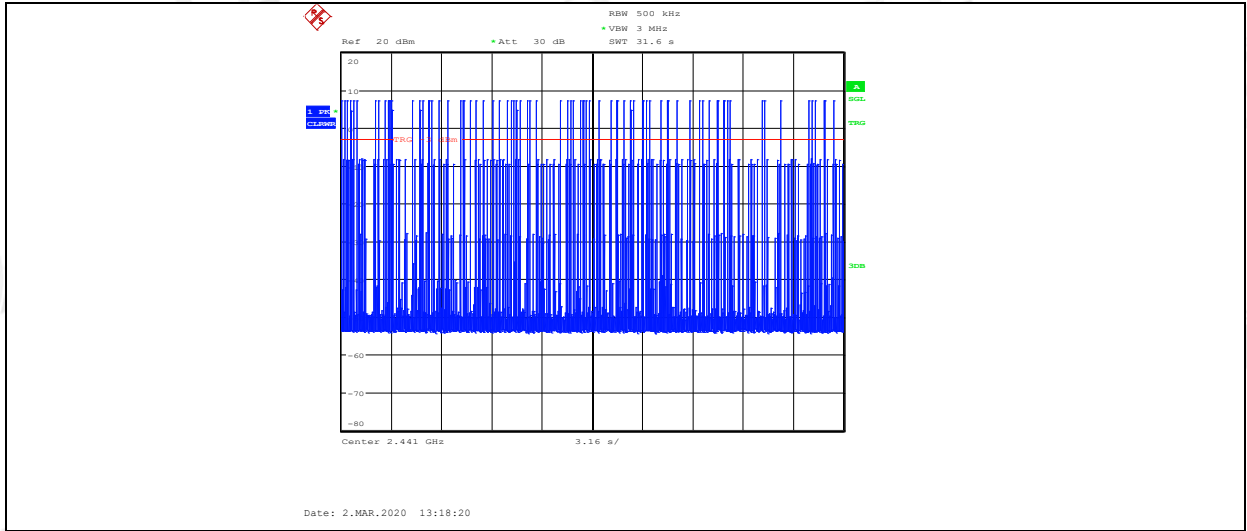

Date: 2.MAR.2020 13:18:20

9. Band Edge Compliance (conducted method)

9.1. Block diagram of test setup

Same as section 4.1

9.2. Limit

All restriction band should comply with 15.209, other emission should be at least 20dB below the fundamental.

9.3. Test result

Mode	Freq. (MHz)	Conclusion
GFSK	Hopping off 2402	PASS
	Hopping off 2480	PASS
	Hopping on	PASS
$\pi/4$ -DQPSK	Hopping off 2402	PASS
	Hopping off 2480	PASS
	Hopping on	PASS
8DPSK	Hopping off 2402	PASS
	Hopping off 2480	PASS
	Hopping on	PASS

9.4. Original test data

Left side:

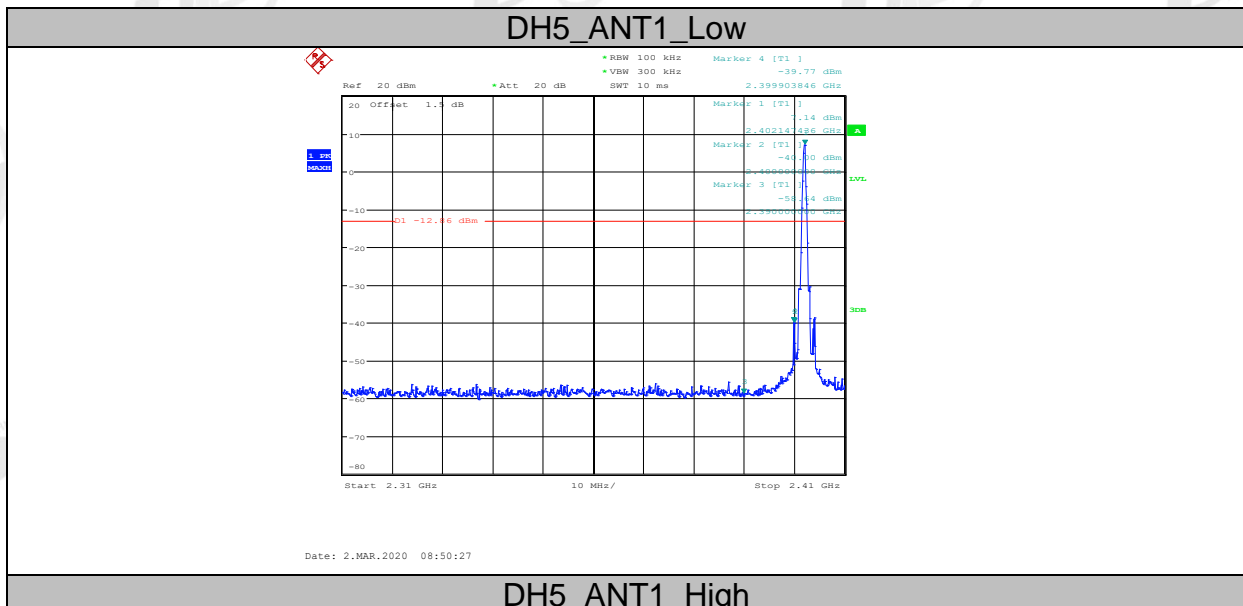

DH5_ANT1_High

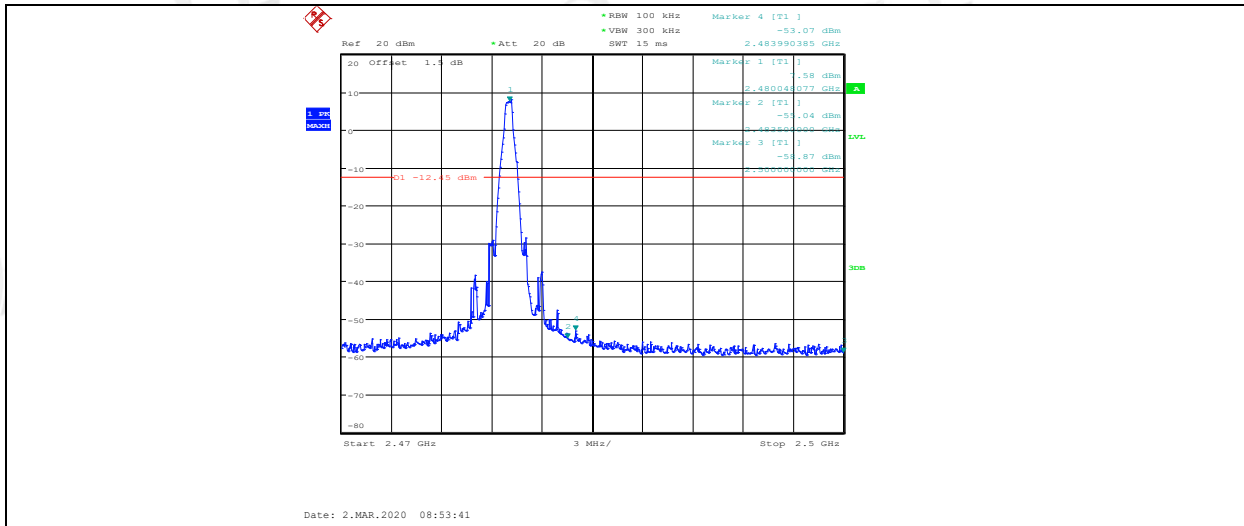

DH5_ANT1_Low

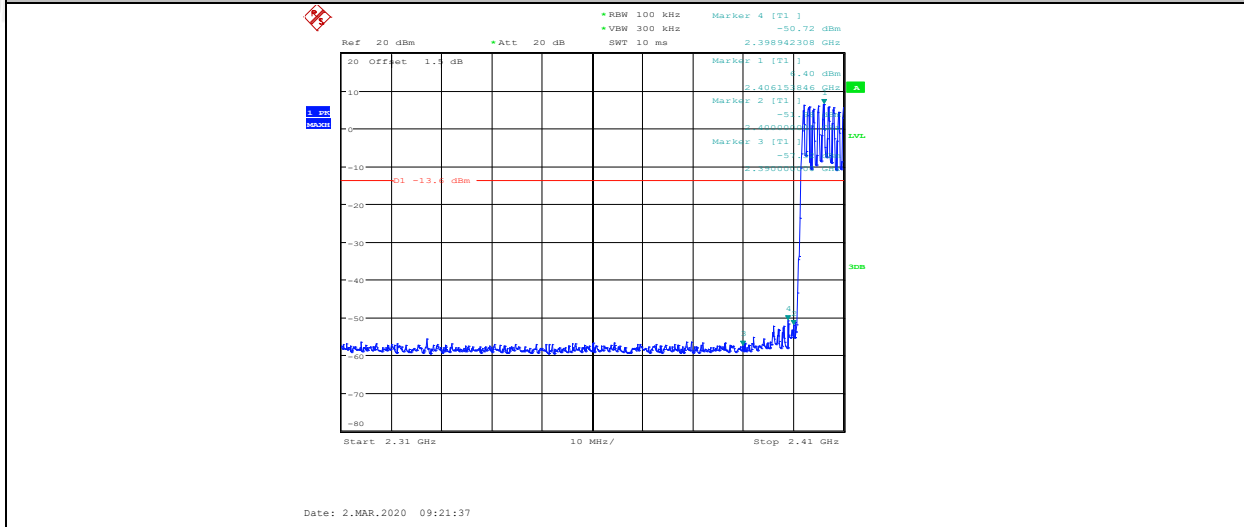

DH5_ANT1_High

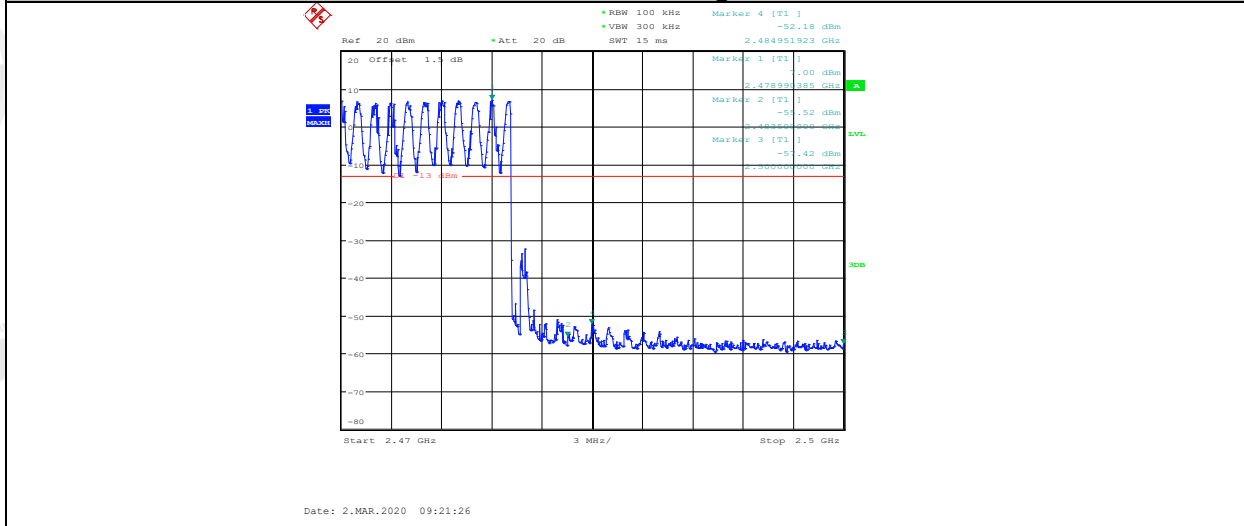

2DH5_ANT1_Low

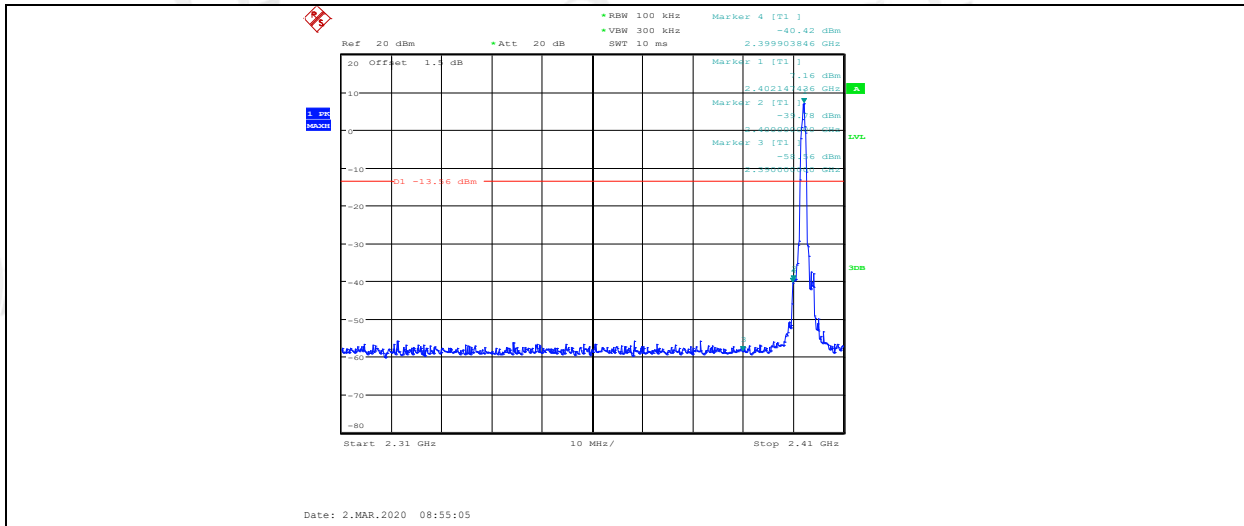

2DH5_ANT1_High

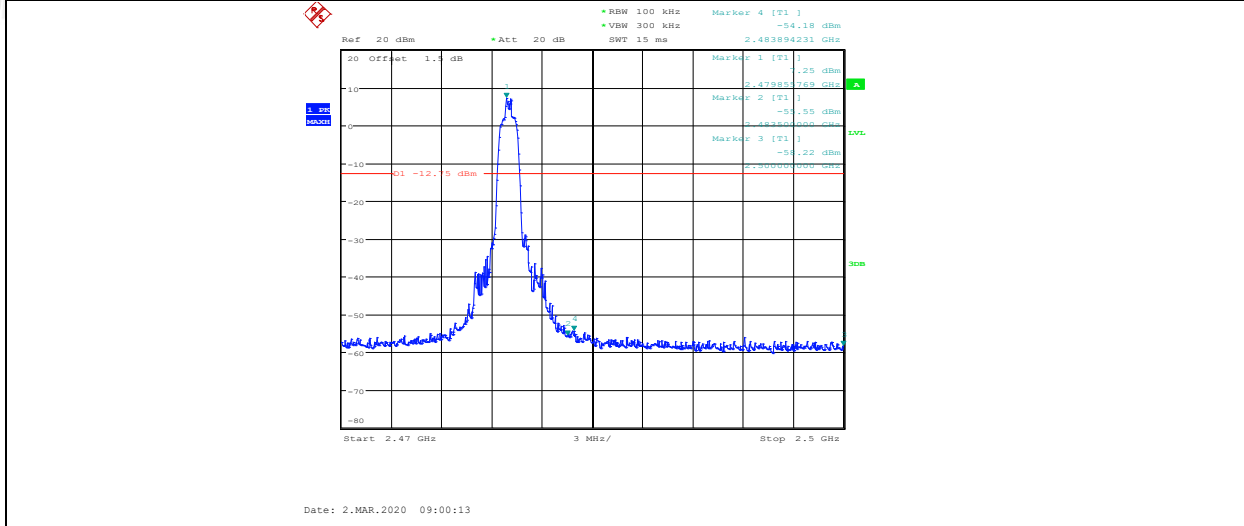

2DH5_ANT1_Low

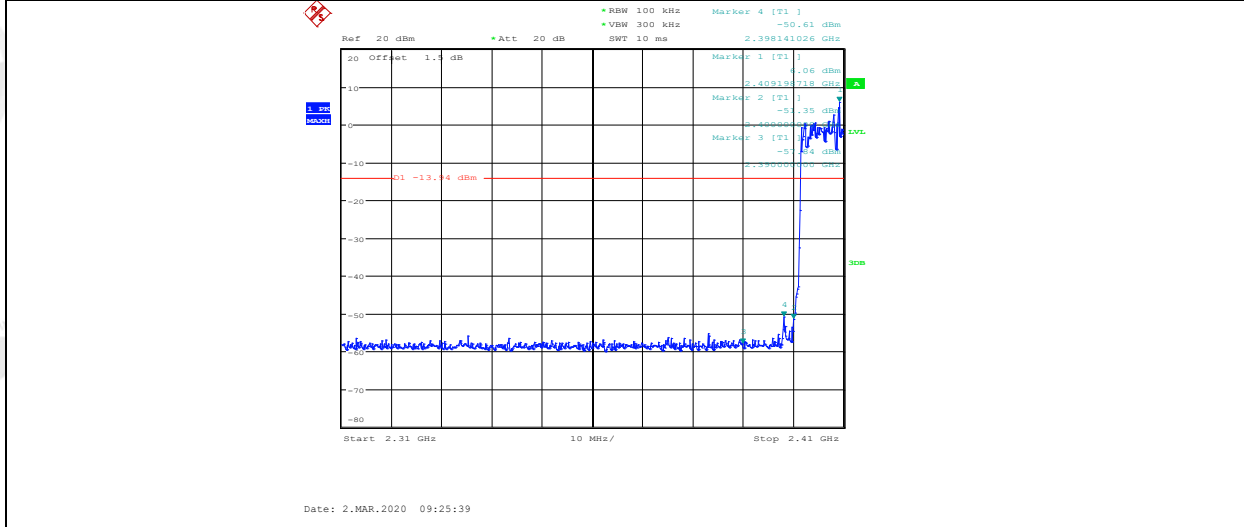

2DH5_ANT1_High

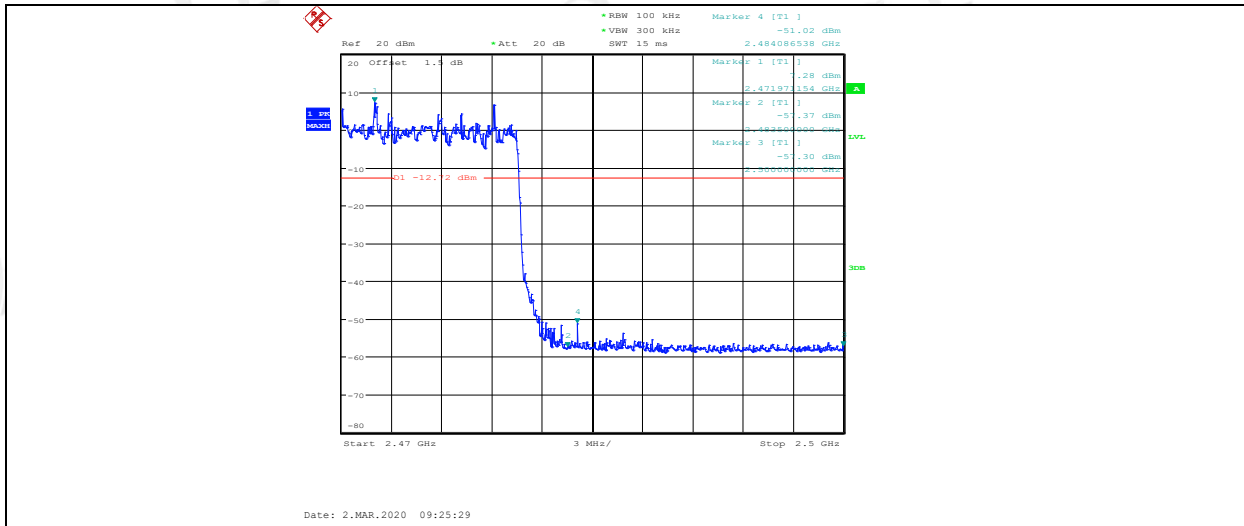

3DH5_ANT1_Low

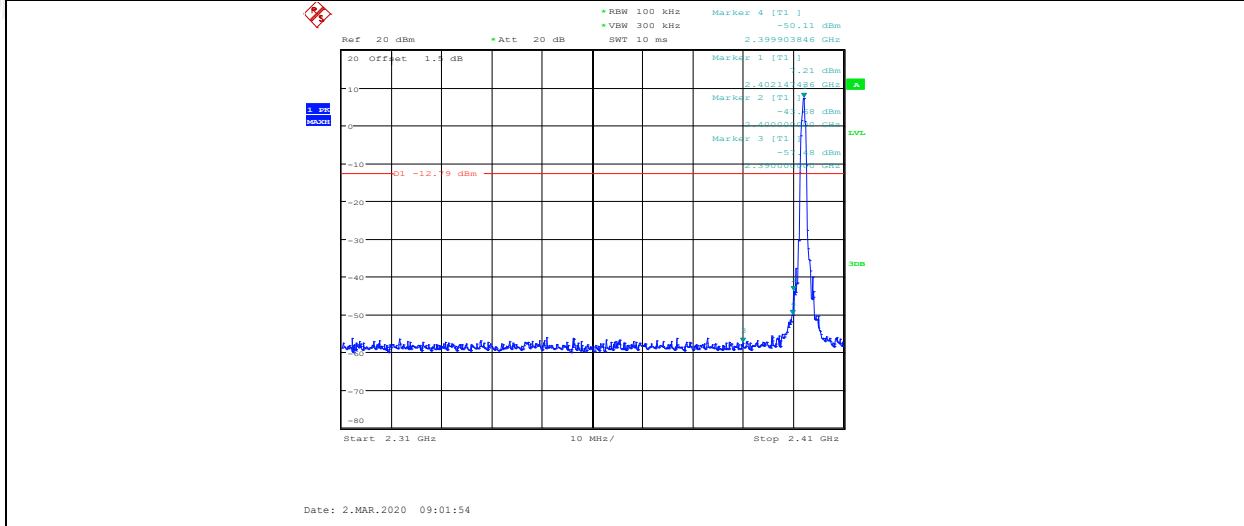

3DH5_ANT1_High

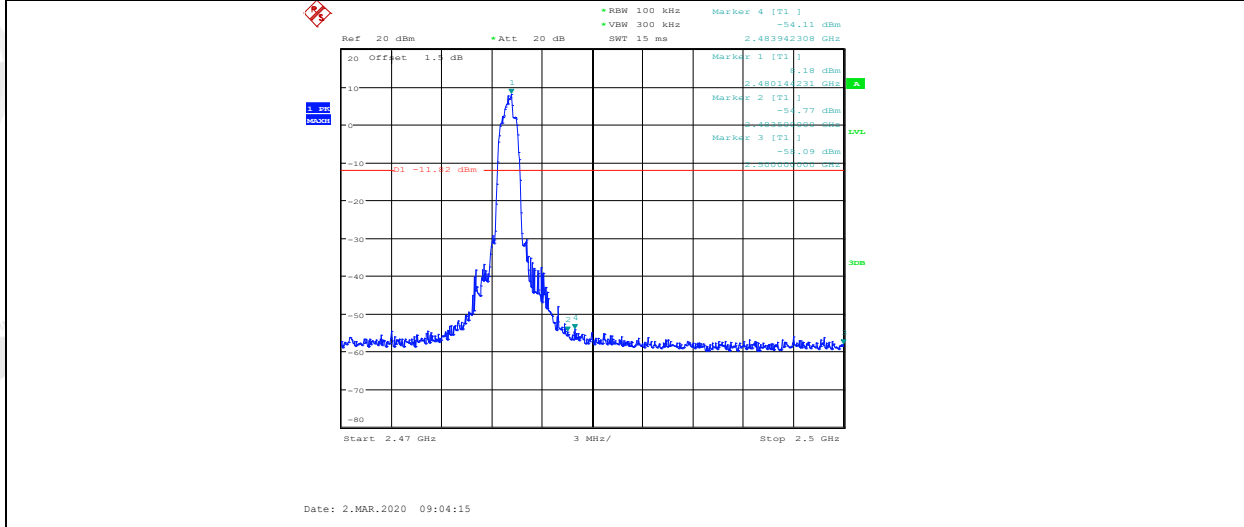

3DH5_ANT1_Low

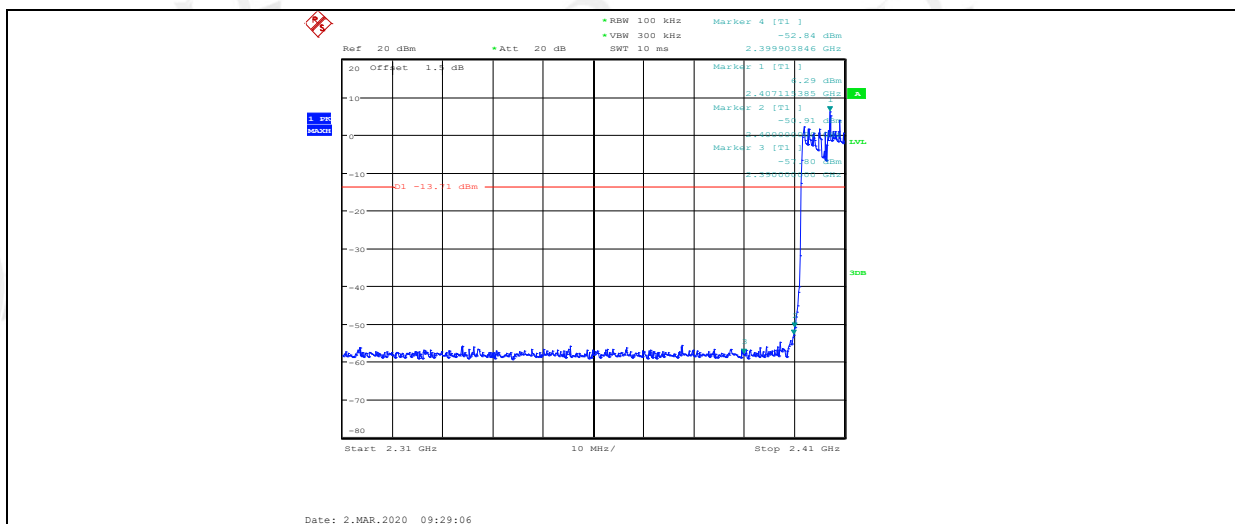

3DH5_ANT1_High

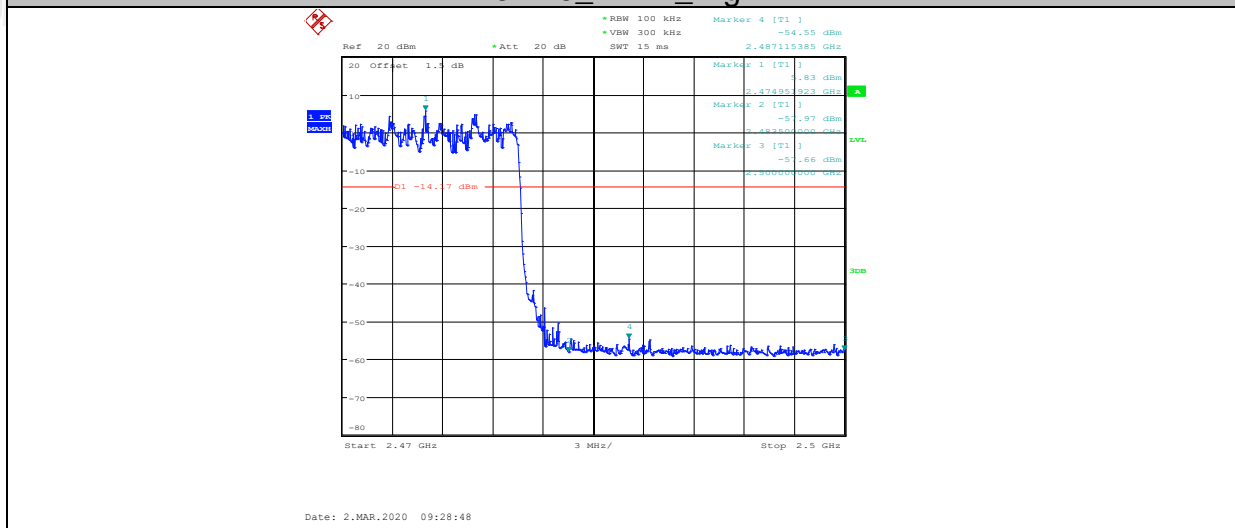

Right side:

DH5_ANT1_Low

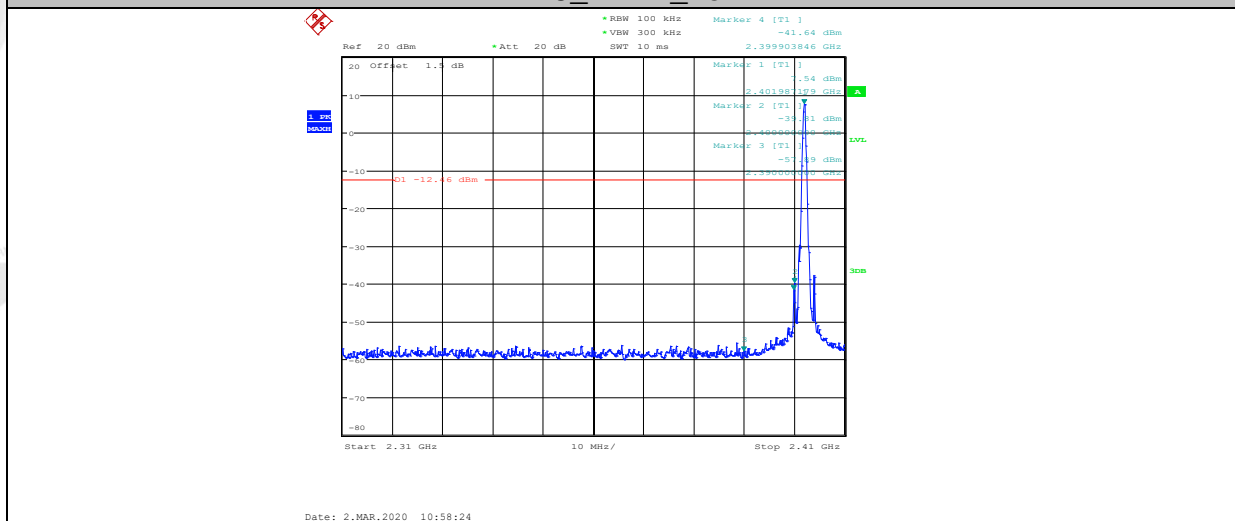

DH5_ANT1_High

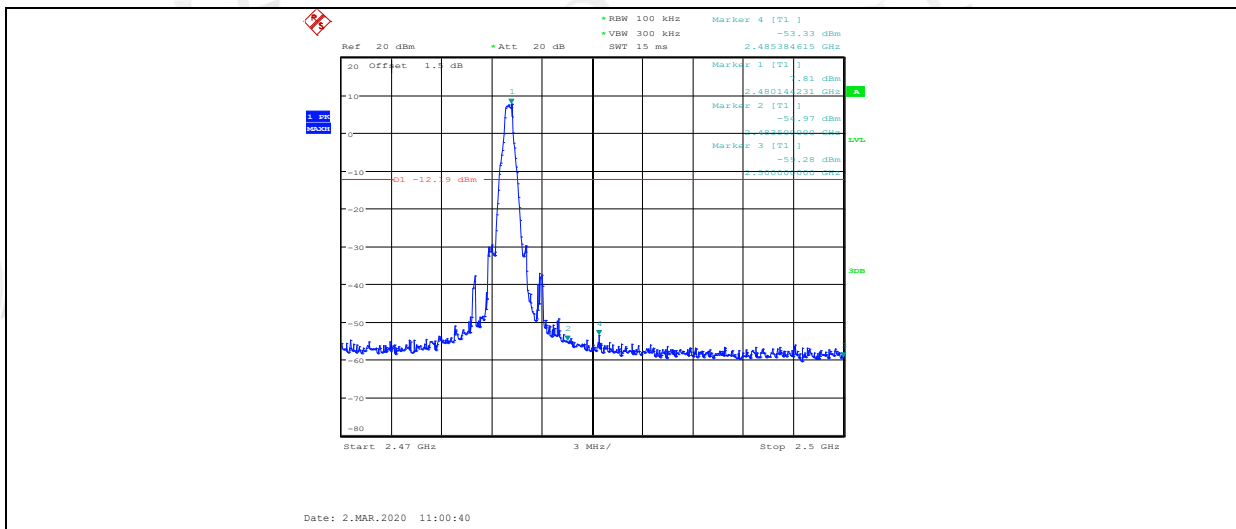

DH5_ANT1_Low

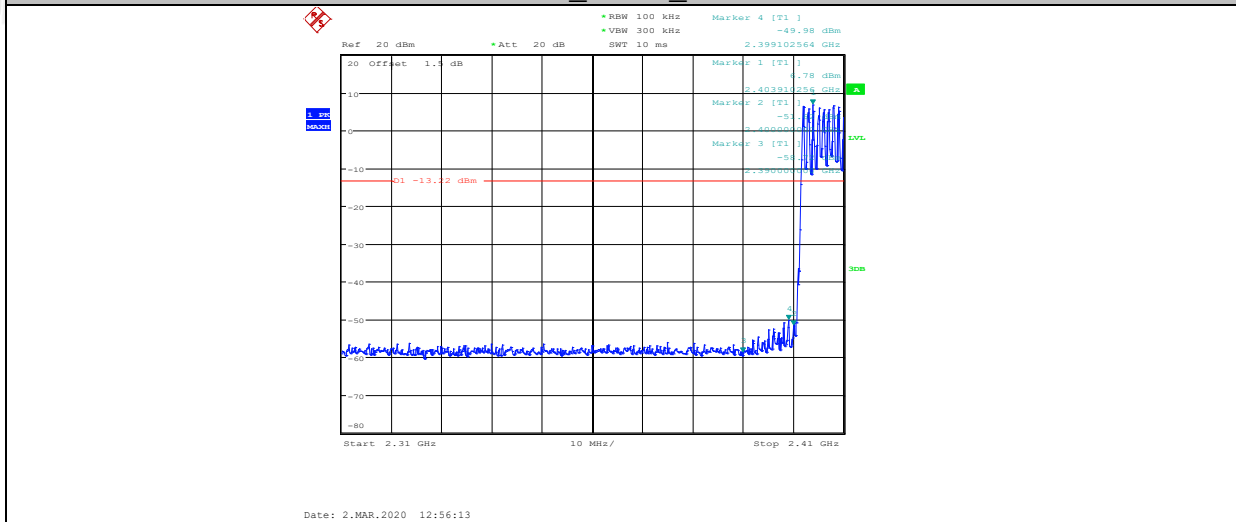

DH5_ANT1_High

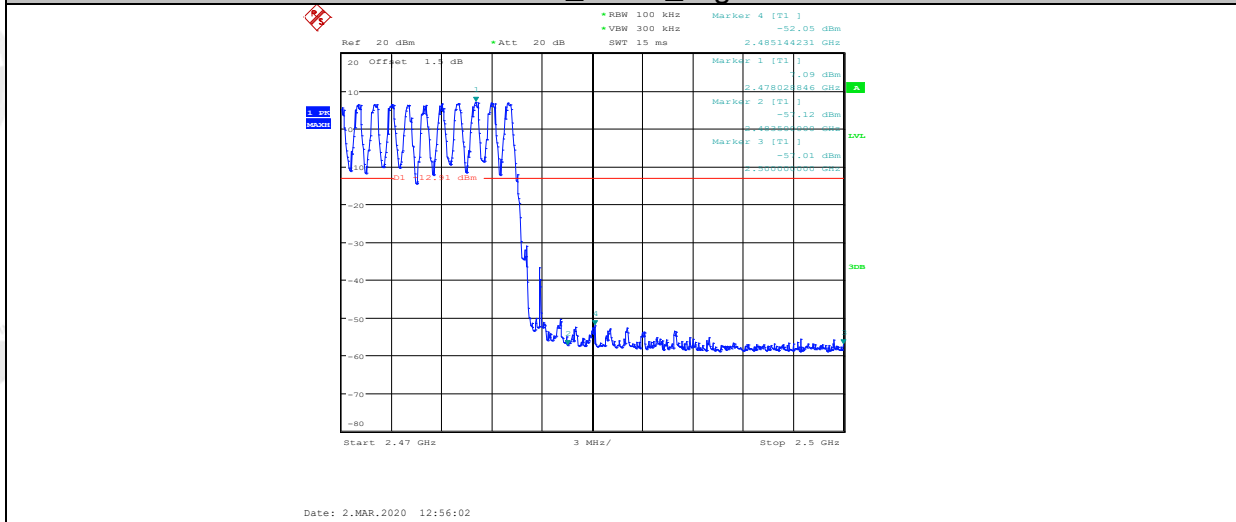

2DH5_ANT1_Low

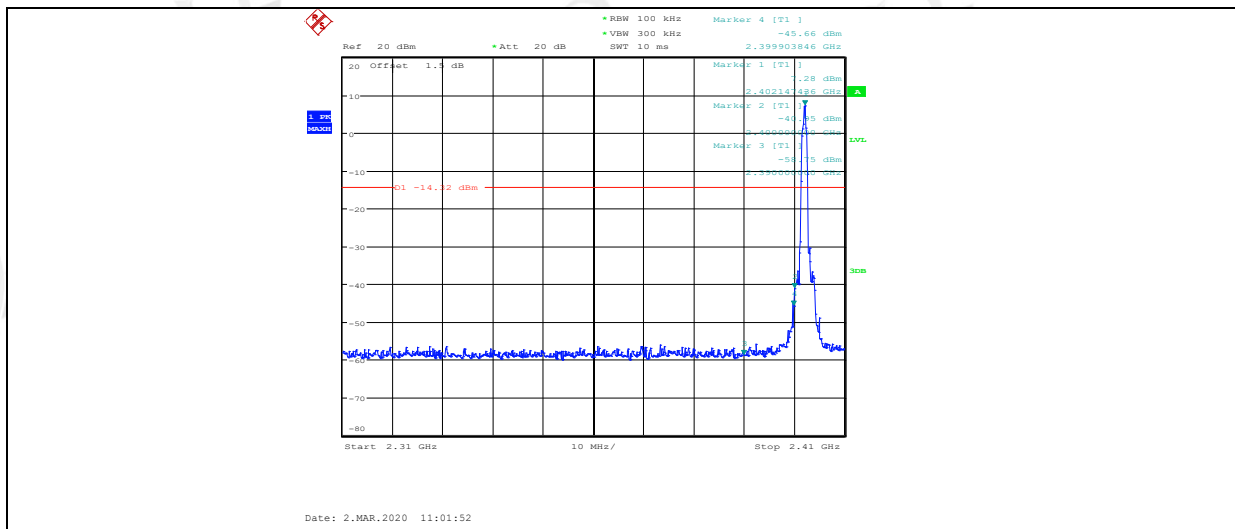

2DH5_ANT1_High

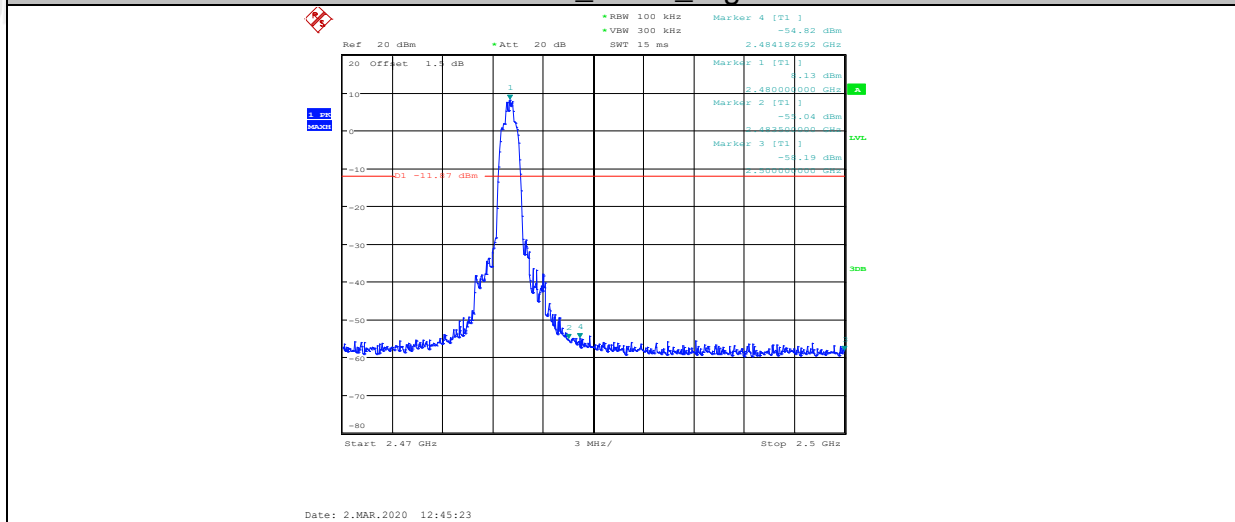

2DH5_ANT1_Low

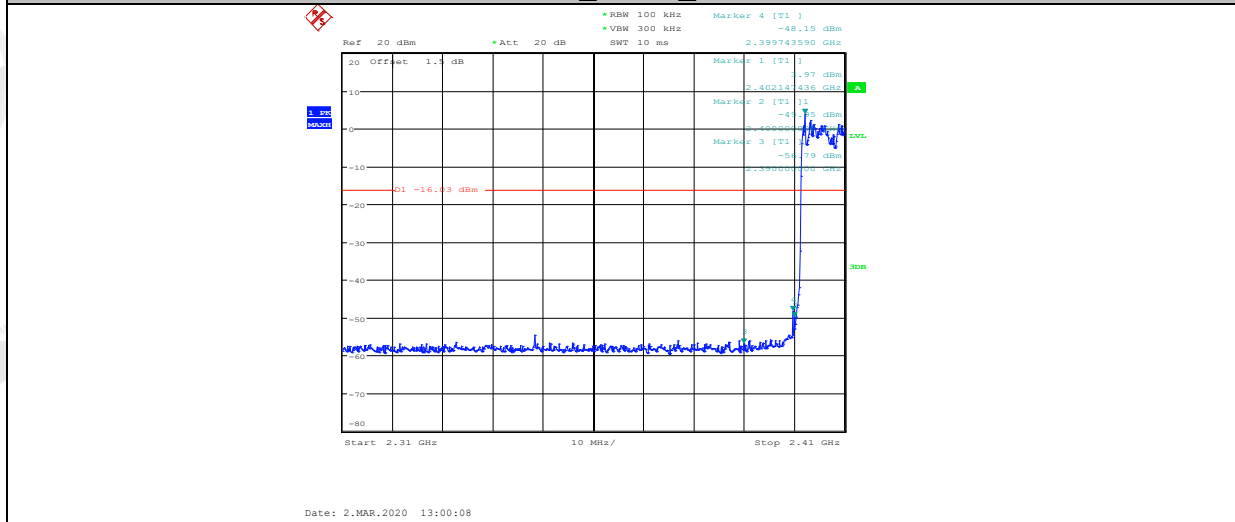

2DH5_ANT1_High

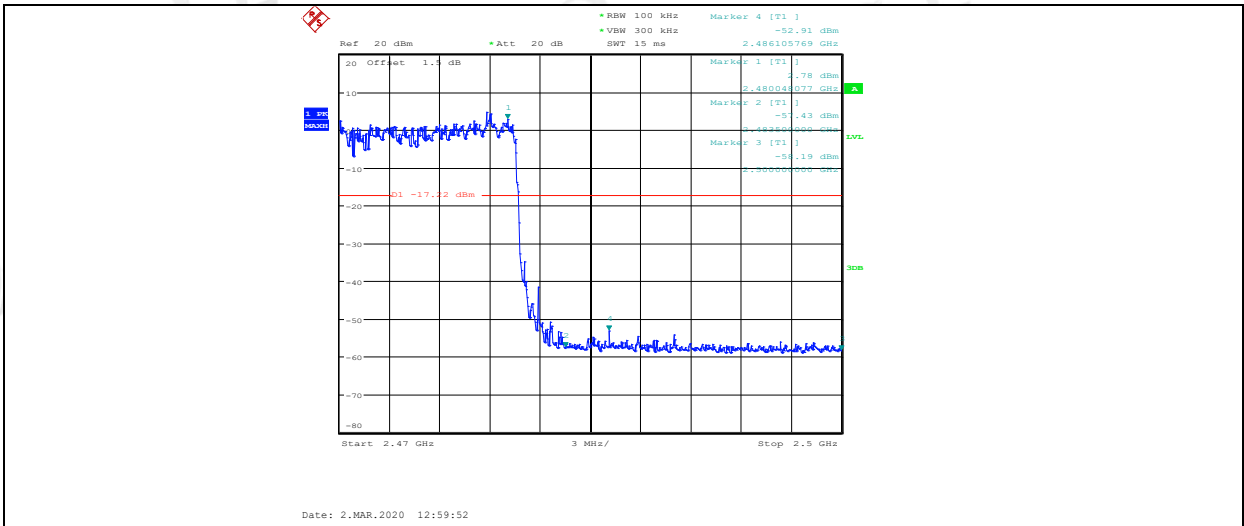

3DH5_ANT1_Low

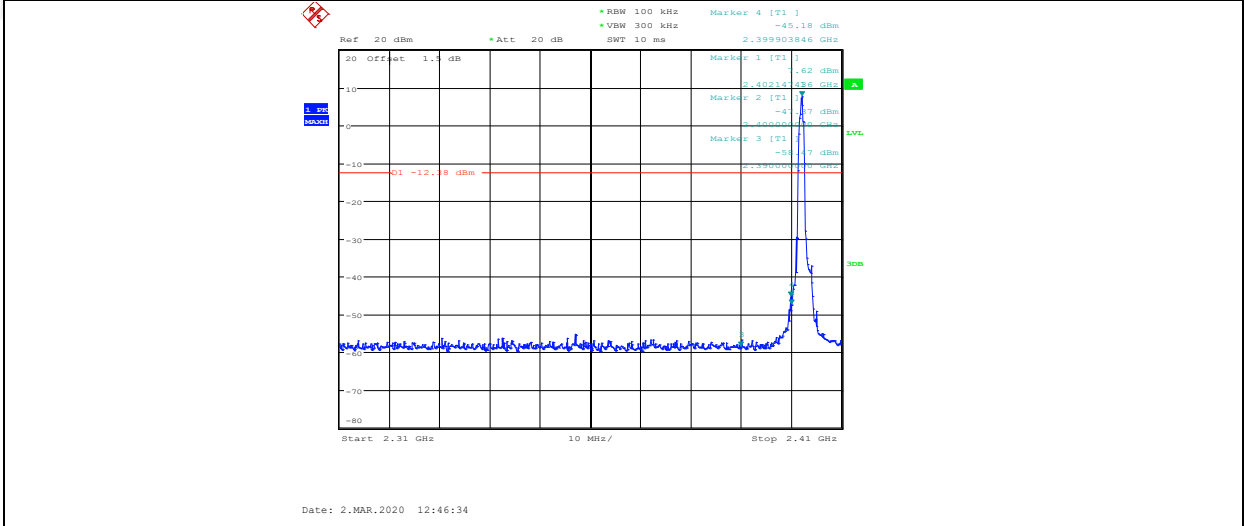

3DH5_ANT1_High

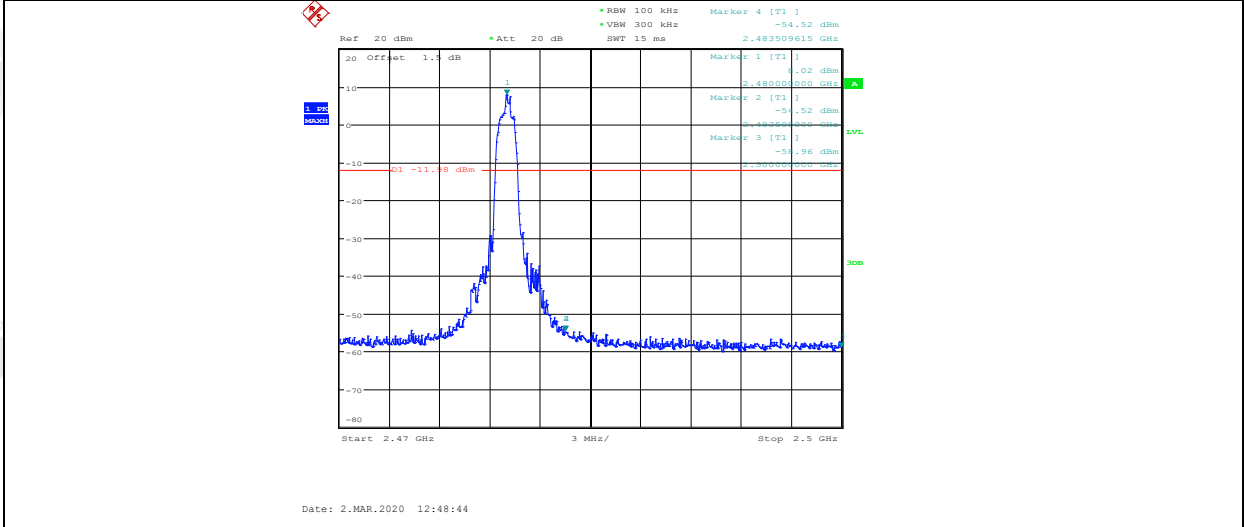

3DH5_ANT1_Low

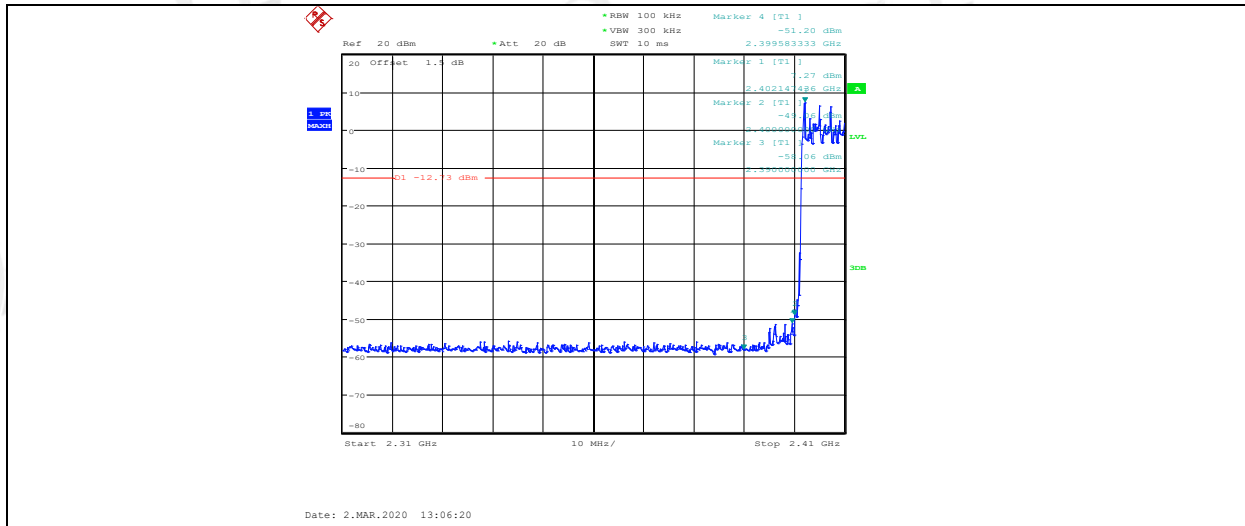

3DH5_ANT1_High

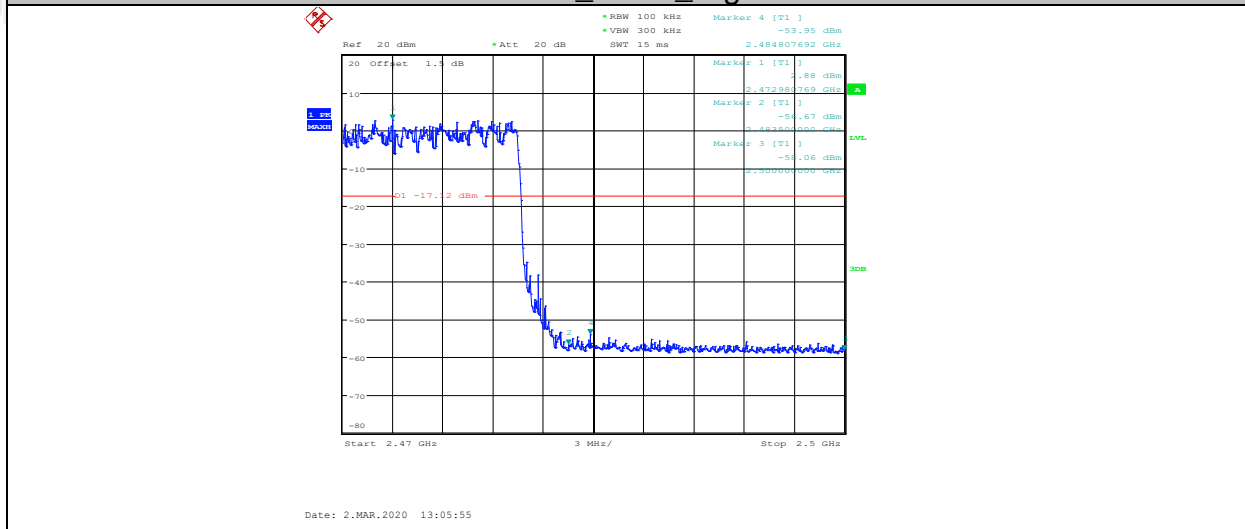

10. Radiated emission

10.1. Block diagram of test setup

In 3m Anechoic Chamber Test Setup Diagram for 9kHz-30MHz

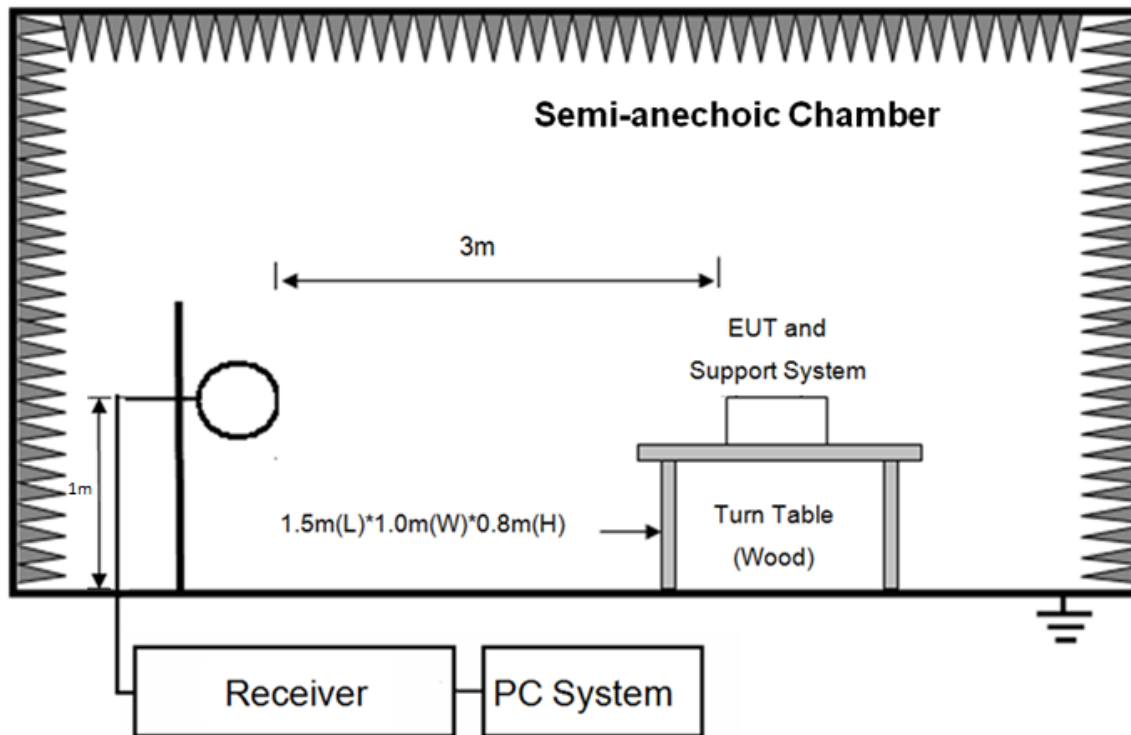

In 3m Anechoic Chamber Test Setup Diagram for below 1GHz

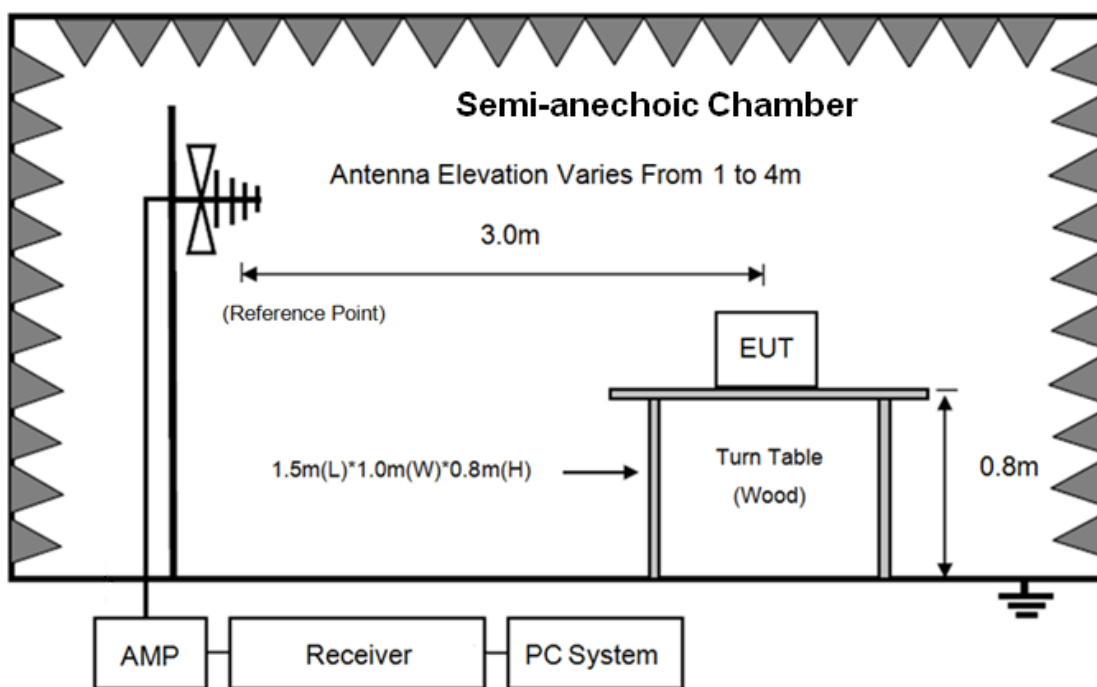

In 3m Anechoic Chamber Test Setup Diagram for frequency above 1GHz

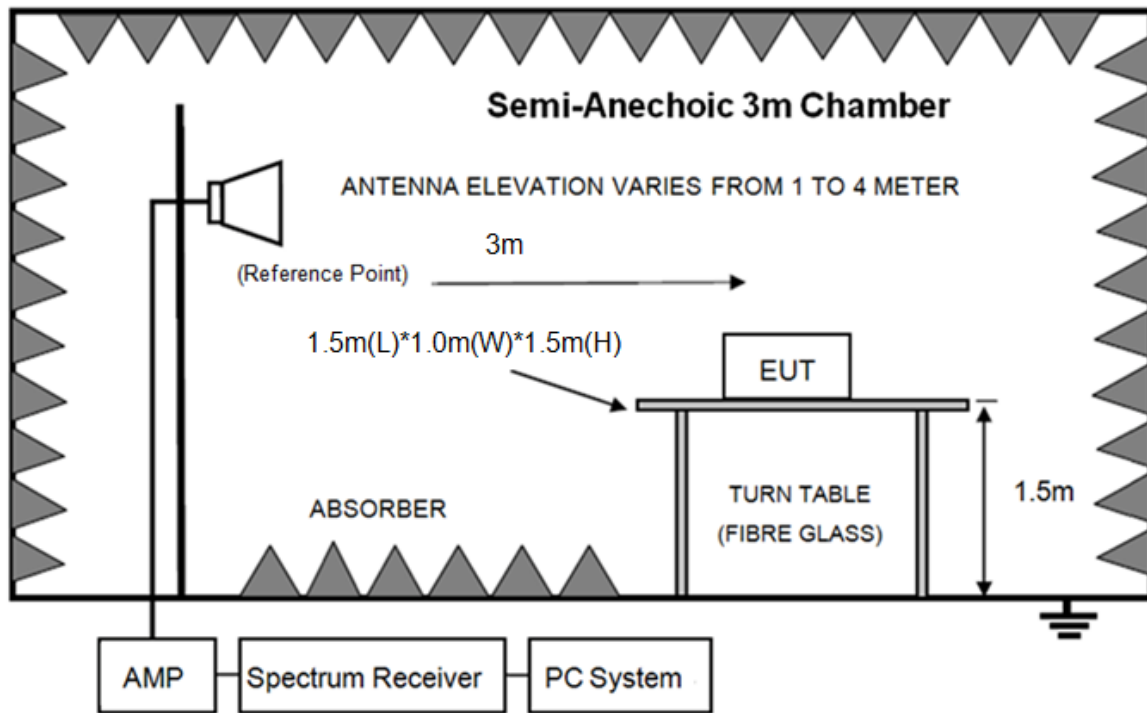

Note: For harmonic emissions test an appropriate high pass filter was inserted in the input port of AMP.

10.2. Limit

(1) FCC 15.205 Restricted frequency band

MHz	MHz	MHz	GHz
0.090-0.110	16.42-16.423	399.9-410	4.5-5.15
10.495-0.505	16.69475-16.69525	608-614	5.35-5.46
2.1735-2.1905	16.80425-16.80475	960-1240	7.25-7.75
4.125-4.128	25.5-25.67	1300-1427	8.025-8.5
4.1772&4.1775	37.5-38.25	1435-1626.5	9.0-9.2
4.2072&4.2075	73-74.6	1645.5-1646.5	9.3-9.5
6.215-6.218	74.8-75.2	1660-1710	10.6-12.7
6.26775-6.26825	108-121.94	1718.8-1722.2	13.25-13.4
6.31175-6.31225	123-138	2200-2300	14.47-14.5
8.291-8.294	149.9-150.05	2310-2390	15.35-16.2
8.362-8.366	156.52475-156.52525	2483.5-2500	17.7-21.4
8.37625-8.38675	156.7-156.9	2690-2900	22.01-23.12
8.41425-8.41475	162.0125-167.17	3260-3267	23.6-24.0
12.29-12.293	167.72-173.2	3332-3339	31.2-31.8
12.51975-12.52025	240-285	3345.8-3358	36.43-36.5
12.57675-12.57725	322-335.4	3600-4400	(?)
13.36-13.41			

(2) FCC 15.209 Limit.

FREQUENCY MHz	DISTANCE Meters	FIELD STRENGTHS LIMIT	
		$\mu\text{V}/\text{m}$	$\text{dB}(\mu\text{V})/\text{m}$
0.009 ~ 0.490	300	2400/F(kHz)	67.6-20log(F)
0.490 ~ 1.705	30	24000/F(kHz)	87.6-20log(F)
1.705 ~ 30.0	30	30	29.54
30 ~ 88	3	100	40.0
88 ~ 216	3	150	43.5
216 ~ 960	3	200	46.0
960 ~ 1000	3	500	54.0
Above 1000	3	74.0 $\text{dB}(\mu\text{V})/\text{m}$ (Peak) 54.0 $\text{dB}(\mu\text{V})/\text{m}$ (Average)	

Note: (1) The emission limits shown in the above table are based on measurements employing a CISPR QP detector except for the frequency bands 9-90kHz, 110-490kHz and above 1000MHz, radiated emissions limits in these three bands are based on measurements employing an average detector.

(2) At frequencies below 30MHz, measurement may be performed at a distance closer than that specified, and the limit at closer measurement distance can be extrapolated by below formula:

$$\text{Limit}_{3\text{m}}(\text{dB}\mu\text{V}/\text{m}) = \text{Limit}_{30\text{m}}(\text{dB}\mu\text{V}/\text{m}) + 40\text{Log}(30\text{m}/3\text{m})$$

(3) Limit for this EUT

All the emissions appearing within 15.205 restricted frequency bands shall not exceed the limits shown in 15.209, all the other emissions shall be at least 20dB below the fundamental emissions or comply with 15.209 limits.

10.3. Test Procedure

- (1) EUT was placed on a non-metallic table, 80 cm above the ground plane inside a semi-anechoic chamber for below 1G and 150 cm above the ground plane inside a fully-anechoic chamber for above 1G.
- (2) Test antenna was located 3m from the EUT on an adjustable mast, and the antenna used as below table.

Test frequency range	Test antenna used	Test antenna distance
9kHz-30MHz	Active Loop antenna	3m
30MHz-1GHz	Trilog Broadband Antenna	3m
1GHz-18GHz	Double Ridged Horn Antenna(1GHz-18GHz)	3m
18GHz-40GHz	Horn Antenna(18GHz-40GHz)	1m

According ANSI C63.10:2013 clause 6.4.4.2 and 6.5.3, for measurements below 30 MHz, the loop antenna was positioned with its plane vertical from the EUT and rotated about its vertical axis for maximum response at each azimuth position around the EUT. And the loop antenna also be positioned with its plane horizontal at the specified distance from the EUT. The center of the

loop is 1 m above the ground. for measurement above 30MHz, the trilog Broadband Antenna or Horn Antenna was located 3m from EUT, Measurements were made with the antenna positioned in both the horizontal and vertical planes of Polarization, and the measurement antenna was varied from 1 m to 4 m. in height above the reference ground plane to obtain the maximum signal strength.

(3) Below pre-scan procedure was first performed in order to find prominent frequency spectrum radiated emissions from 9 kHz to 25 GHz:

(a) Scanning the peak frequency spectrum with the antenna specified in step (3), and the EUT was rotated 360 degree, the antenna height was varied from 1m to 4m (Except loop antenna, it's fixed 1m above ground.)

(b) Change work frequency or channel of device if practicable.

(c) Change modulation type of device if practicable.

(d) Change power supply range from 85% to 115% of the rated supply voltage

(e) Rotated EUT though three orthogonal axes to determine the attitude of EUT arrangement produces highest emissions.

Spectrum frequency from 9 kHz to 25 GHz (tenth harmonic of fundamental frequency) was investigated, and no any obvious emission were detected from 18 GHz to 25 GHz, so below final test was performed with frequency range from 9 kHz to 18 GHz.

(4) For final emissions measurements at each frequency of interest, the EUT was rotated and the antenna height was varied between 1m and 4m in order to maximize the emission. Measurements in both horizontal and vertical polarities were made and the data was recorded. In order to find the maximum emission, the relative positions of equipment and all of the interface cables were changed according to ANSI C63.10:2013 on Radiated Emission test.

(5) The emissions from 9 kHz to 1GHz were measured based on CISPR QP detector except for the frequency bands 9-90 kHz, 110-490 kHz, for emissions from 9 kHz-90 kHz,110 kHz-490 kHz and above 1 GHz were measured based on average detector, for emissions above 1 GHz, peak emissions also be measured and need comply with Peak limit.

(6) The emissions from 9 kHz to 1 GHz, QP or average values were measured with EMI receiver with below RBW.

Frequency band	RBW
9 kHz-150 kHz	200 Hz
150 kHz-30 MHz	9 kHz
30 MHz-1 GHz	120 kHz

(7) For emissions above 1GHz, both Peak and Average level were measured with Spectrum Analyzer, and the RBW is set at 1 MHz, VBW is set at 3 MHz for Peak measure; RBW 1 MHz VBW 10 Hz for Average measure (according ANSI C63.10:2013 clause 4.1.4.2.2 procedure for average measure).

(8) X axis, Y axis, Z axis are tested, and worse setup X axis is reported.

10.4. Test result

PASS. (See below detailed test result)

All the emissions except fundamental emission from 9 kHz to 25 GHz were comply with 15.209 limits.

Note1: According exploratory test no any obvious emission was detected from 9 kHz to 30 MHz and 18 GHz to 25 GHz.

Note2: For emissions below 1GHz, according exploratory explorer test, when change Tx mode and channel, have no distinct influence on emissions level, so for emissions below 1 GHz, the final test was only performed with EUT working in right side 8DPSK, Tx 2441 MHz mode.

Note3: For emissions above 1 GHz. If peak results comply with AV limit, AV Result is deemed to comply with AV limit.

Radiated Emission test (below 1GHz)

TR-4-E-009 Radiated Emission Test Result

Test Site : DDT 3m Chamber 1#
Test Date : 2020-03-05
EUT : BLUETOOTH HEADSET
Power Supply : Battery
Condition : Temp:24.5°C,Humi:55%,Press:100.1kPa
Memo :

D:\2020 RE 1# Report data\Q20022505-1E REFLECT FLOW\FCC BELOW1G.EM6
Tested By : Jacky
Model Number : REFLECT FLOW
Test Mode : Tx mode
Antenna/Distance : 2019 VULB 9163 1#/3m/VERTICAL

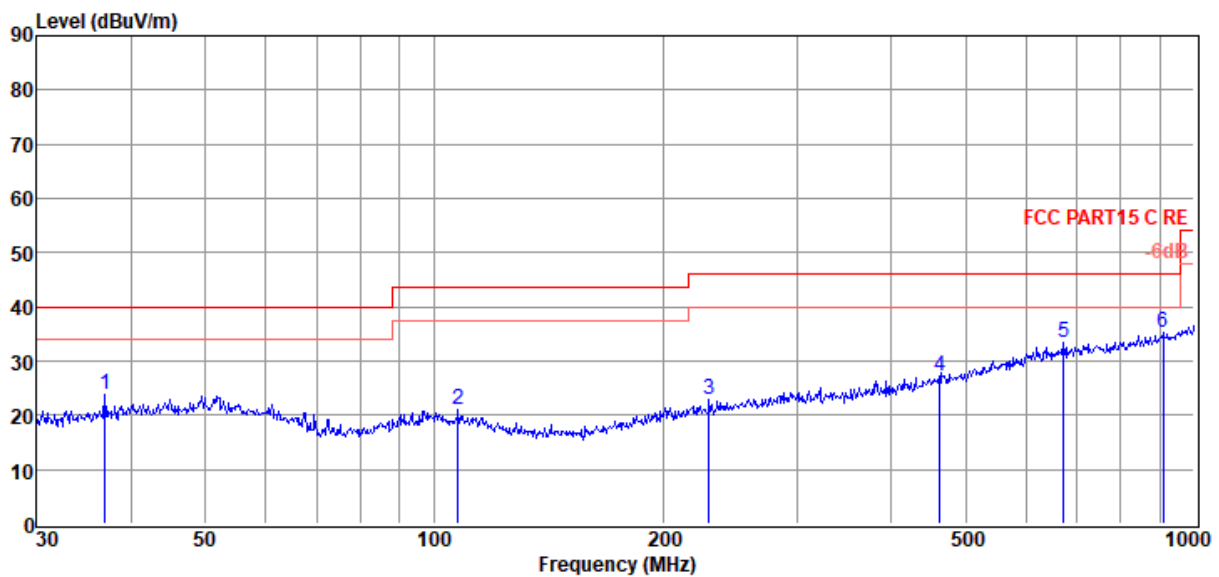

Item (Mark)	Freq. (MHz)	Read Level (dB μ V)	Antenna Factor (dB/m)	Cable Loss (dB)	Result Level (dB μ V/m)	Limit Line (dB μ V/m)	Over Limit (dB)	Detector	Polarization
1	36.90	6.89	13.00	3.87	23.76	40.00	-16.24	Peak	VERTICAL
2	107.51	5.07	11.44	4.47	20.98	43.50	-22.52	Peak	VERTICAL
3	230.10	5.22	12.33	5.19	22.74	46.00	-23.26	Peak	VERTICAL
4	462.35	4.58	16.53	6.21	27.32	46.00	-18.68	Peak	VERTICAL
5	672.84	6.56	19.72	6.99	33.27	46.00	-12.73	Peak	VERTICAL
6	909.67	5.77	21.90	7.72	35.39	46.00	-10.61	Peak	VERTICAL

Note: 1. Result Level = Read Level + Antenna Factor + Cable loss.

2. If Peak Result complies with QP limit, QP Result is deemed to comply with QP limit.

3. Test setup: RBW: 120 kHz, VBW: 300 kHz, Sweep time: auto.

TR-4-E-009 Radiated Emission Test Result

Test Site : DDT 3m Chamber 1# D:\2020 RE 1# Report data\Q20022505-1E REFLECT FLOW\FCC BELOW1G.EM6
Test Date : 2020-03-05 **Tested By** : Jacky
EUT : BLUETOOTH HEADSET **Model Number** : REFLECT FLOW
Power Supply : Battery **Test Mode** : Tx mode
Condition : Temp:24.5°C,Humi:55%,Press:100.1kPa **Antenna/Distance** : 2019 VULB 9163 1#/3m/HORIZONTAL
Memo :

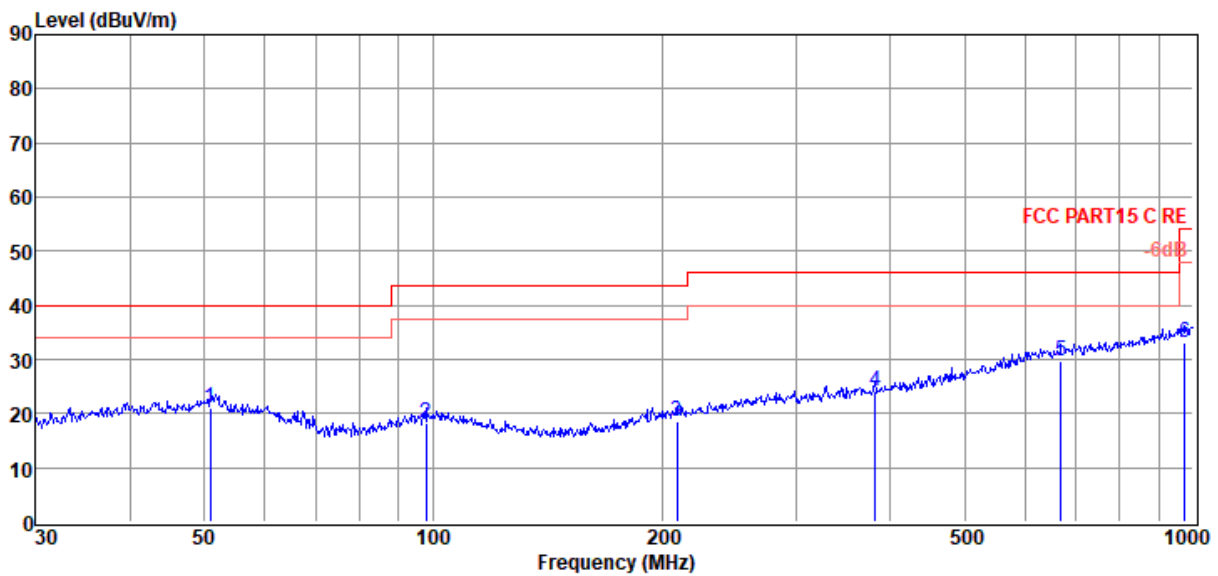

Item (Mark)	Freq. (MHz)	Read Level (dBμV)	Antenna Factor (dB/m)	Cable Loss (dB)	Result Level (dBμV/m)	Limit Line (dBμV/m)	Over Limit (dB)	Detector	Polarization
1	50.94	2.97	14.08	4.00	21.05	40.00	-18.95	QP	HORIZONTAL
2	97.80	2.04	11.69	4.39	18.12	43.50	-25.38	QP	HORIZONTAL
3	209.31	1.66	11.70	5.08	18.44	43.50	-25.06	QP	HORIZONTAL
4	381.25	3.12	15.10	5.89	24.11	46.00	-21.89	QP	HORIZONTAL
5	670.49	2.96	19.70	6.98	29.64	46.00	-16.36	QP	HORIZONTAL
6	975.75	2.72	22.57	7.90	33.19	54.00	-20.81	QP	HORIZONTAL

Note: 1. Result Level = Read Level + Antenna Factor + Cable loss.
 2. If Peak Result complies with QP limit, QP Result is deemed to comply with QP limit.
 3. Test setup: RBW: 120 kHz, VBW: 300 kHz, Sweep time: auto.

Radiated Emission test (above 1GHz)

Freq. (MHz)	Read level (dB μ V)	Antenna Factor (dB/m)	PRM Factor (dB)	Cable Loss (dB)	Result Level (dB μ V/m)	Limit (dB μ V/m)	Margin (dB)	Detector type	Polarization
Tx mode 2402MHz									
5301.00	45.31	34.68	43.31	7.12	43.80	74.00	-30.20	Peak	HORIZONTAL
7154.00	44.85	36.03	42.92	8.33	46.29	74.00	-27.71	Peak	HORIZONTAL
8259.00	45.44	36.81	42.74	9.05	48.56	74.00	-25.44	Peak	HORIZONTAL
10129.00	44.58	37.75	42.39	9.98	49.92	74.00	-24.08	Peak	HORIZONTAL
12050.00	45.56	38.41	42.25	10.84	52.56	74.00	-21.44	Peak	HORIZONTAL
12951.00	44.50	38.86	41.31	11.47	53.52	74.00	-20.48	Peak	HORIZONTAL
4804.00	50.64	34.12	43.48	6.79	48.07	74.00	-25.93	Peak	VERTICAL
6899.00	45.55	35.84	42.95	8.14	46.58	74.00	-27.42	Peak	VERTICAL
7936.00	45.51	36.56	42.81	8.95	48.21	74.00	-25.79	Peak	VERTICAL
9755.00	45.91	37.61	42.44	9.74	50.82	74.00	-23.18	Peak	VERTICAL
12050.00	45.93	38.41	42.25	10.84	52.93	74.00	-21.07	Peak	VERTICAL
12781.00	45.16	38.73	41.48	11.35	53.76	74.00	-20.24	Peak	VERTICAL
Tx mode 2441MHz									
4884.00	47.56	34.28	43.46	6.84	45.22	74.00	-28.78	Peak	HORIZONTAL
5981.00	47.39	35.19	43.11	7.59	47.06	74.00	-26.94	Peak	HORIZONTAL
8021.00	45.29	36.62	42.80	9.00	48.11	74.00	-25.89	Peak	HORIZONTAL
9551.00	44.97	37.44	42.48	9.59	49.52	74.00	-24.48	Peak	HORIZONTAL
11285.00	45.02	38.16	42.33	10.59	51.44	74.00	-22.56	Peak	HORIZONTAL
12849.00	44.75	38.78	41.41	11.40	53.52	74.00	-20.48	Peak	HORIZONTAL
4884.00	49.53	34.28	43.46	6.84	47.19	74.00	-26.81	Peak	VERTICAL
7171.00	45.48	36.04	42.91	8.34	46.95	74.00	-27.05	Peak	VERTICAL
7919.00	45.48	36.55	42.81	8.94	48.16	74.00	-25.84	Peak	VERTICAL
9534.00	45.25	37.43	42.49	9.58	49.77	74.00	-24.23	Peak	VERTICAL
11455.00	45.37	38.19	42.33	10.64	51.87	74.00	-22.13	Peak	VERTICAL
12985.00	44.27	38.89	41.28	11.49	53.37	74.00	-20.63	Peak	VERTICAL
Tx mode 2480MHz									
4961.00	45.12	34.43	43.43	6.88	43.00	74.00	-31.00	Peak	HORIZONTAL
7205.00	46.53	36.07	42.91	8.37	48.06	74.00	-25.94	Peak	HORIZONTAL
9755.00	45.19	37.61	42.44	9.74	50.10	74.00	-23.90	Peak	HORIZONTAL
11285.00	44.16	38.16	42.33	10.59	50.58	74.00	-23.42	Peak	HORIZONTAL
12084.00	45.27	38.42	42.21	10.86	52.34	74.00	-21.66	Peak	HORIZONTAL
12866.00	44.99	38.79	41.40	11.41	53.79	74.00	-20.21	Peak	HORIZONTAL
4960.00	48.92	34.42	43.43	6.88	46.79	74.00	-27.21	Peak	VERTICAL
7341.00	44.77	36.18	42.89	8.48	46.54	74.00	-27.46	Peak	VERTICAL
9670.00	44.97	37.54	42.46	9.68	49.73	74.00	-24.27	Peak	VERTICAL
11200.00	44.40	38.14	42.34	10.56	50.76	74.00	-23.24	Peak	VERTICAL
12050.00	45.56	38.41	42.25	10.84	52.56	74.00	-21.44	Peak	VERTICAL
12696.00	44.56	38.66	41.57	11.29	52.94	74.00	-21.06	Peak	VERTICAL
Result: Pass									

Note: 1. 30MHz~25GHz: (Scan with all side GFSK, $\pi/4$ -DQPSK, 8DPSK, the worst case is right side GFSK Mode)

2. Result Level = Read Level + Antenna Factor + Cable loss - PRM Factor.

3. For emissions above 1GHz. If peak results comply with AV limit, AV Result is deemed to comply with AV limit.

11. RF Conducted Spurious Emissions

11.1. Block diagram of test setup

Same as section 4.1

11.2. Limits

In any 100 kHz bandwidth outside the frequency bands in which the spread spectrum intentional radiator is operating, the radio frequency power that is produced by the intentional radiator shall be at least 20 dB below that in the 100 kHz bandwidth within the band that contains the highest level of the desired power.

11.3. Test Procedure

(1) Connect EUT's antenna output to spectrum analyzer by RF cable.

(2) Establish a reference level by using the following procedure:

Center frequency	Test frequency
RBW:	100 kHz
VBW:	300 kHz
Span	Wide enough to capture the peak level of the in-band emission
Detector Mode:	Peak
Sweep time:	auto
Trace mode	Max hold

(3) Allow the trace to stabilize, use the peak marker function to determine the maximum peak power level to establish the reference level.

(4) Set the spectrum analyzer as follows:

RBW:	100 kHz
VBW:	300 kHz
Span	Encompass frequency range to be measured
Number of measurement points	$\geq \text{span}/\text{RBW}$
Detector Mode:	Peak
Sweep time:	auto
Trace mode	Max hold

(5) Allow the trace to stabilize, use the peak marker function to determine the maximum amplitude of all unwanted emissions outside of the authorized frequency band

11.4. Test Result

Mode	Freq. (MHz)	Conclusion
GFSK	Hopping off 2402	PASS
	Hopping off 2441	PASS
	Hopping off 2480	PASS
$\pi/4$ -DQPSK	Hopping off 2402	PASS
	Hopping off 2441	PASS
	Hopping off 2480	PASS
8DPSK	Hopping off 2402	PASS
	Hopping off 2441	PASS
	Hopping off 2480	PASS

11.5. Original test data

Left side:

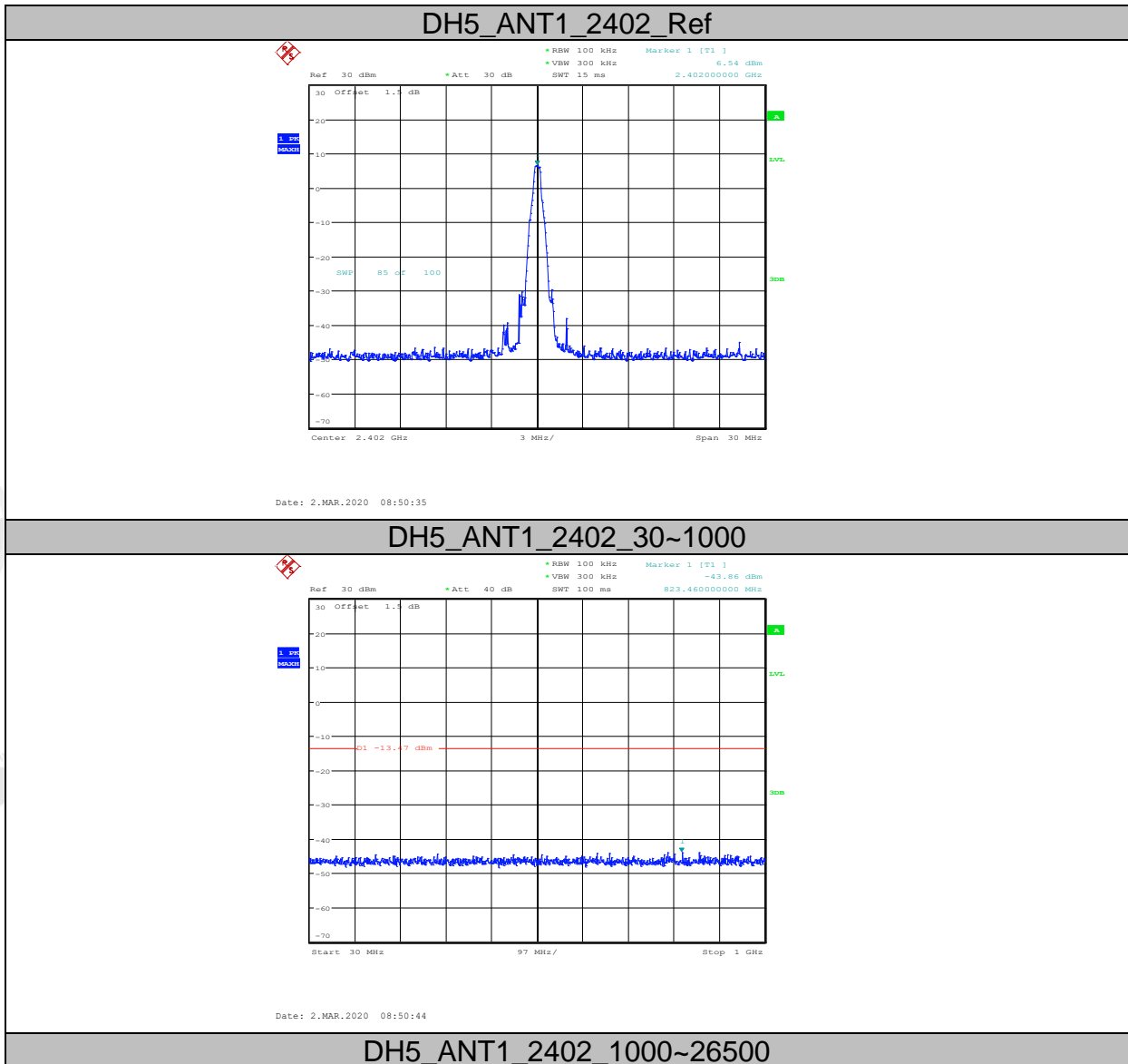

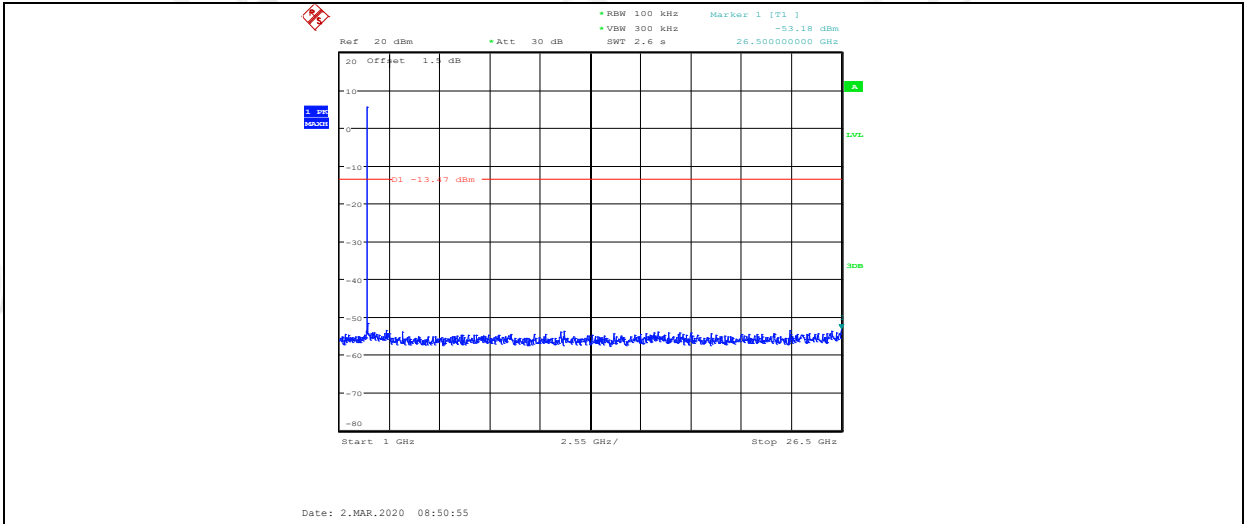

DH5_ANT1_2441_Ref

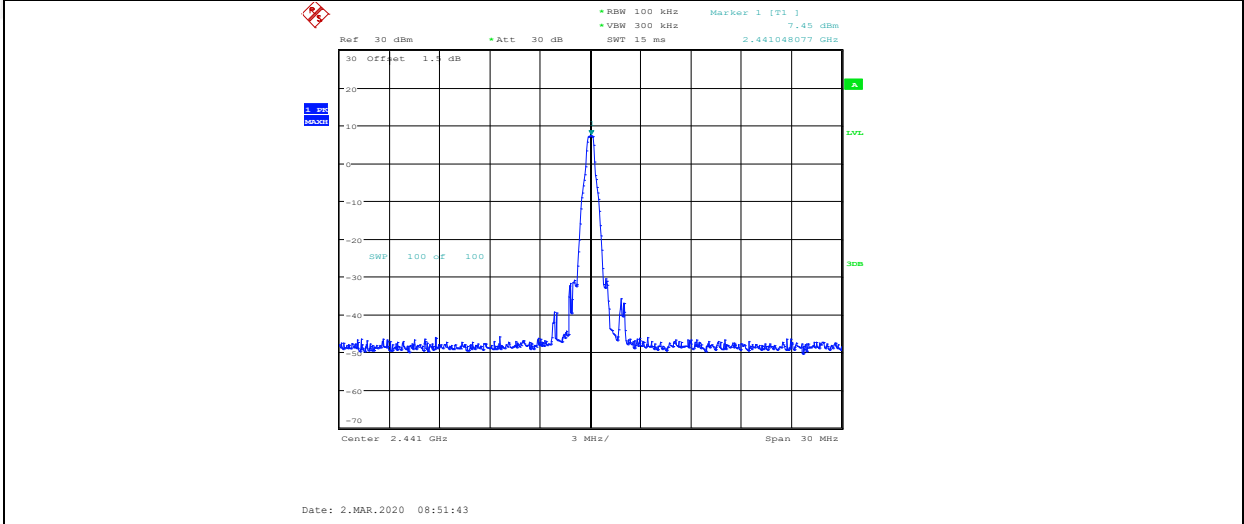

DH5_ANT1_2441_30~1000

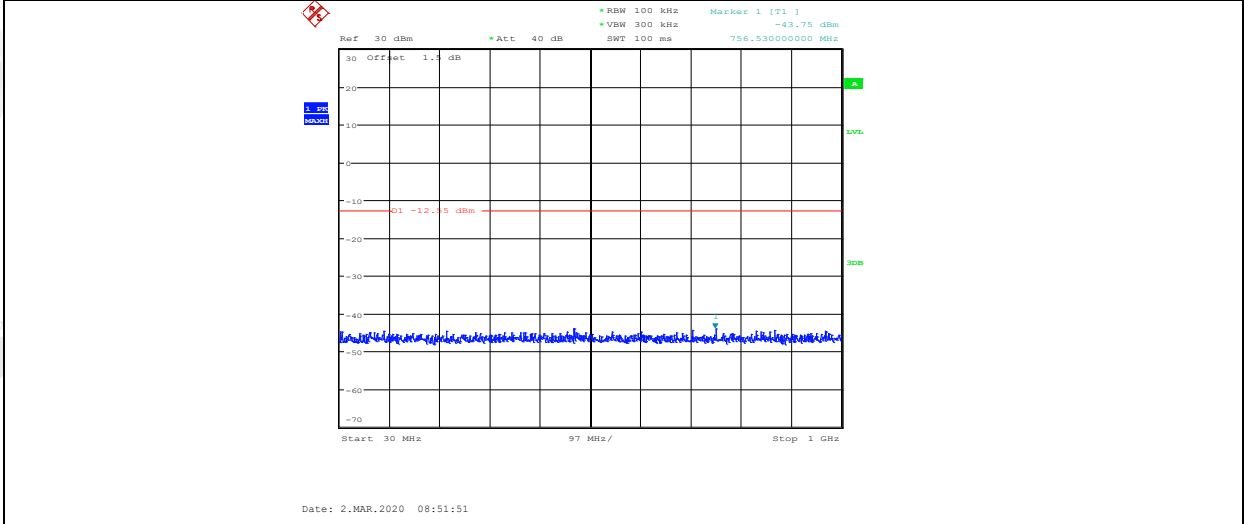

DH5_ANT1_2441_1000~26500

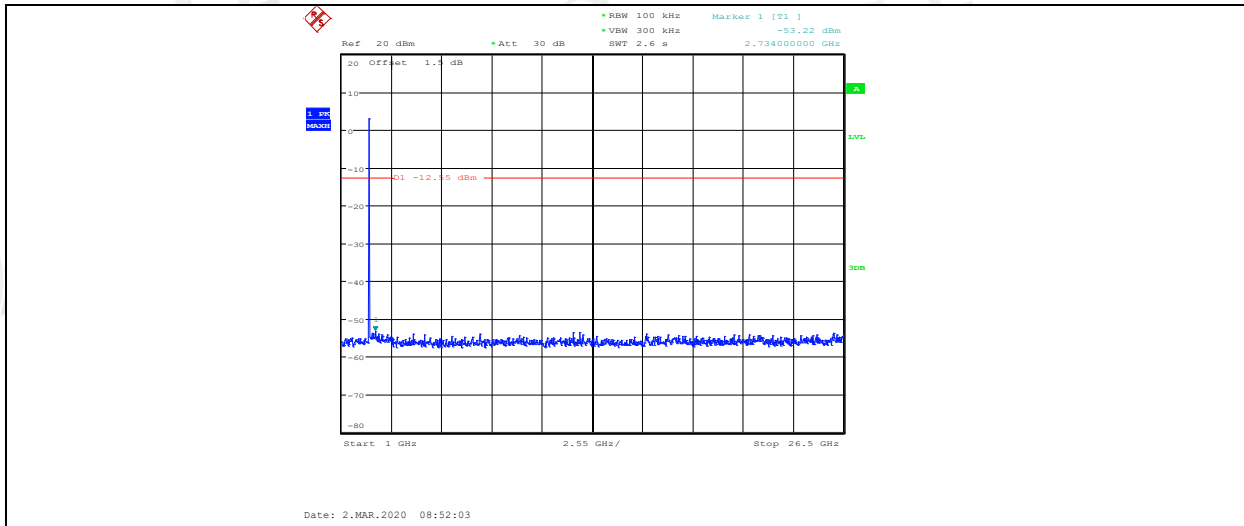

DH5_ANT1_2480_Ref

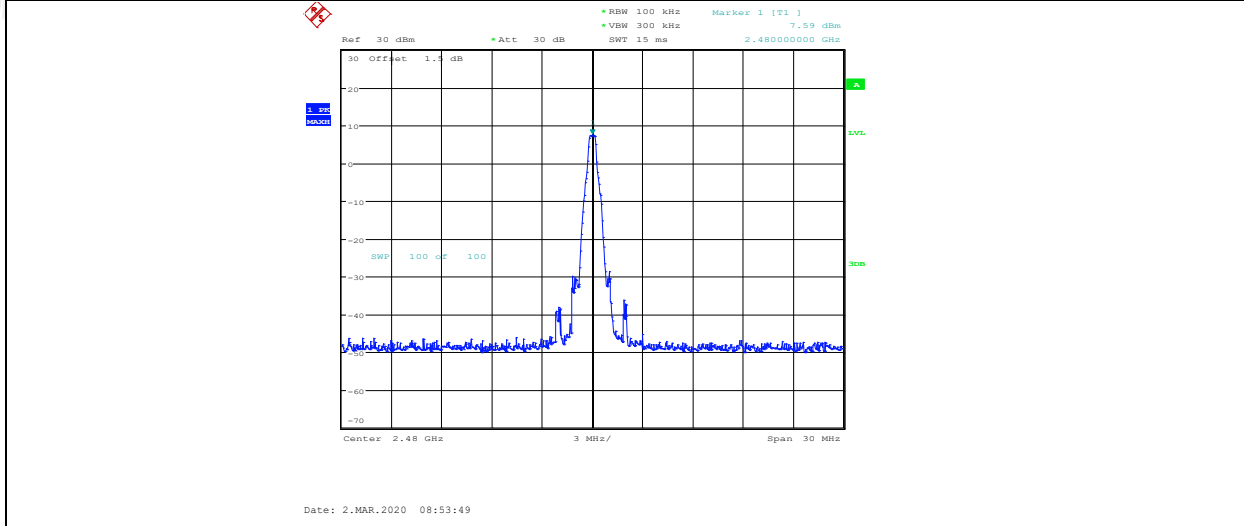

DH5_ANT1_2480_30~1000

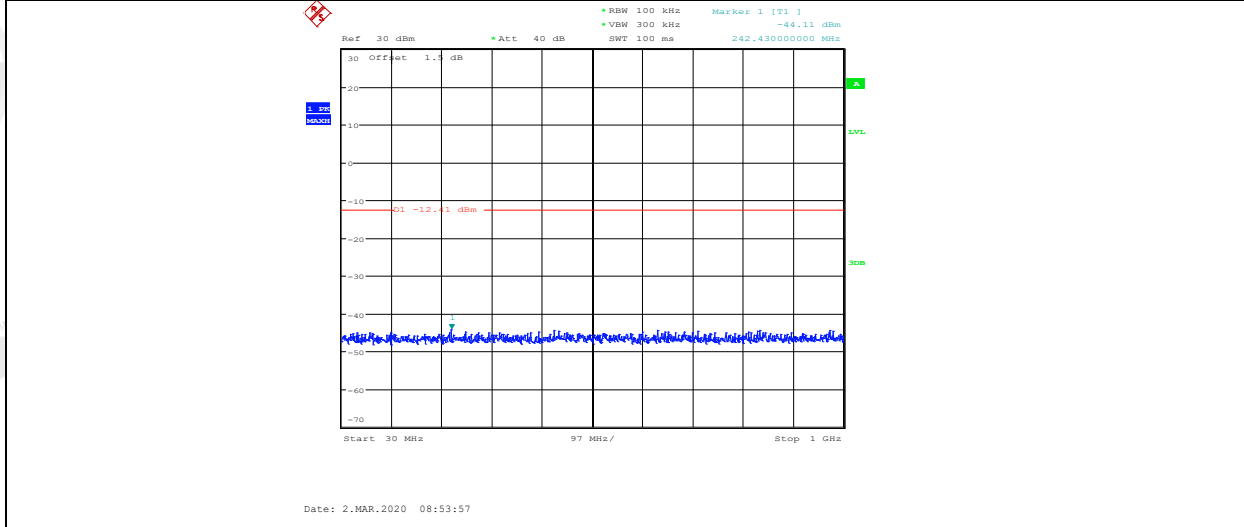

DH5_ANT1_2480_1000~26500

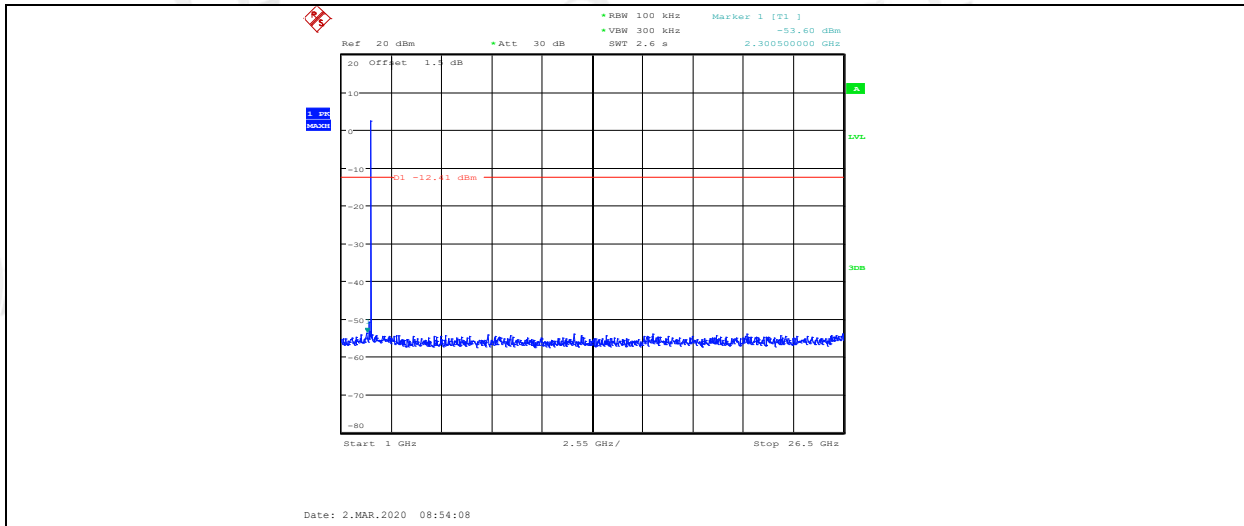

2DH5_ANT1_2402_Ref

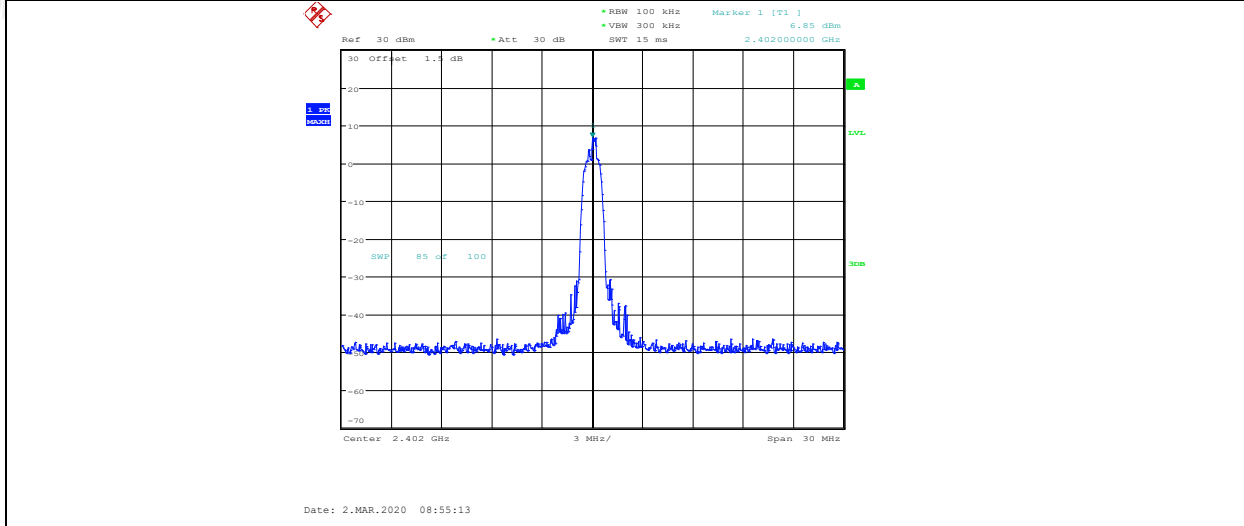

2DH5_ANT1_2402_30~1000

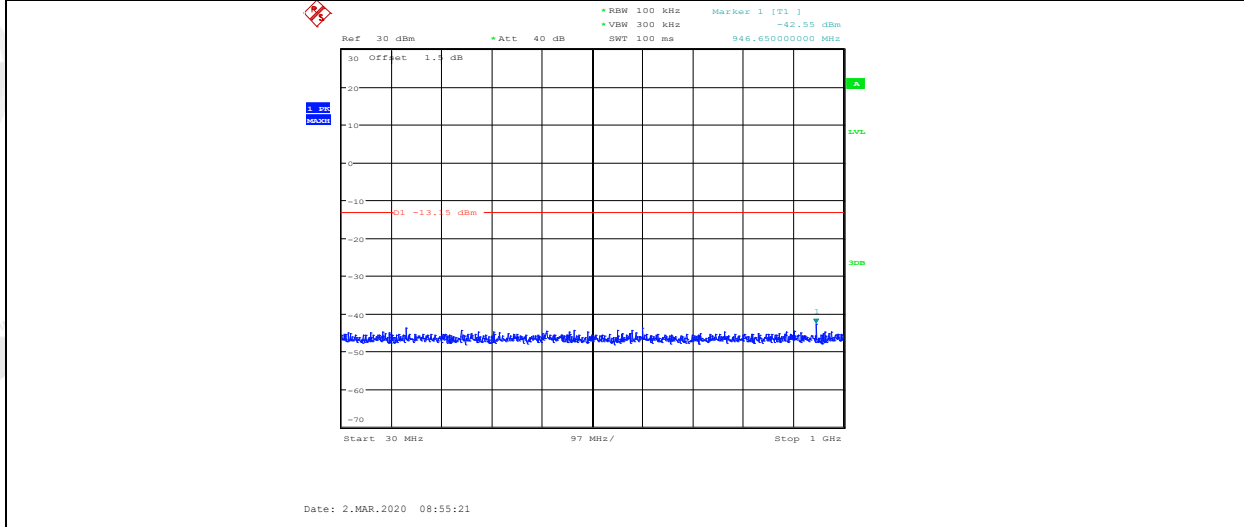

2DH5_ANT1_2402_1000~26500

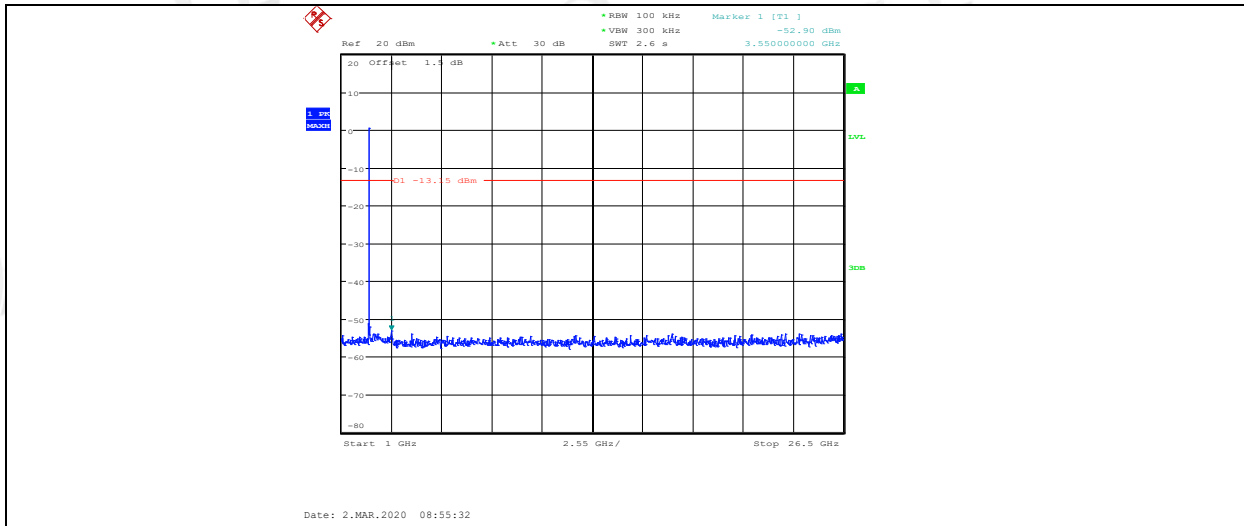

2DH5_ANT1_2441_Ref

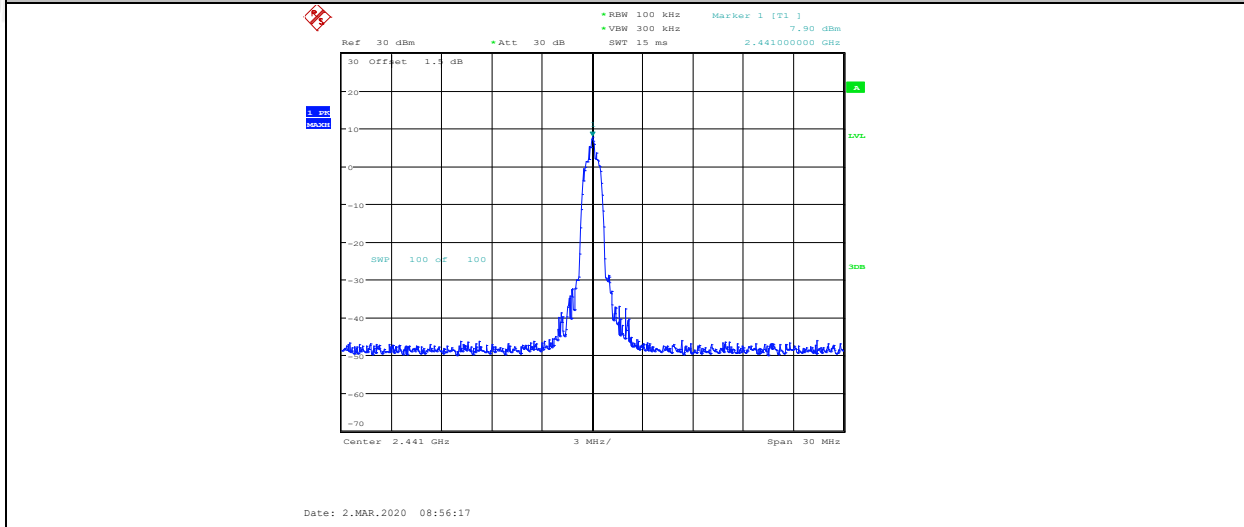

2DH5_ANT1_2441_30~1000

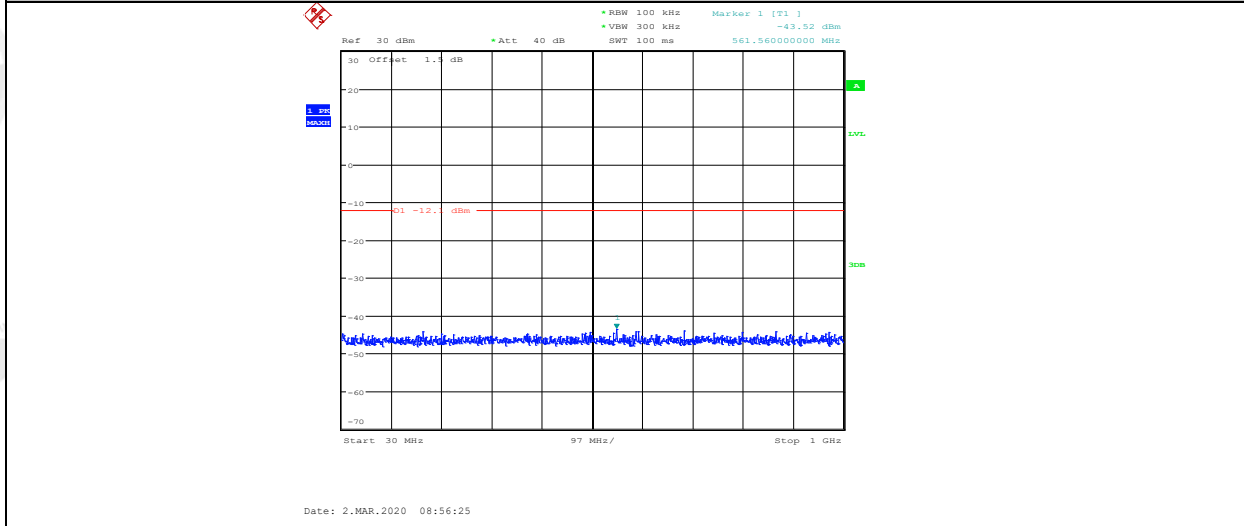

2DH5_ANT1_2441_1000~26500

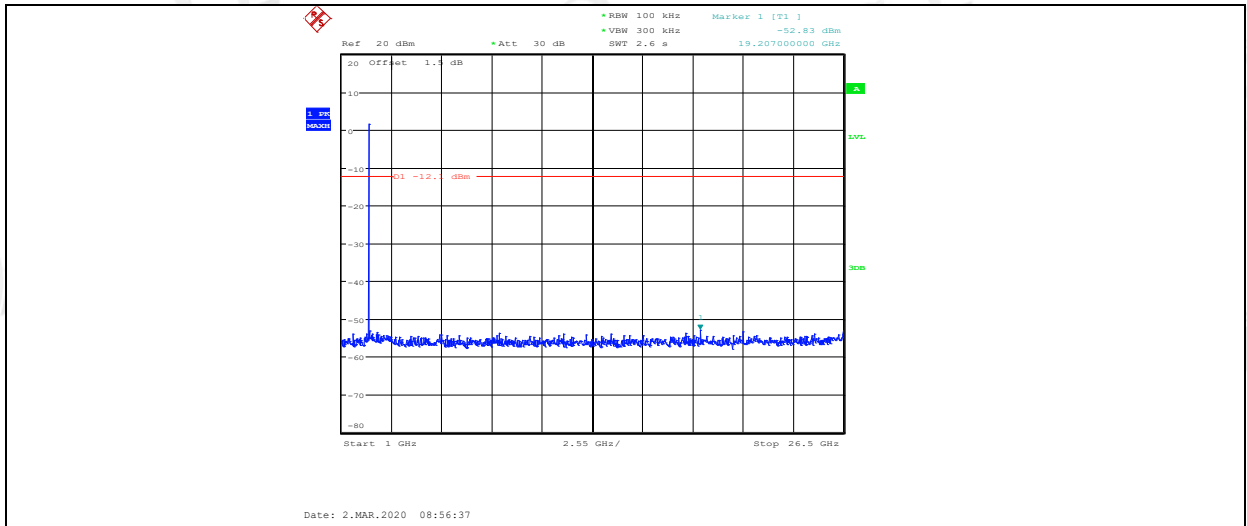

2DH5_ANT1_2480_Ref

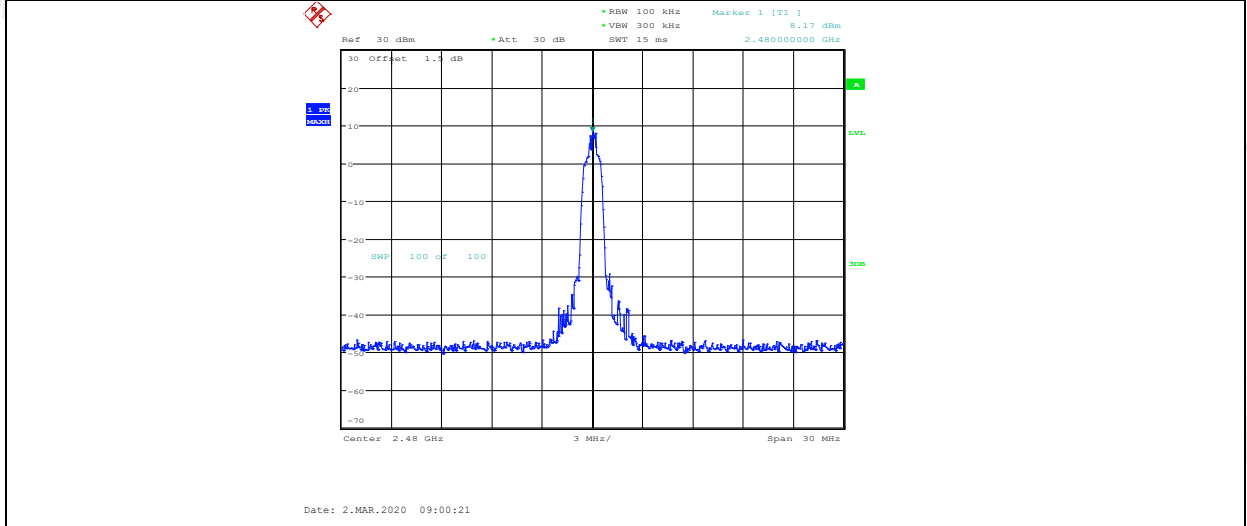

2DH5_ANT1_2480_30~1000

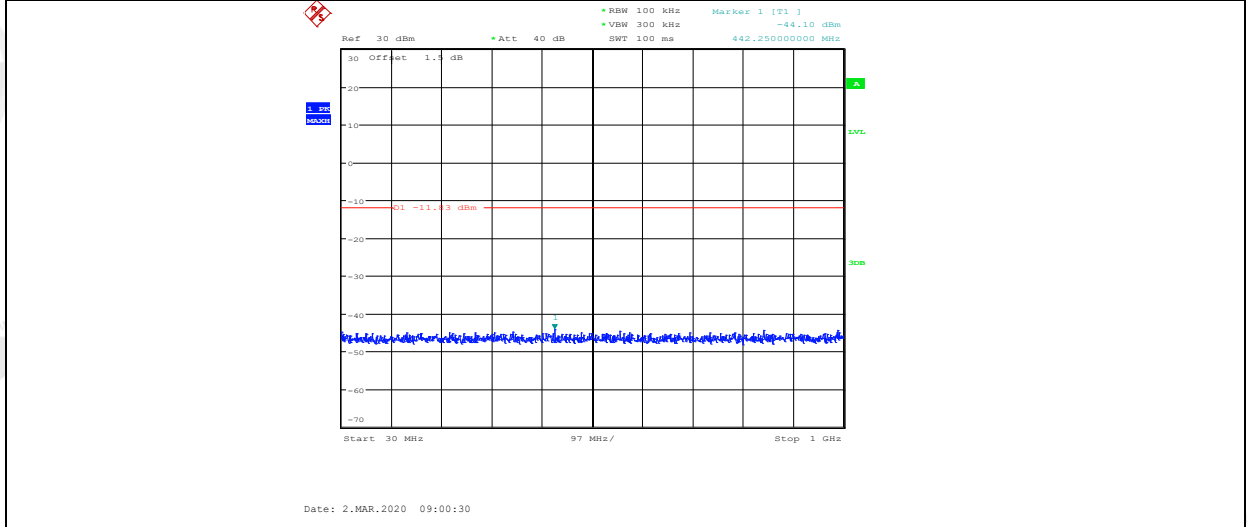

2DH5_ANT1_2480_1000~26500

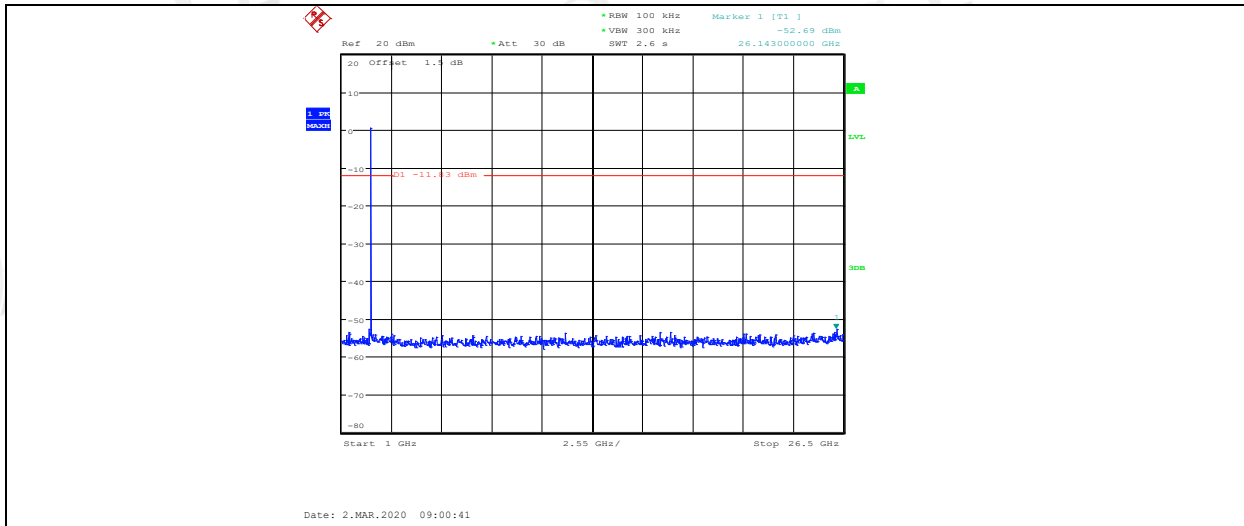

3DH5_ANT1_2402_Ref

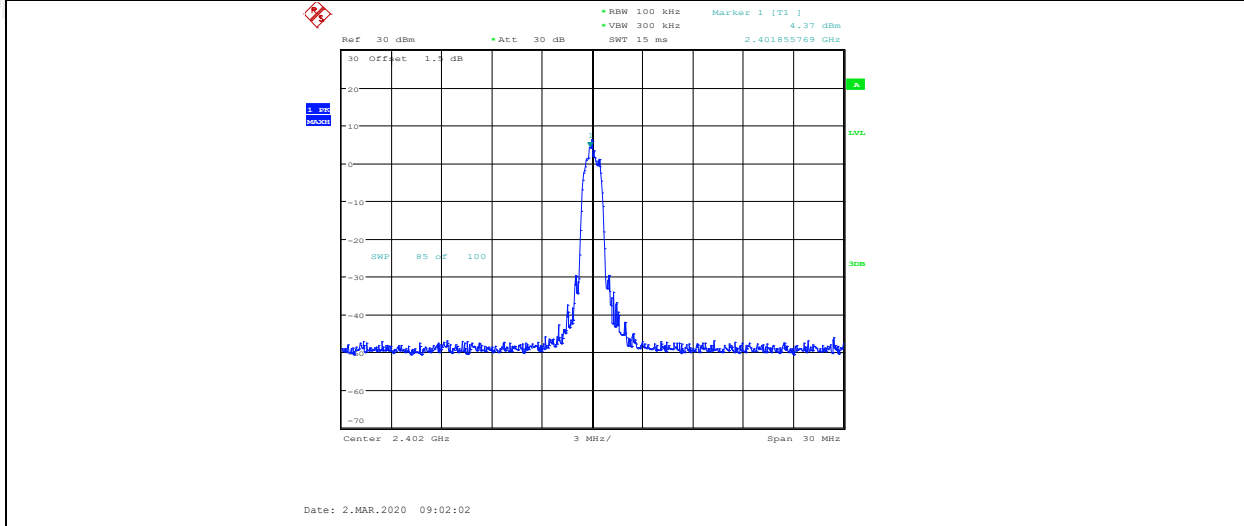

3DH5_ANT1_2402_30~1000

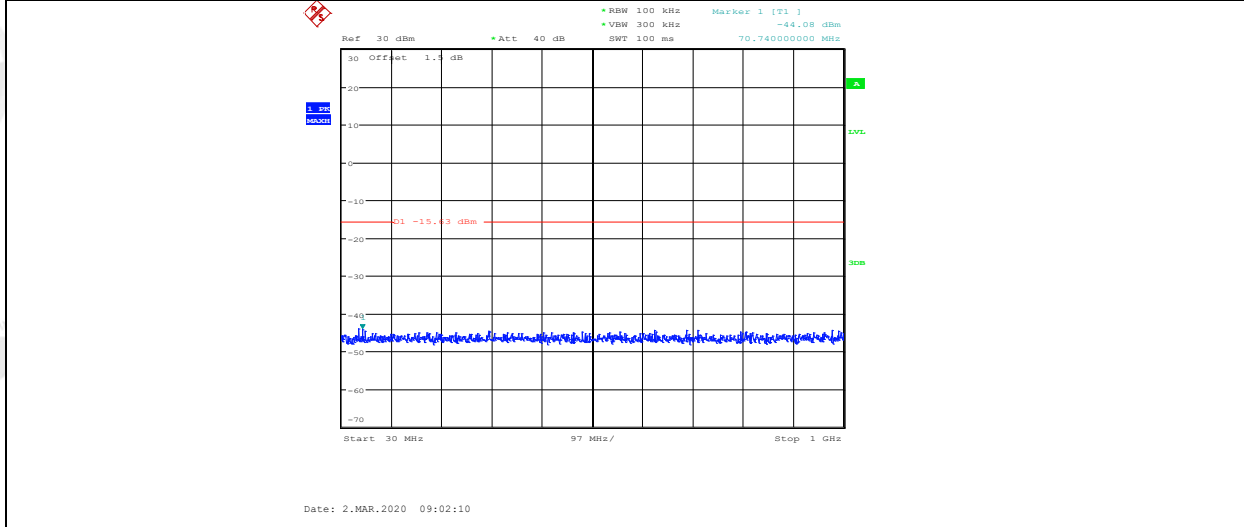

3DH5_ANT1_2402_1000~26500