

# LOVESAC

STEALTHTECH™

## SACTIONALS

Sound + Charge System

### SETUP GUIDE

Models: EE4034, EE0362, EW3251,  
GE2913, GE0177, GE7065, QST015C

————— SOUND BY —————  
**harman / kardon®**

# Important Safety Instructions

## When using a Sactionals StealthTech Sound + Charge System, basic precautions should always be followed, including:

Read all instructions before using this product.

**DANGER** – To reduce the risk of electric shock: Always unplug this product from the electrical outlet before cleaning.

**WARNING** – To reduce the risk of burns, fire, electric shock, or injury to persons:

- Unplug from outlet before putting on or taking off parts.
- Always disconnect power and audio cords before cleaning or moving your Sactionals pieces.
- Close supervision is necessary when this product is used by, or near children, or those with disabilities.
- Use this product only for its intended use as described in these instructions. Do not use attachments not recommended by the manufacturer.
- Verify line voltage before use. The Sactionals StealthTech Sound + Charge System has been designed for use with 100-240 volt, 50/60 Hz AC current.
- Connect cords to properly grounded outlets only.
- Keep all cords away from heated surfaces.
- Never operate this product if it has a damaged cord or plug, if it is not working properly, if it has been dropped, damaged, or dropped into water. Contact Lovesac Customer Love.
- When disconnecting the power cord from an AC outlet, always pull the plug; never pull the cord.
- Do not run power cords under rugs or carpets, or place heavy objects directly on them.
- Route all power and audio cords away from Sactionals Feet and Shoes using the included clips to prevent cords from being pinched underneath a Shoe or Seat Frame.
- Do not open electronic units.
- Never drop or insert any object into any opening.
- If water falls inside electronics, disconnect from the AC power source immediately.
- To prevent damage to the wireless charger and/or upfiring speaker, do not place objects more than 300 lbs on top of the Sound + Charge or Satellite Sides.
- Max Seat Load Rating – 300 lbs.
- Do not use outdoors or in wet locations. Use only in dry locations.
- Do not operate where aerosol (spray) products are being used or where oxygen is being administered.
- StealthTech products are not intended for mounting in a permanently installed or stationary furnishing or as part of a building structure.

# Important Safety Instructions

## Continued

- The Sationals StealthTech Sound + Charge System is to be used with Lovesac indoor Sactional furniture only.
- Subwoofers are only intended to be used with indoor Sactionals Seat and Deep Seat Sets.

## SAVE THESE INSTRUCTIONS

### SERVICING OF DOUBLE-INSULATED PRODUCTS

In a double-insulated product, two systems of insulation are provided instead of grounding. No grounding means is provided on a double-insulated product, nor is a means for grounding to be added to the product. Servicing a double-insulated product requires extreme care and knowledge of the system and is to be done only by qualified service personnel. Replacement parts for a double-insulated product must be identical to the parts they replace. A double-insulated product is marked with the words "DOUBLE INSULATION" or "DOUBLE INSULATED". The symbol (square within a square) is also able to be marked on the product.

# Table Of Contents

IMPORTANT SAFETY INSTRUCTIONS.....	2
INTRODUCTION.....	5
WHAT'S INCLUDED.....	6
SYSTEM ENHANCEMENTS.....	7
PLANNING YOUR LAYOUT.....	8
INSTALLATION.....	16
AUDIO PRESETS.....	31
CONNECT TO OTHER DEVICES.....	32
PRODUCT OVERVIEW.....	33
LED INDICATORS.....	38
HELP & TROUBLESHOOTING.....	41
LIMITED WARRANTY.....	43
SPECIFICATIONS.....	44
LEGAL & COMPLIANCE.....	45

# Introduction

The Sactionals StealthTech Sound + Charge System combines premium surround sound by Harman Kardon and integrated wireless charging completely hidden from view. The unique proximity and placement of speakers, combined with patented tuning technology for passing sound through fabric and upholstery, delivers an unparalleled audio experience. And, with wireless charging capabilities available where it's needed most, remaining connected is never a problem. When it comes to technology, invisible is beautiful.

We encourage you to read through this manual which describes the StealthTech products and includes step-by-step instructions to help you get started.

Read and understand all the safety instructions before using this product.

If you have any questions about these products, their installation, or their operation, please contact the Lovesac Customer Love Team at 1-888-636-1223 or [customerlove@lovesac.com](mailto:customerlove@lovesac.com). You can also visit [www.lovesac.com](http://www.lovesac.com) for additional resources.

# What's Included

## Sactionals StealthTech Sound + Charge System

Sound + Charge Side: Left

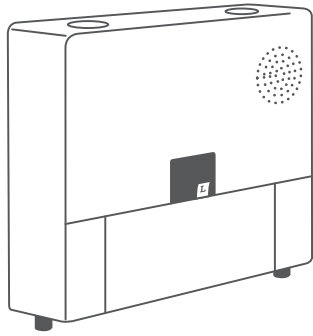

Sound + Charge Side: Right

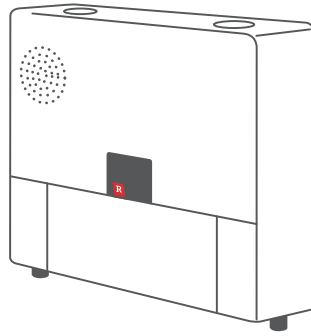

Sound + Charge Center Channel



Wall-Mount Bracket and Template

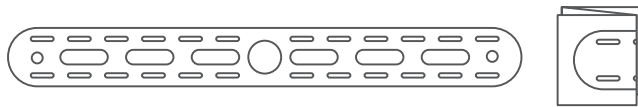

Remote Control, 2 AAA Batteries



HDMI Cable

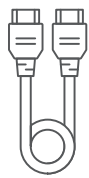

Optical Cable

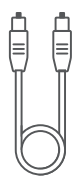

AUX Cable



Power Cord



2 Stud Screws, 1 Drill Bit

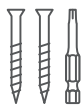

4 Screws & Drywall Anchors

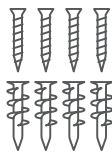

Sound + Charge Subwoofer

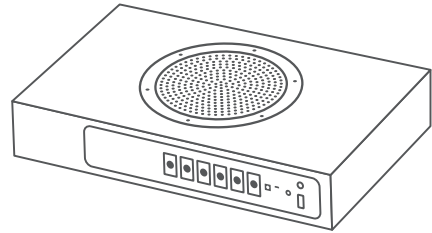

Mounting Brackets



Power Adaptor

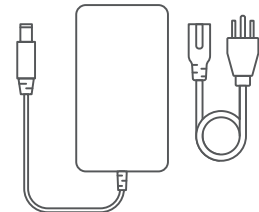

Audio Cables: R and L

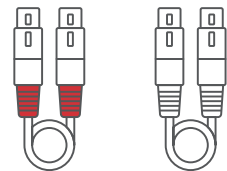

4 Thumb Screws

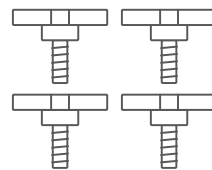

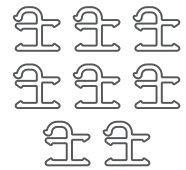

8 Cord Clips



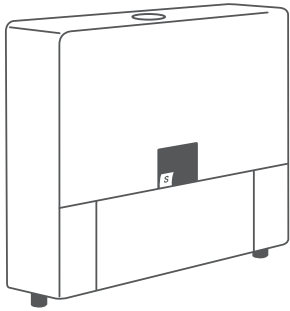

# System Enhancements

## Sactionals StealthTech Sound + Charge System Enhancements

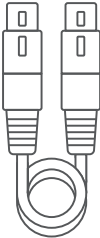
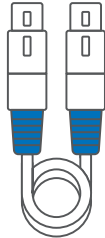
These products are optional pieces sold separately to further enhance your StealthTech experience.

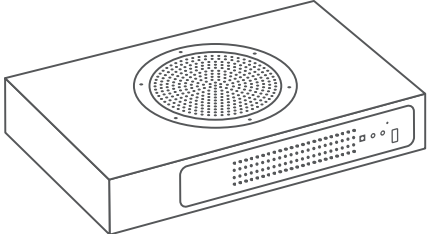
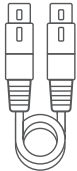
<p>Sound + Charge Satellite Side</p> 	<p>Audio Cable: Satellite</p> 	<p>Sound + Charge 25ft Audio Cable: R/L</p>  <p>For large setups</p>	<p>Sound + Charge 25ft Audio Cable: Satellite</p>  <p>For large setups with Satellite Sides</p>
--	---	---	--

<p>Sound + Charge Satellite Subwoofer</p> 	<p>25ft Audio Cable: R/L</p> 	<p>AUX Cable</p> 	<p>4 Cord Clips</p> 
---	--	--	---

# Planning Your Layout

## Configuration Key

Using the key below, the diagrams on the following pages show the optimal layout for the best sound experience for your configuration.

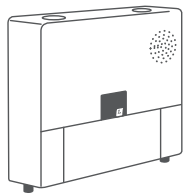

Left

**Sound + Charge Side: Left**  
Placed on left of configuration.

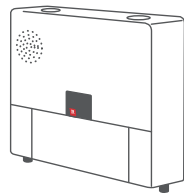

Right

**Sound + Charge Side: Right**  
Placed on right of configuration.

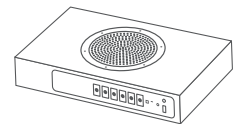

**Sound + Charge Subwoofer**  
Placed in the center of your most used seating area.

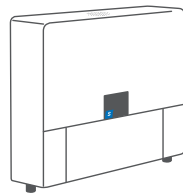

Satellite Left  
Satellite Right

**Optional Sound + Charge Satellite Side**  
"Left" and "Right" are identical and determined only by placement.



**Optional Sound + Charge Satellite Subwoofer**  
See placement suggestions below.

## Satellite Subwoofer Placement

Spread Subwoofers out so that bass is distributed throughout your configuration.

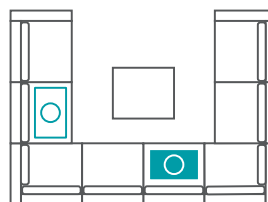
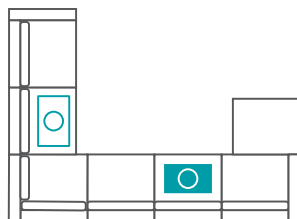



# Planning Your Layout

Choose the configuration shape that most closely matches your setup.

## Straight Configurations

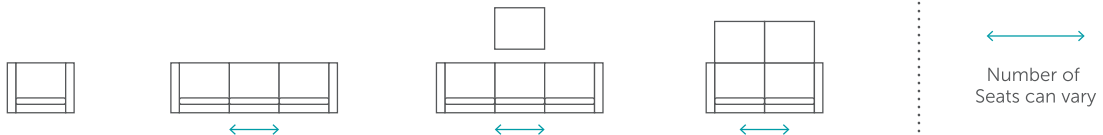

**Optimal Experience for 3 Seats or Fewer: 6 Speaker Immersive Sound + Charge System**

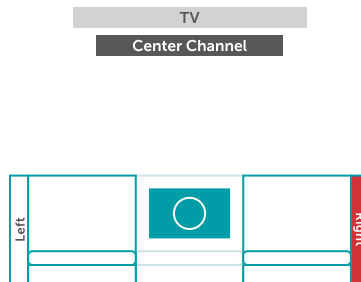

**Optimal Experience for 4 Seats or More: 8 Speaker Immersive Sound + Charge System - incorporates 2 Satellite Sides**

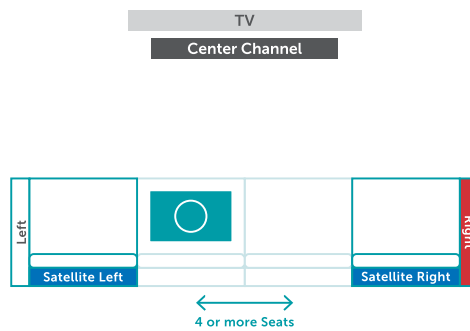

# Planning Your Layout

Choose the configuration shape that most closely matches your setup.

## Left L Configurations

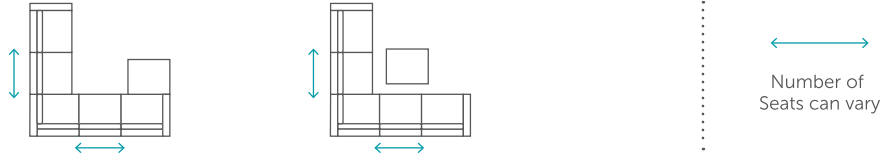

### 6 Speaker Immersive Sound + Charge System

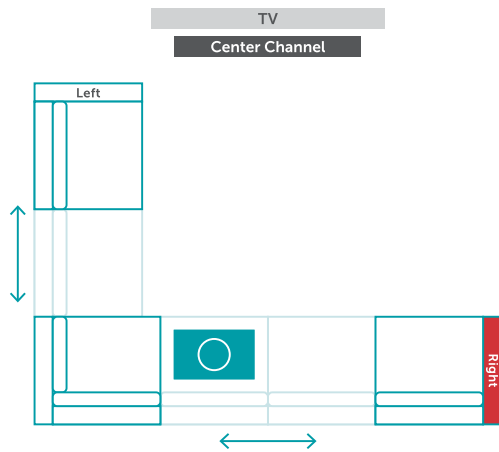

### 7 Speaker Immersive Sound + Charge System - incorporates 1 Satellite Side

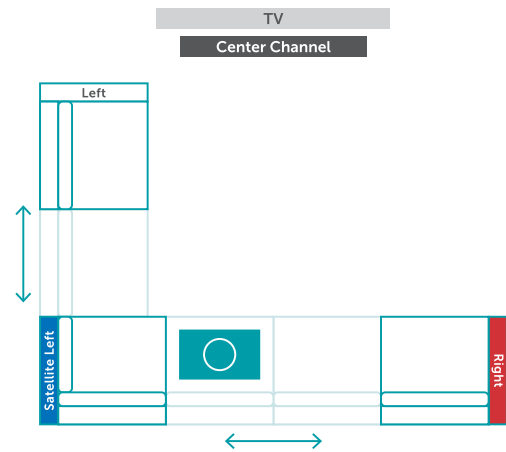

### 8 Speaker Immersive Sound + Charge System - incorporates 2 Satellite Sides

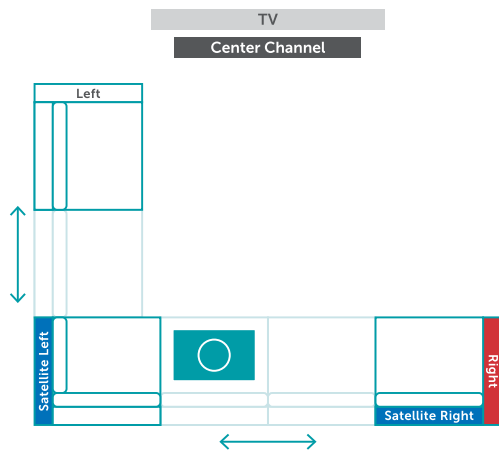

### Optimal Experience: 9 Speaker Immersive Sound + Charge System - incorporates 3 Satellite Sides

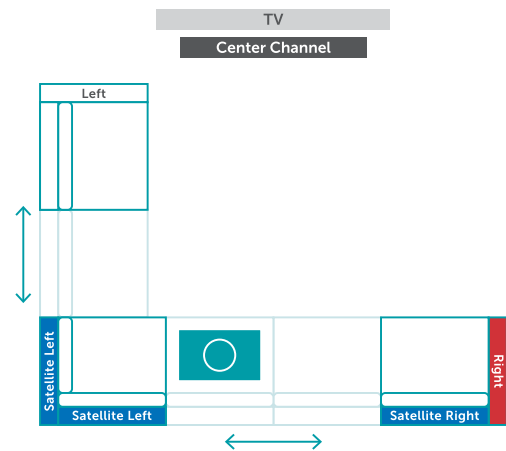

\*If you often watch TV/Movies from rear seats, consider using an optional setup found on page 15.

# Planning Your Layout

Choose the configuration shape that most closely matches your setup.

## Right L Configurations

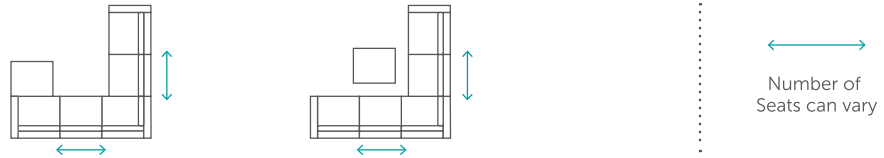

### 6 Speaker Immersive Sound + Charge System

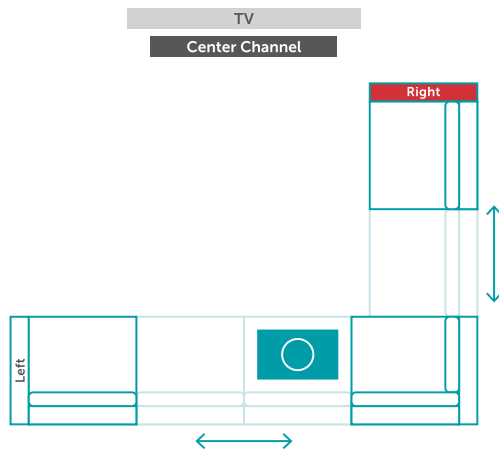

### 7 Speaker Immersive Sound + Charge System - incorporates 1 Satellite Side

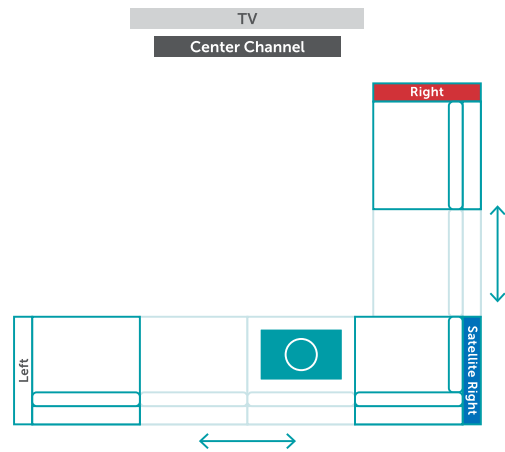

### 8 Speaker Immersive Sound + Charge System - incorporates 2 Satellite Sides

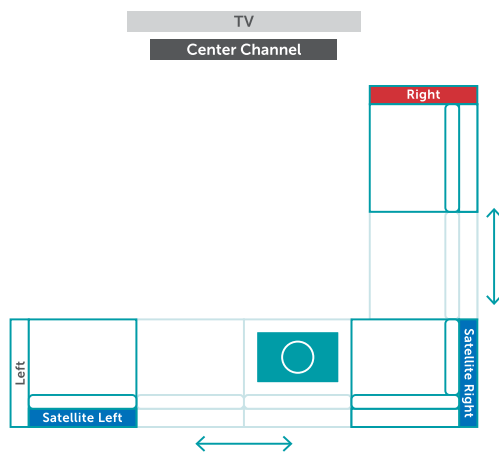

### Optimal Experience: 9 Speaker Immersive Sound + Charge System - incorporates 3 Satellite Sides

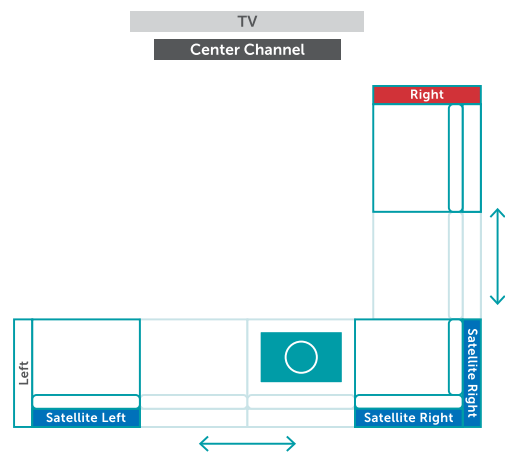

\*If you often watch TV/Movies from rear seats, consider using an optional setup found on page 15.

# Planning Your Layout

Choose the configuration shape that most closely matches your setup.

## L Configurations with TV on an Angle

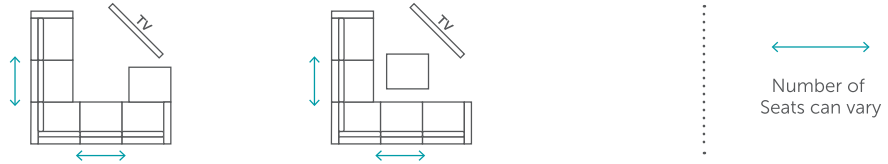

**6 Speaker Immersive Sound + Charge System**

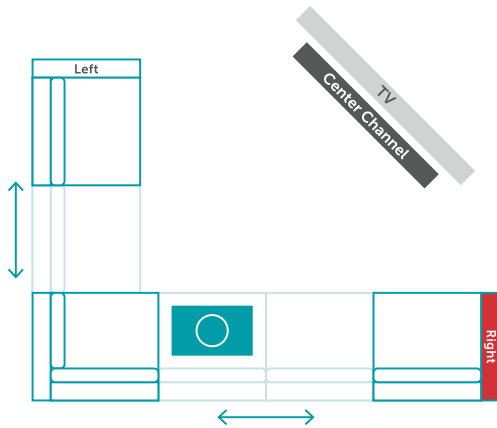

**8 Speaker Immersive Sound + Charge System - incorporates 2 Satellite Sides**

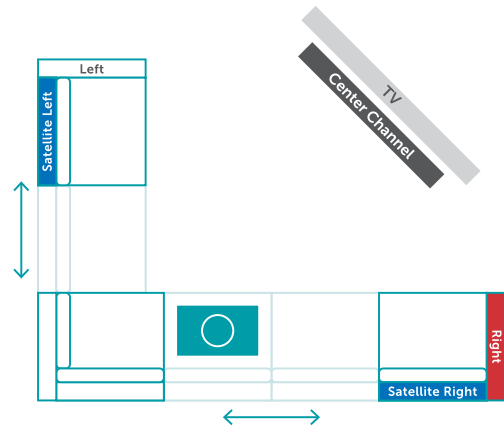

**8 Speaker Immersive Sound + Charge System - incorporates 2 Satellite Sides**

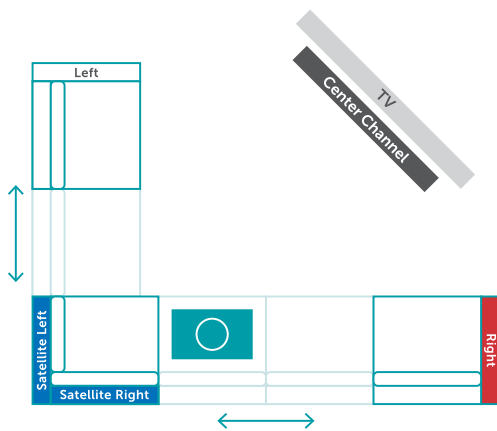

**Optimal Experience: 10 Speaker Immersive Sound + Charge System - incorporates 4 Satellite Sides**

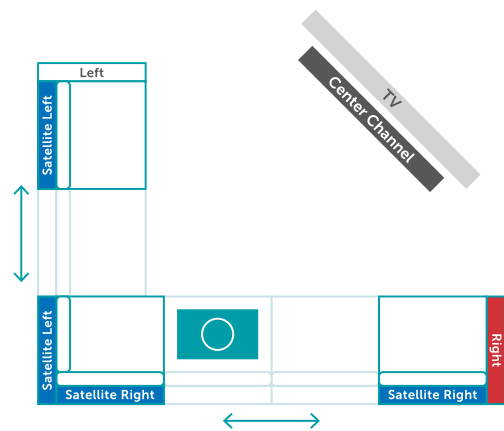

# Planning Your Layout

Choose the configuration shape that most closely matches your setup.

## U Configurations

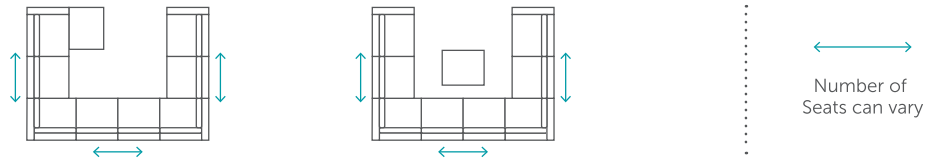

### 6 Speaker Immersive Sound + Charge System

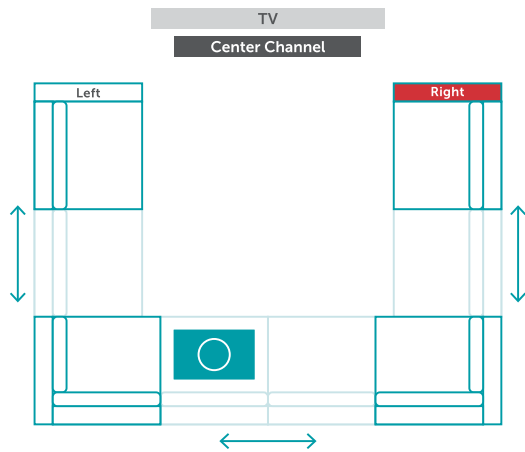

### 8 Speaker Immersive Sound + Charge System - incorporates 2 Satellite Sides

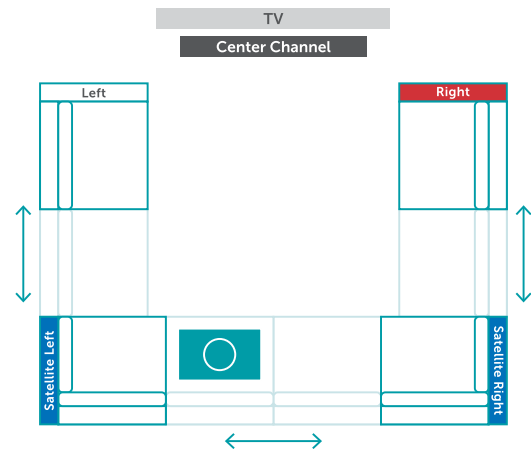

### Optimal Experience: 10 Speaker Immersive Sound + Charge System - incorporates 4 Satellite Sides

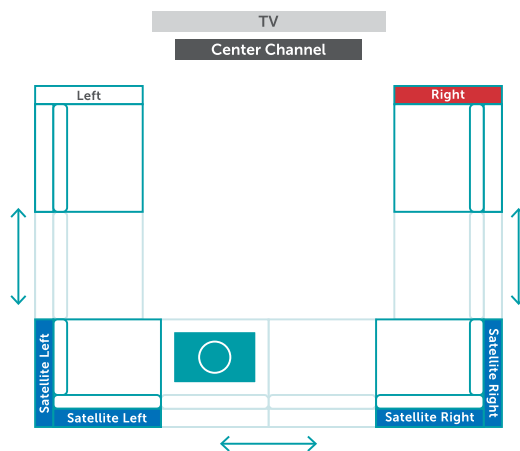

\*If you often watch TV/Movies from rear seats, consider using an optional setup found on page 15.

# Planning Your Layout

Choose the configuration shape that most closely matches your setup.

## M Lounger Configuration

**6 Speaker** Immersive Sound + Charge System

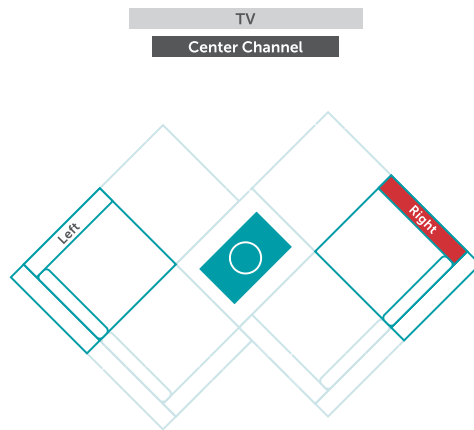

**Optimal Experience: 8 Speaker** Immersive Sound + Charge System - incorporates 2 Satellite Sides

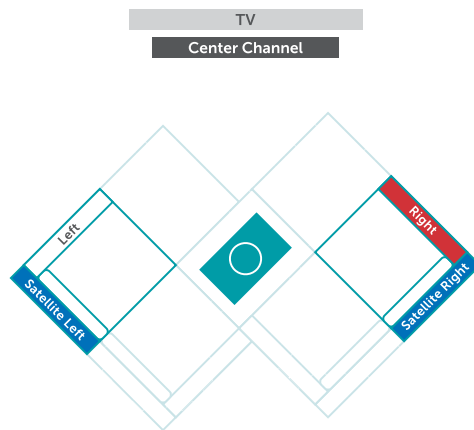

# Planning Your Layout

## Optional Setup for L & U Shapes

- If you often watch TV/Movies from the rear Seats, see setup options below.
- In the app, you must select "Straight Configuration".

### L & U Configurations: Sound + Charge System Setup on Rear Seats

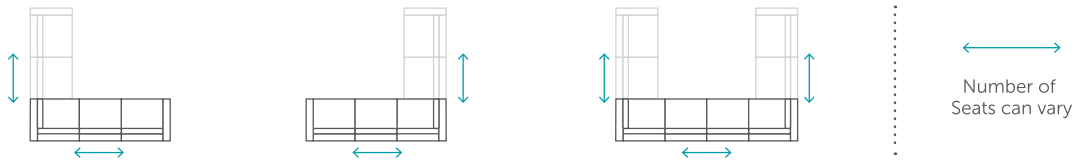

#### 6 Speaker Immersive Sound + Charge System

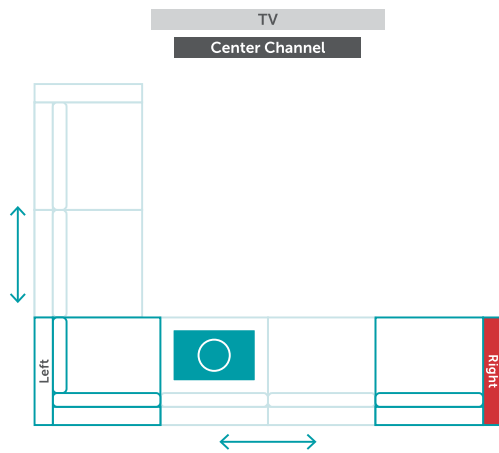

#### Optimal Experience: 8 Speaker Immersive Sound + Charge System - incorporates 2 Satellite Sides

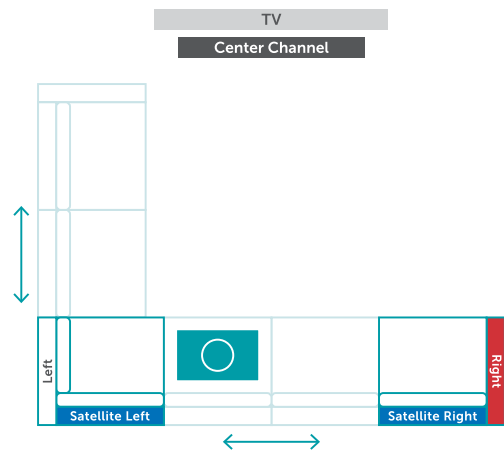

#### 6 Speaker Immersive Sound + Charge System

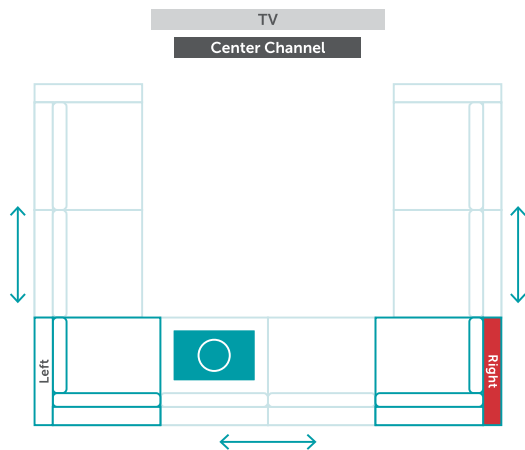

#### Optimal Experience: 8 Speaker Immersive Sound + Charge System - incorporates 2 Satellite Sides

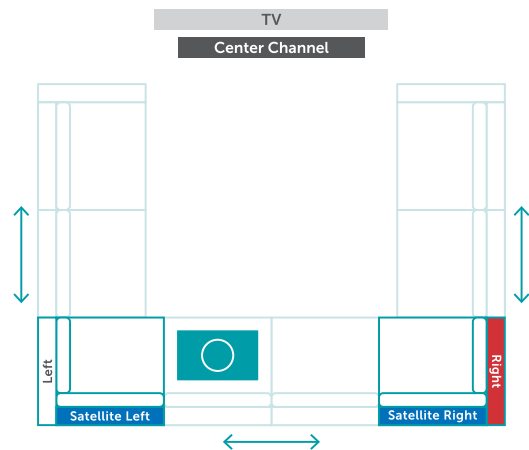

# Installation

## Step 1 Unbox and Cover Sactionals Pieces

\*Note: For assembly videos visit: [youtube.com/LovesacHQ](https://youtube.com/LovesacHQ)  or scan this QR code:



### 1.1 Unbox

- Carefully unbox Sactionals Inserts, Covers, and all StealthTech products.
- Remove Cushions, Back Pillows, and Hardware from Inserts.

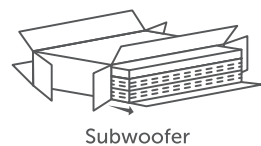

Subwoofer

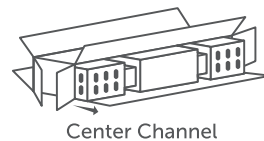

Center Channel

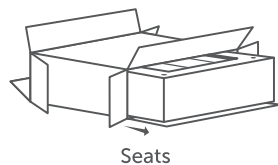

Seats

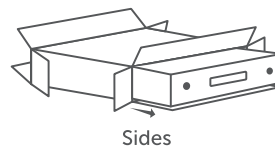

Sides

### 1.2 Review labels and markings

- Take note of your Cover fabric type and color, which will be used later when creating your tuning profile in the Lovesac StealthTech App. This information can be found on your packing slip or on the label located inside your Covers (2021 Covers or newer).
- Note Right and Left Sound + Charge Sides are labeled "R" and "L", and Satellite Sides are labeled "S" for easy identification.
- Note position of Integrated Wireless Charger so that, after covering your Sides, you can place your phone correctly.

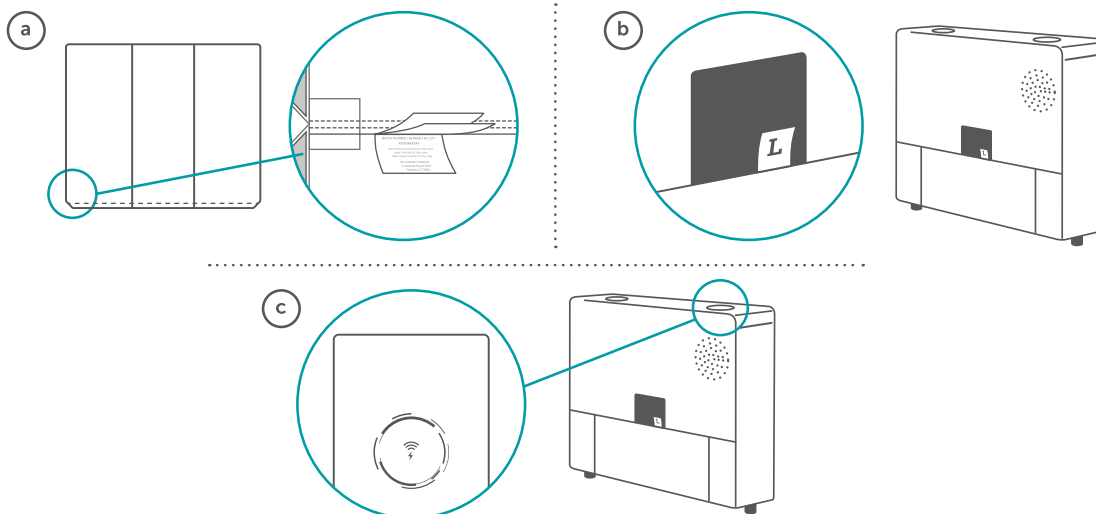



# Installation

## Step 2 Cover Inserts and Recycle Cardboard Boxes

### 2.1 Cover Inserts and Install Feet

a. Cover all Sactionals Inserts, including Sound + Charge Sides and any Satellite Sides.

*\*Notes:*

- *StealthTech Sides use Standard Sactionals Covers.*
- *More detailed covering instructions are available on Sactionals Insert box flaps.*
- *Do not install Feet on Seat Frame that the Subwoofer will be installed into.*

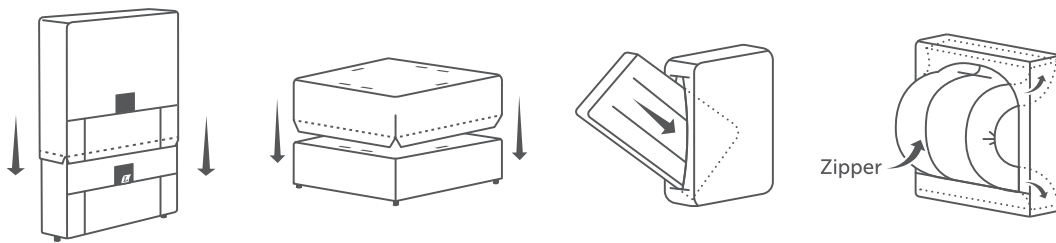

Make piles of similar objects for easier setup.

### 2.2 Recycle Cardboard Boxes

a. Flatten cardboard boxes for future use or please recycle them.

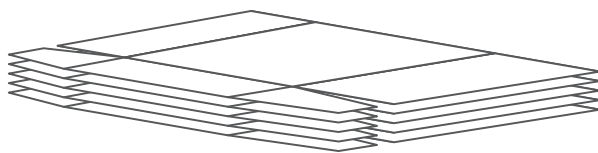

# Installation

## Step 3 Install Sound + Charge Center Channel

### 3.1 TV Stand Placement

- a. Place Center Channel on its rubber feet on a stable and level surface below your TV.

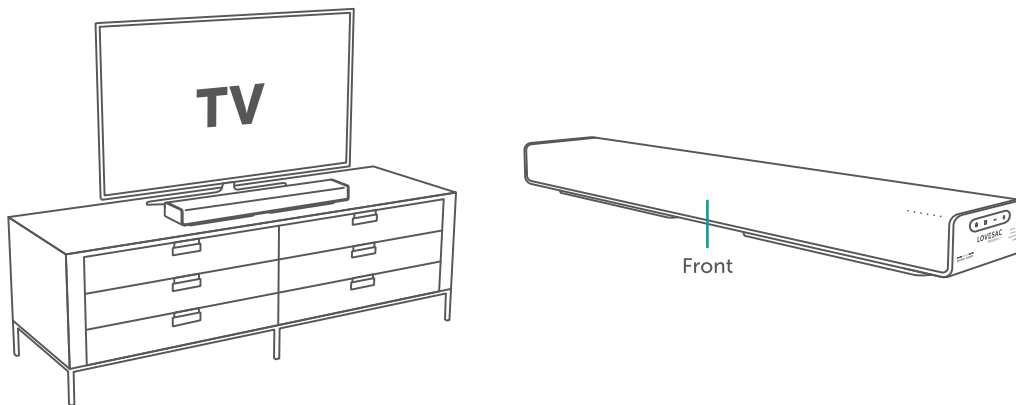

### 3.2 Wall-Mount Option: Mark Screw Placement

*\*Note: Mounting your Center Channel can be done at any time.*

- a. Using a level, tape the wall-mount paper guide to the wall centered below the TV.
- b. Mark screw locations.
  - Stud mounted (**Recommended**):
    1. Use a stud finder to determine if the wall-mount bracket can be stud mounted.
    2. Using the template, identify the 2 top row slots that align with the studs. Mark the screw locations through the paper onto the wall.
  - Drywall mounted:
    1. Mark screw locations for the 4 outer slots through the paper onto the wall.
- c. Remove paper guide.

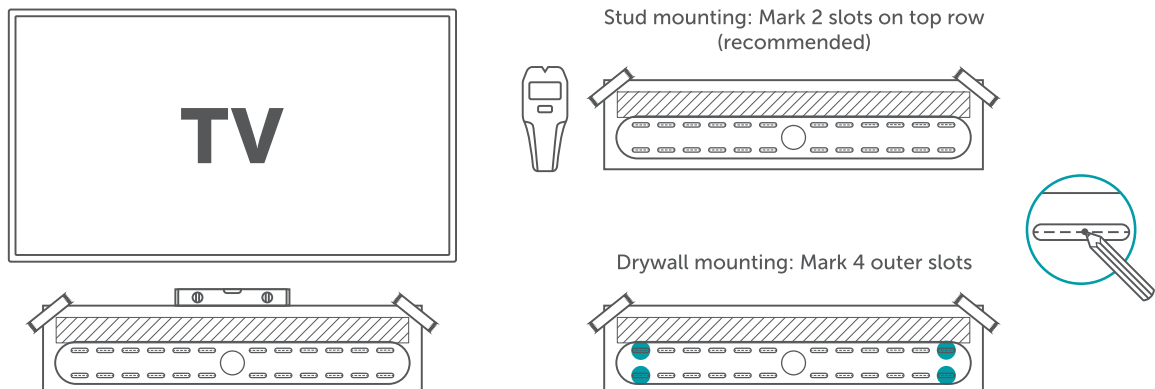

# Installation

## Step 3 Install Sound + Charge Center Channel (Continued)

### 3.3 Wall-Mount Option: Attach Bracket

- Remove and discard both foam protectors from Center Channel Wall-Mount Bracket posts.
- Attach Center Channel Wall-Mount Bracket:
  - Stud mounted:
    - Attach bracket using a drill and included bit with the 2 longer stud screws.
  - Drywall mounted:
    - Insert 4 drywall anchors with a drill.
    - Attach bracket by inserting the 4 shorter drywall screws into the anchors.

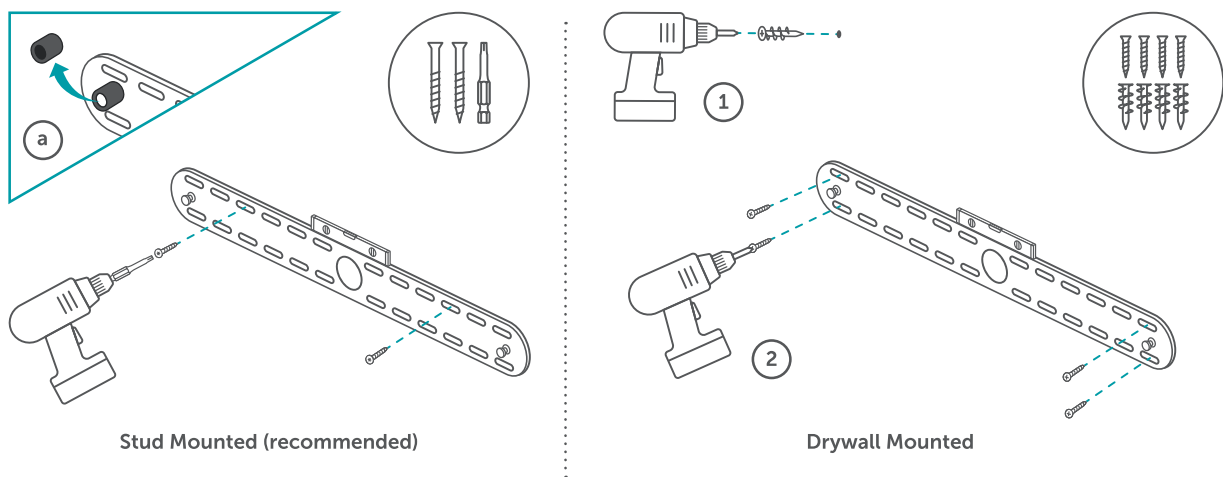

### 3.4 Wall-Mount Option: Mount Center Channel

- Push Center Channel onto Center Channel bracket with keyholes aligned to posts.
- Firmly press down to lock in place.

**! Caution: Ensure keyholes are oriented as shown to prevent Center Channel from falling.**

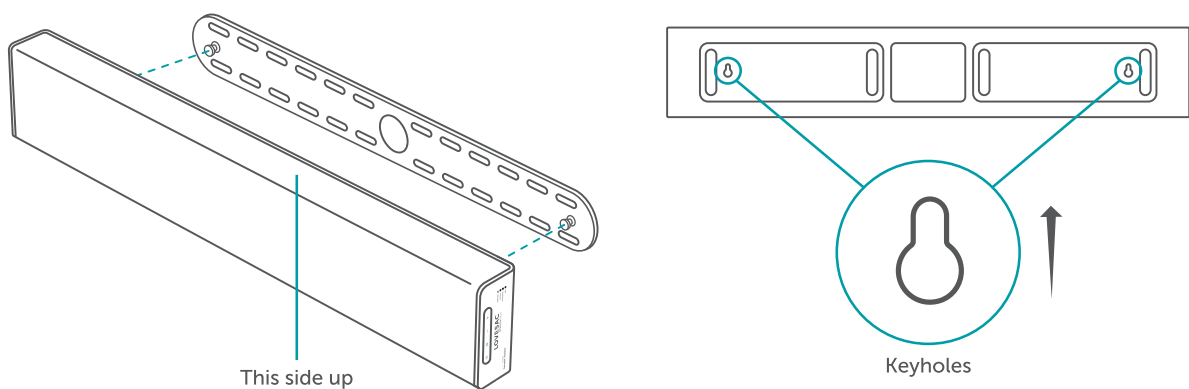

# Installation

## Step 4 Connect Sound + Charge Center Channel to TV

*\*Note: Some TVs require settings changes to be compatible with external speakers. Consult your TV manual.*

### 4.1 Input Connection Option 1: HDMI ARC

- a. Connect included HDMI cable to **HDMI ARC** ports on your Center Channel and TV. If HDMI ARC port is not labeled, consult your TV manual.

*\*Note: With newer TV models, you must turn eARC off in your TV settings.*

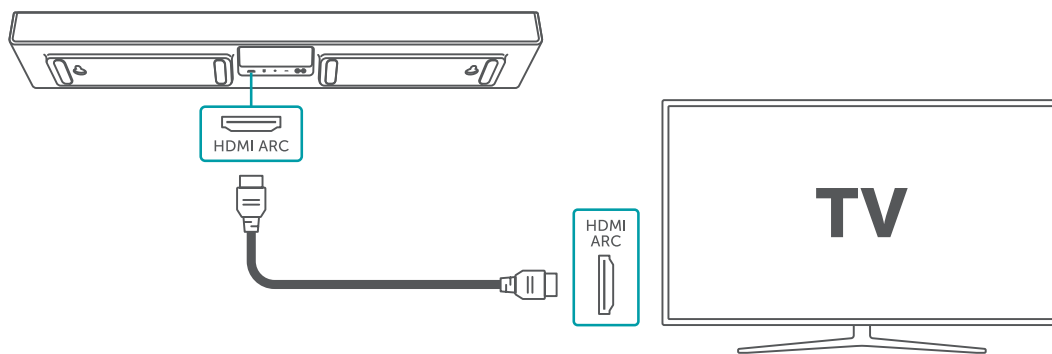

### 4.2 Input Connection Option 2: Optical

- a. Connect included Optical cable to **Optical** ports on your Center Channel and TV.

*\*Note: It is recommended that you turn the TV speakers off in your TV settings. Also, the TV remote will not change your system volume when using Optical.*

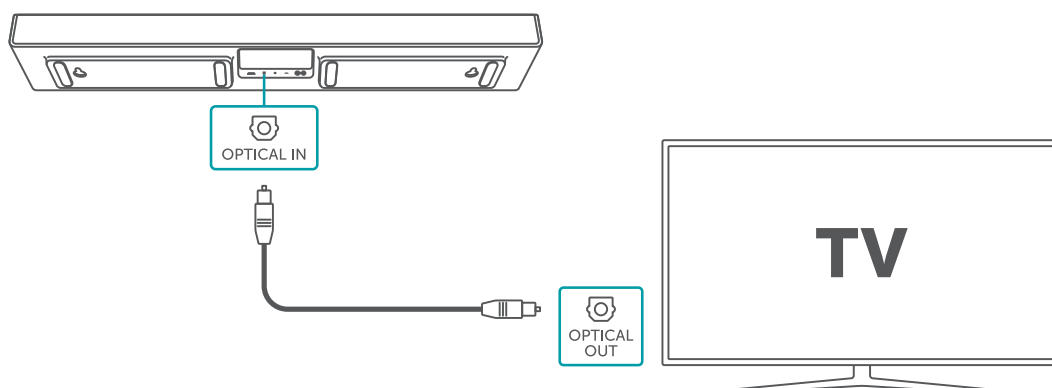

# Installation

## Step 5 Power Sound + Charge Center Channel On

### 5.1 Plug In

- a. Plug Center Channel power cord into an outlet.

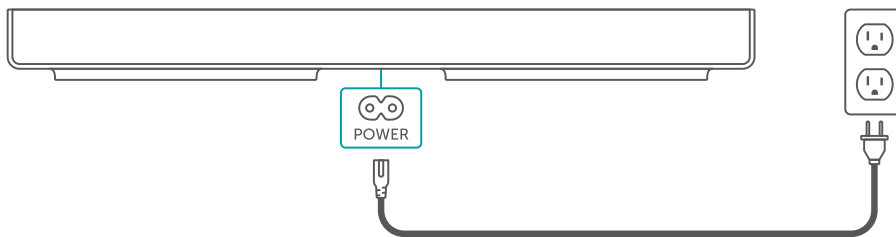

### 5.2 Power On and Select Input

- a. If Center Channel is off, press **Power** button.
- b. Select input by pressing the **Input** button on the Center Channel.

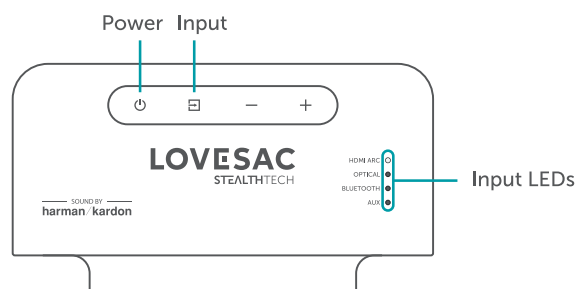

### 5.3 Pair Remote Control

- a. With Center Channel on, simultaneously hold down the **Volume +** and **-** buttons on the Remote Control for more than 5 seconds.
  - Red LED on Remote Control will blink for two seconds, then turn off.
- b. Change volume with Remote Control to verify successful pairing.

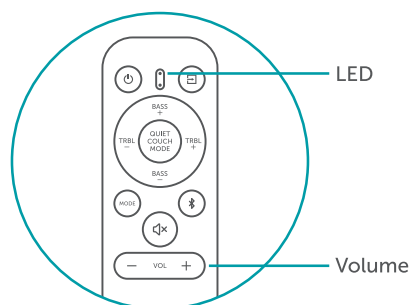

# Installation

## Step 6 Mount Sound + Charge Subwoofer(s)

*\*Note: These steps can also be used to setup any Satellite Subwoofers you may have purchased.*

### 6.1 Attach Brackets

- With speaker facing up, align brackets as shown below.
- Use included thumb screws to secure brackets.

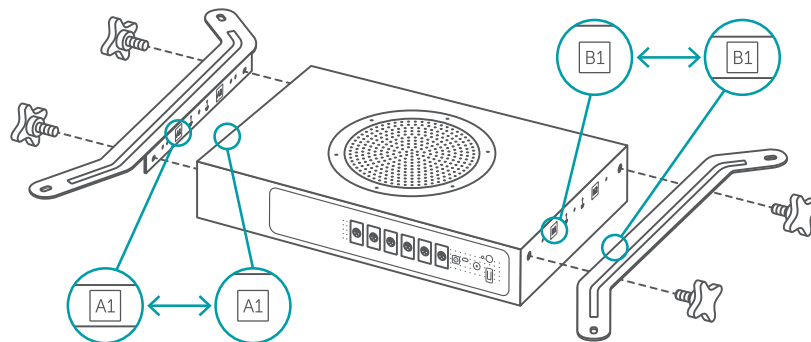

### 6.2 Mount Subwoofer to Seat Frame

- Place Seat Frame upside down.
- With speaker facing up, align Subwoofer Mounting Brackets with Feet holes.
  - Subwoofer speaker will face the floor once fully installed into your configuration.
- Install 4 Feet through the mounting bracket holes.

*\*Note: Subwoofers are not intended to be installed in Sactionals Storage Seats.*

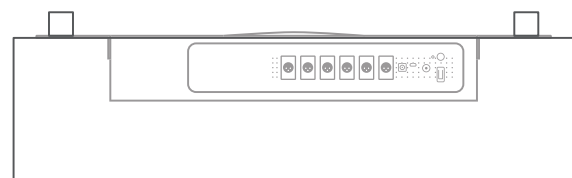
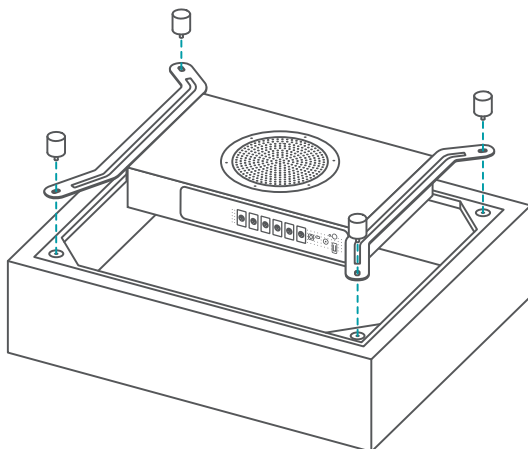

Front View After Subwoofer is Installed



Partially thread all four Feet before fully tightening them down. Do not over tighten.

# Installation

## Step 7 Connect Audio and Power Cables to Subwoofer(s)

*\*Note: Left/Right positions are determined when seated on your Sectionals facing the TV.*

### 7.1 Connect Audio Cables and Power Cord

- Connect both **R** and **L** Sound + Charge Side Audio Cables to the Subwoofer.
- If purchased, connect Satellite Side Audio Cable(s) to the **S(LEFT)** or **S(RIGHT)** ports.
- Connect AC cord to power adaptor, then insert power cord into Subwoofer.

*\*Note: Large setups may require one or more 25ft Audio Cables. See page 7.*

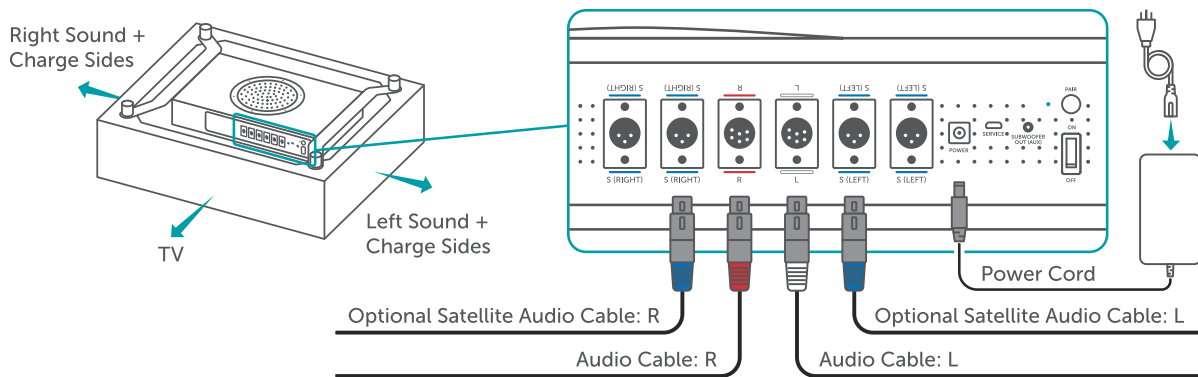

### 7.2 Optional: Connect Satellite Subwoofer Audio Cable and Power Cord

- If purchased, connect provided Auxiliary Cable to "Out" on one Subwoofer and to "In" on the next Satellite Subwoofer.
- Connect AC cord to power adaptor, then insert power cord into Satellite Subwoofer.

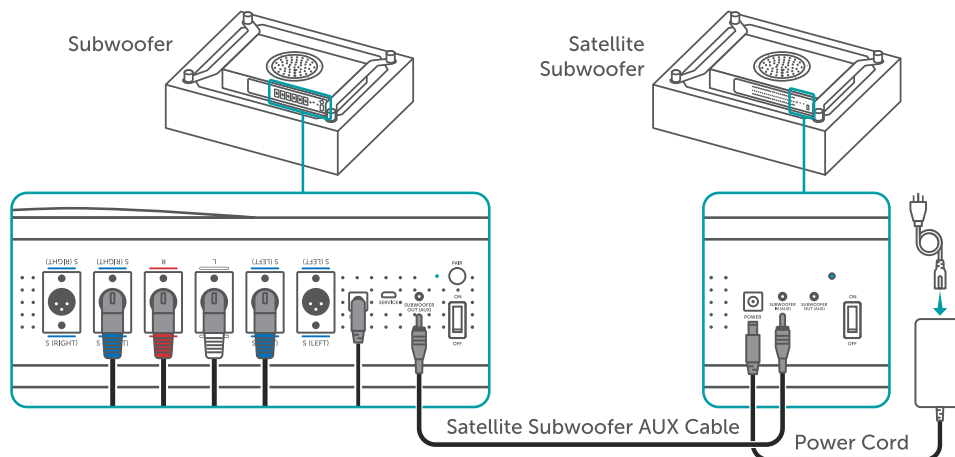

# Installation

## Step 8 Lay Out Cables and Turn On Subwoofer(s)

### 8.1 Lay Out Cables

- a. Lay all right cables towards the right end of your setup, and all left cables towards the left end.

**! Caution:** Ensure cables are routed so they are not pinched by Shoes.

#### Standard Seat Configuration

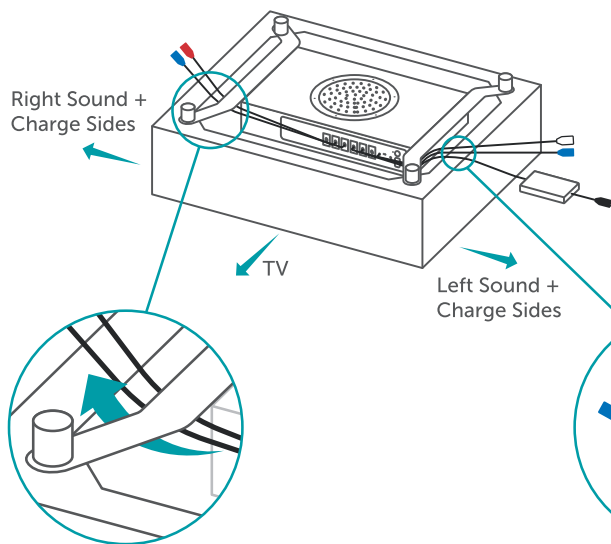

**PRO TIP** Route cables under brackets to keep off the floor.

#### Deep Seat Configuration

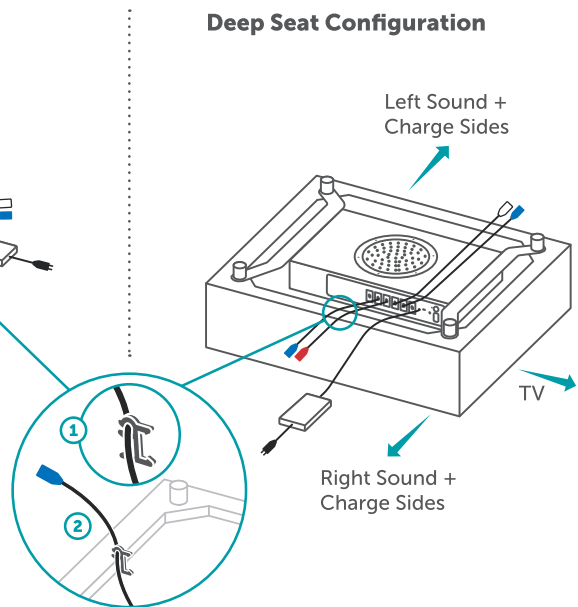

**PRO TIP** Cord clips may be used to secure cables to Seat Frames.

### 8.2 Plug In & Turn On

- a. Plug power cord of Sound + Charge Subwoofer and any Satellite Subwoofer(s) into an outlet.  
b. Switch Subwoofer(s) **Power** button to On.  
c. Subwoofer enters pairing mode when the LED begins to flash.

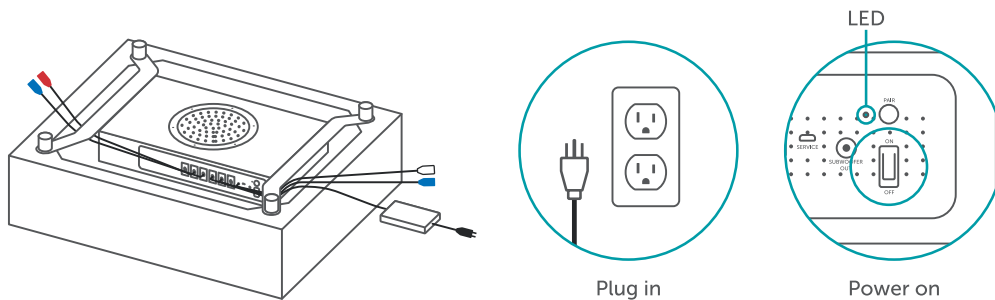



# Installation

## Step 9 Pair Subwoofer and Flip Over

### 9.1 Pair Sound + Charge Subwoofer and Center Channel

- a. With the Center Channel powered on, hold the **Input** and **+** buttons simultaneously for 3 seconds to enable pairing. Release buttons when the Center Channel front LED starts to flash.
- b. A “water-drop” tone will play and Subwoofer LED will turn off when pairing is successful.

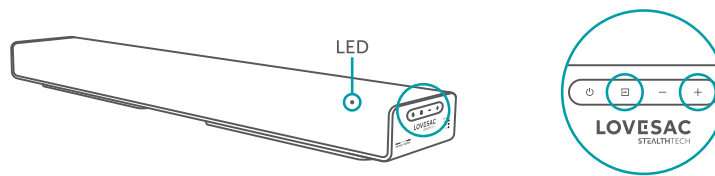

### 9.2 Flip Seat Frame Over

- a. Flip over Seat Frame(s) with Subwoofer(s) installed.

#### Standard Seat Configuration

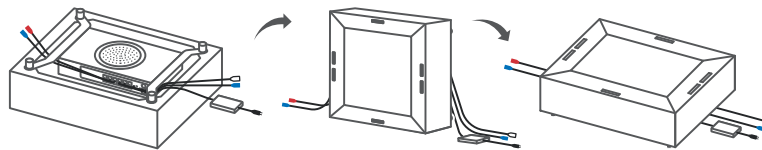

#### Deep Seat Configuration

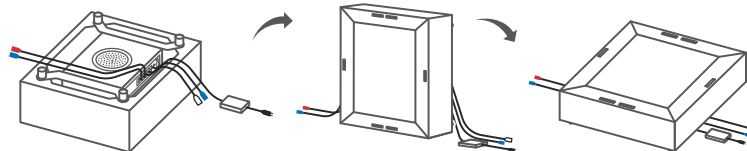

### 9.3 Lay Down Shoes

- a. Lay down Shoes to know where to lay out cables.

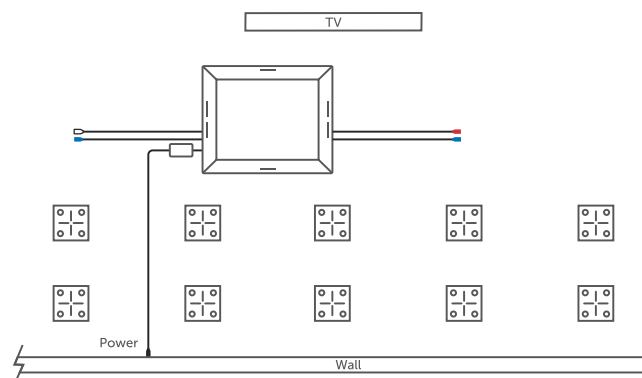

# Installation

## Step 10 Lay Out Cables & Place Subwoofer Seat

### 10.1 Place Seat Frame

- Place your Seat Frame with Subwoofer into 4 Shoes.
- Leave Shoes sticking out to connect other Seats or Sides.
- Straighten Shoes using alignment marks.

**! Caution: Ensure cables are routed so they are not pinched by Shoes.**

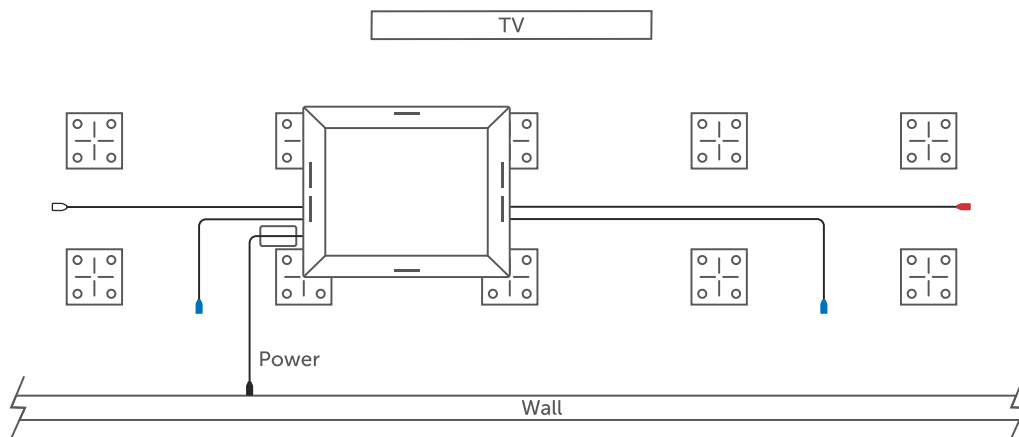

### 10.2 Add Seat Frames

- Place the rest of your Sactionals Seat Frames into Shoes.
- Ensure cable ends reach past all Seats.

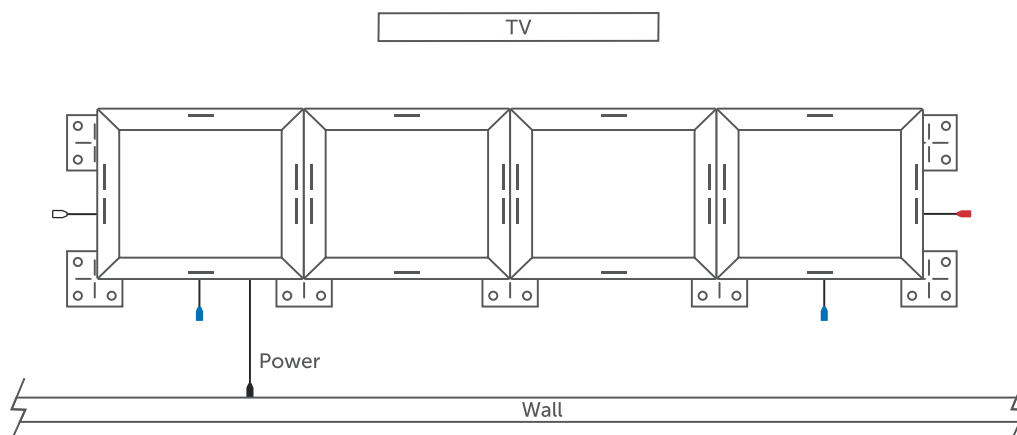

# Installation

## Step 11 Place Sides & Connect Audio Cables

### 11.1 Lay out all Sides

- Place all Sides near their final location.

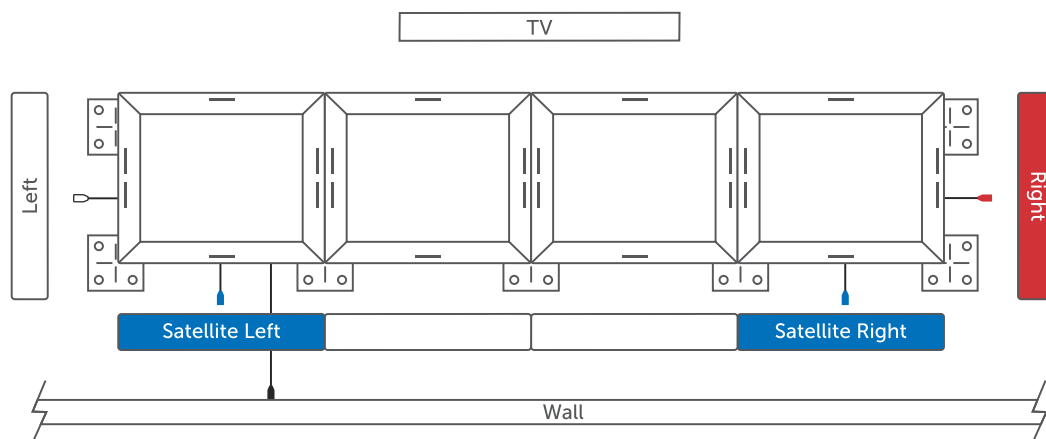

### 11.2 Connect Audio Cables

- Rotate Sound + Charge and Satellite Sides to plug in audio cables.
- Make sure cables "click" into the ports.

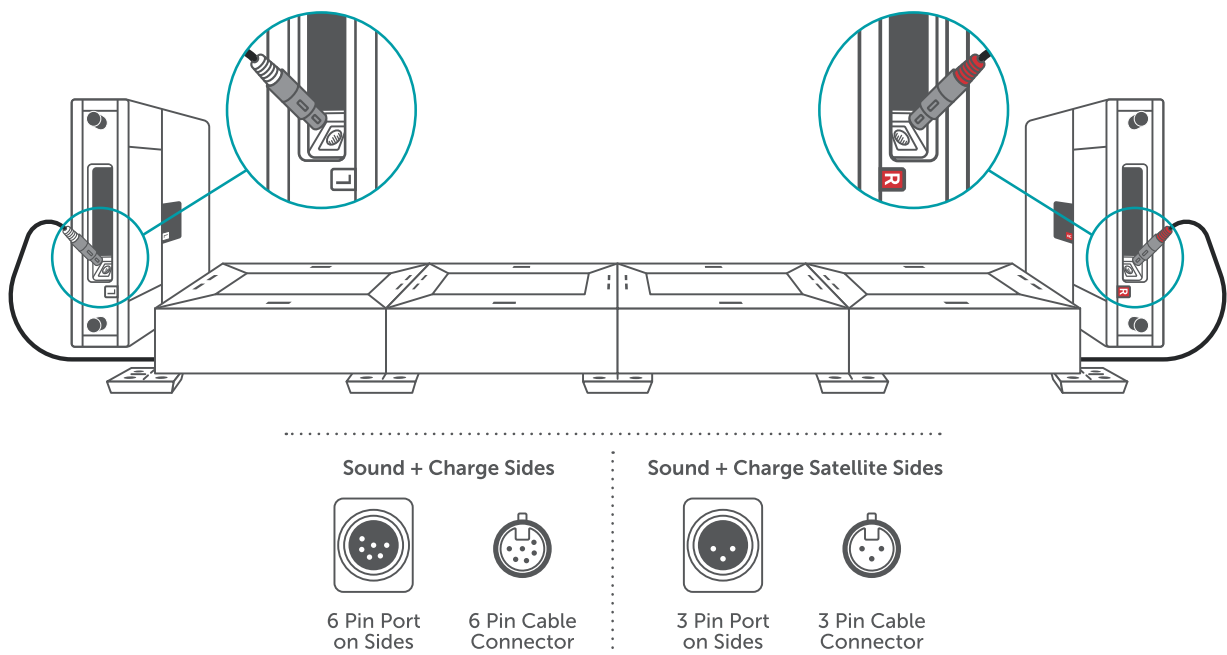

# Installation

## Step 12 Install Sides and Finish Sactionals Setup

### 12.1 Add Sides and Clamps

- Place all Sides in Shoes.
- Use included steel Clamps to attach all Sides to Seat Frames.

**! Caution: Ensure cables are routed so they are not pinched by Shoes.**

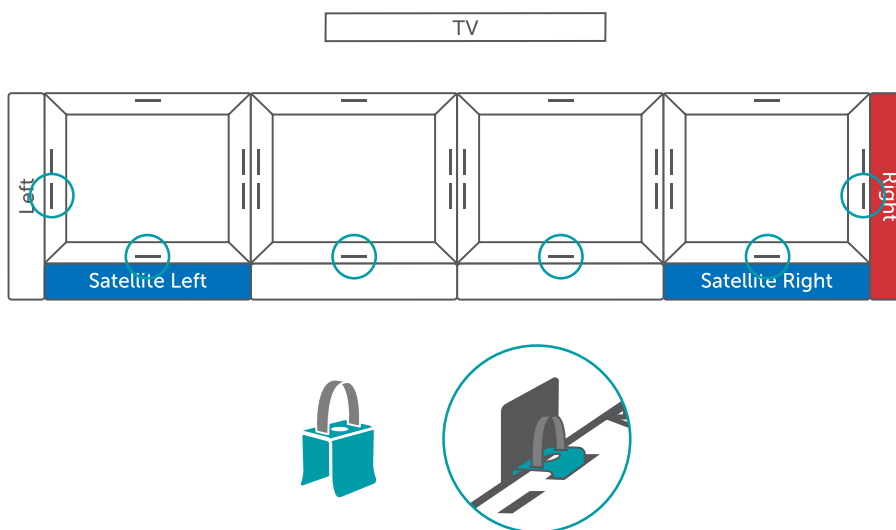

### 12.2 Add Cushions and Pillows

- Add all of your Seat Cushions and Back Pillows.

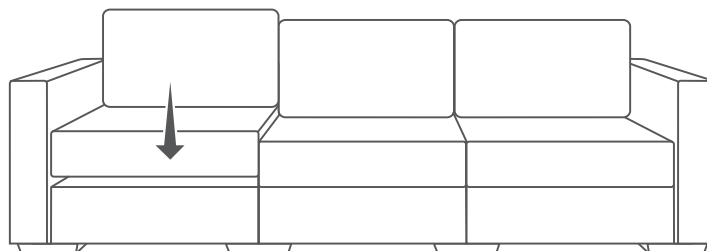

# Installation

## Step 13 Pair a Bluetooth Device

### 13.1 Pair a Bluetooth Device

- a. Ensure Center Channel is on.
- b. Initiate Bluetooth pairing.
  - Option 1: Center Channel
    1. Press **Input** button until Bluetooth is selected.
    2. Hold **Input** button for 3 seconds to initiate Bluetooth pairing process.
  - Option 2: Remote Control
    1. Press and hold **Bluetooth** button for 3 seconds to initiate Bluetooth pairing process.
- c. Center Channel enters pairing mode when front LEDs begin to flash.
- d. Connect to Center Channel.
  1. Open the Bluetooth settings on your smart device and select "**StealthTech**" to connect.  
Play music through your favorite music service.

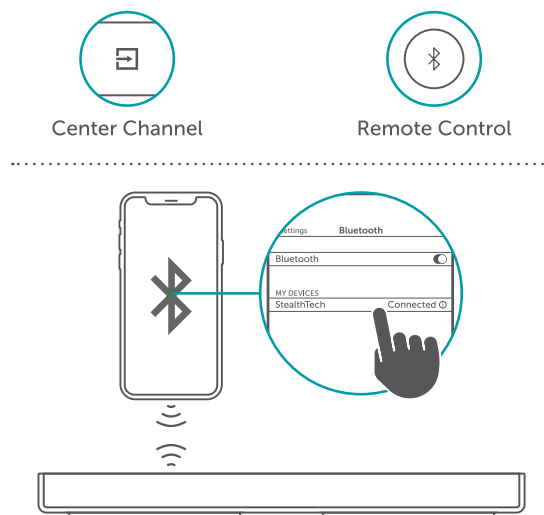

*\*Note: Performing operations in Step 13.1b will disconnect any connected device and put the Center Channel into pairing mode for another device to be connected.*

# Installation

## Step 14 Download the Lovesac StealthTech App

### 14.1 Download the Lovesac StealthTech App

- a. Download the “**Lovesac StealthTech**” App from the Apple App Store or Google Play Store.
  - Requires Android Version 10 or newer, or Apple iOS 13 or newer.
- b. Ensure Center Channel and Subwoofer are powered on.
- c. Follow the in-app instructions to finish setting up your custom tuning profile based on your configuration shape and fabric type.

#### Additional App Features:

- Toggle between Harman Kardon defined presets (see page 31).
- Create and save custom presets (see page 31).
- Adjust treble, bass, speaker balance, center channel volume, and system volume.

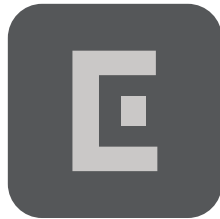

Scan this QR code to download the Lovesac StealthTech App.

#### \*Notes:

- *The app can be downloaded to multiple devices, but only one can have the app open and actively control the System at a time.*
- *Separate Bluetooth connections are required to use the app and to stream music from your device. The app automatically connects to the System when the app is open. To stream music from your device, follow the Bluetooth pairing process on page 29.*

# Getting to Know Your System

## Audio Presets

### Harman Kardon Presets

Each preset provides a unique listening experience by changing the volumes of various speakers throughout the room.

#### 1. Movie: All speakers full volume

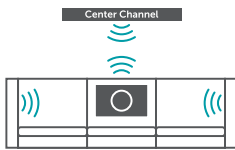

**5.1 Surround** content plays through intended speakers.

**Stereo** content is passed through Dolby ProLogic II to create a simulated 5.1 surround experience.

#### LED Behavior Key



Movie



#### 2. Music: Center Channel volume reduced

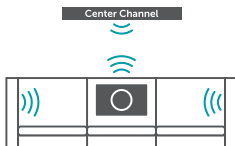

**5.1 Surround** content plays through intended speakers.

**Stereo** content plays through the couch in stereo and mixed to the Center Channel.

Music



#### 3. TV: Couch speakers volume reduced

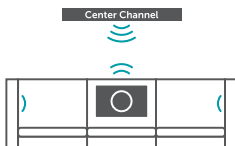

**5.1 Surround** content plays through intended speakers.

**Stereo** content plays through the couch in stereo and mixed to the Center Channel.

TV



#### 4. News: Couch speakers off, Subwoofer volume reduced

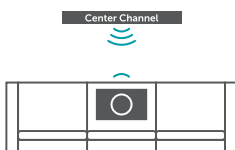

**5.1 Surround** content not recommended for this preset.

**Stereo** content is mixed to the Center Channel.

News



### Custom Audio Presets (In App only)

Use the app to create and save up to 5 custom presets. Choose the Harman Kardon preset that has the desired signal processing (as described above). You can then customize system volume, speaker balance, bass, treble, and center volume.

### Quiet Couch Mode

This audio filter can be temporarily added to any active preset. The couch speakers volume and loud audio peaks are reduced.

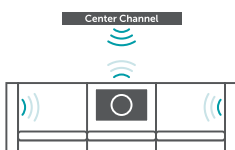

Movie preset with Quiet Couch Mode enabled

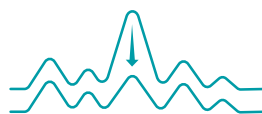

Audio peaks are reduced

All LEDs flash on at half brightness when engaged, and turn off after 3 seconds.



All LEDs flash on at full brightness when disengaged.



# Getting to Know Your System

## Connect Sound + Charge Center Channel to Other Devices

### 1 Streaming Device or Gaming Console

Connect the audio from your streaming box, gaming console, DVD player, or Blu-Ray player directly to your Center Channel via an Optical cable.

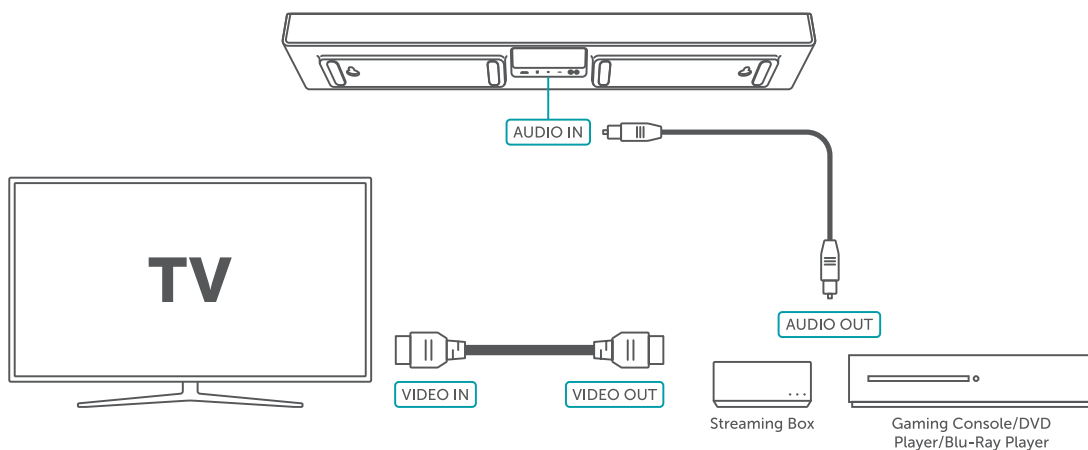

### 2 Analog (AUX)

Connect to devices such as a laptop, tablet, or smartphone with a 3.5mm Auxiliary (Aux) cable.

*\*Note: AUX cable does not support a 5.1 signal.*

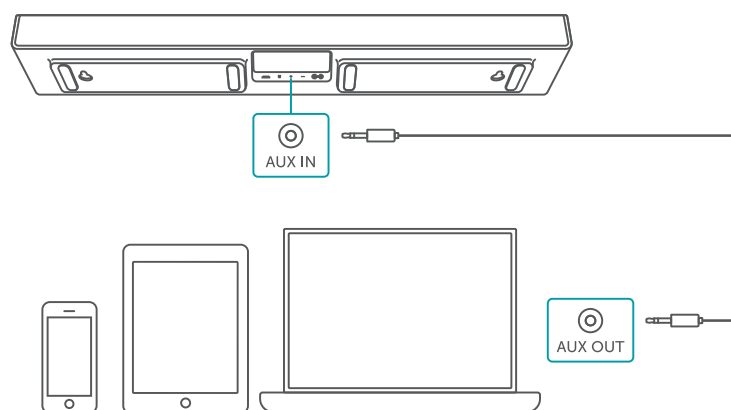



# Getting to Know Your System

## Product Overview

### Sound

Sound Sides feature two embedded speakers, all hidden from view. The large embedded speaker that faces inward on the Side provides right and left audio respectively, and the embedded upfiring speaker on top of the Side provides rear audio for an immersive surround sound experience.

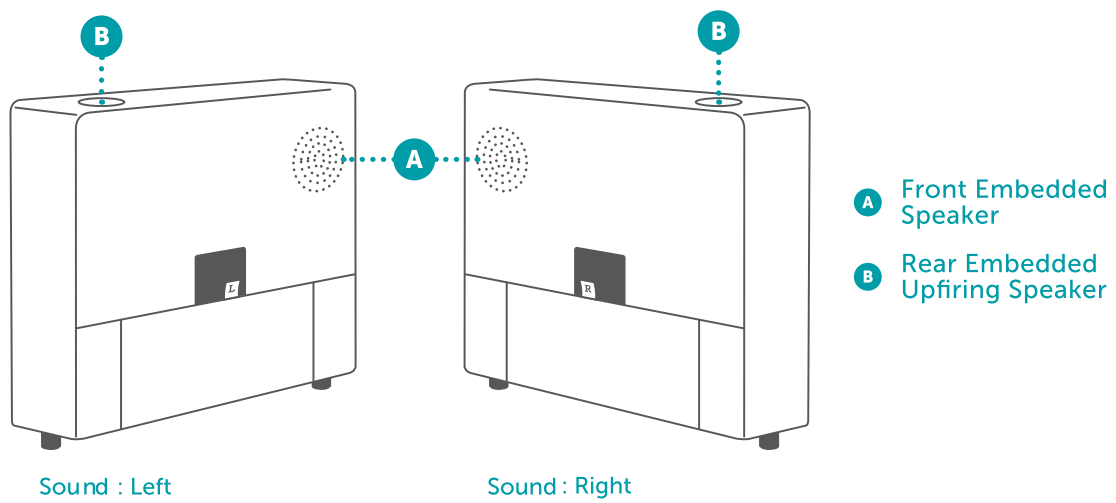

# Getting to Know Your System

## Product Overview

### Sound + Charge Center Channel

The Sound + Charge Center Channel decodes the incoming audio signal then transmits that signal to the Sound + Charge Subwoofer. It also acts as the Center Channel speaker with 4 mid range speakers, 1 tweeter, and 2 mini subwoofers. The Center Channel automatically switches to standby after 10 minutes of inactivity. The Center Channel can power on automatically with either HDMI ARC or Bluetooth inputs, *if* the respective input was active when the Center Channel was powered off.

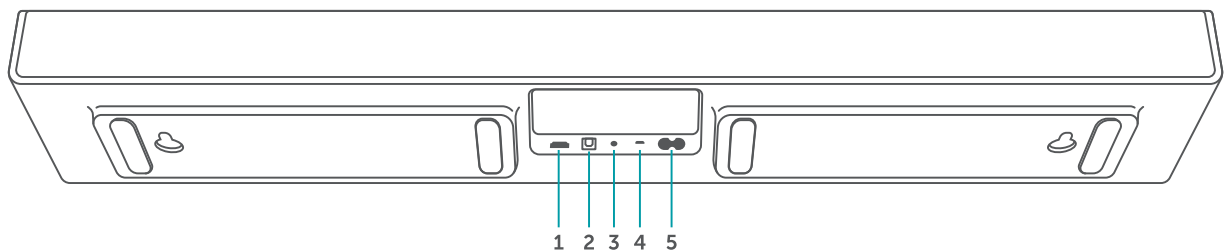
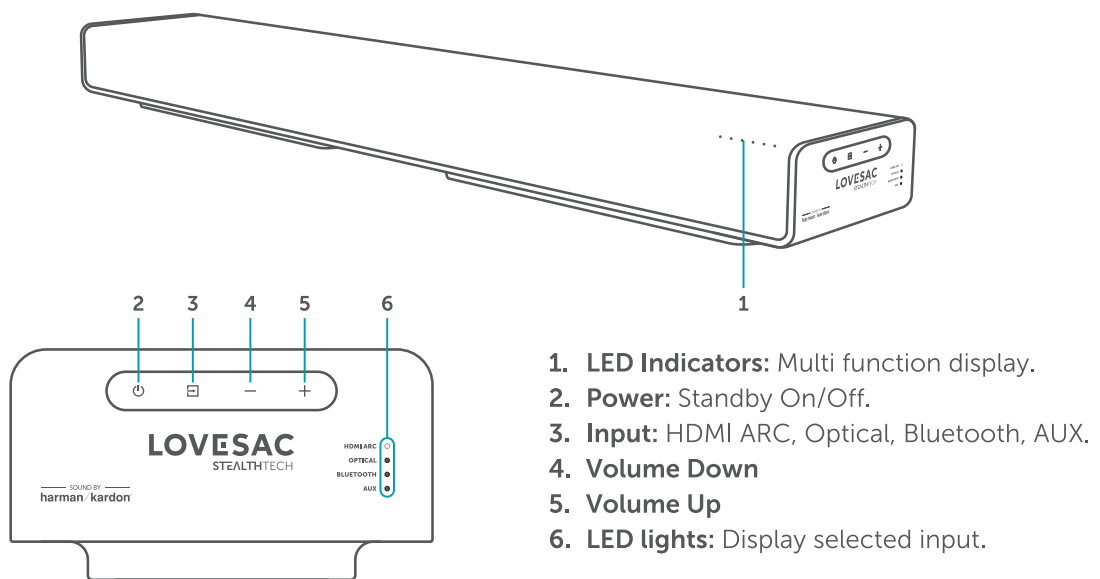

- 1. HDMI ARC:** Connect to the HDMI ARC port on your TV.
- 2. Optical In:** Connect to an optical audio output on your TV or digital device.
- 3. AUX In:** Connect to an audio device (3.5 mm cable).
- 4. Factory USB port:** For factory service only.
- 5. Power:** Connect to the power supply.

# Getting to Know Your System

## Product Overview

### Sound + Charge Remote Control

The Remote Control includes quick access to many features of your Sound + Charge System. For more advanced controls, use the Lovesac StealthTech app.

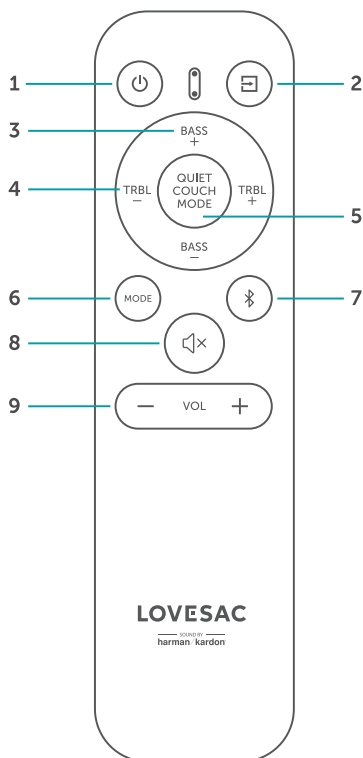

1. **Power**
2. **Input:** HDMI ARC, Optical, Bluetooth, AUX.
3. **Bass:** Increase or decrease subwoofer volume.
4. **Treble:** Increase or decrease treble level.
5. **Quiet Couch Mode:** See description on page 31.
6. **Mode:** Toggle between Harman Kardon defined Preset Tuning Profiles: Movie, Music, TV, News (For preset descriptions, see page 31).
7. **Bluetooth Input:** Select Bluetooth input. Long press to begin Bluetooth pairing.
8. **Mute**
9. **Volume**

### Remote Control Pairing

If the Remote Control is paired, the LED will flash one time for every button press. If the LED flashes for 5 seconds after pressing one button, it is not paired.

#### How to re-pair Remote Control

1. Ensure Center Channel is on.
2. On the Remote Control, hold down **Volume +** and **-** simultaneously for more than 5 seconds.
  - The red LED on the Remote Control will blink for two seconds, then turn off.
3. Change volume with Remote Control to verify successful pairing.

# Getting to Know Your System

## Product Overview

### Sound + Charge Subwoofer

The Subwoofer receives the signal from the Center Channel, amplifies the signal and sends it to the Sound + Charge Sides and Satellite Sides (Optional). The Subwoofer boasts an 8" driver that delivers powerful bass.

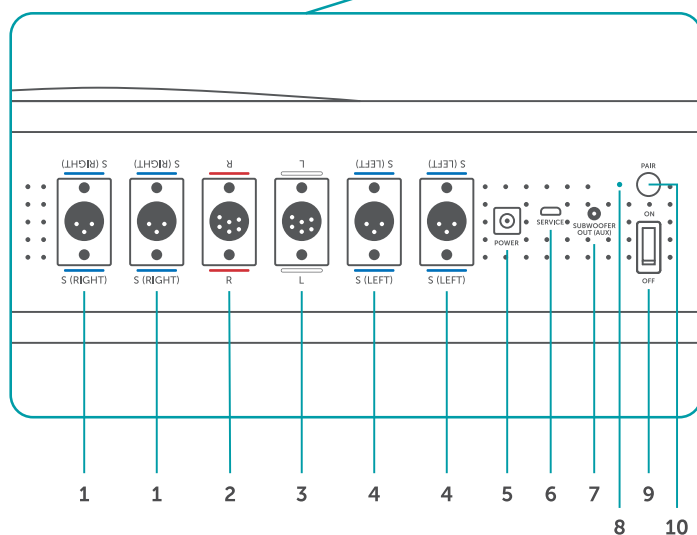
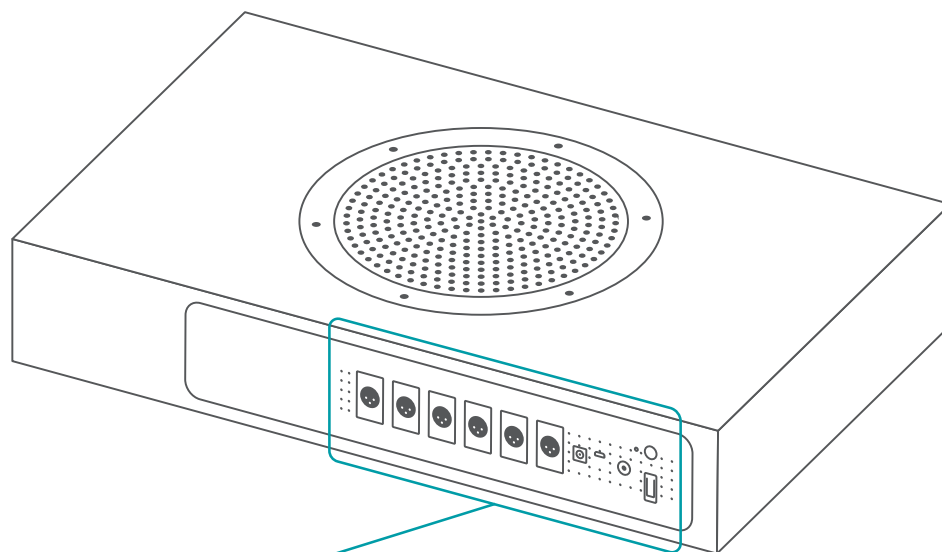

1. 2x Satellite Side (Optional): S (Right)
2. Sound + Charge Side: R
3. Sound + Charge Side: L
4. 2x Satellite Side (Optional): S (Left)
5. Power Cord port
6. Factory USB port
7. AUX out
8. Pairing LED indicator
9. On/Off Switch
10. Pair button

*\*Note: Left and Right positions are determined when seated on your Sectionals facing the TV.*

# Getting to Know Your System

## Product Overview

### Sound + Charge Satellite Side

A Sound + Charge Satellite Side is an optional StealthTech product that enhances your experience by adding more surround sound to your Sound + Charge System. It features an embedded upfiring speaker on the top of the Side, hidden from view. A maximum of four Satellite Sides can be added to your system.

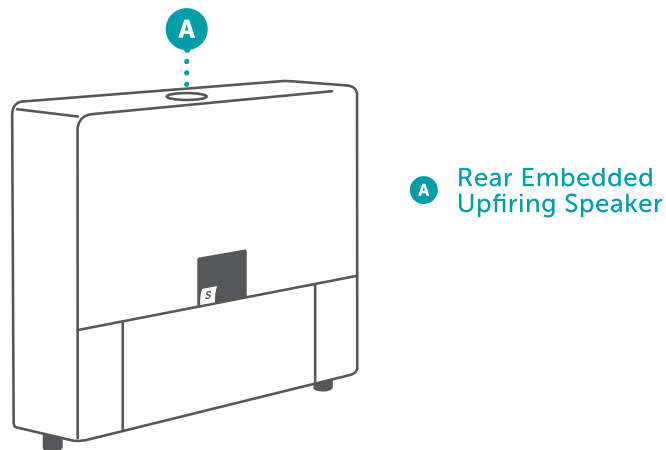

### Sound + Charge Satellite Subwoofer

A Satellite Subwoofer is an optional StealthTech product to enhance your experience by adding more bass to your Sound + Charge System. A maximum of three Satellite Subwoofers can be added.

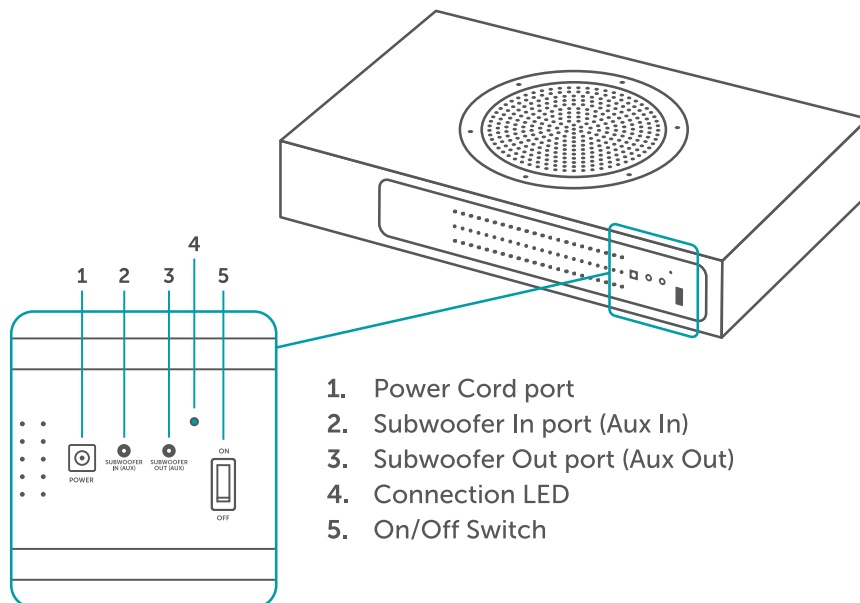







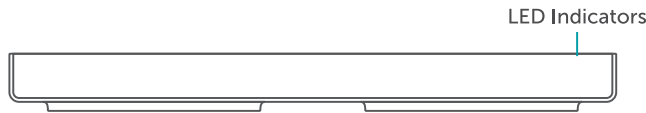













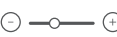





# Getting to Know Your System

## LED Indicators















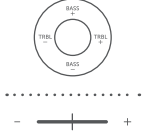





The LED indicators will behave differently with each function.



FUNCTION	LED BEHAVIOR	DESCRIPTION
<b>POWER ON/ WAKE FROM STANDBY</b>  	All LEDs flash once.  	Press the <b>Power</b> button on the Center Channel or remote control.
<b>SELECT INPUT</b>    <hr style="border-top: 1px dashed black;"/>   	<b>HDMI-ARC</b>   <b>Optical</b>   <b>Bluetooth</b>   <b>AUX</b> 	On the Center Channel, press the <b>Input</b> button to change audio input.  On the remote control, press the <b>Input</b> button display the current input and press again to change audio input. Or press the <b>Bluetooth</b> button to directly select the Bluetooth input.  In the app, press the <b>Input</b> button at the top of the dashboard to change audio input.
<b>VOLUME</b>    <hr style="border-top: 1px dashed black;"/> 	Volume increases from left to right       	On the Center Channel and remote control, press the <b>Volume +/-</b> buttons to increase/decrease volume level.  In the app, slide the <b>System Volume</b> slider to increase/decrease volume level.
<b>MUTE</b>  	LEDs used to display current volume will change to half brightness when muted.  Example volume level   Example volume level when muted 	On the remote control and in the app, press the <b>Mute</b> button to mute sound for the entire system. Press again to unmute, or press <b>VOL +/-</b> buttons to unmute.
<b>QUIET COUCH MODE</b>    <hr style="border-top: 1px dashed black;"/> 	All LEDs flash on at half brightness when engaged   All LEDs flash on at full brightness when disengaged. 	On the remote control and in the app, press the <b>Quiet Couch Mode</b> button to engage. Press again to disengage. See page 31 for a description of Quiet Couch Mode.







# Getting to Know Your System

## LED Indicators (Cont.)

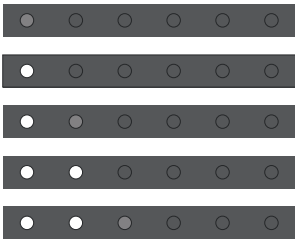
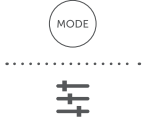
FUNCTION	LED BEHAVIOR	DESCRIPTION
<p><b>BLUETOOTH</b></p> 	<p>Bluetooth Input Selected.</p>  <p><b>Bluetooth Pairing Process:</b></p> <p>1. Pairing: All LEDs flash slow.</p>  <p>2. Connected: All LEDs at full brightness.</p> 	<p><b>Select Bluetooth Input:</b> On the Center Channel, press the <b>Input</b> button until the Bluetooth input is selected.</p> <p>On the remote control and in the app, press the <b>Bluetooth</b> button once to select Bluetooth input.</p> <p><b>Pair to Bluetooth:</b> On the remote control, press and hold the <b>Bluetooth</b> button for 3 seconds to initiate the pairing process.</p> <p>On the Center Channel, press <b>Input</b> button until Bluetooth is selected, Press and hold the <b>Input</b> button for 3 seconds to initiate Bluetooth pairing process.</p>
<p><b>TREBLE/BASS</b></p> 	<p>Level increases from left to right</p>        <p>Treble/Bass at default level</p> 	<p>On the remote control, press <b>Bass+/Bass-</b> and <b>Treble+/Treble-</b> buttons to increase/decrease bass or treble level.</p> <p>In the app, slide <b>Bass+/Bass-</b> and <b>Treble+/Treble-</b> sliders to increase/decrease bass or treble level.</p>
<p><b>SPEAKER BALANCE</b></p> 	<p>3 Levels Right of Center</p>  <p>2 Levels Right of Center</p>  <p>1 Level Right of Center</p>  <p>Speaker and Center Balance is Centered</p>  <p>1 Level Left of Center</p>  <p>2 Levels Left of Center</p>  <p>3 Levels Left of Center</p> 	<p>In the app, slide <b>Speaker Balance</b> slider to move the balance to the left or right.</p>

# Getting to Know Your System

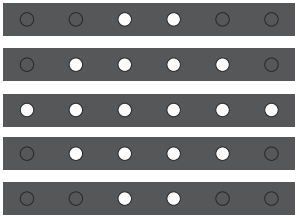
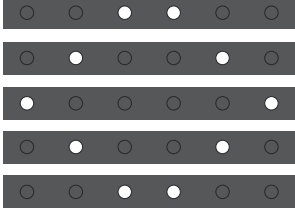
## LED Indicators (Cont.)

FUNCTION	LED BEHAVIOR	DESCRIPTION
<p>CENTER VOLUME</p> 	<p>Volume increases from left to right →</p> 	<p>In the app, slide the <b>Center Volume</b> slider to increase or decrease the Center Channel volume.</p>
<p>PRESETS</p> 	<p>Movie</p>  <p>Music</p>  <p>TV</p>  <p>News</p> 	<p>On the remote control, press the <b>Mode</b> button to display the currently selected preset. Press again to change your audio preset.</p> <p>In the app, press the <b>Presets</b> button at the top of the dashboard to change your audio preset.</p>
<p>DOLBY DIGITAL INDICATOR</p>		<p>When a Dolby Digital signal is detected, this LED sequence will light up, lasting 2 seconds.</p>
<p>DOLBY PRO LOGIC INDICATOR</p>		<p>When Dolby Pro Logic is activated, this LED sequence will light up, lasting 2 seconds.</p>
<p>CENTER CHANNEL PAIRING WITH SUBWOOFER</p>	<p>Pairing Mode</p> 	<p>On the Center Channel, hold down the <b>Source</b> and <b>+</b> buttons for 3 seconds. LED 1 will begin to blink when Center Channel enters pairing mode. Once paired, the LED light turns off and audible tone is played.</p>



# Help & Troubleshooting

If you have any questions about these products, their installation, or their operation, please contact the Lovesac Customer Love Team at 1-888-636-1223 or [customerlove@lovesac.com](mailto:customerlove@lovesac.com). You can also visit [www.lovesac.com](http://www.lovesac.com) for additional resources.

## Troubleshooting

### Issue 1: No sound coming from any speakers

- Ensure Center Channel is powered on.
- Ensure Center Channel power cord is securely connected.
- Plug a different device into the electrical outlet to verify that the outlet is working correctly.
- Ensure mute is off and volume is not set to zero.
- Ensure correct source is selected.
- Ensure source cord is plugged in.
  - If using HDMI ARC, ensure it is connected to the correct HDMI port on the TV.
  - If problem persists, try another source or different audio content.
- Check TV settings for audio output. Sometimes it may be sending audio through optical when you are connected to HDMI or vice versa.
- If using Bluetooth, ensure that the volume on your source device is turned up and that the device is not muted.
- After checking all other options, factory reset system and re-pair (see page 42).

### Issue 2: No sound coming from Center Channel only

- Ensure Center Volume is not turned down all the way.
- If the audio source is 5.1, sometimes the recorded audio does not provide content on all channels.
  - To check this: Try another source or different audio content to see if problem persists.
- After checking all other options, factory reset system and re-pair (see page 42).

### Issue 3: No sound coming from Subwoofer and Sides (couch)

- Ensure Subwoofer is plugged in and powered on.
- Check EQ settings:
  - If Quiet Couch Mode is on and volume set very low, little sound will come from couch.
  - On the News setting, no sound comes from couch speakers and very little comes from the Subwoofer.
- Try another source or different audio content to see if problem persists.
- After checking all other options, factory reset system and re-pair (see page 42).

### Issue 4: No sound coming from Subwoofer (but sound is coming from other couch speakers)

- Check EQ settings:
  - If Quiet Couch Mode is on and volume set very low, little sound will come from Subwoofer.
  - If the News preset is selected and volume set very low, little sound will come from the Subwoofer.
  - If the Bass is turned low and volume set very low, little sound will come from Subwoofer.
- Switch to audio with known bass content.
- After checking all other options, factory reset system and re-pair (see page 42).

### Issue 5: No sound coming from one or more Sides

- Ensure the Side(s) is plugged in (check both ends of each cable).
- Check EQ settings:
  - If Quiet Couch Mode is on and volume set very low, little sound will come from Side(s).
  - If the News preset is selected and volume set very low, little sound will come from Side(s).
- Try another source or different audio content to see if problem persists.
- After checking all other options, factory reset system and re-pair (see page 42).

### Issue 6: Distorted sound, poor audio, or echo in the system

- Check if the TV is playing audio through TV speakers and StealthTech System.
  - Press Mute button on TV.
  - TV settings may require you to select output "speaker".
- For Bluetooth, ensure the device is within connection range.
  - Move the device closer to the Center Channel, or remove any obstacle between the device and the Center Channel.
- Check all cable connections throughout system.
- Try another source or different audio content to see if problem persists.
- After checking all other options, factory reset system and re-pair (see page 42).

### Issue 7: Bluetooth cannot pair or connect to Center Channel

- Check if Center Channel is in Bluetooth pairing mode (see page 29).

# Help & Troubleshooting

- Check if system is connected to another device.
  - Disconnect other device or press and hold Bluetooth button on remote control.
- Ensure the device is within connection range.
  - Move the device closer to the Center Channel, or remove any obstacle between the device and the Center Channel.
- Ensure Bluetooth is enabled on device.
- Try connecting another device to see if problem persists.
- Go to the list of connected Bluetooth devices on your phone, make your phone “forget” StealthTech, and re-pair.
- Unplug Center Channel for 10 seconds and plug back in.
- Note that separate Bluetooth connections are required to use the app and to stream music from your device (see \*Notes on page 30).
- After checking all other options, factory reset system and re-pair (see page 42).

## Issue 8: App not connecting to the system

- Ensure the app is closed on other devices.
- See Issue 7 to verify the phone is properly connected to the system.
- Verify Android or IOS version supports the app. The app requires Android Version 10 or newer, or Apple iOS 13 or newer.

## Issue 9: Remote Control doesn't work

- Ensure batteries are good.
- Ensure the remote is paired to the system.
  - Re-pair the remote (see page 42).

## Issue 10: Integrated Wireless Charger not working

- Ensure the Side is plugged in (check if sound is coming from speakers).
- Ensure the device is positioned correctly over the charging mark.
  - Remove cover to see charging mark and learn positioning.
  - Note that not all phones have charging coils centered in the phone.
- Ensure the phone has wireless charging capabilities.
  - For example, iPhone 7 or older does not.
- After checking all other options, please contact the Lovesac Customer Love Team (see page 5).

## System Reset and Update

### How to perform factory reset of Center Channel

1. Power on Center Channel.
2. Hold down Center Channel + and - buttons simultaneously for 10 seconds.
3. All LEDs turn will turn off, turn on, and turn off.
  - \* Subwoofer and Remote Control will both need to be paired to the Center Channel again (see steps below).

### Pair Subwoofer and Center Channel

1. With the Center Channel and Subwoofer powered on, hold the **Input** and **+** buttons on the Center Channel simultaneously for 3 seconds to enable pairing. Release buttons when the Center Channel front LED starts to flash.
2. A “water-drop” tone will play when pairing is successful. All LEDs will turn off.
3. If pairing is unsuccessful, unplug the Subwoofer and Center Channel for 10 seconds and try again.

### How to Re-Pair Bluetooth Remote Control

1. Ensure Center Channel is powered on.
2. On the Remote Control, hold down **Volume +** and **-** simultaneously for 10 seconds.
  - The red LED on the Remote Control will blink for two seconds, then turn off.
3. Change volume with the Remote Control to verify successful pairing.

# Limited Warranty

Lovesac furniture is Designed for Life™. This means that as your furniture needs change, our products evolve along with you.

Designed for Life™ products also come with peace of mind. When you buy a Lovesac product, you never have to worry. Upon purchase, every Lovesac product is automatically registered and your warranty is activated.

To make things even easier, we've broken down the warranty details of your Lovesac StealthTech purchase.

The Lovesac StealthTech products listed below are covered under a limited warranty for 3 years following the date of purchase.

## **Sactionals StealthTech Sound + Charge System:**

- Sound + Charge Subwoofer
- Sound + Charge Center Channel
- Sound + Charge Integrated Wireless Charger
- Sound + Charge Subwoofer Power Adaptor
- Sound + Charge Center Channel Power Cord
- Sound + Charge Remote Control
- Sound + Charge Audio Cable: R
- Sound + Charge Audio Cable: L

## **System Enhancements:**

- Sound + Charge Satellite Subwoofer
- Sound + Charge 25 Foot Audio Cable: R/L
- Sound + Charge 25 Foot Audio Cable: Satellite

For full Lovesac warranty information please visit [lovesac.com/warranty](https://lovesac.com/warranty).

# Specifications

## **Sactionals StealthTech Sound + Charge Side (Each):**

- Model No.s GE0177, GE2913
- Total speaker power output (Max. @ THD 1%): 52W RMS, 104W peak
- Speaker drivers: 1 x 6.5" mid with tweeter, 1 x 3.5" mid with tweeter
- Frequency range: 130Hz–20KHz
- Operating temperature: 0° C - 45° C
- Dimensions: 35.3" x 27" x 6" / 896 x 687 x 152mm
- Weight: 38lbs / 17.2kg

## **Sactionals StealthTech Sound + Charge Center Channel:**

- Model No. EE4034
- Power input: 100 - 240VAC, ~50/60Hz
- Total speaker power output (Max. @ THD 1%): 40W RMS, 80W peak
- Speaker drivers: 4 x mid-range, 1 x 1" tweeter, 2 x 3.5" woofer
- Frequency range: 65Hz-20KHz +/- 10dB
- Operating temperature: 0° C - 45° C
- Audio inputs: 1 x HDMI (ARC), 1 x Optical, 1 x 3.5mm Auxiliary, Bluetooth
- Dimensions: 32" x 5.5" x 3" / 812.8 x 139.7 x 76.2mm
- Weight: 9.5lbs / 4.4kg
- Bluetooth version: 5.0

## **Sactionals StealthTech Sound + Charge Remote Control:**

- Model No. EE3531
- Bluetooth version: 4.2
- Bluetooth frequency range: 2.4GHz-2.4835GHz
- Transmitting power: 0dBm
- Modulation type: GFSK

## **Sactionals StealthTech Sound + Charge Subwoofer:**

- Model No. EE0362
- Power supply input: 100 - 240VAC, ~50/60Hz
- Power supply output: 7.5 Amps, 24V DC
- Speaker power output (Max. @ THD 1%): 50W RMS, 100W Peak
- Speaker driver: 1 x 8" Subwoofer
- Frequency range: Down to 33Hz (-10dB)
- Operating temperature: 0° C - 45° C
- Dimensions: 22" x 14.1" x 3.9" / 560 x 360 x 100mm
- Weight: 23.5lbs / 10.7kg

## **Sactionals StealthTech Sound + Charge Satellite Subwoofer:**

- Model No. EW3251
- Power supply input: 100 - 240VAC, ~50/60Hz
- Power supply output: 2.1 Amps, 24V DC

- Speaker power output (Max. @ THD 1%): 50W RMS, 100W Peak
- Speaker driver: 1 x 8" Subwoofer
- Frequency range: Down to 33Hz (-10dB)
- Operating temperature: 0° C - 45° C
- Dimensions: 22" x 14.1" x 3.9" / 560 x 360 x 100mm
- Weight: 22lbs / 10kg

## **Sactionals StealthTech Sound + Charge Satellite Side (Each):**

- Model No. GE7065
- Total speaker power output (Max. @ THD 1%): 12W RMS, 24W Peak
- Speaker drivers: 1 x 3.5" mid with tweeter
- Frequency range: 130Hz – 20KHz
- Operating temperature: 0° C - 45° C
- Dimensions: 35.3" x 27" x 6" / 896 x 687 x 152mm
- Weight: 32lbs / 14.5kg

## **Total Sactionals StealthTech Sound + Charge System Speaker Power Output:**

- 6 Speaker Immersive Sound + Charge System (Max. @ THD 1%): 194W RMS, 388W peak
- 7 Speaker Immersive Sound + Charge System (Max. @ THD 1%): 206W RMS, 412W peak
- 8 Speaker Immersive Sound + Charge System (Max. @ THD 1%): 218W RMS, 436W peak
- 9 Speaker Immersive Sound + Charge System (Max. @ THD 1%): 230W RMS, 460W peak
- 10 Speaker Immersive Sound + Charge System (Max. @ THD 1%): 242W RMS, 484W peak

# Legal & Compliance

## FCC compliance statement

This device complies with Part 15 of the FCC Rules. Operation is subject to the following two conditions:

- (1) this device may not cause harmful interference, and
- (2) this device must accept any interference received, including interference that may cause undesired operation.

Changes or modifications not expressly approved by the party responsible for compliance could void the user's authority to operate the equipment.

This equipment has been tested and found to comply with the limits for a Class B digital device, pursuant to Part 15 of the FCC Rules. These limits are designed to provide reasonable protection against harmful interference in a residential installation. This equipment generates, uses and can radiate radio frequency energy and, if not installed and used in accordance with the instructions, may cause harmful interference to radio communications. However, there is no guarantee that interference will not occur in a particular installation.

If this equipment does cause harmful interference to radio or television reception, which can be determined by turning the equipment off and on, the user is encouraged to try to correct the interference by one or more of the following measures:

- Reorient or relocate the receiving antenna.
- Increase the separation between the equipment and receiver.
- Connect the equipment into an outlet on a circuit different from that to which the receiver is connected.
- Consult the dealer or an experienced radio/TV technician for help.

## ISED compliance statement

This device contains license-exempt transmitter(s)/receiver(s) that comply with Innovation, Science and Economic Development Canada's license-exempt RSS(s). Operation is subject to the following two conditions:

- (1) This device may not cause interference.
- (2) This device must accept any interference, including interference that may cause undesired operation of the device.

L'émetteur/récepteur exempt de licence contenu dans le présent appareil est conforme aux CNR d'Innovation, Sciences et Développement économique Canada applicables aux appareils radio exempts de licence.

L'exploitation est autorisée aux deux conditions suivantes :

- (1) L'appareil ne doit pas produire de brouillage;
- (2) L'appareil doit accepter tout brouillage radioélectrique subi, même si le brouillage est susceptible d'en compromettre le fonctionnement.

## Radiation Exposure statement

This equipment complies with FCC/IC RSS-102 radiation exposure limits set forth for an uncontrolled environment. This equipment should be installed and operated with minimum distance 20 cm between the radiator and your body.

Cet équipement est conforme aux limites d'exposition aux radiations FCC/IC CNR-102 établies pour un environnement non contrôlé. Cet équipement doit être installé et utilisé avec une distance minimale de 20 cm entre le radiateur et votre corps.



The Bluetooth® word mark and logos are registered trademarks owned by Bluetooth SIG, Inc. and any use of such marks by Harman International Industries, Incorporated is under license. Other trademarks and trade names are those of their respective owners.



Manufactured under license from Dolby Laboratories. Dolby, Dolby Audio, and the double-D symbol are trademarks of Dolby Laboratories Licensing Corporation.



The terms HDMI, HDMI High-Definition Multimedia Interface, and the HDMI logo are trademarks or registered trademarks of HDMI Licensing Administrator, Inc.

**LOVESAC**  
STEALTHTECH™