

FCC AND ISED CERTIFICATION TEST REPORT

FOR

| | | |
|-----------------------------|---|---|
| Applicant | : | Harman International Industries, Inc. |
| Address | : | 8500 Balboa Boulevard, Northridge, CA 91329, UNITED STATES |
| Equipment under Test | : | BLUETOOTH HEADSET |
| Model No. | : | LIVE PRO+ TWS |
| Trade Mark | : | JBL |
| FCC ID | : | APILIVEPROTWS |
| IC | : | 6132A-LIVEPROTWS |
| Manufacturer | : | Harman International Industries, Inc. |
| Address | : | 8500 Balboa Boulevard, Northridge, CA 91329, UNITED STATES |

Issued By: Dongguan Dongdian Testing Service Co., Ltd.

Add.: No. 17, Zongbu Road 2, Songshan Lake Sci&Tech, Industry Park,
Dongguan City, Guangdong Province, China, 523808

Tel.: +86-0769-38826678, **E-mail:** ddt@dgddt.com, <http://www.dgddt.com>

REPORT

Table of Contents

| | | |
|------|---|----|
| | Test report declares..... | 4 |
| 1. | Summary of Test Results..... | 6 |
| 2. | General Test Information | 7 |
| 2.1. | Description of EUT | 7 |
| 2.2. | Accessories of EUT..... | 7 |
| 2.3. | Assistant equipment used for test..... | 8 |
| 2.4. | Block diagram of EUT configuration for test | 8 |
| 2.5. | Test environment conditions | 8 |
| 2.6. | Deviations of test standard..... | 8 |
| 2.7. | Test laboratory | 8 |
| 2.8. | Measurement uncertainty..... | 9 |
| 3. | Equipment Used During Test..... | 9 |
| 4. | 6 dB Bandwidth and 99% Bandwidth..... | 11 |
| 4.1. | Block diagram of test setup..... | 11 |
| 4.2. | Limits | 11 |
| 4.3. | Test procedure | 11 |
| 4.4. | Test result..... | 12 |
| 4.5. | Original test data | 12 |
| 5. | Maximum Peak Output Power | 17 |
| 5.1. | Block diagram of test setup..... | 17 |
| 5.2. | Limits | 17 |
| 5.3. | Test procedure | 17 |
| 5.4. | Test result..... | 17 |
| 5.5. | Original test data | 18 |
| 6. | Power Spectral Density..... | 20 |
| 6.1. | Block diagram of test setup..... | 20 |
| 6.2. | Limits | 20 |
| 6.3. | Test procedure | 20 |
| 6.4. | Test result..... | 20 |
| 6.5. | Original test data | 21 |
| 7. | Band Edge Compliance (Conducted Method) | 23 |
| 7.1. | Block diagram of test setup..... | 23 |
| 7.2. | Limits | 23 |
| 7.3. | Test procedure | 23 |
| 7.4. | Test result..... | 24 |
| 7.5. | Original test data | 24 |
| 8. | Radiated Emission | 26 |

| | | |
|-------|---|----|
| 8.1. | Block diagram of test setup..... | 26 |
| 8.2. | Limit..... | 27 |
| 8.3. | Test Procedure..... | 28 |
| 8.4. | Test result..... | 30 |
| 9. | RF Conducted Spurious Emissions | 34 |
| 9.1. | Block diagram of test setup..... | 34 |
| 9.2. | Limits | 34 |
| 9.3. | Test procedure | 34 |
| 9.4. | Test result..... | 35 |
| 9.5. | Original test data | 35 |
| 10. | Emissions in Restricted Frequency Bands | 42 |
| 10.1. | Block diagram of test setup..... | 42 |
| 10.2. | Limit..... | 42 |
| 10.3. | Test procedure | 42 |
| 10.4. | Test result..... | 42 |
| 11. | Power Line Conducted Emission | 47 |
| 11.1. | Block diagram of test setup..... | 47 |
| 11.2. | Power line conducted emission limits | 47 |
| 11.3. | Test procedure | 47 |
| 11.4. | Test result..... | 48 |
| 12. | Antenna Requirements | 51 |
| 12.1. | Limit..... | 51 |
| 12.2. | Result | 51 |

Test Report Declare

| | | |
|-----------------------------|---|--|
| Applicant | : | Harman International Industries, Inc. |
| Address | : | 8500 Balboa Boulevard, Northridge, CA 91329, UNITED STATES |
| Equipment under Test | : | BLUETOOTH HEADSET |
| Model No. | : | LIVE PRO+ TWS |
| Trade Mark | : | JBL |
| Manufacturer | : | Harman International Industries, Inc. |
| Address | : | 8500 Balboa Boulevard, Northridge, CA 91329, UNITED STATES |

Test Standard Used:

FCC Rules and Regulations Part 15 Subpart C, RSS-247 Issue 2 February 2017.

Test Procedure Used:

ANSI C63.10:2013, RSS-Gen Issue 5, Apr. 2018

We Declare:

The equipment described above is tested by Dongguan Dongdian Testing Service Co., Ltd. and in the configuration tested the equipment complied with the standards specified above. The test results are contained in this test report and Dongguan Dongdian Testing Service Co., Ltd. is assumed of full responsibility for the accuracy and completeness of these tests.

After test and evaluation, our opinion is that the equipment provided for test compliance with the requirement of the above FCC&ISED standards.

| | | | |
|-------------------------|-------------------|----------------------|-------------------------------|
| Report No: | DDT-R20063026-1E5 | | |
| Date of Receipt: | Jul. 06, 2020 | Date of Test: | Jul. 07, 2020 ~ Aug. 31, 2020 |

Prepared By:

Talent Zhang

Talent Zhang/Engineer

Approved By:



Damon Hu/EMC Manager

Note: This report applies to above tested sample only. This report shall not be reproduced in parts without written approval of Dongguan Dongdian Testing Service Co., Ltd.

Revision History

| Rev. | Revisions | Issue Date | Revised By |
|------|---------------|---------------|------------|
| --- | Initial issue | Aug. 31, 2020 | |
| | | | |

1. Summary of Test Results

| The EUT have been tested according to the applicable standards as referenced below. | | |
|---|---|---------|
| Description of Test Item | Standard | Verdict |
| 6 dB Bandwidth and 99% Bandwidth | FCC Part 15: 15.247 ANSI C63.10:2013 RSS-247 Issue 2 | Pass |
| Peak Output Power | FCC Part 15: 15.247 ANSI C63.10:2013 RSS-247 Issue 2 | Pass |
| Power Spectral Density | FCC Part 15:15.247 ANSI C63.10:2013 RSS-247 Issue 2 | Pass |
| Band Edge Compliance (conducted method) | FCC Part 15: 15.209 FCC Part 15: 15.247 ANSI C63.10: 2013 RSS-247 Issue 2 RSS-Gen Issue 5 | Pass |
| Radiation Emission | FCC Part 15: 15.247 ANSI C63.10:2013 RSS-247 Issue 2 RSS-Gen Issue 5 | Pass |
| RF Conducted Spurious Emissions | FCC Part 15: 15.209 FCC Part 15: 15.247 ANSI C63.10: 2013 RSS-247 Issue 2 RSS-Gen Issue 5 | Pass |
| Emission in Restricted Frequency Bands | FCC Part 15: 15.209 FCC Part 15: 15.247 ANSI C63.10: 2013 RSS-247 Issue 2 RSS-Gen Issue 5 | Pass |
| Power Line Conducted Emission | FCC Part 15: 15.207 ANSI C63.10: 2013 RSS-Gen Issue 5 | Pass |
| Antenna Requirement | FCC Part 15: 15.203 RSS-Gen Issue 5 | Pass |

2. General Test Information

2.1. Description of EUT

| | |
|--------------------------|--|
| EUT* Name | : BLUETOOTH HEADSET |
| Model Number | : LIVE PRO+ TWS |
| EUT Function Description | : Please reference user manual of this device |
| Power Supply | : DC 5V from Charging case : DC 3.7V Polymer Li-ion built-in battery |
| Radio Specification | : Bluetooth V5.0 |
| Operation Frequency | : 2402 MHz - 2480 MHz |
| Modulation | : GFSK |
| Data Rate | : 1Mbps |
| Antenna Type | : Left side: LDS antenna, maximum PK gain: -2.13 dBi : Right side: LDS antenna, maximum PK gain: 0.65 dBi |
| Sample Type | : B17CE8 and B17CE9 for conductive Left side and Right side : B17D03 and B17DD9 for radiation Left side and Right side TL-GTR202411MA002 for charging case |

Note: EUT is the ab. of equipment under test.

| Channel information | | | | | |
|---------------------|-----------------|---------|-----------------|---------|-----------------|
| Channel | Frequency (MHz) | Channel | Frequency (MHz) | Channel | Frequency (MHz) |
| 0 | 2402 | 14 | 2430 | 28 | 2458 |
| 1 | 2404 | 15 | 2432 | 29 | 2460 |
| 2 | 2406 | 16 | 2434 | 30 | 2462 |
| 3 | 2408 | 17 | 2436 | 31 | 2464 |
| 4 | 2410 | 18 | 2438 | 32 | 2466 |
| 5 | 2412 | 19 | 2440 | 33 | 2468 |
| 6 | 2414 | 20 | 2442 | 34 | 2470 |
| 7 | 2416 | 21 | 2444 | 35 | 2472 |
| 8 | 2418 | 22 | 2446 | 36 | 2474 |
| 9 | 2420 | 23 | 2448 | 37 | 2476 |
| 10 | 2422 | 24 | 2450 | 38 | 2478 |
| 11 | 2424 | 25 | 2452 | 39 | 2480 |
| 12 | 2426 | 26 | 2454 | | |
| 13 | 2428 | 27 | 2456 | | |

2.2. Accessories of EUT

| Description of Accessories | Manufacturer | Model Number | Description | Remark |
|----------------------------|-------------------------------------|---------------|---------------------------|--------|
| Type-C Cable | Harman | N/A | Length: 220mm, unshielded | N/A |
| Charging case | Harman | LIVE PRO+ TWS | N/A | N/A |
| Built-in Battery | Chongqing VDL Electronics Co., Ltd. | 1254 VDL | DC3.7V, 55mAh | N/A |

2.3. Assistant equipment used for test

| Assistant equipment | Manufacturer | Model number | EMC Compliance | SN |
|---------------------|-------------------------|--------------|--|----------|
| Notebook | Lenovo Beijing Co. Ltd. | ThinkPad | FCC/CE | TP00015A |
| Adapter | SAMSUNG | EP-TA200 | Input: 100-240~, 50/60Hz, 0.5A; Output: 9V/1.67A or 5V/2A | N/A |

2.4. Block diagram of EUT configuration for test

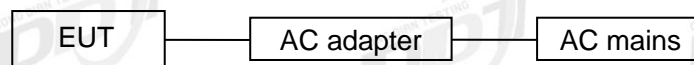

Test software: BQB.EXE

The test software was used to control EUT work in Continuous Tx mode, and select test channel, wireless mode as below table:

| Tested mode, channel, information | | | |
|-----------------------------------|------------------|---------|-----------------|
| Mode | Setting Tx Power | Channel | Frequency (MHz) |
| GFSK | / | CH0 | 2402 |
| | / | CH19 | 2440 |
| | / | CH39 | 2480 |

2.5. Test environment conditions

During the measurement the environmental conditions were within the listed ranges:

| | |
|--------------------|------------|
| Temperature range: | 21-25 °C |
| Humidity range: | 40-75% |
| Pressure range: | 86-106 kPa |

2.6. Deviations of test standard

No deviation.

2.7. Test laboratory

Dongguan Dongdian Testing Service Co., Ltd.

Add.: No. 17, Zongbu Road 2, Songshan Lake Sci&Tech, Industry Park, Dongguan City, Guangdong Province, China, 523808

Tel.: +86-0769-38826678, <http://www.dgddt.com>, Email: ddt@dgddt.com

CNAS Registration No. CNAS L6451; A2LA Certificate Number: 3870.01;

FCC Designation Number: CN1182; FCC Test Firm Registration Number: 540522

Industry Canada Site Registration Number: 10288A-1

2.8. Measurement uncertainty

| Test Item | Uncertainty |
|---|---|
| Bandwidth | 1.1% |
| Peak Output Power (Conducted) (Spectrum analyzer) | 0.86 dB (10 MHz ≤ f < 3.6 GHz); 1.38 dB (3.6 GHz ≤ f < 8 GHz) |
| Peak Output Power (Conducted) (Power Sensor) | 0.74 dB |
| Power Spectral Density | 0.74 dB (10 MHz ≤ f < 3.6 GHz); 1.38 dB (3.6 GHz ≤ f < 8 GHz) |
| Frequencies Stability | 6.7 × 10 ⁻⁸ (Antenna couple method) 5.5 × 10 ⁻⁸ (Conducted method) |
| Conducted spurious emissions | 0.86 dB (10 MHz ≤ f < 3.6 GHz); 1.40 dB (3.6 GHz ≤ f < 8 GHz) 1.66 dB (8 GHz ≤ f < 22 GHz) |
| Uncertainty for radio frequency (RBW < 20 kHz) | 3×10 ⁻⁸ |
| Temperature | 0.4 °C |
| Humidity | 2 % |
| Uncertainty for Radiation Emission test (30 MHz - 1 GHz) | 4.70 dB (Antenna Polarize: V) 4.84 dB (Antenna Polarize: H) |
| Uncertainty for Radiation Emission test (1 GHz - 40 GHz) | 4.10 dB (1 - 6 GHz) 4.40 dB (6 GHz - 18 GHz) 3.54 dB (18 GHz - 26 GHz) 4.30 dB (26 GHz - 40 GHz) |
| Uncertainty for Power line conduction emission test | 3.32 dB (150 kHz - 30 MHz) |

Note: This uncertainty represents an expanded uncertainty expressed at approximately the 95% confidence level using a coverage factor of k=2.

3. Equipment Used During Test

| Equipment | Manufacturer | Model No. | Serial No. | Last Cal. | Cal. Interval |
|---|--------------|-----------------|------------|---------------|---------------|
| RF Connected Test (Tonscend RF Measurement System) | | | | | |
| Spectrum analyzer | R&S | FSU26 | 200071 | Sep. 29, 2019 | 1 Year |
| Spectrum analyzer | Agilent | N9020D | MY49100362 | Sep. 29, 2019 | 1 Year |
| Wideband Radio Communication tester | R&S | CMW500 | 117491 | Jul. 01, 2020 | 1 Year |
| Vector Signal Generator | Agilent | E8267D | US49060192 | Sep. 29, 2019 | 1 Year |
| Vector Signal Generator | Agilent | N5182A | MY48180737 | Jul. 01, 2020 | 1 Year |
| Power Sensor | Agilent | U2021XA | MY55150010 | Jul. 01, 2020 | 1 Year |
| Power Sensor | Agilent | U2021XA | MY55150011 | Jul. 01, 2020 | 1 Year |
| DC Power Source | MATRIS | MPS-3005L-3 | D813058W | Jul. 01, 2020 | 1 Year |
| RF Cable | Micable | C10-01-01-1 | 100309 | Sep. 29, 2019 | 1 Year |
| Temp&Humi Programmable | ZHIXIANG | ZXGDJS-15 0L | ZX170110-A | Oct. 21, 2019 | 1 Year |
| Test Software | JS Tonscend | JS1120-3 | Ver.2.7 | N/A | N/A |
| Radiation 1#chamber | | | | | |

| | | | | | |
|--|-------------|---------------|----------------|---------------|--------|
| EMI Test Receiver | R&S | ESU8 | 100316 | Sep. 29, 2019 | 1 Year |
| Spectrum analyzer | Agilent | E4447A | MY50180031 | Jul. 01, 2020 | 1 Year |
| Trilog Broadband Antenna | Schwarzbeck | VULB9163 | 9163-462 | Nov. 15, 2019 | 1 Year |
| Active Loop antenna | Schwarzbeck | FMZB-1519 | 1519-038 | Sep. 29, 2019 | 1 Year |
| Double Ridged Horn Antenna | R&S | HF907 | 100276 | Nov. 15, 2019 | 1 Year |
| Broad Band Horn Antenna | Schwarzbeck | BBHA 9170 | 790 | Sep. 29, 2019 | 1 Year |
| Pre-amplifier | A.H. | PAM-0118 | 360 | Sep. 29, 2019 | 1 Year |
| Pre-amplifier | TERA-MW | TRLA-0040 G35 | 101303 | Sep. 29, 2019 | 1 Year |
| RF Cable | HUBSER | CP-X2+ CP-X1 | W11.03+ W12.02 | Sep. 29, 2019 | 1 Year |
| RF Cable | N/A | 5m+6m+1m | 06270619 | Sep. 29, 2019 | 1 Year |
| MI Cable | HUBSER | C10-01-01-1 M | 1091629 | Sep. 29, 2019 | 1 Year |
| Test software | Audix | E3 | V 6.11111b | N/A | N/A |
| Radiation 2#chamber | | | | | |
| EMI Test Receiver | R&S | ESCI | 101364 | Sep. 29, 2019 | 1 Year |
| Spectrum analyzer | Agilent | E4447A | MY50180031 | Jul. 01, 2020 | 1 Year |
| Trilog Broadband Antenna | Schwarzbeck | VULB 9163 | 9163-994 | Nov. 15, 2019 | 1 Year |
| Active Loop antenna | Schwarzbeck | FMZB-1519 | 1519-038 | Sep. 29, 2019 | 1 Year |
| Double Ridged Horn Antenna | Schwarzbeck | BBHA9120 | 02108 | Jul. 21, 2019 | 1 Year |
| Broad Band Horn Antenna | Schwarzbeck | BBHA 9170 | 790 | Sep. 29, 2019 | 1 Year |
| Pre-amplifier | TERA-MW | TRLA-0040 G35 | 101303 | Sep. 29, 2019 | 1 Year |
| RF Cable | N/A | 14+1.5m | 06270619 | Sep. 29, 2019 | 1 Year |
| Test software | Audix | E3 | V 6.11111b | N/A | N/A |
| Power Line Conducted Emissions Test | | | | | |
| EMI Test Receiver | R&S | ESU8 | 100316 | Sep. 29, 2019 | 1 Year |
| LISN 1 | R&S | ENV216 | 101109 | Sep. 29, 2019 | 1 Year |
| LISN 2 | R&S | ESH2-Z5 | 100309 | Sep. 29, 2019 | 1 Year |
| Pulse Limiter | R&S | ESH3-Z2 | 101242 | Sep. 29, 2019 | 1 Year |
| CE Cable 1 | HUBSER | N/A | W10.01 | Sep. 29, 2019 | 1 Year |
| Test software | Audix | E3 | V 6.11111b | N/A | N/A |

4. 6 dB Bandwidth and 99% Bandwidth

4.1. Block diagram of test setup

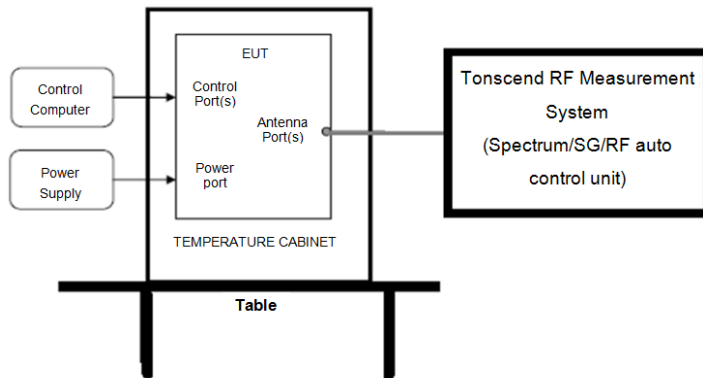

4.2. Limits

For direct sequence systems, the minimum 6 dB bandwidth shall be at least 500 kHz

4.3. Test procedure

(1) Connect EUT's antenna output to spectrum analyzer by RF cable.

(2) 99% Bandwidth set the spectrum analyzer as follows:

| | |
|----------------|----------|
| RBW: | 30 kHz |
| VBW: | 100 kHz |
| Detector Mode: | Peak |
| Sweep time: | auto |
| Trace mode | Max hold |

(3) 6 dB Bandwidth set the spectrum analyzer as follows:

| | |
|----------------|----------|
| RBW: | 100 kHz |
| VBW: | 300 kHz |
| Detector Mode: | Peak |
| Sweep time: | auto |
| Trace mode | Max hold |

(4) Allow the trace to stabilize, measure the 6 dB and 99% bandwidth of signal.

4.4. Test result

Left side:

| Mode | Channel | 99% bandwidth Result (MHz) | 6 dB bandwidth Result (MHz) | 6 dB width Limit (MHz) | Verdict |
|------|---------|----------------------------|-----------------------------|------------------------|---------|
| GFSK | CH0 | 1.020 | 0.704 | >0.5 | Pass |
| | CH19 | 1.024 | 0.708 | >0.5 | Pass |
| | CH39 | 1.024 | 0.704 | >0.5 | Pass |

Right side:

| Mode | Channel | 99% bandwidth Result (MHz) | 6 dB bandwidth Result (MHz) | 6 dB width Limit (MHz) | Verdict |
|------|---------|----------------------------|-----------------------------|------------------------|---------|
| GFSK | CH0 | 1.020 | 0.708 | >0.5 | Pass |
| | CH19 | 1.020 | 0.724 | >0.5 | Pass |
| | CH39 | 1.024 | 0.716 | >0.5 | Pass |

4.5. Original test data

Left side:

99% bandwidth:

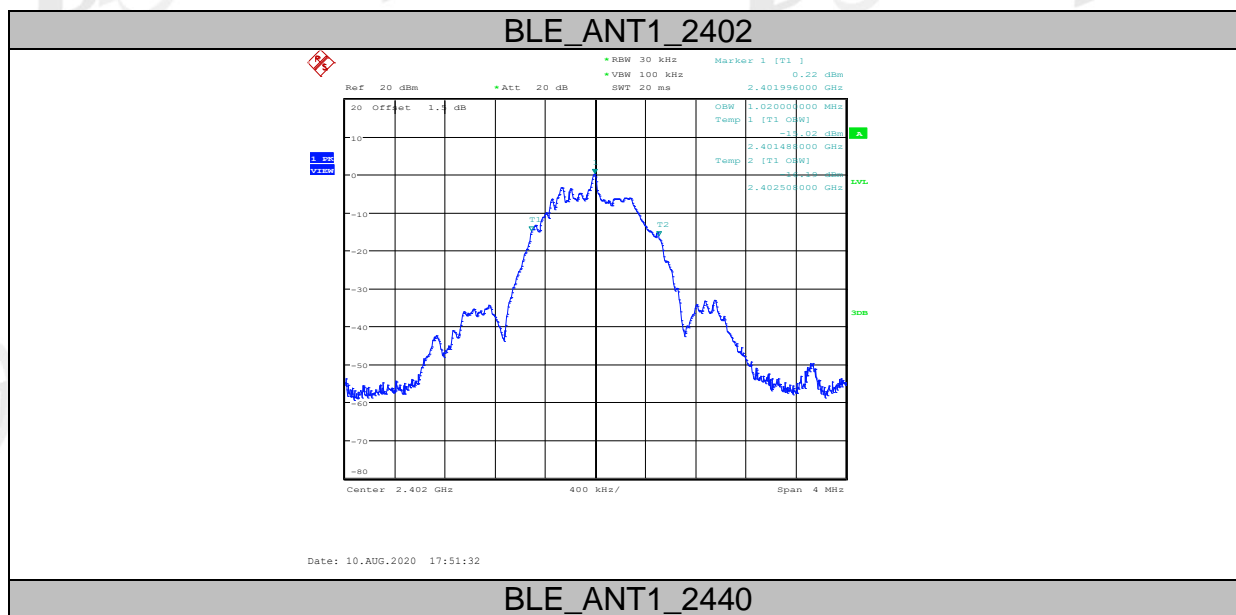

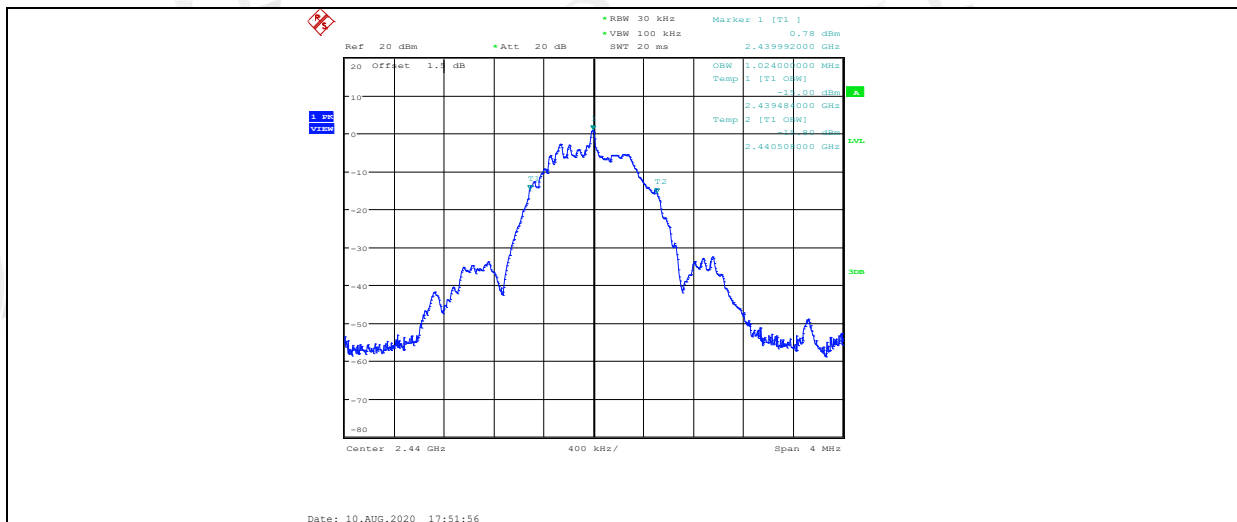

BLE_ANT1_2480

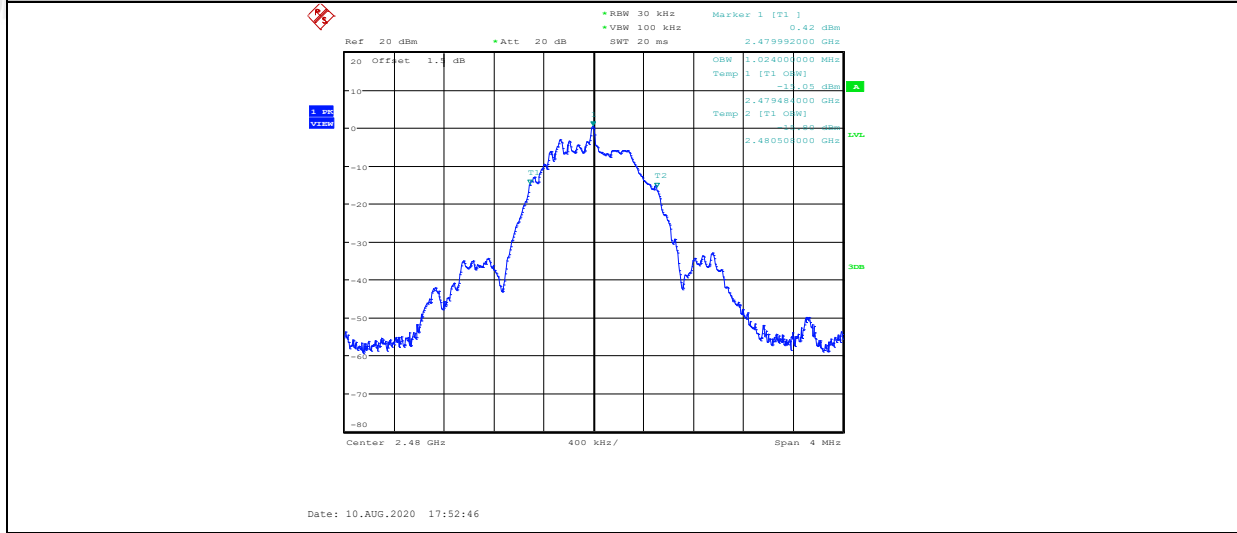

6 dB bandwidth:

BLE_ANT1_2402

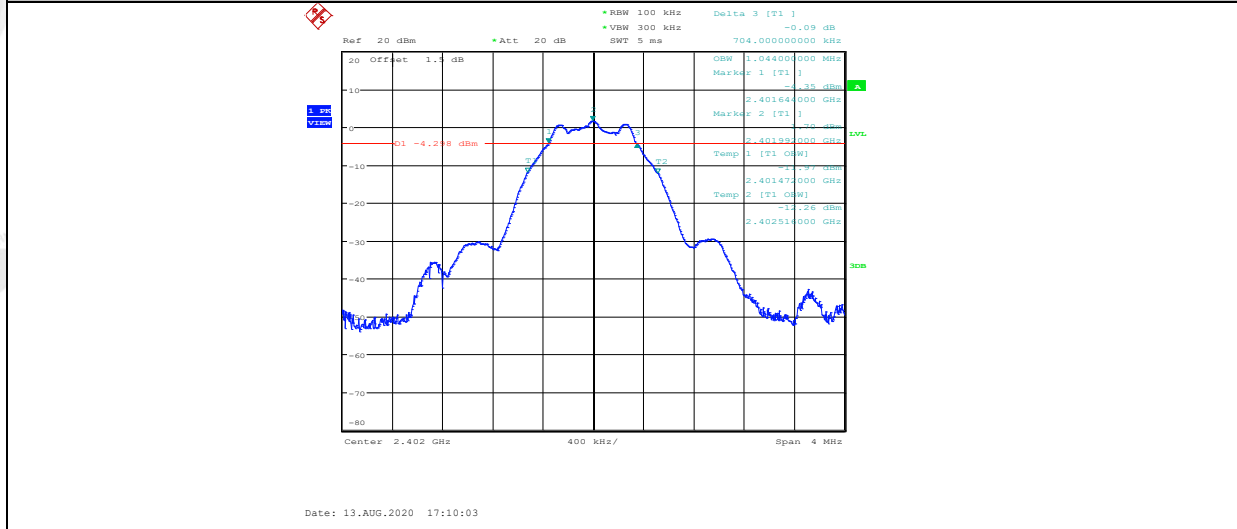

BLE_ANT1_2440

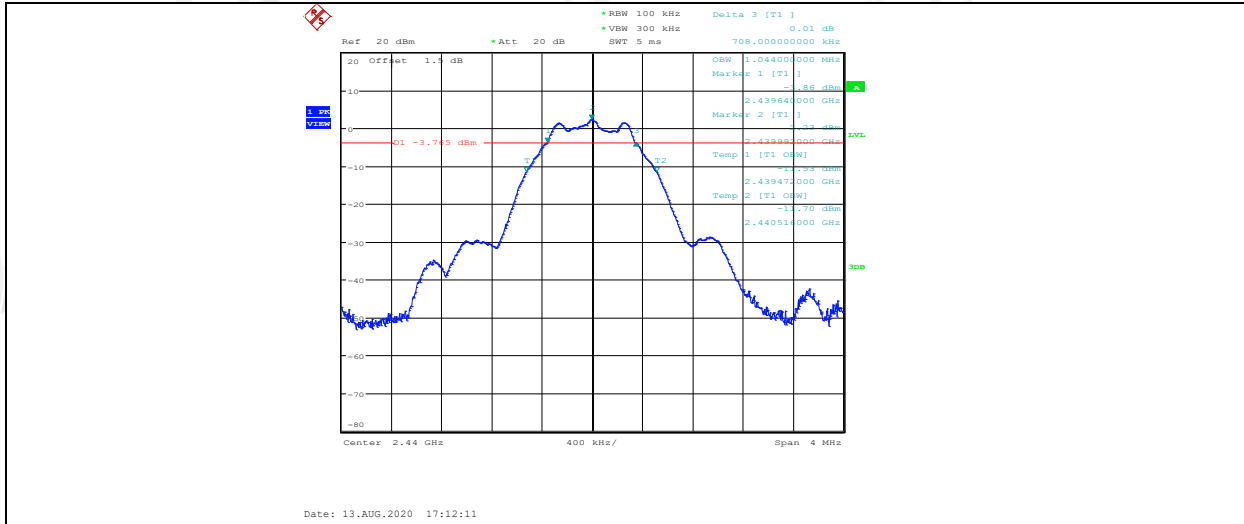

BLE_ANT1_2480

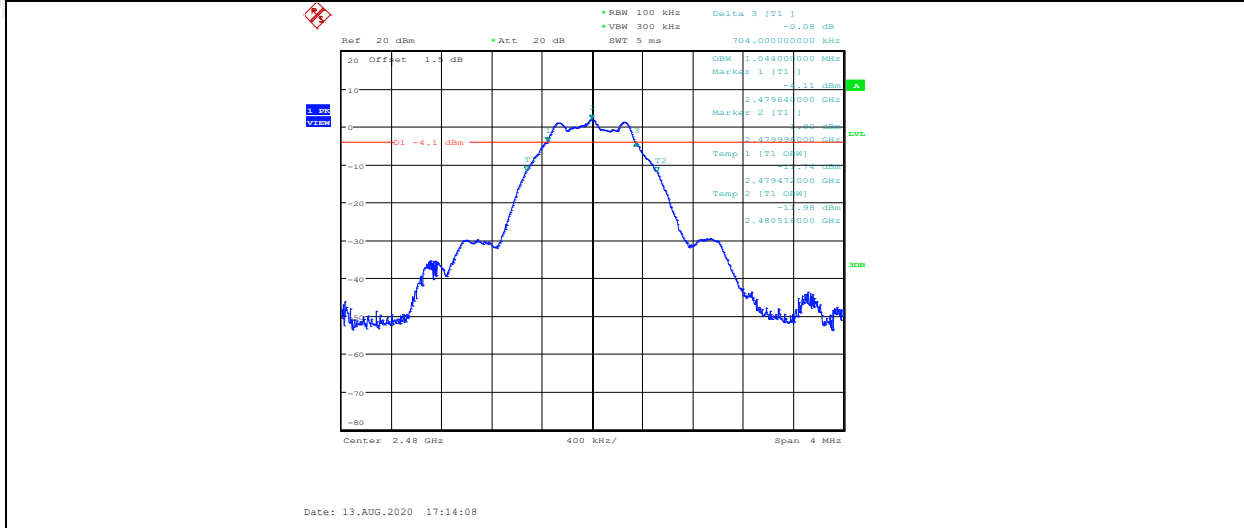

Right side:
99% bandwidth:

BLE_ANT1_2402

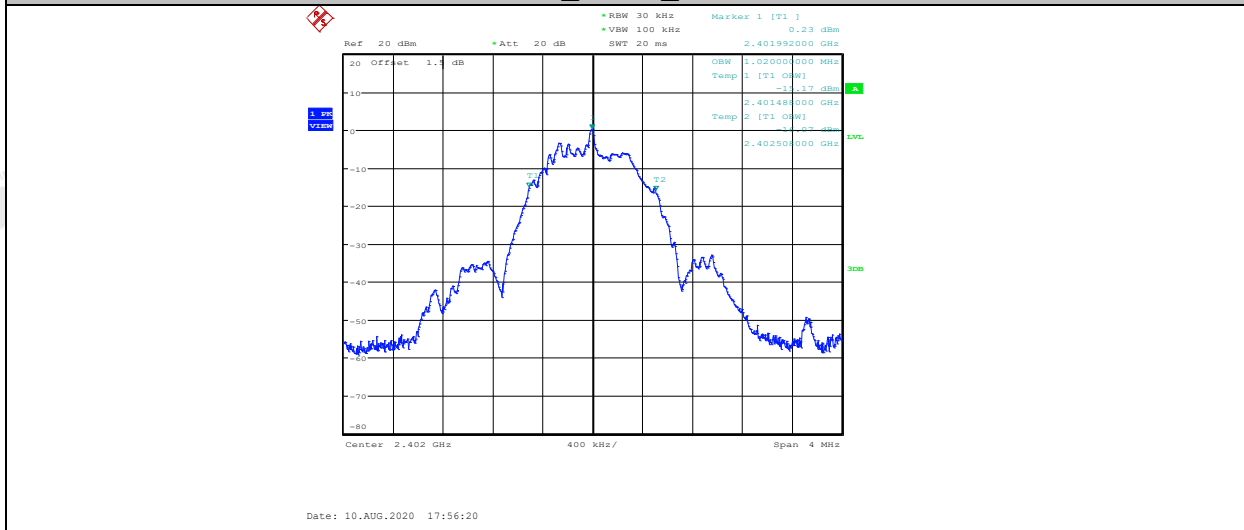

BLE_ANT1_2440

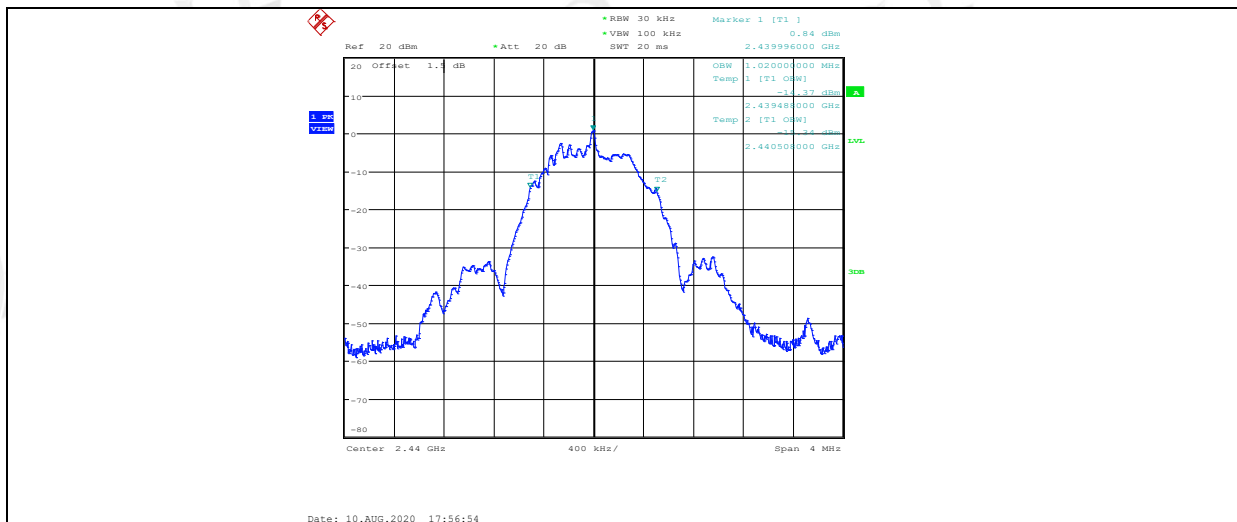

BLE_ANT1_2480

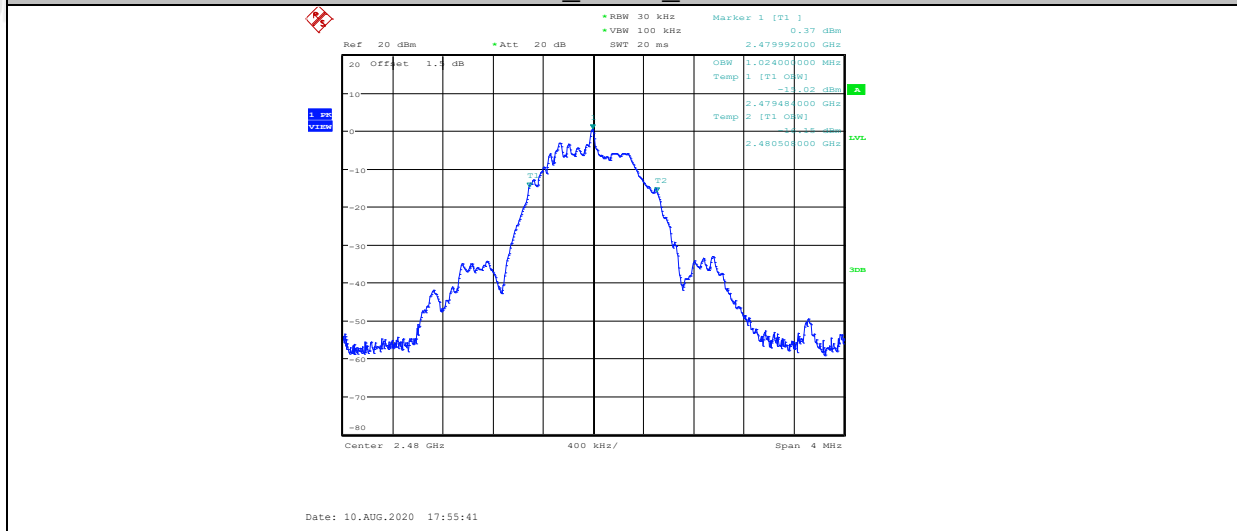

6 dB bandwidth:

BLE_ANT1_2402

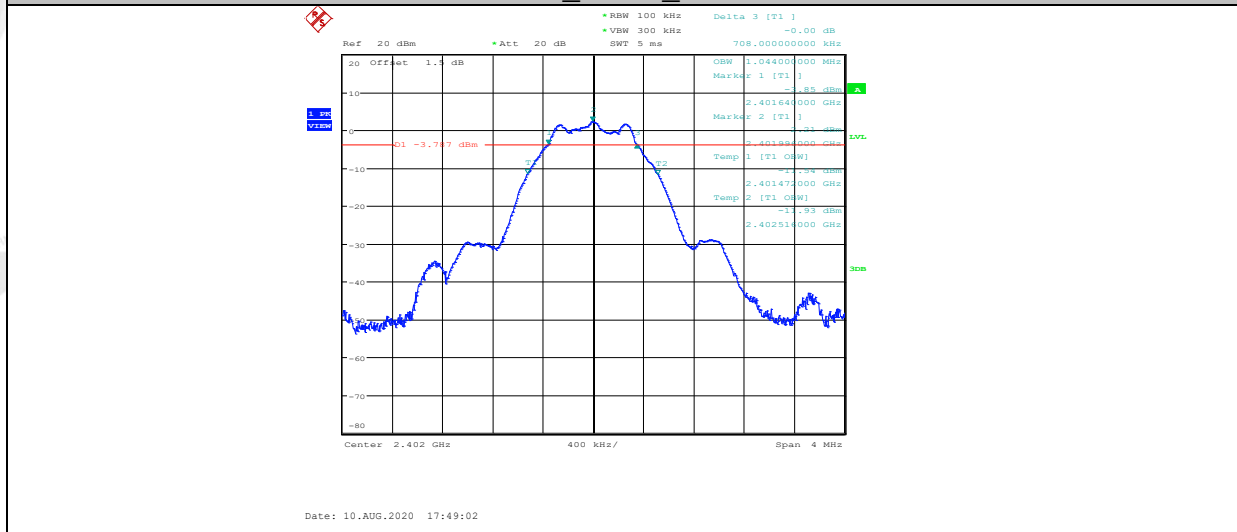

BLE_ANT1_2440

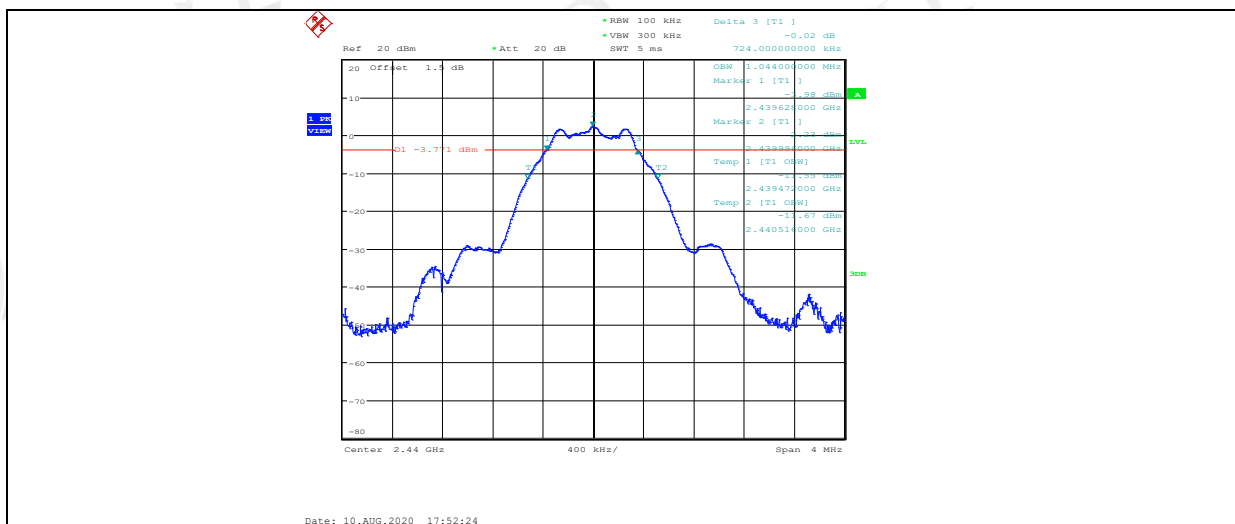

BLE_ANT1_2480

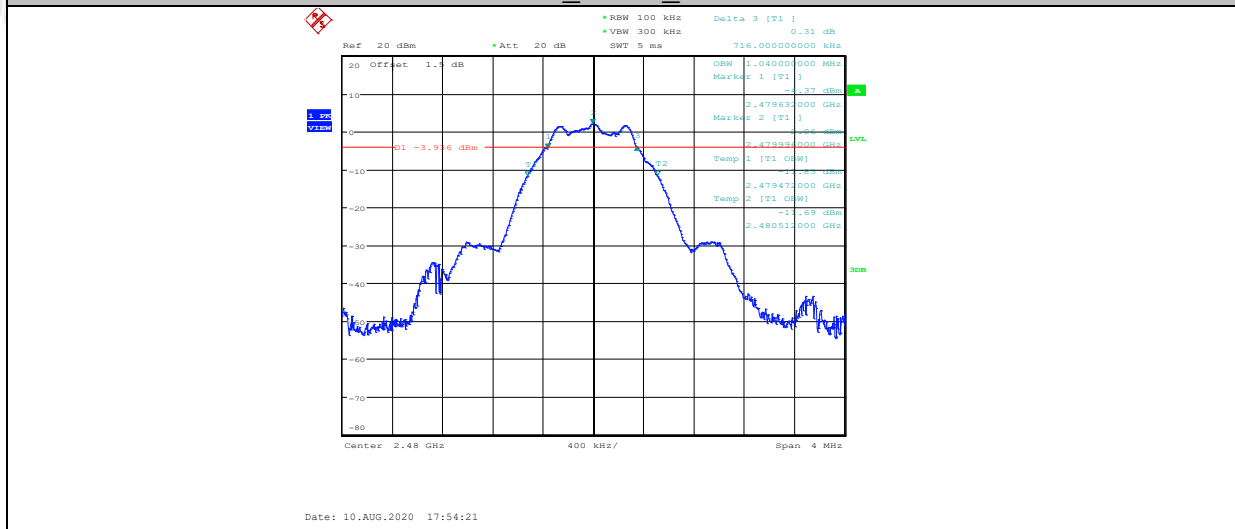

5. Maximum Peak Output Power

5.1. Block diagram of test setup

Same with 4.1

5.2. Limits

For systems using digital modulation in the 902-928 MHz, 2400-2483.5 MHz, and 5725-5850 MHz bands: 1 Watt. If transmitting antennas of directional gain greater than 6dBi are used, the conducted output power from the intentional radiator shall be reduced below the stated values as appropriate, by the amount in dB that the directional gain of the antenna exceeds 6 dBi.

5.3. Test procedure

- (1) Connect EUT's antenna output to spectrum analyzer by RF cable.
- (2) Set the spectrum analyzer as follows:

| | |
|----------------|----------------|
| RBW: | ≥DTS bandwidth |
| VBW: | ≥3 x RBW |
| Span | ≥3 x RBW |
| Detector Mode: | Peak |
| Sweep time: | auto |
| Trace mode | Max hold |

- (3) Allow the trace to stabilize, Use the instrument's band/channel power measurement function with the band limits set equal to the DTS bandwidth edges measure out the PK output power.

5.4. Test result

Left side:

| Mode | Freq. (MHz) | Peak Output Power (dBm) | Limit (dBm) | Verdict |
|------|-------------|-------------------------|-------------|---------|
| GFSK | 2402 | 2.34 | 30 | Pass |
| | 2440 | 3.03 | 30 | Pass |
| | 2480 | 2.75 | 30 | Pass |

Right side:

| Mode | Freq. (MHz) | Peak Output Power (dBm) | Limit (dBm) | Verdict |
|------|-------------|-------------------------|-------------|---------|
| GFSK | 2402 | 3.07 | 30 | Pass |
| | 2440 | 3.21 | 30 | Pass |
| | 2480 | 3.18 | 30 | Pass |

5.5. Original test data

Left side:

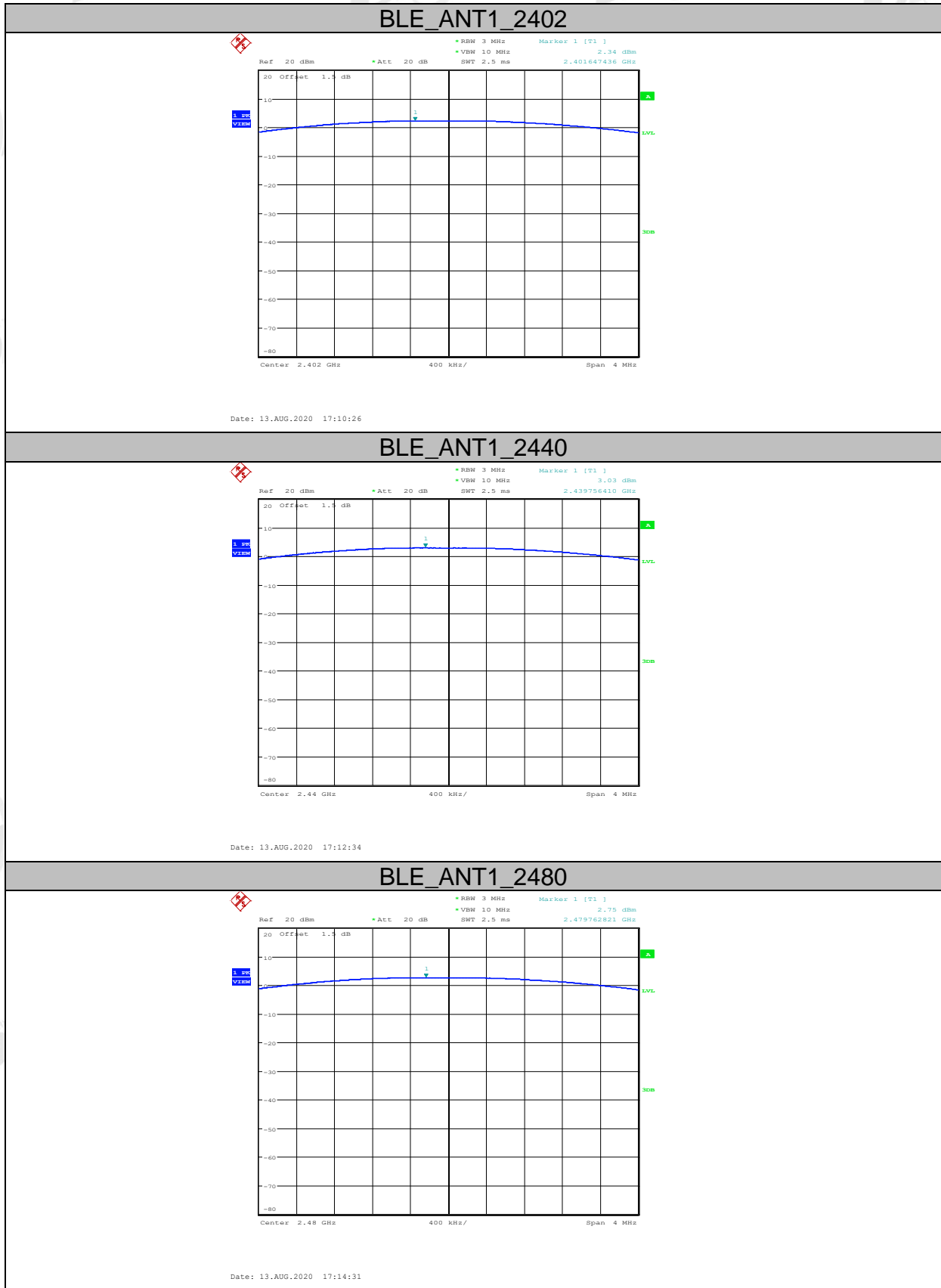

Right side:

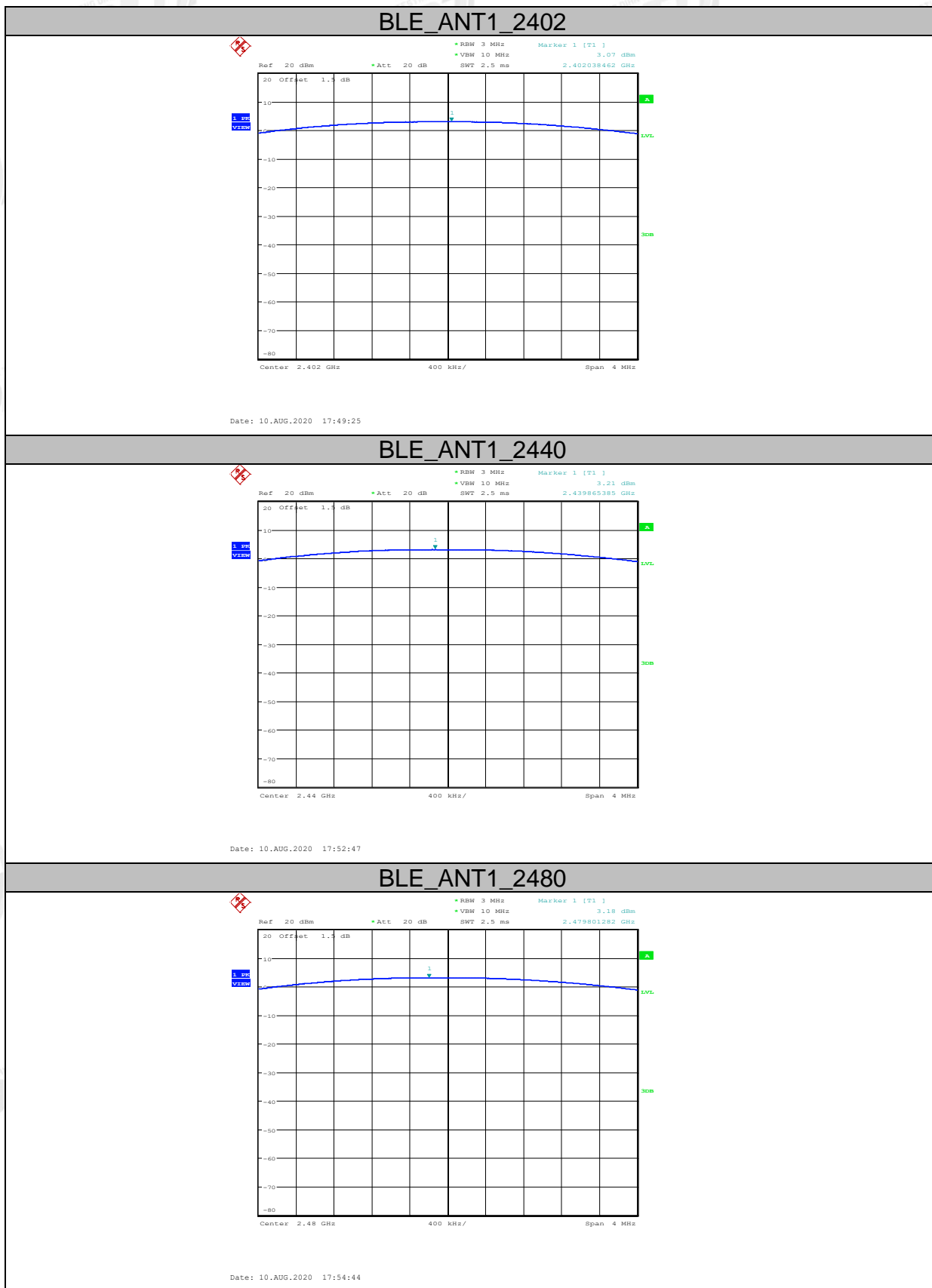

6. Power Spectral Density

6.1. Block diagram of test setup

Same with 4.1

6.2. Limits

For digitally modulated systems, the power spectral density conducted from the intentional radiator to the antenna shall not be greater than 8 dBm in any 3 kHz band during any time interval of continuous transmission.

6.3. Test procedure

- (1) Connect EUT's antenna output to spectrum analyzer by RF cable.
- (2) Set the spectrum analyzer as follows:

| | |
|------------------|--|
| Center frequency | DTS Channel center frequency |
| RBW: | $3 \text{ kHz} \leq \text{RBW} \leq 100 \text{ kHz}$ |
| VBW: | $\geq 3\text{RBW}$ |
| Span | 1.5 times the DTS bandwidth |
| Detector Mode: | Peak |
| Sweep time: | auto |
| Trace mode | Max hold |

- (3) Allow the trace to stabilize, use the peak marker function to determine the maximum amplitude level within the RBW.
- (4) If measured value exceeds limit, reduce RBW (no less than 3 kHz) and repeat.

6.4. Test result

Left side:

| EUT Set Mode | Antenna | Channel | Result (dBm/3 kHz) |
|-------------------------|---------|---------|--------------------|
| GFSK | ANT1 | CH0 | -13.48 |
| | ANT1 | CH19 | -12.79 |
| | ANT1 | CH39 | -13.17 |
| Limit: <13.2 dBm/10 kHz | | | Verdict: Pass |

Right side:

| EUT Set Mode | Antenna | Channel | Result (dBm/3 kHz) |
|---------------------|---------|---------|--------------------|
| GFSK | ANT1 | CH0 | -12.77 |
| | ANT1 | CH19 | -12.68 |
| | ANT1 | CH39 | -12.76 |
| Limit: <8 dBm/3 kHz | | | Verdict: Pass |

6.5. Original test data

Left side:

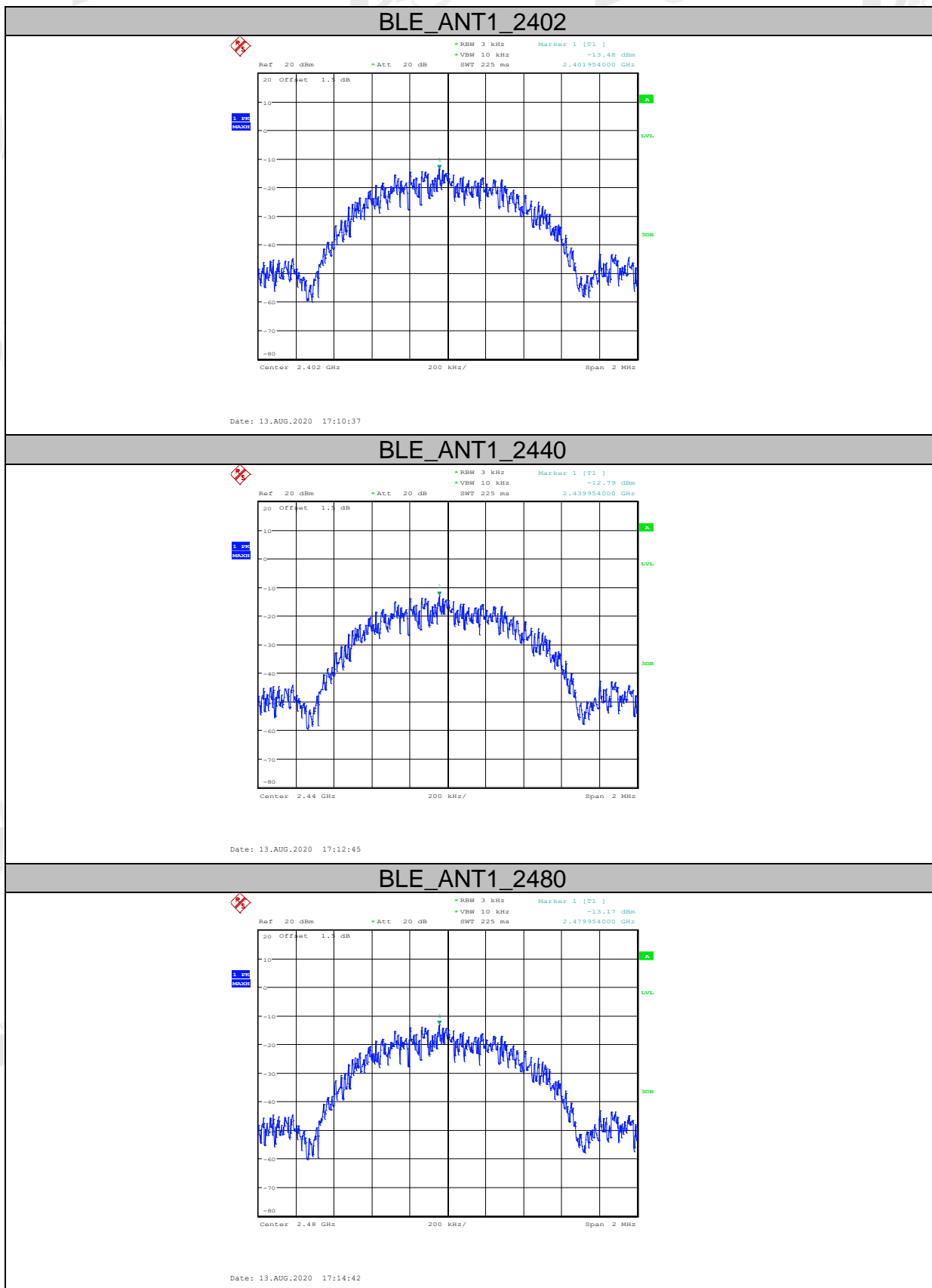

Right side:

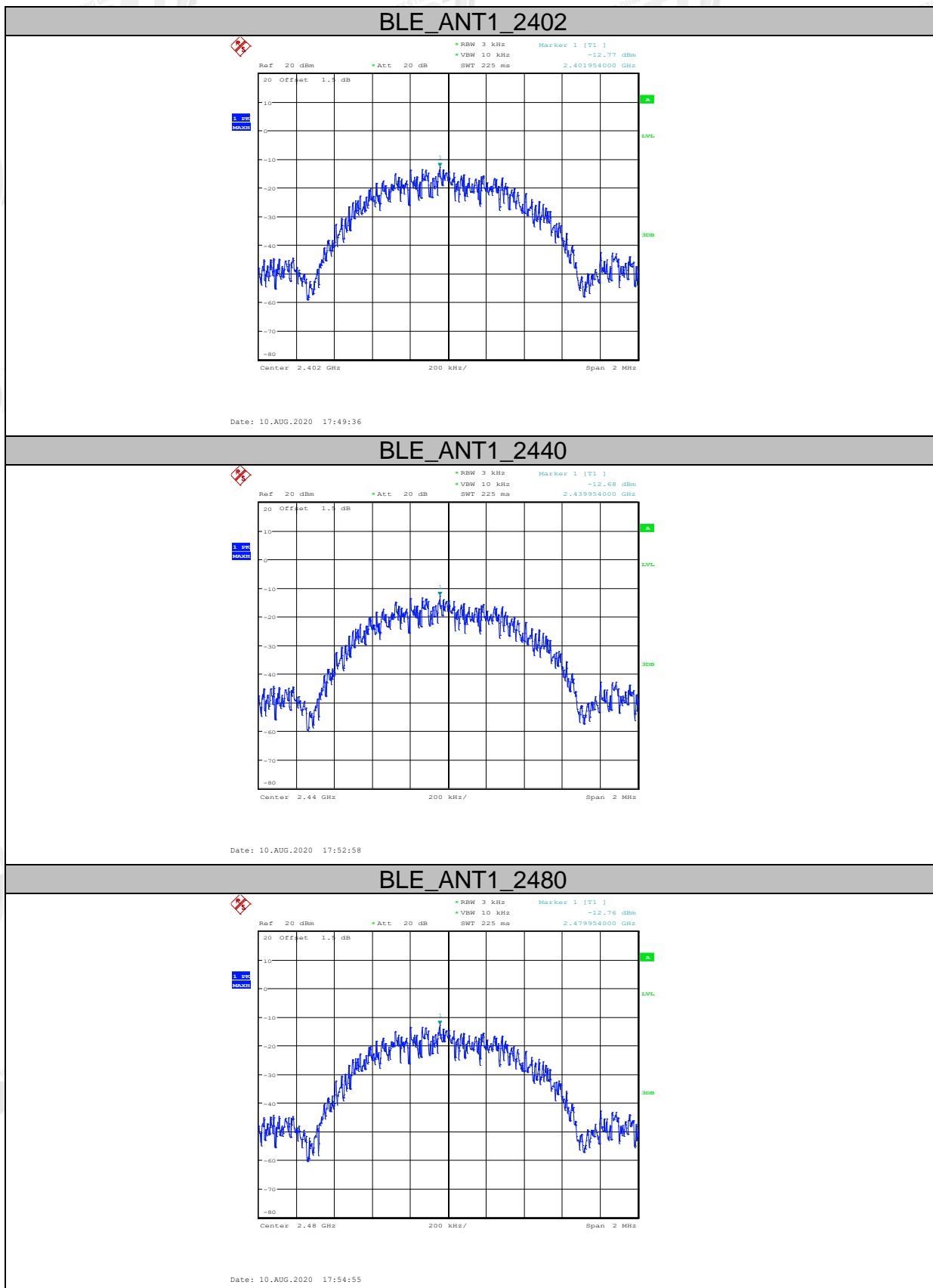

7. Band Edge Compliance (Conducted Method)

7.1. Block diagram of test setup

Same with 4.1

7.2. Limits

In any 100 kHz bandwidth outside the frequency bands in which the spread spectrum intentional radiator is operating, the radio frequency power that is produced by the intentional radiator shall be at least 20 dB below that in the 100 kHz bandwidth within the band that contains the highest level of the desired power.

7.3. Test procedure

(1) Connect EUT's antenna output to spectrum analyzer by RF cable.

(2) Establish a reference level by using the following procedure:

| | |
|------------------|------------------------------|
| Center frequency | DTS Channel center frequency |
| RBW: | 100 kHz |
| VBW: | 300 kHz |
| Span | 1.5 times the DTS bandwidth |
| Detector Mode: | Peak |
| Sweep time: | auto |
| Trace mode | Max hold |

(3) Allow the trace to stabilize, use the peak marker function to determine the maximum peak power level to establish the reference level.

(4) Set the spectrum analyzer as follows:

| | |
|------------------------------|--|
| RBW: | 100 kHz |
| VBW: | 300 kHz |
| Span | Encompass frequency range to be measured |
| Number of measurement points | $\geq \text{span/RBW}$ |
| Detector Mode: | Peak |
| Sweep time: | auto |
| Trace mode | Max hold |

(5) Allow the trace to stabilize, use the peak marker function to determine the maximum amplitude of all unwanted emissions outside of the authorized frequency band

7.4. Test result

| EUT Set Mode | CH or Frequency | Measured Range | Verdict |
|--------------|-----------------|-----------------------|---------|
| GFSK | CH0 | 2.300 GHz - 2.405 GHz | Pass |
| | CH39 | 2.470 GHz - 2.550 GHz | Pass |

7.5. Original test data

Left side:

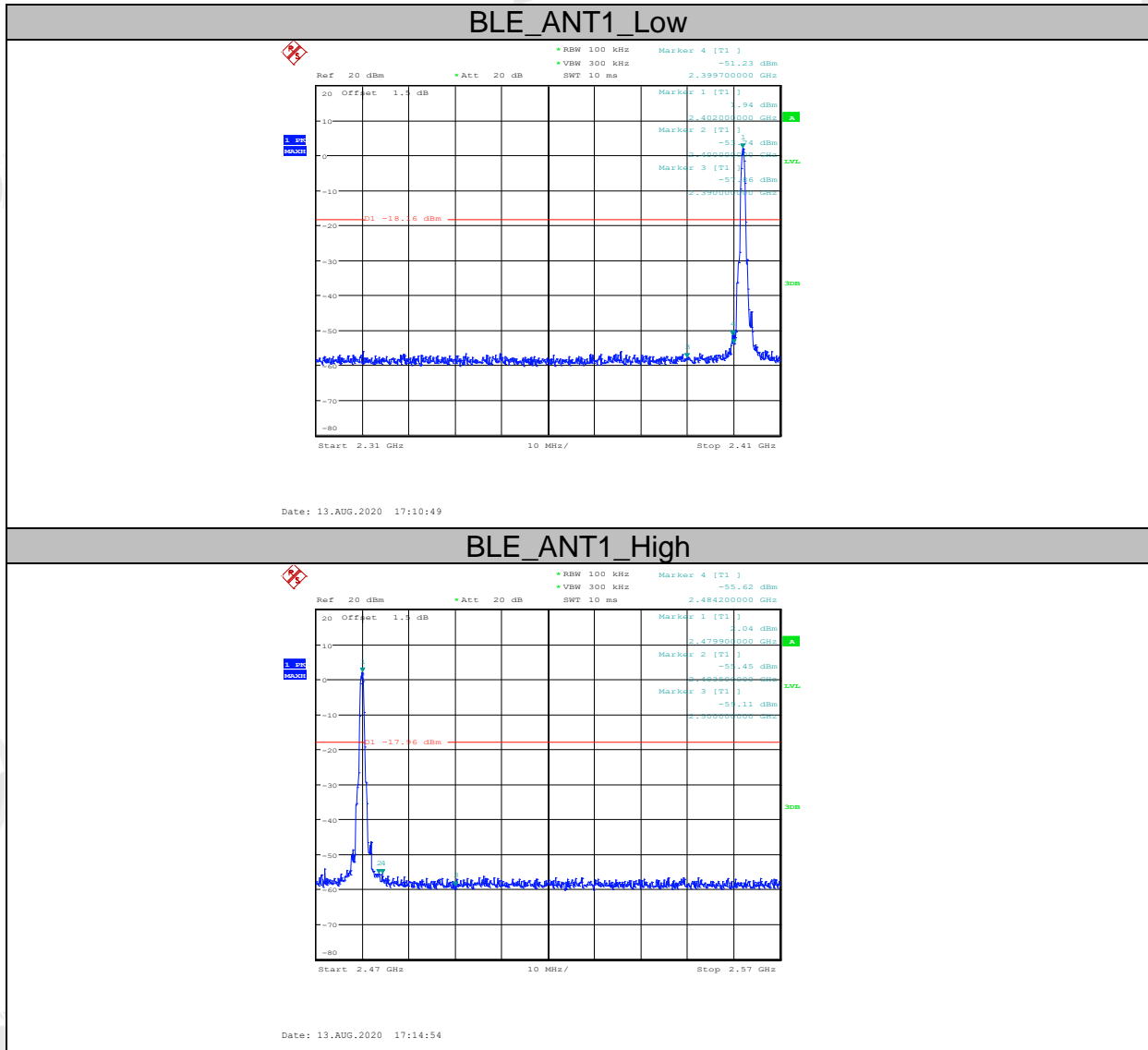

Right side:

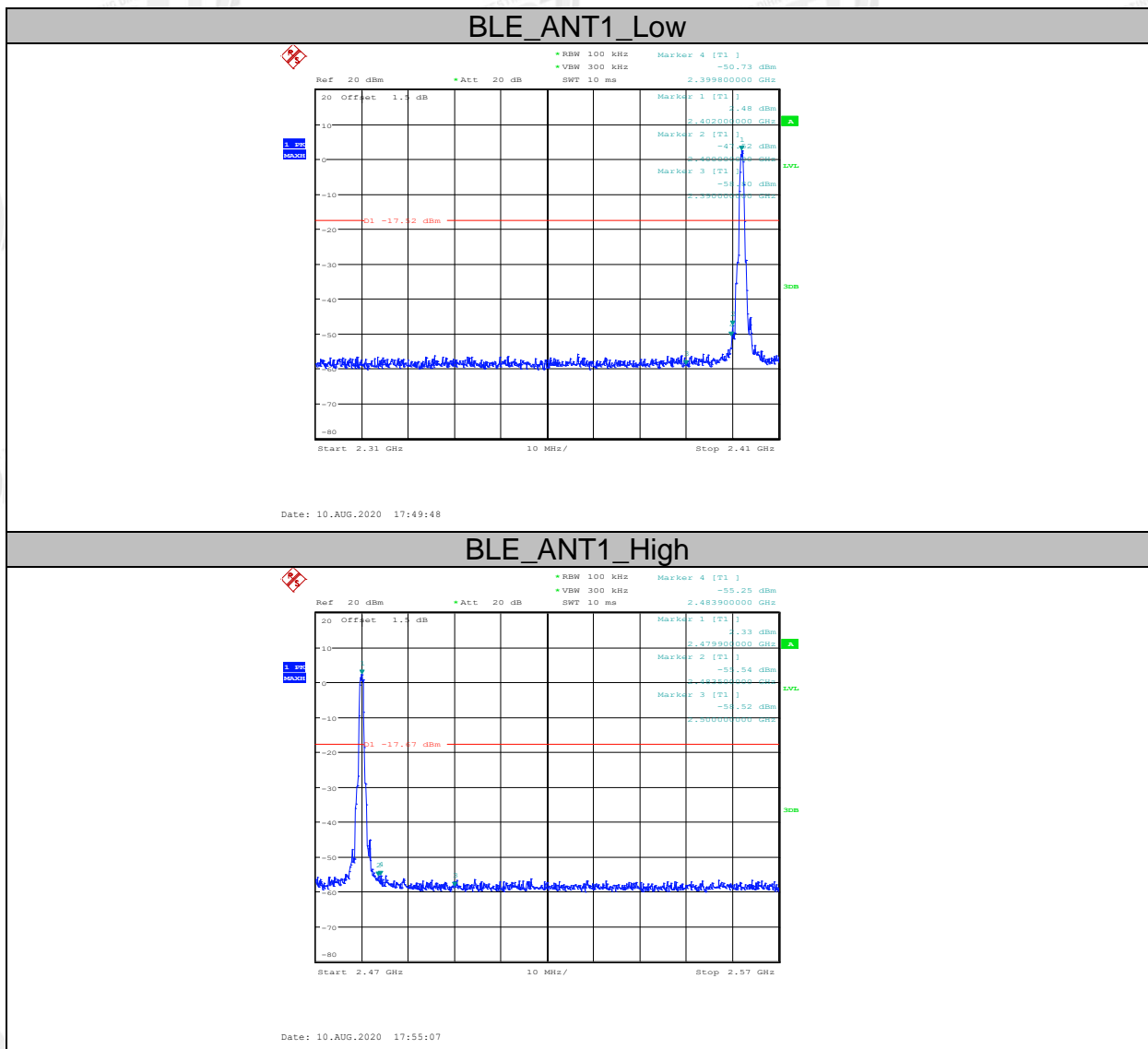

8. Radiated Emission

8.1. Block diagram of test setup

In 3 m Anechoic Chamber, test setup diagram for 9 kHz - 30 MHz:

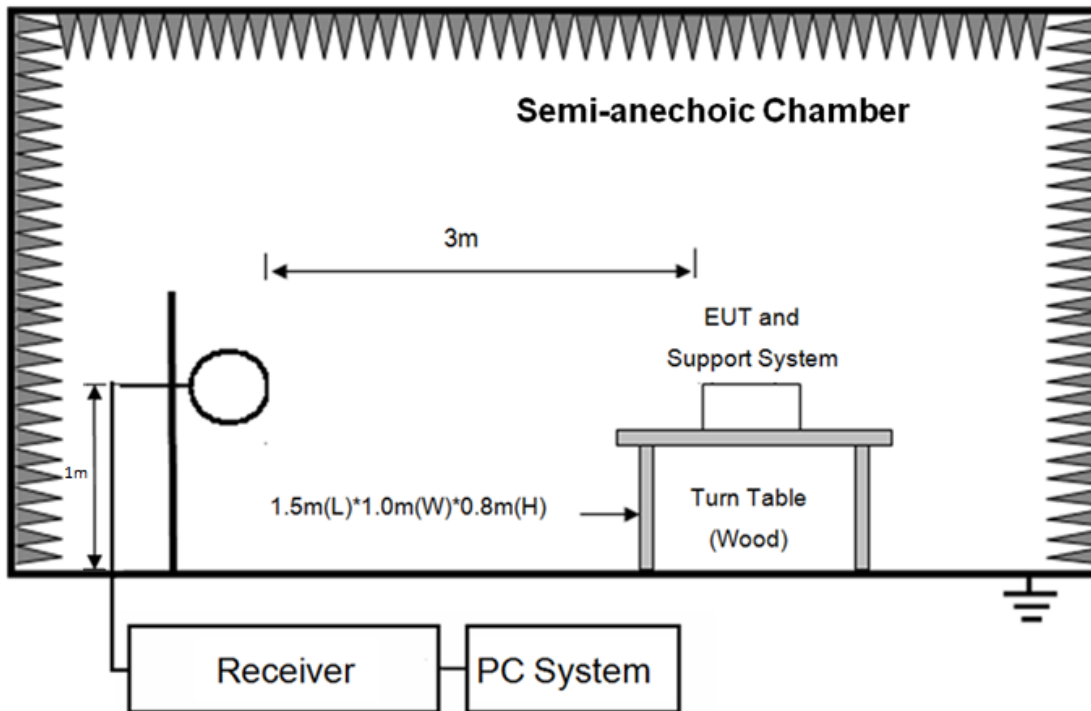

In 3 m Anechoic Chamber, test setup diagram for 30 MHz - 1 GHz:

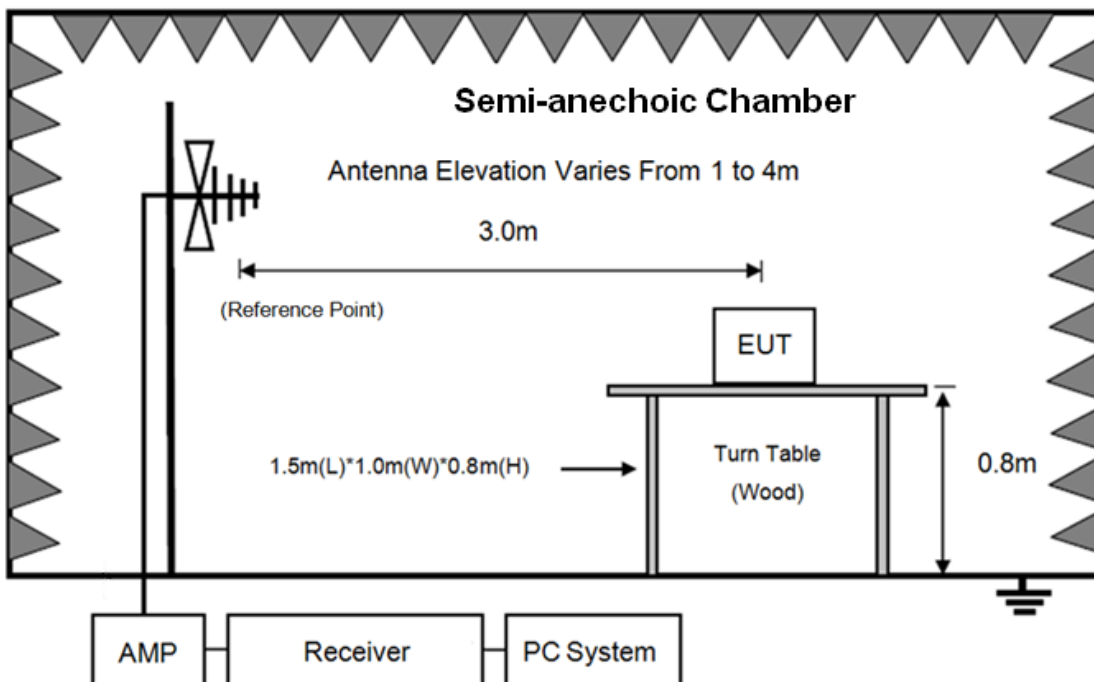

In 3 m Anechoic Chamber, test setup diagram for frequency above 1 GHz:

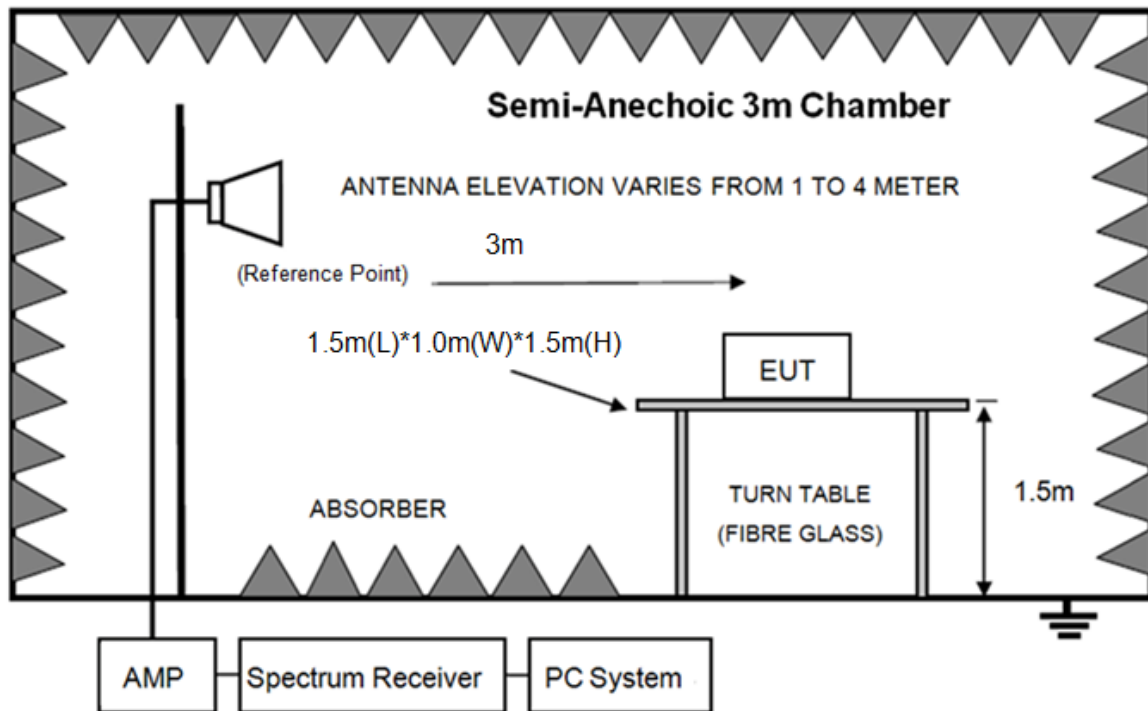

Note: For harmonic emissions test an appropriate high pass filter was inserted in the input port of AMP.

8.2. Limit

8.2.1 FCC 15.205 Restricted frequency band

| MHz | MHz | MHz | GHz |
|--------------------------|---------------------|---------------|------------------|
| 0.090-0.110 | 16.42-16.423 | 399.9-410 | 4.5-5.15 |
| ¹ 0.495-0.505 | 16.69475-16.69525 | 608-614 | 5.35-5.46 |
| 2.1735-2.1905 | 16.80425-16.80475 | 960-1240 | 7.25-7.75 |
| 4.125-4.128 | 25.5-25.67 | 1300-1427 | 8.025-8.5 |
| 4.1772&4.17775 | 37.5-38.25 | 1435-1626.5 | 9.0-9.2 |
| 4.2072&4.20775 | 73-74.6 | 1645.5-1646.5 | 9.3-9.5 |
| 6.215-6.218 | 74.8-75.2 | 1660-1710 | 10.6-12.7 |
| 6.26775-6.26825 | 108-121.94 | 1718.8-1722.2 | 13.25-13.4 |
| 6.31175-6.31225 | 123-138 | 2200-2300 | 14.47-14.5 |
| 8.291-8.294 | 149.9-150.05 | 2310-2390 | 15.35-16.2 |
| 8.362-8.366 | 156.52475-156.52525 | 2483.5-2500 | 17.7-21.4 |
| 8.37625-8.38675 | 156.7-156.9 | 2690-2900 | 22.01-23.12 |
| 8.41425-8.41475 | 162.0125-167.17 | 3260-3267 | 23.6-24.0 |
| 12.29-12.293 | 167.72-173.2 | 3332-3339 | 31.2-31.8 |
| 12.51975-12.52025 | 240-285 | 3345.8-3358 | 36.43-36.5 |
| 12.57675-12.57725 | 322-335.4 | 3600-4400 | (²) |
| 13.36-13.41 | | | |

¹Until February 1, 1999, this restricted band shall be 0.490-0.510 MHz.

²Above 38.6

8.2.2 FCC 15.209 Limit.

| FREQUENCY MHz | DISTANCE Meters | FIELD STRENGTHS LIMIT | |
|------------------|--------------------|---|-----------------------------------|
| | | $\mu\text{V}/\text{m}$ | $\text{dB}(\mu\text{V})/\text{m}$ |
| 0.009 ~ 0.490 | 300 | 2400/F(kHz) | 67.6-20log(F) |
| 0.490 ~ 1.705 | 30 | 24000/F(kHz) | 87.6-20log(F) |
| 1.705 ~ 30.0 | 30 | 30 | 29.54 |
| 30 ~ 88 | 3 | 100 | 40.0 |
| 88 ~ 216 | 3 | 150 | 43.5 |
| 216 ~ 960 | 3 | 200 | 46.0 |
| 960 ~ 1000 | 3 | 500 | 54.0 |
| Above 1000 | 3 | 74.0 $\text{dB}(\mu\text{V})/\text{m}$ (Peak) 54.0 $\text{dB}(\mu\text{V})/\text{m}$ (Average) | |

Note: (1) The emission limits shown in the above table are based on measurements employing a CISPR QP detector except for the frequency bands 9 - 90 kHz, 110 - 490 kHz and above 1000 MHz. Radiated emissions limits in these three bands are based on measurements employing an average detector.

(2) At frequencies below 30 MHz, measurement may be performed at a distance closer than that specified, and the limit at closer measurement distance can be extrapolated by below formula:

$$\text{Limit}_{3\text{m}}(\text{dB}\mu\text{V}/\text{m}) = \text{Limit}_{30\text{m}}(\text{dB}\mu\text{V}/\text{m}) + 40\text{Log}(30\text{m}/3\text{m})$$

8.2.3 Limit for this EUT

All the emissions appearing within 15.205 restricted frequency bands shall not exceed the limits shown in 15.209, all the other emissions shall be at least 20 dB below the fundamental emissions or comply with 15.209 limits.

8.3. Test Procedure

- (1) EUT was placed on a non-metallic table, 80 cm above the ground plane inside a semi-anechoic chamber for below 1 G and 150 cm above the ground plane inside a semi-anechoic chamber for above 1 G.
- (2) Test antenna was located 3 m from the EUT on an adjustable mast, and the antenna used as below table.

| Test frequency range | Test antenna used | Test antenna distance |
|----------------------|--|-----------------------|
| 9 kHz - 30 MHz | Active Loop antenna | 3 m |
| 30 MHz - 1 GHz | Trilog Broadband Antenna | 3 m |
| 1 GHz - 18 GHz | Double Ridged Horn Antenna (1 GHz - 18 GHz) | 3 m |
| 18 GHz - 40 GHz | Horn Antenna (18 GHz - 40 GHz) | 1 m |

According ANSI C63.10:2013 clause 6.4.4.2 and 6.5.3, for measurements below 30 MHz, the loop antenna was positioned with its plane vertical from the EUT and rotated about its vertical axis for maximum response at each azimuth position around the EUT. And the loop antenna also is positioned with its plane horizontal at the specified distance from the EUT. The center of the

loop is 1 m above the ground. For measurement above 30 MHz, the Trilog Broadband Antenna or Horn Antenna was located 3 m from EUT, Measurements were made with the antenna positioned in both the horizontal and vertical planes of Polarization, and the measurement antenna was varied from 1 m to 4 m. in height above the reference ground plane to obtain the maximum signal strength.

(3) Below pre-scan procedure was first performed in order to find prominent frequency spectrum radiated emissions from 9 kHz to 25 GHz:

(a) Scanning the peak frequency spectrum with the antenna specified in step (3), and the EUT was rotated 360 degree, the antenna height was varied from 1 m to 4 m (Except loop antenna, it's fixed 1 m above ground.)

(b) Change work frequency or channel of device if practicable.

(c) Change modulation type of device if practicable.

(d) Change power supply range from 85% to 115% of the rated supply voltage

(e) Rotated EUT though three orthogonal axes to determine the attitude of EUT arrangement produces highest emissions.

Spectrum frequency from 9 kHz to 25 GHz (tenth harmonic of fundamental frequency) was investigated, and no any obvious emission were detected from 9 kHz to 30 MHz and 18 GHz to 25 GHz, so below final test was performed with frequency range from 30 MHz to 18 GHz.

(4) For final emissions measurements at each frequency of interest, the EUT was rotated and the antenna height was varied between 1 m and 4 m in order to maximize the emission. Measurements in both horizontal and vertical polarities were made and the data was recorded. In order to find the maximum emission, the relative positions of equipments and all of the interface cables were changed according to ANSI C63.10:2013 on Radiated Emission test.

(5) The emissions from 9 kHz to 1 GHz were measured based on CISPR QP detector except for the frequency bands 9 - 90 kHz, 110 - 490 kHz, for emissions from 9 kHz - 90 kHz, 110 kHz - 490 kHz and above 1 GHz were measured based on average detector, for emissions above 1 GHz, peak emissions also be measured and need comply with Peak limit.

(6) The emissions from 9 kHz to 1 GHz, QP or average values were measured with EMI receiver with below RBW

| Frequency band | RBW |
|------------------|---------|
| 9 kHz - 150 kHz | 200 Hz |
| 150 kHz - 30 MHz | 9 kHz |
| 30 MHz - 1 GHz | 120 kHz |

(7) For emissions above 1 GHz, both Peak and Average level were measured with Spectrum Analyzer, and the RBW is set at 1 MHz, VBW is set at 3 MHz for Peak measure; According ANSI C63.10:2013 clause 4.1.4.2.2 procedure for average measure.

(8) X axis, Y axis, Z axis are tested, and worse setup X axis is reported.

8.4. Test result

Pass. (See below detailed test result)

All the emissions except fundamental emission from 9 kHz to 25 GHz were comply with 15.209 limit.

Note1: According exploratory test, the emission levels are 20 dB below the limit detected from 9 kHz to 30 MHz and 18 GHz to 25 GHz, so the final test was performed with frequency range from 30 MHz to 18 GHz and recorded in below.

Note2: For emissions below 1 GHz, according exploratory explorer test, when change Tx mode and channel, have no distinct influence on emissions level, so for emissions below 1 GHz, the final test was only performed with EUT working in right side GFSK, Tx 2440 MHz mode.

Note3: For emissions above 1 GHz. If peak results comply with AV limit, AV Result is deemed to comply with AV limit.

Radiated Emission test (below 1 GHz) TR-4-E-009 Radiated Emission Test Result

Test Site : DDT 3m Chamber 1# D:\2020 RE 1# Report data\Q20063026-1E\FCC BELOW 1G.EM6
Test Date : 2020-08-13 **Tested By** : Kennys
EUT : BLUETOOTH HEADSET **Model Number** : LIVE PRO+ TWS
Power Supply : Battery **Test Mode** : Tx mode
Condition : Temp:24.5°C,Humi:45%,Press:101.3kPa **Antenna/Distance** : 2019 VULB 9163 1#/3m/VERTICAL
Memo :

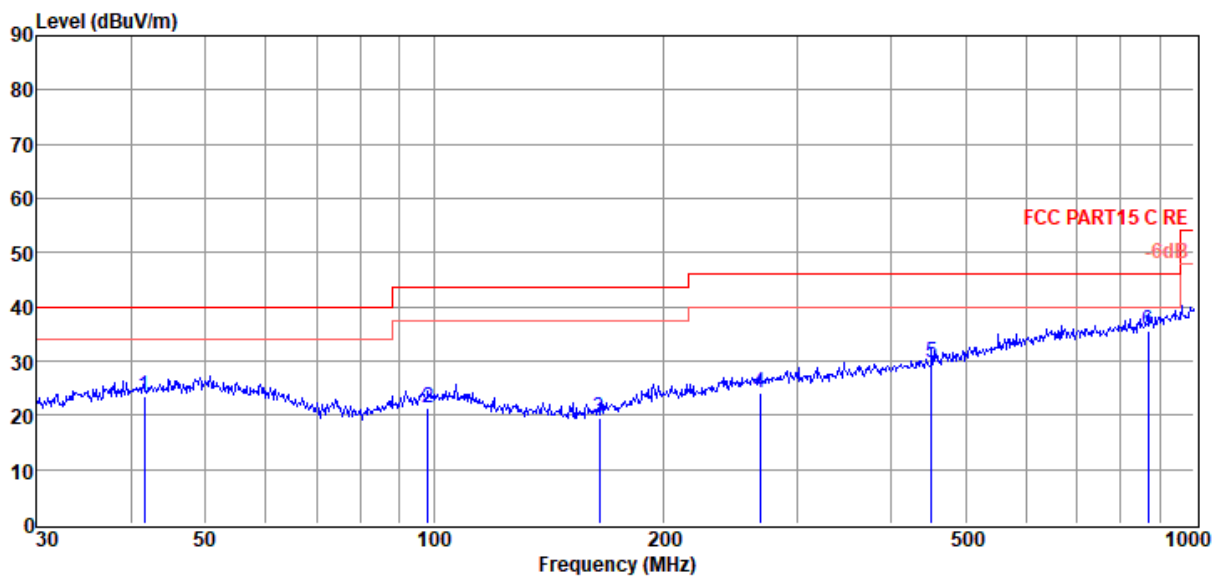

| Item (Mark) | Freq. (MHz) | Read Level (dBμV) | Antenna Factor (dB/m) | Cable Loss (dB) | Result Level (dBμV/m) | Limit Line (dBμV/m) | Over Limit (dB) | Detector | Polarization |
|-------------|-------------|-------------------|-----------------------|-----------------|-----------------------|---------------------|-----------------|----------|--------------|
| 1 | 41.57 | 5.92 | 13.79 | 3.92 | 23.63 | 40.00 | -16.37 | QP | VERTICAL |
| 2 | 98.14 | 5.29 | 11.72 | 4.40 | 21.41 | 43.50 | -22.09 | QP | VERTICAL |
| 3 | 164.91 | 5.62 | 8.95 | 4.84 | 19.41 | 43.50 | -24.09 | QP | VERTICAL |
| 4 | 268.49 | 5.52 | 13.36 | 5.38 | 24.26 | 46.00 | -21.74 | QP | VERTICAL |
| 5 | 451.14 | 7.08 | 16.32 | 6.16 | 29.56 | 46.00 | -16.44 | QP | VERTICAL |
| 6 | 869.13 | 6.56 | 21.47 | 7.59 | 35.62 | 46.00 | -10.38 | QP | VERTICAL |

- Note: 1. Result Level = Read Level + Antenna Factor + Cable loss.
 2. If Peak Result complies with QP limit, QP Result is deemed to comply with QP limit.
 3. Test setup: RBW: 120 kHz, VBW: 300 kHz, Sweep time: auto.

TR-4-E-009 Radiated Emission Test Result

Test Site : DDT 3m Chamber 1#

D:\2020 RE 1# Report data\Q20063026-1\FCC BELOW
1G.EM6

Test Date : 2020-08-13

Tested By : Kennys

EUT : BLUETOOTH HEADSET

Model Number : LIVE PRO+ TWS

Power Supply : Battery

Test Mode : Tx mode

Condition : Temp:24.5°C,Humi:45%,Press:101.3kPa

Antenna/Distance : 2019 VULB 9163 1#/3m/HORIZONTAL

Memo :

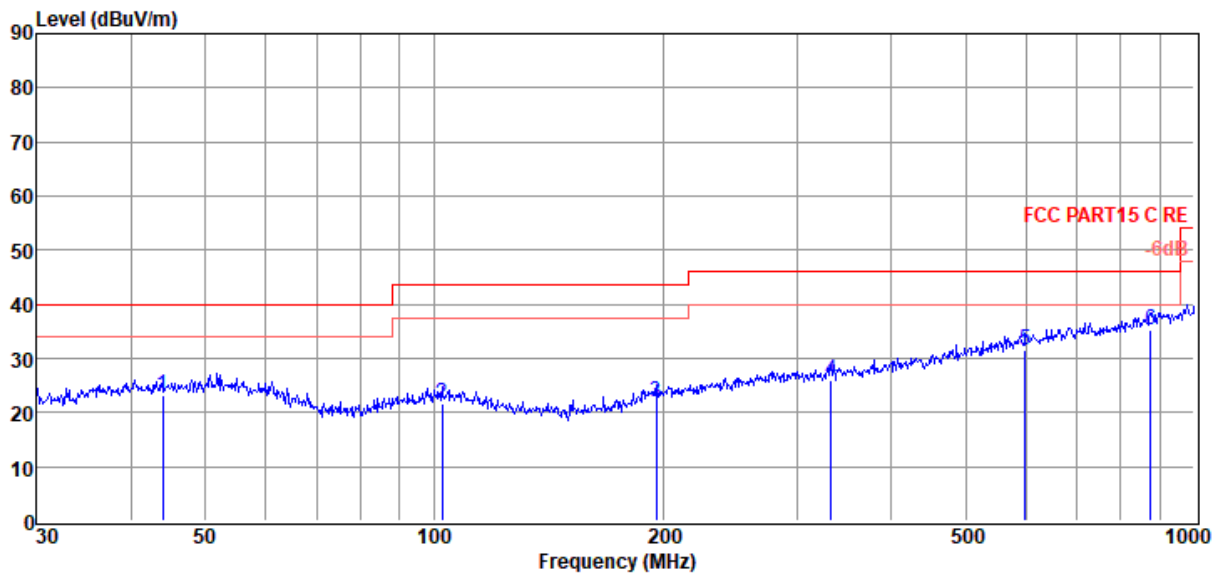

| Item (Mark) | Freq. (MHz) | Read Level (dBμV) | Antenna Factor (dB/m) | Cable Loss dB | Result Level (dBμV/m) | Limit Line (dBμV/m) | Over Limit (dB) | Detector | Polarization |
|----------------|----------------|-------------------------|-----------------------------|---------------------|-----------------------------|---------------------------|-----------------------|----------|--------------|
| 1 | 43.97 | 5.36 | 13.91 | 3.94 | 23.21 | 40.00 | -16.79 | QP | HORIZONTAL |
| 2 | 102.36 | 5.59 | 11.75 | 4.43 | 21.77 | 43.50 | -21.73 | QP | HORIZONTAL |
| 3 | 195.82 | 5.66 | 11.28 | 5.01 | 21.95 | 43.50 | -21.55 | QP | HORIZONTAL |
| 4 | 332.52 | 5.70 | 14.53 | 5.68 | 25.91 | 46.00 | -20.09 | QP | HORIZONTAL |
| 5 | 599.32 | 5.59 | 19.19 | 6.74 | 31.52 | 46.00 | -14.48 | QP | HORIZONTAL |
| 6 | 875.25 | 6.14 | 21.54 | 7.61 | 35.29 | 46.00 | -10.71 | QP | HORIZONTAL |

Note: 1. Result Level = Read Level + Antenna Factor + Cable loss.

2. If Peak Result complies with QP limit, QP Result is deemed to comply with QP limit.

3. Test setup: RBW: 120 kHz, VBW: 300 kHz, Sweep time: auto.

Radiated Emission test (above 1 GHz)

| Freq. (MHz) | Read level (dB μ V) | Antenna Factor (dB/m) | PRM Factor (dB) | Cable Loss (dB) | Result Level (dB μ V/m) | Limit (dB μ V/m) | Margin (dB) | Detector type | Polarization |
|------------------|-------------------------|-----------------------|-----------------|-----------------|-----------------------------|----------------------|-------------|---------------|--------------|
| Tx mode 2402 MHz | | | | | | | | | |
| 5114.00 | 47.43 | 32.55 | 43.38 | 6.35 | 42.95 | 74.00 | -31.05 | Peak | HORIZONTAL |
| 7630.00 | 44.98 | 37.48 | 42.85 | 8.27 | 47.88 | 74.00 | -26.12 | Peak | HORIZONTAL |
| 10129.00 | 45.70 | 39.68 | 42.39 | 9.37 | 52.36 | 74.00 | -21.64 | Peak | HORIZONTAL |
| 11965.00 | 44.92 | 39.14 | 42.30 | 10.51 | 52.27 | 74.00 | -21.73 | Peak | HORIZONTAL |
| 14039.00 | 42.25 | 40.89 | 40.30 | 10.96 | 53.80 | 74.00 | -20.20 | Peak | HORIZONTAL |
| 15450.00 | 41.90 | 39.10 | 40.15 | 11.59 | 52.44 | 74.00 | -21.56 | Peak | HORIZONTAL |
| 5284.00 | 46.77 | 32.61 | 43.32 | 6.47 | 42.53 | 74.00 | -31.47 | Peak | VERTICAL |
| 7545.00 | 45.04 | 37.36 | 42.86 | 8.18 | 47.72 | 74.00 | -26.28 | Peak | VERTICAL |
| 9959.00 | 44.66 | 39.47 | 42.41 | 9.35 | 51.07 | 74.00 | -22.93 | Peak | VERTICAL |
| 11421.00 | 44.73 | 39.81 | 42.33 | 9.83 | 52.04 | 74.00 | -21.96 | Peak | VERTICAL |
| 13155.00 | 43.65 | 39.82 | 41.11 | 10.73 | 53.09 | 74.00 | -20.91 | Peak | VERTICAL |
| 15824.00 | 42.65 | 38.61 | 40.12 | 11.54 | 52.68 | 74.00 | -21.32 | Peak | VERTICAL |
| Tx mode 2440 MHz | | | | | | | | | |
| 4519.00 | 47.43 | 31.83 | 43.59 | 5.99 | 41.66 | 74.00 | -32.34 | Peak | HORIZONTAL |
| 6406.00 | 46.77 | 34.91 | 43.03 | 7.21 | 45.86 | 74.00 | -28.14 | Peak | HORIZONTAL |
| 9925.00 | 44.82 | 39.44 | 42.41 | 9.32 | 51.17 | 74.00 | -22.83 | Peak | HORIZONTAL |
| 11506.00 | 45.11 | 39.69 | 42.32 | 9.93 | 52.41 | 74.00 | -21.59 | Peak | HORIZONTAL |
| 13155.00 | 43.52 | 39.82 | 41.11 | 10.73 | 52.96 | 74.00 | -21.04 | Peak | HORIZONTAL |
| 15280.00 | 41.77 | 39.44 | 40.17 | 11.61 | 52.65 | 74.00 | -21.35 | Peak | HORIZONTAL |
| 5131.00 | 47.01 | 32.55 | 43.37 | 6.36 | 42.55 | 74.00 | -31.45 | Peak | VERTICAL |
| 7290.00 | 44.48 | 37.17 | 42.90 | 7.89 | 46.64 | 74.00 | -27.36 | Peak | VERTICAL |
| 9551.00 | 44.76 | 39.14 | 42.48 | 9.03 | 50.45 | 74.00 | -23.55 | Peak | VERTICAL |
| 11744.00 | 45.42 | 39.41 | 42.31 | 10.23 | 52.75 | 74.00 | -21.25 | Peak | VERTICAL |
| 13529.00 | 42.61 | 40.33 | 40.74 | 10.82 | 53.02 | 74.00 | -20.98 | Peak | VERTICAL |
| 15960.00 | 43.04 | 38.45 | 40.10 | 11.53 | 52.92 | 74.00 | -21.08 | Peak | VERTICAL |
| Tx mode 2480 MHz | | | | | | | | | |
| 4519.00 | 47.43 | 31.83 | 43.59 | 5.99 | 41.66 | 74.00 | -32.34 | Peak | HORIZONTAL |
| 6406.00 | 46.77 | 34.91 | 43.03 | 7.21 | 45.86 | 74.00 | -28.14 | Peak | HORIZONTAL |
| 9551.00 | 44.82 | 39.14 | 42.48 | 9.03 | 50.51 | 74.00 | -23.49 | Peak | HORIZONTAL |
| 11506.00 | 45.11 | 39.69 | 42.32 | 9.93 | 52.41 | 74.00 | -21.59 | Peak | HORIZONTAL |
| 12985.00 | 44.09 | 39.57 | 41.28 | 10.69 | 53.07 | 74.00 | -20.93 | Peak | HORIZONTAL |
| 15671.00 | 43.37 | 38.79 | 40.13 | 11.56 | 53.59 | 74.00 | -20.41 | Peak | HORIZONTAL |
| 4995.00 | 47.86 | 32.49 | 43.42 | 6.27 | 43.20 | 74.00 | -30.80 | Peak | VERTICAL |
| 7664.00 | 44.85 | 37.53 | 42.84 | 8.31 | 47.85 | 74.00 | -26.15 | Peak | VERTICAL |
| 9925.00 | 45.40 | 39.44 | 42.41 | 9.32 | 51.75 | 74.00 | -22.25 | Peak | VERTICAL |
| 11540.00 | 45.21 | 39.65 | 42.32 | 9.98 | 52.52 | 74.00 | -21.48 | Peak | VERTICAL |
| 13716.00 | 42.50 | 40.56 | 40.57 | 10.86 | 53.35 | 74.00 | -20.65 | Peak | VERTICAL |
| 15654.00 | 43.31 | 38.82 | 40.13 | 11.56 | 53.56 | 74.00 | -20.44 | Peak | VERTICAL |
| Verdict: Pass | | | | | | | | | |

Note: 1. Scan with all side, the worst case is right side recorded in this report.

2. Result Level = Read Level + Antenna Factor + Cable loss - PRM Factor.

3. For emissions above 1GHz. If peak results comply with AV limit, AV Result is deemed to comply with AV limit.

9. RF Conducted Spurious Emissions

9.1. Block diagram of test setup

Same as section 4.1

9.2. Limits

In any 100 kHz bandwidth outside the frequency bands in which the spread spectrum intentional radiator is operating, the radio frequency power that is produced by the intentional radiator shall be at least 20 dB below that in the 100 kHz bandwidth within the band that contains the highest level of the desired power.

9.3. Test procedure

(1) Connect EUT's antenna output to spectrum analyzer by RF cable.

(2) Establish a reference level by using the following procedure:

| | |
|------------------|---|
| Center frequency | Test frequency |
| RBW: | 100 kHz |
| VBW: | 300 kHz |
| Span | Wide enough to capture the peak level of the in-band emission |
| Detector Mode: | Peak |
| Sweep time: | auto |
| Trace mode | Max hold |

(3) Allow the trace to stabilize, use the peak marker function to determine the maximum peak power level to establish the reference level.

(4) Set the spectrum analyzer as follows:

| | |
|------------------------------|--|
| RBW: | 100 kHz |
| VBW: | 300 kHz |
| Span | Encompass frequency range to be measured |
| Number of measurement points | $\geq \text{span}/\text{RBW}$ |
| Detector Mode: | Peak |
| Sweep time: | auto |
| Trace mode | Max hold |

(5) Allow the trace to stabilize, use the peak marker function to determine the maximum amplitude of all unwanted emissions outside of the authorized frequency band

9.4. Test result

| Mode | Freq. (MHz) | Verdict |
|------|-------------|---------|
| GFSK | 2402 | Pass |
| | 2440 | Pass |
| | 2480 | Pass |

9.5. Original test data

Left side:

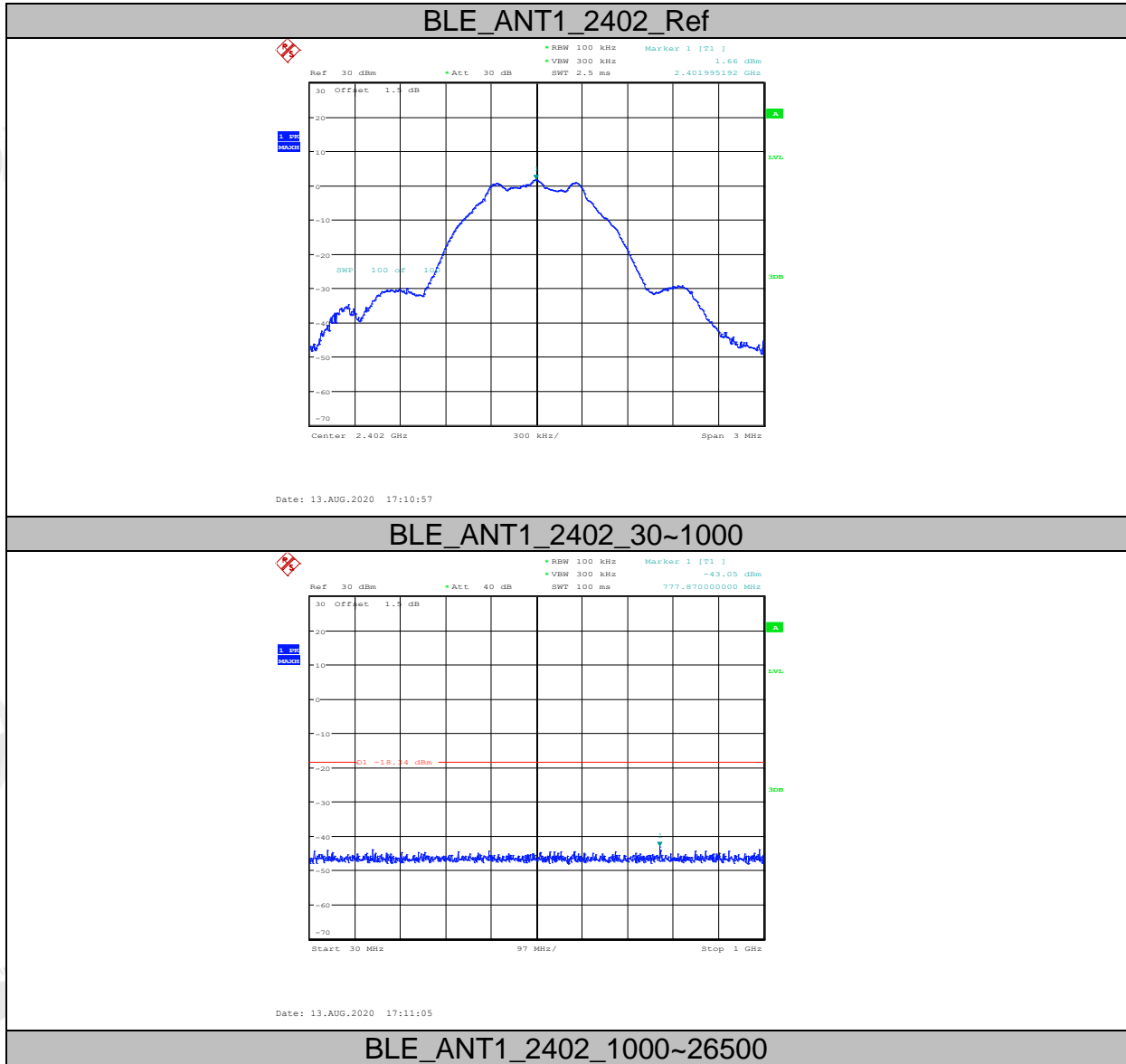

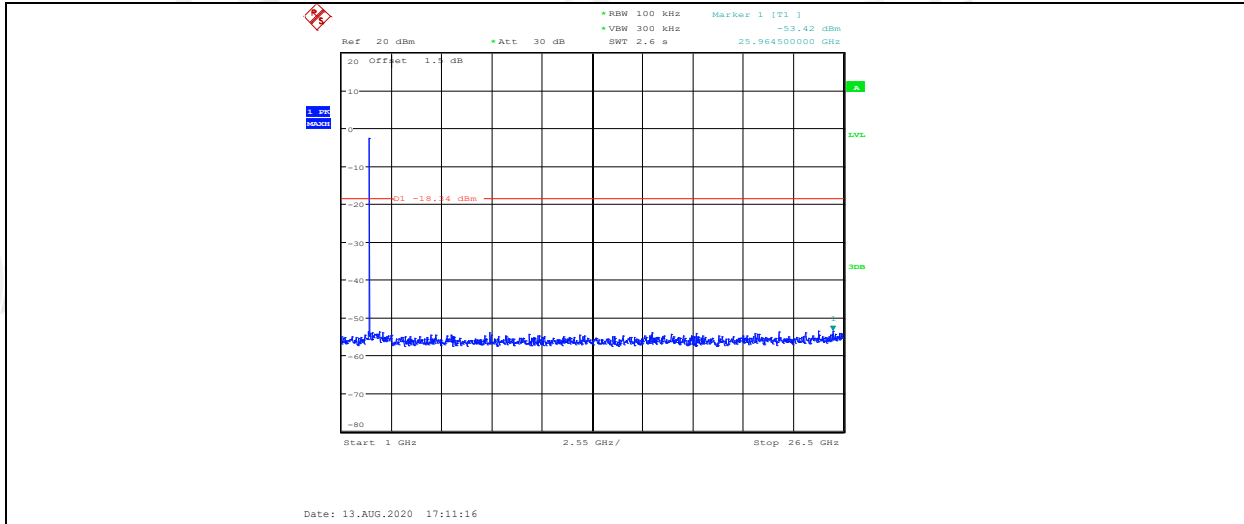

BLE_ANT1_2440_Ref

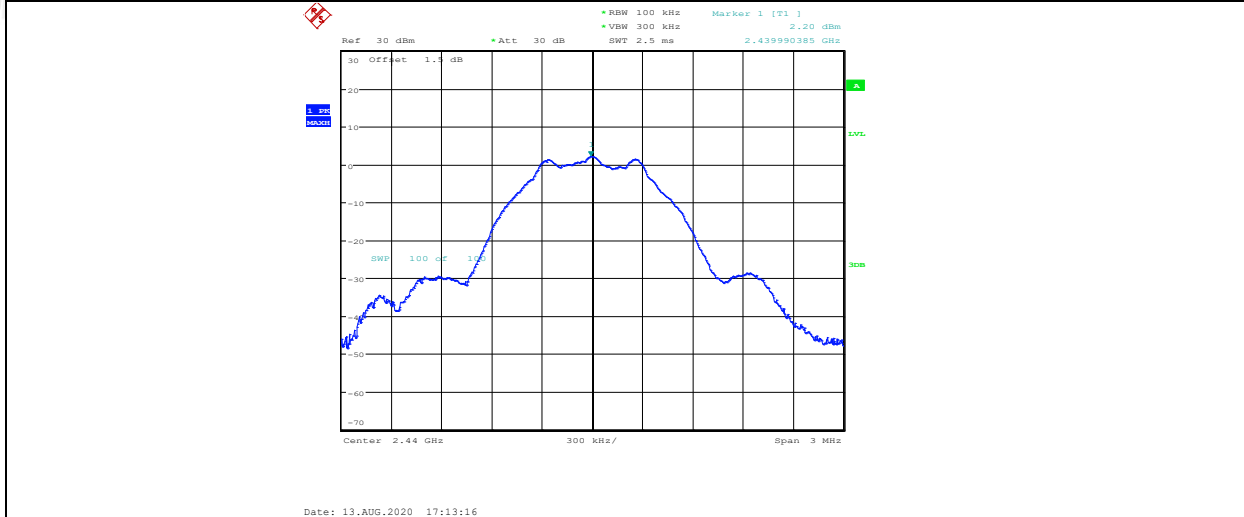

BLE_ANT1_2440_30~1000

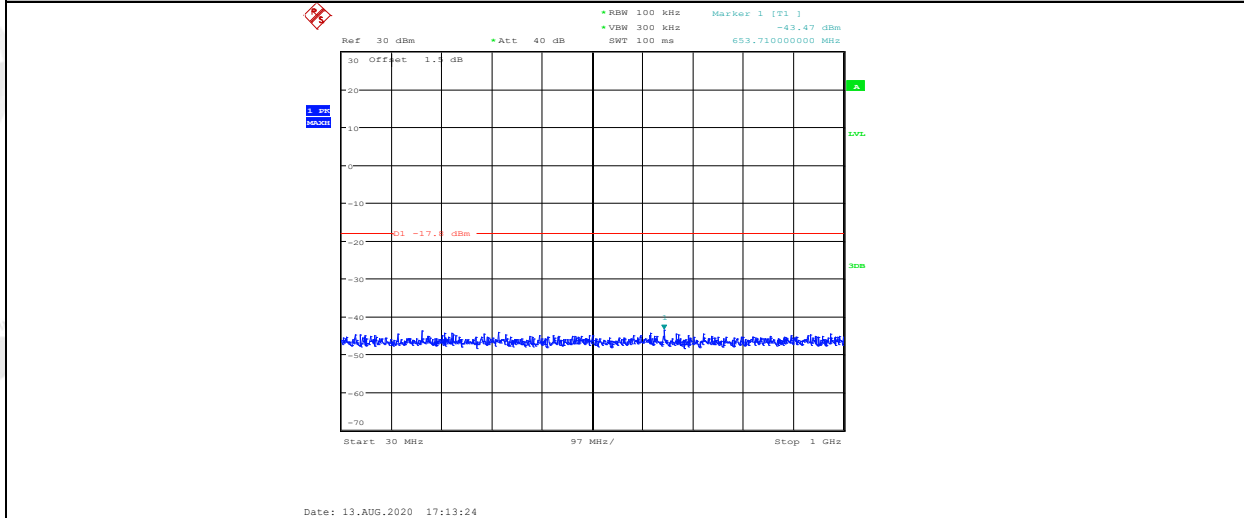

BLE_ANT1_2440_1000~26500

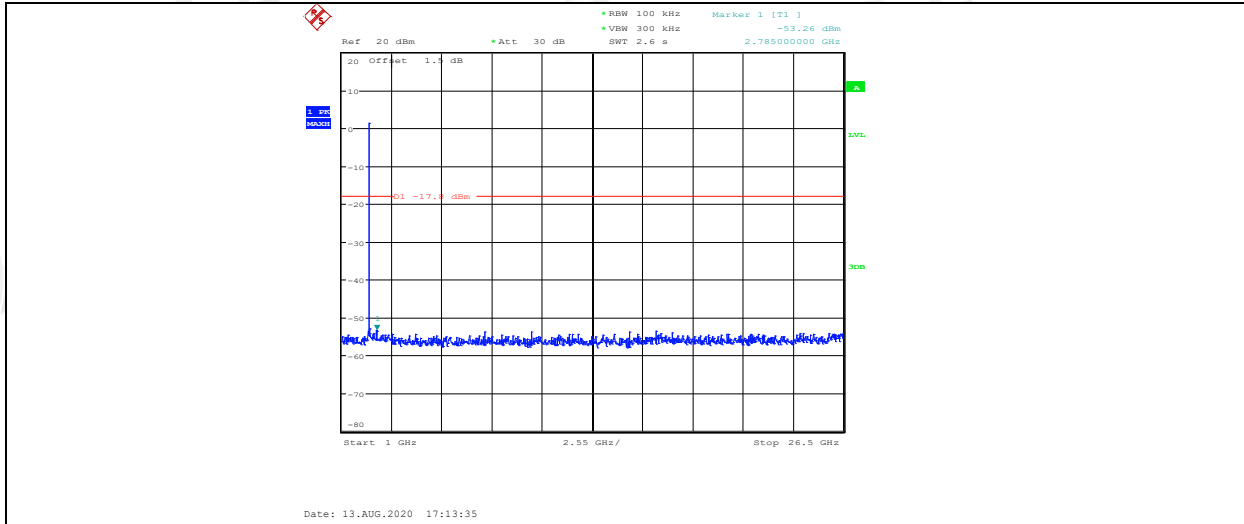

BLE_ANT1_2480_Ref

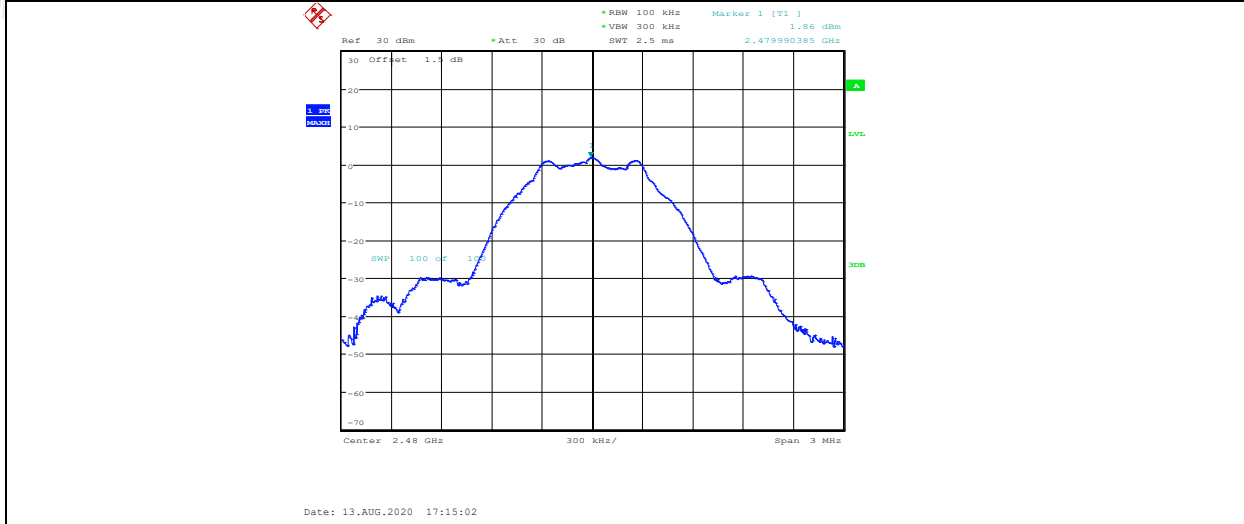

BLE_ANT1_2480_30~1000

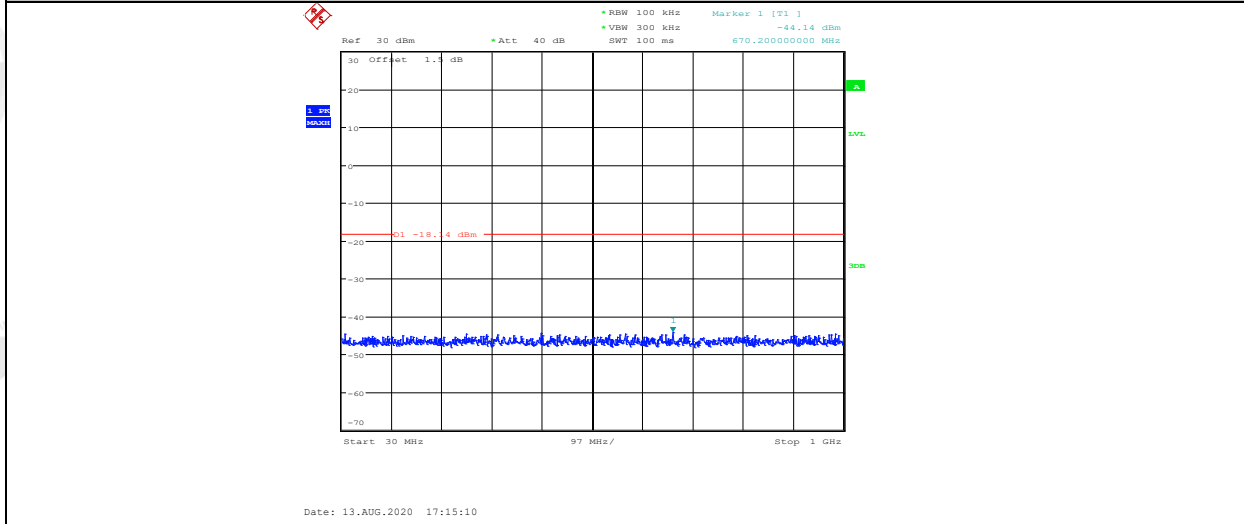

BLE_ANT1_2480_1000~26500

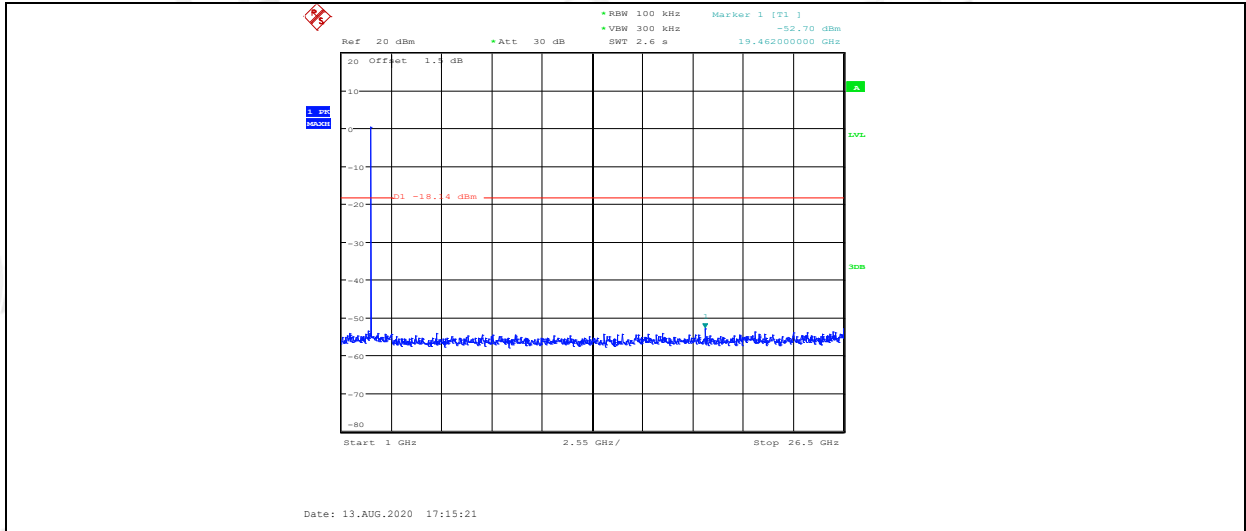

Right side:

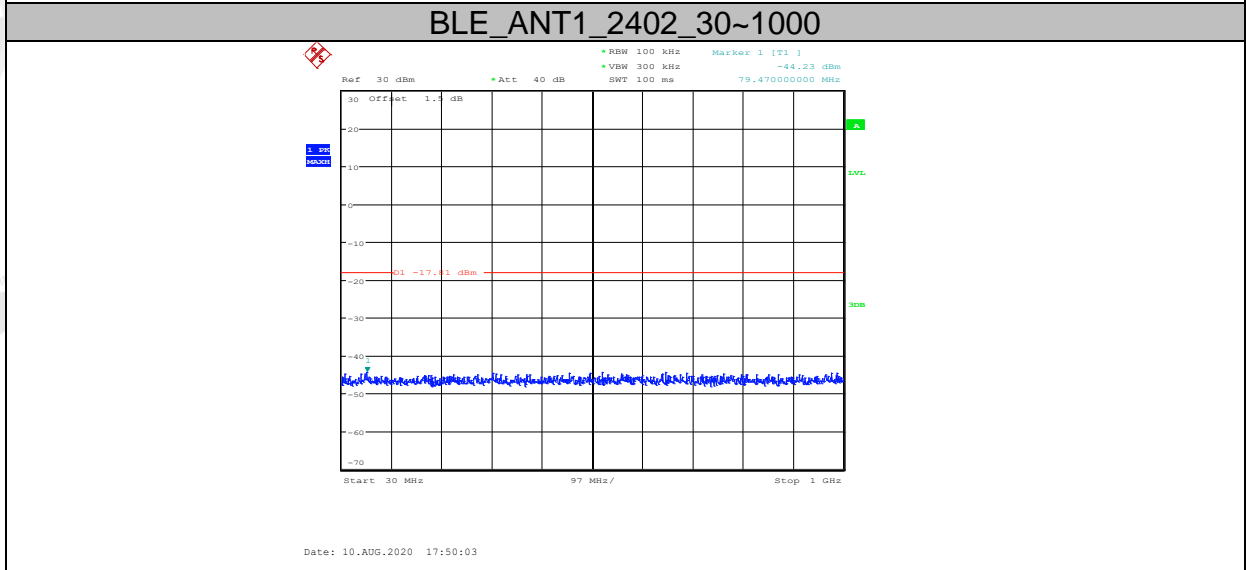
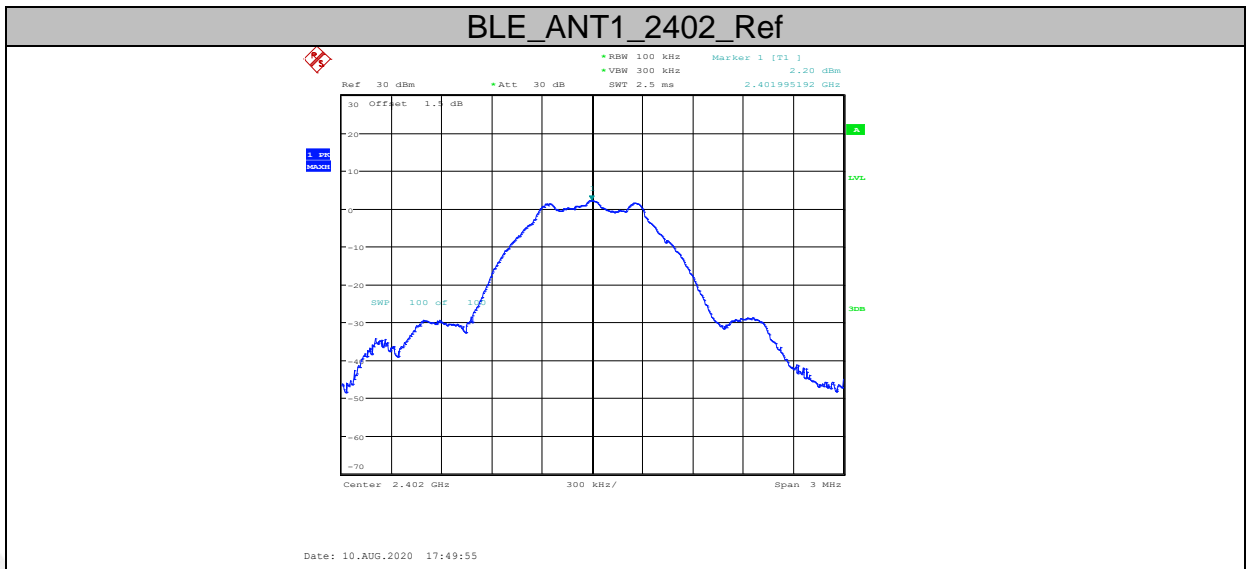

BLE_ANT1_2402_1000~26500

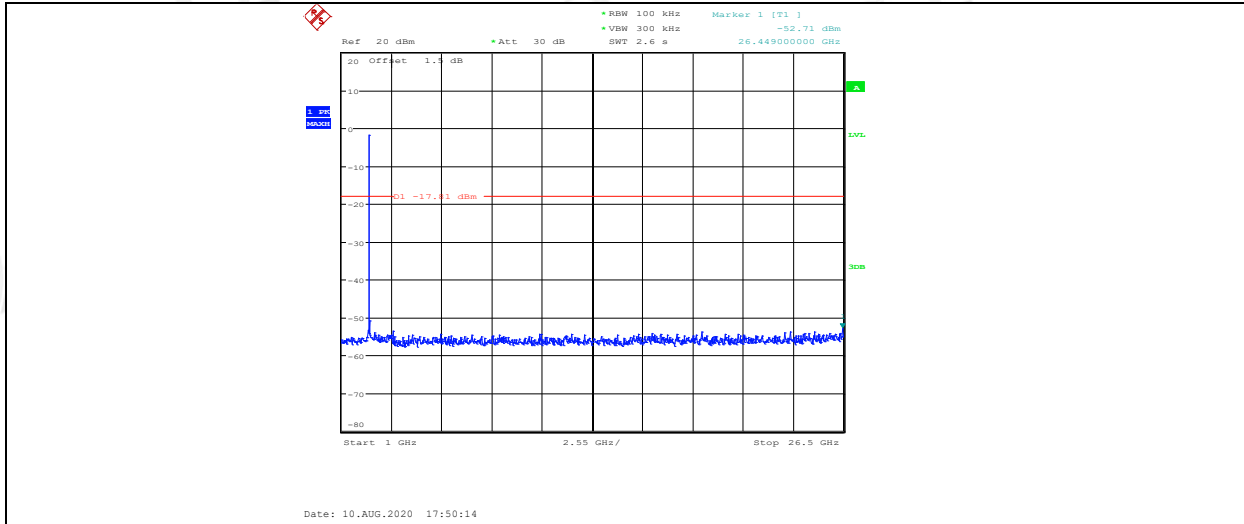

BLE_ANT1_2440_Ref

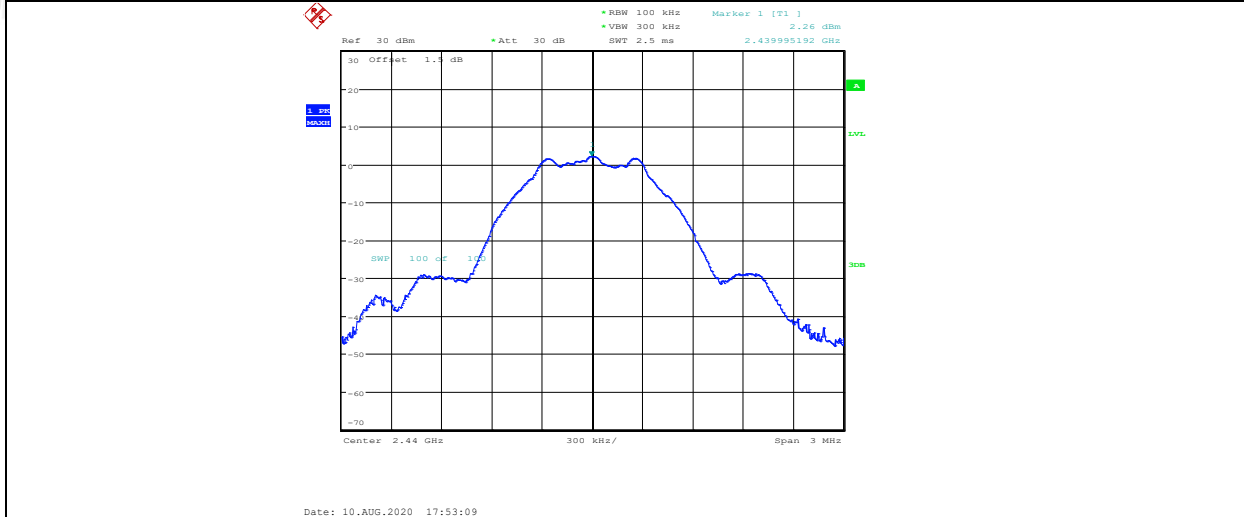

BLE_ANT1_2440_30~1000

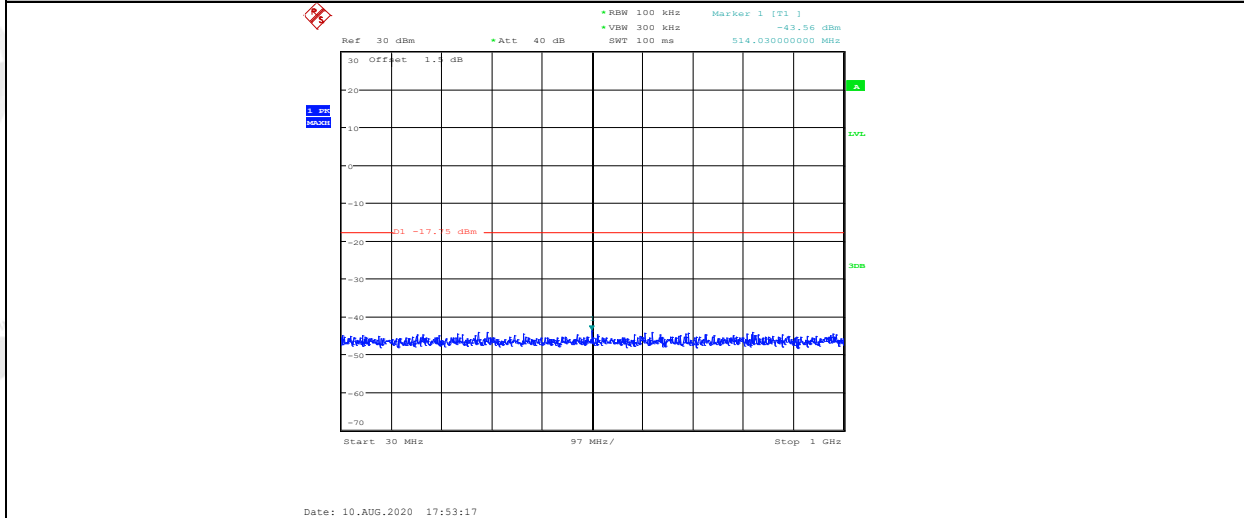

BLE_ANT1_2440_1000~26500

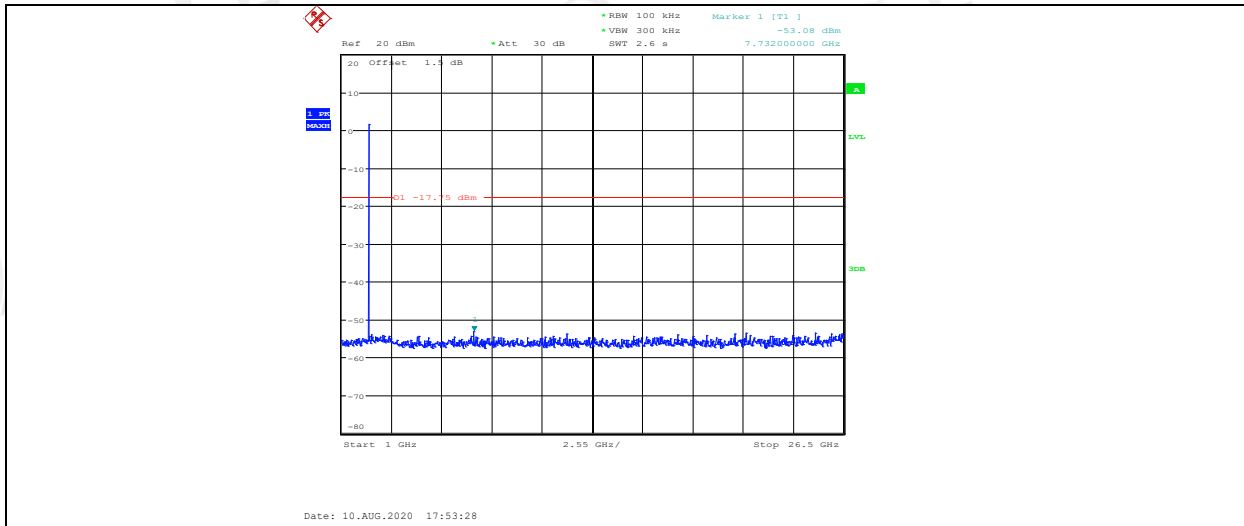

BLE_ANT1_2480_Ref

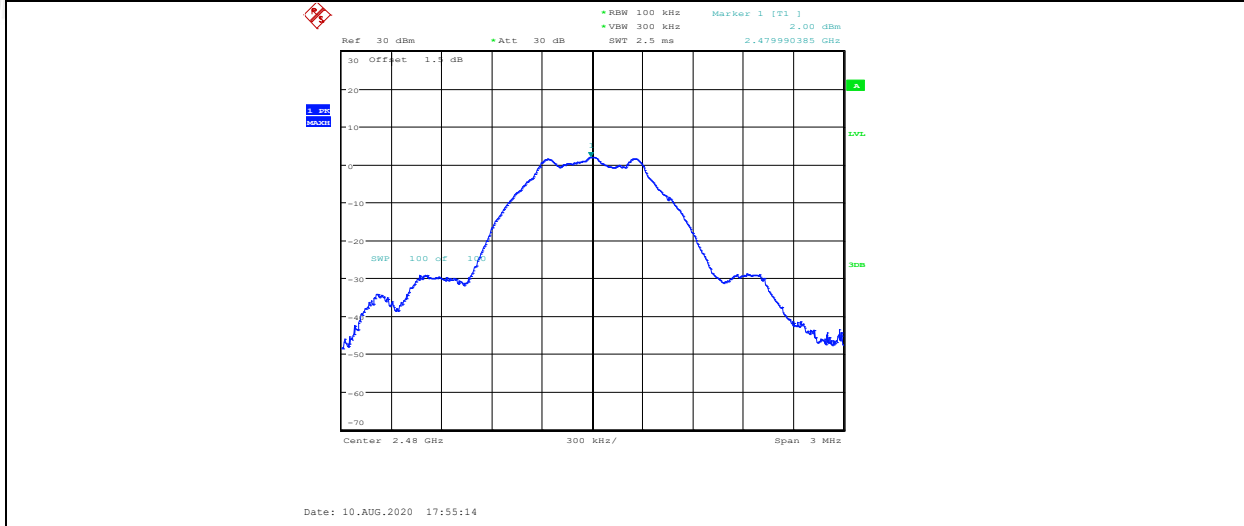

BLE_ANT1_2480_30~1000

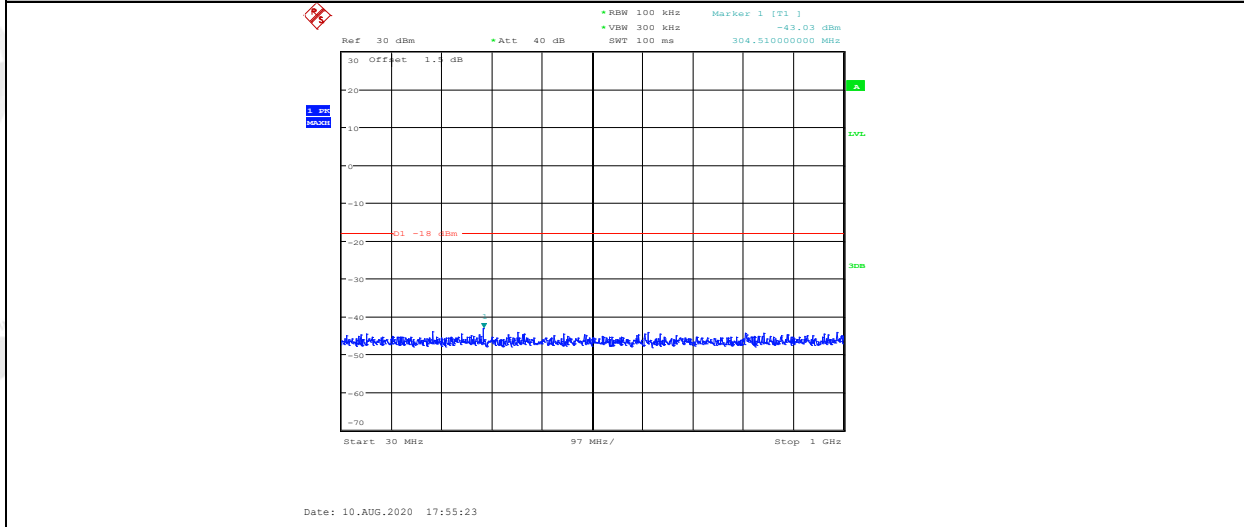

BLE_ANT1_2480_1000~26500

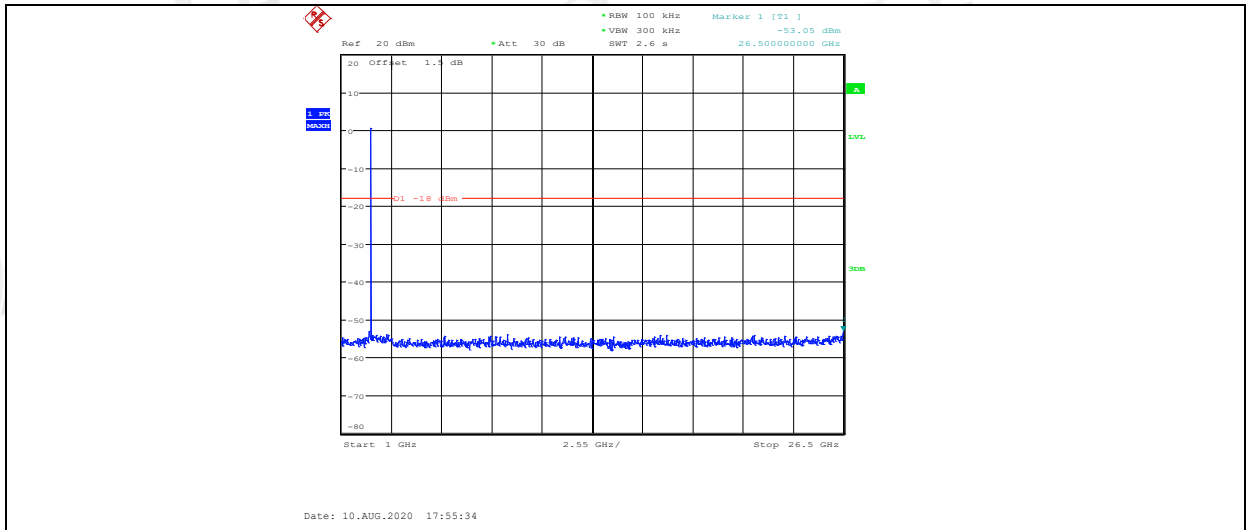

10. Emissions in Restricted Frequency Bands

10.1. Block diagram of test setup

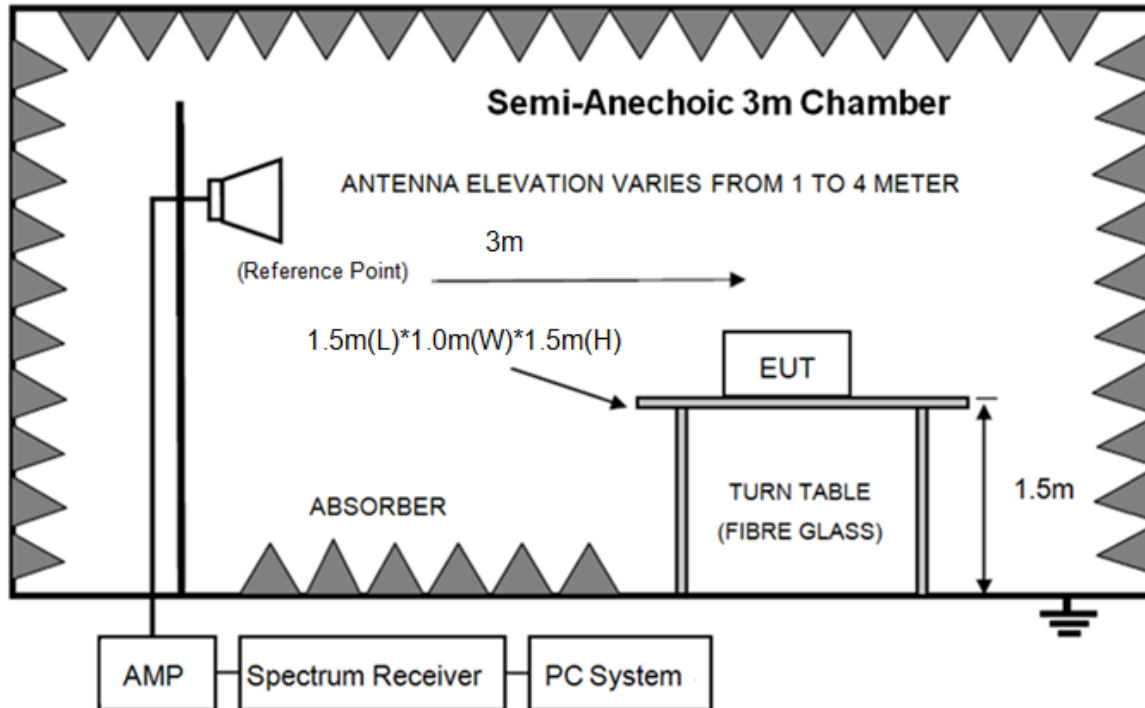

10.2. Limit

All restriction band should comply with 15.209, other emission should be at least 20 dB below the fundamental.

10.3. Test procedure

Same with clause 8.3 except change investigated frequency range from 2310 MHz to 2410 MHz and 2470 MHz to 2500 MHz.

Remark: All restriction band have been tested, and only the worst case is shown in report.

10.4. Test result

Pass. (See below detailed test result)

Note: Scan with all side, the worst case is left side recorded in this report.

TR-4-E-009 Radiated Emission Test Result

Test Site : DDT 3m Chamber 2#

D:\2020 RE2# Report Data\Q20063026-1E PRO TWS\FCC ABOVE1G.EM6

Test Date : 2020-08-11

Tested By : Talent

EUT : BLUETOOTH HEADSET

Model Number : LIVE PRO+ TWS

Power Supply : Battery

Test Mode : Tx mode

Condition : Temp:24.5°C,Humi:55%,Press:100.1kPa

Antenna/Distance : 2019 BBHA9120D/3m/VERTICAL

Memo : BLE 2402

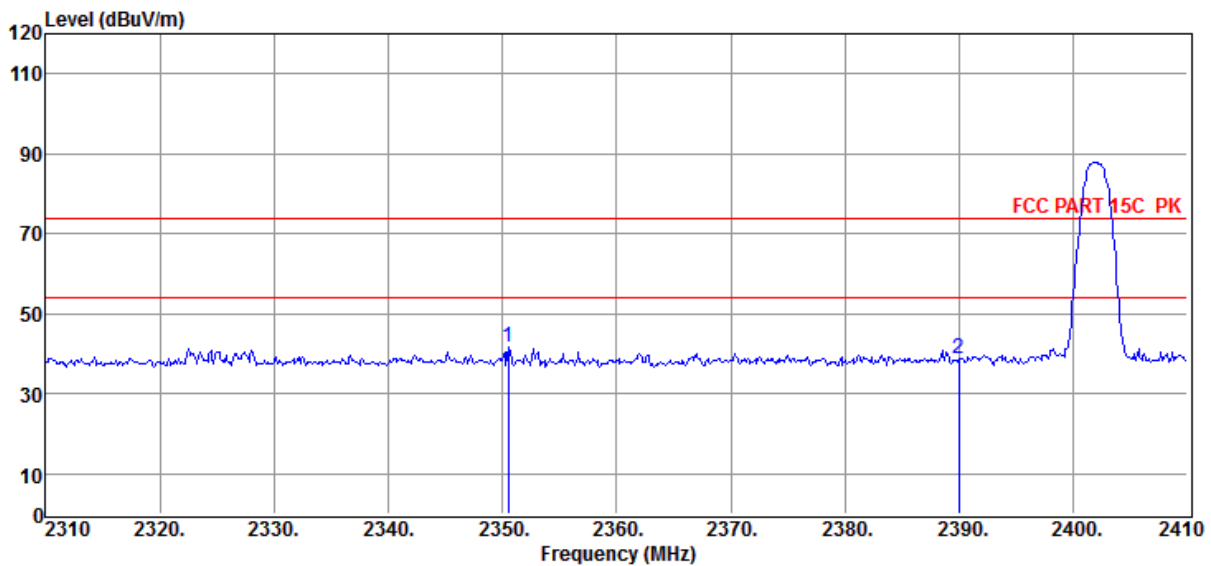

| Item (Mark) | Freq. (MHz) | Read Level (dBμV) | Antenna Factor (dB/m) | PRM Factor (dB) | Cable Loss (dB) | Result Level (dBμV/m) | Limit Line (dBμV/m) | Over Limit (dB) | Detector | Polarization |
|-------------|-------------|-------------------|-----------------------|-----------------|-----------------|-----------------------|---------------------|-----------------|----------|--------------|
| 1 | 2350.50 | 53.34 | 27.40 | 43.19 | 4.00 | 41.55 | 74.00 | -32.45 | Peak | VERTICAL |
| 2 | 2390.00 | 50.50 | 27.48 | 43.21 | 4.03 | 38.80 | 74.00 | -35.20 | Peak | VERTICAL |

Note: 1. Result Level = Read Level + Antenna Factor + Cable loss - PRM Factor.

2. If Peak Result complies with AV limit, AV Result is deemed to comply with AV limit.

3. Test setup: RBW: 1 MHz, VBW: 3 MHz, Sweep time: auto.

TR-4-E-009 Radiated Emission Test Result

Test Site : DDT 3m Chamber 2# **D:\2020 RE2# Report Data\Q20063026-1E PRO TWS\FCC ABOVE1G.EM6**
Test Date : 2020-08-11 **Tested By** : Talent
EUT : BLUETOOTH HEADSET **Model Number** : LIVE PRO+ TWS
Power Supply : Battery **Test Mode** : Tx mode
Condition : Temp:24.5°C,Humi:55%,Press:100.1kPa **Antenna/Distance** : 2019 BBHA9120D/3m/HORIZONTAL
Memo : BLE 2402

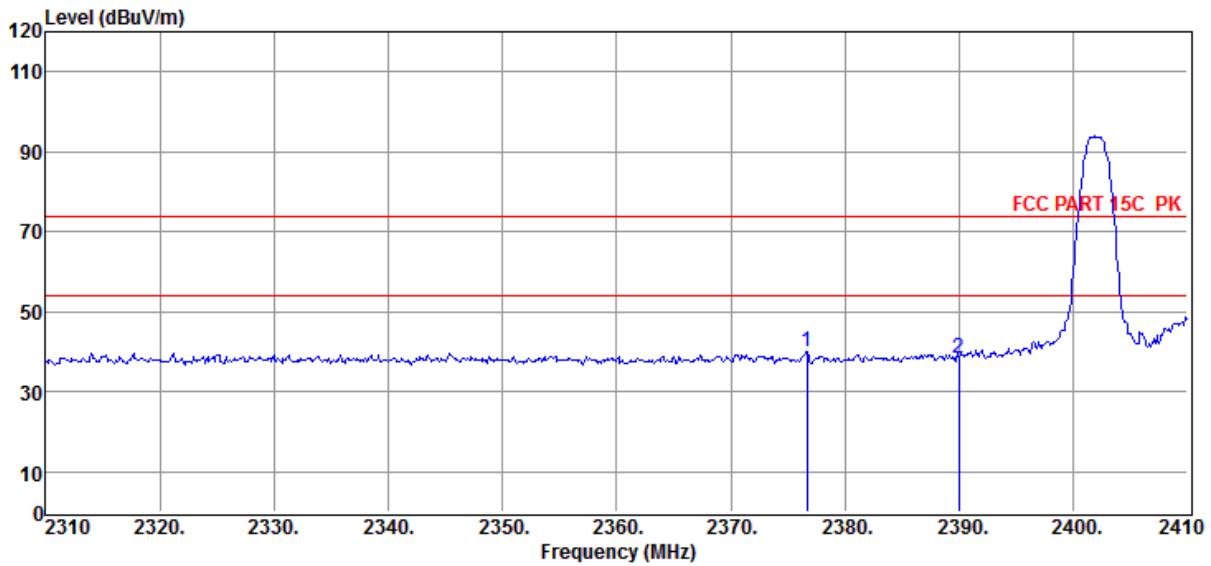

| Item (Mark) | Freq. (MHz) | Read Level (dBμV) | Antenna Factor (dB/m) | PRM Factor (dB) | Cable Loss (dB) | Result Level (dBμV/m) | Limit Line (dBμV/m) | Over Limit (dB) | Detector | Polarization |
|-------------|-------------|-------------------|-----------------------|-----------------|-----------------|-----------------------|---------------------|-----------------|----------|--------------|
| 1 | 2376.70 | 51.86 | 27.45 | 43.20 | 4.02 | 40.13 | 74.00 | -33.87 | Peak | HORIZONTAL |
| 2 | 2390.00 | 50.17 | 27.48 | 43.21 | 4.03 | 38.47 | 74.00 | -35.53 | Peak | HORIZONTAL |

Note: 1. Result Level = Read Level + Antenna Factor + Cable loss - PRM Factor.
 2. If Peak Result complies with AV limit, AV Result is deemed to comply with AV limit.
 3. Test setup: RBW: 1 MHz, VBW: 3 MHz, Sweep time: auto.

TR-4-E-009 Radiated Emission Test Result

Test Site : DDT 3m Chamber 2#

D:\2020 RE2# Report Data\Q20063026-1E PRO TWS\FCC ABOVE1G.EM6

Test Date : 2020-08-11

Tested By : Talent

EUT : BLUETOOTH HEADSET

Model Number : LIVE PRO+ TWS

Power Supply : Battery

Test Mode : Tx mode

Condition : Temp:24.5°C,Humi:55%,Press:100.1kPa

Antenna/Distance : 2019 BBHA9120D/3m/HORIZONTAL

Memo : BLE 2480

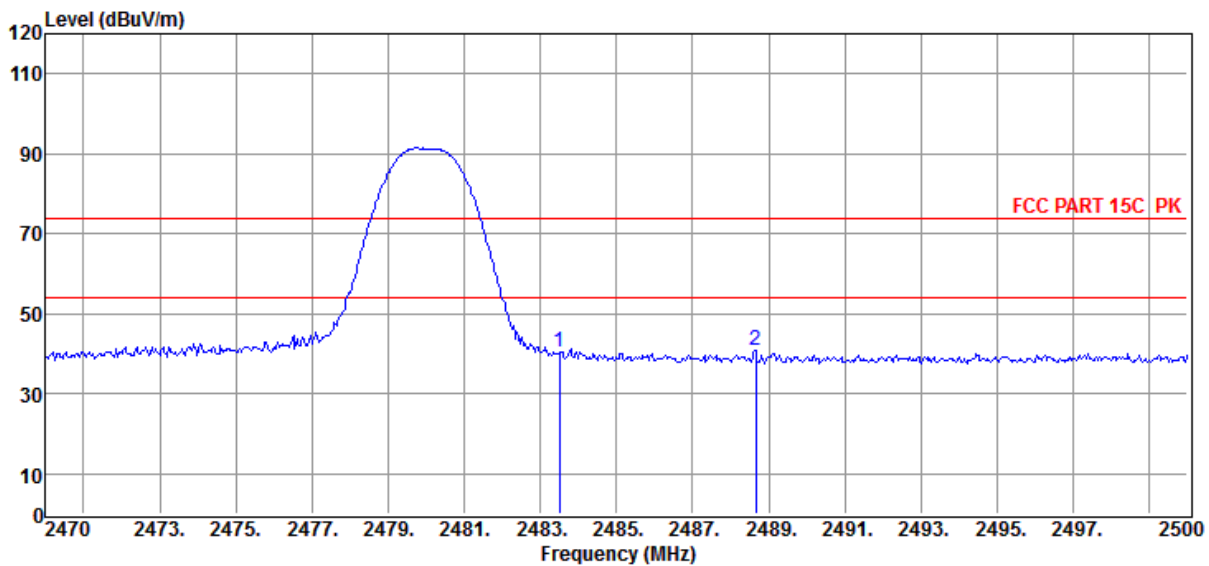

| Item (Mark) | Freq. (MHz) | Read Level (dB μ V) | Antenna Factor (dB/m) | PRM Factor dB | Cable Loss dB | Result Level (dB μ V/m) | Limit Line (dB μ V/m) | Over Limit (dB) | Detector | Polarization |
|----------------|----------------|-------------------------------|-----------------------------|---------------------|---------------------|-----------------------------------|---------------------------------|-----------------------|----------|--------------|
| 1 | 2483.50 | 51.82 | 27.67 | 43.25 | 4.12 | 40.36 | 74.00 | -33.64 | Peak | HORIZONTAL |
| 2 | 2488.66 | 52.10 | 27.68 | 43.25 | 4.13 | 40.66 | 74.00 | -33.34 | Peak | HORIZONTAL |

Note: 1. Result Level = Read Level + Antenna Factor + Cable loss - PRM Factor.

2. If Peak Result complies with AV limit, AV Result is deemed to comply with AV limit.

3. Test setup: RBW: 1 MHz, VBW: 3 MHz, Sweep time: auto.

TR-4-E-009 Radiated Emission Test Result

Test Site : DDT 3m Chamber 2#

D:\2020 RE2# Report Data\Q20063026-1E PRO TWS\FCC ABOVE1G.EM6

Test Date : 2020-08-11

Tested By : Talent

EUT : BLUETOOTH HEADSET

Model Number : LIVE PRO+ TWS

Power Supply : Battery

Test Mode : Tx mode

Condition : Temp:24.5°C,Humi:55%,Press:100.1kPa

Antenna/Distance : 2019 BBHA9120D/3m/VERTICAL

Memo : BLE 2480

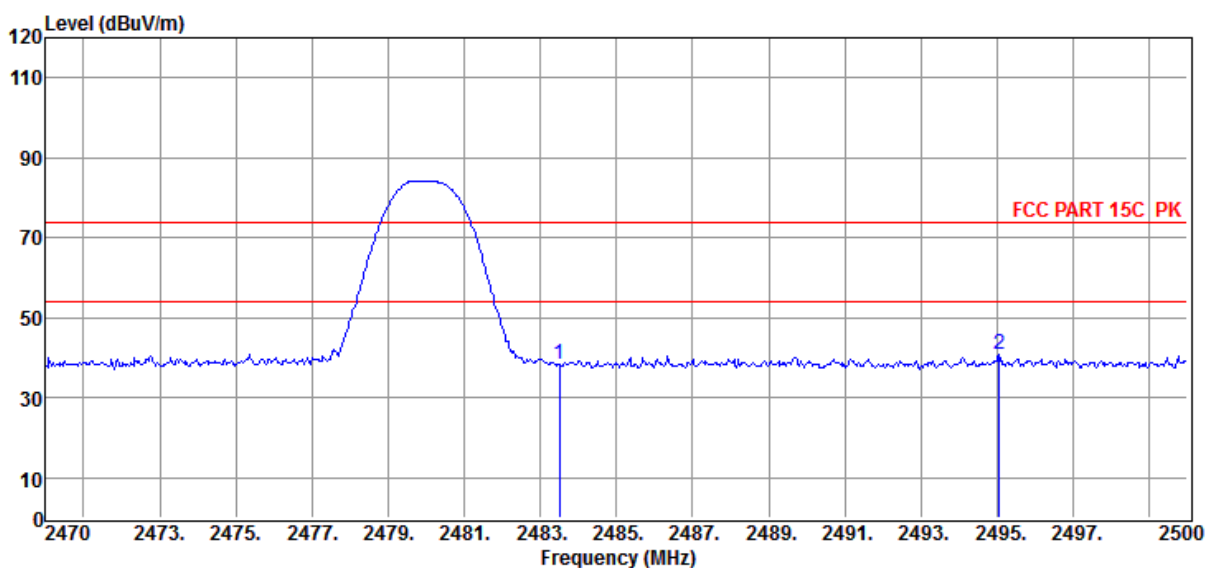

| Item (Mark) | Freq. (MHz) | Read Level (dBμV) | Antenna Factor (dB/m) | PRM Factor (dB) | Cable Loss (dB) | Result Level (dBμV/m) | Limit Line (dBμV/m) | Over Limit (dB) | Detector | Polarization |
|-------------|-------------|-------------------|-----------------------|-----------------|-----------------|-----------------------|---------------------|-----------------|----------|--------------|
| 1 | 2483.50 | 49.82 | 27.67 | 43.25 | 4.12 | 38.36 | 74.00 | -35.64 | Peak | VERTICAL |
| 2 | 2495.05 | 52.09 | 27.69 | 43.26 | 4.14 | 40.66 | 74.00 | -33.34 | Peak | VERTICAL |

Note: 1. Result Level = Read Level + Antenna Factor + Cable loss - PRM Factor.

2. If Peak Result complies with AV limit, AV Result is deemed to comply with AV limit.

3. Test setup: RBW: 1 MHz, VBW: 3 MHz, Sweep time: auto.

11. Power Line Conducted Emission

11.1. Block diagram of test setup

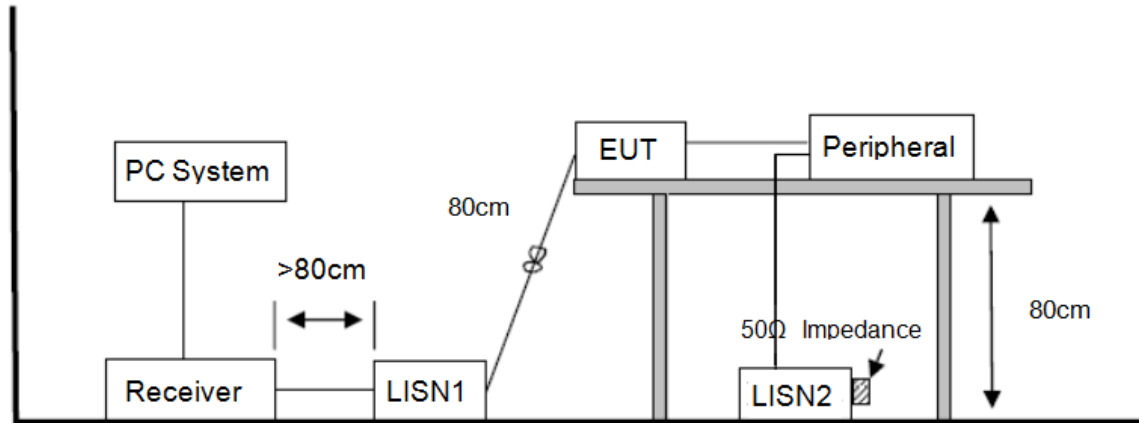

11.2. Power line conducted emission limits

| Frequency | Quasi-Peak Level dB(μ V) | Average Level dB(μ V) |
|-------------------|----------------------------------|-------------------------------|
| 150 kHz ~ 500 kHz | 66 ~ 56* | 56 ~ 46* |
| 500 kHz ~ 5 MHz | 56 | 46 |
| 5 MHz ~ 30 MHz | 60 | 50 |

Note 1: * Decreasing linearly with logarithm of frequency.

Note 2: The lower limit shall apply at the transition frequencies.

11.3. Test procedure

The EUT and Support equipment, if needed, were put placed on a non-metallic table, 80 cm above the ground plane.

Configuration EUT to simulate typical usage as described in clause 2.4 and test equipment as described in clause 10.2 of this report.

All I/O cables were positioned to simulate typical actual usage as per ANSI C63.10.

All support equipment power received from a second LISN.

Emissions were measured on each current carrying line of the EUT using an EMI Test Receiver connected to the LISN powering the EUT.

The Receiver scanned from 150 kHz to 30 MHz for emissions in each of the test modes.

During the above scans, the emissions were maximized by cable manipulation.

The test mode(s) described in clause 2.4 were scanned during the preliminary test.

After the preliminary scan, we found the test mode producing the highest emission level.

The EUT configuration and worse cable configuration of the above highest emission levels were recorded for reference of the final test.

EUT and support equipment were set up on the test bench as per the configuration with highest emission level in the preliminary test.

A scan was taken on both power lines, Neutral and Line, recording at least the six highest emissions.

Emission frequency and amplitude were recorded into a computer in which correction factors were used to calculate the emission level and compare reading to the applicable limit.

The test data of the worst-case condition(s) was recorded.

The bandwidth of test receiver is set at 9 kHz.

11.4. Test result

Pass. (See below detailed test result)

Note1: All emissions not reported below are too low against the prescribed limits.

Note2: "----" means Peak detection; "-----" means Average detection.

Note3: Pre-test AC conducted emission at both voltage AC 120V/60Hz and AC 240V/50Hz, recorded worse case.

TR-4-E-010 Conducted Emission Test Result

Test Site : DDT 1# Shield Room D:\2020 CE report data\Q20063026-4E\20200707 CE.EM6
Test Date : 2020-07-07 **Tested By** : Bote Huang
EUT : BLUETOOTH HEADSET **Model Number** : LIVE PRO+ TWS
Power Supply : AC 120V/60Hz **Test Mode** : BLE mode
Condition : TEMP:25°C, RH:50%, BP:101.4kPa **LISN** : 2019 ENV216 1#/LINE
Memo : BLE

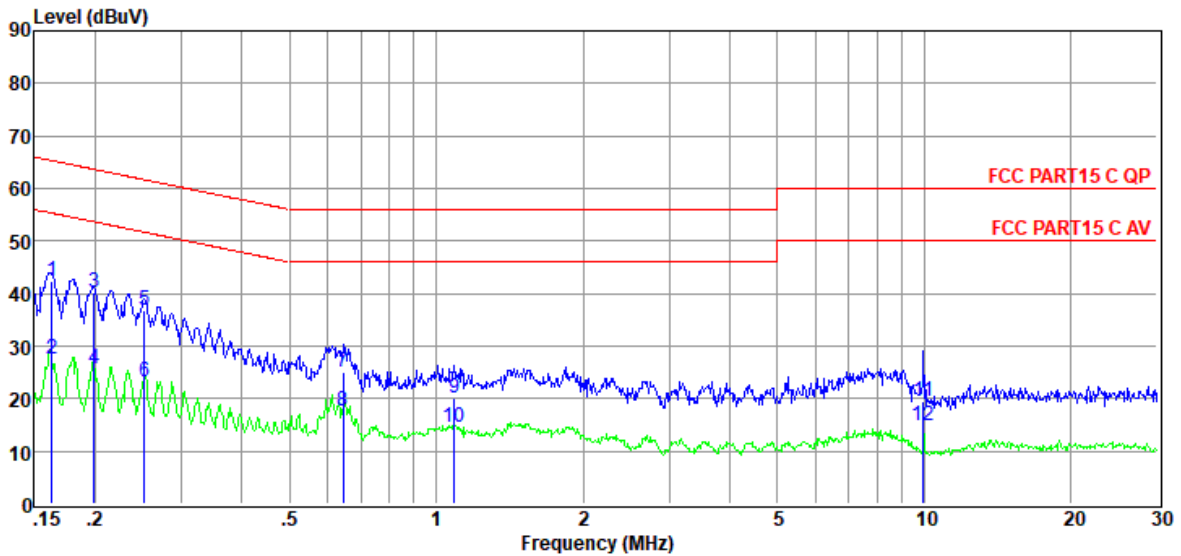

| Item (Mark) | Freq. (MHz) | Read Level (dBμV) | LISN Factor (dB) | Cable Loss (dB) | Pulse Limiter Factor (dB) | Result Level (dBμV) | Limit Line (dBμV) | Over Limit (dB) | Detector | Phase |
|----------------|----------------|----------------------|---------------------|--------------------|------------------------------|------------------------|----------------------|--------------------|----------|-------|
| 1 | 0.16 | 22.94 | 9.60 | 0.01 | 9.86 | 42.41 | 65.30 | -22.89 | QP | LINE |
| 2 | 0.16 | 7.97 | 9.60 | 0.01 | 9.86 | 27.44 | 55.30 | -27.86 | Average | LINE |
| 3 | 0.20 | 20.58 | 9.60 | 0.02 | 9.86 | 40.06 | 63.67 | -23.61 | QP | LINE |
| 4 | 0.20 | 6.17 | 9.60 | 0.02 | 9.86 | 25.65 | 53.67 | -28.02 | Average | LINE |
| 5 | 0.25 | 17.32 | 9.60 | 0.02 | 9.86 | 36.80 | 61.69 | -24.89 | QP | LINE |
| 6 | 0.25 | 3.82 | 9.60 | 0.02 | 9.86 | 23.30 | 51.69 | -28.39 | Average | LINE |
| 7 | 0.64 | 5.51 | 9.60 | 0.03 | 9.86 | 25.00 | 56.00 | -31.00 | QP | LINE |
| 8 | 0.64 | -1.82 | 9.60 | 0.03 | 9.86 | 17.67 | 46.00 | -28.33 | Average | LINE |
| 9 | 1.09 | 0.68 | 9.60 | 0.03 | 9.86 | 20.17 | 56.00 | -35.83 | QP | LINE |
| 10 | 1.09 | -4.97 | 9.60 | 0.03 | 9.86 | 14.52 | 46.00 | -31.48 | Average | LINE |
| 11 | 9.97 | 0.03 | 9.60 | 0.11 | 9.89 | 19.63 | 60.00 | -40.37 | QP | LINE |
| 12 | 9.97 | -4.81 | 9.60 | 0.11 | 9.89 | 14.79 | 50.00 | -35.21 | Average | LINE |

- Note: 1. Result Level = Read Level + LISN Factor + Pulse Limiter Factor + Cable loss.
 2. If QP Result complies with AV limit, AV Result is deemed to comply with AV limit.
 3. Test setup: RBW: 200 Hz (9 kHz—150 kHz), 9 kHz (150 kHz—30 MHz).
 4. Step size: 80Hz (0.009MHz-0.15MHz), 4 kHz (0.15MHz-30MHz), Scan time: auto.

TR-4-E-010 Conducted Emission Test Result

Test Site : DDT 1# Shield Room D:\2020 CE report data\Q20063026-4E\20200707 CE.EM6
Test Date : 2020-07-07 **Tested By** : Bote Huang
EUT : BLUETOOTH HEADSET **Model Number** : LIVE PRO+ TWS
Power Supply : AC 120V/60Hz **Test Mode** : BLE mode
Condition : TEMP:25°C, RH:50%, BP:101.4kPa **LISN** : 2019 ENV216 1#/NEUTRAL
Memo : BLE

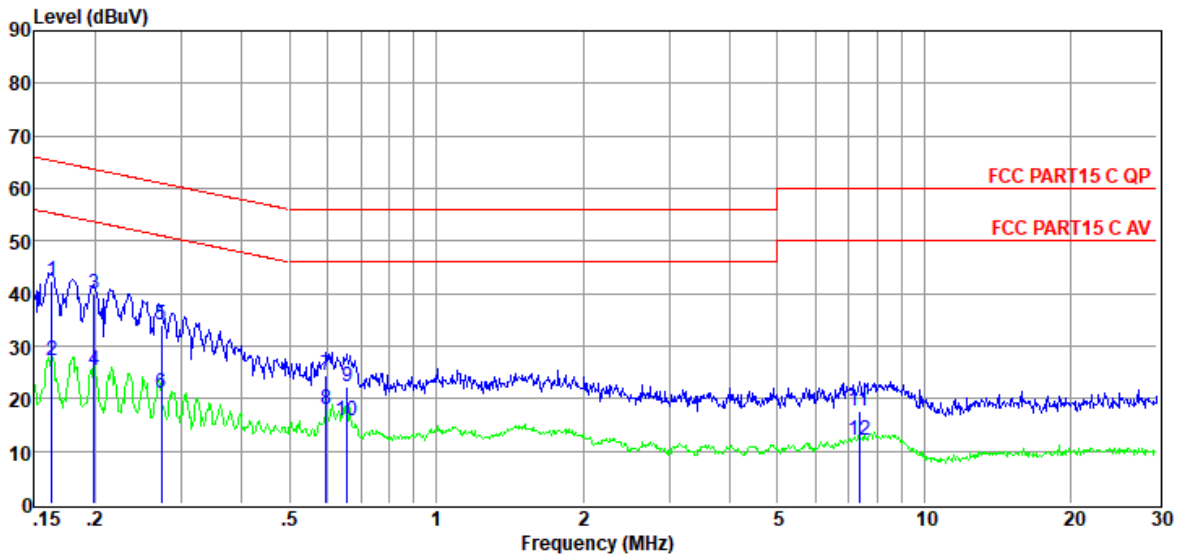

| Item (Mark) | Freq. (MHz) | Read Level (dBμV) | LISN Factor (dB) | Cable Loss (dB) | Pulse Limiter Factor (dB) | Result Level (dBμV) | Limit Line (dBμV) | Over Limit (dB) | Detector | Phase |
|----------------|----------------|----------------------|---------------------|--------------------|------------------------------|------------------------|----------------------|--------------------|----------|---------|
| 1 | 0.16 | 22.83 | 9.60 | 0.01 | 9.86 | 42.30 | 65.30 | -23.00 | QP | NEUTRAL |
| 2 | 0.16 | 7.78 | 9.60 | 0.01 | 9.86 | 27.25 | 55.30 | -28.05 | Average | NEUTRAL |
| 3 | 0.20 | 20.54 | 9.60 | 0.02 | 9.86 | 40.02 | 63.67 | -23.65 | QP | NEUTRAL |
| 4 | 0.20 | 5.98 | 9.60 | 0.02 | 9.86 | 25.46 | 53.67 | -28.21 | Average | NEUTRAL |
| 5 | 0.27 | 14.51 | 9.60 | 0.02 | 9.86 | 33.99 | 61.03 | -27.04 | QP | NEUTRAL |
| 6 | 0.27 | 1.51 | 9.60 | 0.02 | 9.86 | 20.99 | 51.03 | -30.04 | Average | NEUTRAL |
| 7 | 0.59 | 5.06 | 9.60 | 0.03 | 9.86 | 24.55 | 56.00 | -31.45 | QP | NEUTRAL |
| 8 | 0.59 | -1.45 | 9.60 | 0.03 | 9.86 | 18.04 | 46.00 | -27.96 | Average | NEUTRAL |
| 9 | 0.66 | 2.73 | 9.60 | 0.03 | 9.86 | 22.22 | 56.00 | -33.78 | QP | NEUTRAL |
| 10 | 0.66 | -3.62 | 9.60 | 0.03 | 9.86 | 15.87 | 46.00 | -30.13 | Average | NEUTRAL |
| 11 | 7.37 | -1.81 | 9.60 | 0.10 | 9.88 | 17.77 | 60.00 | -42.23 | QP | NEUTRAL |
| 12 | 7.37 | -7.39 | 9.60 | 0.10 | 9.88 | 12.19 | 50.00 | -37.81 | Average | NEUTRAL |

- Note: 1. Result Level = Read Level + LISN Factor + Pulse Limiter Factor + Cable loss.
 2. If QP Result complies with AV limit, AV Result is deemed to comply with AV limit.
 3. Test setup: RBW: 200 Hz (9 kHz—150 kHz), 9 kHz (150 kHz—30 MHz).
 4. Step size: 80Hz (0.009MHz-0.15MHz), 4 kHz (0.15MHz-30MHz), Scan time: auto.

12. Antenna Requirements

12.1. Limit

For intentional device, according to FCC 47 CFR Section 15.203, an intentional radiator shall be designed to ensure that no antenna other than that furnished by the responsible party shall be used with the device. And according to FCC 47 CFR Section 15.247 (b), if transmitting antennas of directional gain greater than 6 dBi are used, the power shall be reduced by the amount in dB that the directional gain of the antenna exceeds 6 dBi.

12.2. Result

The left side antenna used for this product is LDS antenna and right side is LDS antenna and that no antenna other than that furnished by the responsible party shall be used with the device, the maximum peak gain of the left side transmit antenna is -2.13 dBi and right side is 0.65 dBi.

END OF REPORT