

SAR TEST REPORT

for

Harman International Industries, Inc.

BLUETOOTH HEADSET

Model No.: LIVE PRO+ TWS

Trade Mark: JBL

FCC ID: APILIVEPROTWS

IC: 6132A-LIVEPROTWS

The MAX SAR(1g)	
Head SAR	0.7975W/Kg

Prepared for : Harman International Industries, Inc.
8500 Balboa Boulevard, Northridge, CA 91329, UNITED STATES

Prepared By : Audix Technology (Shenzhen) Co., Ltd.
No. 6, Kefeng Road, Science & Technology Park,
Nanshan District, Shenzhen, Guangdong, China

Tel: (0755) 26639496

Fax: (0755) 26632877

Report Number : ACS-SF20025

Date of Test : Aug.20, 2020

Date of Report : Sep.27, 2020

TABLE OF CONTENTS

<u>Description</u>	<u>Page</u>
Test Report Verification.....	3
1. GENERAL INFORMATION.....	4
1.1. Description of Equipment Under Test.....	4
1.2. Feature of Equipment Under Test	5
2. GENERAL DESCRIPTION.....	6
2.1. Product Description For EUT.....	6
2.2. Applied Standards	6
2.3. Device Category and SAR Limits	6
2.4. Test Conditions.....	6
2.5. Exposure Positions Consideration.....	7
2.6. Standalone SAR Test Exclusion Considerations.....	8
2.7. EUT Configuration and operation conditions for test.	10
2.8. Test Equipments.....	10
2.9. Laboratory Environment	11
2.10. Measurement Uncertainty	11
3. MEASURE PROCEDURES.....	14
3.1. General description of test procedures	14
4. SAR MEASUREMENTS SYSTEM.....	15
4.1. SAR Measurement Set-up	15
4.2. ELI Phantom.....	16
4.3. Device Holder for SAM Twin Phantom.....	17
4.4. DASY5 E-field Probe System.....	18
4.5. E-field Probe Calibration.....	19
4.6. Scanning procedure	20
5. DATA STORAGE AND EVALUATION.....	22
5.1. Data Storage	22
5.2. Data Evaluation by SEMCAD.....	22
6. SYSTEM CHECK	24
7. TEST RESULTS.....	26
7.1. Output power.....	26
7.2. System Check for Head Tissue simulating liquid	28
7.3. Test Results	29

ANNEX A: SYSTEM CHECK RESULTS

ANNEX B: TEST PLOTS

ANNEX C: DASY CABLIBRATION CERTIFICATE

ANNEX D: TEST SETUP PHOTOS

SAR TEST REPORT

Applicant : Harman International Industries, Inc.
 Product : BLUETOOTH HEADSET
 Trade Mark : JBL
 FCC ID : APILIVEPROTWSP
 IC : 6132A-LIVEPROTWSP
 (A) Model No. : LIVE PRO+ TWS
 (B) Test Voltage : DC 3.7V (built-in battery)

Measurement Standard Used:

- FCC 47 CFR Part 2 (2.1093)
- IEEE C95.1-1999
- IEEE 1528-2013
- IEC62209-1:2016
- IEC62209-2:2010
- FCC OET Bulletin 65 Supplement C (Edition 01-01)
- RSS-102 ISSUE 5: 2015
- FCC KDB 447498 D01 v06
- FCC KDB 865664 D01/D02

The device described above is tested by Audix Technology (Shenzhen) Co., Ltd. to determine the maximum emission levels emanating from the device and the severe levels of the device can endure and its performance criterion. The test results are contained in this test report and Audix Technology (Shenzhen) Co., Ltd. is assumed full responsibility for the accuracy and completeness of test. This report contains data that are not covered by the NVLAP accreditation. Also, this report shows that the EUT is technically compliant with the FCC and RSS-102 requirements.

This report applies to above tested sample only. This report shall not be reproduced in part without written approval of Audix Technology (Shenzhen) Co., Ltd.

The report must not be used by the client to claim product certification, approval, or endorsement by NVLAP, NIST, or any agency of the federal government.

Date of Test : Aug.20, 2020 Report of date: Sep.27, 2020

Prepared by : Monica Liu Reviewed by : Sunny Lu
 Monica Liu / Assistant Sunny Lu / Deputy Manager



信華科技(深圳)有限公司
 Audix Technology (Shenzhen) Co., Ltd.
 EMC 部門報告專用章
 Stamp only for EMC Dept. Report
 Signature: David Jin

Approved & Authorized Signer: David Jin
 David Jin / Deputy General Manager

1. GENERAL INFORMATION

1.1. Description of Equipment Under Test

Applicant	Harman International Industries, Inc. 8500 Balboa Boulevard, Northridge, CA 91329, UNITED STATES
Manufacturer	Harman International Industries, Inc. 8500 Balboa Boulevard, Northridge, CA 91329, UNITED STATES
Product	BLUETOOTH HEADSET
Model No.	LIVE PRO+ TWS
Trade Mark	JBL
FCC ID	APILIVEPROTWSP
IC	6132A-LIVEPROTWSP
Sample Type	Prototype production
Date of Receipt	Aug.20, 2020
Date of Test	Aug.20, 2020

1.2. Feature of Equipment Under Test

Product Feature & Specification		
Product	BLUETOOTH HEADSET	
Model No.	LIVE PRO+ TWS	
FCC ID	APILIVEPROTWS	
IC	6132A-LIVEPROTWS	
Radio	Bluetooth BDR+EDR; BLE	
Power Source	<input checked="" type="checkbox"/> Commercial Power	AC 100 ~ 240V
	<input checked="" type="checkbox"/> External Power Source	DC 5V
	<input checked="" type="checkbox"/> Polymer Li-ion battery	DC 3.7V
	<input type="checkbox"/> UM battery	DC V
Bluetooth		
Frequency Range	2402-2480MHz	
Type of Modulation	GFSK, $\pi/4$ DQPSK, 8DPSK	
Data Rate	1Mbps, 2Mbps, 3Mbps	
Quantity of Channels	79/40	
Channel Separation	1MHz/2MHz	

Antenna System

Bluetooth	
Type of Antenna	LDS Antenna
Antenna Peak Gain	Left side: -2.13dBi Right side: 0.65dBi

2. GENERAL DESCRIPTION

2.1. Product Description For EUT [None]

2.2. Applied Standards

The Specific Absorption Rate (SAR) testing specification, method and procedure for this device is in accordance with the following standards:

- FCC 47 CFR Part 2 (2.1093)
- IEEE C95.1-1999
- IEEE 1528-2013
- IEC62209-1:2016
- IEC62209-2:2010
- FCC OET Bulletin 65 Supplement C (Edition 01-01)
- RSS-102 ISSUE 5: 2015
- FCC KDB 447498 D01 v06
- FCC KDB 865664 D01/D02

2.3. Device Category and SAR Limits

This device belongs to portable device category because its radiating structure is allowed to be used within 20 centimeters of the body of the user. Limit for General Population/Uncontrolled exposure should be applied for this device, it is 1.6 W/kg as averaged over any 1 gram of tissue.

2.4. Test Conditions

2.4.1. Ambient Condition

Ambient Temperature	20 to 24 °C
Humidity	< 60 %

2.4.2. Test Configuration

The distance between the EUT and the antenna of the emulator is larger than 50 cm and the output power radiated from the emulator antenna is at least 30dB smaller than the output power of EUT. The EUT was set from the emulator to radiate maximum output power during all tests.

2.5. Exposure Positions Consideration

Left side:

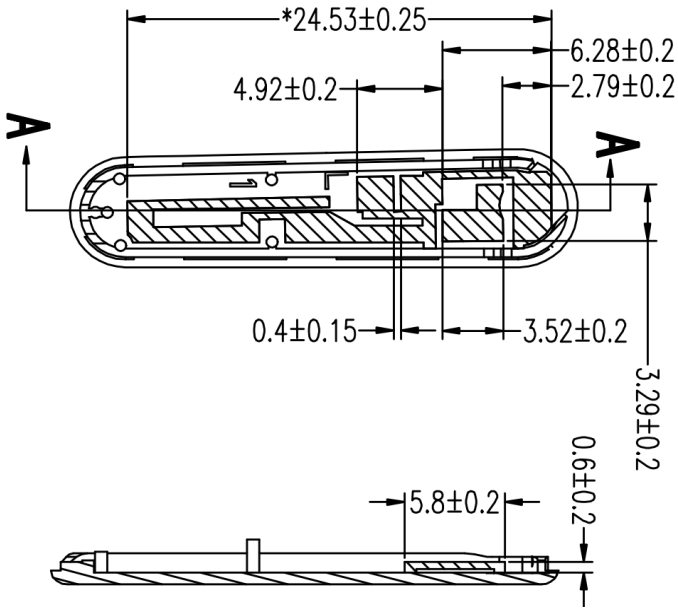

Right side:

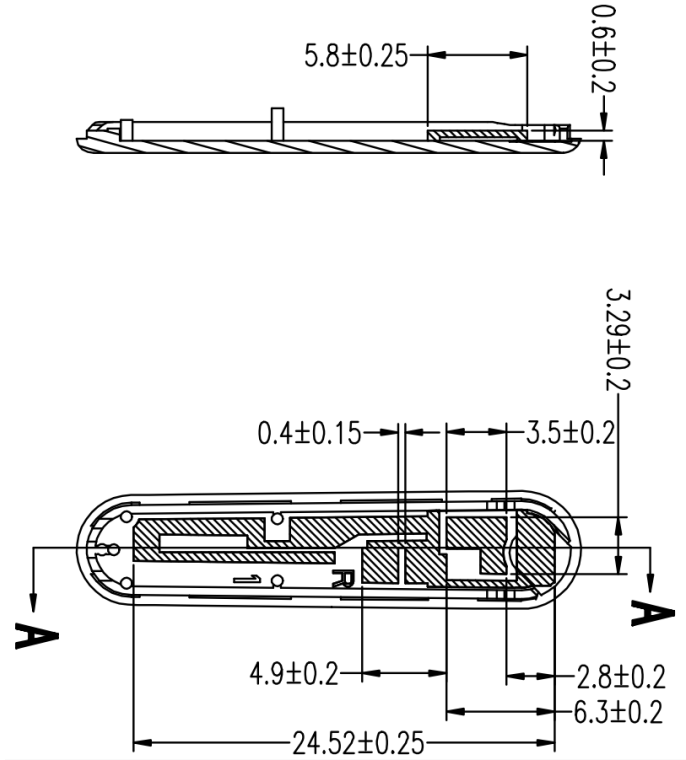

Antenna	Description
antenna	Bluetooth BDR+EDR; BLE

Sides for SAR tests Test distance: 0 mm(Head)						
Band	Head					
	Top	Front	Cochlea	Bottom	Left	Right
Bluetooth	√	√	√	√	√	√

2.6. Standalone SAR Test Exclusion Considerations

According to RSS-102 Table 1, the SAR test exclusion threshold for 2450MHz at 5mm test separation distances is 4mW.

Frequency (MHz)	Exemption Limits (mW)				
	At separation distance of ≤5 mm	At separation distance of 10 mm	At separation distance of 15 mm	At separation distance of 20 mm	At separation distance of 25 mm
≤300	71 mW	101 mW	132 mW	162 mW	193 mW
450	52 mW	70 mW	88 mW	106 mW	123 mW
835	17 mW	30 mW	42 mW	55 mW	67 mW
1900	7 mW	10 mW	18 mW	34 mW	60 mW
2450	4 mW	7 mW	15 mW	30 mW	52 mW
3500	2 mW	6 mW	16 mW	32 mW	55 mW
5800	1 mW	6 mW	15 mW	27 mW	41 mW

Frequency (MHz)	Exemption Limits (mW)				
	At separation distance of 30 mm	At separation distance of 35 mm	At separation distance of 40 mm	At separation distance of 45 mm	At separation distance of ≥50 mm
≤300	223 mW	254 mW	284 mW	315 mW	345 mW
450	141 mW	159 mW	177 mW	195 mW	213 mW
835	80 mW	92 mW	105 mW	117 mW	130 mW
1900	99 mW	153 mW	225 mW	316 mW	431 mW
2450	83 mW	123 mW	173 mW	235 mW	309 mW
3500	86 mW	124 mW	170 mW	225 mW	290 mW
5800	56 mW	71 mW	85 mW	97 mW	106 mW

Standalone 1-g head or body SAR evaluation by measurement or numerical simulation is not required when the corresponding SAR Exclusion Threshold condition, listed below, is satisfied. The 1-g SAR test exclusion threshold for 100 MHz to 6 GHz at test separation distances ≤ 50 mm are determined by:

$[(\text{max. power of channel, including tune-up tolerance, mW}) / (\text{min. test separation distance, mm})] \cdot [\sqrt{f(\text{GHz})}] \leq 3.0$ for 1-g SAR, where

- $f(\text{GHz})$ is the RF channel transmit frequency in GHz
- Power and distance are rounded to the nearest mW and mm before calculation
- The result is rounded to one decimal place for comparison

According to the KDB447498 appendix A, the SAR test exclusion threshold for 2450MHz at 5mm test separation distances is 10 mW.

Appendix A

SAR Test Exclusion Thresholds for 100 MHz – 6 GHz and ≤ 50 mm

Approximate SAR Test Exclusion Power Thresholds at Selected Frequencies and Test Separation Distances are illustrated in the following Table.

MHz	5	10	15	20	25	mm
150	39	77	116	155	194	SAR Test Exclusion Threshold (mW)
300	27	55	82	110	137	
450	22	45	67	89	112	
835	16	33	49	66	82	
900	16	32	47	63	79	
1500	12	24	37	49	61	
1900	11	22	33	44	54	
2450	10	19	29	38	48	
3600	8	16	24	32	40	
5200	7	13	20	26	33	
5400	6	13	19	26	32	
5800	6	12	19	25	31	

2.7. EUT Configuration and operation conditions for test.

EUT

(EUT: BLUETOOTH HEADSET)

2.8. Test Equipments

Item	Equipment	Manufacturer	Model No.	Serial No.	Last Cal Date	Validity Date	Cal. Agency
1.	DASY5 SAR Test System	Speag	TX60 L speag	F09/5B1H1/01	NCR	NCR	N/A
2.	Wireless Communication Test Set	Agilent	E5515C	GB443002433	2020.04.11	2021.04.11	CCIC
3.	Power Meter	Anritsu	ML2487A	6K00003262	2020.04.11	2021.04.11	CCIC
4.	Power Sensor	Anritsu	MA2491A	033005	2020.04.11	2021.04.11	CCIC
5.	Signal Generator	Rohde & Schwarz	SMB100A	181375	2020.04.11	2021.04.11	CCIC
6.	Amplifier	Milmega	ZHL-42W	C620601316	NCR	NCR	N/A
7.	Dipole Validation Kits	Speag	D2450V2	862	2020.06.15	2023.06.15	SPEAG
8.	Attenuator	N/A	1527	001	2019.10.13	2020.10.13	CCIC
9.	Date Acquisition Electronics	Speag	DAE4	899	2020.03.18	2021.03.18	CCTL
10.	E-Field Probe	Speag	EX3DV4	3767	2020.04.01	2021.04.01	CCTL
11.	ENA Series Analyzer	Agilent	E5071B	MY42403549	2020.04.11	2021.04.11	CCIC
12.	Test Software	Schmid&Partner Englinnering AG	DASY5	52.8.7.1137	NCR	NCR	NCR
13.	Radio Communication Analyzer	ANRITSU	MT8820C	6201091003	2019.10.12	2020.10.12	CCIC
14.	Radio Communication Analyzer	R&S	CMW500	103249	2019.10.12	2020.10.12	CCIC

Note: Dipole antenna calibration interval is 3 year, annual check result to be follow (Refer to KDB 865664, Dipole calibration)

2.9. Laboratory Environment

Temperature	Min:20°C,Max.25°C
Relative humidity	Min. = 30%, Max. = 70%
Note: Ambient noise is checked and found very low and in compliance with requirement of standards.	

2.10. Measurement Uncertainty

Test Item	Uncertainty
Uncertainty for SAR test	1g: 21.14
	10g: 20.64
Uncertainty for test site temperature and humidity	0.6°C

Source	Type	Uncertainty Value (%)	Probability Distribution	K	C1(1g)	C1(10g)	Standard uncertainty u _i (%)1g	Standard uncertainty u _i (%)10g	Degree of freedom V _{eff} or V _i
Measurement system repeatability	A	0.5	N	1		1	0.5	0.5	9
Probe calibration	B	5.9	N	1	1	1	5.9	5.9	∞
Isotropy	B	4.7	R	√3	1	1	2.7	2.7	∞
Linearity	B	4.7	R	√3	1	1	2.7	2.7	∞
Probe modulation response	B	0	R	√3	1	1	0	0	∞
Detection limits	B	1.0	R	√3	1	1	0.6	0.6	∞
Boundary effect	B	1.9	R	√3	1	1	1.1	1.1	∞
Readout electronics	B	1.0	N	1	1	1	1.0	1.0	∞
Response time	B	0	R	√3	1	1	0	0	∞
Integration time	B	4.32	R	√3	1	1	2.5	2.5	∞
RF ambient conditions – noise	B	0	R	√3	1	1	0	0	∞
RF ambient conditions – reflections	B	3	R	√3	1	1	1.73	1.73	∞
Probe positioner mech. restrictions	B	0.4	R	√3	1	1	0.2	0.2	∞
Probe positioning with respect to phantom shell	B	2.9	R	√3	1	1	1.7	1.7	∞
Post-processing	B	0	R	√3	1	1	0	0	∞
Test sample related									
Device holder uncertainty	A	2.94	N	1	1	1	2.94	2.94	M-1
Test sample positioning	A	4.1	N	1	1	1	4.1	4.1	M-1
Power scaling	B	5.0	R	√3	1	1	2.9	2.9	∞
Drift of output power (measured SAR drift)	B	5.0	R	√3	1	1	2.9	2.9	∞
Phantom and set-up									
Phantom uncertainty (shape and thickness tolerances)	B	4.0	R	√3	1	1	2.3	2.1	∞
Algorithm for correcting SAR for deviations in permittivity and conductivity	B	1.9	N	1	1	0,84	1,9	1,6	∞
Liquid conductivity (meas.)	A	0.55	N	1	0.78	0.71	0.24	0.21	M-1
Liquid permittivity (meas.)	A	0.19	N	1	0.23	0.26	0.09	0.06	M
Liquid permittivity – temperature uncertainty	A	5.0	R	√3	0,78	0,71	1.4	1.1	∞
Liquid conductivity – temperature uncertainty	A	5.0	R	√3	0.23	0,26	1.2	0.8	∞
Combined standard uncertainty	$u_c = \sqrt{\sum_{i=1}^{23} c_i^2 u_i^2}$						10.57	10.32	
Expanded uncertainty (95 % conf. interval)	$u_e = 2u_c$			N	K=2		21.14	20.64	

The following tissue formulations are provided for reference only as some of the parameters have not been thoroughly verified. The composition of ingredients may be modified accordingly to achieve the desired target tissue parameters required for routine SAR evaluation.

Ingredients (% by weight)	Frequency (MHz)									
	450		835		915		1900		2450	
Tissue Type	Head	Body	Head	Body	Head	Body	Head	Body	Head	Body
Water	38.56	51.16	41.45	52.4	41.05	56.0	54.9	40.4	62.7	73.2
Salt (NaCl)	3.95	1.49	1.45	1.4	1.35	0.76	0.18	0.5	0.5	0.04
Sugar	56.32	46.78	56.0	45.0	56.5	41.76	0.0	58.0	0.0	0.0
HEC	0.98	0.52	1.0	1.0	1.0	1.21	0.0	1.0	0.0	0.0
Bactericide	0.19	0.05	0.1	0.1	0.1	0.27	0.0	0.1	0.0	0.0
Triton X-100	0.0	0.0	0.0	0.0	0.0	0.0	0.0	0.0	36.8	0.0
DGBE	0.0	0.0	0.0	0.0	0.0	0.0	44.92	0.0	0.0	26.7
Dielectric Constant	43.42	58.0	42.54	56.1	42.0	56.8	39.9	54.0	39.8	52.5
Conductivity (S/m)	0.85	0.83	0.91	0.95	1.0	1.07	1.42	1.45	1.88	1.78

Salt: 99+% Pure Sodium Chloride

Sugar: 98+% Pure Sucrose

Water: De-ionized, 16 MΩ+ resistivity

HEC: Hydroxyethyl Cellulose

DGBE: 99+% Di(ethylene glycol) butyl ether, [2-(2-butoxyethoxy)ethanol]

Triton X-100 (ultra pure): Polyethylene glycol mono [4-(1,1, 3, 3-tetramethylbutyl)phenyl]ether

Simulating Liquids for 5 GHz, Manufactured by SPEAG

Ingredients	(% by weight)
Water	78
Mineral oil	11
Emulsifiers	9
Additives and Salt	2

3. MEASURE PROCEDURES

3.1. General description of test procedures

This is a BLUETOOTH HEADSET and it is appropriate for head SAR test, each side of the EUT should be tested. Choose the channel which has the maximum power as the priority test channel, if the test result less than 0.8W/Kg, then other channel can be excluded, otherwise, the channel which has a secondary highest power should be tested instead.

Please apply the following guidance for SAR testing:

1. Please use a 0 mm test separation distance on the flat phantom during SAR testing of this device. This separation distance is based on the guidance found in FCC KDB Publication 447498 D01, Section 5.2.3 3)
2. Please utilize a head tissue simulating liquid (TSL) of the appropriate frequency during SAR testing.
3. Please use the guidance found in FCC KDB Publication 447498 D01 to determine which sides of the device need to be tested for SAR.

4. SAR MEASUREMENTS SYSTEM

4.1. SAR Measurement Set-up

DASY5 system for performing compliance tests consists of the following items:

- (1) A standard high precision 6-axis robot (Stäubli RX family) with controller and software. An arm extension for accommodating the data acquisition electronics (DAE).
- (2) A dosimetric probe, i.e. an isotropic E-field probe optimized and calibrated for usage. It issues simulating liquid. The probe is equipped with an optical surface detector system.
- (3) A data acquisition electronic (DAE) which performs the signal amplification, signal multiplexing, AD-conversion, offset measurements, mechanical surface detection, collision detection, etc. The unit is battery powered with standard or rechargeable batteries. The signal is optically transmitted to the EOC.
- (4) A unit to operate the optical surface detector which is connected to the EOC.
- (5) The Electro-Optical Coupler (EOC) performs the conversion from the optical into a digital electric signal of the DAE. The EOC is connected to the DASY5 measurement server.
- (6) The DASY5 measurement server, which performs all real-time data evaluation for field measurements and surface detection, controls robot movements and handles safety operation. A computer operating Windows 2003.
- (7) DASY5 software and SEMCAD data evaluation software.
- (8) Remote control with teach panel and additional circuitry for robot safety such as warning lamps, etc.
- (9) The generic twin phantom enabling the testing of left-hand and right-hand usage.
- (10) The device holder for handheld mobile phones.
- (11) Tissue simulating liquid mixed according to the given recipes.
- (12) System validation dipoles allowing to validate the proper functioning of the system.

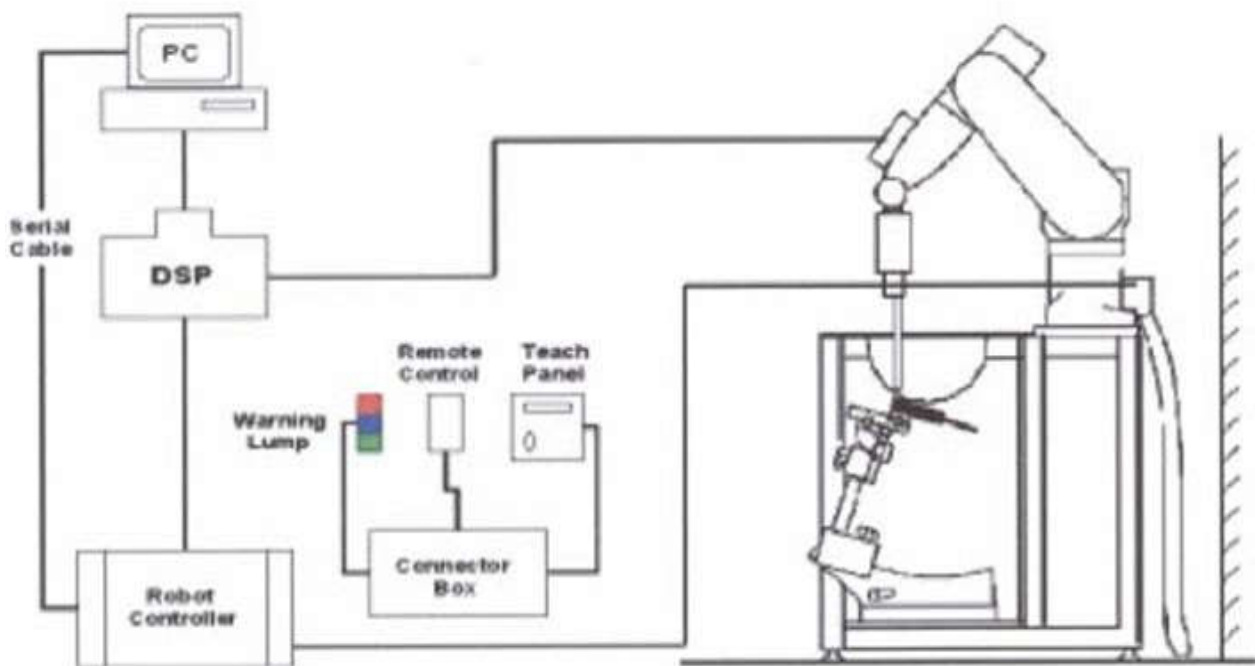

Figure 4.1 SAR Lab Test Measurement Set-up

4.2. ELI Phantom

Phantom for compliance testing of handheld and body-mounted wireless devices in the frequency range of 30 MHz to 6 GHz. ELI is fully compatible with the IEC 62209-2 standard and all known tissue simulating liquids. ELI has been optimized regarding its performance and can be integrated into our standard phantom tables. A cover prevents evaporation of the liquid. Reference markings on the phantom allow installation of the complete setup, including all predefined phantom positions and measurement grids, by teaching three points. The phantom is compatible with all SPEAG dosimetric probes and dipoles.



Material	Vynylester, glass fiber reinforced (VE-GF)
Liquid Compatibility	Compatible with all SPEAG tissue simulating liquids (incl. DGBE type)
Shell Thickness	2.0 ± 0.2 mm (bottom plate)
Dimensions	Major axis: 600 mm Minor axis: 400 mm
Filling Volume	approx. 30 liters
Wooden Support	SPEAG standard phantom table

The bottom plate contains three pair of bolts for locking the device holder. The device holder positions are adjusted to the standard measurement positions in the three sections.

Figure 6.2 Top View of Twin Phantom

A white cover is provided to tap the phantom during off-periods to prevent water evaporation and changes in the liquid parameters.

On the phantom top, three reference markers are provided to identify the phantom position with respect to the robot.

The phantom can be used with the following tissue simulating liquids:

- *Water-sugar based liquid
- *Glycol based liquids

4.3. Device Holder for SAM Twin Phantom

The SAR in the Phantom is approximately inversely proportional to the square of the distance between the source and the liquid surface. For a source in 5 mm distance, a positioning uncertainty of $\pm 0.5\text{mm}$ would produce a SAR uncertainty of $\pm 20\%$. An accurate device position is therefore crucial for accurate and repeatable measurement. The position in which the devices must be measured, are defined by the standards.

The DASY5 device holder is designed to cope with different positions given in the standard. It has two scales for the device rotation (with respect to the body axis) and the device inclination (with respect to the line between the ear reference points). The rotation centers for both scales is the ear reference point (EPR).

Thus the device needs no repositioning when changing the angles.

The DASY5 device holder has been made out of low-loss POM material having the following dielectric parameters: relative permittivity $\epsilon_r = 3$ and loss tangent $\delta = 0.02$. The amount of dielectric material has been reduced in the closest vicinity of the device, since measurements have suggested that the influence of the clamp on the test results could thus be lowered.



Figure 4.3 Device Holder

4.4. DASY5 E-field Probe System

The SAR measurements were conducted with the dosimetric probe EX3DV4 (manufactured by SPEAG), designed in the classical triangular configuration and optimized for dosimetric evaluation.



Figure 4.4 EX3DV4 E-field Probe

4.4.1. EX3DV4 Probe Specification

Construction	Symmetrical design with triangular core Built-in shielding against static charges PEEK enclosure material (resistant to organic solvents, e.g., DGBE)
Calibration	ISO/IEC 17025 calibration service available
Frequency	10 MHz to > 6 GHz Linearity: ± 0.2 dB (30 MHz to 6 GHz)
Directivity	± 0.3 dB in HSL (rotation around probe axis) ± 0.5 dB in tissue material (rotation normal to probe axis)
Dynamic Range	10 μ W/g to > 100 mW/g Linearity: ± 0.2 dB (noise: typically < 1 μ W/g)
Dimensions	Overall length: PRS-T2 mm (Tip: 20 mm) Tip diameter: 2.5 mm (Body: 12 mm) Typical distance from probe tip to dipole centers: 1 mm
Application	High precision dosimetric measurements in any exposure scenario (e.g., very strong gradient fields). Only probe which enables compliance testing for frequencies up to 6 GHz with precision of better 30%.

4.5. E-field Probe Calibration

Each probe is calibrated according to a dosimetric assessment procedure with accuracy better than $\pm 10\%$. The spherical isotropy was evaluated and found to be better than $\pm 0.25\text{dB}$. The sensitivity parameters (NormX, NormY, NormZ), the diode compression parameter (DCP) and the conversion factor (ConvF) of the probe are tested.

The free space E-field from amplified probe outputs is determined in a test chamber. This is performed in a TEM cell for frequencies below 1 GHz, and in a wave guide above 1 GHz for free space. For the free space calibration, the probe is placed in the volumetric center of the cavity and at the proper orientation with the field. The probe is then rotated 360 degrees.

E-field temperature correlation calibration is performed in a flat phantom filled with the appropriate simulated brain tissue. The measured free space E-field in the medium correlates to temperature rise in a dielectric medium. For temperature correlation calibration a RF transparent thermistor-based temperature probe is used in conjunction with the E-field probe.

$$\text{SAR} = C \frac{\Delta T}{\Delta t}$$

Where: Δt = Exposure time (30 seconds),
C = Heat capacity of tissue (brain or muscle),
 ΔT = Temperature increase due to RF exposure.
Or

$$\text{SAR} = \frac{|E|^2 \sigma}{\rho}$$

Where:
 σ = Simulated tissue conductivity,
 ρ = Tissue density (kg/m^3).

4.6. Scanning procedure

The DASY5 installation includes predefined files with recommended procedures for measurements and validation. They are read-only document files and destined as fully defined but unmeasured masks. All test positions (head or body-worn) are tested with the same configuration of test steps differing only in the grid definition for the different test positions.

The "reference" and "drift" measurements are located at the beginning and end of the batch process. They measure the field drift at one single point in the liquid over the complete procedure. The indicated drift is mainly the variation of the EUT's output power and should vary max. $\pm 5\%$.

The "surface check" measurement tests the optical surface detection system of the DASY5 system by repeatedly detecting the surface with the optical and mechanical surface detector and comparing the results. The output gives the detecting heights of both systems, the difference between the two systems and the standard deviation of the detection repeatability. Air bubbles or refraction in the liquid due to separation of the sugar-water mixture gives poor repeatability (above $\pm 0.1\text{mm}$). To prevent wrong results tests are only executed when the liquid is free of air bubbles.

The difference between the optical surface detection and the actual surface depends on the Probe and is specified with each probe. (It does not depend on the surface reflectivity or the probe angle to the surface within $\pm 30^\circ$.)

Area Scan

The Area Scan is used as a fast scan in two dimensions to find the area of high field values before running a detailed measurement around the hot spot. Before starting the area scan a grid spacing of 15 mm x 15 mm is set. During the scan the distance of the probe to the phantom remains unchanged.

After finishing area scan, the field maxima within a range of 2 dB will be ascertained.

Zoom Scan

Zoom Scans are used to estimate the peak spatial SAR values within a cubic averaging volume containing 1 g and 10 g of simulated tissue. The default Zoom Scan is done by 7x7x7 points within a cube whose base is centered around the maxima found in the preceding area scan.

Spatial Peak Detection

The procedure for spatial peak SAR evaluation has been implemented and can determine values of masses of 1g and 10g, as well as for user-specific masses. The DASY5 system allows evaluations that combine measured data and robot positions, such as:

- maximum search
- extrapolation
- boundary correction
- peak search for averaged SAR

During a maximum search, global and local maxima searches are automatically performed in 2-D after each Area Scan measurement with at least 6 measurement points. It is based on the evaluation of the local SAR gradient calculated by the Quadratic Shepard's method. The algorithm will find the global maximum and all local maxima within -2 dB of the global maxima for all SAR distributions.

Extrapolation routines are used to obtain SAR values between the lowest measurement points and the inner phantom surface. The extrapolation distance is determined by the surface detection distance and the probe sensor offset. Several measurements at different distances are necessary for the extrapolation. Extrapolation routines require at least 10 measurement points in 3-D space. They are used in the Zoom Scan to obtain SAR values between the lowest measurement points and the inner phantom surface. The routine uses the modified Quadratic Shepard's method for extrapolation. For a grid using 7x7x7 measurement points with 5mm resolution amounting to 343 measurement points, the uncertainty of the extrapolation routines is less than 1% for 1g and 10g cubes.

A Z-axis scan measures the total SAR value at the x-and y-position of the maximum SAR value found during the cube 7x7x7 scan. The probe is moved away in z-direction from the bottom of the SAM phantom in 5mm steps.

5. DATA STORAGE AND EVALUATION

5.1. Data Storage

The DASY5 software stores the acquired data from the data acquisition electronics as raw data (in microvolt readings from the probe sensors), together with all necessary software parameters for the data evaluation (probe calibration data, liquid parameters and device frequency and modulation data) in measurement files with the extension ".DA4". The software evaluates the desired unit and format for output each time the data is visualized or exported. This allows verification of the complete software setup even after the measurement and allows correction of incorrect parameter settings. For example, if a measurement has been performed with a wrong crest factor parameter in the device setup, the parameter can be corrected afterwards and the data can be re-evaluated.

The measured data can be visualized or exported in different units or formats, depending on the selected probe type ([V/m], [A/m], [°C], [mW/g], [mW/cm²], [dBrel], etc.). Some of these units are not available in certain situations or show meaningless results, e.g., a SAR output in a lossless media will always be zero. Raw data can also be exported to perform the evaluation with other software packages.

5.2. Data Evaluation by SEMCAD

The SEMCAD software automatically executes the following procedures to calculate the field units from the microvolt readings at the probe connector. The parameters used in the evaluation are stored in the configuration modules of the software:

Probe parameters:	- Sensitivity	Normi, ai0, ai1, ai2
	- Conversion factor	ConvFi
	- Diode compression point	Dcpi

Device parameters:	- Frequency	f
	- Crest factor	cf

Media parameters:	- Conductivity
	- Density

These parameters must be set correctly in the software. They can be found in the component documents or they can be imported into the software from the configuration files issued for the DASY5 components. In the direct measuring mode of the multimeter option, the parameters of the actual system setup are used. In the scan visualization and export modes, the parameters stored in the corresponding document files are used.

The first step of the evaluation is a linearization of the filtered input signal to account for the compression characteristics of the detector diode. The compensation depends on the input signal, the diode type and the DC-transmission factor from the diode to the evaluation electronics.

If the exciting field is pulsed, the crest factor of the signal must be known to correctly compensate for peak power. The formula for each channel can be given as:

$$Vi = Ui + Ui^2 \cdot cf / dcpi$$

- With V_i = compensated signal of channel i ($i = x, y, z$)
- U_i = input signal of channel i ($i = x, y, z$)
- cf = crest factor of exciting field (DASY parameter)
- dcp_i = diode compression point (DASY parameter)

From the compensated input signals the primary field data for each channel can be evaluated:

E-field probes: $E_i = (V_i / Norm_i \cdot ConvF)^{1/2}$

H-field probes: $H_i = (V_i)^{1/2} \cdot (ai_0 + ai_1 f + ai_2 f^2) / f$

- With V_i = compensated signal of channel i ($i = x, y, z$)
- $Norm_i$ = sensor sensitivity of channel i ($i = x, y, z$)
- $ConvF$ = sensitivity enhancement in solution
- ai_j = sensor sensitivity factors for H-field probes
- f = carrier frequency [GHz]
- E_i = electric field strength of channel i in V/m
- H_i = magnetic field strength of channel i in A/m

The RSS value of the field components gives the total field strength (Hermitian magnitude):

$$E_{tot} = (E_x^2 + E_y^2 + E_z^2)^{1/2}$$

The primary field data are used to calculate the derived field units.

$$SAR = (E_{tot}^2 \cdot \sigma) / (\rho \cdot 1000)$$

with

SAR = local specific absorption rate in mW/g

E_{tot} = total field strength in V/m

σ = conductivity in [mho/m] or [Siemens/m]

ρ = equivalent tissue density in g/cm³

Note that the density is normally set to 1 (or 1.06), to account for actual brain density rather than the density of the simulation liquid. The power flow density is calculated assuming the excitation field to be a free space field.

$$P_{pwe} = E_{tot}^2 / 3770 \quad \text{or} \quad P_{pwe} = H_{tot}^2 \cdot 37.7$$

with P_{pwe} = equivalent power density of a plane wave in mW/cm²

E_{tot} = total electric field strength in V/m

H_{tot} = total magnetic field strength in A/m

6. SYSTEM CHECK

The manufacturer calibrates the probes annually. Dielectric parameters of the tissue simulates were measured every day using the dielectric probe kit and the network analyzer. A system check measurement was made following the determination of the dielectric parameters of the simulates, using the dipole validation kit. A power level of 250 mW was supplied to the dipole antenna, which was placed under the flat section of the twin SAM phantom. The system check results (dielectric parameters and SAR values) are given in the ANNEX A.

System check results have to be equal or near the values determined during dipole calibration with the relevant liquids and test system ($\pm 10\%$).

System check is performed regularly on all frequency bands where tests are performed with the DASY5 system.

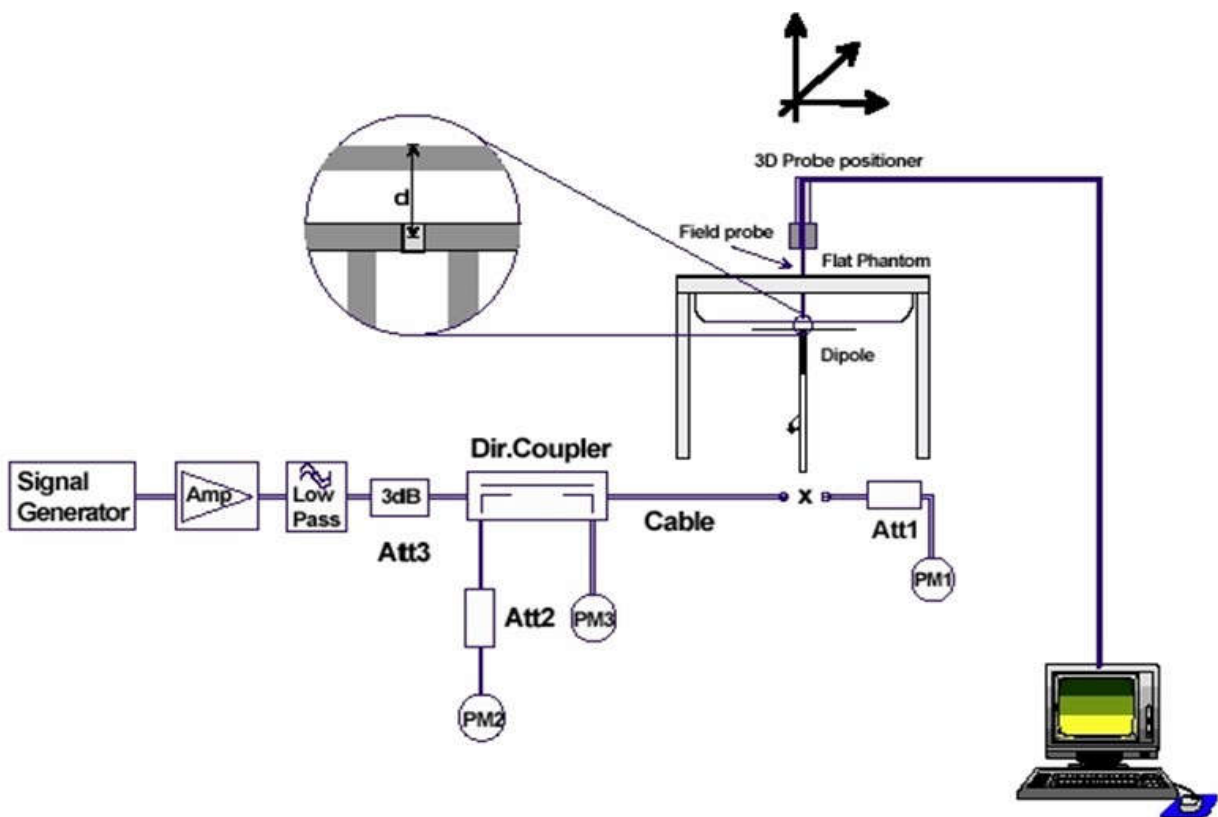

Figure 6.1: System Check Set-up



Figure 6.3: photos of system

7. TEST RESULTS

7.1. Output power

Left side:

(Bluetooth BER+EDR)

Test Mode	Frequency (MHz)	Average Output Power (dBm)	Duty Cycle	Maximum Tune-up Power (dBm)
DH5	2402	10.04	0.58	10.50
DH5	2441	11.23		11.50
DH5	2480	9.81		10.00
2DH5	2402	10.03		10.50
2DH5	2441	11.18		11.50
2DH5	2480	9.87		10.00
3DH5	2402	9.98		10.00
3DH5	2441	11.21		11.50
3DH5	2480	9.87		10.00

(BLE)

Test Mode	Frequency (MHz)	Average Output Power (dBm)	Duty Cycle	Maximum Tune-up Power (dBm)
GFSK	2402	2.12	0.62	2.50
	2440	2.98		3.00
	2480	2.56		3.00

Note: Use the data rate with the maximum output level for the SAR test.

Right side:
(Bluetooth BER+EDR)

Test Mode	Frequency (MHz)	Average Output Power (dBm)	Duty Cycle	Maximum Tune-up Power (dBm)
DH5	2402	11.17	0.58	11.50
DH5	2441	11.78		12.00
DH5	2480	10.39		10.50
2DH5	2402	11.21		11.50
2DH5	2441	11.75		12.00
2DH5	2480	10.37		10.50
3DH5	2402	11.14		11.50
3DH5	2441	11.71		12.00
3DH5	2480	10.35		10.50

(BLE)

Test Mode	Frequency (MHz)	Average Output Power (dBm)	Duty Cycle	Maximum Tune-up Power (dBm)
GFSK	2402	2.98	0.62	3.00
	2440	3.11		3.50
	2480	3.01		3.50

Note: Use the data rate with the maximum output level for the SAR test.

7.2. System Check for Head Tissue simulating liquid

Frequency	Description	SAR(W/kg) (1g±18.8% window; 10g±18.7% window)		Dielectric Parameters (±12.1% window)		Temp
		1g	10g	εr	σ(s/m)	°C
2450MHz	Recommended value	52.70 42.7924 – 62.606	24.20 19.6746 – 28.7254	39.20 34.4568 – 43.9432	1.80 1.5822 – 2.0178	/
	Measurement value 2020-08-20	51.6	22.92	39.15	1.81	22.03

Note: Recommended Values used derive from the calibration certificate and 250 mW is used as feeding power to the calibrated dipole.

7.3. Test Results

Frequency		Dielectric Parameters (±12.1% window)			
		ϵ_r		σ (s/m)	
		Measurement value	Recommended value	Measurement value	Recommended value
2450MHz	2402MHz	38.913 -0.73%	39.20	1.828 1.56%	1.80
	2441MHz	38.734 -1.19%		1.878 4.33%	
	2480MHz	38.579 -1.58%		1.917 6.50%	



Figure 4.4: Liquid depth in the Flat Phantom

Left side:

Band	Freq.	Test Position	Output Power		Measured Results		Scaled-1		Scaled-Final		Power Drift (dB)
			Max. Scaled AV Power (dBm)	Measured AV Power (dBm)	SAR1g (W/kg)	SAR10g (W/kg)	SAR1g (W/kg)	SAR10g (W/kg)	SAR1g (W/kg)	SAR10g (W/kg)	
BDR +EDR (DH5)	2402	Front	10.50	10.04	0.257	0.078	0.2857	0.0867	0.4926	0.1495	0.19
	2441	Top	11.50	11.23	0.021	0.00974	0.0223	0.0104	0.0385	0.0179	0.16
		Right			0.046	0.018	0.0490	0.0192	0.0844	0.0330	0.16
		Left			0.028	0.011	0.0298	0.0117	0.0514	0.0202	0.16
		Front			0.269	0.082	0.2863	0.0873	0.4935	0.1504	0.12
		Cochlea			0.046	0.016	0.0490	0.0170	0.0844	0.0294	0.15
		Bottom			0.037	0.014	0.0394	0.0149	0.0679	0.0257	-0.01
	2480	Front	10.00	9.81	0.279	0.085	0.2915	0.0888	0.5025	0.1531	0.16

Conclusion: PASS

Note :

Factor= Max. Scaled AV Power(W)/Measured Power(W)

Scaled SAR-1= Measured SAR*Factor

Scaled-Final= Scaled SAR-1*(1/Duty Cycle)

The Max. Reported SAR : 0.5025W/kg for 1g SAR

Right side:

Band	Freq.	Test Position	Output Power		Measured Results		Scaled-1		Scaled-Final		Power Drift (dB)
			Max. Scaled AV Power (dBm)	Measured AV Power (dBm)	SAR1g (W/kg)	SAR10g (W/kg)	SAR1g (W/kg)	SAR10g (W/kg)	SAR1g (W/kg)	SAR10g (W/kg)	
BDR +EDR (DH5)	2402	Front	11.50	11.17	0.417	0.122	0.4499	0.1316	0.7757	0.2270	0.05
	2441	Top	12.00	11.78	0.031	0.015	0.0326	0.0158	0.0562	0.0272	0.17
		Right			0.100	0.041	0.1052	0.0431	0.1814	0.0744	0.11
		Left			0.186	0.070	0.1957	0.0736	0.3374	0.1270	0.10
		Front			0.430	0.126	0.4523	0.1325	0.7799	0.2285	0.19
		Cochlea			0.025	0.014	0.0263	0.0147	0.0453	0.0254	-0.13
		Bottom			0.030	0.014	0.0316	0.0147	0.0544	0.0254	0.17
	2480	Front	10.50	10.39	0.451	0.132	0.4626	0.1354	0.7975	0.2334	0.05

Conclusion: PASS

Note :

Factor= Max. Scaled AV Power(W)/Measured Power(W)

Scaled SAR-1= Measured SAR*Factor

Scaled-Final= Scaled SAR-1*(1/Duty Cycle)

The Max. Reported SAR : 0.7975W/kg for 1g SAR

ANNEX A: SYSTEM CHECK RESULTS

Test Laboratory: Audix SAR Lab

Date: 20/08/2020

CW 2450

DUT: Dipole 2450 MHz D2450V2; Type: D2450V2; Serial: D2450V2 - SN: 862

Communication System: UID 0, CW (0); Communication System Band: D2450 (2450.0 MHz); Frequency: 2450 MHz; Communication System PAR: 0 dB

Medium parameters used: $f = 2450$ MHz; $\sigma = 1.81$ S/m; $\epsilon_r = 39.15$; $\rho = 1000$ kg/m³

Phantom section: Flat Section

DASY5 Configuration:

- Probe: EX3DV4 - SN3767; ConvF(7.46, 7.46, 7.46); Calibrated: 01/04/2020;
- Modulation Compensation:
- Sensor-Surface: 4mm (Mechanical Surface Detection)
- Electronics: DAE4 Sn899; Calibrated: 18/03/2020
- Phantom: SAM1; Type: SAM; Serial: TP-1543
- Measurement SW: DASY52, Version 52.8 (8); SEMCAD X Version 14.6.10 (7331)

Configuration/CW 2450MHz/Area Scan (61x71x1): Interpolated grid: dx=2.000 mm, dy=2.000 mm

Maximum value of SAR (interpolated) = 16.7 W/kg

Configuration/CW 2450MHz/Zoom Scan (7x7x7)/Cube 0: Measurement grid:

dx=5mm, dy=5mm, dz=5mm

Reference Value = 82.10 V/m; Power Drift = 0.14 dB

Peak SAR (extrapolated) = 29.1 W/kg

SAR(1 g) = 12.9 W/kg; SAR(10 g) = 5.73 W/kg

Maximum value of SAR (measured) = 14.5 W/kg

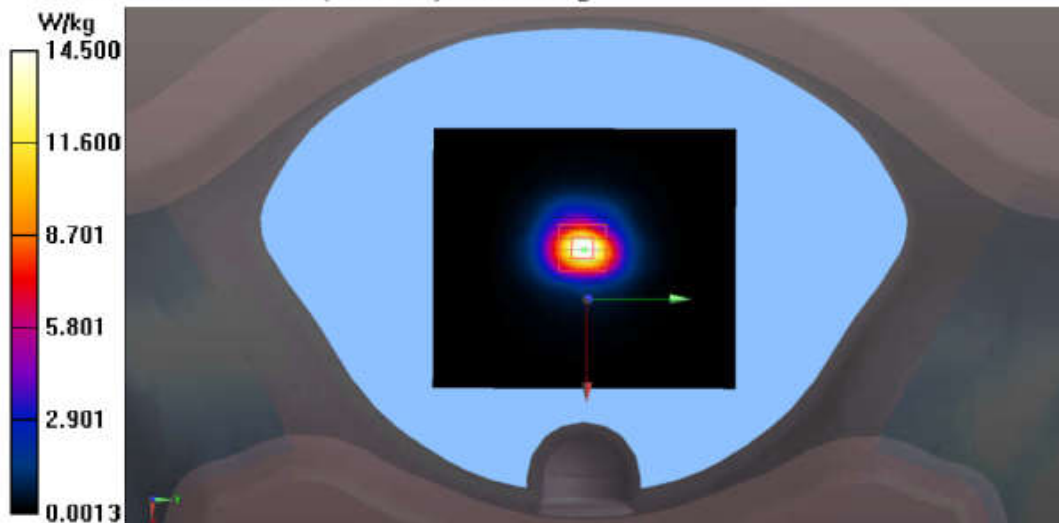

ANNEX B: TEST PLOTS

Left side:
(BDR+EDR)

Test Laboratory: Audix SAR Lab

Date: 20/08/2020

CH0(2402MHz Front)

DUT: BLUETOOTH HEADSET M/N:LIVE PRO+ TWS

Communication System: UID 0, Blue Tooth (0); Communication System Band: Mid;

Frequency: 2402 MHz; Communication System PAR: 0 dB

Medium parameters used: $f = 2402$ MHz; $\sigma = 1.828$ S/m; $\epsilon_r = 38.913$; $\rho = 1000$ kg/m³

Phantom section: Flat Section

DASY5 Configuration:

- Probe: EX3DV4 - SN3767; ConvF(7.46, 7.46, 7.46); Calibrated: 01/04/2020;
- Modulation Compensation:
- Sensor-Surface: 4mm (Mechanical Surface Detection)
- Electronics: DAE4 Sn899; Calibrated: 18/03/2020
- Phantom: SAM1; Type: SAM; Serial: TP-1543
- Measurement SW: DASY52, Version 52.8 (8); SEMCAD X Version 14.6.10 (7331)

Configuration/CH0(2402MHz Front)/Area Scan (51x51x1): Interpolated grid:

$dx=1.500$ mm, $dy=1.500$ mm

Maximum value of SAR (interpolated) = 0.275 W/kg

Configuration/CH0(2402MHz Front)/Zoom Scan (5x5x7)/Cube 0:

Measurement grid: $dx=8$ mm, $dy=8$ mm, $dz=5$ mm

Reference Value = 6.109 V/m; Power Drift = 0.19 dB

Peak SAR (extrapolated) = 0.881 W/kg

SAR(1 g) = 0.257 W/kg; SAR(10 g) = 0.078 W/kg

Maximum value of SAR (measured) = 0.303 W/kg

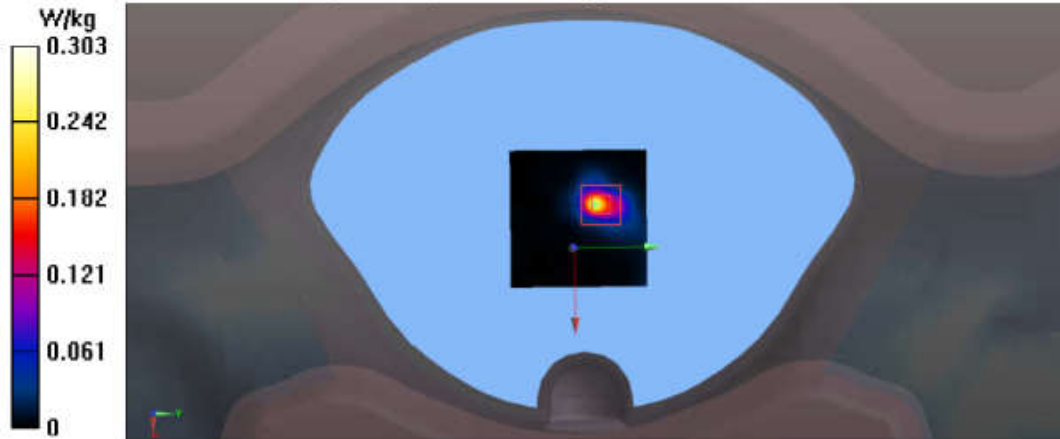

Test Laboratory: Audix SAR Lab

Date: 20/08/2020

CH39(2441MHz Bottom)

DUT: BLUETOOTH HEADSET M/N:LIVE PRO+ TWS

Communication System: UID 0, Blue Tooth (0); Communication System Band: Mid;

Frequency: 2441 MHz; Communication System PAR: 0 dB

Medium parameters used (interpolated): $f = 2441$ MHz; $\sigma = 1.878$ S/m; $\epsilon_r = 38.734$; $\rho = 1000$ kg/m³

Phantom section: Flat Section

DASY5 Configuration:

- Probe: EX3DV4 - SN3767; ConvF(7.46, 7.46, 7.46); Calibrated: 01/04/2020;
- Modulation Compensation:
- Sensor-Surface: 4mm (Mechanical Surface Detection)
- Electronics: DAE4 Sn899; Calibrated: 18/03/2020
- Phantom: SAM1; Type: SAM; Serial: TP-1543
- Measurement SW: DASY52, Version 52.8 (8); SEMCAD X Version 14.6.10 (7331)

Configuration/CH39(2441MHz Bottom)/Area Scan (51x51x1): Interpolated grid:

$dx = 1.500$ mm, $dy = 1.500$ mm

Maximum value of SAR (interpolated) = 0.0383 W/kg

Configuration/CH39(2441MHz Bottom)/Zoom Scan (5x5x7)/Cube 0:

Measurement grid: $dx = 8$ mm, $dy = 8$ mm, $dz = 5$ mm

Reference Value = 2.991 V/m; Power Drift = -0.01 dB

Peak SAR (extrapolated) = 0.0920 W/kg

SAR(1 g) = 0.037 W/kg; SAR(10 g) = 0.014 W/kg

Maximum value of SAR (measured) = 0.0415 W/kg

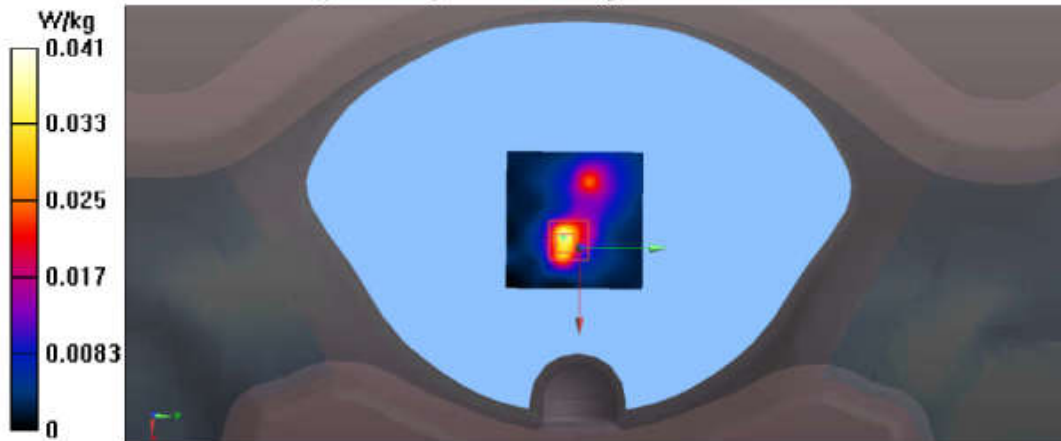

Test Laboratory: Audix SAR Lab

Date: 20/08/2020

CH39(2441MHz Cochlea Side)

DUT: BLUETOOTH HEADSET M/N:LIVE PRO+ TWS

Communication System: UID 0, Blue Tooth (0); Communication System Band: Mid;

Frequency: 2441 MHz; Communication System PAR: 0 dB

Medium parameters used (interpolated): $f = 2441$ MHz; $\sigma = 1.878$ S/m; $\epsilon_r = 38.734$; $\rho = 1000$ kg/m³

Phantom section: Flat Section

DASY5 Configuration:

- Probe: EX3DV4 - SN3767; ConvF(7.46, 7.46, 7.46); Calibrated: 01/04/2020;
- Modulation Compensation:
- Sensor-Surface: 4mm (Mechanical Surface Detection)
- Electronics: DAE4 Sn899; Calibrated: 18/03/2020
- Phantom: SAM1; Type: SAM; Serial: TP-1543
- Measurement SW: DASY52, Version 52.8 (8); SEMCAD X Version 14.6.10 (7331)

Configuration/CH39(2441MHz Cochlea Side)/Area Scan (51x51x1):

Interpolated grid: dx=1.500 mm, dy=1.500 mm

Maximum value of SAR (interpolated) = 0.0305 W/kg

Configuration/CH39(2441MHz Cochlea Side)/Zoom Scan (5x5x7)/Cube 0:

Measurement grid: dx=8mm, dy=8mm, dz=5mm

Reference Value = 2.790 V/m; Power Drift = 0.15 dB

Peak SAR (extrapolated) = 0.153 W/kg

SAR(1 g) = 0.046 W/kg; SAR(10 g) = 0.016 W/kg

Maximum value of SAR (measured) = 0.0463 W/kg

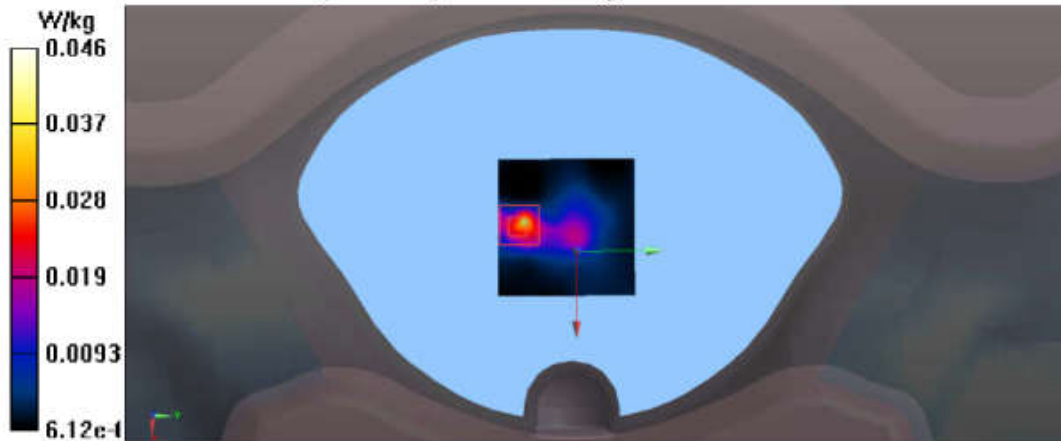

Test Laboratory: Audix SAR Lab

Date: 20/08/2020

CH39(2441MHz Front)

DUT: BLUETOOTH HEADSET M/N:LIVE PRO+ TWS

Communication System: UID 0, Blue Tooth (0); Communication System Band: Mid;

Frequency: 2441 MHz; Communication System PAR: 0 dB

Medium parameters used (interpolated): $f = 2441$ MHz; $\sigma = 1.878$ S/m; $\epsilon_r = 38.734$; $\rho = 1000$ kg/m³

Phantom section: Flat Section

DASY5 Configuration:

- Probe: EX3DV4 - SN3767; ConvF(7.46, 7.46, 7.46); Calibrated: 01/04/2020;
- Modulation Compensation:
- Sensor-Surface: 4mm (Mechanical Surface Detection)
- Electronics: DAE4 Sn899; Calibrated: 18/03/2020
- Phantom: SAM1; Type: SAM; Serial: TP-1543
- Measurement SW: DASY52, Version 52.8 (8); SEMCAD X Version 14.6.10 (7331)

Configuration/CH39(2441MHz Front)/Area Scan (51x51x1): Interpolated grid:

$dx=1.500$ mm, $dy=1.500$ mm

Maximum value of SAR (interpolated) = 0.288 W/kg

Configuration/CH39(2441MHz Front)/Zoom Scan (5x5x7)/Cube 0:

Measurement grid: $dx=8$ mm, $dy=8$ mm, $dz=5$ mm

Reference Value = 6.152 V/m; Power Drift = 0.12 dB

Peak SAR (extrapolated) = 0.944 W/kg

SAR(1 g) = 0.269 W/kg; SAR(10 g) = 0.082 W/kg

Maximum value of SAR (measured) = 0.313 W/kg

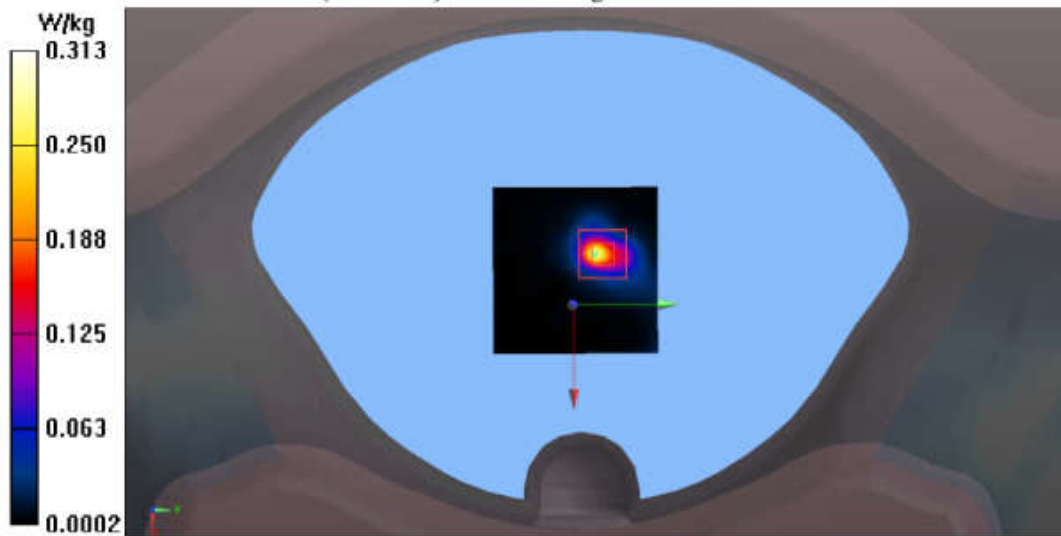

Test Laboratory: Audix SAR Lab

Date: 20/08/2020

CH39(2441MHz Left)

DUT: BLUETOOTH HEADSET M/N:LIVE PRO+ TWS

Communication System: UID 0, Blue Tooth (0); Communication System Band: Mid;

Frequency: 2441 MHz; Communication System PAR: 0 dB

Medium parameters used (interpolated): $f = 2441$ MHz; $\sigma = 1.878$ S/m; $\epsilon_r = 38.734$; $\rho = 1000$ kg/m³

Phantom section: Flat Section

DASY5 Configuration:

- Probe: EX3DV4 - SN3767; ConvF(7.46, 7.46, 7.46); Calibrated: 01/04/2020;
- Modulation Compensation:
- Sensor-Surface: 4mm (Mechanical Surface Detection)
- Electronics: DAE4 Sn899; Calibrated: 18/03/2020
- Phantom: SAM1; Type: SAM; Serial: TP-1543
- Measurement SW: DASY52, Version 52.8 (8); SEMCAD X Version 14.6.10 (7331)

Configuration/CH39(2441MHz Left)/Area Scan (51x51x1): Interpolated grid:

$dx = 1.500$ mm, $dy = 1.500$ mm

Maximum value of SAR (interpolated) = 0.0332 W/kg

Configuration/CH39(2441MHz Left)/Zoom Scan (5x5x7)/Cube 0: Measurement

grid: $dx = 8$ mm, $dy = 8$ mm, $dz = 5$ mm

Reference Value = 0.9850 V/m; Power Drift = 0.16 dB

Peak SAR (extrapolated) = 0.0730 W/kg

SAR(1 g) = 0.028 W/kg; SAR(10 g) = 0.011 W/kg

Maximum value of SAR (measured) = 0.0335 W/kg

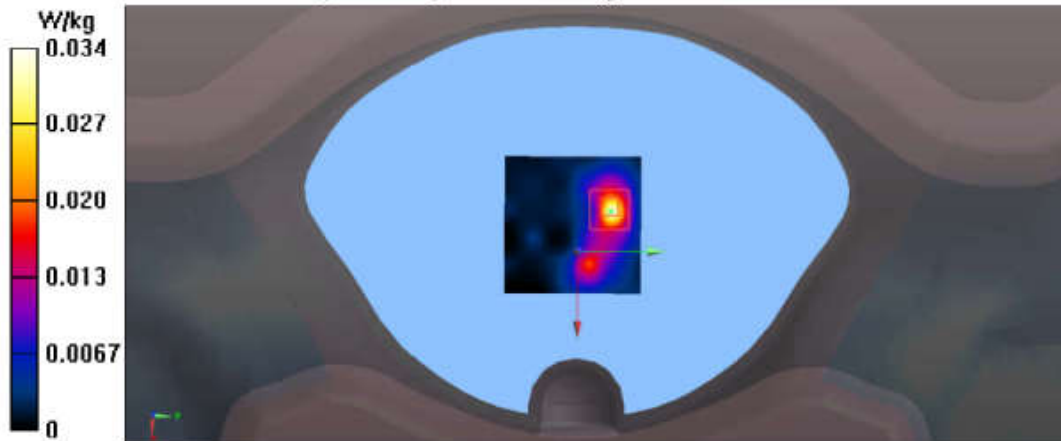

Test Laboratory: Audix SAR Lab

Date: 20/08/2020

CH39(2441MHz Right)

DUT: BLUETOOTH HEADSET M/N:LIVE PRO+ TWS

Communication System: UID 0, Blue Tooth (0); Communication System Band: Mid;

Frequency: 2441 MHz; Communication System PAR: 0 dB

Medium parameters used (interpolated): $f = 2441$ MHz; $\sigma = 1.878$ S/m; $\epsilon_r = 38.734$; $\rho = 1000$ kg/m³

Phantom section: Flat Section

DASY5 Configuration:

- Probe: EX3DV4 - SN3767; ConvF(7.46, 7.46, 7.46); Calibrated: 01/04/2020;
- Modulation Compensation:
- Sensor-Surface: 4mm (Mechanical Surface Detection)
- Electronics: DAE4 Sn899; Calibrated: 18/03/2020
- Phantom: SAM1; Type: SAM; Serial: TP-1543
- Measurement SW: DASY52, Version 52.8 (8); SEMCAD X Version 14.6.10 (7331)

Configuration/CH39(2441MHz Right)/Area Scan (51x51x1): Interpolated grid:

$dx = 1.500$ mm, $dy = 1.500$ mm

Maximum value of SAR (interpolated) = 0.0506 W/kg

Configuration/CH39(2441MHz Right)/Zoom Scan (5x5x7)/Cube 0:

Measurement grid: $dx = 8$ mm, $dy = 8$ mm, $dz = 5$ mm

Reference Value = 3.134 V/m; Power Drift = 0.16 dB

Peak SAR (extrapolated) = 0.124 W/kg

SAR(1 g) = 0.046 W/kg; SAR(10 g) = 0.018 W/kg

Maximum value of SAR (measured) = 0.0502 W/kg

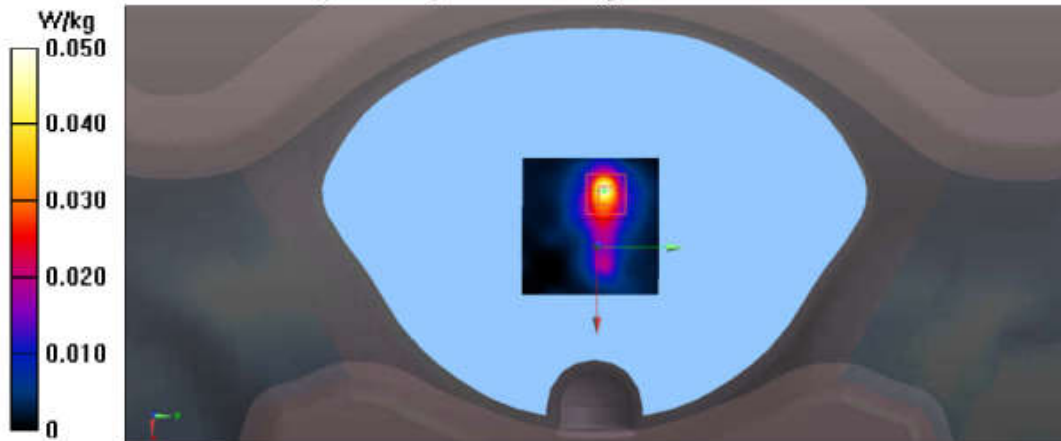

Test Laboratory: Audix SAR Lab

Date: 20/08/2020

CH39(2441MHz Top)

DUT: BLUETOOTH HEADSET M/N:LIVE PRO+ TWS

Communication System: UID 0, Blue Tooth (0); Communication System Band: Mid;

Frequency: 2441 MHz; Communication System PAR: 0 dB

Medium parameters used (interpolated): $f = 2441$ MHz; $\sigma = 1.878$ S/m; $\epsilon_r = 38.734$; $\rho = 1000$ kg/m³

Phantom section: Flat Section

DASY5 Configuration:

- Probe: EX3DV4 - SN3767; ConvF(7.46, 7.46, 7.46); Calibrated: 01/04/2020;
- Modulation Compensation:
- Sensor-Surface: 4mm (Mechanical Surface Detection)
- Electronics: DAE4 Sn899; Calibrated: 18/03/2020
- Phantom: SAM1; Type: SAM; Serial: TP-1543
- Measurement SW: DASY52, Version 52.8 (8); SEMCAD X Version 14.6.10 (7331)

Configuration/CH39(2441MHz Top)/Area Scan (51x51x1): Interpolated grid:

$dx = 1.500$ mm, $dy = 1.500$ mm

Maximum value of SAR (interpolated) = 0.0227 W/kg

Configuration/CH39(2441MHz Top)/Zoom Scan (5x5x7)/Cube 0: Measurement

grid: $dx = 8$ mm, $dy = 8$ mm, $dz = 5$ mm

Reference Value = 3.117 V/m; Power Drift = 0.16 dB

Peak SAR (extrapolated) = 0.0500 W/kg

SAR(1 g) = 0.021 W/kg; SAR(10 g) = 0.00974 W/kg

Maximum value of SAR (measured) = 0.0230 W/kg

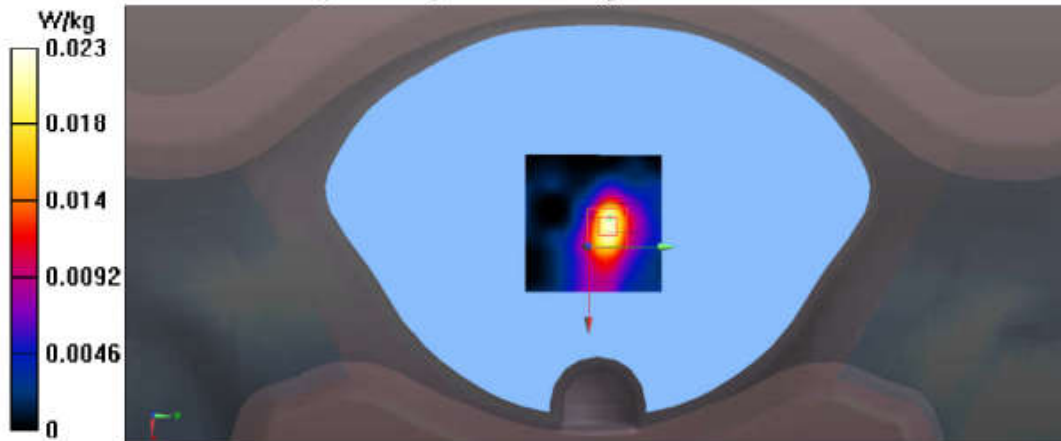

Test Laboratory: Audix SAR Lab

Date: 20/08/2020

CH78(2480MHz Front)

DUT: BLUETOOTH HEADSET M/N:LIVE PRO+ TWS

Communication System: UID 0, Blue Tooth (0); Communication System Band: Mid;

Frequency: 2480 MHz; Communication System PAR: 0 dB

Medium parameters used: $f = 2480$ MHz; $\sigma = 1.917$ S/m; $\epsilon_r = 38.579$; $\rho = 1000$ kg/m³

Phantom section: Flat Section

DASY5 Configuration:

- Probe: EX3DV4 - SN3767; ConvF(7.46, 7.46, 7.46); Calibrated: 01/04/2020;
- Modulation Compensation:
- Sensor-Surface: 4mm (Mechanical Surface Detection)
- Electronics: DAE4 Sn899; Calibrated: 18/03/2020
- Phantom: SAM1; Type: SAM; Serial: TP-1543
- Measurement SW: DASY52, Version 52.8 (8); SEMCAD X Version 14.6.10 (7331)

Configuration/CH78(2480MHz Front)/Area Scan (51x51x1): Interpolated grid:

$dx=1.500$ mm, $dy=1.500$ mm

Maximum value of SAR (interpolated) = 0.295 W/kg

Configuration/CH78(2480MHz Front)/Zoom Scan (5x5x7)/Cube 0:

Measurement grid: $dx=8$ mm, $dy=8$ mm, $dz=5$ mm

Reference Value = 6.155 V/m; Power Drift = 0.16 dB

Peak SAR (extrapolated) = 0.981 W/kg

SAR(1 g) = 0.279 W/kg; SAR(10 g) = 0.085 W/kg

Maximum value of SAR (measured) = 0.323 W/kg

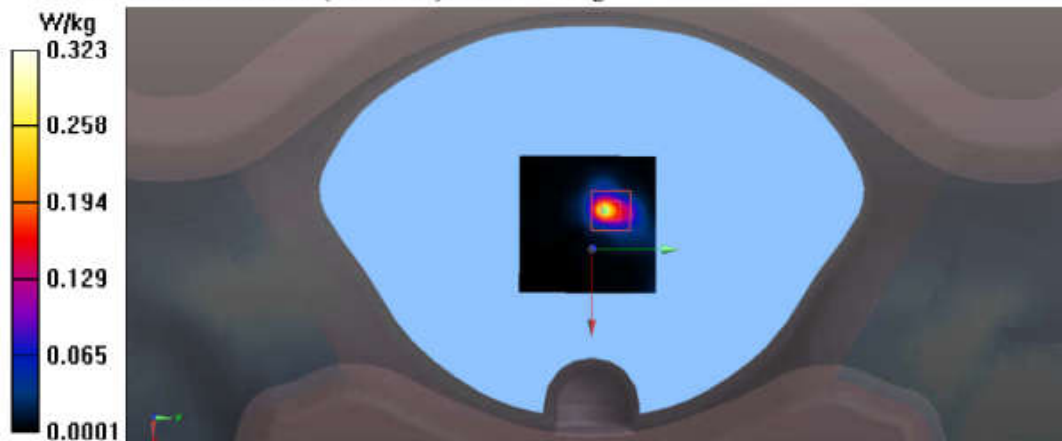

Right side:
(BDR+EDR)

Test Laboratory: Audix SAR Lab

Date: 20/08/2020

CH0(2402MHz Front)

DUT: BLUETOOTH HEADSET M/N:LIVE PRO+ TWS

Communication System: UID 0, Blue Tooth (0); Communication System Band: Mid;

Frequency: 2402 MHz; Communication System PAR: 0 dB

Medium parameters used: $f = 2402$ MHz; $\sigma = 1.828$ S/m; $\epsilon_r = 38.913$; $\rho = 1000$ kg/m³

Phantom section: Flat Section

DASY5 Configuration:

- Probe: EX3DV4 - SN3767; ConvF(7.46, 7.46, 7.46); Calibrated: 01/04/2020;
- Modulation Compensation:
- Sensor-Surface: 4mm (Mechanical Surface Detection)
- Electronics: DAE4 Sn899; Calibrated: 18/03/2020
- Phantom: SAM1; Type: SAM; Serial: TP-1543
- Measurement SW: DASY52, Version 52.8 (8); SEMCAD X Version 14.6.10 (7331)

Configuration/CH0(2402MHz Front)/Area Scan (51x51x1): Interpolated grid:

$dx=1.500$ mm, $dy=1.500$ mm

Maximum value of SAR (interpolated) = 0.364 W/kg

Configuration/CH0(2402MHz Front)/Zoom Scan (5x5x7)/Cube 0:

Measurement grid: $dx=8$ mm, $dy=8$ mm, $dz=5$ mm

Reference Value = 17.17 V/m; Power Drift = 0.05 dB

Peak SAR (extrapolated) = 1.41 W/kg

SAR(1 g) = 0.417 W/kg; SAR(10 g) = 0.122 W/kg

Maximum value of SAR (measured) = 0.389 W/kg

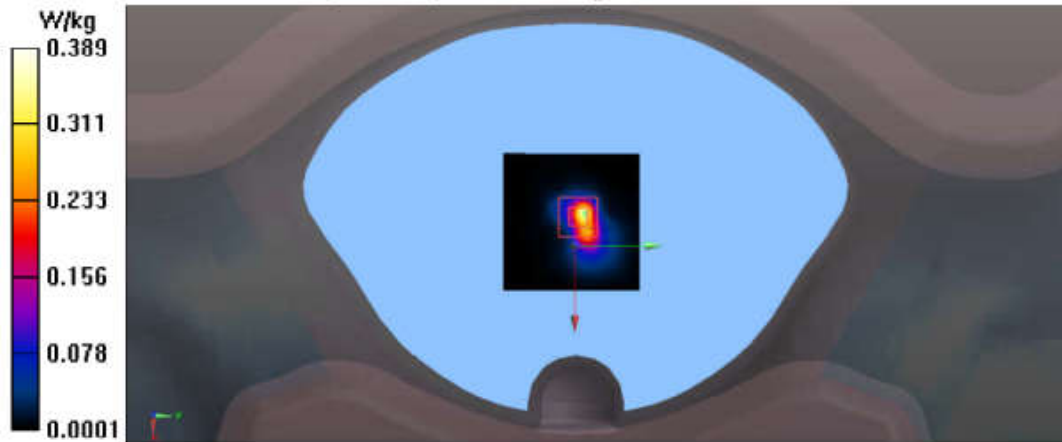

Test Laboratory: Audix SAR Lab

Date: 20/08/2020

CH39(2441MHz Bottom)

DUT: BLUETOOTH HEADSET M/N:LIVE PRO+ TWS

Communication System: UID 0, Blue Tooth (0); Communication System Band: Mid;

Frequency: 2441 MHz; Communication System PAR: 0 dB

Medium parameters used (interpolated): $f = 2441$ MHz; $\sigma = 1.878$ S/m; $\epsilon_r = 38.734$; $\rho = 1000$ kg/m³

Phantom section: Flat Section

DASY5 Configuration:

- Probe: EX3DV4 - SN3767; ConvF(7.46, 7.46, 7.46); Calibrated: 01/04/2020;
- Modulation Compensation:
- Sensor-Surface: 4mm (Mechanical Surface Detection)
- Electronics: DAE4 Sn899; Calibrated: 18/03/2020
- Phantom: SAM1; Type: SAM; Serial: TP-1543
- Measurement SW: DASY52, Version 52.8 (8); SEMCAD X Version 14.6.10 (7331)

Configuration/CH39(2441MHz Bottom)/Area Scan (51x51x1): Interpolated grid:

$dx = 1.500$ mm, $dy = 1.500$ mm

Maximum value of SAR (interpolated) = 0.0349 W/kg

Configuration/CH39(2441MHz Bottom)/Zoom Scan (5x5x7)/Cube 0:

Measurement grid: $dx = 8$ mm, $dy = 8$ mm, $dz = 5$ mm

Reference Value = 2.843 V/m; Power Drift = 0.17 dB

Peak SAR (extrapolated) = 0.0650 W/kg

SAR(1 g) = 0.030 W/kg; SAR(10 g) = 0.014 W/kg

Maximum value of SAR (measured) = 0.0332 W/kg

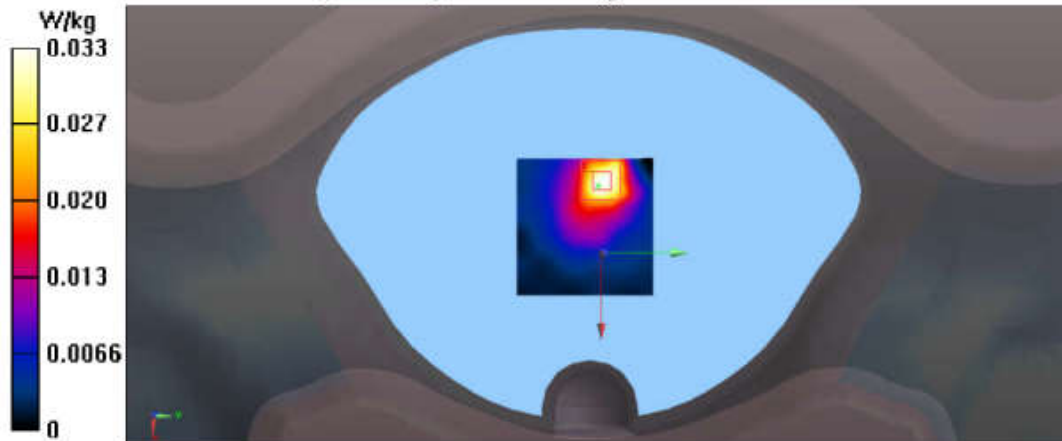

Test Laboratory: Audix SAR Lab

Date: 20/08/2020

CH39(2441MHz Cochlea Side)

DUT: BLUETOOTH HEADSET M/N:LIVE PRO+ TWS

Communication System: UID 0, Blue Tooth (0); Communication System Band: Mid;

Frequency: 2441 MHz; Communication System PAR: 0 dB

Medium parameters used (interpolated): $f = 2441$ MHz; $\sigma = 1.878$ S/m; $\epsilon_r = 38.734$; $\rho = 1000$ kg/m³

Phantom section: Flat Section

DASY5 Configuration:

- Probe: EX3DV4 - SN3767; ConvF(7.46, 7.46, 7.46); Calibrated: 01/04/2020;
- Modulation Compensation:
- Sensor-Surface: 4mm (Mechanical Surface Detection)
- Electronics: DAE4 Sn899; Calibrated: 18/03/2020
- Phantom: SAM1; Type: SAM; Serial: TP-1543
- Measurement SW: DASY52, Version 52.8 (8); SEMCAD X Version 14.6.10 (7331)

Configuration/CH39(2441MHz Cochlea Side)/Area Scan (51x51x1):

Interpolated grid: dx=1.500 mm, dy=1.500 mm

Maximum value of SAR (interpolated) = 0.0296 W/kg

Configuration/CH39(2441MHz Cochlea Side)/Zoom Scan (5x5x7)/Cube 0:

Measurement grid: dx=8mm, dy=8mm, dz=5mm

Reference Value = 3.547 V/m; Power Drift = -0.13 dB

Peak SAR (extrapolated) = 0.0640 W/kg

SAR(1 g) = 0.025 W/kg; SAR(10 g) = 0.014 W/kg

Maximum value of SAR (measured) = 0.0263 W/kg

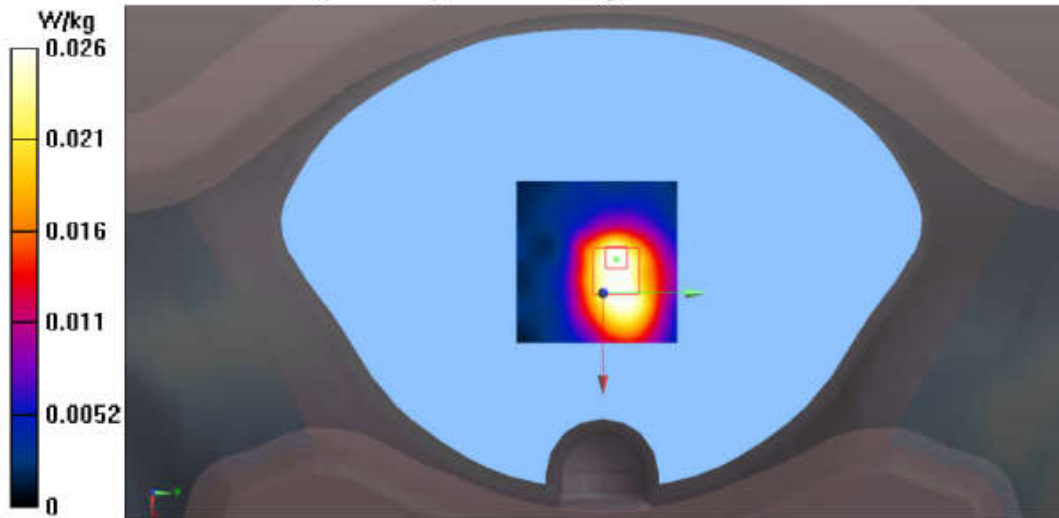

Test Laboratory: Audix SAR Lab

Date: 20/08/2020

CH39(2441MHz Front)

DUT: BLUETOOTH HEADSET M/N:LIVE PRO+ TWS

Communication System: UID 0, Blue Tooth (0); Communication System Band: Mid;

Frequency: 2441 MHz; Communication System PAR: 0 dB

Medium parameters used (interpolated): $f = 2441$ MHz; $\sigma = 1.878$ S/m; $\epsilon_r = 38.734$; $\rho = 1000$ kg/m³

Phantom section: Flat Section

DASY5 Configuration:

- Probe: EX3DV4 - SN3767; ConvF(7.46, 7.46, 7.46); Calibrated: 01/04/2020;
- Modulation Compensation:
- Sensor-Surface: 4mm (Mechanical Surface Detection)
- Electronics: DAE4 Sn899; Calibrated: 18/03/2020
- Phantom: SAM1; Type: SAM; Serial: TP-1543
- Measurement SW: DASY52, Version 52.8 (8); SEMCAD X Version 14.6.10 (7331)

Configuration/CH39(2441MHz Front)/Area Scan (51x51x1): Interpolated grid:

$dx = 1.500$ mm, $dy = 1.500$ mm

Maximum value of SAR (interpolated) = 0.376 W/kg

Configuration/CH39(2441MHz Front)/Zoom Scan (5x5x7)/Cube 0:

Measurement grid: $dx = 8$ mm, $dy = 8$ mm, $dz = 5$ mm

Reference Value = 16.77 V/m; Power Drift = 0.19 dB

Peak SAR (extrapolated) = 1.45 W/kg

SAR(1 g) = 0.430 W/kg; SAR(10 g) = 0.126 W/kg

Maximum value of SAR (measured) = 0.412 W/kg

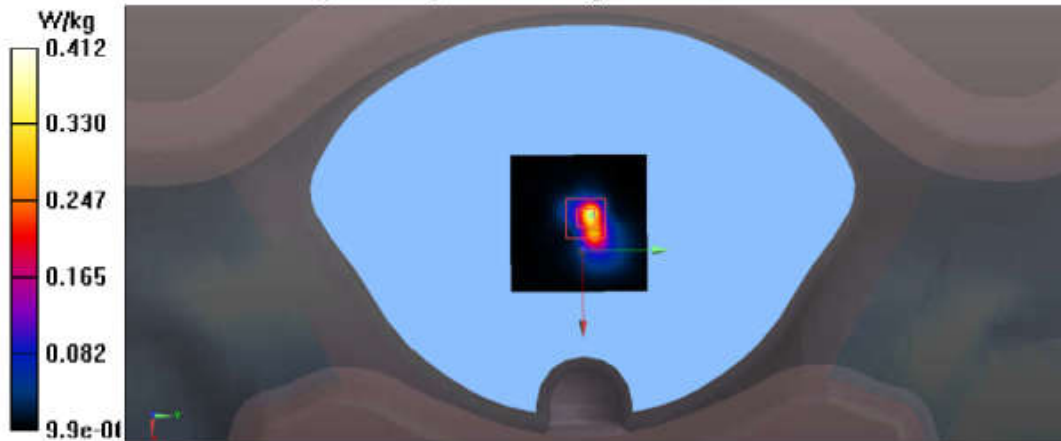

Test Laboratory: Audix SAR Lab

Date: 20/08/2020

CH39(2441MHz Left)

DUT: BLUETOOTH HEADSET M/N:LIVE PRO+ TWS

Communication System: UID 0, Blue Tooth (0); Communication System Band: Mid;

Frequency: 2441 MHz; Communication System PAR: 0 dB

Medium parameters used (interpolated): $f = 2441$ MHz; $\sigma = 1.878$ S/m; $\epsilon_r = 38.734$; $\rho = 1000$ kg/m³

Phantom section: Flat Section

DASY5 Configuration:

- Probe: EX3DV4 - SN3767; ConvF(7.46, 7.46, 7.46); Calibrated: 01/04/2020;
- Modulation Compensation:
- Sensor-Surface: 4mm (Mechanical Surface Detection)
- Electronics: DAE4 Sn899; Calibrated: 18/03/2020
- Phantom: SAM1; Type: SAM; Serial: TP-1543
- Measurement SW: DASY52, Version 52.8 (8); SEMCAD X Version 14.6.10 (7331)

Configuration/CH39(2441MHz Left)/Area Scan (51x51x1): Interpolated grid:

$dx = 1.500$ mm, $dy = 1.500$ mm

Maximum value of SAR (interpolated) = 0.188 W/kg

Configuration/CH39(2441MHz Left)/Zoom Scan (5x5x7)/Cube 0: Measurement

grid: $dx = 8$ mm, $dy = 8$ mm, $dz = 5$ mm

Reference Value = 10.21 V/m; Power Drift = 0.10 dB

Peak SAR (extrapolated) = 0.528 W/kg

SAR(1 g) = 0.186 W/kg; SAR(10 g) = 0.070 W/kg

Maximum value of SAR (measured) = 0.198 W/kg

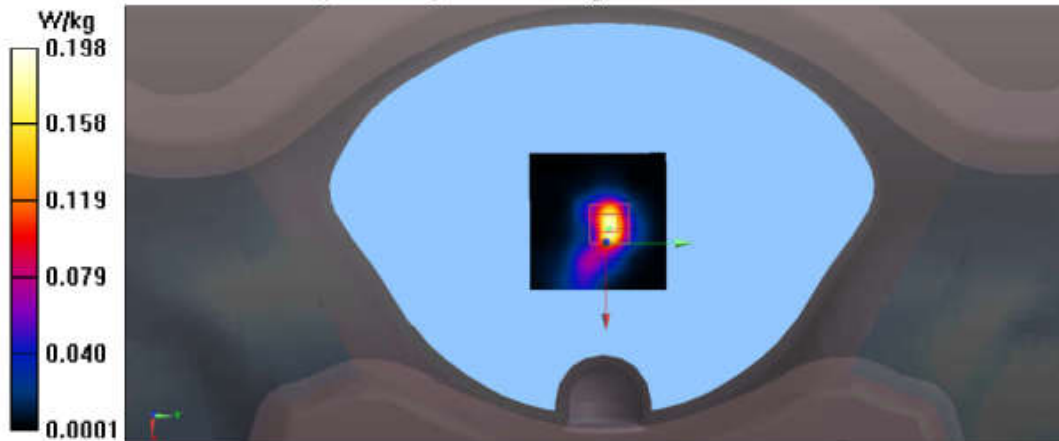

Test Laboratory: Audix SAR Lab

Date: 20/08/2020

CH39(2441MHz Right)

DUT: BLUETOOTH HEADSET M/N:LIVE PRO+ TWS

Communication System: UID 0, Blue Tooth (0); Communication System Band: Mid;

Frequency: 2441 MHz; Communication System PAR: 0 dB

Medium parameters used (interpolated): $f = 2441$ MHz; $\sigma = 1.878$ S/m; $\epsilon_r = 38.734$; $\rho = 1000$ kg/m³

Phantom section: Flat Section

DASY5 Configuration:

- Probe: EX3DV4 - SN3767; ConvF(7.46, 7.46, 7.46); Calibrated: 01/04/2020;
- Modulation Compensation:
- Sensor-Surface: 4mm (Mechanical Surface Detection)
- Electronics: DAE4 Sn899; Calibrated: 18/03/2020
- Phantom: SAM1; Type: SAM; Serial: TP-1543
- Measurement SW: DASY52, Version 52.8 (8); SEMCAD X Version 14.6.10 (7331)

Configuration/CH39(2441MHz Right)/Area Scan (51x51x1): Interpolated grid:

dx=1.500 mm, dy=1.500 mm

Maximum value of SAR (interpolated) = 0.113 W/kg

Configuration/CH39(2441MHz Right)/Zoom Scan (5x5x7)/Cube 0:

Measurement grid: dx=8mm, dy=8mm, dz=5mm

Reference Value = 5.822 V/m; Power Drift = 0.11 dB

Peak SAR (extrapolated) = 0.256 W/kg

SAR(1 g) = 0.100 W/kg; SAR(10 g) = 0.041 W/kg

Maximum value of SAR (measured) = 0.112 W/kg

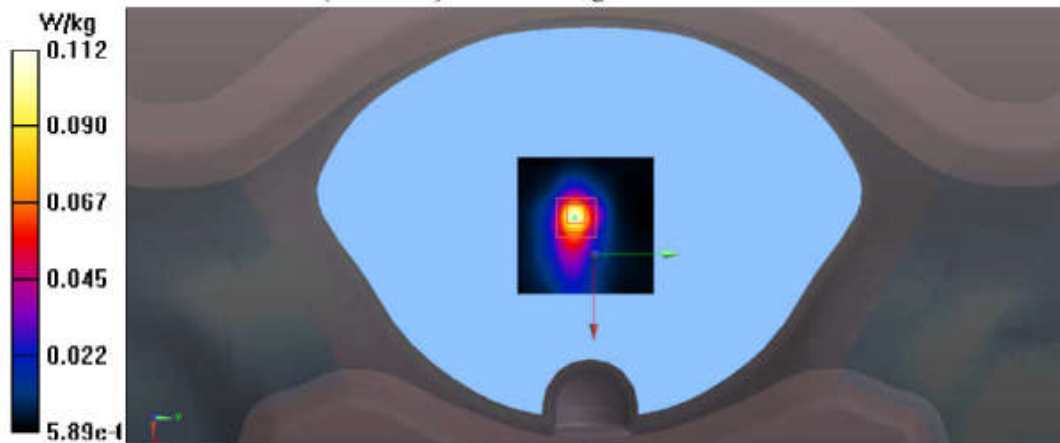

Test Laboratory: Audix SAR Lab

Date: 20/08/2020

CH39(2441MHz Top)

DUT: BLUETOOTH HEADSET M/N:LIVE PRO+ TWS

Communication System: UID 0, Blue Tooth (0); Communication System Band: Mid;

Frequency: 2441 MHz; Communication System PAR: 0 dB

Medium parameters used (interpolated): $f = 2441$ MHz; $\sigma = 1.878$ S/m; $\epsilon_r = 38.734$; $\rho = 1000$ kg/m³

Phantom section: Flat Section

DASY5 Configuration:

- Probe: EX3DV4 - SN3767; ConvF(7.46, 7.46, 7.46); Calibrated: 01/04/2020;
- Modulation Compensation:
- Sensor-Surface: 4mm (Mechanical Surface Detection)
- Electronics: DAE4 Sn899; Calibrated: 18/03/2020
- Phantom: SAM1; Type: SAM; Serial: TP-1543
- Measurement SW: DASY52, Version 52.8 (8); SEMCAD X Version 14.6.10 (7331)

Configuration/CH39(2441MHz Top)/Area Scan (51x51x1): Interpolated grid:

dx=1.500 mm, dy=1.500 mm

Maximum value of SAR (interpolated) = 0.0313 W/kg

Configuration/CH39(2441MHz Top)/Zoom Scan (5x5x7)/Cube 0: Measurement

grid: dx=8mm, dy=8mm, dz=5mm

Reference Value = 3.787 V/m; Power Drift = 0.17 dB

Peak SAR (extrapolated) = 0.0670 W/kg

SAR(1 g) = 0.031 W/kg; SAR(10 g) = 0.015 W/kg

Maximum value of SAR (measured) = 0.0325 W/kg

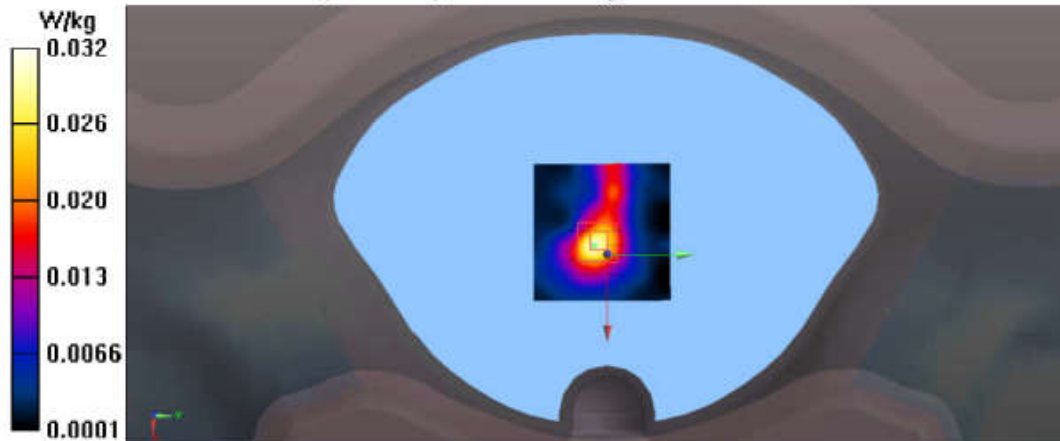

Test Laboratory: Audix SAR Lab

Date: 20/08/2020

CH78(2480MHz Front)

DUT: BLUETOOTH HEADSET M/N:LIVE PRO+ TWS

Communication System: UID 0, Blue Tooth (0); Communication System Band: Mid;

Frequency: 2480 MHz; Communication System PAR: 0 dB

Medium parameters used: $f = 2480$ MHz; $\sigma = 1.917$ S/m; $\epsilon_r = 38.579$; $\rho = 1000$ kg/m³

Phantom section: Flat Section

DASY5 Configuration:

- Probe: EX3DV4 - SN3767; ConvF(7.46, 7.46, 7.46); Calibrated: 01/04/2020;
- Modulation Compensation:
- Sensor-Surface: 4mm (Mechanical Surface Detection)
- Electronics: DAE4 Sn899; Calibrated: 18/03/2020
- Phantom: SAM1; Type: SAM; Serial: TP-1543
- Measurement SW: DASY52, Version 52.8 (8); SEMCAD X Version 14.6.10 (7331)

Configuration/CH78(2480MHz Front)/Area Scan (51x51x1): Interpolated grid:

$dx=1.500$ mm, $dy=1.500$ mm

Maximum value of SAR (interpolated) = 0.393 W/kg

Configuration/CH78(2480MHz Front)/Zoom Scan (5x5x7)/Cube 0:

Measurement grid: $dx=8$ mm, $dy=8$ mm, $dz=5$ mm

Reference Value = 17.36 V/m; Power Drift = 0.05 dB

Peak SAR (extrapolated) = 1.54 W/kg

SAR(1 g) = 0.451 W/kg; SAR(10 g) = 0.132 W/kg

Maximum value of SAR (measured) = 0.426 W/kg

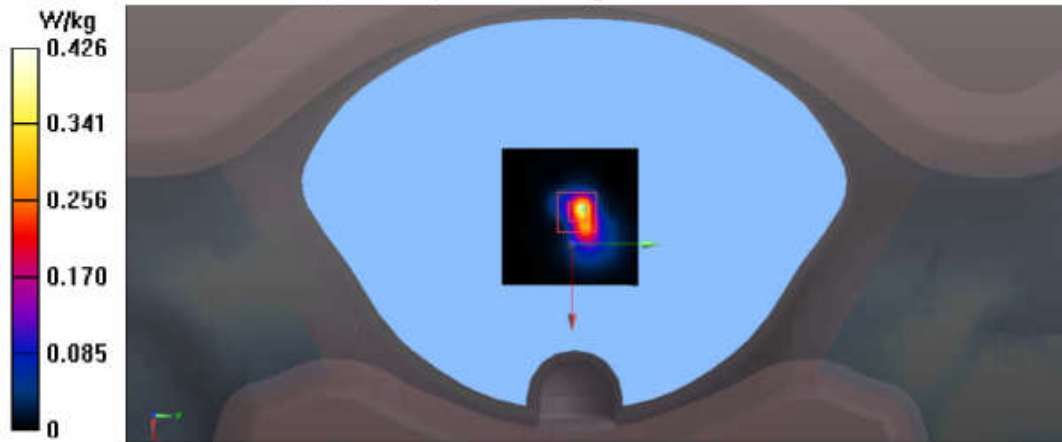

ANNEX C: DASY CABLIBRATION CERTIFICATE



Client **Audix** Certificate No: **Z20-60216**

CALIBRATION CERTIFICATE

Object: D2450V2 - SN: 862

Calibration Procedure(s): FF-Z11-003-01
Calibration Procedures for dipole validation kits



Calibration date: June 15, 2020

This calibration Certificate documents the traceability to national standards, which realize the physical units of measurements(SI). The measurements and the uncertainties with confidence probability are given on the following pages and are part of the certificate.

All calibrations have been conducted in the closed laboratory facility: environment temperature(22±3)°C and humidity<70%.

Calibration Equipment used (M&TE critical for calibration)

Primary Standards	ID #	Cal Date(Calibrated by, Certificate No.)	Scheduled Calibration
Power Meter NRP2	106277	04-Sep-19 (CTTL, No.J19X07825)	Sep-20
Power sensor NRP8S	104291	04-Sep-19 (CTTL, No.J19X07825)	Sep-20
Reference Probe EX3DV4	SN 7514	27-Sep-19(CTTL-SPEAG,No.Z19-60306)	Sep-20
DAE4	SN 1555	22-Aug-19(CTTL-SPEAG,No.Z19-60295)	Aug-20
Secondary Standards	ID #	Cal Date(Calibrated by, Certificate No.)	Scheduled Calibration
Signal Generator E4438C	MY49071430	25-Feb-20 (CTTL, No.J20X00516)	Feb-21
NetworkAnalyzer E5071C	MY46107873	10-Feb-20 (CTTL, No.J20X00515)	Feb-21

	Name	Function	Signature
Calibrated by:	Zhao Jing	SAR Test Engineer	
Reviewed by:	Lin Hao	SAR Test Engineer	
Approved by:	Qi Dianyuan	SAR Project Leader	

Issued: June 21, 2020

This calibration certificate shall not be reproduced except in full without written approval of the laboratory.



In Collaboration with
s p e a g
CALIBRATION LABORATORY

Add: No.51 Xueyuan Road, Haidian District, Beijing, 100191, China
Tel: +86-10-62304633-2079 Fax: +86-10-62304633-2504
E-mail: cttl@chinattl.com http://www.chinattl.cn

Glossary:

TSL	tissue simulating liquid
ConvF	sensitivity in TSL / NORM _{x,y,z}
N/A	not applicable or not measured

Calibration is Performed According to the Following Standards:

- IEEE Std 1528-2013, "IEEE Recommended Practice for Determining the Peak Spatial-Averaged Specific Absorption Rate (SAR) in the Human Head from Wireless Communications Devices: Measurement Techniques", June 2013
- IEC 62209-1, "Measurement procedure for assessment of specific absorption rate of human exposure to radio frequency fields from hand-held and body-mounted wireless communication devices- Part 1: Device used next to the ear (Frequency range of 300MHz to 6GHz)", July 2016
- IEC 62209-2, "Procedure to measure the Specific Absorption Rate (SAR) For wireless communication devices used in close proximity to the human body (frequency range of 30MHz to 6GHz)", March 2010
- KDB865664, SAR Measurement Requirements for 100 MHz to 6 GHz

Additional Documentation:

- DASY4/5 System Handbook

Methods Applied and Interpretation of Parameters:

- Measurement Conditions:* Further details are available from the Validation Report at the end of the certificate. All figures stated in the certificate are valid at the frequency indicated.
- Antenna Parameters with TSL:* The dipole is mounted with the spacer to position its feed point exactly below the center marking of the flat phantom section, with the arms oriented parallel to the body axis.
- Feed Point Impedance and Return Loss:* These parameters are measured with the dipole positioned under the liquid filled phantom. The impedance stated is transformed from the measurement at the SMA connector to the feed point. The Return Loss ensures low reflected power. No uncertainty required.
- Electrical Delay:* One-way delay between the SMA connector and the antenna feed point. No uncertainty required.
- SAR measured:* SAR measured at the stated antenna input power.
- SAR normalized:* SAR as measured, normalized to an input power of 1 W at the antenna connector.
- SAR for nominal TSL parameters:* The measured TSL parameters are used to calculate the nominal SAR result.

The reported uncertainty of measurement is stated as the standard uncertainty of Measurement multiplied by the coverage factor $k=2$, which for a normal distribution Corresponds to a coverage probability of approximately 95%.



In Collaboration with
s p e a g
CALIBRATION LABORATORY

Add: No.51 Xueyuan Road, Haidian District, Beijing, 100191, China
 Tel: +86-10-62304633-2079 Fax: +86-10-62304633-2504
 E-mail: cttl@chinattl.com http://www.chinattl.cn

Measurement Conditions

DASY system configuration, as far as not given on page 1.

DASY Version	DASY52	V52.10.4
Extrapolation	Advanced Extrapolation	
Phantom	Triple Flat Phantom 5.1C	
Distance Dipole Center - TSL	10 mm	with Spacer
Zoom Scan Resolution	dx, dy, dz = 5 mm	
Frequency	2450 MHz ± 1 MHz	

Head TSL parameters

The following parameters and calculations were applied.

	Temperature	Permittivity	Conductivity
Nominal Head TSL parameters	22.0 °C	39.2	1.80 mho/m
Measured Head TSL parameters	(22.0 ± 0.2) °C	39.0 ± 6 %	1.80 mho/m ± 6 %
Head TSL temperature change during test	<1.0 °C	----	----

SAR result with Head TSL

SAR averaged over 1 cm³ (1 g) of Head TSL	Condition	
SAR measured	250 mW input power	13.2 W/kg
SAR for nominal Head TSL parameters	normalized to 1W	52.7 W/kg ± 18.8 % (k=2)
SAR averaged over 10 cm³ (10 g) of Head TSL	Condition	
SAR measured	250 mW input power	6.05 W/kg
SAR for nominal Head TSL parameters	normalized to 1W	24.2 W/kg ± 18.7 % (k=2)

Body TSL parameters

The following parameters and calculations were applied.

	Temperature	Permittivity	Conductivity
Nominal Body TSL parameters	22.0 °C	52.7	1.95 mho/m
Measured Body TSL parameters	(22.0 ± 0.2) °C	52.3 ± 6 %	1.94 mho/m ± 6 %
Body TSL temperature change during test	<1.0 °C	----	----

SAR result with Body TSL

SAR averaged over 1 cm³ (1 g) of Body TSL	Condition	
SAR measured	250 mW input power	12.8 W/kg
SAR for nominal Body TSL parameters	normalized to 1W	51.3 W/kg ± 18.8 % (k=2)
SAR averaged over 10 cm³ (10 g) of Body TSL	Condition	
SAR measured	250 mW input power	5.94 W/kg
SAR for nominal Body TSL parameters	normalized to 1W	23.8 W/kg ± 18.7 % (k=2)



In Collaboration with
s p e a g
CALIBRATION LABORATORY

Add: No.51 Xueyuan Road, Haidian District, Beijing, 100191, China
Tel: +86-10-62304633-2079 Fax: +86-10-62304633-2504
E-mail: cttl@chinattl.com http://www.chinattl.cn

Appendix (Additional assessments outside the scope of CNAS L0570)

Antenna Parameters with Head TSL

Impedance, transformed to feed point	54.8Ω+ 2.09 jΩ
Return Loss	- 26.0dB

Antenna Parameters with Body TSL

Impedance, transformed to feed point	47.3Ω+ 3.17 jΩ
Return Loss	- 27.4dB

General Antenna Parameters and Design

Electrical Delay (one direction)	1.021 ns
----------------------------------	----------

After long term use with 100W radiated power, only a slight warming of the dipole near the feedpoint can be measured.

The dipole is made of standard semirigid coaxial cable. The center conductor of the feeding line is directly connected to the second arm of the dipole. The antenna is therefore short-circuited for DC-signals. On some of the dipoles, small end caps are added to the dipole arms in order to improve matching when loaded according to the position as explained in the "Measurement Conditions" paragraph. The SAR data are not affected by this change. The overall dipole length is still according to the Standard. No excessive force must be applied to the dipole arms, because they might bend or the soldered connections near the feedpoint may be damaged.

Additional EUT Data

Manufactured by	SPEAG
-----------------	-------



In Collaboration with
s p e a g
CALIBRATION LABORATORY

Add: No.51 Xueyuan Road, Haidian District, Beijing, 100191, China
Tel: +86-10-62304633-2079 Fax: +86-10-62304633-2504
E-mail: cttl@chinattl.com http://www.chinattl.cn

DASY5 Validation Report for Head TSL

Date: 06.15.2020

Test Laboratory: CTTL, Beijing, China

DUT: Dipole 2450 MHz; Type: D2450V2; Serial: D2450V2 - SN: 862

Communication System: UID 0, CW; Frequency: 2450 MHz; Duty Cycle: 1:1

Medium parameters used: $f = 2450$ MHz; $\sigma = 1.803$ S/m; $\epsilon_r = 39.01$; $\rho = 1000$ kg/m³

Phantom section: Right Section

DASY5 Configuration:

- Probe: EX3DV4 - SN7514; ConvF(7.22, 7.22, 7.22) @ 2450 MHz; Calibrated: 2019-09-27
- Sensor-Surface: 1.4mm (Mechanical Surface Detection)
- Electronics: DAE4 Sn1555; Calibrated: 2019-08-22
- Phantom: MFP_V5.1C (20deg probe tilt); Type: QD 000 P51 Cx; Serial: 1062
- Measurement SW: DASY52, Version 52.10 (4); SEMCAD X Version 14.6.14 (7483)

Dipole Calibration/Zoom Scan (7x7x7) (7x7x7)/Cube 0: Measurement grid: dx=5mm, dy=5mm, dz=5mm

Reference Value = 105.0 V/m; Power Drift = -0.06 dB

Peak SAR (extrapolated) = 28.3 W/kg

SAR(1 g) = 13.2 W/kg; SAR(10 g) = 6.05 W/kg

Smallest distance from peaks to all points 3 dB below = 9 mm

Ratio of SAR at M2 to SAR at M1 = 46.9%

Maximum value of SAR (measured) = 22.4 W/kg

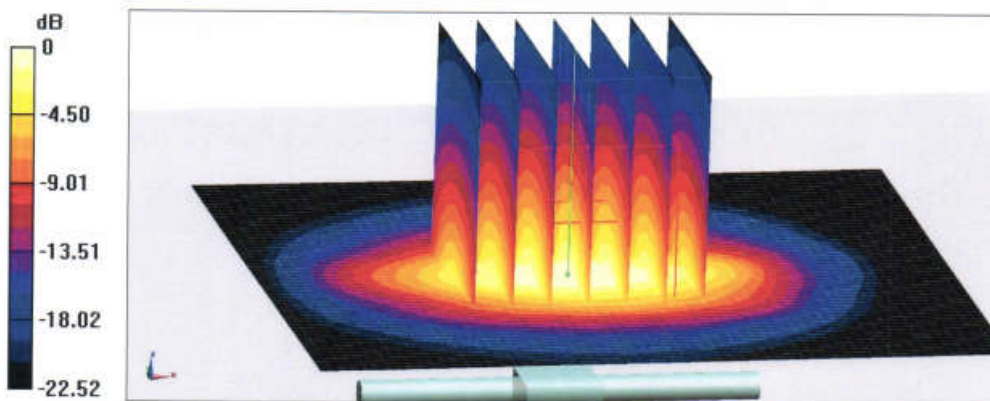

0 dB = 22.4 W/kg = 13.50 dBW/kg



In Collaboration with
s p e a g
CALIBRATION LABORATORY

Add: No.51 Xueyuan Road, Haidian District, Beijing, 100191, China
Tel: +86-10-62304633-2079 Fax: +86-10-62304633-2504
E-mail: cttl@chinattl.com http://www.chinattl.cn

Impedance Measurement Plot for Head TSL

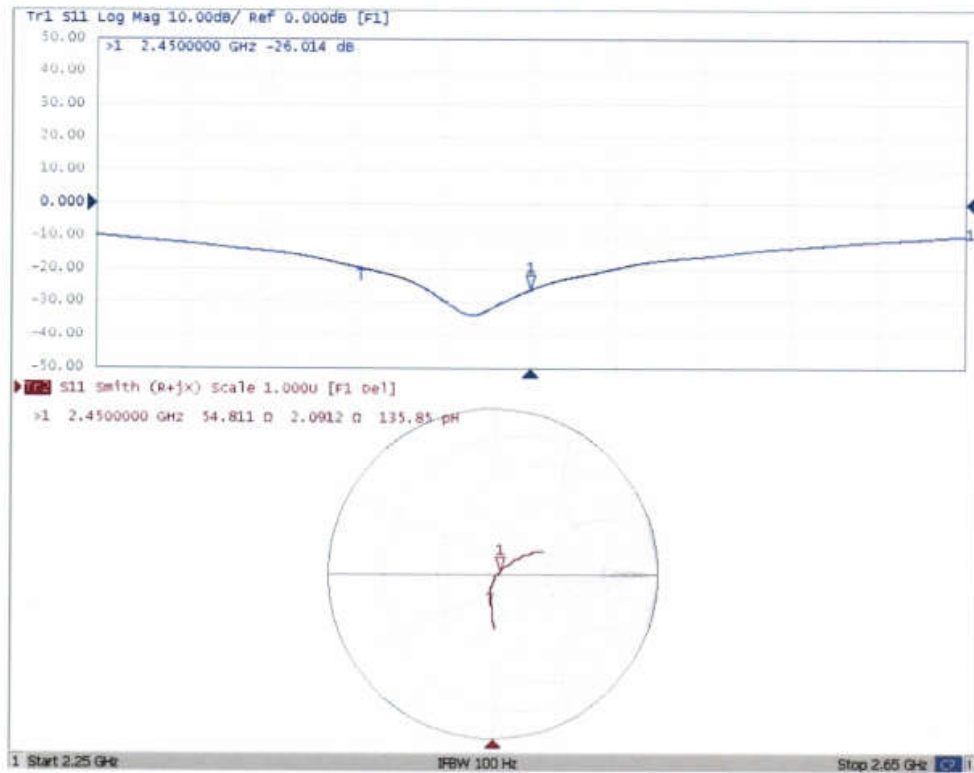



In Collaboration with
s p e a g
CALIBRATION LABORATORY

Add: No.51 Xueyuan Road, Haidian District, Beijing, 100191, China
 Tel: +86-10-62304633-2079 Fax: +86-10-62304633-2504
 E-mail: cttl@chinattl.com http://www.chinattl.cn

DASY5 Validation Report for Body TSL

Date: 06.15.2020

Test Laboratory: CTTL, Beijing, China

DUT: Dipole 2450 MHz; Type: D2450V2; Serial: D2450V2 - SN: 862

Communication System: UID 0, CW; Frequency: 2450 MHz; Duty Cycle: 1:1

Medium parameters used: $f = 2450$ MHz; $\sigma = 1.937$ S/m; $\epsilon_r = 52.32$; $\rho = 1000$ kg/m³

Phantom section: Center Section

DASY5 Configuration:

- Probe: EX3DV4 - SN7514; ConvF(7.32, 7.32, 7.32) @ 2450 MHz; Calibrated: 2019-09-27
- Sensor-Surface: 1.4mm (Mechanical Surface Detection)
- Electronics: DAE4 Sn1555; Calibrated: 2019-08-22
- Phantom: MFP_V5.1C (20deg probe tilt); Type: QD 000 P51 Cx; Serial: 1062
- Measurement SW: DASY52, Version 52.10 (4); SEMCAD X Version 14.6.14 (7483)

Dipole Calibration/Zoom Scan (7x7x7) (7x7x7)/Cube 0: Measurement grid: dx=5mm, dy=5mm, dz=5mm

Reference Value = 98.50 V/m; Power Drift = 0.08 dB

Peak SAR (extrapolated) = 26.2 W/kg

SAR(1 g) = 12.8 W/kg; SAR(10 g) = 5.94 W/kg

Smallest distance from peaks to all points 3 dB below = 8.5 mm

Ratio of SAR at M2 to SAR at M1 = 50.3%

Maximum value of SAR (measured) = 21.1 W/kg

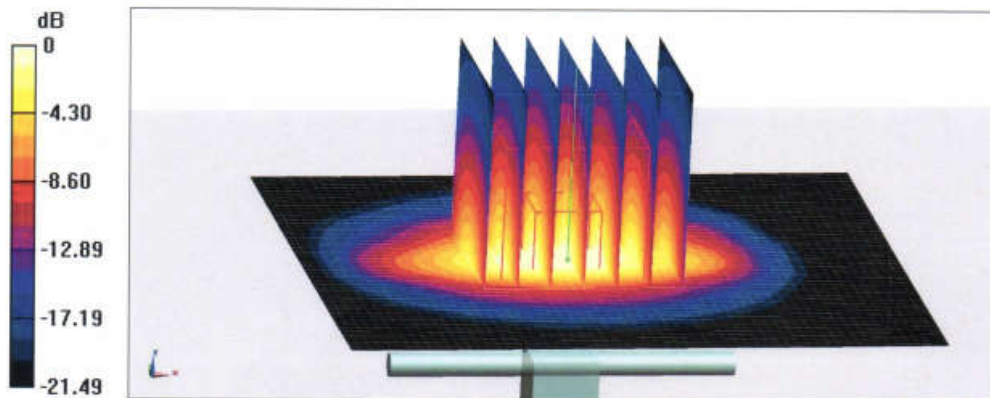

0 dB = 21.1 W/kg = 13.24 dBW/kg



In Collaboration with
s p e a g
CALIBRATION LABORATORY

Add: No.51 Xueyuan Road, Haidian District, Beijing, 100191, China
Tel: +86-10-62304633-2079 Fax: +86-10-62304633-2504
E-mail: cttl@chinattl.com http://www.chinattl.cn

Impedance Measurement Plot for Body TSL

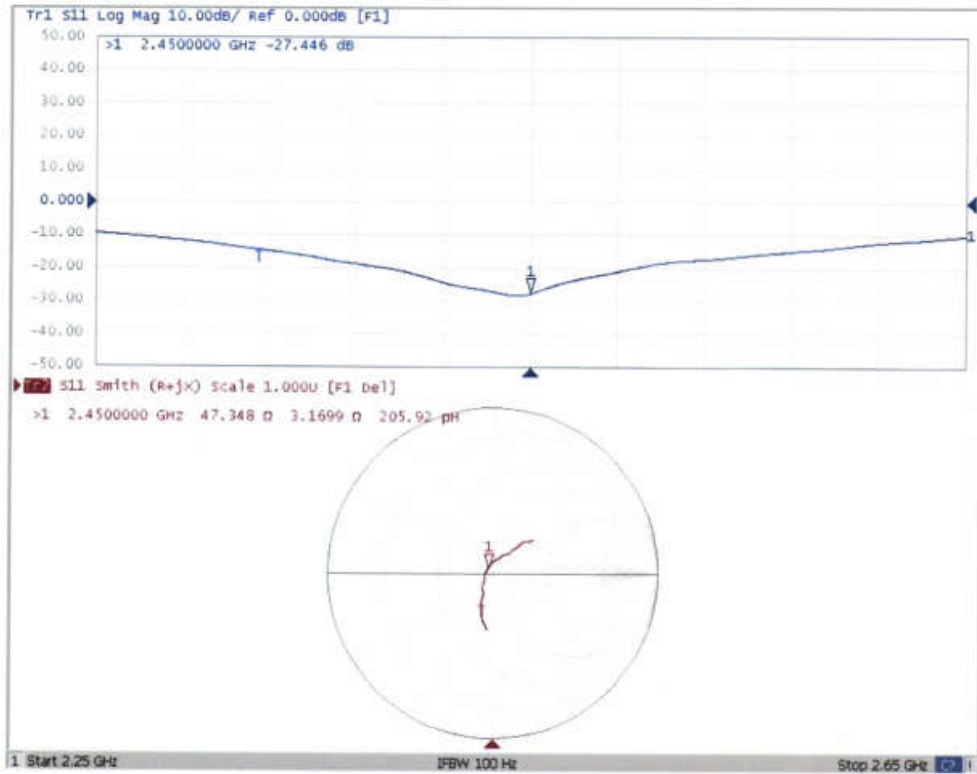



In Collaboration with
s p e a g
CALIBRATION LABORATORY



中国认可
国际互认
校准
CALIBRATION
CNAS L0570

Add: No.51 Xueyuan Road, Haidian District, Beijing, 100191, China
Tel: +86-10-62304633-2512 Fax: +86-10-62304633-2504
E-mail: cttl@chinattl.com [Http://www.chinattl.cn](http://www.chinattl.cn)

Client : **Audix**

Certificate No: **Z20-60111**

CALIBRATION CERTIFICATE

Object: **DAE4 - SN: 899**

Calibration Procedure(s): **FF-Z11-002-01
Calibration Procedure for the Data Acquisition Electronics (DAEx)**

Calibration date: **March 18, 2020**

This calibration Certificate documents the traceability to national standards, which realize the physical units of measurements(SI). The measurements and the uncertainties with confidence probability are given on the following pages and are part of the certificate.

All calibrations have been conducted in the closed laboratory facility: environment temperature(22±3)°C and humidity<70%.

Calibration Equipment used (M&TE critical for calibration)

Primary Standards	ID #	Cal Date(Calibrated by, Certificate No.)	Scheduled Calibration
Process Calibrator 753	1971018	24-Jun-19 (CTTL, No.J19X05126)	Jun-20

	Name	Function	Signature
Calibrated by:	Yu Zongying	SAR Test Engineer	
Reviewed by:	Lin Hao	SAR Test Engineer	
Approved by:	Qi Dianyuan	SAR Project Leader	

Issued: March 20, 2020

This calibration certificate shall not be reproduced except in full without written approval of the laboratory.

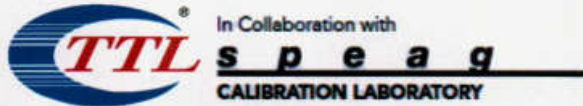

Add: No.51 Xueyuan Road, Haidian District, Beijing, 100191, China
Tel: +86-10-62304633-2512 Fax: +86-10-62304633-2504
E-mail: ettl@chinattl.com Http://www.chinattl.cn

Glossary:

DAE data acquisition electronics
Connector angle information used in DASY system to align probe sensor X to the robot coordinate system.

Methods Applied and Interpretation of Parameters:

- *DC Voltage Measurement:* Calibration Factor assessed for use in DASY system by comparison with a calibrated instrument traceable to national standards. The figure given corresponds to the full scale range of the voltmeter in the respective range.
- *Connector angle:* The angle of the connector is assessed measuring the angle mechanically by a tool inserted. Uncertainty is not required.
- The report provide only calibration results for DAE, it does not contain other performance test results.

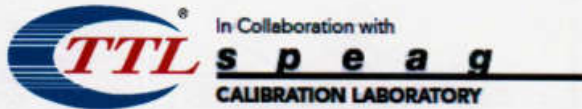

Add: No.51 Xueyuan Road, Haidian District, Beijing, 100191, China
Tel: +86-10-62304633-2512 Fax: +86-10-62304633-2504
E-mail: cttl@chinattl.com Http://www.chinattl.cn

DC Voltage Measurement

A/D - Converter Resolution nominal

High Range: 1LSB = 6.1 μ V, full range = -100...+300 mV

Low Range: 1LSB = 61nV, full range = -1.....+3mV

DASY measurement parameters: Auto Zero Time: 3 sec; Measuring time: 3 sec

Calibration Factors	X	Y	Z
High Range	402.285 \pm 0.15% (k=2)	403.043 \pm 0.15% (k=2)	403.034 \pm 0.15% (k=2)
Low Range	3.97978 \pm 0.7% (k=2)	3.97684 \pm 0.7% (k=2)	3.98312 \pm 0.7% (k=2)

Connector Angle

Connector Angle to be used in DASY system	350 $^{\circ}$ \pm 1 $^{\circ}$
---	-----------------------------------

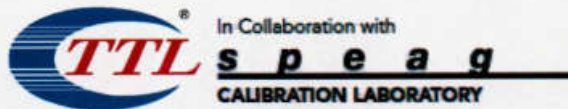

Add: No.51 Xueyuan Road, Haidian District, Beijing, 100191, China
 Tel: +86-10-62304633-2512 Fax: +86-10-62304633-2504
 E-mail: ctll@chinattl.com [Http://www.chinattl.cn](http://www.chinattl.cn)



中国认可
 国际互认
 校准
 CALIBRATION
 CNAS L0570

Client **Audix**

Certificate No: **Z20-60110**

CALIBRATION CERTIFICAT

Object **EX3DV4 - SN : 3767**

Calibration Procedure(s) **FF-Z11-004-01
 Calibration Procedures for Dosimetric E-field Probes**



Calibration date: **April 01, 2020**

This calibration Certificate documents the traceability to national standards, which realize the physical units of measurements(SI). The measurements and the uncertainties with confidence probability are given on the following pages and are part of the certificate.

All calibrations have been conducted in the closed laboratory facility: environment temperature(22±3)°C and humidity<70%.

Calibration Equipment used (M&TE critical for calibration)

Primary Standards	ID #	Cal Date(Calibrated by, Certificate No.)	Scheduled Calibration
Power Meter NRP2	101919	18-Jun-19(CTTL, No.J19X05125)	Jun-20
Power sensor NRP-Z91	101547	18-Jun-19(CTTL, No.J19X05125)	Jun-20
Power sensor NRP-Z91	101548	18-Jun-19(CTTL, No.J19X05125)	Jun-20
Reference 10dBAttenuator	18N50W-10dB	10-Feb-20(CTTL, No.J20X00525)	Feb-22
Reference 20dBAttenuator	18N50W-20dB	10-Feb-20(CTTL, No.J20X00526)	Feb-22
Reference Probe EX3DV4	SN 7307	24-May-19(SPEAG, No.EX3-7307_May19/2)	May-20
DAE4	SN 1525	26-Aug-19(SPEAG, No.DAE4-1525_Aug19)	Aug-20
Secondary Standards	ID #	Cal Date(Calibrated by, Certificate No.)	Scheduled Calibration
SignalGenerator MG3700A	6201052605	18-Jun-19(CTTL, No.J19X05127)	Jun-20
Network Analyzer E5071C	MY46110673	10-Feb-20(CTTL, No.J20X00515)	Feb-21

	Name	Function	Signature
Calibrated by:	Yu Zongying	SAR Test Engineer	
Reviewed by:	Lin Hao	SAR Test Engineer	
Approved by:	Qi Dianyuan	SAR Project Leader	

Issued: April 03, 2020

This calibration certificate shall not be reproduced except in full without written approval of the laboratory.

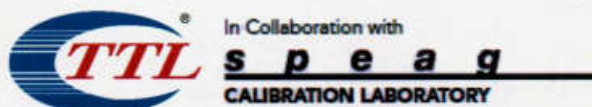

Add: No.51 Xueyuan Road, Haidian District, Beijing, 100191, China
 Tel: +86-10-62304633-2512 Fax: +86-10-62304633-2504
 E-mail: cttl@chinattl.com [Http://www.chinattl.cn](http://www.chinattl.cn)

Glossary:

- TSL tissue simulating liquid
- NORM_{x,y,z} sensitivity in free space
- ConvF sensitivity in TSL / NORM_{x,y,z}
- DCP diode compression point
- CF crest factor (1/duty_cycle) of the RF signal
- A,B,C,D modulation dependent linearization parameters
- Polarization Φ Φ rotation around probe axis
- Polarization θ θ rotation around an axis that is in the plane normal to probe axis (at measurement center), $\theta=0$ is normal to probe axis

Connector Angle information used in DASY system to align probe sensor X to the robot coordinate system

Calibration is Performed According to the Following Standards:

- a) IEEE Std 1528-2013, "IEEE Recommended Practice for Determining the Peak Spatial-Averaged Specific Absorption Rate (SAR) in the Human Head from Wireless Communications Devices: Measurement Techniques", June 2013
- b) IEC 62209-1, "Measurement procedure for the assessment of Specific Absorption Rate (SAR) from hand-held and body-mounted devices used next to the ear (frequency range of 300 MHz to 6 GHz)", July 2016
- c) IEC 62209-2, "Procedure to determine the Specific Absorption Rate (SAR) for wireless communication devices used in close proximity to the human body (frequency range of 30 MHz to 6 GHz)", March 2010
- d) KDB 865664, "SAR Measurement Requirements for 100 MHz to 6 GHz"

Methods Applied and Interpretation of Parameters:

- NORM_{x,y,z}: Assessed for E-field polarization $\theta=0$ ($f \leq 900\text{MHz}$ in TEM-cell; $f > 1800\text{MHz}$: waveguide). NORM_{x,y,z} are only intermediate values, i.e., the uncertainties of NORM_{x,y,z} does not effect the E^2 -field uncertainty inside TSL (see below ConvF).
- NORM(f)_{x,y,z} = NORM_{x,y,z} * frequency_response (see Frequency Response Chart). This linearization is implemented in DASY4 software versions later than 4.2. The uncertainty of the frequency response is included in the stated uncertainty of ConvF.
- DCP_{x,y,z}: DCP are numerical linearization parameters assessed based on the data of power sweep (no uncertainty required). DCP does not depend on frequency nor media.
- PAR: PAR is the Peak to Average Ratio that is not calibrated but determined based on the signal characteristics.
- A_{x,y,z}; B_{x,y,z}; C_{x,y,z}; VR_{x,y,z}: A,B,C are numerical linearization parameters assessed based on the data of power sweep for specific modulation signal. The parameters do not depend on frequency nor media. VR is the maximum calibration range expressed in RMS voltage across the diode.
- ConvF and Boundary Effect Parameters: Assessed in flat phantom using E-field (or Temperature Transfer Standard for $f \leq 800\text{MHz}$) and inside waveguide using analytical field distributions based on power measurements for $f > 800\text{MHz}$. The same setups are used for assessment of the parameters applied for boundary compensation (alpha, depth) of which typical uncertainty valued are given. These parameters are used in DASY4 software to improve probe accuracy close to the boundary. The sensitivity in TSL corresponds to NORM_{x,y,z} * ConvF whereby the uncertainty corresponds to that given for ConvF. A frequency dependent ConvF is used in DASY version 4.4 and higher which allows extending the validity from $\pm 50\text{MHz}$ to $\pm 100\text{MHz}$.
- Spherical isotropy (3D deviation from isotropy): in a field of low gradients realized using a flat phantom exposed by a patch antenna.
- Sensor Offset: The sensor offset corresponds to the offset of virtual measurement center from the probe tip (on probe axis). No tolerance required.
- Connector Angle: The angle is assessed using the information gained by determining the NORM_x (no uncertainty required).

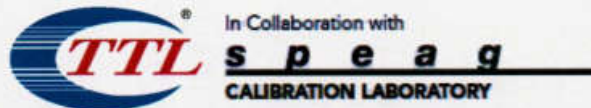

Add: No.51 Xueyuan Road, Haidian District, Beijing, 100191, China
 Tel: +86-10-62304633-2512 Fax: +86-10-62304633-2504
 E-mail: cttl@chinattl.com [Http://www.chinattl.cn](http://www.chinattl.cn)

DASY/EASY – Parameters of Probe: EX3DV4 – SN:3767

Basic Calibration Parameters

	Sensor X	Sensor Y	Sensor Z	Unc (k=2)
Norm($\mu\text{V}/(\text{V}/\text{m})^2$) ^A	0.55	0.57	0.48	$\pm 10.0\%$
DCP(mV) ^B	101.3	100.7	103.7	

Modulation Calibration Parameters

UID	Communication System Name		A dB	B dB $\sqrt{\mu\text{V}}$	C	D dB	VR mV	Unc ^E (k=2)
0	CW	X	0.0	0.0	1.0	0.00	173.8	$\pm 2.3\%$
		Y	0.0	0.0	1.0		175.2	
		Z	0.0	0.0	1.0		160.6	

The reported uncertainty of measurement is stated as the standard uncertainty of Measurement multiplied by the coverage factor k=2, which for a normal distribution Corresponds to a coverage probability of approximately 95%.

^A The uncertainties of Norm X, Y, Z do not affect the E²-field uncertainty inside TSL (see Page 4 and Page 5).
^B Numerical linearization parameter: uncertainty not required.
^E Uncertainty is determined using the max. deviation from linear response applying rectangular distribution and is expressed for the square of the field value.

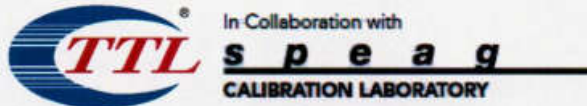

Add: No.51 Xueyuan Road, Haidian District, Beijing, 100191, China
 Tel: +86-10-62304633-2512 Fax: +86-10-62304633-2504
 E-mail: cttl@chinattl.com [Http://www.chinattl.cn](http://www.chinattl.cn)

DASY/EASY – Parameters of Probe : EX3DV4 – SN:3767

Calibration Parameter Determined in Head Tissue Simulating Media

f [MHz] ^C	Relative Permittivity ^F	Conductivity (S/m) ^F	ConvF X	ConvF Y	ConvF Z	Alpha ^G	Depth ^G (mm)	Unct. (k=2)
750	41.9	0.89	9.81	9.81	9.81	0.40	0.80	±12.1%
835	41.5	0.90	9.53	9.53	9.53	0.14	1.49	±12.1%
900	41.5	0.97	9.55	9.55	9.55	0.16	1.30	±12.1%
1640	40.3	1.29	8.41	8.41	8.41	0.20	1.04	±12.1%
1750	40.1	1.37	8.26	8.26	8.26	0.20	1.14	±12.1%
1900	40.0	1.40	8.02	8.02	8.02	0.25	1.05	±12.1%
2000	40.0	1.40	8.00	8.00	8.00	0.19	1.19	±12.1%
2300	39.5	1.67	7.79	7.79	7.79	0.47	0.77	±12.1%
2450	39.2	1.80	7.46	7.46	7.46	0.53	0.74	±12.1%
2600	39.0	1.96	7.31	7.31	7.31	0.64	0.68	±12.1%
3300	38.2	2.71	7.40	7.40	7.40	0.66	0.68	±13.3%
3500	37.9	2.91	6.98	6.98	6.98	0.52	0.80	±13.3%
3700	37.7	3.12	6.60	6.60	6.60	0.47	0.88	±13.3%
3900	37.5	3.32	6.50	6.50	6.50	0.40	1.15	±13.3%
4100	37.2	3.53	6.43	6.43	6.43	0.40	1.20	±13.3%
4400	36.9	3.84	6.32	6.32	6.32	0.35	1.33	±13.3%
4600	36.7	4.04	6.15	6.15	6.15	0.45	1.40	±13.3%
4800	36.4	4.25	5.98	5.98	5.98	0.40	1.65	±13.3%
4950	36.3	4.40	5.80	5.80	5.80	0.40	1.60	±13.3%
5200	36.0	4.66	5.55	5.55	5.55	0.40	1.45	±13.3%
5300	35.9	4.76	5.14	5.14	5.14	0.40	1.70	±13.3%
5500	35.6	4.96	4.82	4.82	4.82	0.45	1.65	±13.3%
5600	35.5	5.07	4.75	4.75	4.75	0.45	1.55	±13.3%
5800	35.3	5.27	4.70	4.70	4.70	0.50	1.40	±13.3%

^C Frequency validity above 300 MHz of ±100MHz only applies for DASY v4.4 and higher (Page 2), else it is restricted to ±50MHz. The uncertainty is the RSS of ConvF uncertainty at calibration frequency and the uncertainty for the indicated frequency band. Frequency validity below 300 MHz is ± 10, 25, 40, 50 and 70 MHz for ConvF assessments at 30, 64, 128, 150 and 220 MHz respectively. Above 5 GHz frequency validity can be extended to ± 110 MHz.

^F At frequency below 3 GHz, the validity of tissue parameters (ϵ and σ) can be relaxed to ±10% if liquid compensation formula is applied to measured SAR values. At frequencies above 3 GHz, the validity of tissue parameters (ϵ and σ) is restricted to ±5%. The uncertainty is the RSS of the ConvF uncertainty for indicated target tissue parameters.

^G Alpha/Depth are determined during calibration. SPEAG warrants that the remaining deviation due to the boundary effect after compensation is always less than ± 1% for frequencies below 3 GHz and below ± 2% for the frequencies between 3-6 GHz at any distance larger than half the probe tip diameter from the boundary.

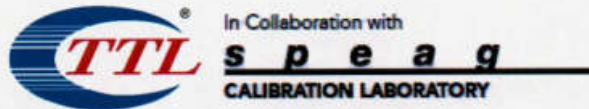

Add: No.51 Xueyuan Road, Haidian District, Beijing, 100191, China
 Tel: +86-10-62304633-2512 Fax: +86-10-62304633-2504
 E-mail: cttl@chinattl.com [Http://www.chinattl.cn](http://www.chinattl.cn)

DASY/EASY – Parameters of Probe : EX3DV4 – SN:3767

Calibration Parameter Determined in Body Tissue Simulating Media

f [MHz] ^C	Relative Permittivity ^F	Conductivity (S/m) ^F	ConvF X	ConvF Y	ConvF Z	Alpha ^G	Depth ^G (mm)	Unct. (k=2)
750	55.5	0.96	9.91	9.91	9.91	0.40	0.80	±12.1%
835	55.2	0.97	9.60	9.60	9.60	0.15	1.51	±12.1%
900	55.0	1.05	9.53	9.53	9.53	0.22	1.16	±12.1%
1640	53.8	1.40	8.15	8.15	8.15	0.23	1.18	±12.1%
1750	53.4	1.49	7.87	7.87	7.87	0.18	1.25	±12.1%
1900	53.3	1.52	7.77	7.77	7.77	0.17	1.33	±12.1%
2000	53.3	1.52	7.70	7.70	7.70	0.20	1.38	±12.1%
2300	52.9	1.81	7.77	7.77	7.77	0.51	0.83	±12.1%
2450	52.7	1.95	7.59	7.59	7.59	0.57	0.78	±12.1%
2600	52.5	2.16	7.37	7.37	7.37	0.68	0.69	±12.1%
3300	51.6	3.08	6.82	6.82	6.82	0.43	1.00	±13.3%
3500	52.3	3.31	6.35	6.35	6.35	0.40	1.25	±13.3%
3700	52.1	3.55	6.19	6.19	6.19	0.40	1.25	±13.3%
3900	50.8	3.78	6.18	6.18	6.18	0.40	1.40	±13.3%
4100	50.5	4.01	6.18	6.18	6.18	0.35	1.40	±13.3%
4400	50.1	4.37	5.97	5.97	5.97	0.35	1.70	±13.3%
4600	49.8	4.60	5.63	5.63	5.63	0.40	1.55	±13.3%
4800	49.6	4.83	5.48	5.48	5.48	0.40	1.65	±13.3%
4950	49.4	5.01	5.24	5.24	5.24	0.45	1.65	±13.3%
5200	49.0	5.30	5.07	5.07	5.07	0.45	1.50	±13.3%
5300	48.9	5.42	4.80	4.80	4.80	0.45	1.50	±13.3%
5500	48.6	5.65	4.36	4.36	4.36	0.45	1.60	±13.3%
5600	48.5	5.77	4.32	4.32	4.32	0.50	1.50	±13.3%
5800	48.2	6.00	4.34	4.34	4.34	0.50	1.44	±13.3%

^C Frequency validity above 300 MHz of ±100MHz only applies for DASY v4.4 and higher (Page 2), else it is restricted to ±50MHz. The uncertainty is the RSS of ConvF uncertainty at calibration frequency and the uncertainty for the indicated frequency band. Frequency validity below 300 MHz is ± 10, 25, 40, 50 and 70 MHz for ConvF assessments at 30, 64, 128, 150 and 220 MHz respectively. Above 5 GHz frequency validity can be extended to ± 110 MHz.

^F At frequency below 3 GHz, the validity of tissue parameters (ϵ and σ) can be relaxed to ±10% if liquid compensation formula is applied to measured SAR values. At frequencies above 3 GHz, the validity of tissue parameters (ϵ and σ) is restricted to ±5%. The uncertainty is the RSS of the ConvF uncertainty for indicated target tissue parameters.

^G Alpha/Depth are determined during calibration. SPEAG warrants that the remaining deviation due to the boundary effect after compensation is always less than ± 1% for frequencies below 3 GHz and below ± 2% for the frequencies between 3-6 GHz at any distance larger than half the probe tip diameter from the boundary.

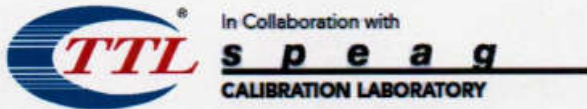

Add: No.51 Xueyuan Road, Haidian District, Beijing, 100191, China
Tel: +86-10-62304633-2512 Fax: +86-10-62304633-2504
E-mail: cttl@chinattl.com [Http://www.chinattl.cn](http://www.chinattl.cn)

Frequency Response of E-Field (TEM-Cell: ifi110 EXX, Waveguide: R22)

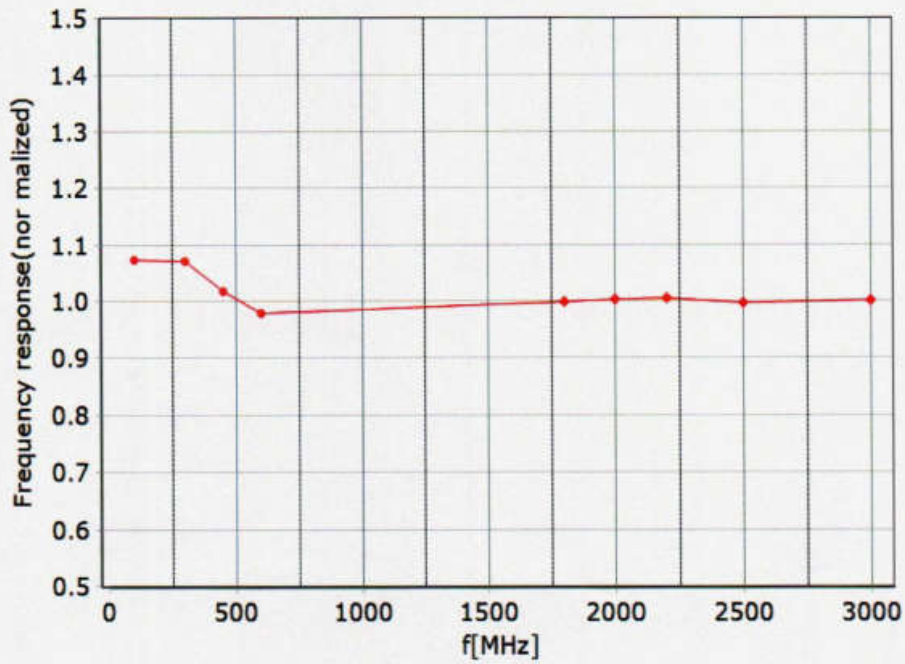

• TEM • R22

Uncertainty of Frequency Response of E-field: $\pm 7.4\%$ (k=2)

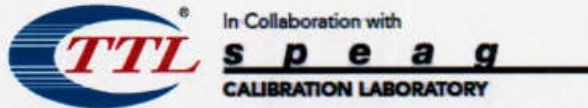

Add: No.51 Xueyuan Road, Haidian District, Beijing, 100191, China
Tel: +86-10-62304633-2512 Fax: +86-10-62304633-2504
E-mail: cttl@chinattl.com [Http://www.chinattl.cn](http://www.chinattl.cn)

Receiving Pattern (Φ), $\theta=0^\circ$

f=600 MHz, TEM

f=1800 MHz, R22

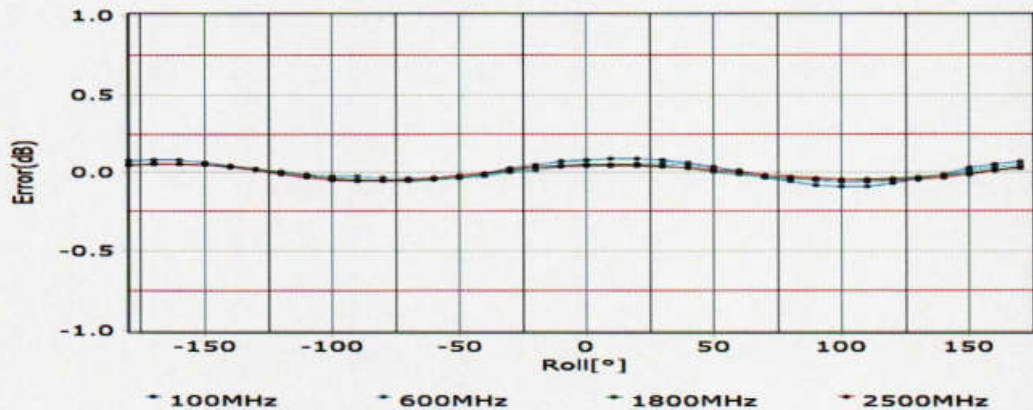
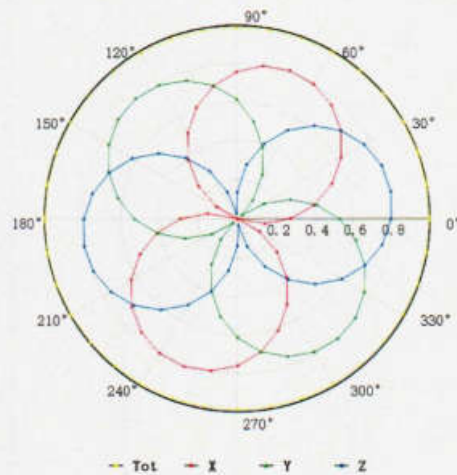
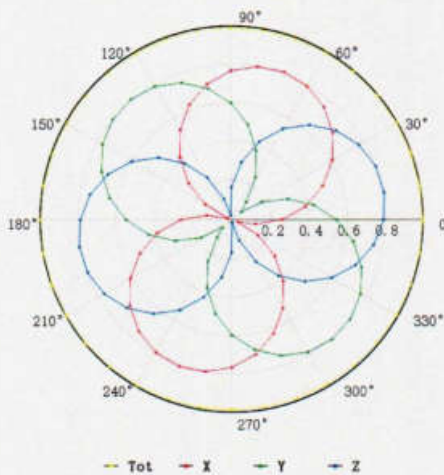

Uncertainty of Axial Isotropy Assessment: $\pm 1.2\%$ ($k=2$)



Add: No.51 Xueyuan Road, Haidian District, Beijing, 100191, China
 Tel: +86-10-62304633-2512 Fax: +86-10-62304633-2504
 E-mail: cttl@chinattl.com [Http://www.chinattl.cn](http://www.chinattl.cn)

**Dynamic Range f(SAR_{head})
 (TEM cell, f = 900 MHz)**

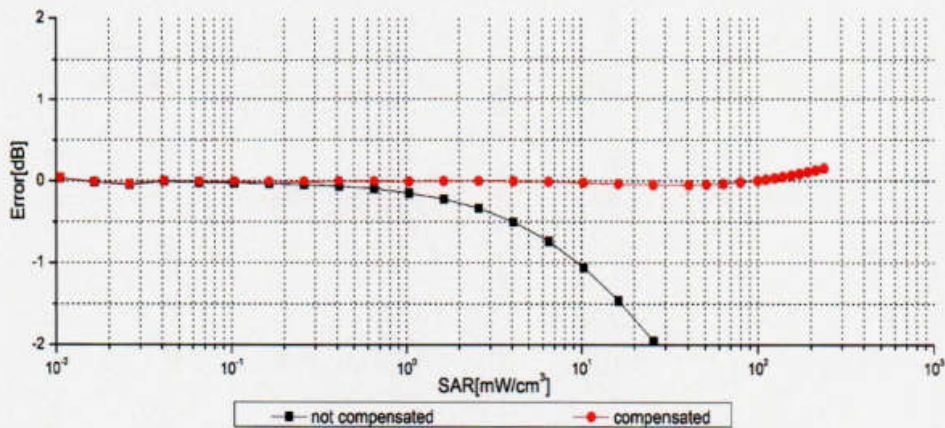
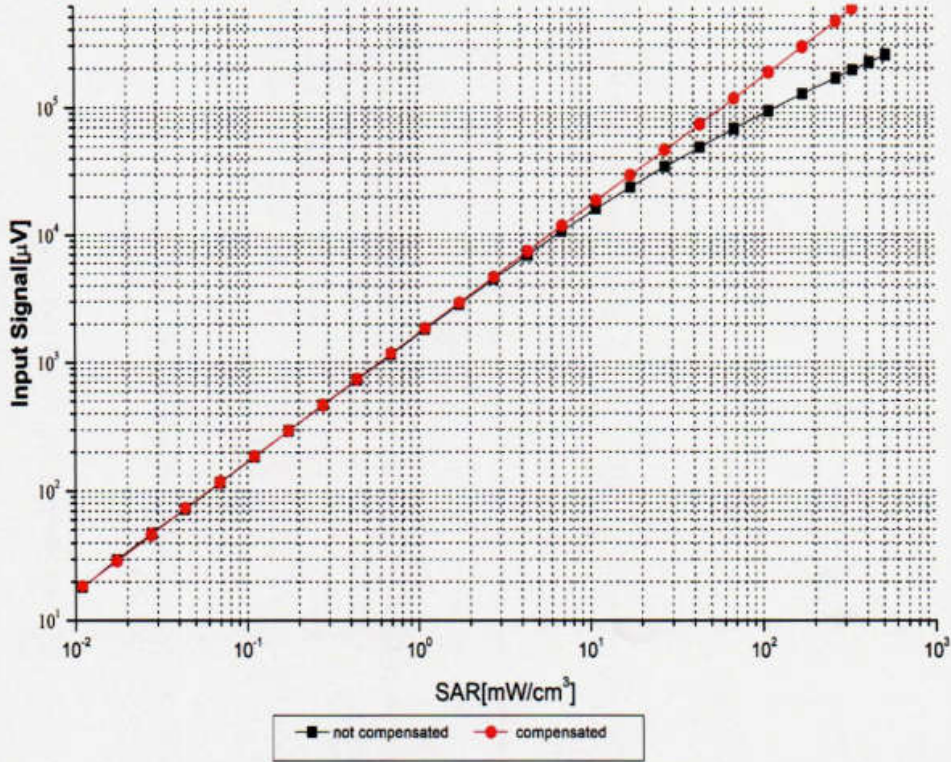

Uncertainty of Linearity Assessment: ±0.9% (k=2)



Add: No.51 Xueyuan Road, Haidian District, Beijing, 100191, China
 Tel: +86-10-62304633-2512 Fax: +86-10-62304633-2504
 E-mail: cttl@chinattl.com [Http://www.chinattl.cn](http://www.chinattl.cn)

Conversion Factor Assessment

f=750 MHz,WGLS R9(H_convF)

f=1750 MHz,WGLS R22(H_convF)

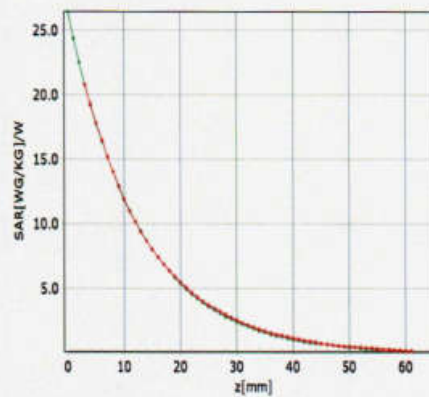
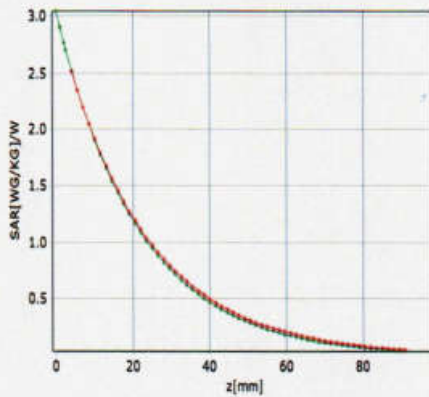

* analytical * measured

* analytical * measured

Deviation from Isotropy in Liquid

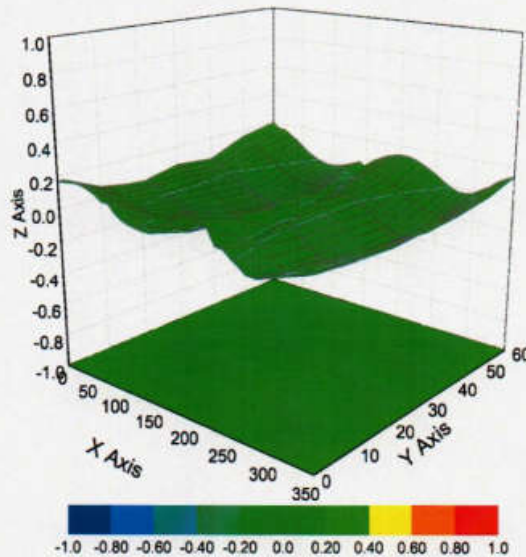

Uncertainty of Spherical Isotropy Assessment: ±3.2% (K=2)



Add: No.51 Xueyuan Road, Haidian District, Beijing, 100191, China
Tel: +86-10-62304633-2512 Fax: +86-10-62304633-2504
E-mail: ctl@chinattl.com [Http://www.chinattl.cn](http://www.chinattl.cn)

DASY/EASY – Parameters of Probe: EX3DV4 – SN:3767

Other Probe Parameters

Sensor Arrangement	Triangular
Connector Angle (°)	146.6
Mechanical Surface Detection Mode	enabled
Optical Surface Detection Mode	disable
Probe Overall Length	337mm
Probe Body Diameter	10mm
Tip Length	10mm
Tip Diameter	2.5mm
Probe Tip to Sensor X Calibration Point	1mm
Probe Tip to Sensor Y Calibration Point	1mm
Probe Tip to Sensor Z Calibration Point	1mm
Recommended Measurement Distance from Surface	1.4mm