



FCC AND ISED CERTIFICATION TEST REPORT

Applicant	:	Harman International Industries, Inc.
Address of Applicant	:	8500 Balboa Boulevard, Northridge, CA 91329, UNITED STATES
Manufacturer	:	Harman International Industries, Inc.
Address of Manufacturer	:	8500 Balboa Boulevard, Northridge, CA 91329, UNITED STATES
Equipment under Test	:	Portable Bluetooth Speaker
Model No.	:	XTREME 4G
Trade Mark	:	JBL
FCC ID	:	APIJBLXTREME4G
IC	:	6132A-JBLXTREME4G
Test Standard(s)	:	FCC Rules and Regulations Part 15 Subpart C, RSS-247 Issue 3 August 2023, ANSI C63.10:2013, RSS-Gen Issue 5, Apr. 2018, Amendment 2 (February 2021)
Report No.	:	DDT-RE23090419-2E02
Issue Date	:	2023/10/10
Issue By	:	Dongguan Dongdian Testing Service Co., Ltd.
Address of Laboratory	:	Unit 2, Building 1, No. 17, Zongbu 2nd Road, Songshan Lake Park, Dongguan, Guangdong, China, 523808

REPORT

Table of Contents

	Test report declares.....	4
1.	Summary of Test Results.....	7
2.	General Test Information	8
2.1.	Description of EUT	8
2.2.	Accessories of EUT.....	9
2.3.	Assistant equipment used for test.....	10
2.4.	Block diagram of EUT configuration for test	10
2.5.	Test environment conditions	10
2.6.	Deviations of test standard.....	10
2.7.	Test laboratory	11
2.8.	Measurement uncertainty.....	11
3.	Equipment Used During Conductive Test.....	12
4.	6 dB Bandwidth	13
4.1.	Block diagram of test setup.....	13
4.2.	Limits	13
4.3.	Test procedure	13
4.4.	Test result.....	13
4.5.	Test graphs	14
5.	99% Bandwidth	16
5.1.	Block diagram of test setup.....	16
5.2.	Limits	16
5.3.	Test procedure	16
5.4.	Test Result	16
5.5.	Test Graphs.....	17
6.	Maximum Peak Output Power	19
6.1.	Block diagram of test setup.....	19
6.2.	Limits	19
6.3.	Test procedure	19
6.4.	Test result.....	19
6.5.	Test graphs	19
7.	Power Spectral Density.....	22
7.1.	Block diagram of test setup.....	22
7.2.	Limits	22
7.3.	Test procedure	22
7.4.	Test result.....	22
7.5.	Test graphs	22
8.	Band Edge Compliance (Conducted Method)	25

8.1.	Block diagram of test setup.....	25
8.2.	Limits	25
8.3.	Test procedure	25
8.4.	Test result.....	25
8.5.	Test graphs	25
9.	RF Conducted Spurious Emissions	28
9.1.	Block diagram of test setup.....	28
9.2.	Limits	28
9.3.	Test procedure	28
9.4.	Test result.....	29
9.5.	Test graphs	29
10.	Duty Cycle	29
10.1.	Block diagram of test setup.....	36
10.2.	Limit	36
10.3.	Test procedure	36
10.4.	Test result.....	36
10.5.	Test graphs	36
11.	Radiated Emission	39
11.1.	Test equipment.....	39
11.2.	Block diagram of test setup.....	39
11.3.	Limit	41
11.4.	Test Procedure.....	42
11.5.	Test result.....	44
12.	Emissions in Restricted Frequency Bands	59
12.1.	Test equipment.....	59
12.2.	Block diagram of test setup.....	59
12.3.	Limit	59
12.4.	Test procedure	59
12.5.	Test result.....	59
13.	Power Line Conducted Emission	68
13.1.	Test equipment.....	68
13.2.	Block diagram of test setup.....	68
13.3.	Power line conducted emission limits	68
13.4.	Test procedure	68
13.5.	Test result.....	69
14.	Antenna Requirements	72
14.1.	Limit	72
14.2.	Result	72

15. Test Setup Photograph 73

16. Photos of the EUT 76

Test Report Declare

Applicant	:	Harman International Industries, Inc.
Address of Applicant	:	8500 Balboa Boulevard, Northridge, CA 91329, UNITED STATES
Equipment under Test	:	Portable Bluetooth Speaker
Model No.	:	XTREME 4G
Trade Mark	:	JBL
Manufacturer	:	Harman International Industries, Inc.
Address of Manufacturer	:	8500 Balboa Boulevard, Northridge, CA 91329, UNITED STATES

Test Standard Used:

FCC Rules and Regulations Part 15 Subpart C, RSS-247 Issue 3 August 2023.

Test Procedure Used:

ANSI C63.10:2013, RSS-Gen Issue 5, Apr. 2018, Amendment 2 (February 2021)

We Declare:

The equipment described above is tested by Dongguan Dongdian Testing Service Co., Ltd. and in the configuration tested the equipment complied with the standards specified above. The test results are contained in this test report and Dongguan Dongdian Testing Service Co., Ltd. is assumed of full responsibility for the accuracy and completeness of these tests.

After test and evaluation, our opinion is that the equipment provided for test compliance with the requirement of the above FCC&ISED standards.

Report No.:	DDT-RE23090419-2E02		
Date of Receipt:	2023/09/14	Date of Test:	2023/09/14 ~ 2023/10/10

Prepared By:

Bobo Chen

Bobo Chen/Engineer

Approved By:

Damon Hu

Damon Hu/EMC Manager

Note: This report applies to above tested sample only. This report shall not be reproduced in parts without written approval of Dongguan Dongdian Testing Service Co., Ltd.

Revision History

Rev.	Revisions	Issue Date	Revised By
---	Initial issue	2023/10/10	

1. Summary of Test Results

Description of Test Item	Standard	Result
6 dB Bandwidth and 99% Bandwidth	FCC Part 15: 15.247(a)(2) RSS-247 Issue 3 clause 5.2(a) RSS-Gen Issue 5 clause 6.7	Pass
Peak Output Power	FCC Part 15: 15.247(b)(3) RSS-247 Issue 3 clause 5.4(d)	Pass
Power Spectral Density	FCC Part 15:15.247(e) RSS-247 Issue 3 clause 5.2(b)	Pass
Band Edge Compliance (conducted method)	FCC Part 15: 15.247(d) RSS-247 Issue 3 clause 5.5	Pass
RF Conducted Spurious Emissions	FCC Part 15: 15.247(d) RSS-247 Issue 3 clause 5.5	Pass
Radiation Emission	FCC Part 15: 15.205 FCC Part 15: 15.209 FCC Part 15: 15.247(d) RSS-247 Issue 3 clause 5.5 RSS-Gen Issue 5 clause 8.9 RSS-Gen Issue 5 clause 8.10	Pass
Emission in Restricted Frequency Bands	FCC Part 15: 15.205 FCC Part 15: 15.209 FCC Part 15: 15.247(d) RSS-247 Issue 3 clause 5.5 RSS-Gen Issue 5 clause 8.9 RSS-Gen Issue 5 clause 8.10	Pass
Power Line Conducted Emission	FCC Part 15: 15.207(a) RSS-Gen Issue 5 clause 8.8	Pass
Antenna Requirement	FCC Part 15: 15.203 RSS-Gen Issue 5 clause 6.8	Pass
Note: Determining compliance based on the results of the compliance measurement, not taking into account measurement instrumentation uncertainty.		

2. General Test Information

2.1. Description of EUT

EUT Name	: Portable Bluetooth Speaker
Model Number	: XTREME 4G
EUT Function Description	: Please reference user manual of this device
Power Supply	: DC 5V/9V/12V/15V/20V ---3.0A from external AC Adapter DC 7.2V Polymer Li-ion built-in battery
Radio Specification	: Bluetooth V5.3 (BR/EDR/LE), 2.4GHz SRD
Operation Frequency	: Bluetooth (BR/EDR/LE): 2402 MHz-2480 MHz 2.4GHz SRD: 2407 MHz-2475 MHz
Modulation	: Bluetooth BR/EDR: GFSK, $\pi/4$ -DQPSK, 8DPSK Bluetooth LE: GFSK 2.4GHz SRD: GFSK, $\pi/4$ -DQPSK, 8DPSK
Sample Number	: S23090419-24 for conductive, S23090419-25 for radiation

Note 1: “☒” means to be chosen or applicable; “☐” means don't to be chosen or not applicable; This note applies to entire report.

Note 2: This report only for Bluetooth LE 1Mbps, 2 Mbps.

Note 3: Simultaneously transmission condition:

Condition	RF Technology	
1	Bluetooth	2.4GHz SRD
The emission of the simultaneous operation has been evaluated and no non-compliance was found.		

Note 4: Antenna information:

Bluetooth Antenna information	
Antenna Type	: FPC
Antenna Gain(dBi)	: 2.09

Note 5: Bluetooth LE Channel information:

Bluetooth LE 1Mbps Channel information					
Channel	Frequency (MHz)	Channel	Frequency (MHz)	Channel	Frequency (MHz)
0	2402	14	2430	28	2458
1	2404	15	2432	29	2460
2	2406	16	2434	30	2462
3	2408	17	2436	31	2464
4	2410	18	2438	32	2466
5	2412	19	2440	33	2468
6	2414	20	2442	34	2470
7	2416	21	2444	35	2472
8	2418	22	2446	36	2474
9	2420	23	2448	37	2476

10	2422	24	2450	38	2478
11	2424	25	2452	39	2480
12	2426	26	2454		
13	2428	27	2456		
Bluetooth LE 2Mbps Channel information					
Channel	Frequency (MHz)	Channel	Frequency (MHz)	Channel	Frequency (MHz)
0	2402	14	2430	28	2458
1	2404	15	2432	29	2460
2	2406	16	2434	30	2462
3	2408	17	2436	31	2464
4	2410	18	2438	32	2466
5	2412	19	2440	33	2468
6	2414	20	2442	34	2470
7	2416	21	2444	35	2472
8	2418	22	2446	36	2474
9	2420	23	2448	37	2476
10	2422	24	2450	38	2478
11	2424	25	2452	39	2480
12	2426	26	2454		
13	2428	27	2456		
The channels denoted with the grey background are excluded, because they are primary advertising channel only for the Bluetooth LE 1Mbps according to the Bluetooth Core Specification.					

Note 6: The above EUT information is declared by manufacturer and for more detailed features description please refer to the manufacturer's specifications or User's Manual. The above Antenna information is declared by manufacturer and for more detailed features description please refer to the manufacturer's specifications, the laboratory shall not be held responsible.

2.2. Accessories of EUT

Description of Accessories	Manufacturer	Model number	Description	Remark
AC Adapter	Group Intellect Power Technology Limited	GHWM-PD60W-X4	Input: 100-240V ~ 50/60 Hz 1.5A Output: 5.0V---3.0A, 9.0V---3.0A, 12.0V---3.0A, 15.0V---3.0A, 20.0V---3.0A	N/A

2.3. Assistant equipment used for test

Assistant equipment	Manufacturer	Model number	EMC Compliance	SN
N/A	N/A	N/A	N/A	N/A

2.4. Block diagram of EUT configuration for test



Test software: Zgmicro Bluetooth * Authentication Tool V2.3.164.891 - 1ToN/PB2.0.exe
 The test software was used to control EUT work in Continuous Tx mode, and select test channel, wireless mode as below table:

The pathloss of external cable: 0.5dB (According to the manufacturer's claims)

Tested mode, channel, information			
Mode	Setting Tx Power	Channel	Frequency (MHz)
GFSK 1M	Default	CH0	2402
	Default	CH19	2440
	Default	CH39	2480
GFSK 2M	Default	CH1	2404
	Default	CH19	2440
	Default	CH38	2478

2.5. Test environment conditions

During the measurement the environmental conditions were within the listed ranges:

Temperature range:	+15°C to +35 °C
Humidity range:	20% to 75%
Pressure range:	86 kPa to 106 kPa

Note: The specific temperature and humidity information of each test item refers to the temperature and humidity record in the corresponding test data.

2.6. Deviations of test standard

No deviation.

2.7. Test laboratory

Dongguan Dongdian Testing Service Co., Ltd.

Add.: No. 17, Zongbu Road 2, Songshan Lake Sci&Tech, Industry Park, Dongguan City, Guangdong Province, China, 523808.

Tel.: +86-0769-38826678, <http://www.dgddt.com>, Email: ddt@dgddt.com.

CNAS Accreditation No. L6451; A2LA Accreditation Number: 3870.01

FCC Designation Number: CN1182, Test Firm Registration Number: 540522

Innovation, Science and Economic Development Canada Site Registration Number: 10288A

Conformity Assessment Body identifier: CN0048

VCCI facility registration number: C-20087, T-20088, R-20123, R-20155, G-20118

2.8. Measurement uncertainty

Test Item	Uncertainty
Bandwidth	1.1%
Peak Output Power (Conducted) (Spectrum analyzer)	0.86 dB (10 MHz ≤ f < 3.6 GHz);
	1.38 dB (3.6 GHz ≤ f < 8 GHz)
Peak Output Power (Conducted) (Power Sensor)	0.74 dB
Power Spectral Density	0.74 dB (10 MHz ≤ f < 3.6 GHz);
	1.38 dB (3.6 GHz ≤ f < 8 GHz)
Frequencies Stability	6.7 × 10 ⁻⁸ (Antenna couple method)
	5.5 × 10 ⁻⁸ (Conducted method)
Conducted spurious emissions	0.86 dB (10 MHz ≤ f < 3.6 GHz);
	1.40 dB (3.6 GHz ≤ f < 8 GHz)
	1.66 dB (8 GHz ≤ f < 26.5 GHz)
Uncertainty for radio frequency (RBW < 20 kHz)	3×10 ⁻⁸
Temperature	0.4 °C
Humidity	2 %
Uncertainty for Radiation Emission test (9 kHz – 30 MHz)	3.44 dB
Uncertainty for Radiation Emission test (30 MHz - 1 GHz)	4.70 dB (Antenna Polarize: V)
	4.84 dB (Antenna Polarize: H)
Uncertainty for Radiation Emission test (1 GHz - 40 GHz)	4.10 dB (1 - 6 GHz)
	4.40 dB (6 GHz - 18 GHz)
	3.54 dB (18 GHz - 26 GHz)
	4.30 dB (26 GHz - 40 GHz)
Uncertainty for Power line conduction emission test	3.34dB (150KHz-30MHz)
	3.72dB (9KHz-150KHz)

Note: This uncertainty represents an expanded uncertainty expressed at approximately the 95% confidence level using a coverage factor of k=2.

3. Equipment Used During Conductive Test

Equipment	Manufacturer	Model No.	Serial Number	Due Date
<input checked="" type="checkbox"/> RF Connected Test (RF Measurement System 3#)				
SIGNAL ANALYZER	R&S	FSV40	101407	2024/07/11
Wideband Radio Communication Tester	R&S	CMW500	117491	2024/04/26
EXG Analog Signal Generator	KEYSIGHT	N5173B	MY62153058	2024/07/11
MXG Vector Signal Generator	Agilent	N5182A	MY48180912	2024/04/22
RF Control Unit	Tonscend	JS0806-2	20C8060230	2024/04/26
TEMP&HUMI Programmable Chamber	ZHIXIANG	ZXGDJS-150L	ZX170110-A	2024/05/14
Test Software	Tonscend	JS1120-3	Ver.3.2.22	N/A

4. 6 dB Bandwidth

4.1. Block diagram of test setup

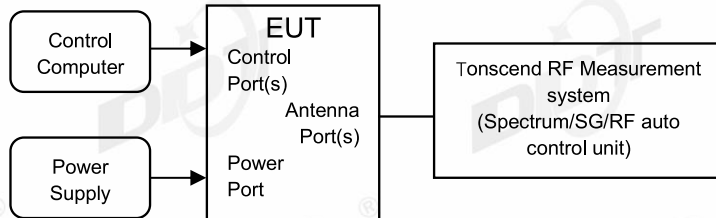

4.2. Limits

For direct sequence systems, the minimum 6 dB bandwidth shall be at least 500 kHz

4.3. Test procedure

- (1) The test according to ANSI C63.10-2013 clause 11.8.
- (2) Connect EUT's antenna output to spectrum analyzer by RF cable, the path loss was compensated to the results
- (3) Set the EUT as maximum power setting and enable the EUT transmit continuously
- (4) Use the following spectrum analyzer settings for 6 dB Bandwidth:

RBW:	100 kHz
VBW:	$\geq [3 \times \text{RBW}]$
Detector Mode:	Peak
Sweep time:	Auto
Trace mode	Max hold
- (5) Allow the trace to stabilize, measure the 6 dB bandwidth of signal, and record the results in the report.

4.4. Test result

Test Mode	Antenna	Frequency [MHz]	DTS BW [MHz]	FL[MHz]	FH[MHz]	Limit [MHz]	Verdict
BLE_1M	Ant1	2402	0.69	2401.66	2402.34	0.5	PASS
		2440	0.70	2439.65	2440.35	0.5	PASS
		2480	0.69	2479.65	2480.34	0.5	PASS
BLE_2M	Ant1	2404	1.26	2403.35	2404.60	0.5	PASS
		2440	1.26	2439.34	2440.60	0.5	PASS
		2478	1.24	2477.36	2478.60	0.5	PASS

4.5. Test graphs

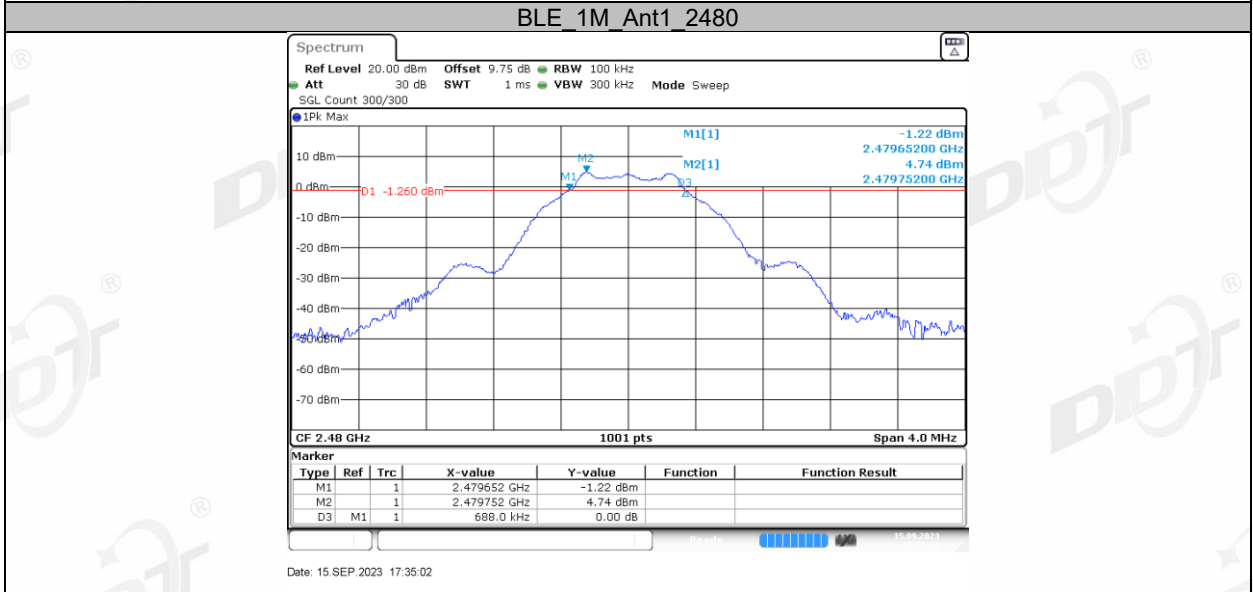
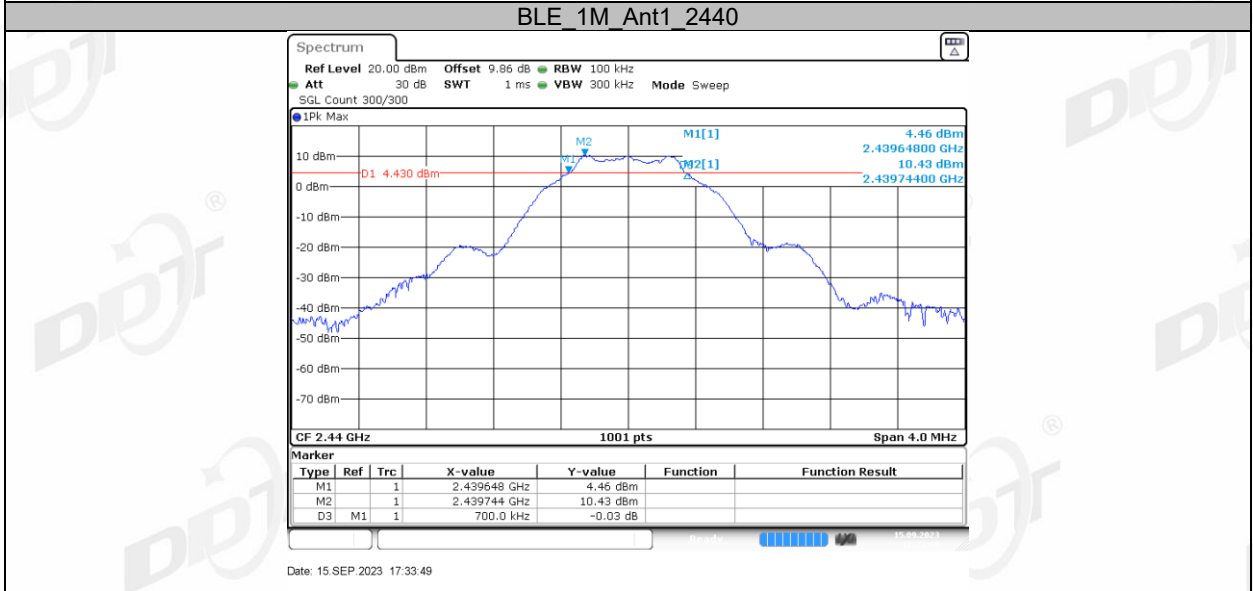
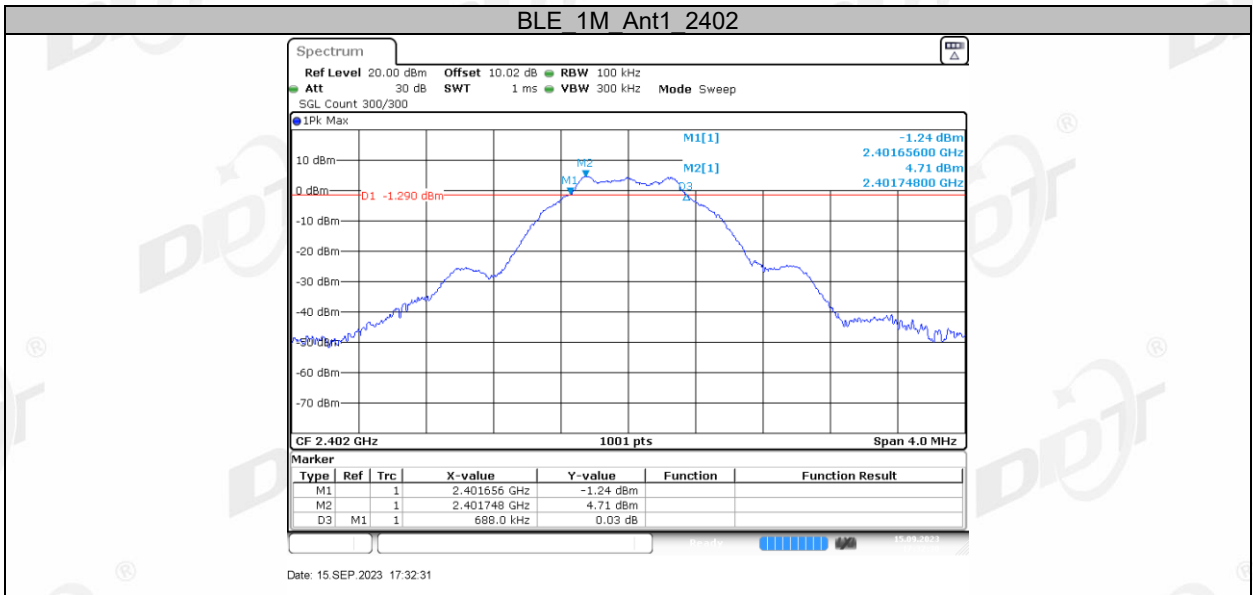

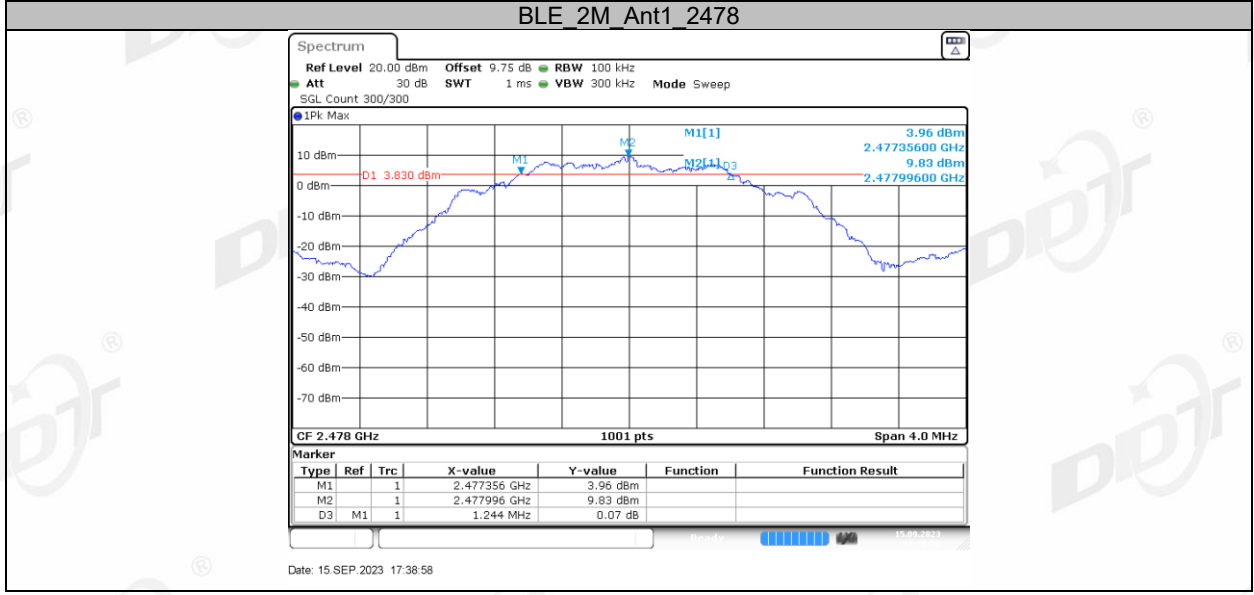
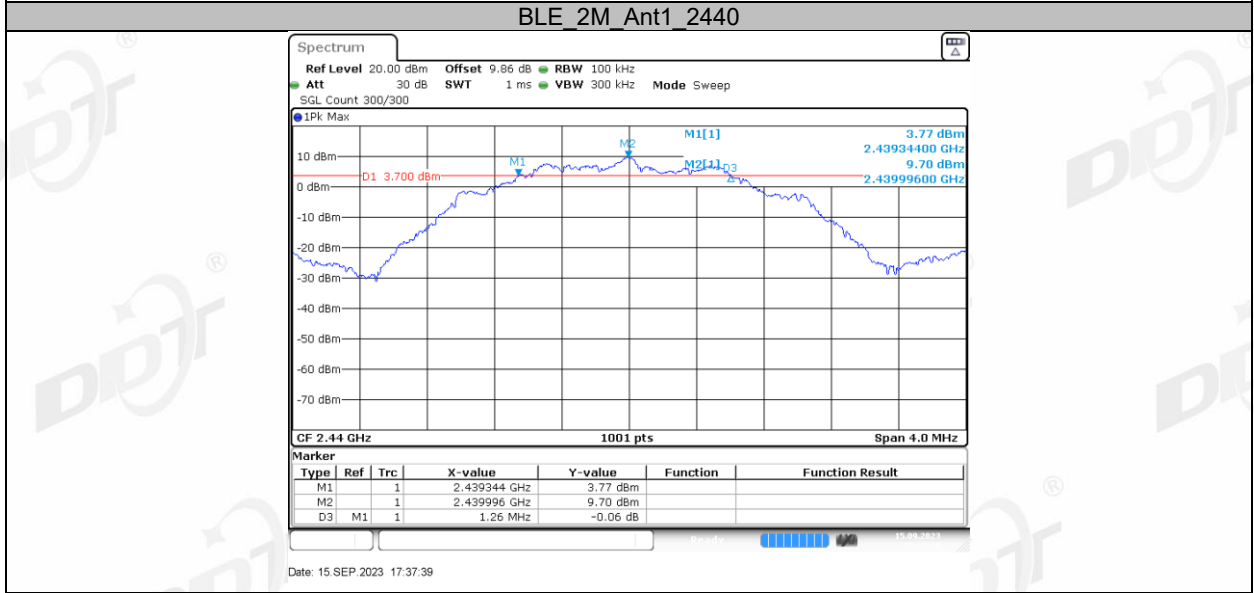
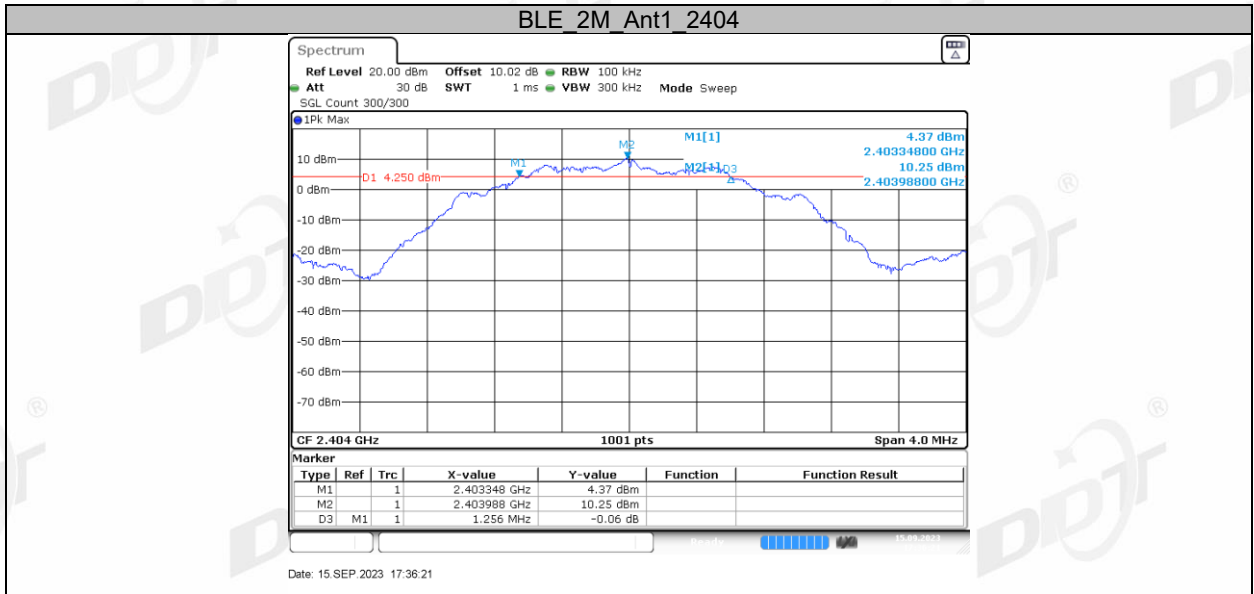

5. 99% Bandwidth

5.1. Block diagram of test setup

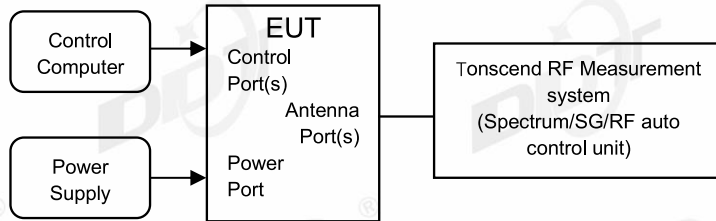

5.2. Limits

Just for Report.

5.3. Test procedure

- (1) The test according to ANSI C63.10-2013 clause 6.9.3.
- (2) Connect EUT's antenna output to spectrum analyzer by RF cable, the path loss was compensated to the results
- (3) Set the EUT as maximum power setting and enable the EUT transmit continuously
- (4) Use the following spectrum analyzer settings for the 99% Bandwidth:
 - RBW: 1% to 5% of the OBW
 - VBW: approximately three times RBW
 - Span: between 1.5 times and 5.0 times the OBW
 - Detector Mode: Peak
 - Sweep time: Auto
 - Trace mode: Max hold
- (5) Allow the trace to stabilize, measure the 99% bandwidth of signal, and record the results in the report.

5.4. Test Result

Test Mode	Antenna	Frequency [MHz]	OCB [MHz]	FL[MHz]	FH[MHz]	Limit [MHz]	Verdict
BLE_1M	Ant1	2402	1.063	2401.4765	2402.5395	---	---
		2440	1.071	2439.4725	2440.5435	---	---
		2480	1.067	2479.4765	2480.5435	---	---
BLE_2M	Ant1	2404	2.082	2402.9770	2405.0589	---	---
		2440	2.074	2438.9810	2441.0549	---	---
		2478	2.082	2476.9770	2479.0589	---	---

5.5. Test Graphs

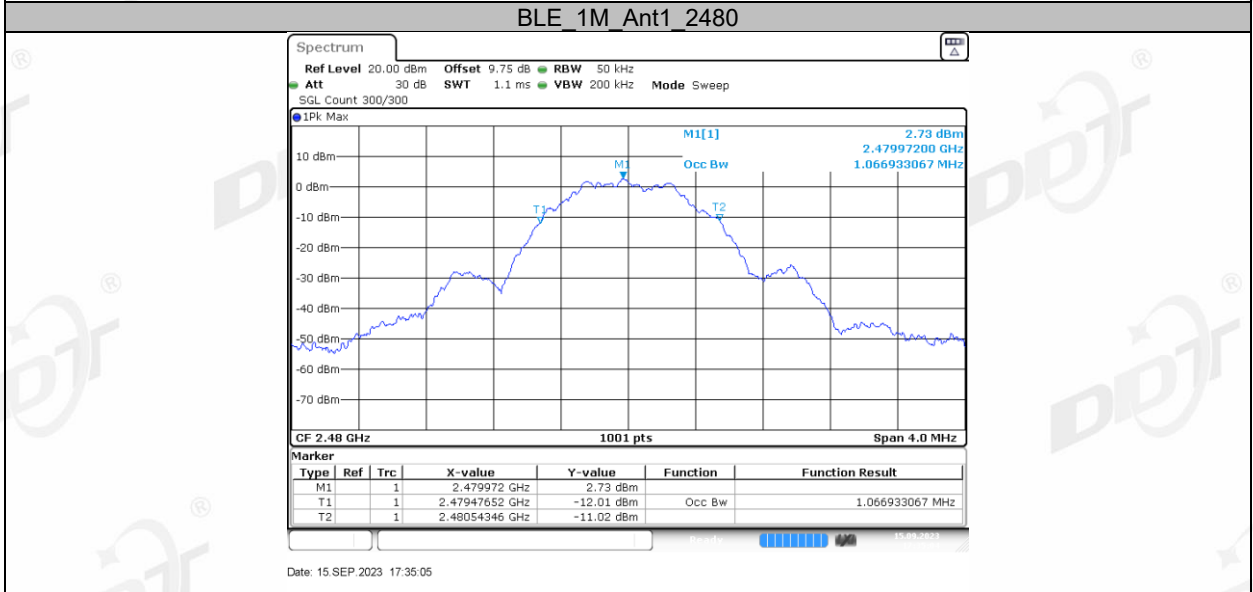
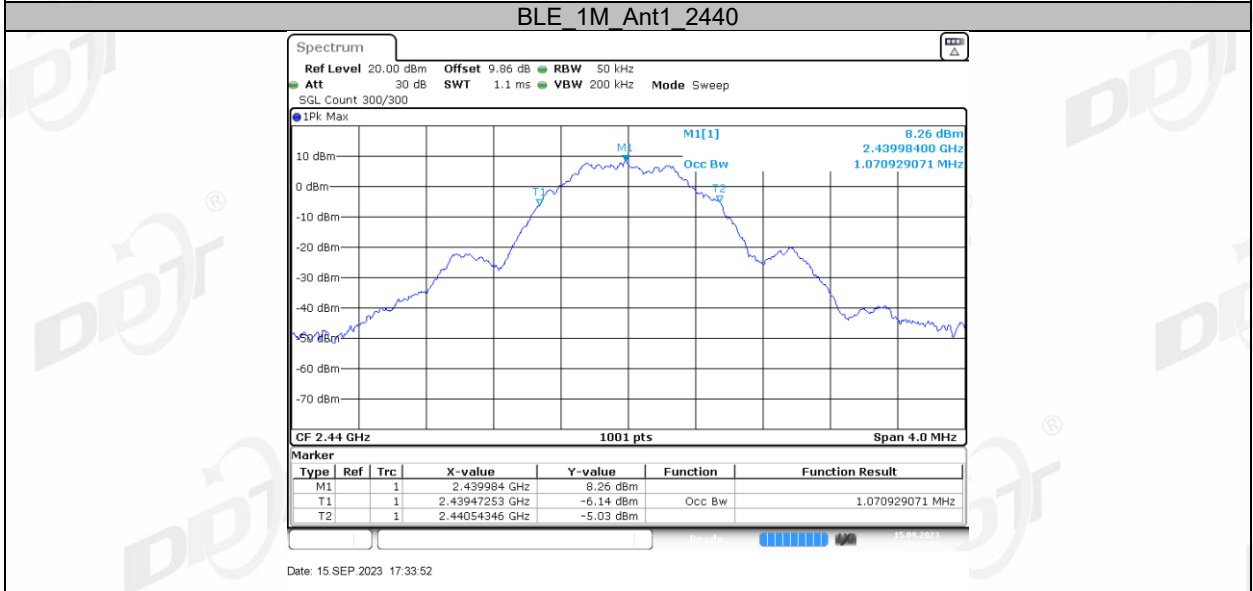
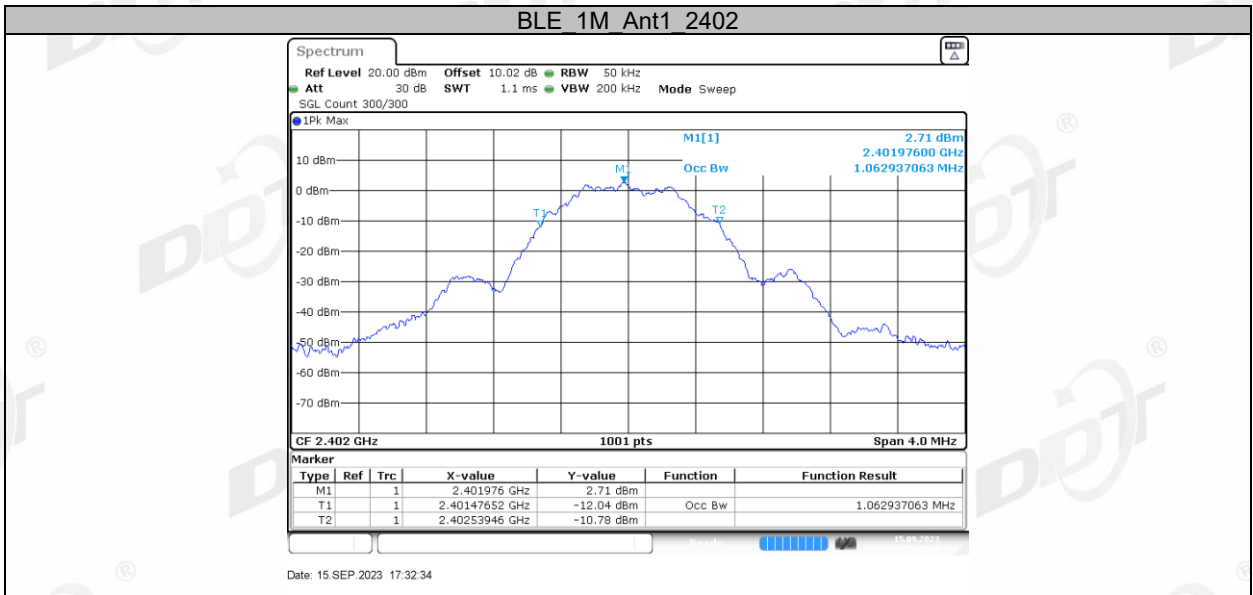

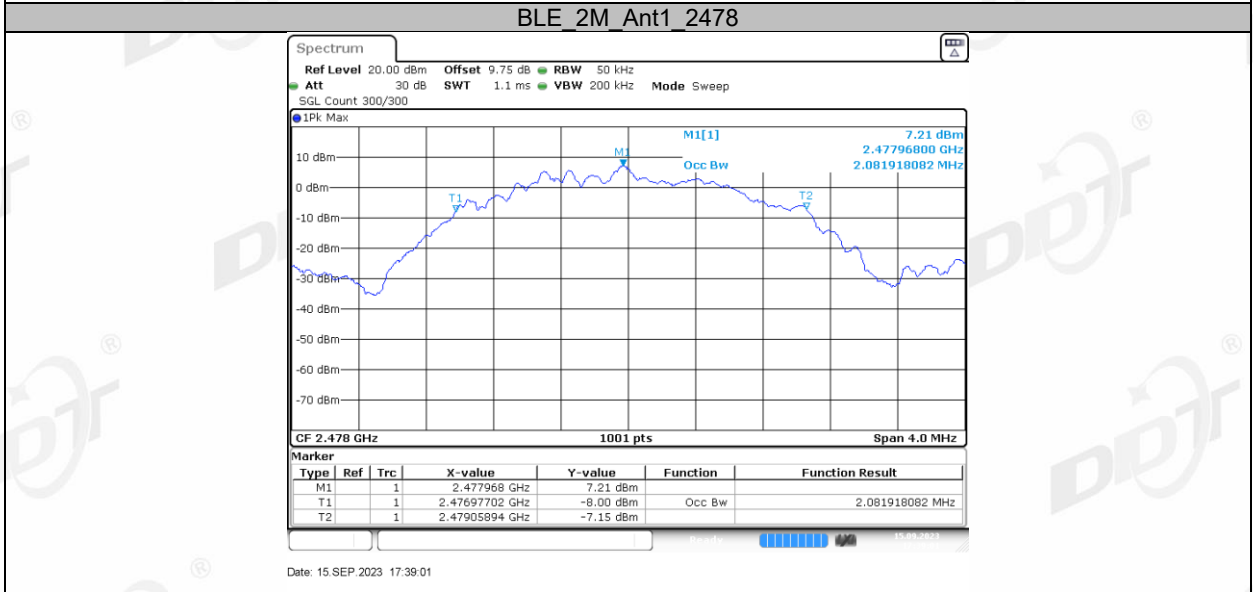
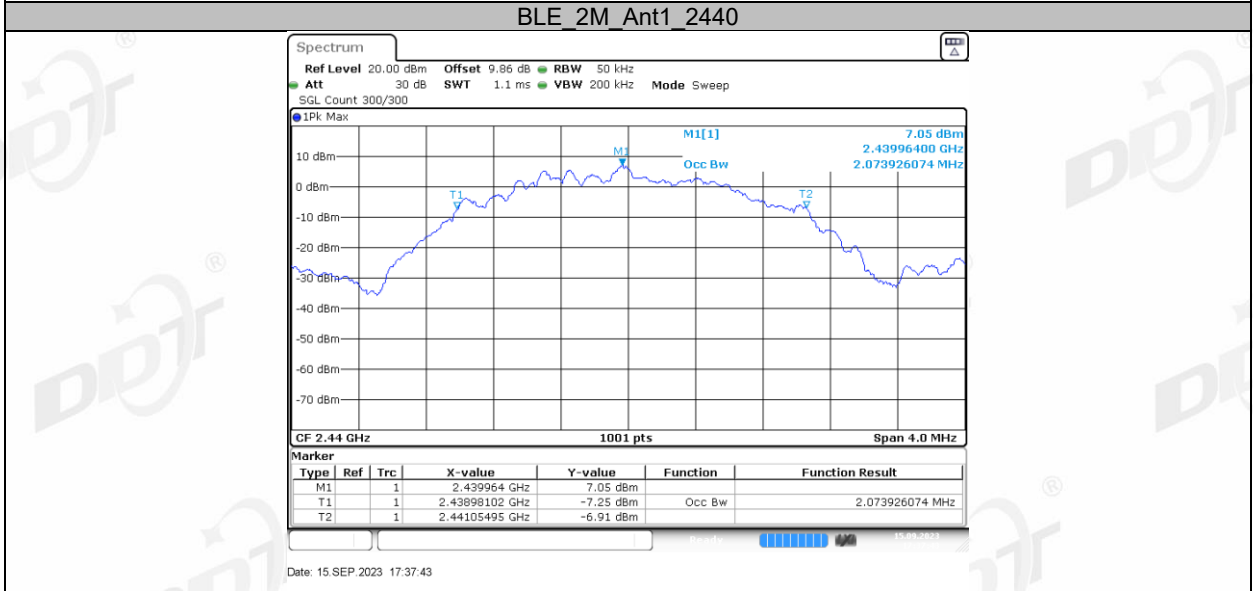
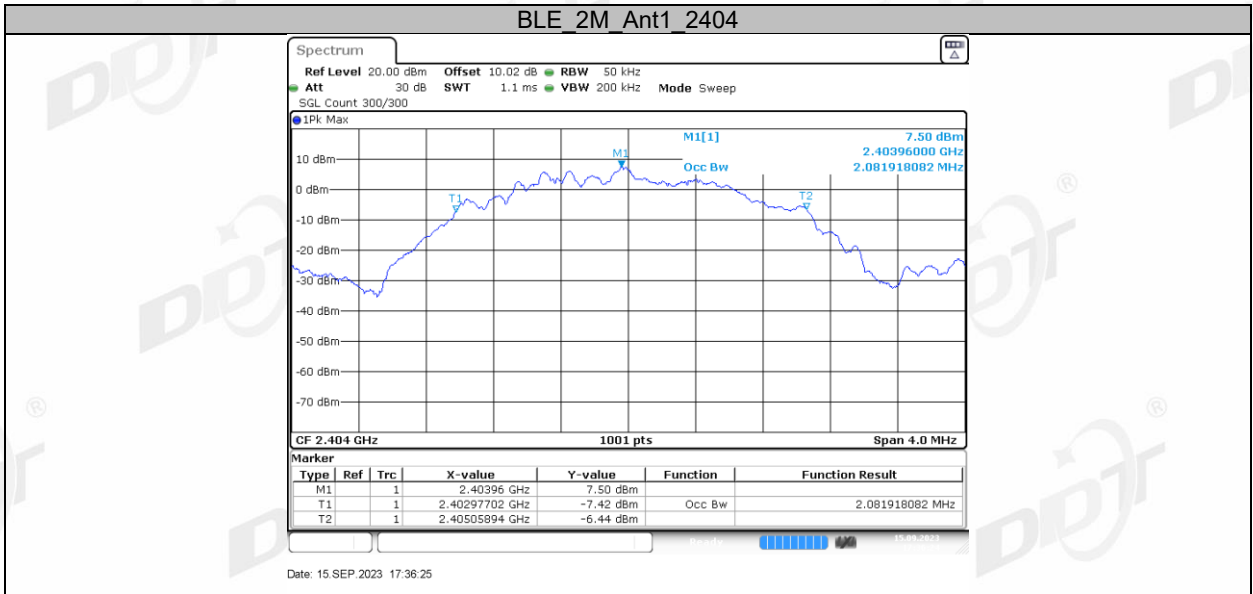

6. Maximum Peak Output Power

6.1. Block diagram of test setup

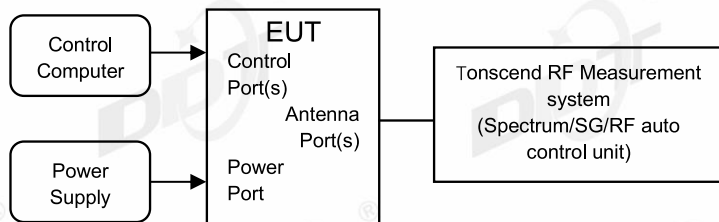

6.2. Limits

For systems using digital modulation in the 902-928 MHz, 2400-2483.5 MHz, and 5725-5850 MHz bands: 1 Watt. If transmitting antennas of directional gain greater than 6dBi are used, the conducted output power from the intentional radiator shall be reduced below the stated values as appropriate, by the amount in dB that the directional gain of the antenna exceeds 6 dBi, the e.i.r.p shall not exceed 4W.

6.3. Test procedure

- (1) The test according to ANSI C63.10-2013 clause 11.9.1.1.
- (2) Connect EUT's antenna output to spectrum analyzer by RF cable, the path loss was compensated to the results.
- (3) Set the EUT as maximum power setting and enable the EUT transmit continuously.
- (4) Use the following spectrum analyzer settings for the maximum peak output power measurement:

RBW:	≥DTS bandwidth
VBW:	≥3 x RBW
Span	≥3 x RBW
Detector Mode:	Peak
Sweep time:	Auto
Trace mode	Max hold
- (5) Allow the trace to stabilize, use peak marker function to determine the peak amplitude level.

6.4. Test result

Test Mode	Antenna	Frequency [MHz]	Conducted Peak Power[dBm]	Conducted Limit[dBm]	EIRP[dBm]	EIRP Limit[dBm]	Verdict
BLE_1M	Ant1	2402	5.5	≤30	7.59	≤36	PASS
		2440	11.23	≤30	13.32	≤36	PASS
		2480	5.52	≤30	7.61	≤36	PASS
BLE_2M	Ant1	2404	11.89	≤30	13.98	≤36	PASS
		2440	11.35	≤30	13.44	≤36	PASS
		2478	11.46	≤30	13.55	≤36	PASS

6.5. Test graphs

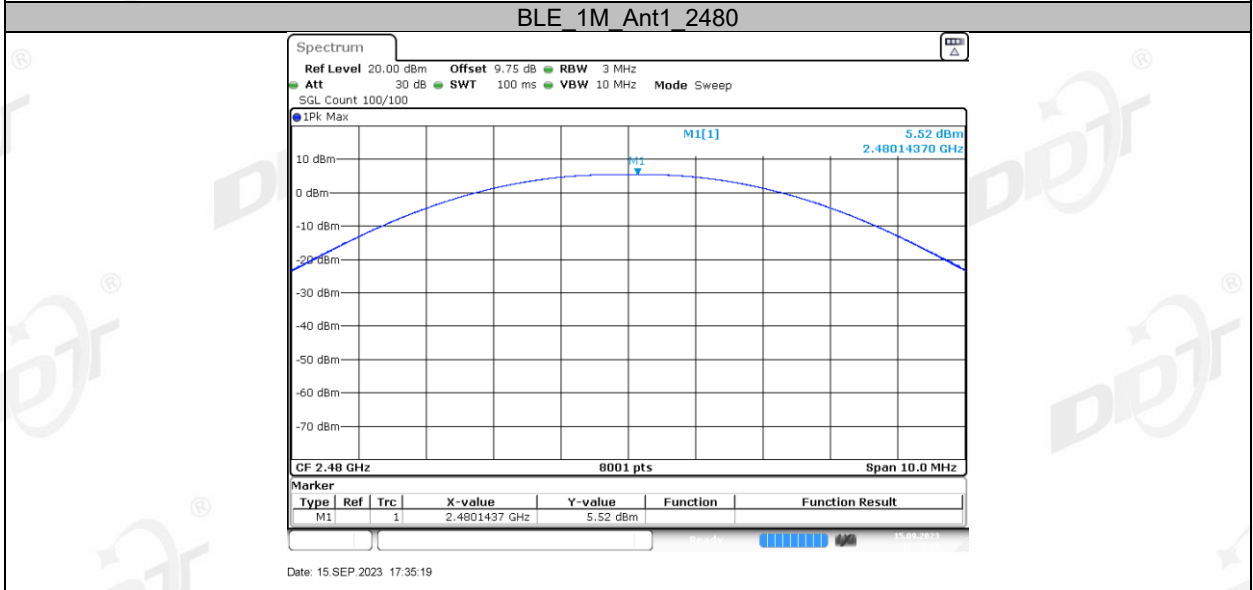
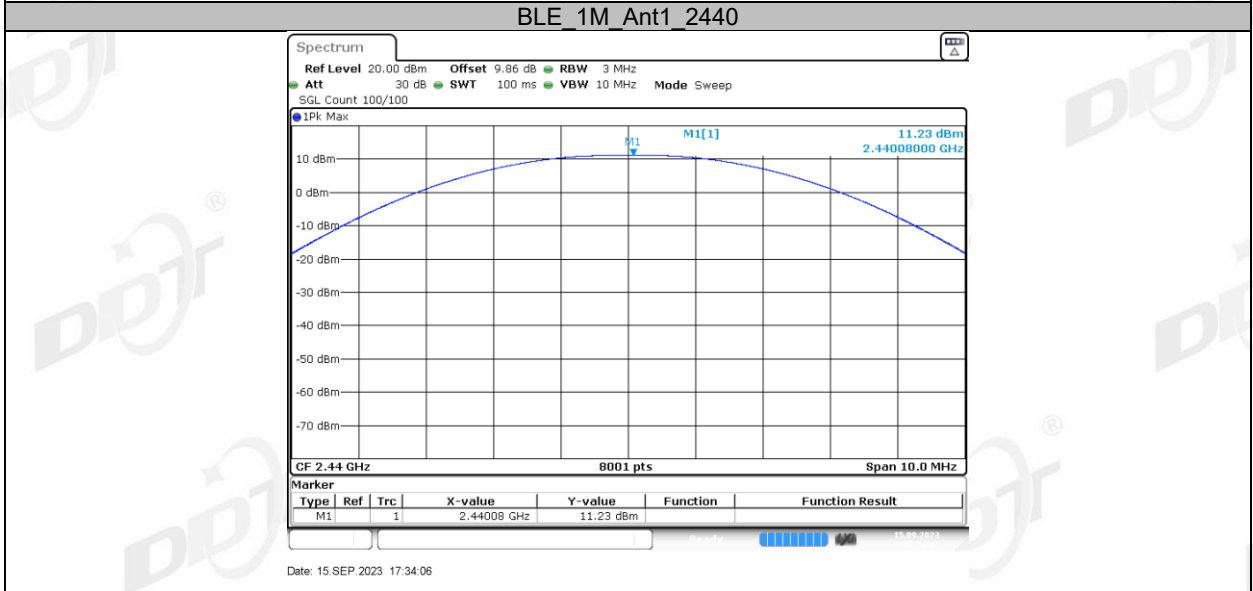
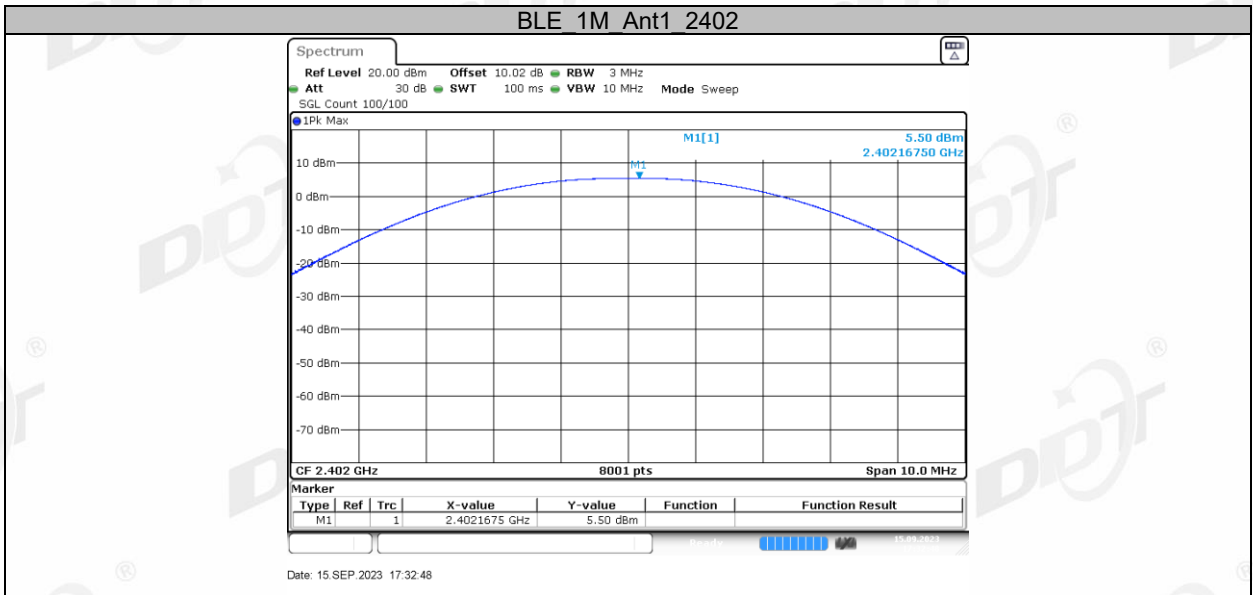

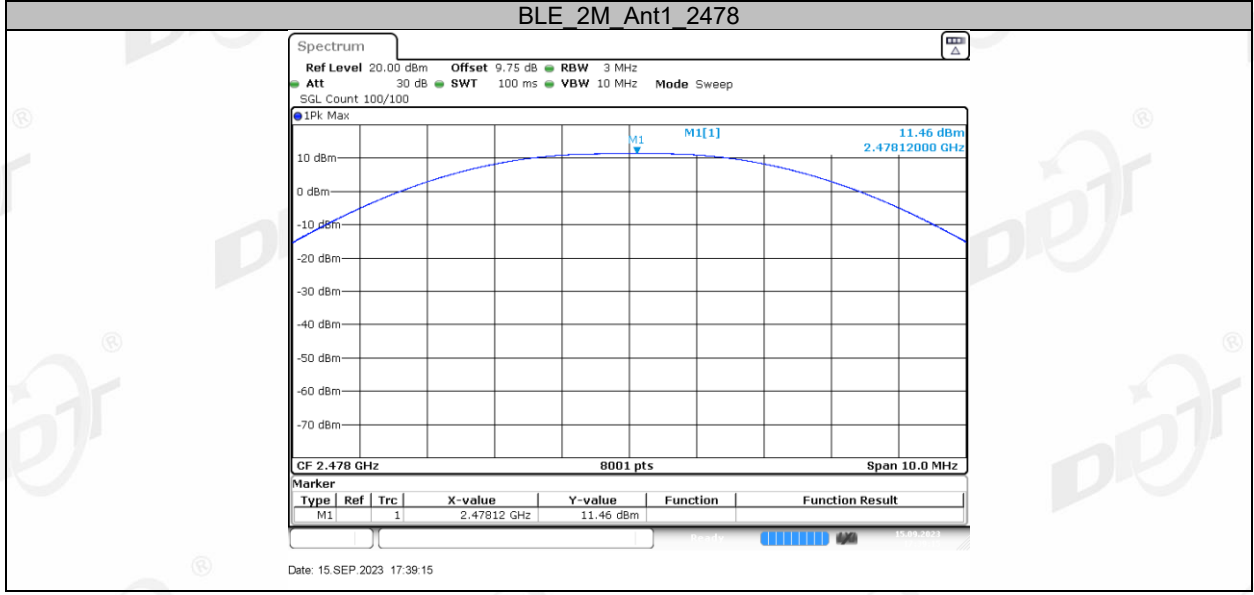
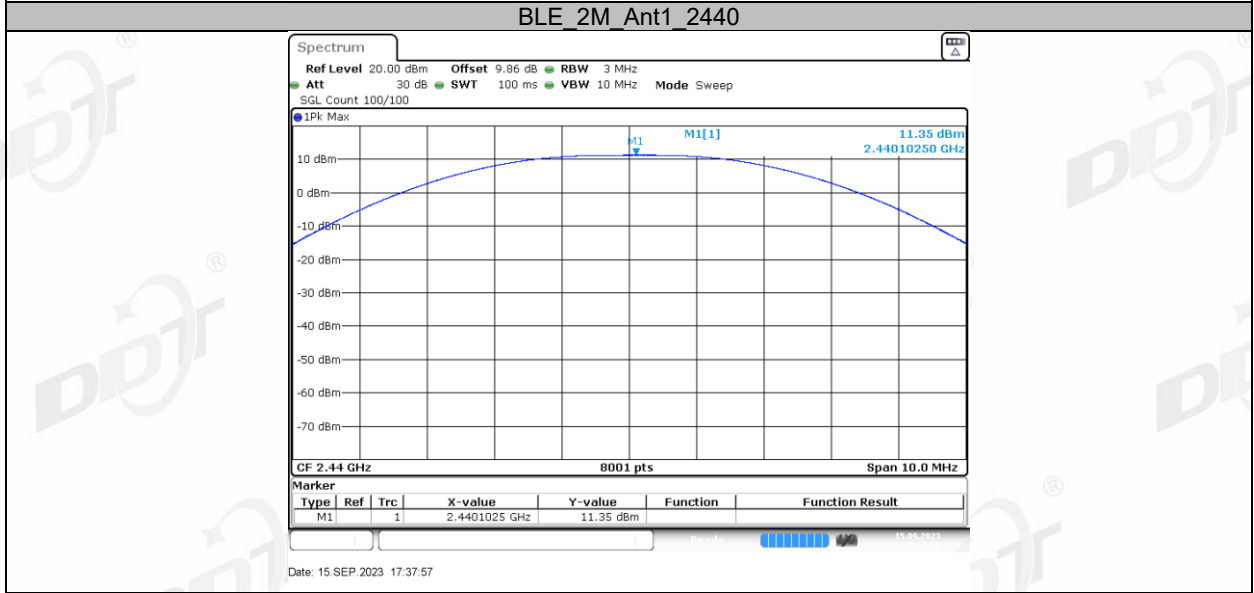
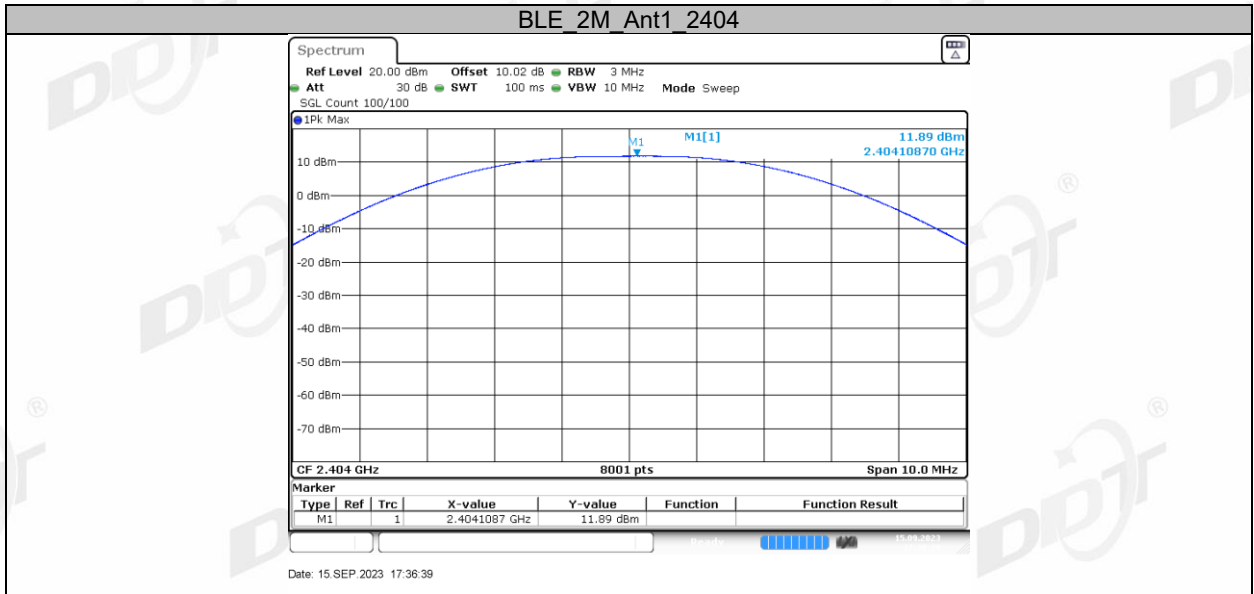

7. Power Spectral Density

7.1. Block diagram of test setup

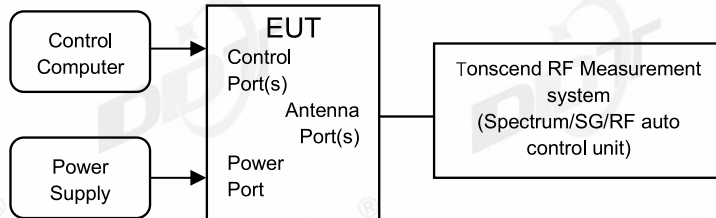

7.2. Limits

For digitally modulated systems, the power spectral density conducted from the intentional radiator to the antenna shall not be greater than 8 dBm in any 3 kHz band during any time interval of continuous transmission.

7.3. Test procedure

- (1) The test according to ANSI C63.10-2013 clause 11.10.2.
- (2) Connect EUT's antenna output to spectrum analyzer by RF cable, the path loss was compensated to the results.
- (3) Set the EUT as maximum power setting and enable the EUT transmit continuously.
- (4) Use the following spectrum analyzer settings for Power Spectral Density measurement:

Center frequency	DTS Channel center frequency
RBW:	$3 \text{ kHz} \leq \text{RBW} \leq 100 \text{ kHz}$
VBW:	$\geq 3\text{RBW}$
Span	1.5 times the DTS bandwidth
Detector Mode:	Peak
Sweep time:	Auto
Trace mode	Max hold
- (5) Allow the trace to stabilize, use the peak marker function to determine the maximum amplitude level within the RBW.

If measured value exceeds limit, reduce RBW (no less than 3 kHz) and repeat.

7.4. Test result

Test Mode	Antenna	Frequency [MHz]	Result [dBm/3kHz]	Limit [dBm/3kHz]	Verdict
BLE_1M	Ant1	2402	-10.3	≤ 8.00	PASS
		2440	-4.48	≤ 8.00	PASS
		2480	-10.2	≤ 8.00	PASS
BLE_2M	Ant1	2404	-6.21	≤ 8.00	PASS
		2440	-6.67	≤ 8.00	PASS
		2478	-6.51	≤ 8.00	PASS

7.5. Test graphs

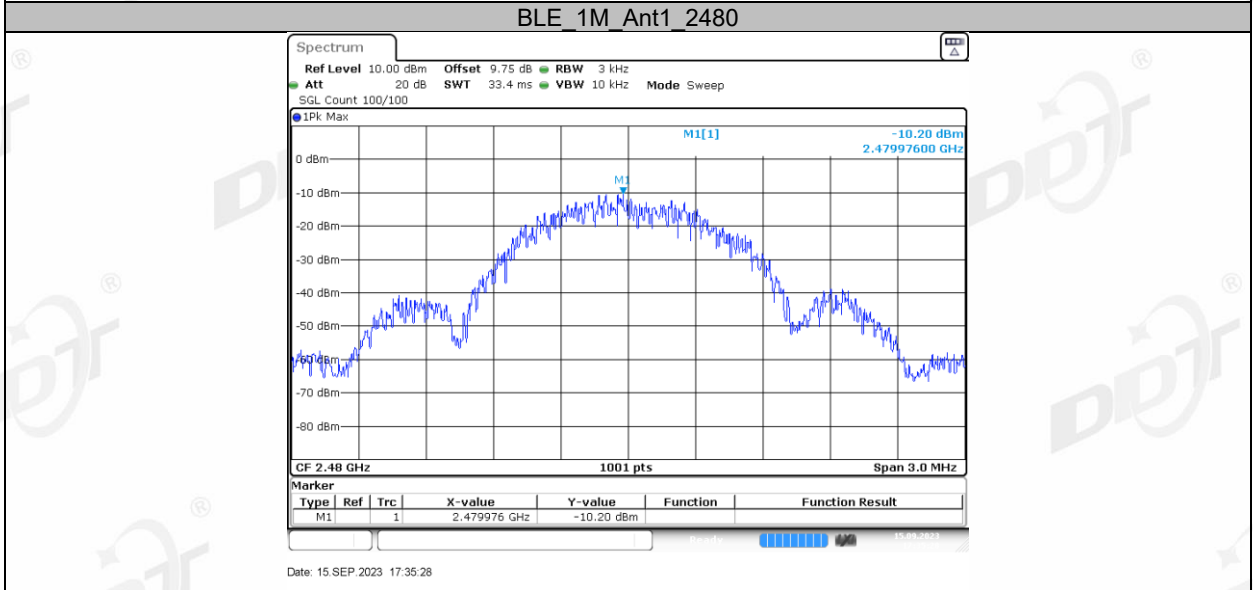
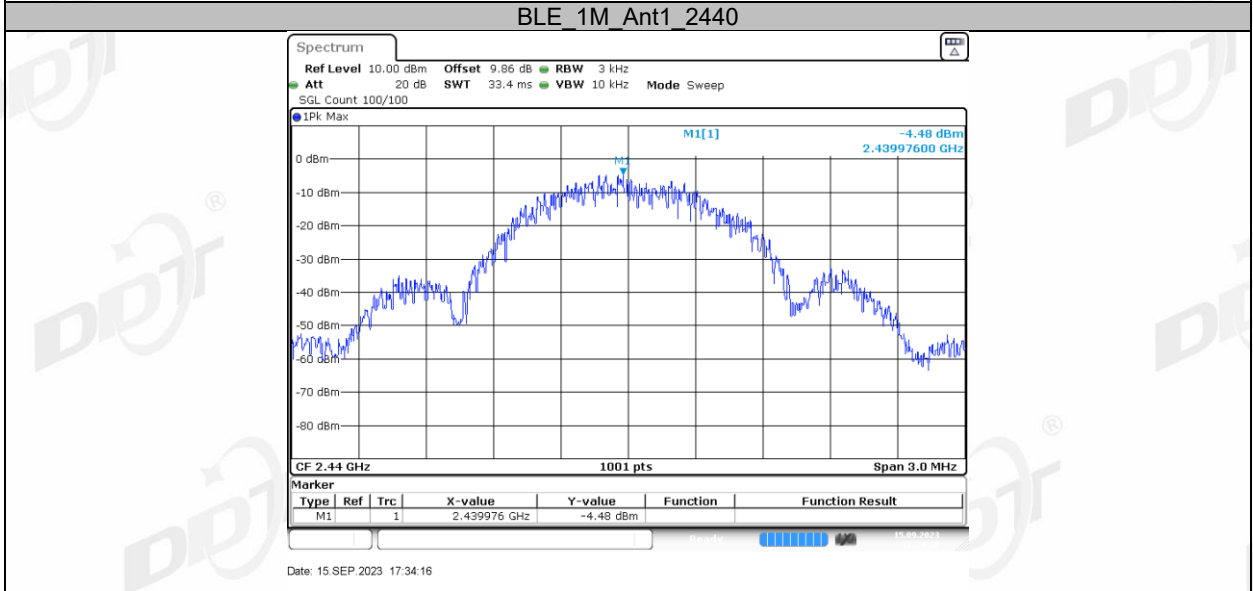
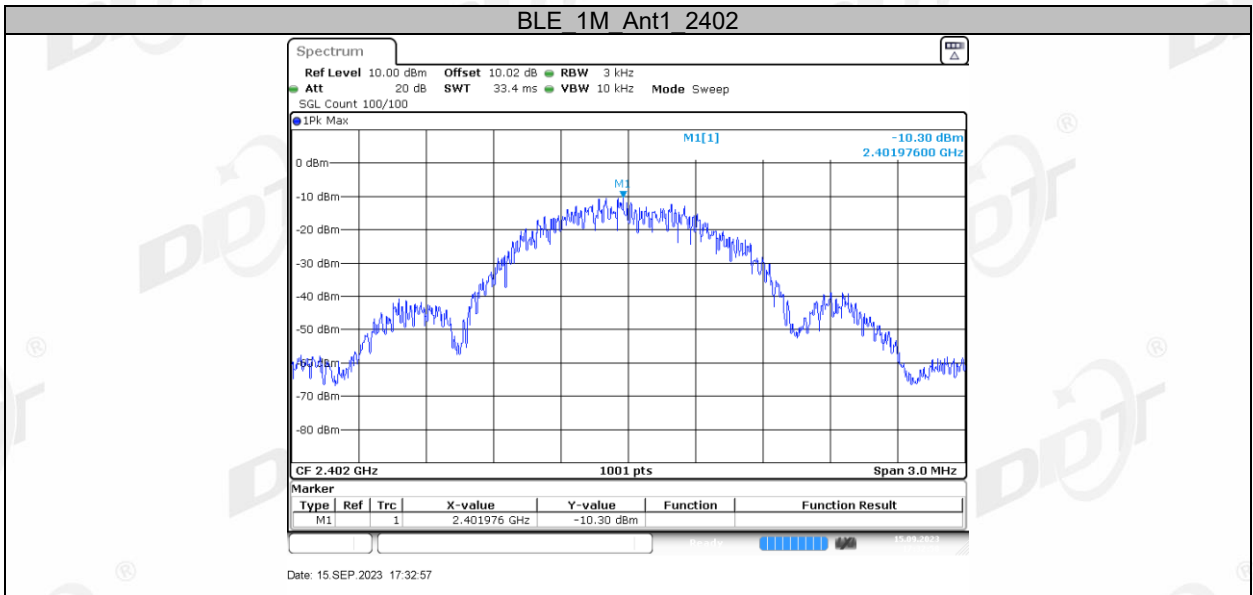

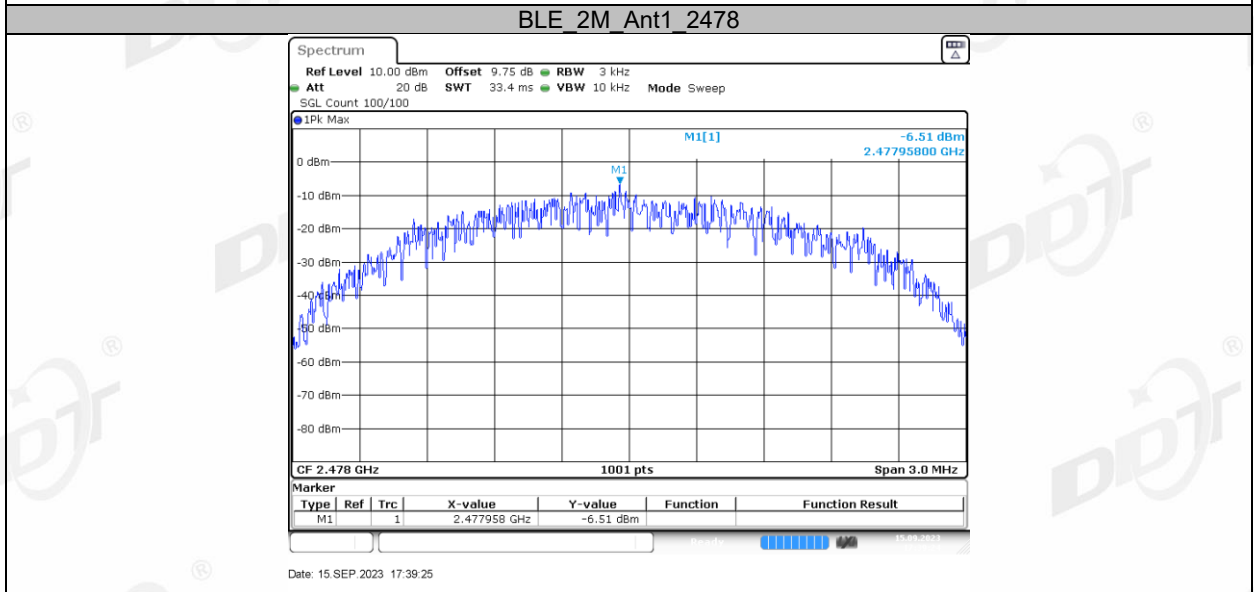
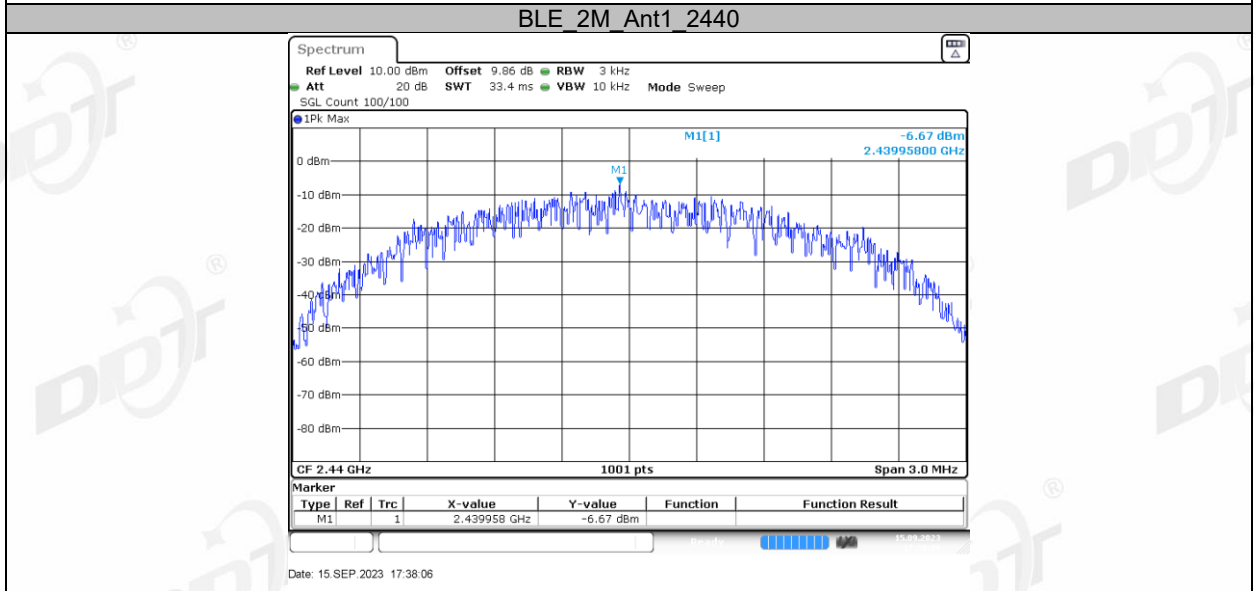
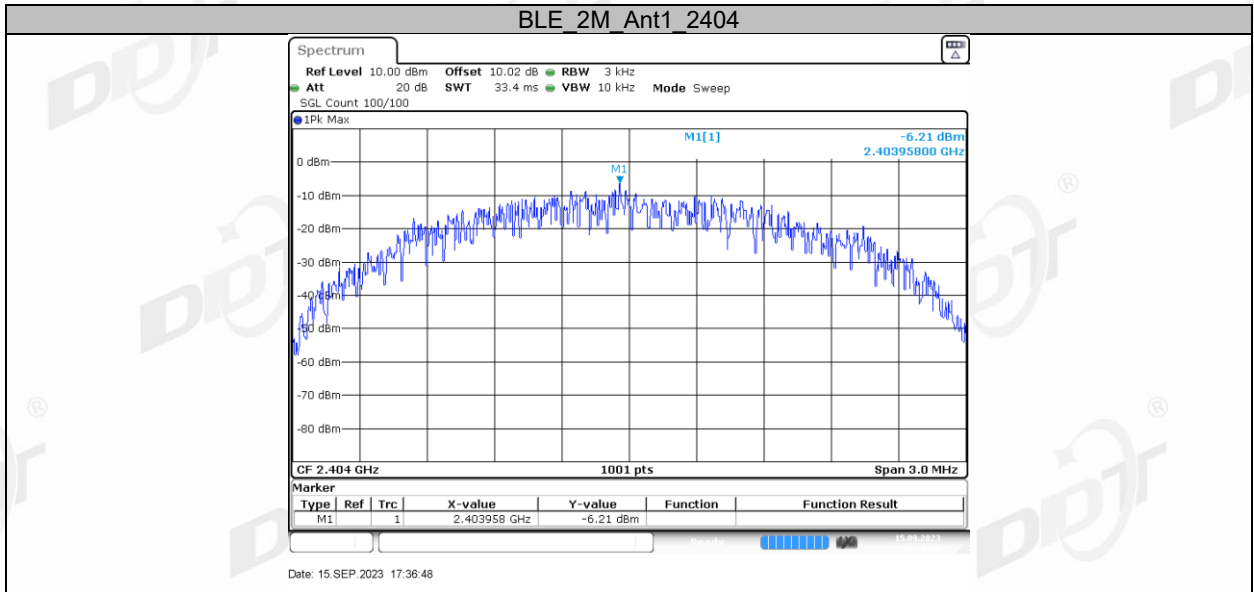

8. Band Edge Compliance (Conducted Method)

8.1. Block diagram of test setup

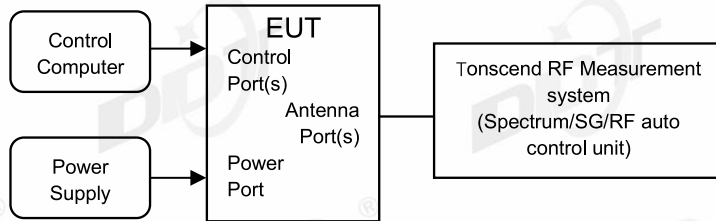

8.2. Limits

In any 100 kHz bandwidth outside the frequency bands in which the spread spectrum intentional radiator is operating, the radio frequency power that is produced by the intentional radiator shall be at least 20 dB below that in the 100 kHz bandwidth within the band that contains the highest level of the desired power.

8.3. Test procedure

- (1) Connect EUT's antenna output to spectrum analyzer by RF cable.
- (2) Establish a reference level by using the following procedure:

RBW:	100 kHz
VBW:	300 kHz
Span	Encompass frequency range to be measured
Detector Mode:	Peak
Sweep time:	Auto
Trace mode	Max hold
- (3) Allow the trace to stabilize, use the peak marker function to determine the maximum peak power level to establish the reference level.
- (4) Then mark the maximum amplitude of all unwanted emissions outside of the authorized frequency band.

8.4. Test result

Mode	Freq. (MHz)	Verdict
GFSK 1M	2402	Pass
	2480	Pass
GFSK 2M	2404	Pass
	2478	Pass

8.5. Test graphs

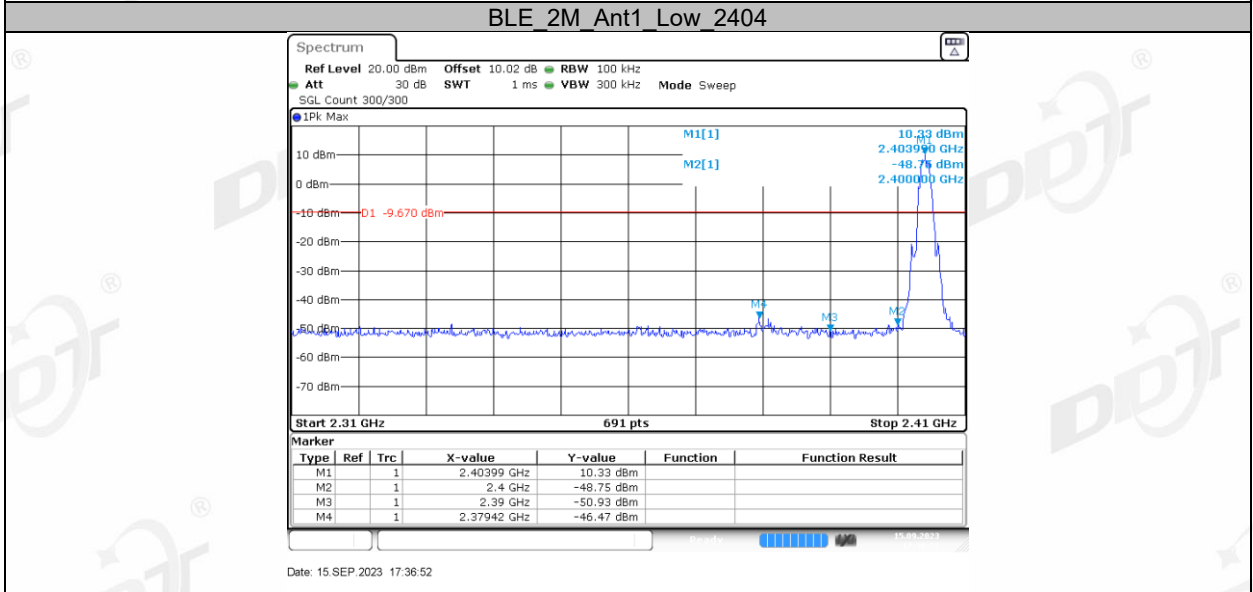
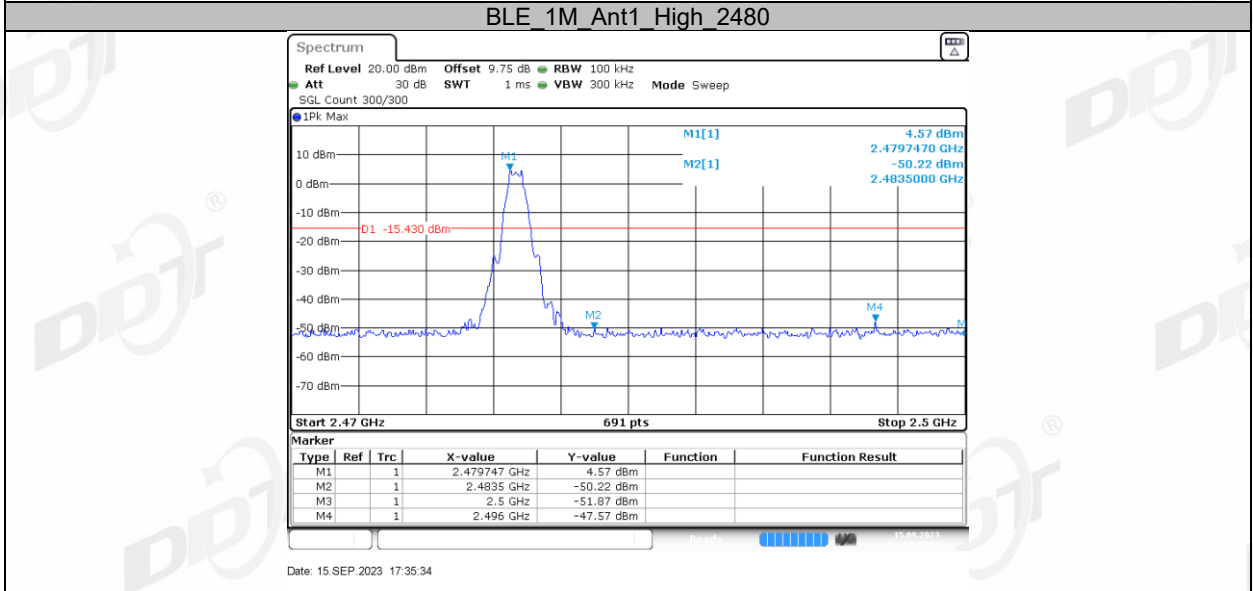
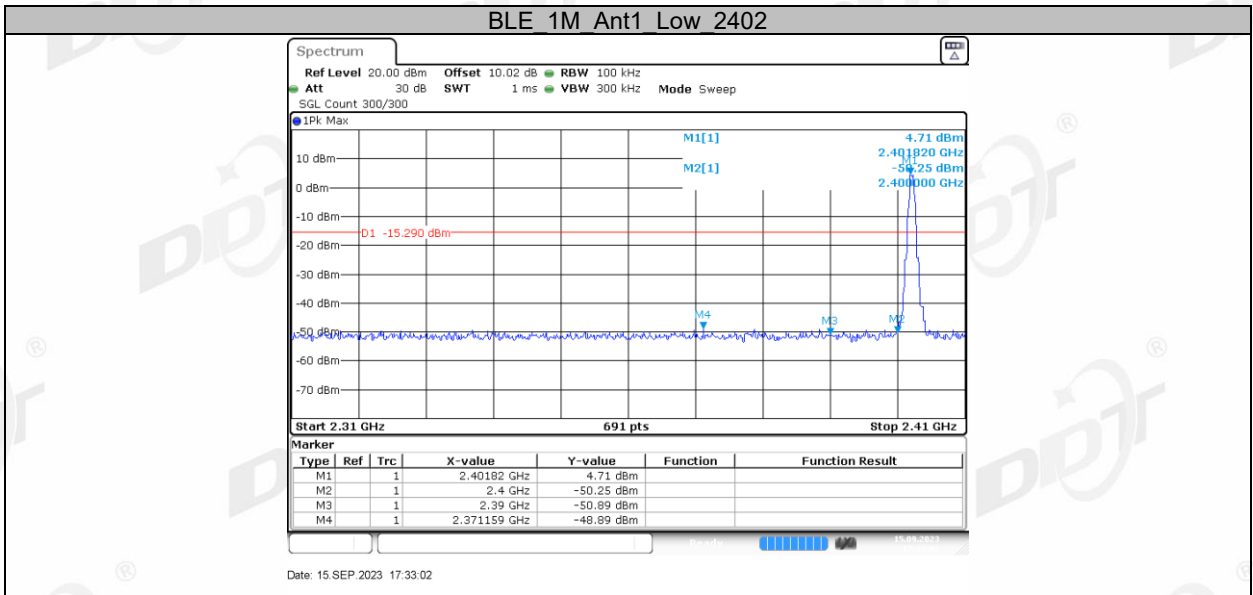

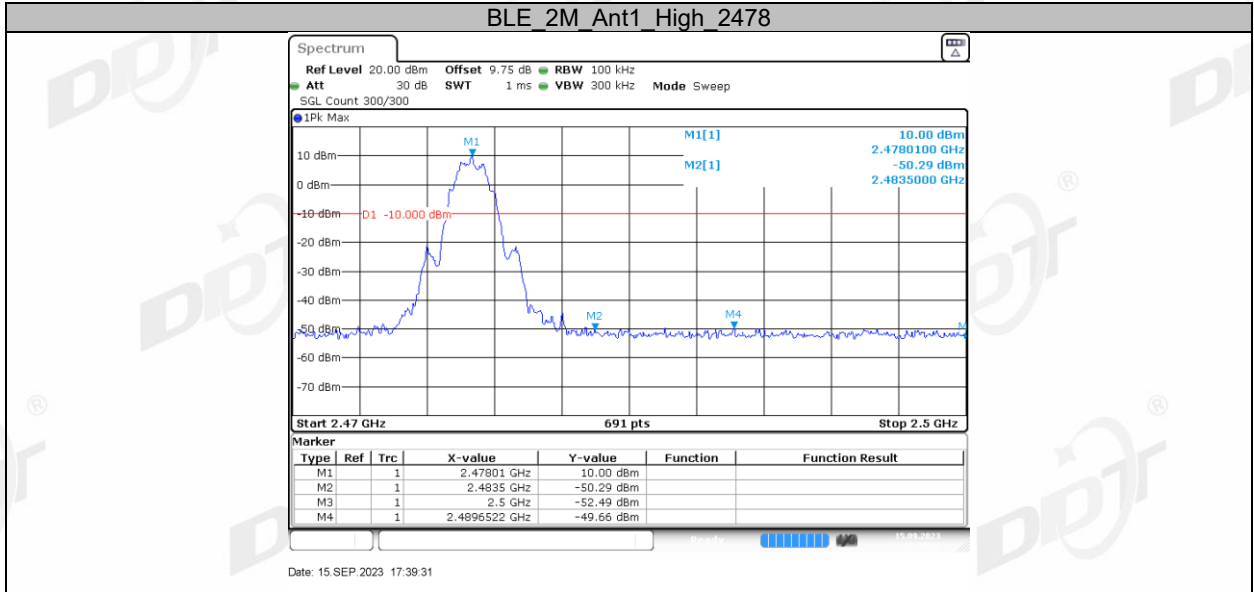

9. RF Conducted Spurious Emissions

9.1. Block diagram of test setup

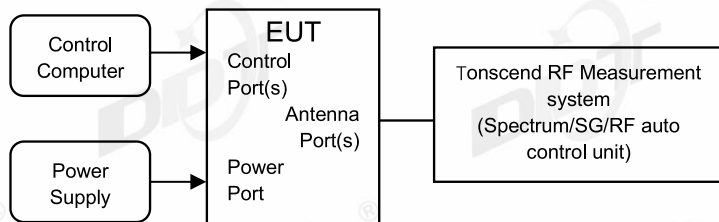

9.2. Limits

In any 100 kHz bandwidth outside the frequency bands in which the spread spectrum intentional radiator is operating, the radio frequency power that is produced by the intentional radiator shall be at least 20 dB below that in the 100 kHz bandwidth within the band that contains the highest level of the desired power.

9.3. Test procedure

- (1) Connect EUT's antenna output to spectrum analyzer by RF cable.
- (2) Establish a reference level by using the following procedure:

Center frequency	Test frequency
RBW:	100 kHz
VBW:	300 kHz
Span	Wide enough to capture the peak level of the in-band emission
Detector Mode:	Peak
Sweep time:	Auto
Trace mode	Max hold

- (3) Allow the trace to stabilize, use the peak marker function to determine the maximum peak power level to establish the reference level.

- (4) Set the spectrum analyzer as follows:

RBW:	100 kHz
VBW:	300 kHz
Span	Encompass frequency range to be measured
Number of measurement points	$\geq \text{Span}/\text{RBW}$
Detector Mode:	Peak
Sweep time:	Auto

Trace mode

Max hold

Allow the trace to stabilize, use the peak marker function to determine the maximum amplitude of all unwanted emissions outside of the authorized frequency band

9.4. Test result

Mode	Freq. (MHz)	Verdict
GFSK 1M	2402	Pass
	2440	Pass
	2480	Pass
GFSK 2M	2404	Pass
	2440	Pass
	2478	Pass

9.5. Test graphs

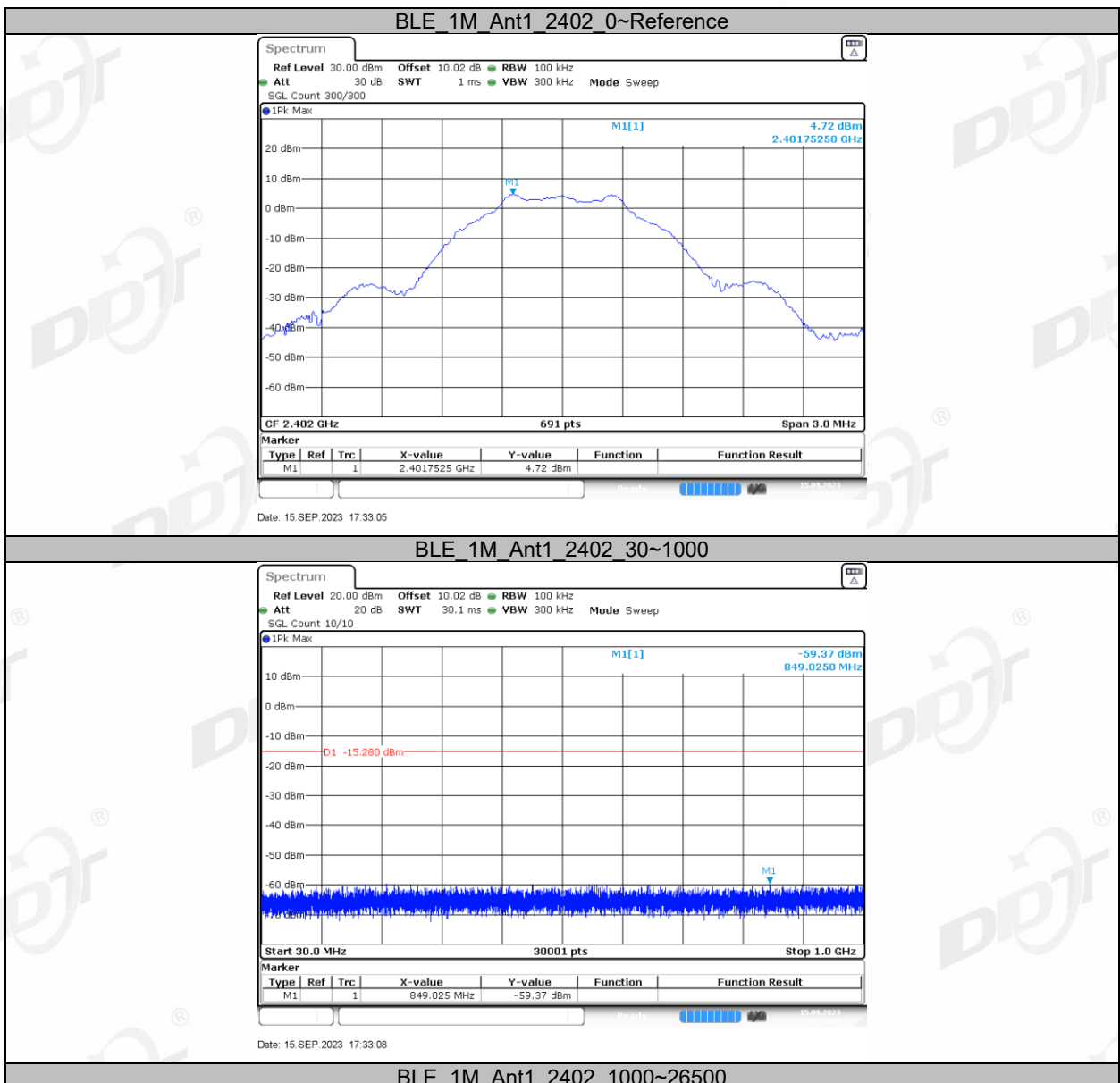

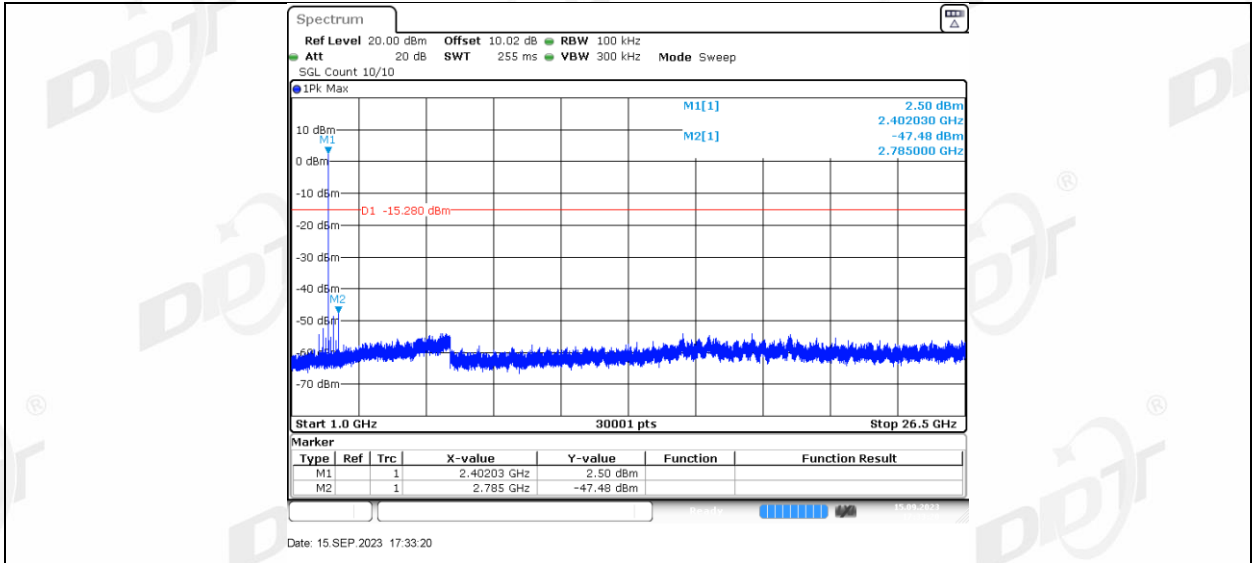

BLE 1M Ant1 2440 0~Reference

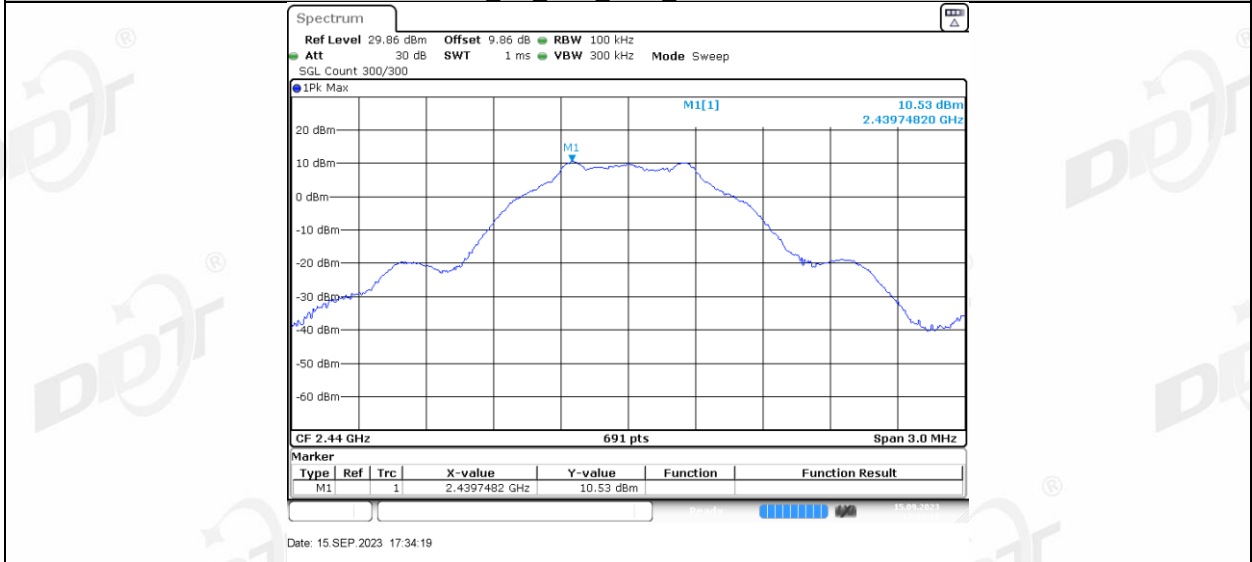

BLE 1M Ant1 2440 30~1000

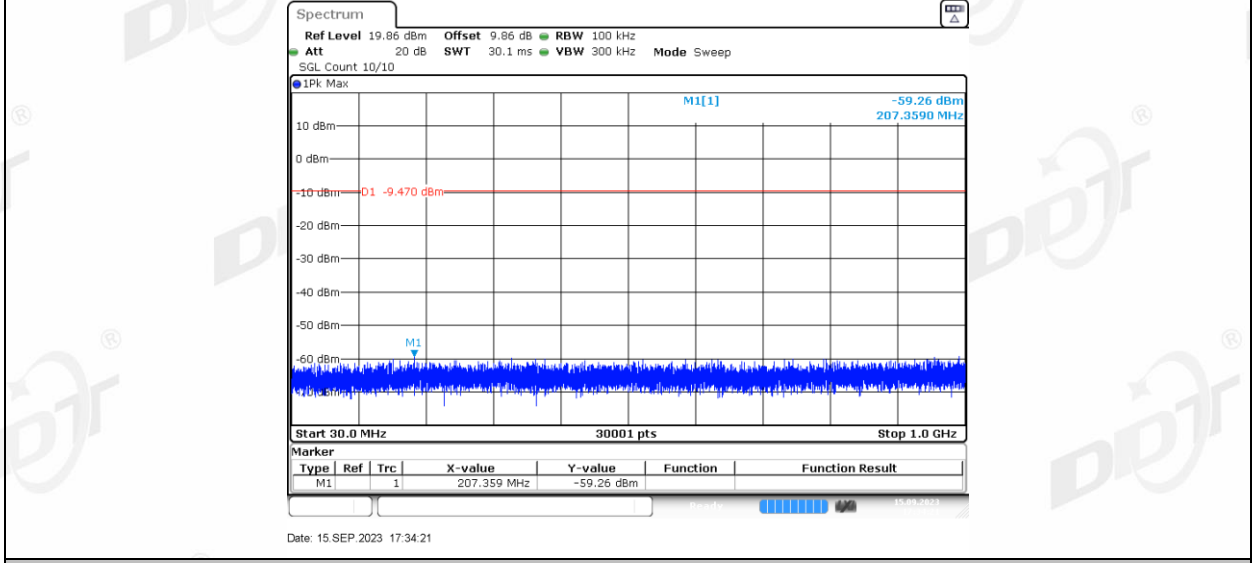

BLE 1M Ant1 2440 1000~26500

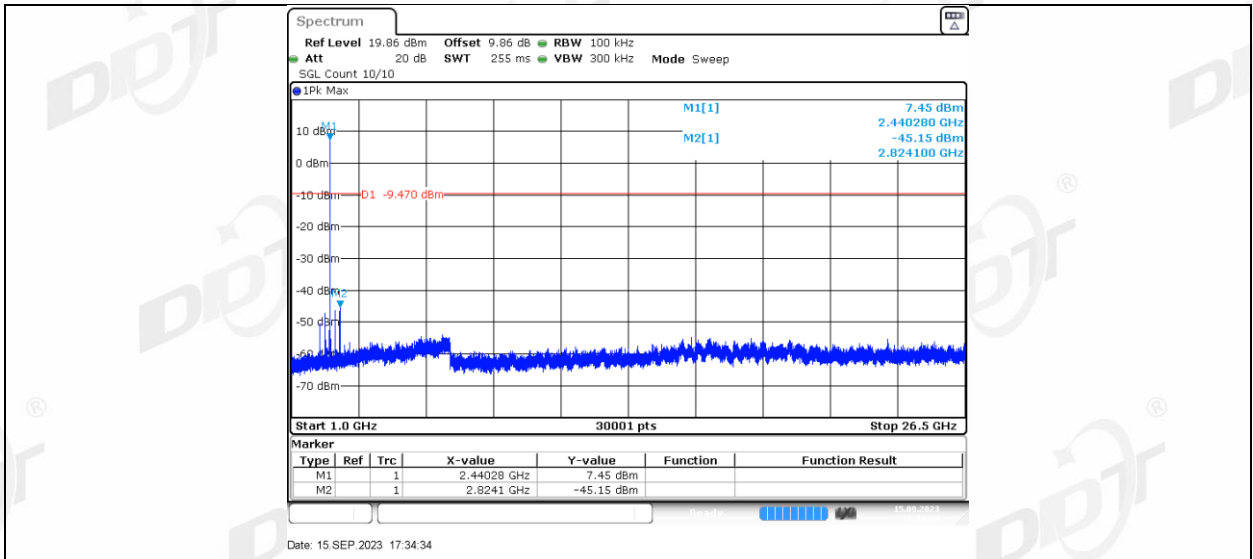

BLE 1M Ant1 2480 0~Reference

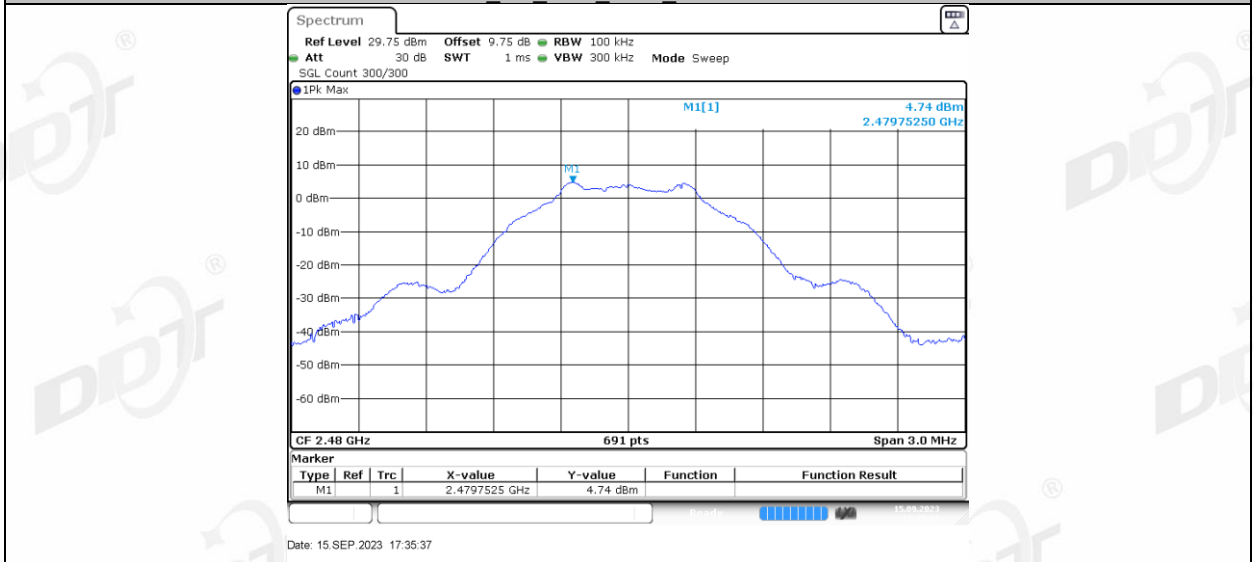

BLE 1M Ant1 2480 30~1000

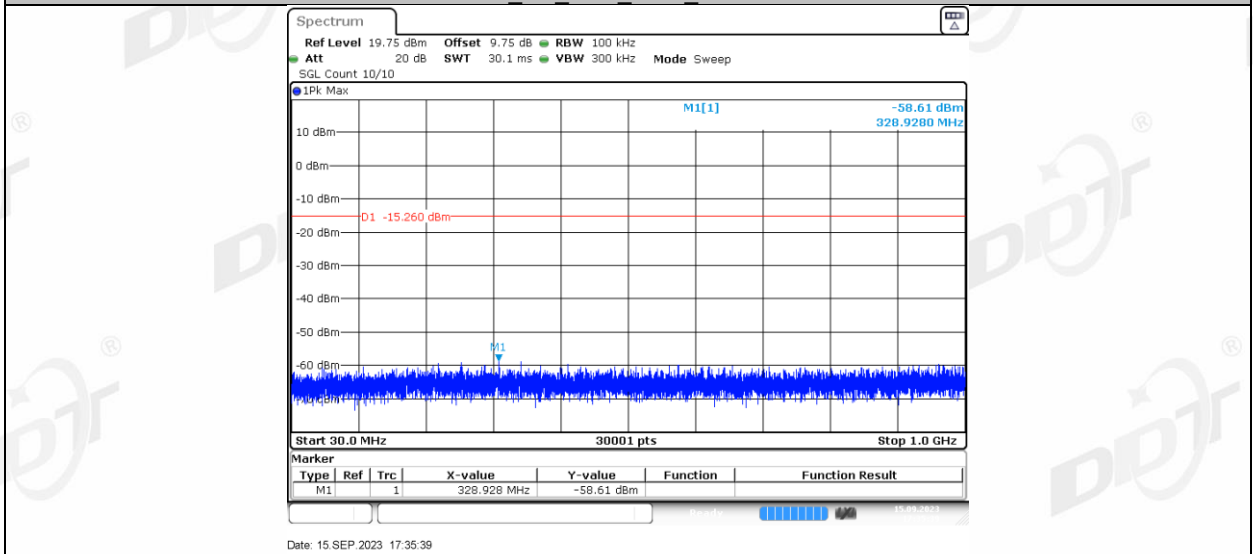

BLE 1M Ant1 2480 1000~26500

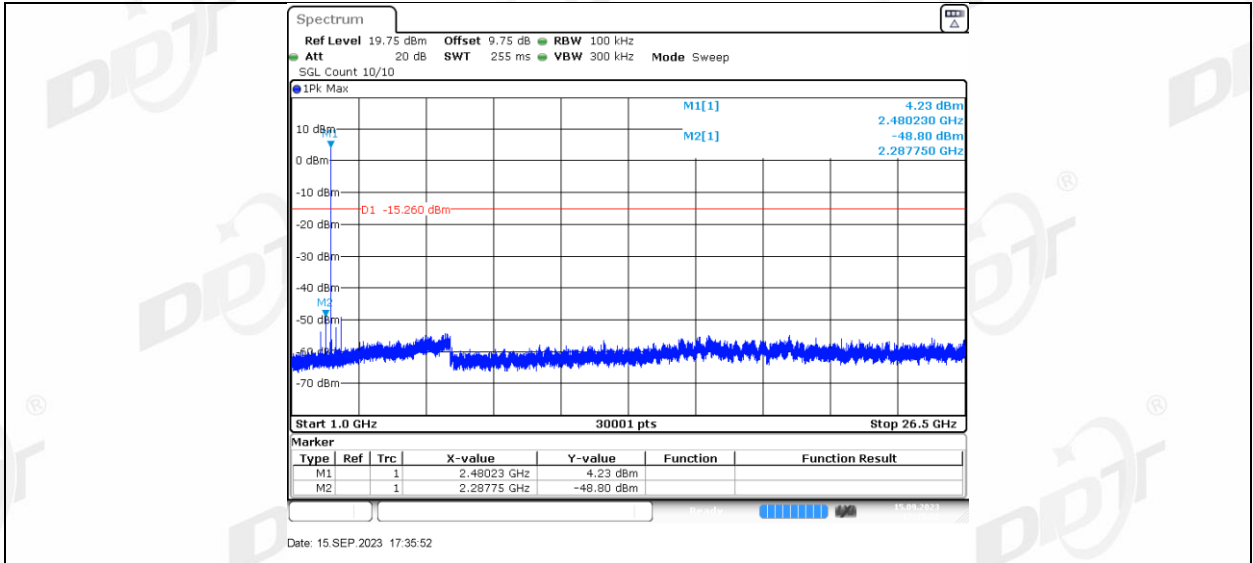

BLE_2M_Ant1_2404_0~Reference

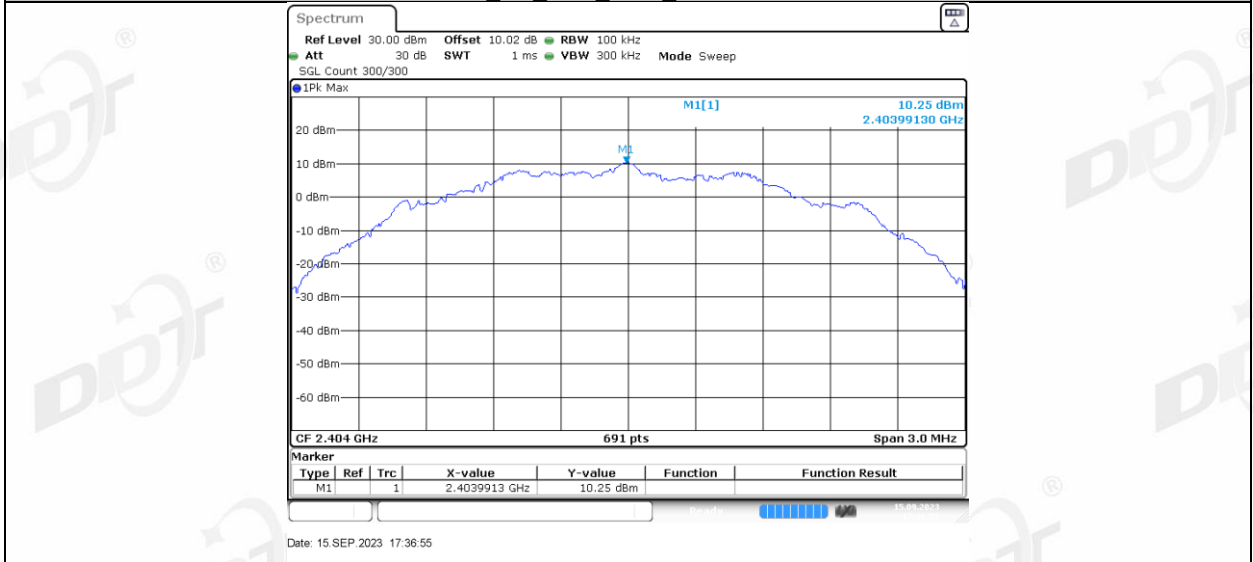

BLE_2M_Ant1_2404_30~1000

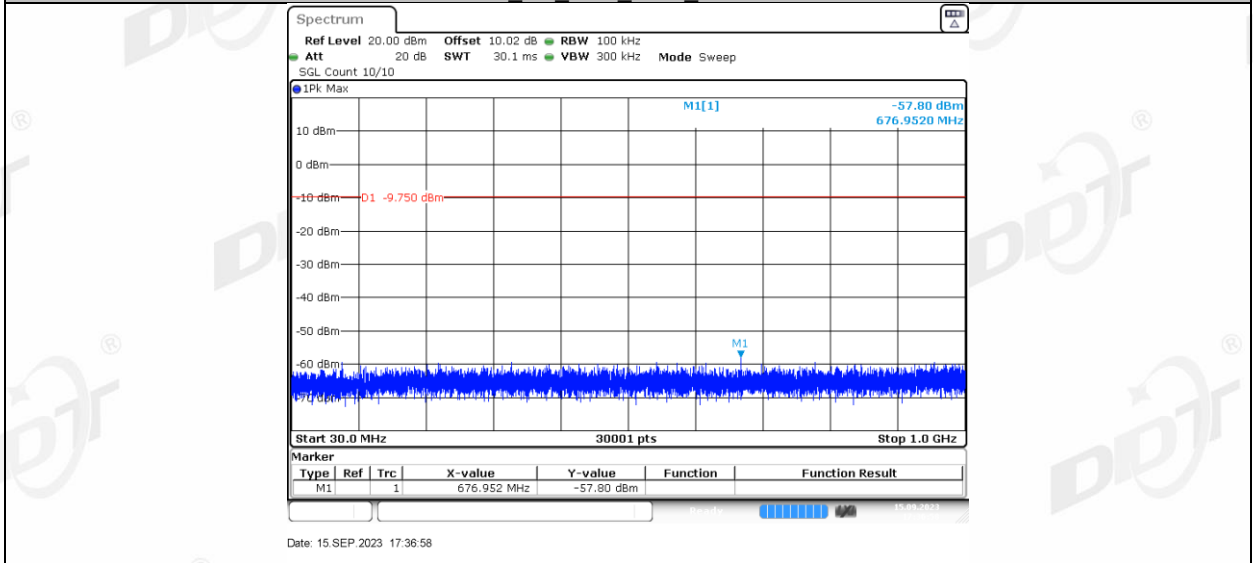

BLE_2M_Ant1_2404_1000~26500

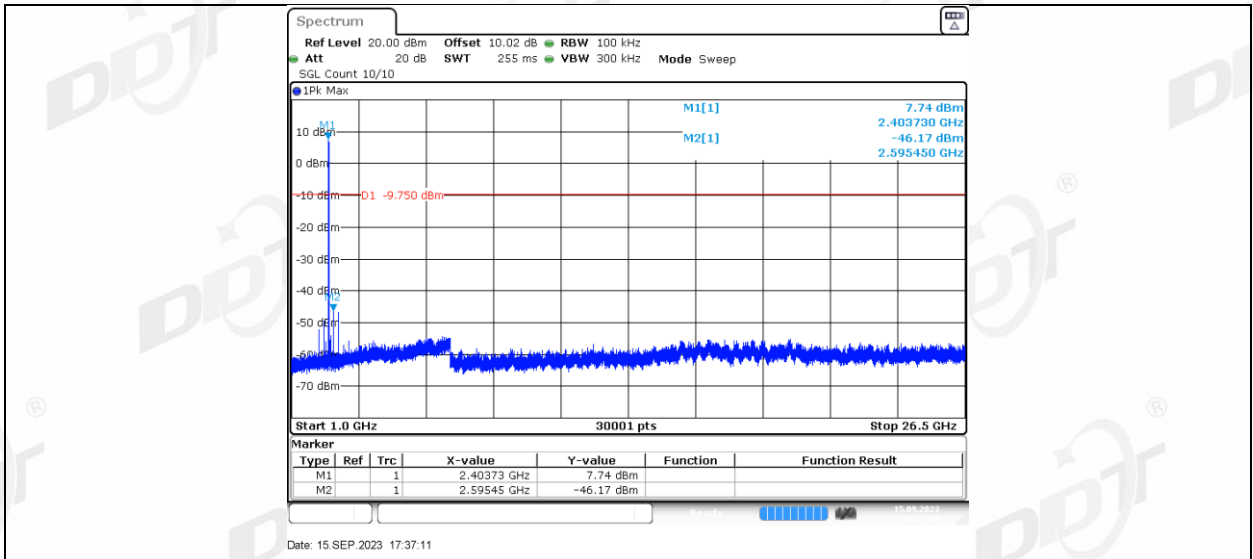

BLE_2M_Ant1_2440_0~Reference

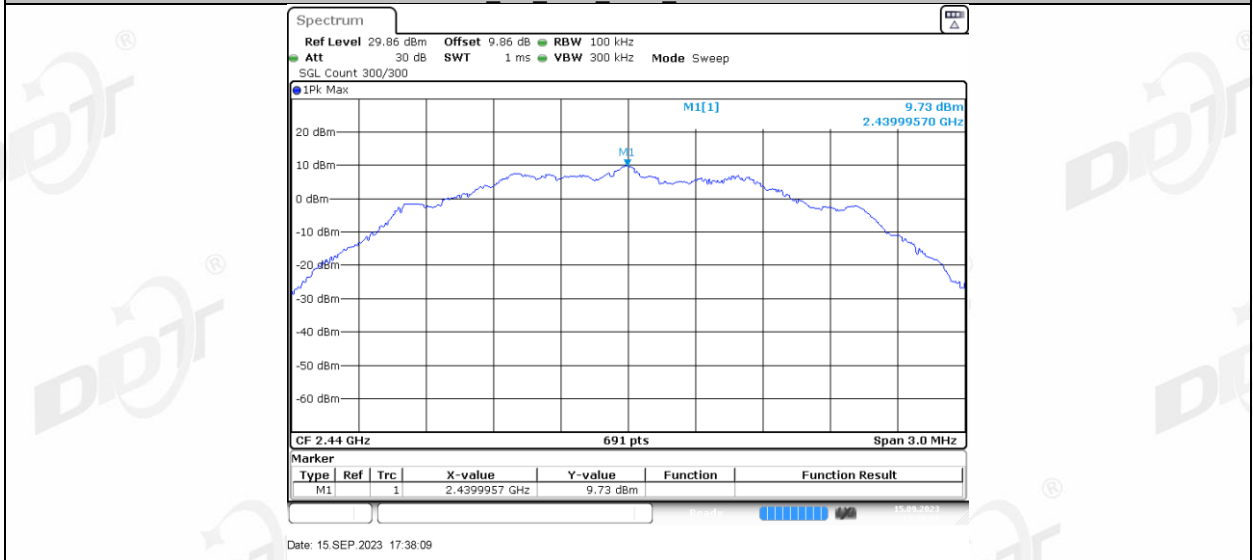

BLE_2M_Ant1_2440_30~1000

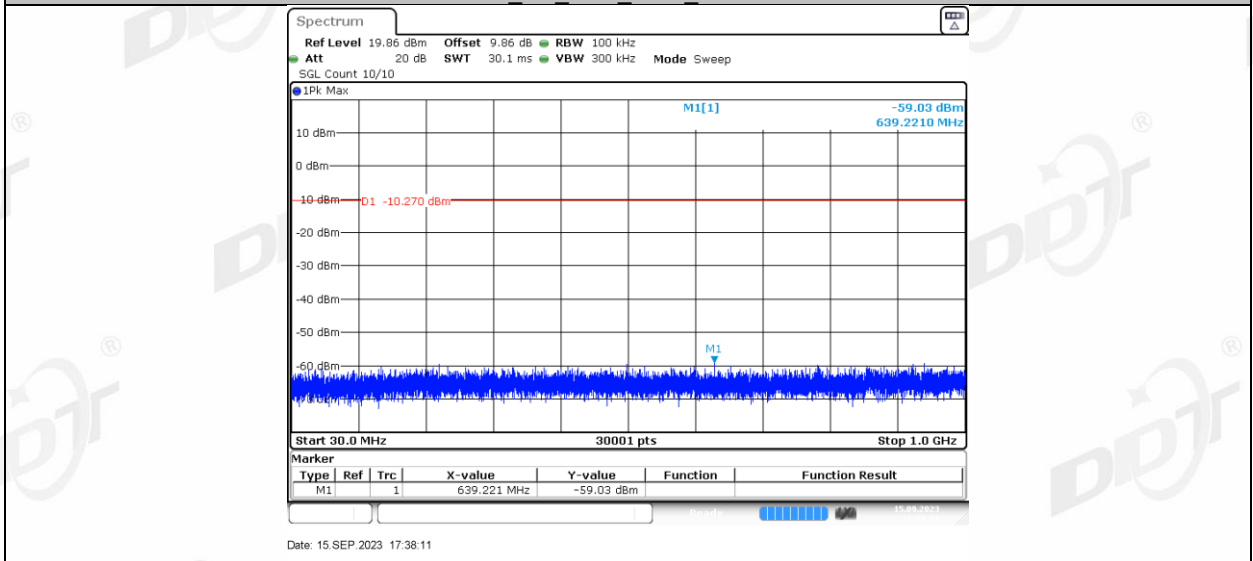

BLE_2M_Ant1_2440_1000~26500

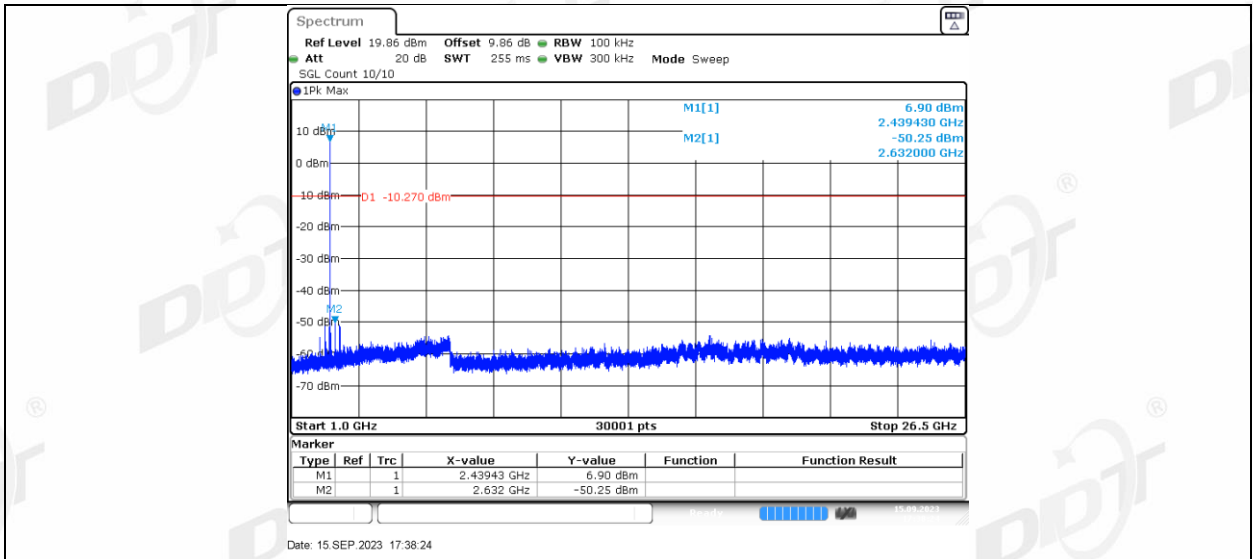

BLE_2M_Ant1_2478_0~Reference

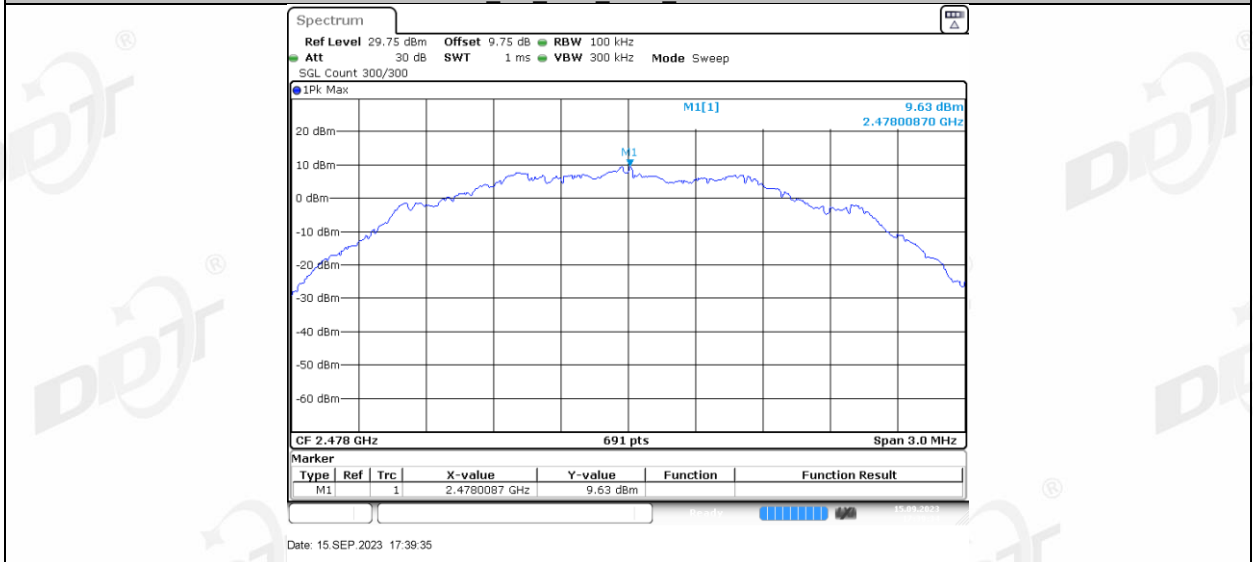

BLE_2M_Ant1_2478_30~1000

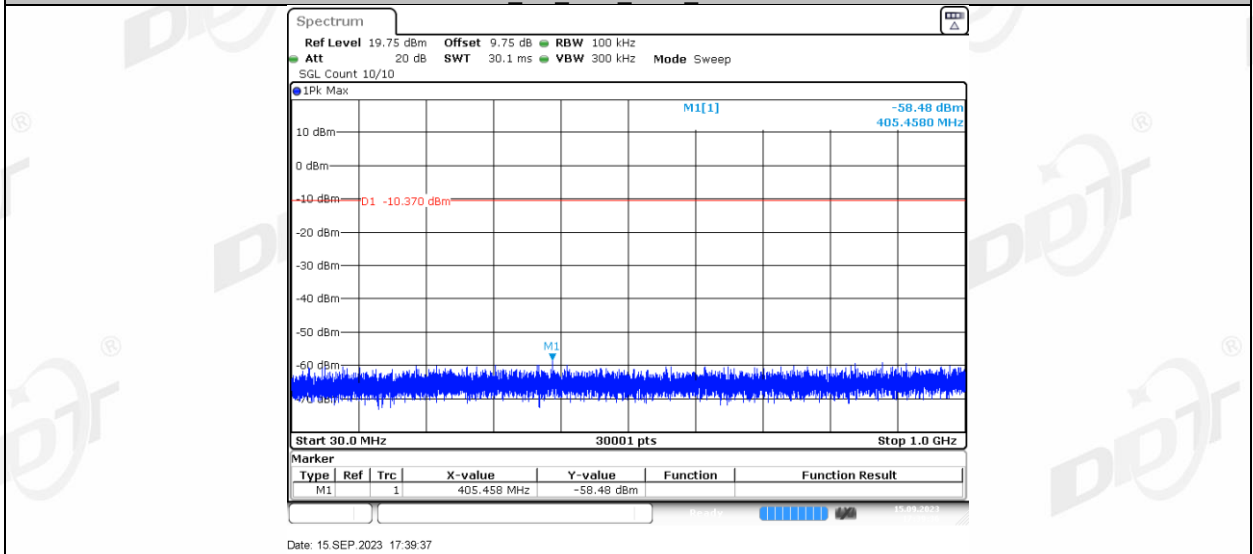

BLE_2M_Ant1_2478_1000~26500

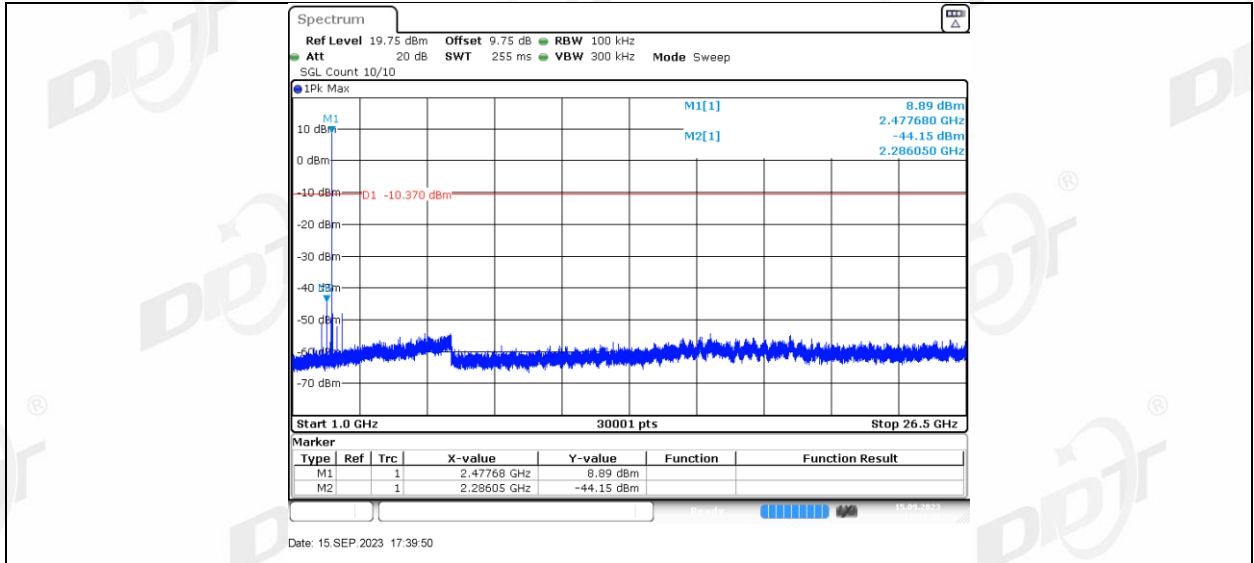

10. Duty Cycle

10.1. Block diagram of test setup

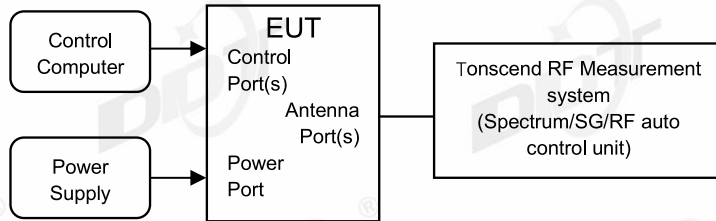

10.2. Limit

Just for Report.

10.3. Test procedure

- Connected the EUT’s antenna port to the Spectrum Analyzer by suitable attenuator, The cable loss and attenuator loss have been put into spectrum analyzer as amplitude offset.

set the Spectrum Analyzer as below:

Centre Frequency: The centre frequency of the middle hopping channel.

Resolution BW: 10 MHz.

Video BW: 10 MHz.

Span: Zero span.

Detector: Peak.

Trace Mode: Clear Write.

Sweep: Video Trigger

- When the trace is complete, measure the sending time of 1 burst and the duty cycle of 1 burst cycle.

- Calculate dwell time follow below formula:

$$\text{Duty cycle} = \text{Pulse's on time} / \text{Burst cycle}$$

10.4. Test result

Test Mode	Antenna	Frequency [MHz]	ON Time [ms]	Period [ms]	Duty Cycle [%]	Duty Cycle Factor[dB]
BLE_1M	Ant1	2402	0.39	0.63	61.90	2.08
		2440	0.39	0.63	61.90	2.08
		2480	0.39	0.63	61.90	2.08
BLE_2M	Ant1	2404	0.20	0.63	31.75	4.98
		2440	0.20	0.63	31.75	4.98
		2478	0.20	0.63	31.75	4.98

10.5. Test graphs

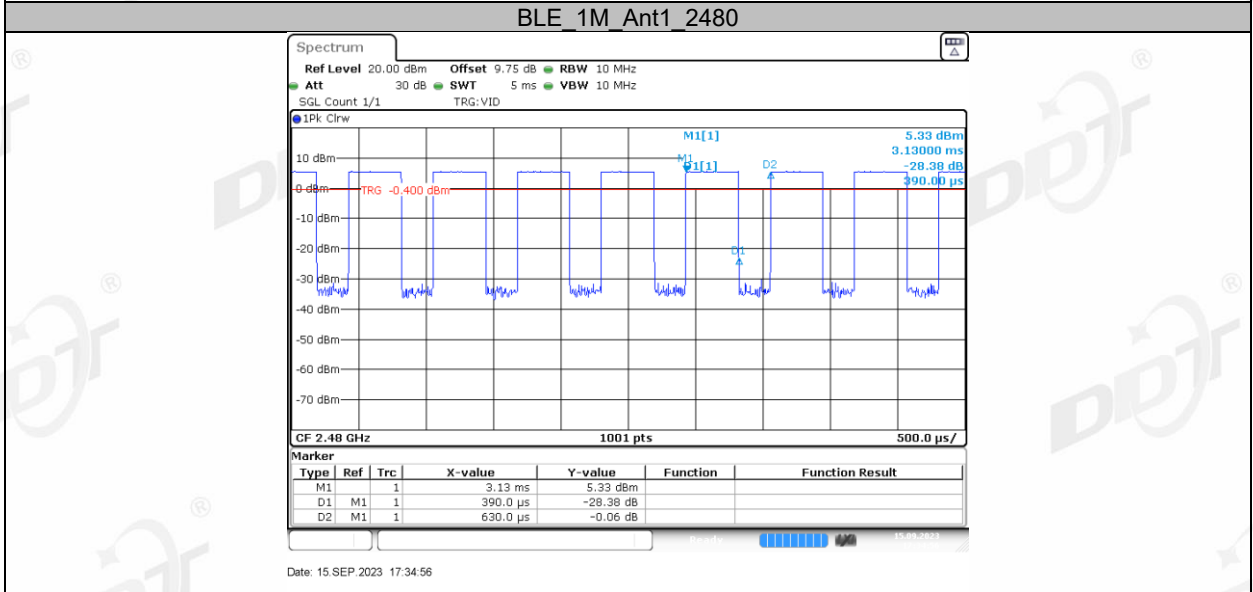
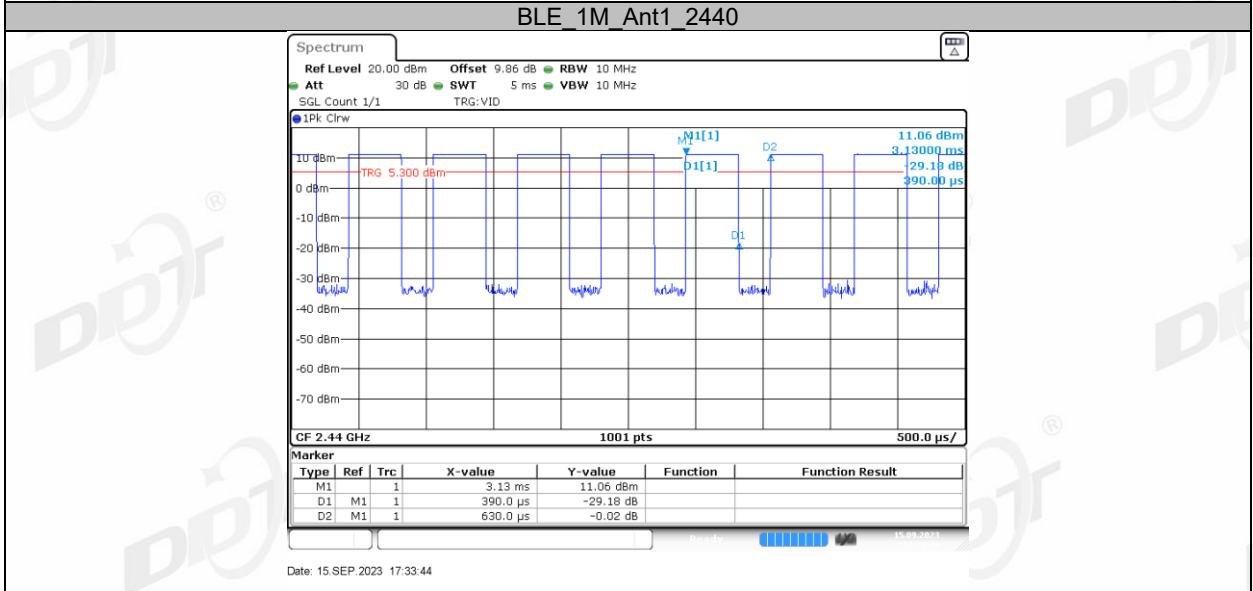
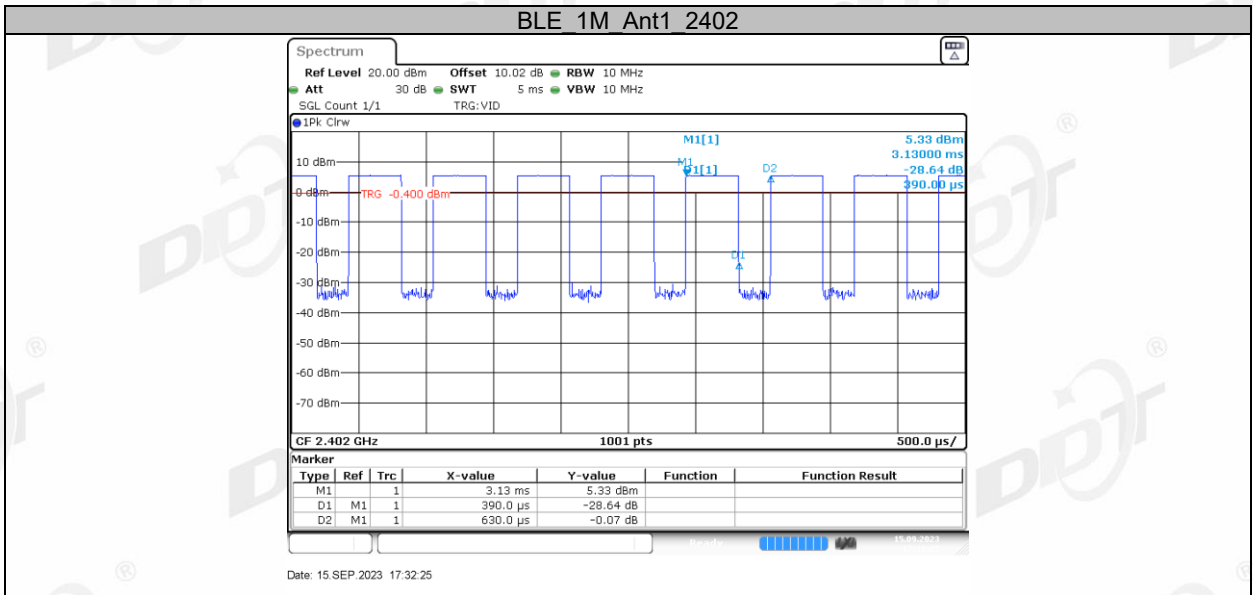

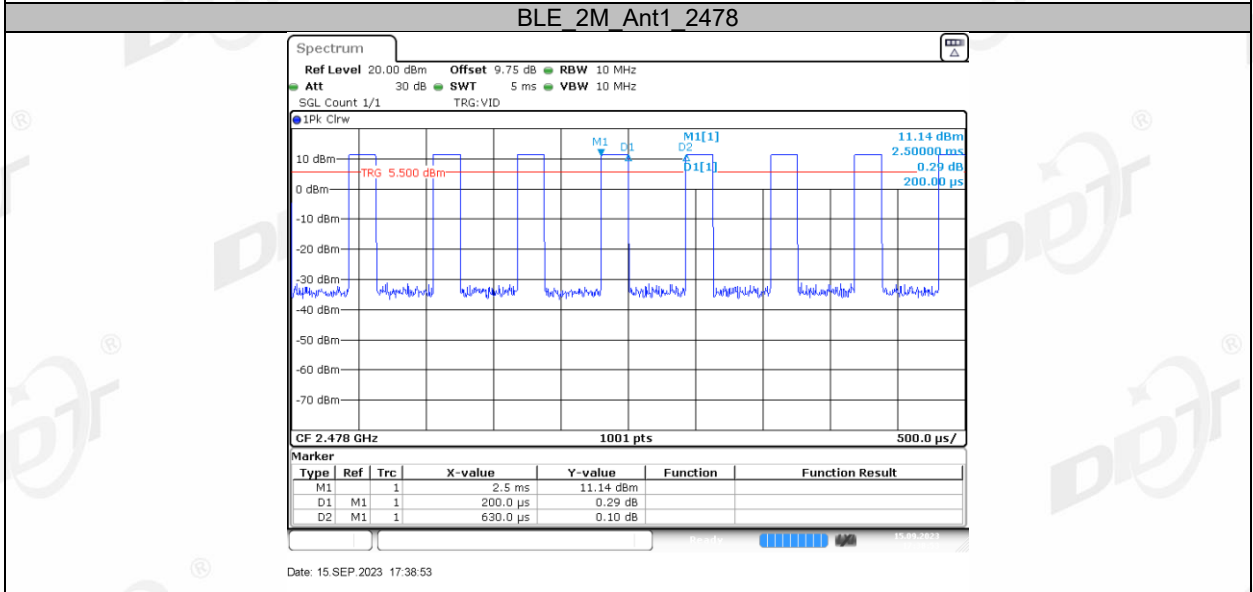
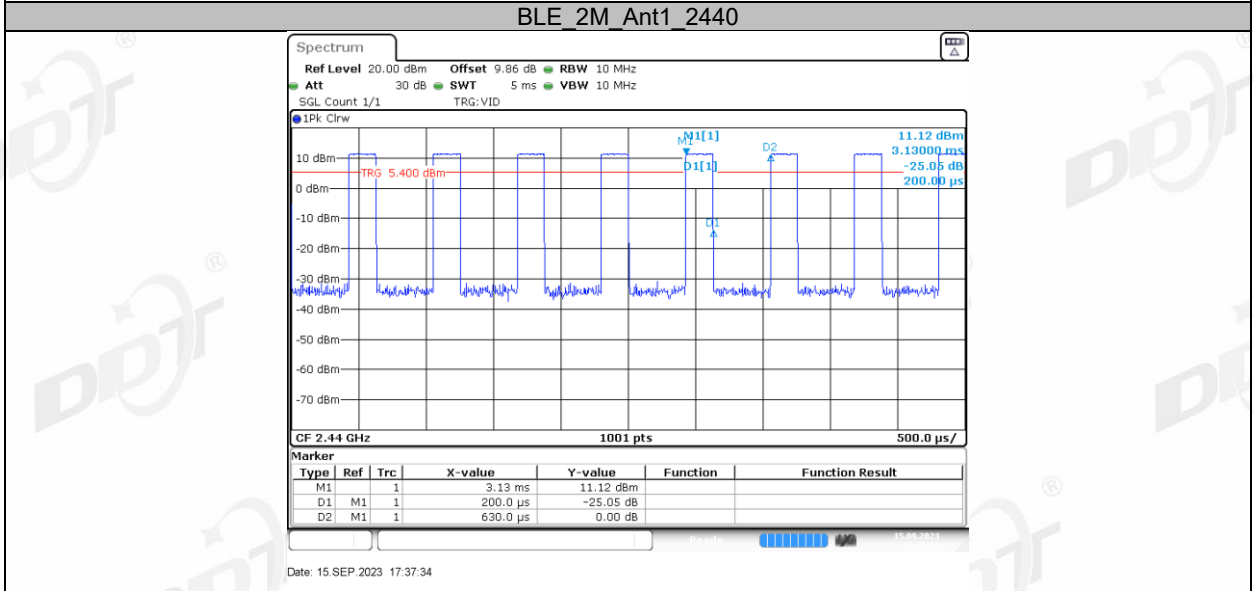
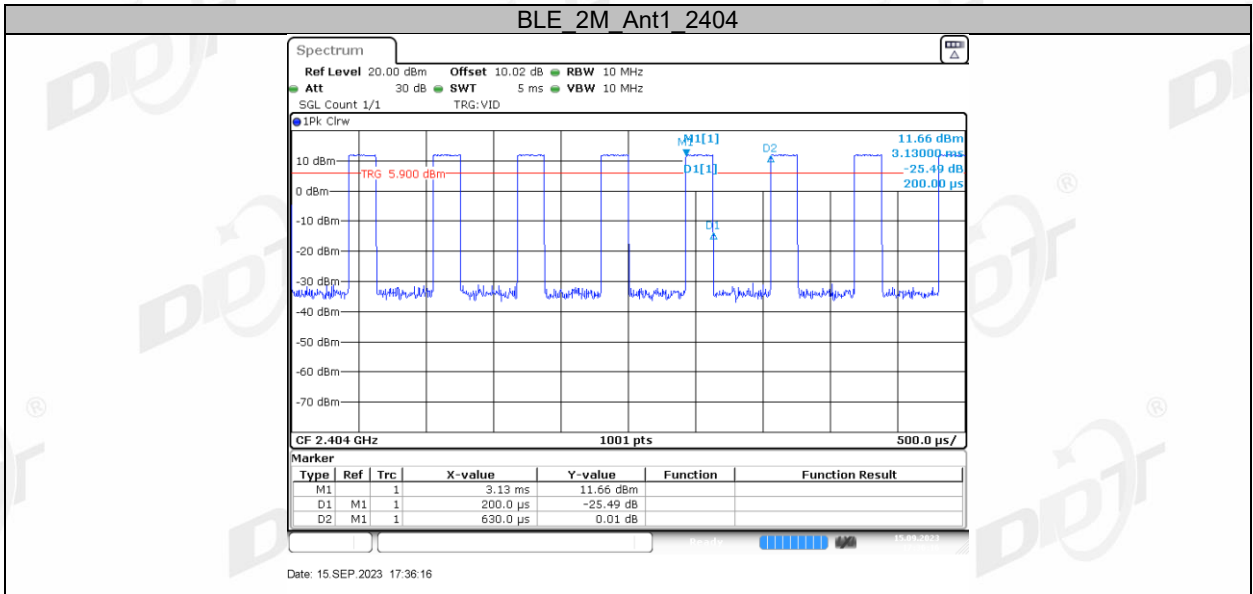

11. Radiated Emission

11.1. Test equipment

Equipment	Manufacturer	Model No.	Serial Number	Due Date
☑ Radiation 3# Chamber				
EMI TEST RECEIVER	R&S	ESU26	100472	2024/04/22
PSA Series Spectrum Analyzer	Agilent	E4447A	MY50180031	2024/04/22
Active Loop Antenna	Schwarzbeck	FMZB-1519	1519-038	2024/09/10
Trilog Broadband Antenna	Schwarzbeck	VULB 9163	01429	2024/07/11
Double Ridged Horn Antenna	Schwarzbeck	BBHA 9120 D	02468	2024/09/17
Broad Band Horn Antenna	Schwarzbeck	BBHA 9170	790	2024/04/25
Pre-amplifier	COM-POWER	PAM-118A	18040084	2024/07/14
Pre-amplifier	COM-POWER	PAM-840A	461369	2024/04/26
RE Cable	N/A	W23.02 CP1-X2 + W23.09 AP1-X8+ JCT26S-NJ-NJ-1.5M	4.5M+8M+1.5M	2024/04/20
RF Cable	Yuhu	JCTB810-NJ-NJ-9M+ ZT26S-SMAJ-SMAJ-1M	21123964	2024/04/22
Band Reject Filter (2400-2500 MHz)	REBES	BRM50702	G555	N/A
Test Software	Tonscend	JS32-RE	V 5.0.0.1	N/A

11.2. Block diagram of test setup

In 3 m Anechoic Chamber, test setup diagram for 9 kHz - 30 MHz:

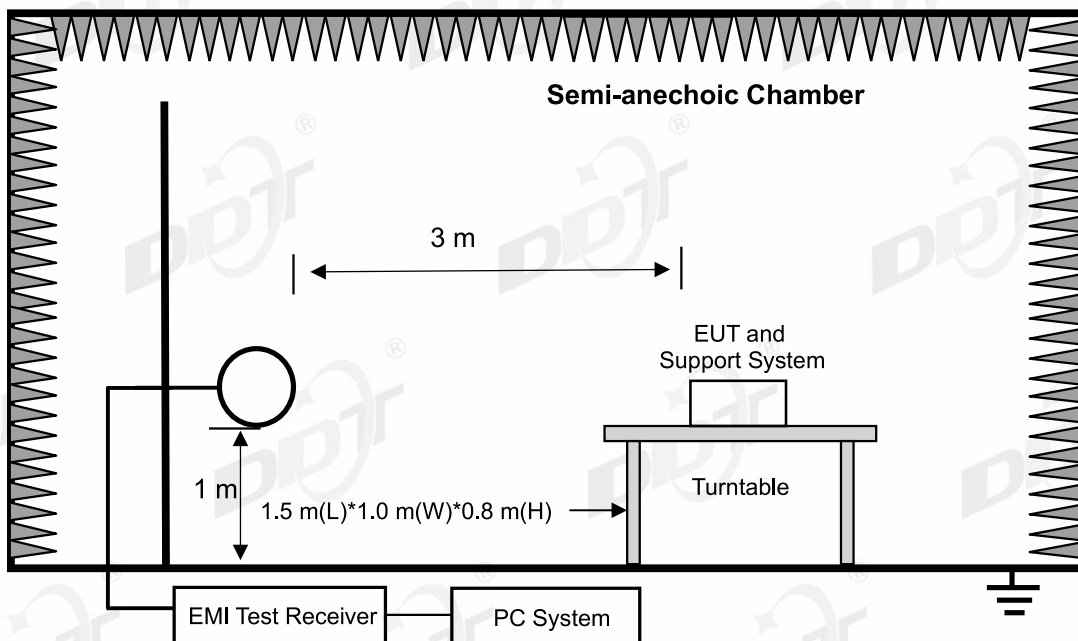

In 3 m Anechoic Chamber, test setup diagram for 30 MHz - 1 GHz:

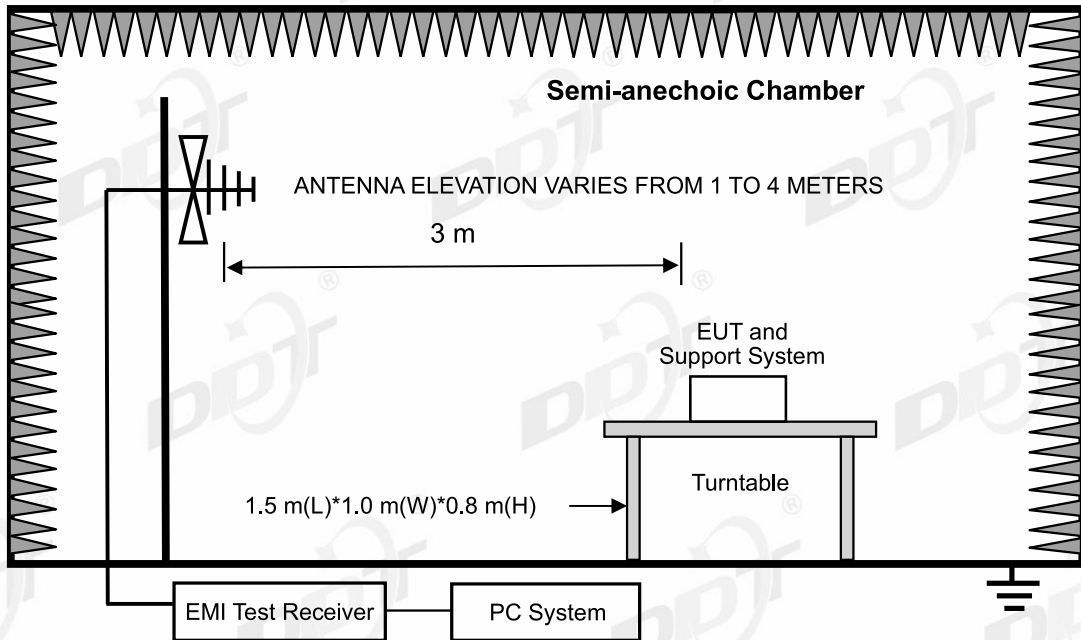

In 3 m Anechoic Chamber, test setup diagram for frequency above 1 GHz:

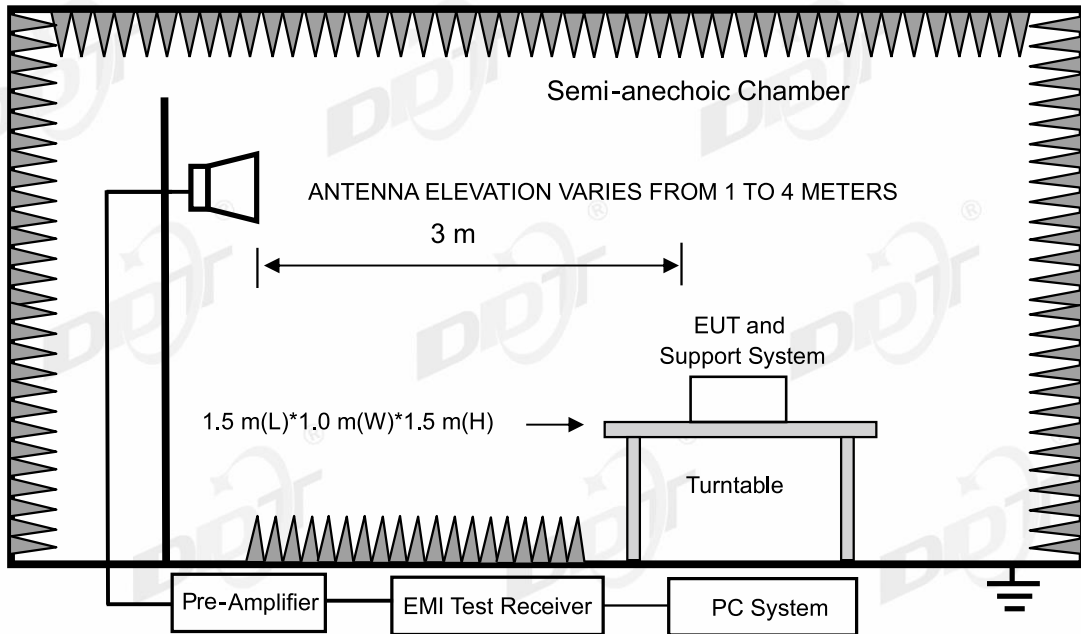

Note: Install an appropriate filter at the input of the measurement system power amplifier. This filter can attenuate the fundamental emission of the EUT and allow an accurate measurement of the associated harmonics and spurious emissions. The filter had been characterized, and the attenuation loss factors had been accounted for in the measurement results.

11.3. Limit

(1) FCC 15.205 Restricted frequency band

MHz	MHz	MHz	GHz
0.090-0.110	16.42-16.423	399.9-410	4.5-5.15
¹ 0.495-0.505	16.69475-16.69525	608-614	5.35-5.46
2.1735-2.1905	16.80425-16.80475	960-1240	7.25-7.75
4.125-4.128	25.5-25.67	1300-1427	8.025-8.5
4.1772&4.17775	37.5-38.25	1435-1626.5	9.0-9.2
4.2072&4.20775	73-74.6	1645.5-1646.5	9.3-9.5
6.215-6.218	74.8-75.2	1660-1710	10.6-12.7
6.26775-6.26825	108-121.94	1718.8-1722.2	13.25-13.4
6.31175-6.31225	123-138	2200-2300	14.47-14.5
8.291-8.294	149.9-150.05	2310-2390	15.35-16.2
8.362-8.366	156.52475-156.52525	2483.5-2500	17.7-21.4
8.37625-8.38675	156.7-156.9	2690-2900	22.01-23.12
8.41425-8.41475	162.0125-167.17	3260-3267	23.6-24.0
12.29-12.293	167.72-173.2	3332-3339	31.2-31.8
12.51975-12.52025	240-285	3345.8-3358	36.43-36.5
12.57675-12.57725	322-335.4	3600-4400	(²)
13.36-13.41			

¹Until February 1, 1999, this restricted band shall be 0.490-0.510 MHz.

²Above 38.6

RSS-Gen section 8.10 Restricted frequency bands*

MHz	MHz	MHz	GHz
0.090-0.110	12.51975-12.52025	240-285	3.5-4.4
0.495-0.505	12.57675-12.57725	322-335.4	4.5-5.15
2.1735-2.1905	13.36-13.41	399.9-410	5.35-5.46
3.020-3.026	16.42-16.423	608-614	7.25-7.75
4.125-4.128	16.69475-16.69525	960-1427	8.025-8.5
4.1772&4.17775	16.80425-16.80475	1435-1626.5	9.0-9.2
4.2072&4.20775	25.5-25.67	1645.5-1646.5	9.3-9.5
5.677-5.683	37.5-38.25	1660-1710	10.6-12.7
6.215-6.218	73-74.6	1718.8-1722.2	13.25-13.4
6.26775-6.26825	74.8-75.2	2200-2300	14.47-14.5
6.31175-6.31225	108-138	2310-2390	15.35-16.2
8.291-8.294	149.9-150.05	2483.5-2500	17.7-21.4
8.362-8.366	156.52475-156.52525	2655-2900	22.01-23.12
8.37625-8.38675	156.7-156.9	3260-3267	23.6-24.0

8.41425-8.41475	162.0125-167.17	3332-3339	31.2-31.8
12.29-12.293	167.72-173.2	3345.8-3358	36.43-36.5
			Above 38.6

* Certain frequency bands listed in table and in bands above 38.6 GHz are designated for licence-exempt applications. These frequency bands and the requirements that apply to related devices are set out in the 200 and 300 series of RSSs.

(2) FCC 15.209 Limit & RSS-Gen section 8.9 Limit

FREQUENCY MHz	DISTANCE Meters	FIELD STRENGTHS LIMIT	
		$\mu\text{V}/\text{m}$	$\text{dB}(\mu\text{V})/\text{m}$
0.009 ~ 0.490	300	2400/F(kHz)	67.6-20log(F)
0.490 ~ 1.705	30	24000/F(kHz)	87.6-20log(F)
1.705 ~ 30.0	30	30	29.54
30 ~ 88	3	100	40.0
88 ~ 216	3	150	43.5
216 ~ 960	3	200	46.0
960 ~ 1000	3	500	54.0
Above 1000	3	74.0 $\text{dB}(\mu\text{V})/\text{m}$ (Peak) 54.0 $\text{dB}(\mu\text{V})/\text{m}$ (Average)	

Note: (1) The emission limits shown in the above table are based on measurements employing a CISPR QP detector except for the frequency bands 9 - 90 kHz, 110 - 490 kHz and above 1000 MHz. Radiated emissions limits in these three bands are based on measurements employing an average detector.

(2) At frequencies below 30 MHz, measurement may be performed at a distance closer than that specified, and the limit at closer measurement distance can be extrapolated by below formula:

$$\text{Limit}_{3\text{m}}(\text{dB}\mu\text{V}/\text{m}) = \text{Limit}_{30\text{m}}(\text{dB}\mu\text{V}/\text{m}) + 40\text{Log}(30\text{m}/3\text{m})$$

(3) Limit for this EUT

The emissions appearing within 15.205 restricted frequency bands shall not exceed the limits shown in 15.209, and the emissions appearing within RSS-Gen section 8.10 Restricted frequency bands shall not exceed the limits shown in RSS-Gen section 8.9, all the other emissions shall be at least 20 dB below the fundamental emissions or comply with 15.209 limits and RSS-Gen section 8.9 limits.

11.4. Test Procedure

(1) EUT was placed on a non-metallic table, 80 cm above the ground plane inside a semi-anechoic chamber for below 1 G and 150 cm above the ground plane inside a semi-anechoic chamber for above 1 G.

(2) Test antenna was located 3 m from the EUT on an adjustable mast, and the antenna used as below table.

Test frequency range	Test antenna used	Test antenna distance
9 kHz - 30 MHz	Active Loop antenna	3 m
30 MHz - 1 GHz	Trilog Broadband Antenna	3 m
1 GHz - 18 GHz	Double Ridged Horn Antenna (1 GHz - 18 GHz)	3 m
18 GHz - 40 GHz	Horn Antenna (18 GHz - 40 GHz)	1 m

According to ANSI C63.10:2013 clause 6.4.6 and 6.5.3, for measurements below 30 MHz, the antenna was located 3 m from EUT, the loop antenna was positioned in three antenna orientations (parallel, perpendicular, and round-parallel), for each measurement antenna alignment, the EUT shall be rotated through 0° to 360° on a turntable, and the lowest height of the magnetic antenna shall be 1 m above the ground. For measurement above 30 MHz, the Trilog Broadband Antenna or Horn Antenna was located 3 m from EUT, measurements were made with the antenna positioned in both the horizontal and vertical planes of polarization, and the measurement antenna was varied from 1 m to 4 m in height above the reference ground plane to obtain the maximum signal strength.

(3) Below pre-scan procedure was first performed in order to find prominent frequency spectrum radiated emissions from 9 kHz to 25 GHz:

(a) Scanning the peak frequency spectrum with the antenna specified in step (3), and the EUT was rotated 360 degrees, the antenna height was varied from 1 m to 4 m (Except loop antenna, it's fixed 1 m above ground.)

(b) Change work frequency or channel of device if practicable.

(c) Change modulation type of device if practicable.

(d) Change power supply range from 85% to 115% of the rated supply voltage

(e) Rotated EUT through three orthogonal axes to determine the attitude of EUT arrangement produces highest emissions.

Spectrum frequency from 9 kHz to 25 GHz (tenth harmonic of fundamental frequency) was investigated, and no any obvious emission were detected from 9 kHz to 30 MHz and 18 GHz to 25 GHz, so below final test was performed with frequency range from 30 MHz to 18 GHz.

(4) For final emissions measurements at each frequency of interest, the EUT was rotated and the antenna height was varied between 1 m and 4 m in order to maximize the emission. Measurements in both horizontal and vertical polarities were made and the data was recorded. In order to find the maximum emission, the relative positions of equipments and all of the interface cables were changed according to ANSI C63.10:2013 on Radiated Emission test.

(5) The emissions from 9 kHz to 1 GHz were measured based on CISPR QP detector except for the frequency bands 9 - 90 kHz, 110 - 490 kHz, for emissions from 9 kHz - 90 kHz, 110 kHz - 490 kHz and above 1 GHz were measured based on average detector, for emissions above 1 GHz, peak emissions also be measured and need comply with Peak limit.

(6) The emissions from 9 kHz to 1 GHz, QP or average values were measured with EMI receiver with below RBW

Frequency band	RBW
9 kHz - 150 kHz	200 Hz
150 kHz - 30 MHz	9 kHz
30 MHz - 1 GHz	120 kHz

For emissions above 1 GHz, both Peak and Average level were measured with Spectrum Analyzer, and the RBW is set at 1 MHz, VBW is set at 3 MHz for Peak measure; According ANSI C63.10:2013 clause 4.1.4.2.2 procedure for average measure.

11.5. Test result

Pass. (See below detailed test result)

All the emissions except fundamental emission from 9 kHz to 25 GHz were comply with 15.209 limits and RSS-Gen section 8.9 limits.

Note1: According exploratory test, the emission levels are 20 dB below the limit detected from 9 kHz to 30 MHz and 18 GHz to 25 GHz, so the final test was performed with frequency range from 30 MHz to 18 GHz and recorded in below.

Note2: For emissions below 1 GHz, according exploratory explorer test, when change Tx mode and channel, have no distinct influence on emissions level, so for emissions below 1 GHz, the final test was only performed with EUT working in GFSK 2M Tx 2404 MHz mode.

Note3: For emissions above 1 GHz. If peak results comply with AV limit, AV Result is deemed to comply with AV limit.

Radiated Emission Test Result (below 1 GHz)

TR-4-E-009 Radiated Emission Test Result

Test Date: 2023-09-15 **Tested By:** Bairong
EUT: Portable Bluetooth Speaker **Model Number:** XTREME 4G
Test Mode: Tx mode **Power Supply:** AC 120V/60Hz
Condition: Temp:22.6°C;Humi:61.7% **Test Site:** DDT 3# Chamber
File Path: d:\ts\2023 report data\Q23090419-2E\FCC BELOW 1G\20230915-004850_H
Memo: Sample Number: S23090419-25

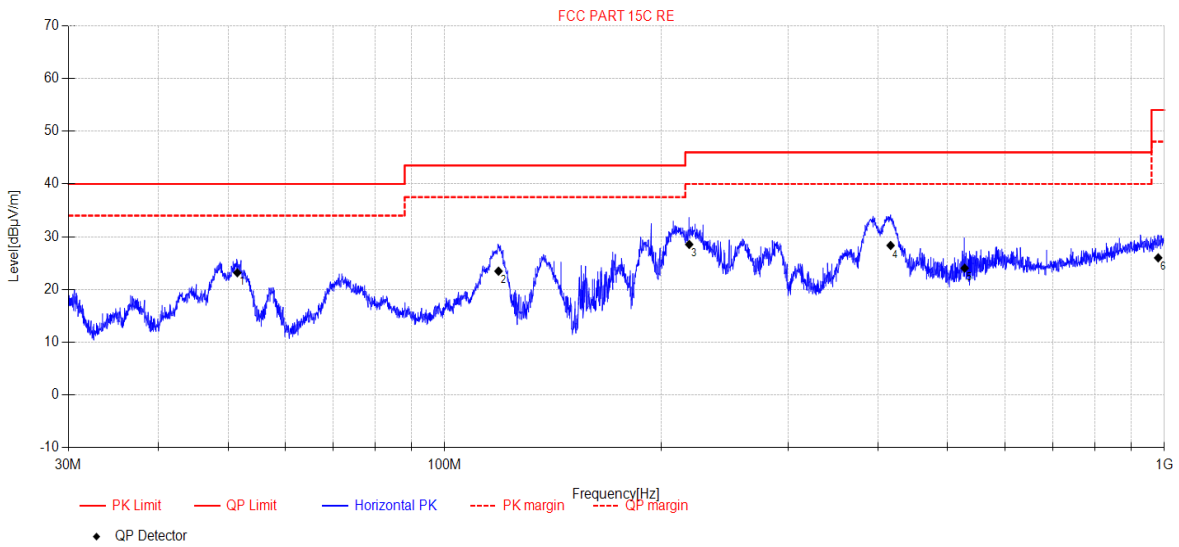

Final Data List										
NO.	Freq. [MHz]	Reading [dBµV/m]	Antenna Factor [dB]	Cable Loss [dB]	AMP [dB]	Result [dBµV/m]	Limit [dBµV/m]	Margin [dB]	Detector	Polarity
1	51.51	36.08	13.05	4.73	-30.69	23.17	40.00	16.83	QP	Horizontal
2	118.82	40.21	8.94	5.16	-30.84	23.47	43.50	20.03	QP	Horizontal
3	218.68	42.12	11.15	5.81	-30.54	28.54	46.00	17.46	QP	Horizontal
4	416.54	36.04	15.63	6.74	-30.07	28.34	46.00	17.66	QP	Horizontal
5	527.94	29.5	17.40	7.04	-29.90	24.04	46.00	21.96	QP	Horizontal
6	980.56	22.75	22.90	8.62	-28.27	26.00	54.00	28.00	QP	Horizontal

Note:

1. Result Level = Reading + Cable loss + Antenna Factor + AMP
2. If Peak Result complies with QP limit, QP Result is deemed to comply with QP limit.
3. Test setup: RBW: 120 kHz, VBW: 300 kHz, Sweep time: auto.

TR-4-E-009 Radiated Emission Test Result

Test Date: 2023-09-15 **Tested By:** Bairong
EUT: Portable Bluetooth Speaker **Model Number:** XTREME 4G
Test Mode: Tx mode **Power Supply:** AC 120V/60Hz
Condition: Temp:22.6°C;Humi:61.7% **Test Site:** DDT 3# Chamber
File Path: d:\ts\2023 report data\Q23090419-2E\FCC BELOW 1G\20230915-004933_V
Memo: Sample Number: S23090419-25

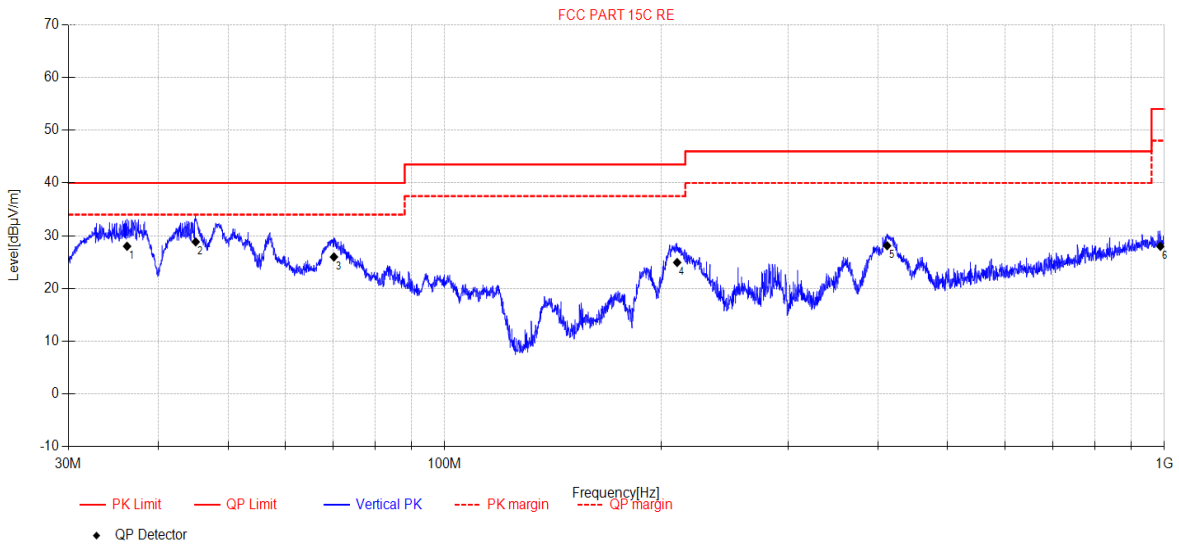

Final Data List										
NO.	Freq. [MHz]	Reading [dBµV/m]	Antenna Factor [dB]	Cable Loss [dB]	AMP [dB]	Result [dBµV/m]	Limit [dBµV/m]	Margin [dB]	Detector	Polarity
1	36.20	43.1	11.26	4.55	-30.91	28.00	40.00	12.00	QP	Vertical
2	45.09	41.92	13.01	4.67	-30.77	28.83	40.00	11.17	QP	Vertical
3	70.18	43.31	8.45	4.79	-30.57	25.98	40.00	14.02	QP	Vertical
4	210.41	38.82	10.91	5.77	-30.57	24.93	43.50	18.57	QP	Vertical
5	411.90	35.86	15.60	6.73	-30.08	28.11	46.00	17.89	QP	Vertical
6	987.46	24.61	22.95	8.65	-28.21	28.00	54.00	26.00	QP	Vertical

Note:

1. Result Level = Reading + Cable loss + Antenna Factor + AMP
2. If Peak Result complies with QP limit, QP Result is deemed to comply with QP limit.
3. Test setup: RBW: 120 kHz, VBW: 300 kHz, Sweep time: auto.

Radiated Emission Test Result (above 1 GHz)

TR-4-E-009 Radiated Emission Test Result

Test Date: 2023-09-14 **Tested By:** Bairong
EUT: Portable Bluetooth Speaker **Model Number:** XTREME 4G
Test Mode: BLE 1M TX 2402MHz **Power Supply:** AC 120V/60Hz
Condition: Temp:21.6°C;Humi:60.7% **Test Site:** DDT 3# Chamber
File Path: d:\ts\2023 report data\Q23090419-2E\FCC ABOVE 1G\27
Memo: Sample Number: S23090419-25

Test Graph

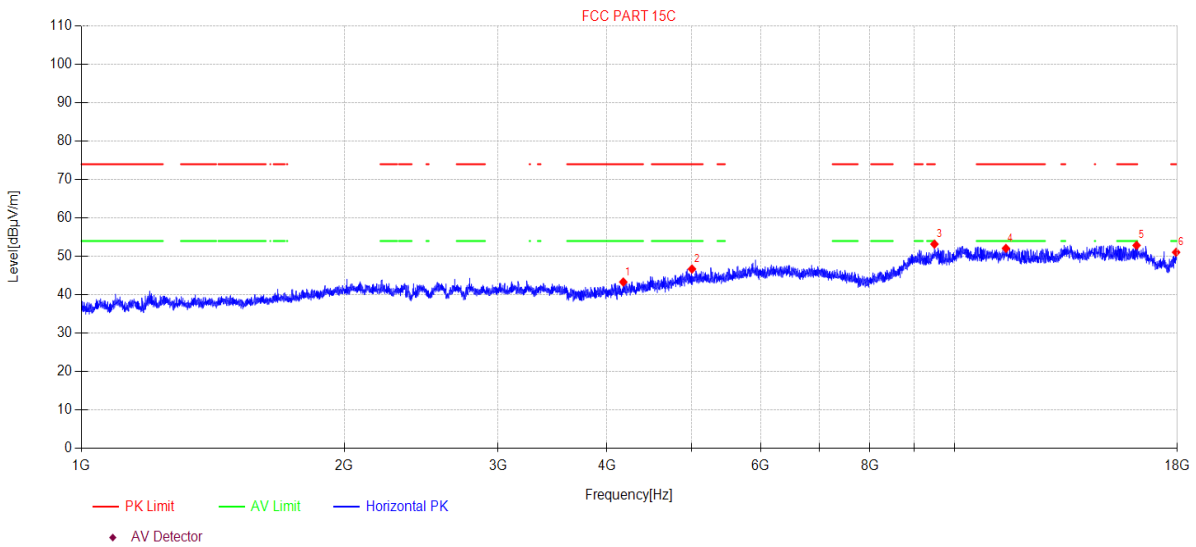

Suspected Data List										
N O.	Freq. [MHz]	Reading [dBµV/m]	Cable loss [dB]	Antenna Factor [dB]	AMP [dB]	Level [dBµV/m]	Limit [dBµV/m]	Margin [dB]	Detector	Polarity
1	4175.13	46.47	6.20	31.05	-40.39	43.33	74.00	30.67	PK	Horizontal
2	5004.58	46.11	7.88	32.81	-40.08	46.72	74.00	27.28	PK	Horizontal
3	9487.07	44.72	8.83	38.40	-38.76	53.19	74.00	20.81	PK	Horizontal
4	11454.27	42.28	10.05	39.05	-39.30	52.08	74.00	21.92	PK	Horizontal
5	16165.20	39.39	15.23	37.73	-39.49	52.86	74.00	21.14	PK	Horizontal
6	17942.87	38.82	13.06	41.46	-42.27	51.07	74.00	22.93	PK	Horizontal

Note:

1. Level = Reading + Cable loss + Antenna Factor + AMP
2. If Peak Result complies with AV limit, AV Result is deemed to comply with AV limit.
3. Test setup: RBW: 1 MHz, VBW: 3 MHz, Sweep time: auto.

TR-4-E-009 Radiated Emission Test Result

Test Date: 2023-09-14 **Tested By:** Bairong
EUT: Portable Bluetooth Speaker **Model Number:** XTREME 4G
Test Mode: BLE 1M TX 2402MHz **Power Supply:** AC 120V/60Hz
Condition: Temp:21.6°C;Humi:60.7% **Test Site:** DDT 3# Chamber
File Path: d:\ts\2023 report data\Q23090419-2E\FCC ABOVE 1G\28
Memo: Sample Number: S23090419-25

Test Graph

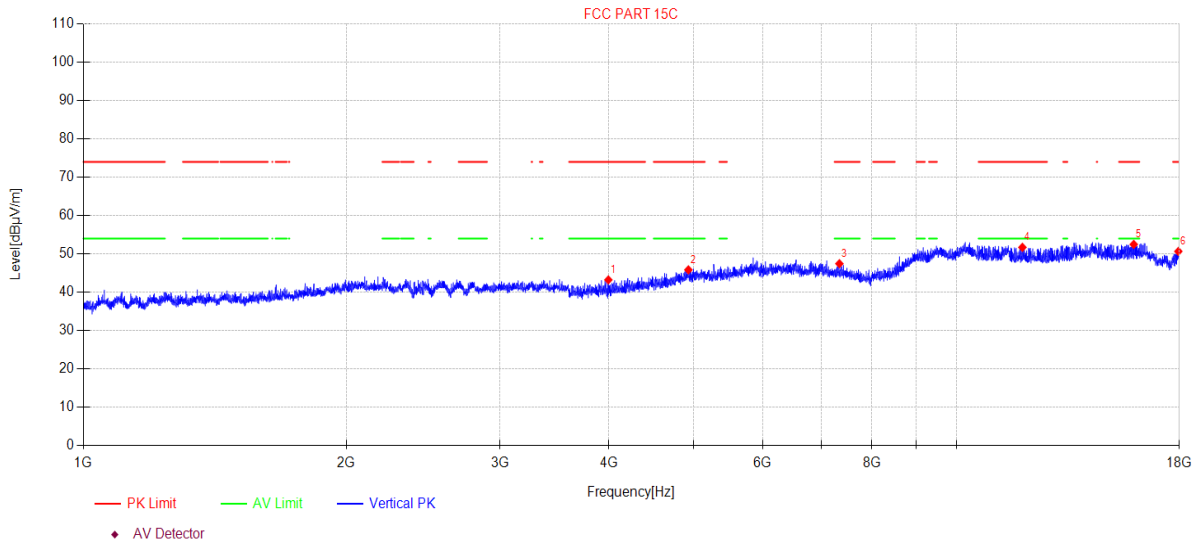

Suspected Data List										
N O.	Freq. [MHz]	Reading [dBµV/m]	Cable loss [dB]	Antenna Factor [dB]	AMP [dB]	Level [dBµV/m]	Limit [dBµV/m]	Margin [dB]	Detector	Polarity
1	3993.38	47.14	5.85	30.69	-40.45	43.23	74.00	30.77	PK	Vertical
2	4931.36	45.50	7.73	32.73	-40.11	45.85	74.00	28.15	PK	Vertical
3	7343.89	44.88	7.63	36.50	-41.56	47.45	74.00	26.55	PK	Vertical
4	11899.68	41.97	10.45	38.80	-39.51	51.71	74.00	22.29	PK	Vertical
5	15960.94	38.14	15.70	37.98	-39.34	52.48	74.00	21.52	PK	Vertical
6	17953.24	38.37	13.07	41.52	-42.30	50.66	74.00	23.34	PK	Vertical

Note:

1. Level = Reading + Cable loss + Antenna Factor + AMP
2. If Peak Result complies with AV limit, AV Result is deemed to comply with AV limit.
3. Test setup: RBW: 1 MHz, VBW: 3 MHz, Sweep time: auto.

TR-4-E-009 Radiated Emission Test Result

Test Date: 2023-09-14 **Tested By:** Bairong
EUT: Portable Bluetooth Speaker **Model Number:** XTREME 4G
Test Mode: BLE 1M TX 2440MHz **Power Supply:** AC 120V/60Hz
Condition: Temp:21.6°C;Humi:60.7% **Test Site:** DDT 3# Chamber
File Path: d:\ts\2023 report data\Q23090419-2E\FCC ABOVE 1G\29
Memo: Sample Number: S23090419-25

Test Graph

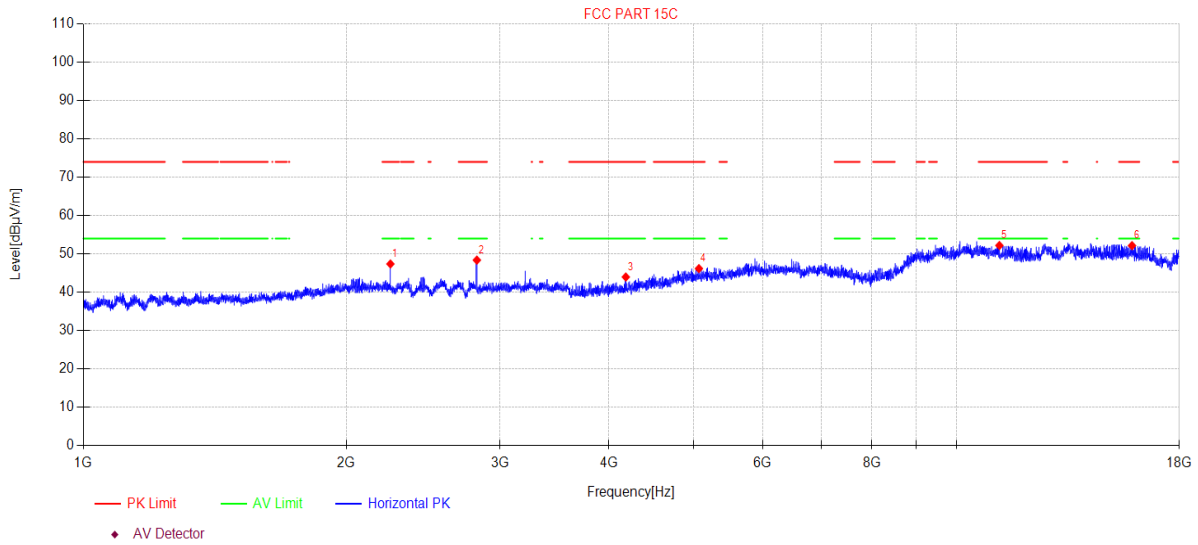

Suspected Data List										
N O.	Freq. [MHz]	Reading [dBµV/m]	Cable loss [dB]	Antenna Factor [dB]	AMP [dB]	Level [dBµV/m]	Limit [dBµV/m]	Margin [dB]	Detector	Polarity
1	2247.46	51.85	5.96	27.29	-37.71	47.39	74.00	26.61	PK	Horizontal
2	2823.08	53.43	5.71	28.59	-39.34	48.39	74.00	25.61	PK	Horizontal
3	4181.17	47.08	6.22	31.06	-40.38	43.98	74.00	30.02	PK	Horizontal
4	5070.09	45.38	7.97	32.90	-40.07	46.18	74.00	27.82	PK	Horizontal
5	11198.95	42.45	9.83	39.10	-39.18	52.20	74.00	21.80	PK	Horizontal
6	15887.30	37.97	15.37	38.11	-39.29	52.16	74.00	21.84	PK	Horizontal

Note:

1. Level = Reading + Cable loss + Antenna Factor + AMP
2. If Peak Result complies with AV limit, AV Result is deemed to comply with AV limit.
3. Test setup: RBW: 1 MHz, VBW: 3 MHz, Sweep time: auto.

TR-4-E-009 Radiated Emission Test Result

Test Date: 2023-09-14 **Tested By:** Bairong
EUT: Portable Bluetooth Speaker **Model Number:** XTREME 4G
Test Mode: BLE 1M TX 2440MHz **Power Supply:** AC 120V/60Hz
Condition: Temp:21.6°C;Humi:60.7% **Test Site:** DDT 3# Chamber
File Path: d:\ts\2023 report data\Q23090419-2E\FCC ABOVE 1G\30
Memo: Sample Number: S23090419-25

Test Graph

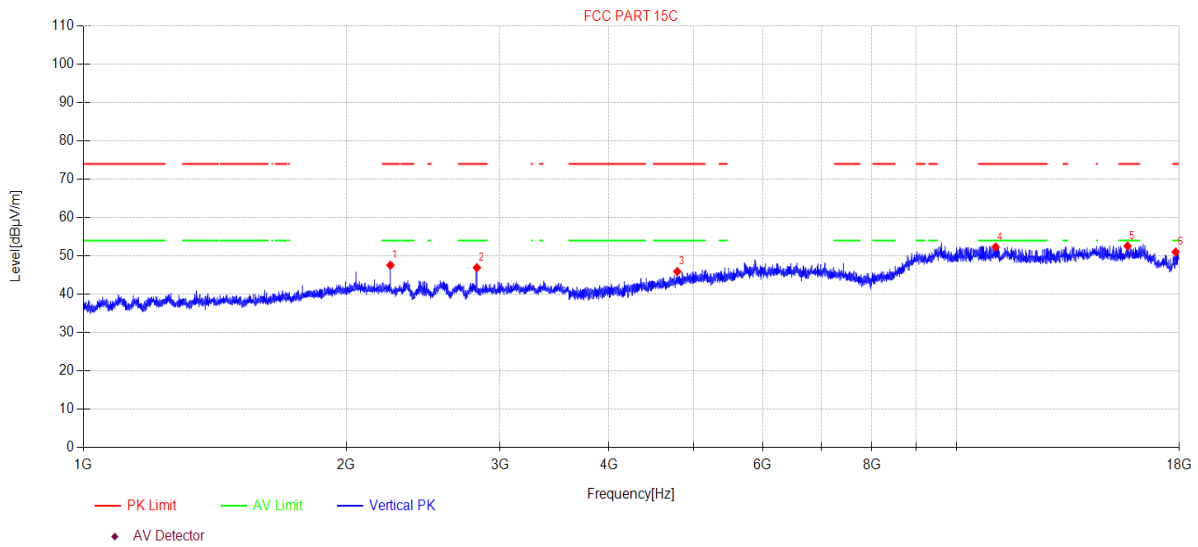

Suspected Data List										
N O.	Freq. [MHz]	Reading [dBµV/m]	Cable loss [dB]	Antenna Factor [dB]	AMP [dB]	Level [dBµV/m]	Limit [dBµV/m]	Margin [dB]	Detector	Polarity
1	2247.46	52.03	5.96	27.29	-37.71	47.57	74.00	26.43	PK	Vertical
2	2823.08	51.97	5.71	28.59	-39.34	46.93	74.00	27.07	PK	Vertical
3	4788.11	46.39	7.44	32.25	-40.16	45.92	74.00	28.08	PK	Vertical
4	11089.45	42.63	9.73	39.10	-39.13	52.33	74.00	21.67	PK	Vertical
5	15704.70	38.91	14.54	38.30	-39.18	52.57	74.00	21.43	PK	Vertical
6	17829.15	39.40	12.92	40.70	-42.02	51.00	74.00	23.00	PK	Vertical

Note:

1. Level = Reading + Cable loss + Antenna Factor + AMP
2. If Peak Result complies with AV limit, AV Result is deemed to comply with AV limit.
3. Test setup: RBW: 1 MHz, VBW: 3 MHz, Sweep time: auto.

TR-4-E-009 Radiated Emission Test Result

Test Date: 2023-09-14 **Tested By:** Bairong
EUT: Portable Bluetooth Speaker **Model Number:** XTREME 4G
Test Mode: BLE 1M TX 2480MHz **Power Supply:** AC 120V/60Hz
Condition: Temp:21.6°C;Humi:60.7% **Test Site:** DDT 3# Chamber
File Path: d:\ts\2023 report data\Q23090419-2E\FCC ABOVE 1G\31
Memo: Sample Number: S23090419-25

Test Graph

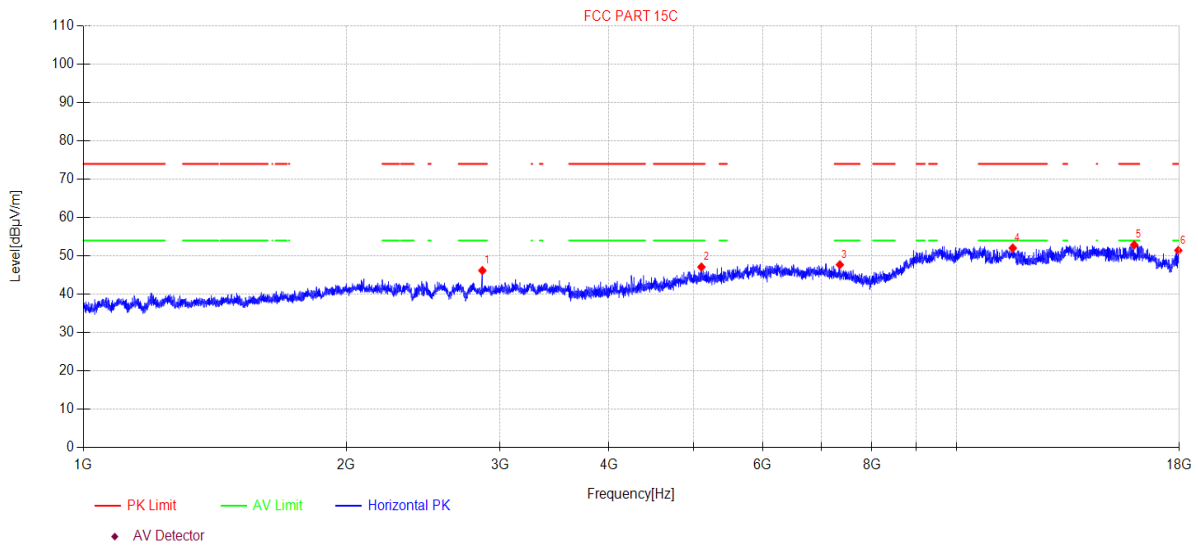

Suspected Data List										
N O.	Freq. [MHz]	Reading [dBµV/m]	Cable loss [dB]	Antenna Factor [dB]	AMP [dB]	Level [dBµV/m]	Limit [dBµV/m]	Margin [dB]	Detector	Polarity
1	2864.17	51.20	5.69	28.76	-39.46	46.19	74.00	27.81	PK	Horizontal
2	5103.91	46.26	8.02	32.90	-40.07	47.11	74.00	26.89	PK	Horizontal
3	7352.38	45.16	7.63	36.50	-41.58	47.71	74.00	26.29	PK	Horizontal
4	11600.86	42.34	10.18	38.90	-39.37	52.05	74.00	21.95	PK	Horizontal
5	15979.40	38.50	15.79	37.94	-39.35	52.88	74.00	21.12	PK	Horizontal
6	17953.24	39.14	13.07	41.52	-42.30	51.43	74.00	22.57	PK	Horizontal

Note:

1. Level = Reading + Cable loss + Antenna Factor + AMP
2. If Peak Result complies with AV limit, AV Result is deemed to comply with AV limit.
3. Test setup: RBW: 1 MHz, VBW: 3 MHz, Sweep time: auto.

TR-4-E-009 Radiated Emission Test Result

Test Date: 2023-09-14 **Tested By:** Bairong
EUT: Portable Bluetooth Speaker **Model Number:** XTREME 4G
Test Mode: BLE 1M TX 2480MHz **Power Supply:** AC 120V/60Hz
Condition: Temp:21.6°C;Humi:60.7% **Test Site:** DDT 3# Chamber
File Path: d:\ts\2023 report data\Q23090419-2E\FCC ABOVE 1G\32
Memo: Sample Number: S23090419-25

Test Graph

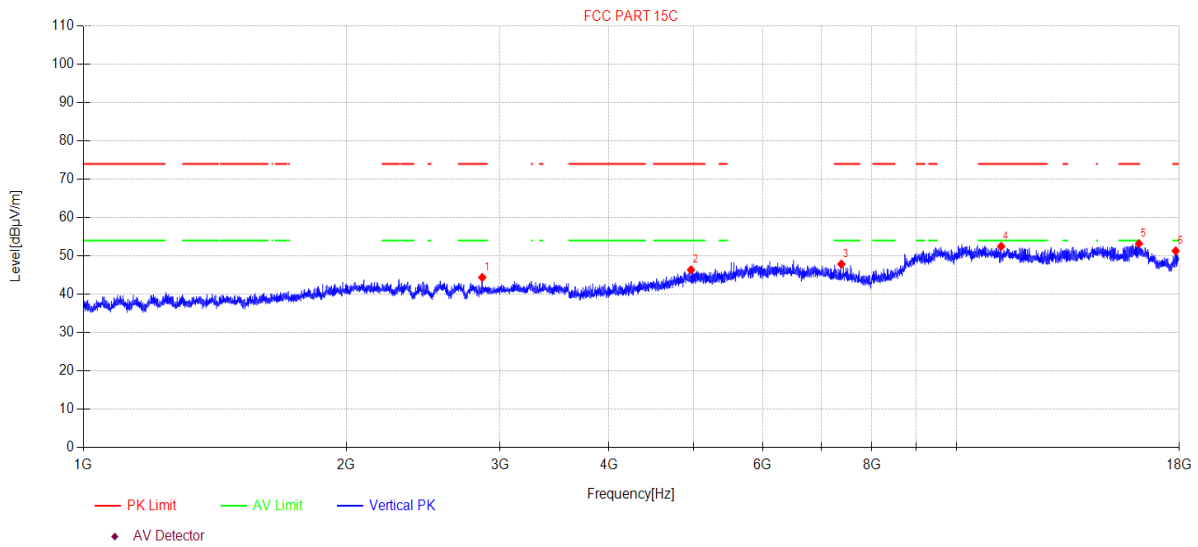

Suspected Data List										
N O.	Freq. [MHz]	Reading [dBµV/m]	Cable loss [dB]	Antenna Factor [dB]	AMP [dB]	Level [dBµV/m]	Limit [dBµV/m]	Margin [dB]	Detector	Polarity
1	2863.34	49.40	5.69	28.75	-39.45	44.39	74.00	29.61	PK	Vertical
2	4965.68	45.85	7.80	32.80	-40.09	46.36	74.00	27.64	PK	Vertical
3	7382.19	45.39	7.64	36.50	-41.66	47.87	74.00	26.13	PK	Vertical
4	11250.86	42.71	9.87	39.10	-39.21	52.47	74.00	21.53	PK	Vertical
5	16183.90	39.83	15.15	37.72	-39.51	53.19	74.00	20.81	PK	Vertical
6	17829.15	39.71	12.92	40.70	-42.02	51.31	74.00	22.69	PK	Vertical

Note:

1. Level = Reading + Cable loss + Antenna Factor + AMP
2. If Peak Result complies with AV limit, AV Result is deemed to comply with AV limit.
3. Test setup: RBW: 1 MHz, VBW: 3 MHz, Sweep time: auto.

TR-4-E-009 Radiated Emission Test Result

Test Date: 2023-09-14 **Tested By:** Bairong
EUT: Portable Bluetooth Speaker **Model Number:** XTREME 4G
Test Mode: BLE 2M TX 2404MHz **Power Supply:** AC 120V/60Hz
Condition: Temp:21.6°C;Humi:60.7% **Test Site:** DDT 3# Chamber
File Path: d:\ts\2023 report data\Q23090419-2E\FCC ABOVE 1G\33
Memo: Sample Number: S23090419-25

Test Graph

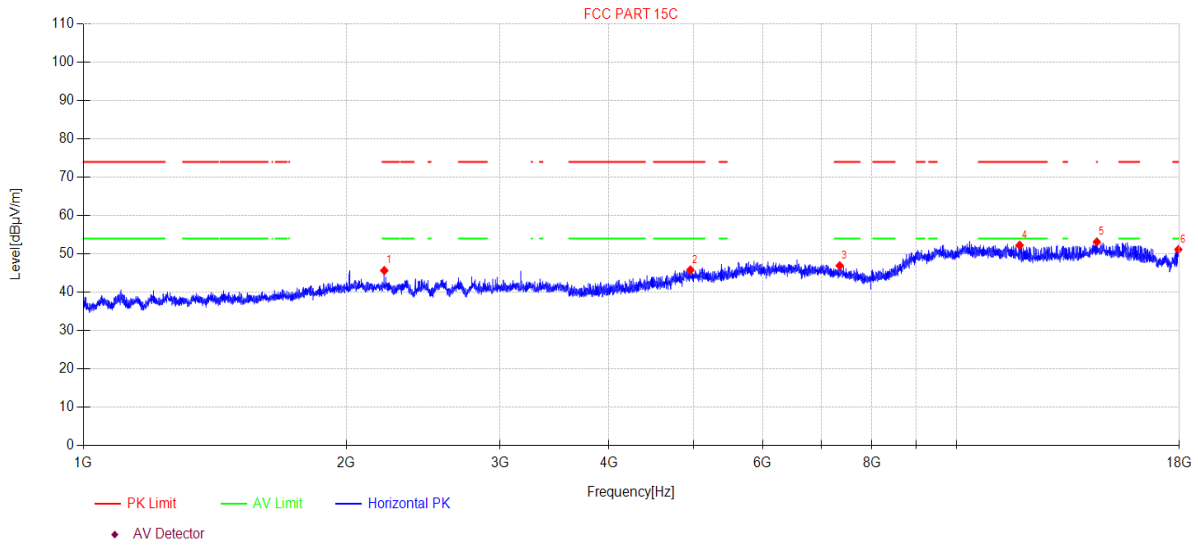

Suspected Data List										
N O.	Freq. [MHz]	Reading [dBµV/m]	Cable loss [dB]	Antenna Factor [dB]	AMP [dB]	Level [dBµV/m]	Limit [dBµV/m]	Margin [dB]	Detector	Polarity
1	2211.38	50.08	5.98	27.22	-37.61	45.67	74.00	28.33	PK	Horizontal
2	4957.08	45.33	7.78	32.80	-40.10	45.81	74.00	28.19	PK	Horizontal
3	7350.26	44.37	7.63	36.50	-41.58	46.92	74.00	27.08	PK	Horizontal
4	11814.02	42.58	10.37	38.80	-39.47	52.28	74.00	21.72	PK	Horizontal
5	14479.71	41.18	11.14	40.02	-39.22	53.12	74.00	20.88	PK	Horizontal
6	17953.24	38.86	13.07	41.52	-42.30	51.15	74.00	22.85	PK	Horizontal

Note:

1. Level = Reading + Cable loss + Antenna Factor + AMP
2. If Peak Result complies with AV limit, AV Result is deemed to comply with AV limit.
3. Test setup: RBW: 1 MHz, VBW: 3 MHz, Sweep time: auto.

TR-4-E-009 Radiated Emission Test Result

Test Date: 2023-09-14 **Tested By:** Bairong
EUT: Portable Bluetooth Speaker **Model Number:** XTREME 4G
Test Mode: BLE 2M TX 2404MHz **Power Supply:** AC 120V/60Hz
Condition: Temp:21.6°C;Humi:60.7% **Test Site:** DDT 3# Chamber
File Path: d:\ts\2023 report data\Q23090419-2E\FCC ABOVE 1G\34
Memo: Sample Number: S23090419-25

Test Graph

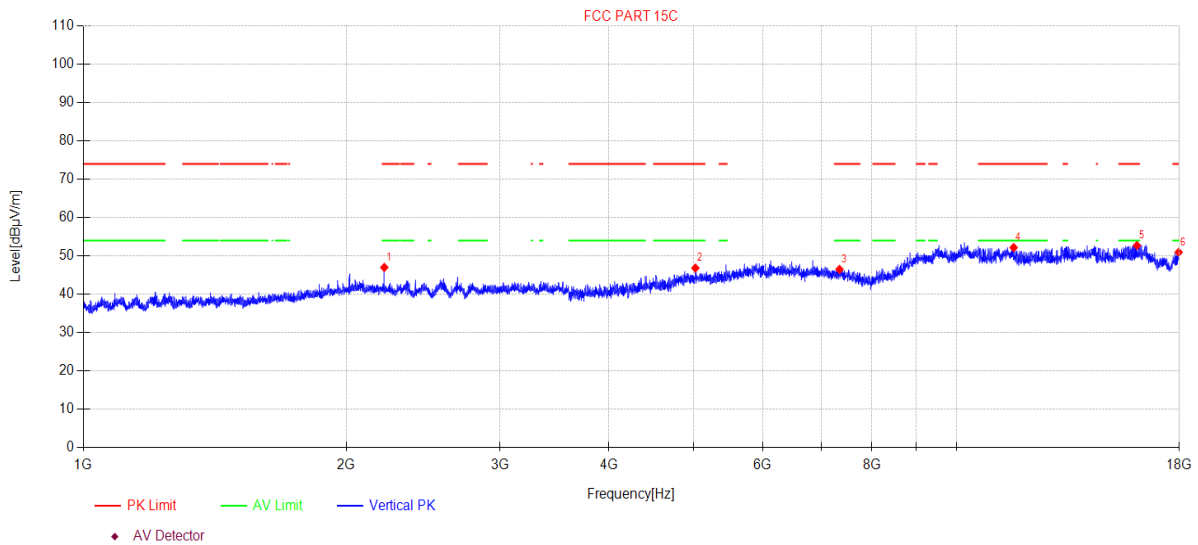

Suspected Data List										
N O.	Freq. [MHz]	Reading [dBµV/m]	Cable loss [dB]	Antenna Factor [dB]	AMP [dB]	Level [dBµV/m]	Limit [dBµV/m]	Margin [dB]	Detector	Polarity
1	2211.38	51.42	5.98	27.22	-37.61	47.01	74.00	26.99	PK	Vertical
2	5023.42	46.17	7.90	32.85	-40.08	46.84	74.00	27.16	PK	Vertical
3	7346.01	43.93	7.63	36.50	-41.57	46.49	74.00	27.51	PK	Vertical
4	11627.71	42.48	10.21	38.87	-39.39	52.17	74.00	21.83	PK	Vertical
5	16095.27	38.84	15.50	37.80	-39.44	52.70	74.00	21.30	PK	Vertical
6	17968.81	38.59	13.09	41.61	-42.33	50.96	74.00	23.04	PK	Vertical

Note:

1. Level = Reading + Cable loss + Antenna Factor + AMP
2. If Peak Result complies with AV limit, AV Result is deemed to comply with AV limit.
3. Test setup: RBW: 1 MHz, VBW: 3 MHz, Sweep time: auto.

TR-4-E-009 Radiated Emission Test Result

Test Date: 2023-09-14 **Tested By:** Bairong
EUT: Portable Bluetooth Speaker **Model Number:** XTREME 4G
Test Mode: BLE 2M TX 2440MHz **Power Supply:** AC 120V/60Hz
Condition: Temp:21.6°C;Humi:60.7% **Test Site:** DDT 3# Chamber
File Path: d:\ts\2023 report data\Q23090419-2E\FCC ABOVE 1G\35
Memo: Sample Number: S23090419-25

Test Graph

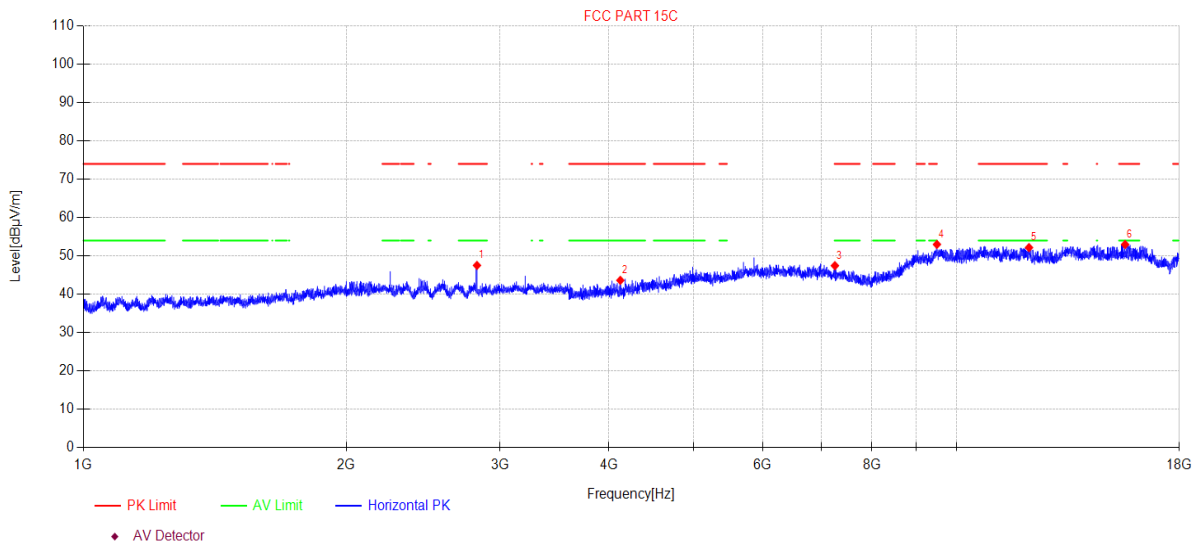

Suspected Data List										
N O.	Freq. [MHz]	Reading [dBµV/m]	Cable loss [dB]	Antenna Factor [dB]	AMP [dB]	Level [dBµV/m]	Limit [dBµV/m]	Margin [dB]	Detector	Polarity
1	2823.90	52.56	5.71	28.60	-39.34	47.53	74.00	26.47	PK	Horizontal
2	4121.18	47.02	6.09	30.94	-40.41	43.64	74.00	30.36	PK	Horizontal
3	7257.38	44.66	7.63	36.50	-41.34	47.45	74.00	26.55	PK	Horizontal
4	9498.04	44.53	8.83	38.40	-38.76	53.00	74.00	21.00	PK	Horizontal
5	12107.83	42.14	10.54	39.10	-39.60	52.18	74.00	21.82	PK	Horizontal
6	15600.65	39.63	14.07	38.40	-39.12	52.98	74.00	21.02	PK	Horizontal

Note:

1. Level = Reading + Cable loss + Antenna Factor + AMP
2. If Peak Result complies with AV limit, AV Result is deemed to comply with AV limit.
3. Test setup: RBW: 1 MHz, VBW: 3 MHz, Sweep time: auto.

TR-4-E-009 Radiated Emission Test Result

Test Date: 2023-09-14 **Tested By:** Bairong
EUT: Portable Bluetooth Speaker **Model Number:** XTREME 4G
Test Mode: BLE 2M TX 2440MHz **Power Supply:** AC 120V/60Hz
Condition: Temp:21.6°C;Humi:60.7% **Test Site:** DDT 3# Chamber
File Path: d:\ts\2023 report data\Q23090419-2E\FCC ABOVE 1G\36
Memo: Sample Number: S23090419-25

Test Graph

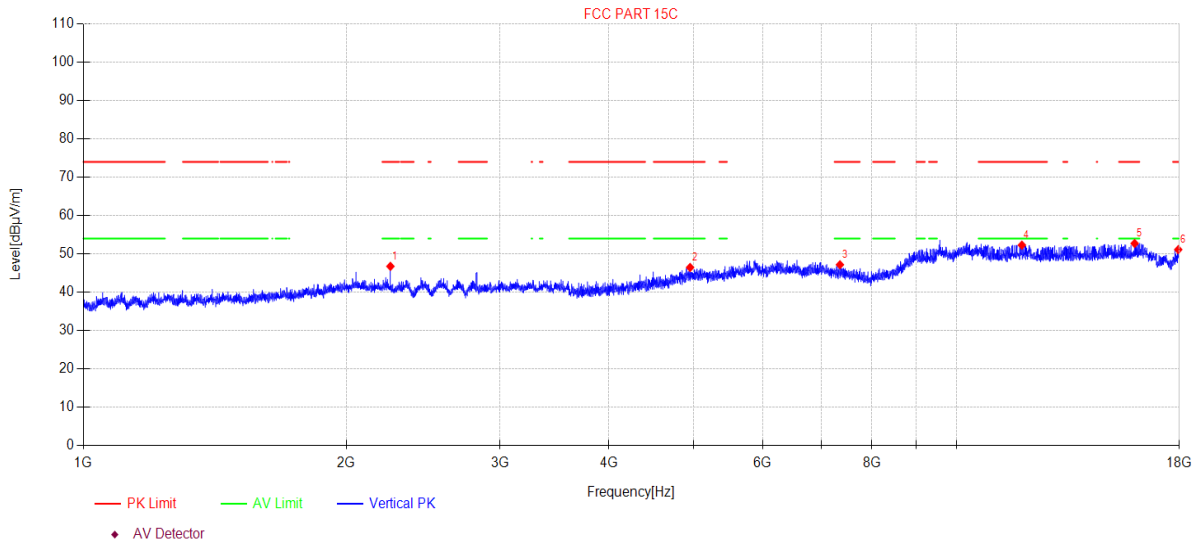

Suspected Data List										
N O.	Freq. [MHz]	Reading [dBµV/m]	Cable loss [dB]	Antenna Factor [dB]	AMP [dB]	Level [dBµV/m]	Limit [dBµV/m]	Margin [dB]	Detector	Polarity
1	2247.46	51.22	5.96	27.29	-37.71	46.76	74.00	27.24	PK	Vertical
2	4954.22	45.99	7.78	32.80	-40.10	46.47	74.00	27.53	PK	Vertical
3	7354.51	44.64	7.63	36.50	-41.59	47.18	74.00	26.82	PK	Vertical
4	11882.50	42.55	10.44	38.80	-39.50	52.29	74.00	21.71	PK	Vertical
5	15997.88	38.31	15.87	37.90	-39.36	52.72	74.00	21.28	PK	Vertical
6	17948.05	38.84	13.07	41.49	-42.28	51.12	74.00	22.88	PK	Vertical

Note:

1. Level = Reading + Cable loss + Antenna Factor + AMP
2. If Peak Result complies with AV limit, AV Result is deemed to comply with AV limit.
3. Test setup: RBW: 1 MHz, VBW: 3 MHz, Sweep time: auto.

TR-4-E-009 Radiated Emission Test Result

Test Date: 2023-09-14 **Tested By:** Bairong
EUT: Portable Bluetooth Speaker **Model Number:** XTREME 4G
Test Mode: BLE 2M TX 2478MHz **Power Supply:** AC 120V/60Hz
Condition: Temp:21.6°C;Humi:60.7% **Test Site:** DDT 3# Chamber
File Path: d:\ts\2023 report data\Q23090419-2E\FCC ABOVE 1G\37
Memo: Sample Number: S23090419-25

Test Graph

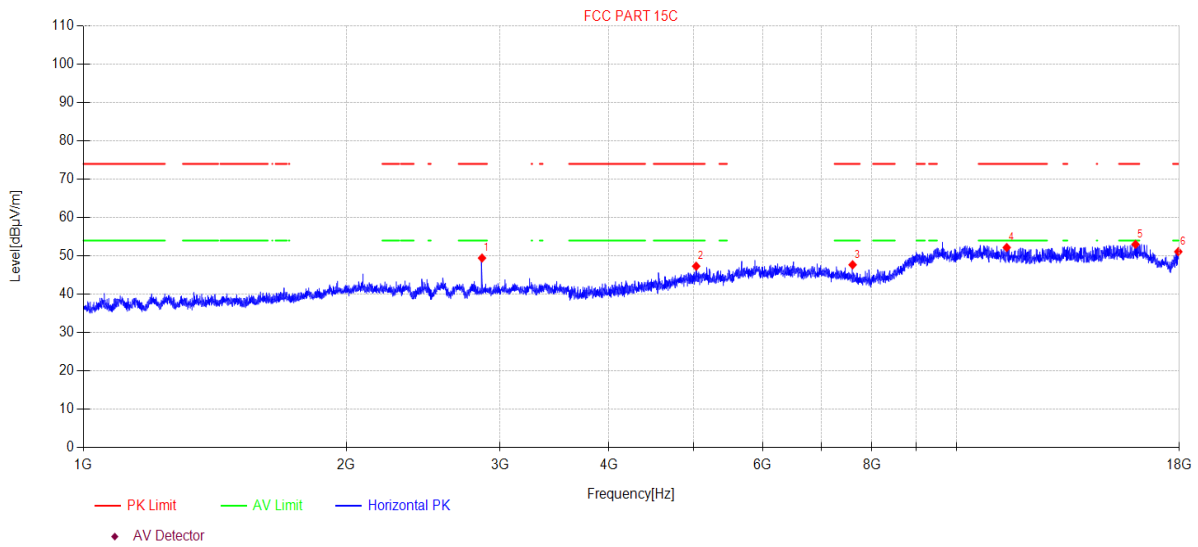

Suspected Data List										
N O.	Freq. [MHz]	Reading [dBµV/m]	Cable loss [dB]	Antenna Factor [dB]	AMP [dB]	Level [dBµV/m]	Limit [dBµV/m]	Margin [dB]	Detector	Polarity
1	2861.69	54.45	5.69	28.75	-39.45	49.44	74.00	24.56	PK	Horizontal
2	5033.59	46.61	7.92	32.87	-40.08	47.32	74.00	26.68	PK	Horizontal
3	7605.24	45.84	7.65	36.41	-42.21	47.69	74.00	26.31	PK	Horizontal
4	11417.92	42.38	10.02	39.08	-39.29	52.19	74.00	21.81	PK	Horizontal
5	16034.91	38.79	15.74	37.87	-39.39	53.01	74.00	20.99	PK	Horizontal
6	17953.24	38.81	13.07	41.52	-42.30	51.10	74.00	22.90	PK	Horizontal

Note:

1. Level = Reading + Cable loss + Antenna Factor + AMP
2. If Peak Result complies with AV limit, AV Result is deemed to comply with AV limit.
3. Test setup: RBW: 1 MHz, VBW: 3 MHz, Sweep time: auto.

TR-4-E-009 Radiated Emission Test Result

Test Date: 2023-09-14 **Tested By:** Bairong
EUT: Portable Bluetooth Speaker **Model Number:** XTREME 4G
Test Mode: BLE 2M TX 2478MHz **Power Supply:** AC 120V/60Hz
Condition: Temp:21.6°C;Humi:60.7% **Test Site:** DDT 3# Chamber
File Path: d:\ts\2023 report data\Q23090419-2E\FCC ABOVE 1G\38
Memo: Sample Number: S23090419-25

Test Graph

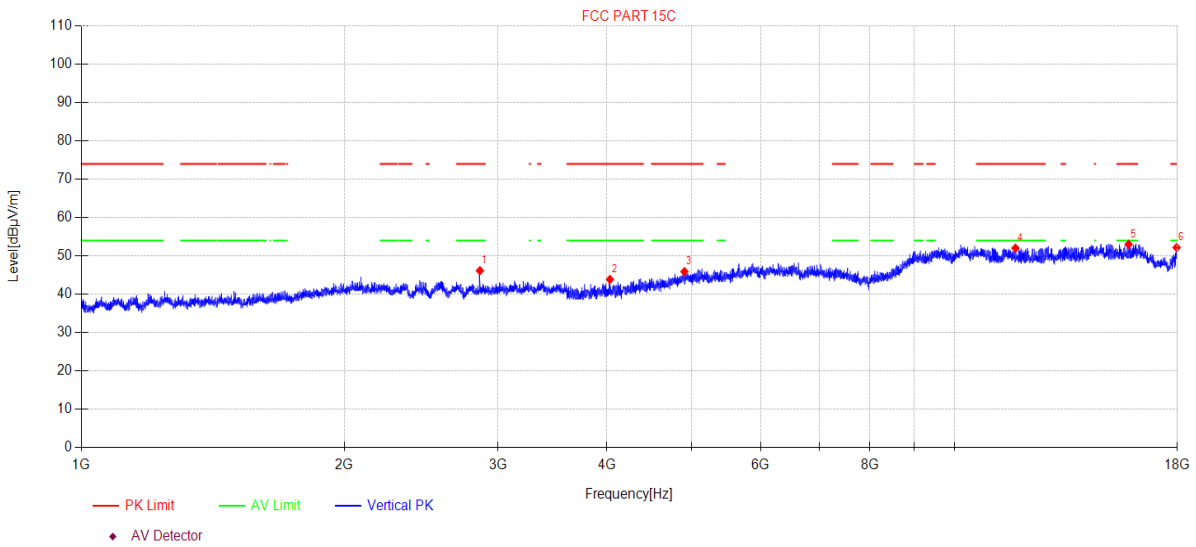

Suspected Data List										
N O.	Freq. [MHz]	Reading [dBµV/m]	Cable loss [dB]	Antenna Factor [dB]	AMP [dB]	Level [dBµV/m]	Limit [dBµV/m]	Margin [dB]	Detector	Polarity
1	2860.86	51.17	5.69	28.74	-39.45	46.15	74.00	27.85	PK	Vertical
2	4030.49	47.64	5.91	30.76	-40.44	43.87	74.00	30.13	PK	Vertical
3	4905.77	45.72	7.68	32.62	-40.11	45.91	74.00	28.09	PK	Vertical
4	11745.93	42.37	10.31	38.80	-39.44	52.04	74.00	21.96	PK	Vertical
5	15827.72	39.01	15.10	38.17	-39.26	53.02	74.00	20.98	PK	Vertical
6	17963.62	39.84	13.09	41.58	-42.32	52.19	74.00	21.81	PK	Vertical

Note:

1. Level = Reading + Cable loss + Antenna Factor + AMP
2. If Peak Result complies with AV limit, AV Result is deemed to comply with AV limit.
3. Test setup: RBW: 1 MHz, VBW: 3 MHz, Sweep time: auto.

12. Emissions in Restricted Frequency Bands

12.1. Test equipment

Equipment	Manufacturer	Model No.	Serial Number	Due Date
☑Radiation 3#Chamber				
EMI TEST RECEIVER	R&S	ESU26	100472	2024/04/22
Double Ridged Horn Antenna	Schwarzbeck	BBHA 9120 D	02468	2024/09/17
Pre-amplifier	COM-POWER	PAM-118A	18040084	2024/07/14
RF Cable	Yuhu	JCTB810-NJ-NJ-9M+ ZT26S-SMAJ-SMAJ-1M	21123964	2024/04/22
Test Software	Tonscend	JS32-RE	V 5.0.0.1	N/A

12.2. Block diagram of test setup

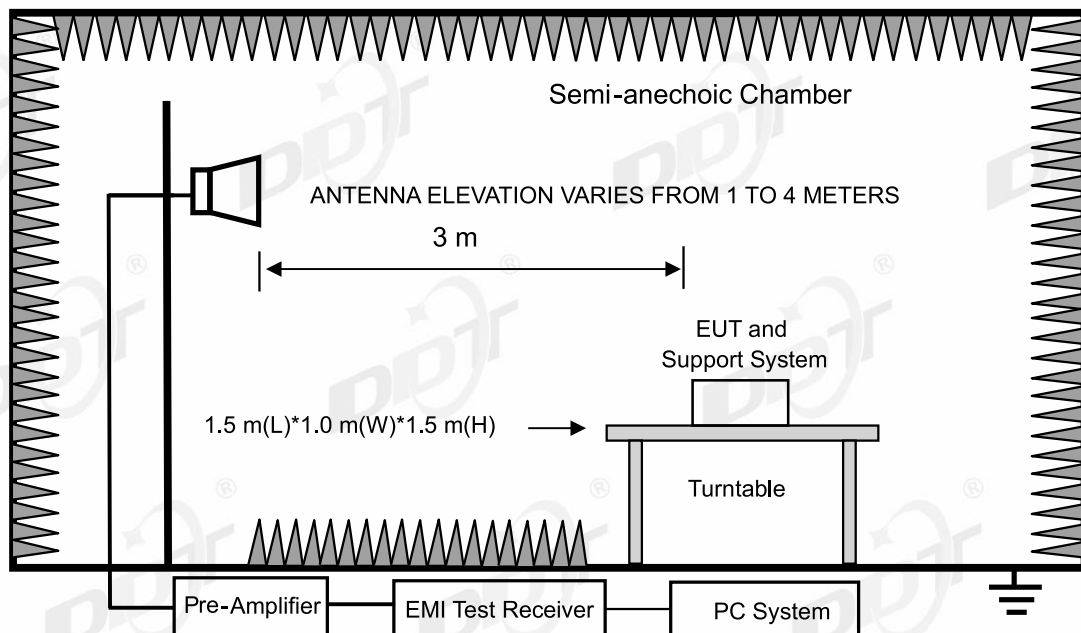

12.3. Limit

All restriction band should comply with 15.209 and RSS-Gen section 8.9 limits, other emission should be at least 20 dB below the fundamental.

12.4. Test procedure

Same with Radiated Emission except change investigated frequency range.

Remark: All restriction band have been tested, and only the worst case is shown in report.

12.5. Test result

Pass. (See below detailed test result)

TR-4-E-009 Radiated Emission Test Result

Test Date: 2023-09-14 **Tested By:** Bairong
EUT: Portable Bluetooth Speaker **Model Number:** XTREME 4G
Test Mode: BLE 1M TX 2402MHz **Power Supply:** AC 120V/60Hz
Condition: Temp:21.6°C;Humi:60.7% **Test Site:** DDT 3# Chamber
File Path: d:\ts\2023 report data\Q23090419-2E\FCC ABOVE 1G\7
Memo: Sample Number: S23090419-25

Test Graph

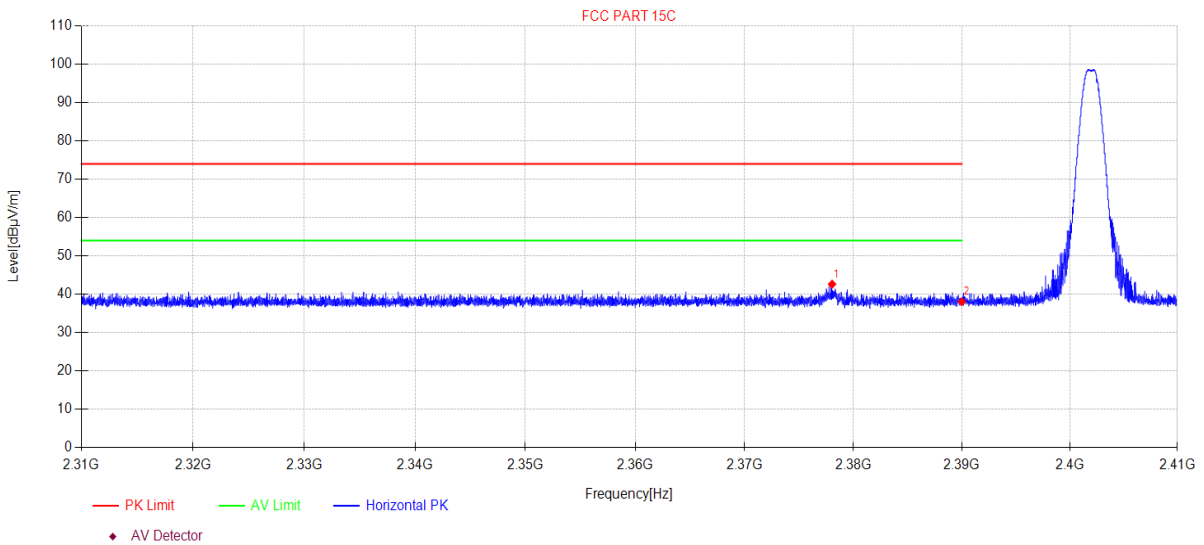

Suspected Data List										
NO	Freq. [MHz]	Reading [dBµV/m]	Cable loss [dB]	Antenna Factor [dB]	AMP [dB]	Level [dBµV/m]	Limit [dBµV/m]	Margin [dB]	Detector	Polarity
1	2378.04	49.39	3.86	27.46	-38.08	42.63	74.00	31.37	PK	Horizontal
2	2390.00	44.82	3.87	27.48	-38.11	38.06	74.00	35.94	PK	Horizontal

Note:

- Level = Reading + Cable loss + Antenna Factor + AMP
- If Peak Result complies with AV limit, AV Result is deemed to comply with AV limit.
- Test setup: RBW: 1 MHz, VBW: 3 MHz, Sweep time: auto.

TR-4-E-009 Radiated Emission Test Result

Test Date: 2023-09-14 **Tested By:** Bairong
EUT: Portable Bluetooth Speaker **Model Number:** XTREME 4G
Test Mode: BLE 1M TX 2402MHz **Power Supply:** AC 120V/60Hz
Condition: Temp:21.6°C;Humi:60.7% **Test Site:** DDT 3# Chamber
File Path: d:\ts\2023 report data\Q23090419-2E\FCC ABOVE 1G\8
Memo: Sample Number: S23090419-25

Test Graph

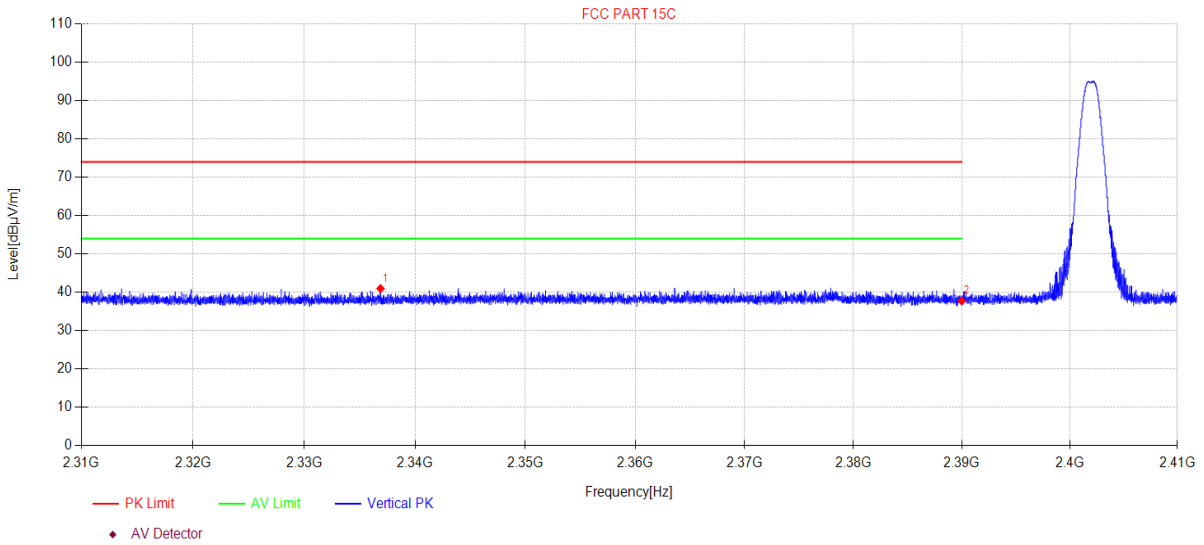

Suspected Data List										
NO	Freq. [MHz]	Reading [dBµV/m]	Cable loss [dB]	Antenna Factor [dB]	AMP [dB]	Level [dBµV/m]	Limit [dBµV/m]	Margin [dB]	Detector	Polarity
1	2336.88	47.74	3.83	27.37	-37.96	40.98	74.00	33.02	PK	Vertical
2	2390.00	44.52	3.87	27.48	-38.11	37.76	74.00	36.24	PK	Vertical

Note:

1. Level = Reading + Cable loss + Antenna Factor + AMP
2. If Peak Result complies with AV limit, AV Result is deemed to comply with AV limit.
3. Test setup: RBW: 1 MHz, VBW: 3 MHz, Sweep time: auto.

TR-4-E-009 Radiated Emission Test Result

Test Date: 2023-09-14 **Tested By:** Bairong
EUT: Portable Bluetooth Speaker **Model Number:** XTREME 4G
Test Mode: BLE 2M TX 2404MHz **Power Supply:** AC 120V/60Hz
Condition: Temp:21.6°C;Humi:60.7% **Test Site:** DDT 3# Chamber
File Path: d:\ts\2023 report data\Q23090419-2E\FCC ABOVE 1G\9
Memo: Sample Number: S23090419-25

Test Graph

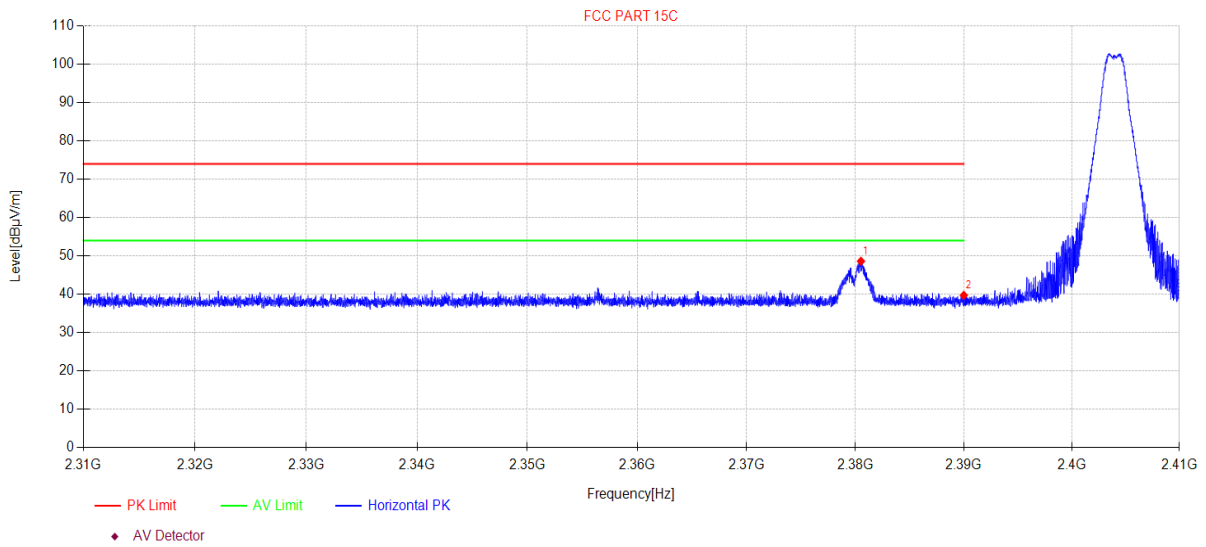

Suspected Data List										
NO	Freq. [MHz]	Reading [dBµV/m]	Cable loss [dB]	Antenna Factor [dB]	AMP [dB]	Level [dBµV/m]	Limit [dBµV/m]	Margin [dB]	Detector	Polarity
1	2380.51	55.39	3.86	27.46	-38.09	48.62	74.00	25.38	PK	Horizontal
2	2390.00	46.49	3.87	27.48	-38.11	39.73	74.00	34.27	PK	Horizontal

Note:

1. Level = Reading + Cable loss + Antenna Factor + AMP
2. If Peak Result complies with AV limit, AV Result is deemed to comply with AV limit.
3. Test setup: RBW: 1 MHz, VBW: 3 MHz, Sweep time: auto.

TR-4-E-009 Radiated Emission Test Result

Test Date: 2023-09-14 **Tested By:** Bairong
EUT: Portable Bluetooth Speaker **Model Number:** XTREME 4G
Test Mode: BLE 2M TX 2404MHz **Power Supply:** AC 120V/60Hz
Condition: Temp:21.6°C;Humi:60.7% **Test Site:** DDT 3# Chamber
File Path: d:\ts\2023 report data\Q23090419-2E\FCC ABOVE 1G\10
Memo: Sample Number: S23090419-25

Test Graph

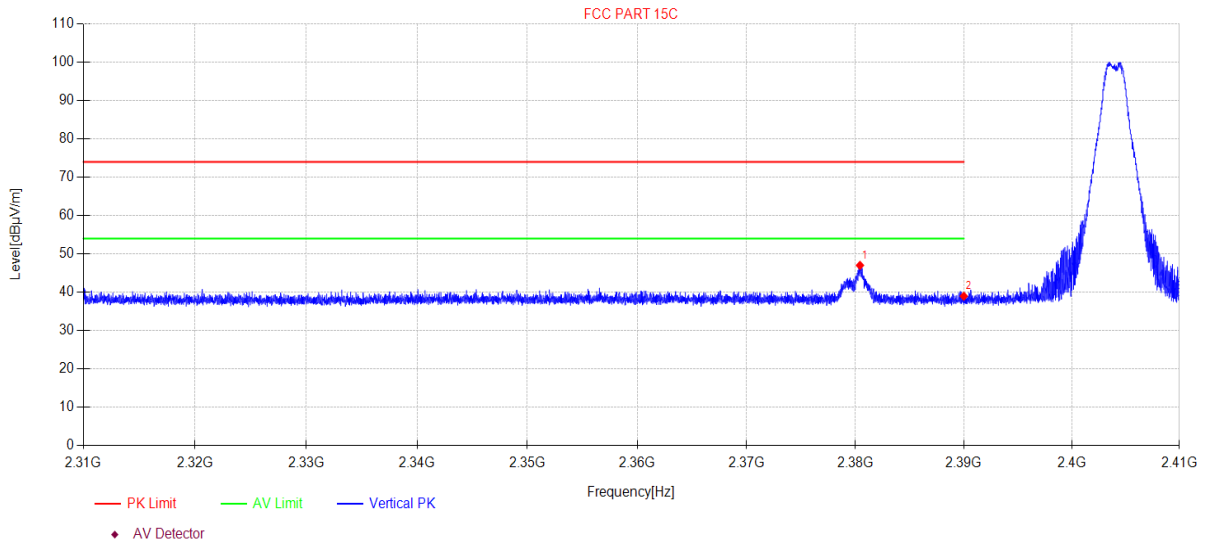

Suspected Data List										
NO	Freq. [MHz]	Reading [dBµV/m]	Cable loss [dB]	Antenna Factor [dB]	AMP [dB]	Level [dBµV/m]	Limit [dBµV/m]	Margin [dB]	Detector	Polarity
1	2380.42	53.78	3.86	27.46	-38.09	47.01	74.00	26.99	PK	Vertical
2	2390.00	45.76	3.87	27.48	-38.11	39.00	74.00	35.00	PK	Vertical

Note:

1. Level = Reading + Cable loss + Antenna Factor + AMP
2. If Peak Result complies with AV limit, AV Result is deemed to comply with AV limit.
3. Test setup: RBW: 1 MHz, VBW: 3 MHz, Sweep time: auto.

TR-4-E-009 Radiated Emission Test Result

Test Date: 2023-09-14 **Tested By:** Bairong
EUT: Portable Bluetooth Speaker **Model Number:** XTREME 4G
Test Mode: BLE 1M TX 2480MHz **Power Supply:** AC 120V/60Hz
Condition: Temp:21.6°C;Humi:60.7% **Test Site:** DDT 3# Chamber
File Path: d:\ts\2023 report data\Q23090419-2E\FCC ABOVE 1G\17
Memo: Sample Number: S23090419-25

Test Graph

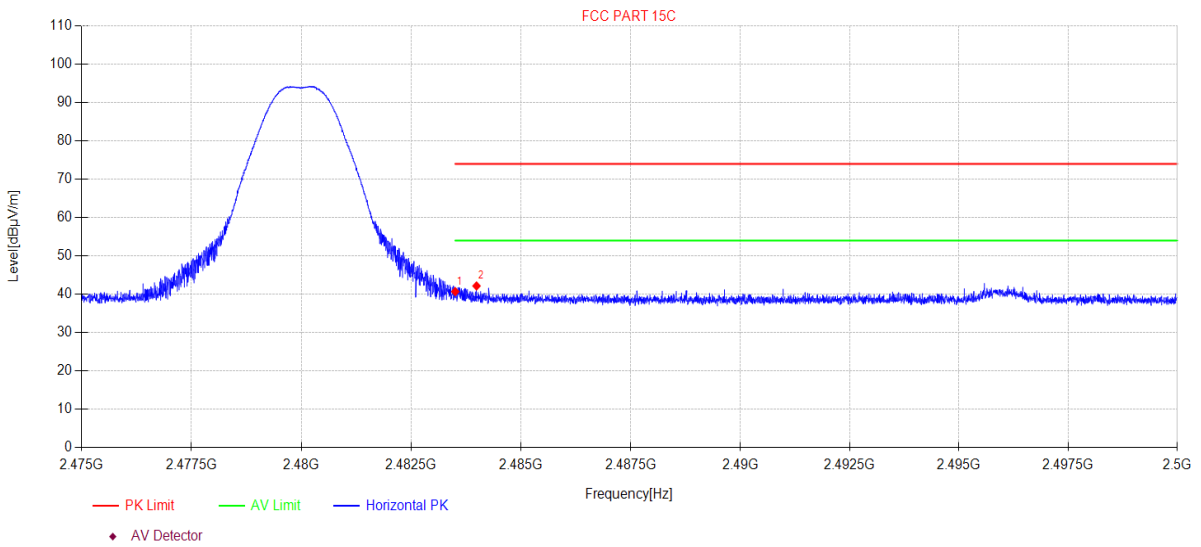

Suspected Data List										
NO	Freq. [MHz]	Reading [dBµV/m]	Cable loss [dB]	Antenna Factor [dB]	AMP [dB]	Level [dBµV/m]	Limit [dBµV/m]	Margin [dB]	Detector	Polarity
1	2483.50	47.42	3.94	27.73	-38.38	40.71	74.00	33.29	PK	Horizontal
2	2483.99	48.88	3.94	27.74	-38.38	42.18	74.00	31.82	PK	Horizontal

Note:

1. Level = Reading + Cable loss + Antenna Factor + AMP
2. If Peak Result complies with AV limit, AV Result is deemed to comply with AV limit.
3. Test setup: RBW: 1 MHz, VBW: 3 MHz, Sweep time: auto.

TR-4-E-009 Radiated Emission Test Result

Test Date: 2023-09-14 **Tested By:** Bairong
EUT: Portable Bluetooth Speaker **Model Number:** XTREME 4G
Test Mode: BLE 1M TX 2480MHz **Power Supply:** AC 120V/60Hz
Condition: Temp:21.6°C;Humi:60.7% **Test Site:** DDT 3# Chamber
File Path: d:\ts\2023 report data\Q23090419-2E\FCC ABOVE 1G\18
Memo: Sample Number: S23090419-25

Test Graph

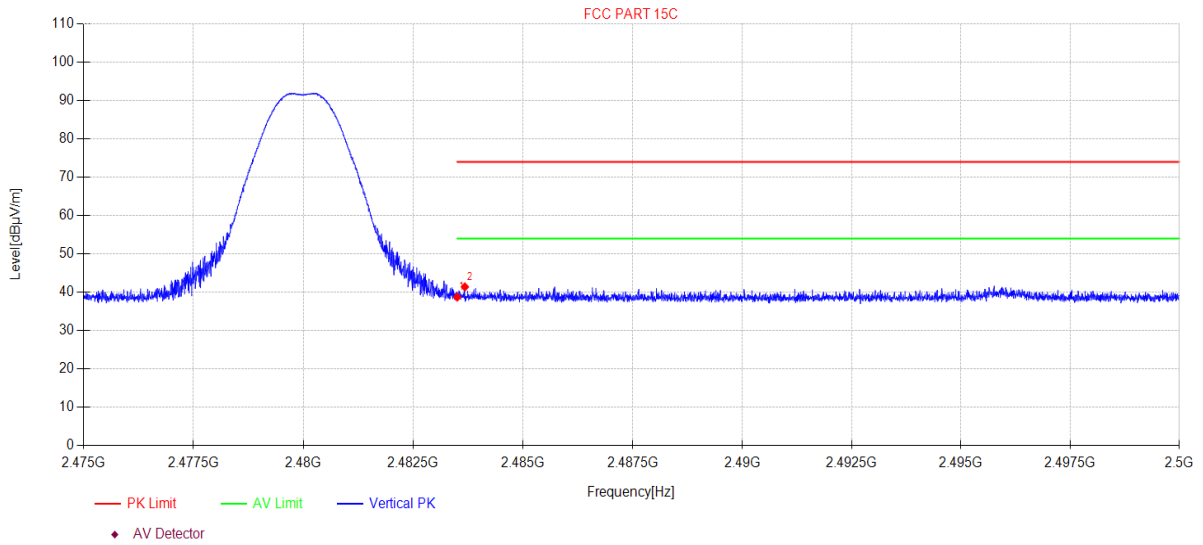

Suspected Data List										
NO	Freq. [MHz]	Reading [dBµV/m]	Cable loss [dB]	Antenna Factor [dB]	AMP [dB]	Level [dBµV/m]	Limit [dBµV/m]	Margin [dB]	Detector	Polarity
1	2483.50	45.46	3.94	27.73	-38.38	38.75	74.00	35.25	PK	Vertical
2	2483.68	48.12	3.94	27.73	-38.38	41.41	74.00	32.59	PK	Vertical

Note:

1. Level = Reading + Cable loss + Antenna Factor + AMP
2. If Peak Result complies with AV limit, AV Result is deemed to comply with AV limit.
3. Test setup: RBW: 1 MHz, VBW: 3 MHz, Sweep time: auto.

TR-4-E-009 Radiated Emission Test Result

Test Date: 2023-09-14 **Tested By:** Bairong
EUT: Portable Bluetooth Speaker **Model Number:** XTREME 4G
Test Mode: BLE 2M TX 2478MHz **Power Supply:** AC 120V/60Hz
Condition: Temp:21.6°C;Humi:60.7% **Test Site:** DDT 3# Chamber
File Path: d:\ts\2023 report data\Q23090419-2E\FCC ABOVE 1G\19
Memo: Sample Number: S23090419-25

Test Graph

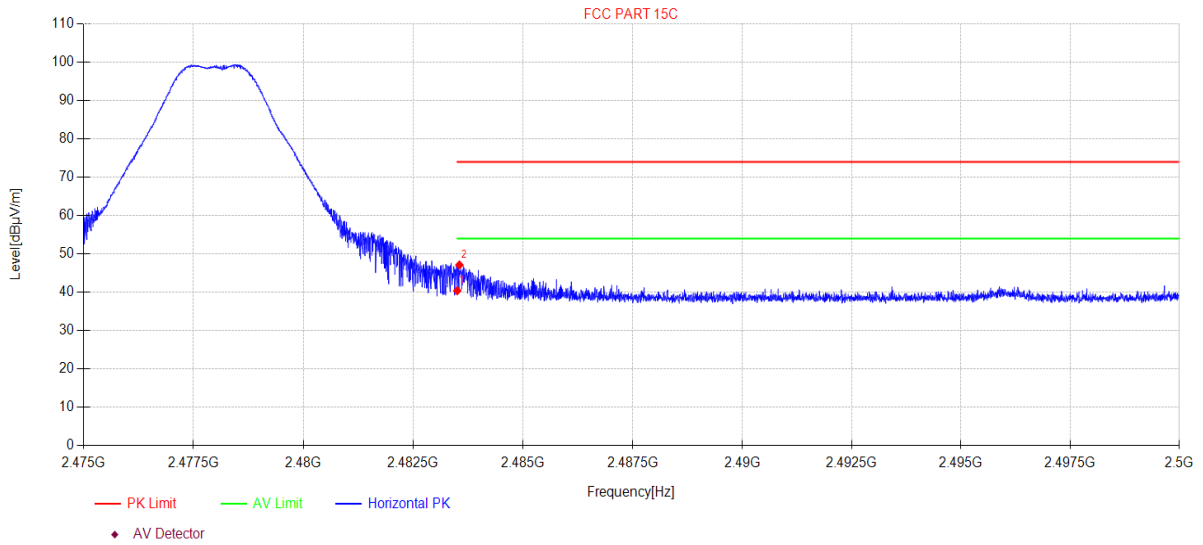

Suspected Data List										
NO	Freq. [MHz]	Reading [dBµV/m]	Cable loss [dB]	Antenna Factor [dB]	AMP [dB]	Level [dBµV/m]	Limit [dBµV/m]	Margin [dB]	Detector	Polarity
1	2483.50	47.13	3.94	27.73	-38.38	40.42	74.00	33.58	PK	Horizontal
2	2483.55	53.83	3.94	27.73	-38.38	47.12	74.00	26.88	PK	Horizontal

Note:

1. Level = Reading + Cable loss + Antenna Factor + AMP
2. If Peak Result complies with AV limit, AV Result is deemed to comply with AV limit.
3. Test setup: RBW: 1 MHz, VBW: 3 MHz, Sweep time: auto.

TR-4-E-009 Radiated Emission Test Result

Test Date: 2023-09-14 **Tested By:** Bairong
EUT: Portable Bluetooth Speaker **Model Number:** XTREME 4G
Test Mode: BLE 2M TX 2478MHz **Power Supply:** AC 120V/60Hz
Condition: Temp:21.6°C;Humi:60.7% **Test Site:** DDT 3# Chamber
File Path: d:\ts\2023 report data\Q23090419-2E\FCC ABOVE 1G\20
Memo: Sample Number: S23090419-25

Test Graph

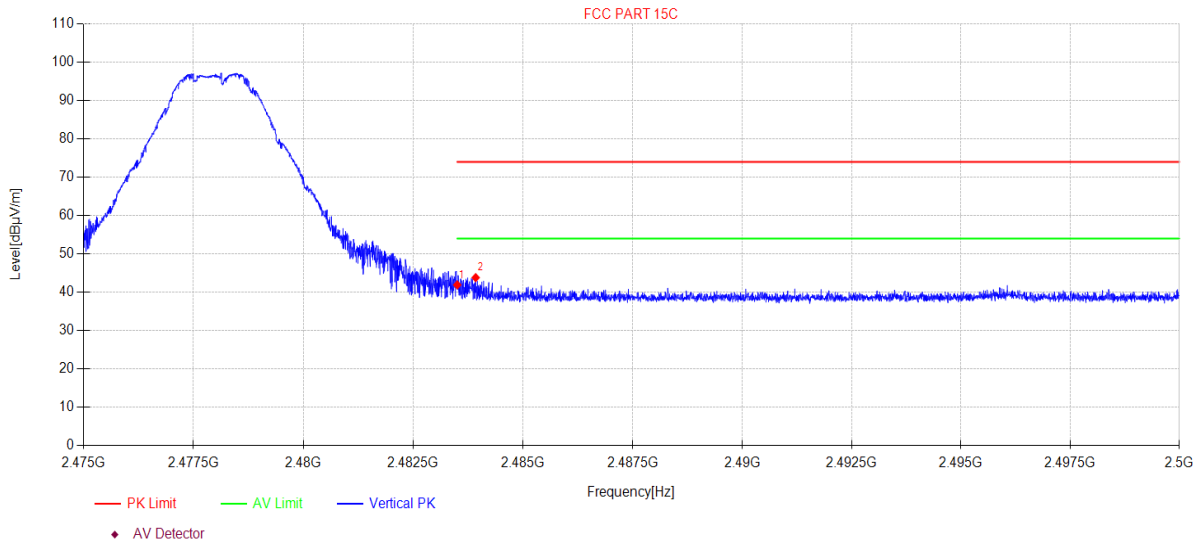

Suspected Data List										
NO	Freq. [MHz]	Reading [dBµV/m]	Cable loss [dB]	Antenna Factor [dB]	AMP [dB]	Level [dBµV/m]	Limit [dBµV/m]	Margin [dB]	Detector	Polarity
1	2483.50	48.64	3.94	27.73	-38.38	41.93	74.00	32.07	PK	Vertical
2	2483.92	50.52	3.94	27.74	-38.38	43.82	74.00	30.18	PK	Vertical

Note:

1. Level = Reading + Cable loss + Antenna Factor + AMP
2. If Peak Result complies with AV limit, AV Result is deemed to comply with AV limit.
3. Test setup: RBW: 1 MHz, VBW: 3 MHz, Sweep time: auto.

13. Power Line Conducted Emission

13.1. Test equipment

Equipment	Manufacturer	Model No.	Serial Number	Due Date
☑Power Line Conducted Emissions Test 1#				
Test Receiver	R&S	ESCI	100551	2024/07/10
LISN 1	R&S	ENV216	101109	2024/07/10
LISN 2	R&S	ESH2-Z5	100309	2024/07/11
Pulse Limiter	R&S	ESH3-Z2	101242	2024/07/14
CE Cable 1	HUBSER	N/A	W10.01	2024/07/14
Test software	Audix	E3	V 6.11111b	N/A

13.2. Block diagram of test setup

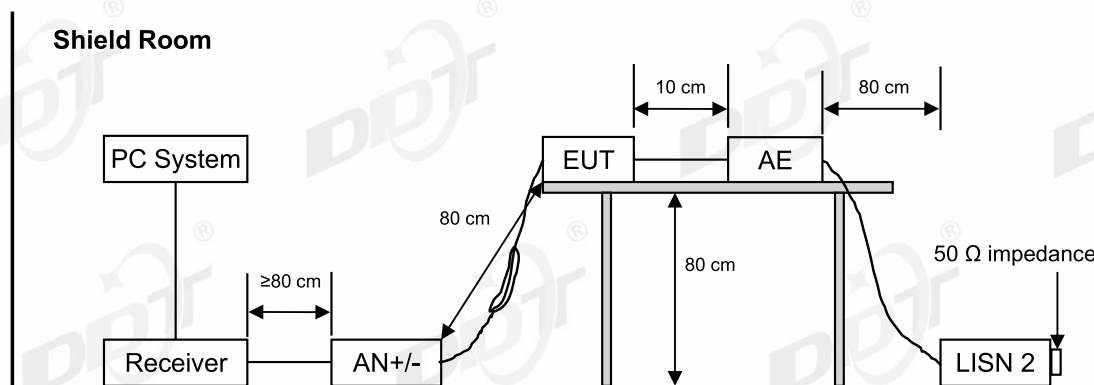

13.3. Power line conducted emission limits

Frequency	Quasi-Peak Level dB(μ V)	Average Level dB(μ V)
150 kHz ~ 500 kHz	66 ~ 56*	56 ~ 46*
500 kHz ~ 5 MHz	56	46
5 MHz ~ 30 MHz	60	50

Note 1: * Decreasing linearly with logarithm of frequency.

Note 2: The lower limit shall apply at the transition frequencies.

13.4. Test procedure

The EUT and Support equipment, if needed, were put placed on a non-metallic table, 80 cm above the ground plane.

All support equipment power received from a second LISN.

Emissions were measured on each current carrying line of the EUT using an EMI Test Receiver connected to the LISN powering the EUT.

The Receiver scanned from 150 kHz to 30 MHz for emissions in each of the test modes.

During the above scans, the emissions were maximized by cable manipulation.

The test mode(s) described in clause 2.4 were scanned during the preliminary test.

After the preliminary scan, we found the test mode producing the highest emission level.

The EUT configuration and worse cable configuration of the above highest emission levels were recorded for reference of the final test.

EUT and support equipment were set up on the test bench as per the configuration with highest emission level in the preliminary test.

A scan was taken on both power lines, Neutral and Line, recording at least the six highest emissions.

Emission frequency and amplitude were recorded into a computer in which correction factors were used to calculate the emission level and compare reading to the applicable limit.

The test data of the worst-case condition(s) was recorded.

The bandwidth of test receiver is set at 9 kHz.

13.5. Test result

Pass. (See below detailed test result)

Note1: All emissions not reported below are too low against the prescribed limits.

Note2: "----" means Peak detection; "----" means Average detection.

Note3: Pre-test AC conducted emission at both voltage AC 120V/60Hz and AC 240V/50Hz, recorded worse case.

TR-4-E-010 Conducted Emission Test Result

Test Site : DDT 5# Shield Room D:\2023 report data\Q23090419-2\FCC CE.EM6
Test Date : 2023-09-18 **Tested By** : Bairong
EUT : Portable Bluetooth Speaker **Model Number** : XTREME 4G
Power Supply : AC 120V/60Hz **Test Mode** : Tx mode
Condition : Temp:22.6°C,Humi:60.6% **LISN** : 2023 ENV216 2#/NEUTRAL

Memo :

Data: 6

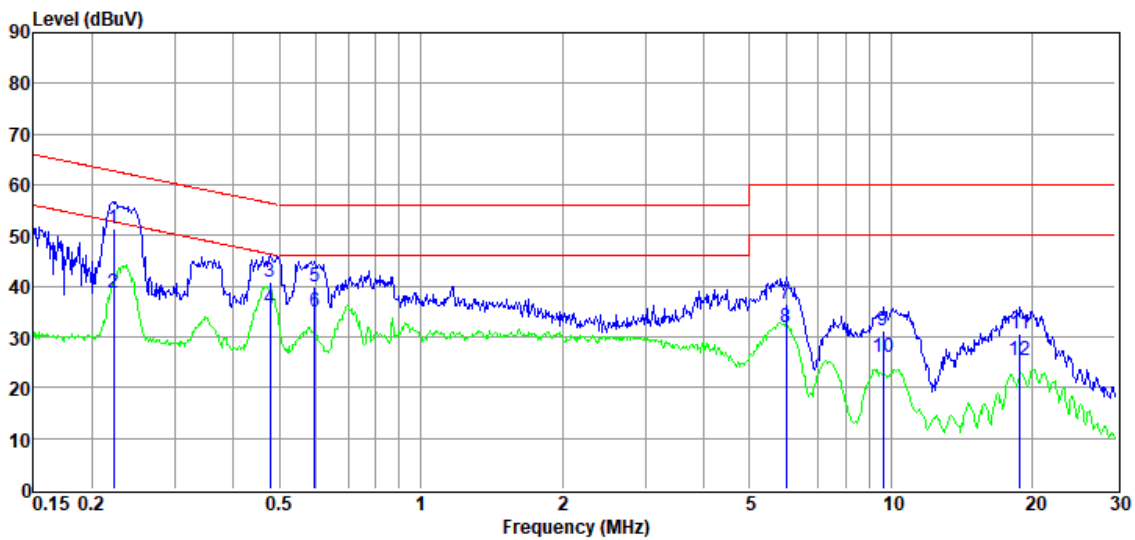

Item (Mark)	Freq. (MHz)	Read Level (dBμV)	LISN Factor (dB)	Cable Loss (dB)	Pulse Limiter Factor (dB)	Result Level (dBμV)	Limit Line (dBμV)	Over Limit (dB)	Detector	Phase
1	0.22	31.13	9.92	0.20	10.14	51.39	62.74	-11.35	QP	NEUTRAL
2	0.22	18.50	9.92	0.20	10.14	38.76	52.74	-13.98	Average	NEUTRAL
3	0.48	20.49	9.97	0.25	10.05	40.76	56.36	-15.60	QP	NEUTRAL
4	0.48	15.31	9.97	0.25	10.05	35.58	46.36	-10.78	Average	NEUTRAL
5	0.59	19.53	10.03	0.26	10.01	39.83	56.00	-16.17	QP	NEUTRAL
6	0.59	14.50	10.03	0.26	10.01	34.80	46.00	-11.20	Average	NEUTRAL
7	5.99	16.20	10.00	0.37	10.03	36.60	60.00	-23.40	QP	NEUTRAL
8	5.99	11.39	10.00	0.37	10.03	31.79	50.00	-18.21	Average	NEUTRAL
9	9.60	10.55	10.05	0.38	10.15	31.13	60.00	-28.87	QP	NEUTRAL
10	9.60	5.27	10.05	0.38	10.15	25.85	50.00	-24.15	Average	NEUTRAL
11	18.82	10.21	10.00	0.40	10.06	30.67	60.00	-29.33	QP	NEUTRAL
12	18.82	4.84	10.00	0.40	10.06	25.30	50.00	-24.70	Average	NEUTRAL

- Note: 1. Result Level = Read Level + LISN Factor + Pulse Limiter Factor + Cable loss.
 2. If QP Result complies with AV limit, AV Result is deemed to comply with AV limit.
 3. Test setup: RBW: 200 Hz (9 kHz—150 kHz), 9 kHz (150 kHz—30 MHz).
 4. Step size: 80Hz (0.009MHz-0.15MHz), 4 kHz (0.15MHz-30MHz), Scan time: auto.

TR-4-E-010 Conducted Emission Test Result

Test Site : DDT 5# Shield Room D:\2023 report data\Q23090419-2E\FCC CE.EM6
Test Date : 2023-09-18 **Tested By** : Bairong
EUT : Portable Bluetooth Speaker **Model Number** : XTREME 4G
Power Supply : AC 120V/60Hz **Test Mode** : Tx mode
Condition : Temp:22.6°C,Humi:60.6% **LISN** : 2023 ENV216 2#/LINE

Memo :

Data: 8

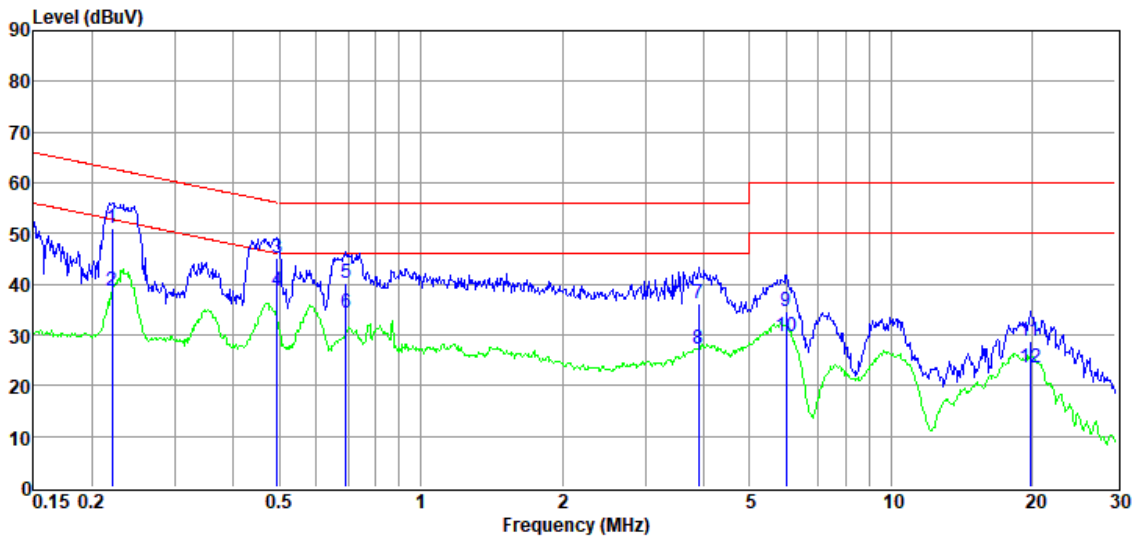

Item (Mark)	Freq. (MHz)	Read Level (dBμV)	LISN Factor (dB)	Cable Loss (dB)	Pulse Limiter Factor (dB)	Result Level (dBμV)	Limit Line (dBμV)	Over Limit (dB)	Detector	Phase
1	0.22	30.65	9.96	0.20	10.14	50.95	62.79	-11.84	QP	LINE
2	0.22	18.31	9.96	0.20	10.14	38.61	52.79	-14.18	Average	LINE
3	0.49	24.93	9.99	0.25	10.05	45.22	56.10	-10.88	QP	LINE
4	0.49	18.32	9.99	0.25	10.05	38.61	46.10	-7.49	Average	LINE
5	0.69	19.96	9.89	0.26	9.97	40.08	56.00	-15.92	QP	LINE
6	0.69	14.19	9.89	0.26	9.97	34.31	46.00	-11.69	Average	LINE
7	3.90	15.79	9.99	0.36	9.92	36.06	56.00	-19.94	QP	LINE
8	3.90	6.86	9.99	0.36	9.92	27.13	46.00	-18.87	Average	LINE
9	5.99	14.30	9.90	0.37	10.03	34.60	60.00	-25.40	QP	LINE
10	5.99	9.39	9.90	0.37	10.03	29.69	50.00	-20.31	Average	LINE
11	19.74	8.46	9.89	0.40	10.05	28.80	60.00	-31.20	QP	LINE
12	19.74	3.12	9.89	0.40	10.05	23.46	50.00	-26.54	Average	LINE

- Note: 1. Result Level = Read Level + LISN Factor + Pulse Limiter Factor + Cable loss.
 2. If QP Result complies with AV limit, AV Result is deemed to comply with AV limit.
 3. Test setup: RBW: 200 Hz (9 kHz—150 kHz), 9 kHz (150 kHz—30 MHz).
 4. Step size: 80Hz (0.009MHz-0.15MHz), 4 kHz (0.15MHz-30MHz), Scan time: auto.

14. Antenna Requirements

14.1. Limit

For intentional device, according to FCC 47 CFR Section 15.203, an intentional radiator shall be designed to ensure that no antenna other than that furnished by the responsible party shall be used with the device. And according to FCC 47 CFR Section 15.247 (b), if transmitting antennas of directional gain greater than 6 dBi are used, the power shall be reduced by the amount in dB that the directional gain of the antenna exceeds 6 dBi.

For intentional device, according to RSS-Gen issue 5 section 6.8.

The applicant for equipment certification shall provide a list of all antenna types that may be used with the transmitter, where applicable (i.e. for transmitters with detachable antenna), indicating the maximum permissible antenna gain (in dBi) and the required impedance for each antenna. The test report shall demonstrate the compliance of the transmitter with the limit for maximum equivalent isotropically radiated power (e.i.r.p.) specified in the applicable RSS, when the transmitter is equipped with any antenna type, selected from this list.

14.2. Result

The antenna used for this product as Antenna information described in section 2.1 of this report, and there is no other antenna than that furnished by the responsible party shall be used with the device.

16. Photos of the EUT

Please refer to appendix I.

END OF REPORT