



FCC AND ISED CERTIFICATION TEST REPORT

FOR

Applicant	:	Harman International Industries, Inc.
Address	:	8500 Balboa Boulevard, Northridge, CA 91329, UNITED STATES
Equipment under Test	:	Portable Bluetooth Speaker
Model No.	:	XTREME 3N
Trade Mark	:	JBL
FCC ID	:	APIJBLXTREME3N
IC	:	6132A-JBLXTREME3N
Manufacturer	:	Harman International Industries, Inc.
Address	:	8500 Balboa Boulevard, Northridge, CA 91329, UNITED STATES

Issued By: Dongguan Dongdian Testing Service Co., Ltd.

Add.: No. 17, Zongbu Road 2, Songshan Lake Sci&Tech, Industry Park,
Dongguan City, Guangdong Province, China, 523808

Tel.: +86-0769-38826678, **E-mail:** ddt@dgddt.com, <http://www.dgddt.com>

REPORT

Table of Contents

	Test report declares.....	4
1.	Summary of Test Results.....	5
2.	General Test Information	7
2.1.	Description of EUT	7
2.2.	Accessories of EUT.....	8
2.3.	Assistant equipment used for test.....	8
2.4.	Block diagram of EUT configuration for test	8
2.5.	Deviations of test standard.....	8
2.6.	Test environment conditions	9
2.7.	Test laboratory	9
2.8.	Measurement uncertainty.....	9
3.	Equipment Used During Test.....	10
4.	Radiated Emission	11
4.1.	Block diagram of test setup.....	11
4.2.	Limit	12
4.3.	Test Procedure	14
4.4.	Test result.....	15
5.	Power Line Conducted Emission.....	24
5.1.	Block diagram of test setup.....	24
5.2.	Power line conducted emission limits	24
5.3.	Test procedure	24
5.4.	Test result.....	25
6.	Test Setup Photograph	34
7.	Photos of the EUT	35

Test Report Declare

Applicant	:	Harman International Industries, Inc.
Address	:	8500 Balboa Boulevard, Northridge, CA 91329, UNITED STATES
Equipment under Test	:	Portable Bluetooth Speaker
Model No.	:	XTREME 3N
Trade Mark	:	JBL
Manufacturer	:	Harman International Industries, Inc.
Address	:	8500 Balboa Boulevard, Northridge, CA 91329, UNITED STATES

Test Standard Used:

FCC Rules and Regulations Part 15 Subpart C, RSS-247 Issue 2 February 2017.

Test Procedure Used:

ANSI C63.10:2013, RSS-Gen Issue 5, Apr. 2018, Amendment 2 (February 2021)

We Declare:

The equipment described above is tested by Dongguan Dongdian Testing Service Co., Ltd. and in the configuration tested the equipment complied with the standards specified above. The test results are contained in this test report and Dongguan Dongdian Testing Service Co., Ltd. is assumed of full responsibility for the accuracy and completeness of these tests.

After test and evaluation, our opinion is that the equipment provided for test compliance with the requirement of the above FCC&ISED standards.

Report No.:	DDT-R22042404-2E01		
Date of Receipt:	Apr. 20, 2022	Date of Test:	Apr. 20, 2022 ~ Jun. 17, 2022

Prepared By:

Bobo Chen

Bobo Chen/Engineer

Approved By:



Damon Hu/EMC Manager

Note: This report applies to above tested sample only. This report shall not be reproduced in parts without written approval of Dongguan Dongdian Testing Service Co., Ltd.

Revision History

Rev.	Revisions	Issue Date	Revised By
---	Initial issue	Jun. 17, 2022	

1. Summary of Test Results

Description of Test Item	Standard	Verdict
Radiated Emission	FCC Part 15: 15.209 FCC Part 15: 15.247(d) ANSI C63.10:2013 RSS-247 Issue 2 RSS-Gen Issue 5	Pass
Power Line Conducted Emissions	FCC Part 15: 15.207 ANSI C63.10:2013 RSS-Gen Issue 5	Pass

Note:

- a. This report changed contents of note 1 and note 2 based on the report DDT-R20052205-4E4, this change based on engineering judgment that only Radiated Emission (below 1 GHz) and Power Line Conducted Emissions need to test.
- b. Please refer to report DDT-R20052205-4E4 for the other original data.

Note 1: The contents of this change are shown in the following table.

1	AMP amplifier gain changed from 20DB to 26DB		
	1)	R11 changed from 51K to 47K	
		R13 changed from 51K to 75K	
	2)	R108 changed from NC to 100K	
R141 changed from 5.6K to 20K			
2	DAC circuit modification		
	1)	C181, C179 changed from 2.8K to 1.1K	
	2)	C84, C83 changed from 2.8K to NC empty stickers	
	3)	C70, C71 changed from 3K to 0R	
	4)	C77, C80, C182, C236 package changed from 0603 to 0402	
	5)	U4 is changed to empty paste, and the surrounding devices are changed to empty paste	
		R46, R48, R49, R50, R51, R52, R43, R42, R41, R34, R37	
C63, C64, C74, C76, C72, C73, C75, C65, C68, C69			
3	FB14, FB17		
	DSP circuit OUT1:WF_L OU2:WF_R		
4	1)	Increase R372=0R R395=0R	
	Modification of BT part to increase software version compatibility		
5	1)	Increase R418=10K R404 reserved grounding resistance NC	
	0R resistance item delete		
	1)	BT page: delete R197, R254, connect directly on PCB	
	2)	PD page: R273, R275, R278, R412, R342, R336, R417	
		R327, R328, R334, R422 deleted, directly connected on the PCB	
	3)	CHARGE page: delete R3, R12, R79, R80, connect directly on the PCB	
4)	DSP page: R84 is changed from 0R to delete, and it is directly connected on the PCB		
	R250, R100, R267 are changed from 0R to delete, and they are directly connected on the PCB		
5)	AMP page: R229, R201, R222, R221, R180, R202, R121, R119, R24		
	Change from 0R to delete, connect directly on the PCB		
6	Other special deletion		

	1)	Delete some useless USB devices
		C148, C302 changed from 22PF to NC (not available for reduced price version)
		FB15, FB13 changed from 300R/100M to NC
	2)	AMP mute circuit components deleted
		R28, R30, Q1, R27, R15 delete
		R183 delete
7	1)	USB chip change
		U5 component original TPS2546RTER changed to CW3048BAAQ

Note 2: Four proposals have been submitted this time, the contents of this change are shown in the following table.

Scenario 1	CR4-SINO GP CELL	a. SDI Battery cell to GP battery cell (TI&SINO)
Scenario 2	CR4-TI GP CELL	
Scenario 3	CR2+CR3+SINO GP CELL	1) SDI Battery cell to GP battery cell (TI&SINO) 2) In total 8 IC's replacements
Scenario 4	CR2+CR3+TI GP CELL	

The details of IC changed in Scenario 3 and Scenario 4 are as follows:

IC	Manufacturer	Model
OP amp	TI	TS2278A
DC-DC boost chip	TI	ETA1038
DC-DC boost chip	TI	JW5060T
DC-DC boost chip	Silergy	JW5060T
USB Power Delivery Protocol chip	TI	SC1833
Battery charge management chip	TI	SC1896
BT CHIP	Shenzhen Jingxun Technology Co., Ltd.	SPIL CHIP (Chip package changes)
Logic IC	Silego	LS4V44057V

2. General Test Information

2.1. Description of EUT

EUT* Name	: Portable Bluetooth Speaker
Model Number	: XTREME 3N
EUT Function Description	: Please reference user manual of this device
Power Supply	: DC 5V/9V/12V/15V/20V ---3.0A from external AC Adapter DC 7.26 V Polymer Li-ion built-in battery
Radio Specification	: Bluetooth V5.1
Operation Frequency	: 2402 MHz - 2480 MHz
Modulation	: GFSK, $\pi/4$ -DQPSK, 8DPSK
Data Rate	: 1 Mbps, 2 Mbps, 3 Mbps
Antenna Gain	: Dedicated FPC antenna, maximum PK gain: 2.24 dBi
Sample Type	: Series production
Sample Number	: S22042404-15, S22042404-20, S22042404-46, S22042404-45

Note: EUT is the ab. of equipment under test.

Channel information					
Channel	Frequency (MHz)	Channel	Frequency (MHz)	Channel	Frequency (MHz)
0	2402	27	2429	54	2456
1	2403	28	2430	55	2457
2	2404	29	2431	56	2458
3	2405	30	2432	57	2459
4	2406	31	2433	58	2460
5	2407	32	2434	59	2461
6	2408	33	2435	60	2462
7	2409	34	2436	61	2463
8	2410	35	2437	62	2464
9	2411	36	2438	63	2465
10	2412	37	2439	64	2466
11	2413	38	2440	65	2467
12	2414	39	2441	66	2468
13	2415	40	2442	67	2469
14	2416	41	2443	68	2470
15	2417	42	2444	69	2471
16	2418	43	2445	70	2472
17	2419	44	2446	71	2473
18	2420	45	2447	72	2474
19	2421	46	2448	73	2475
20	2422	47	2449	74	2476
21	2423	48	2450	75	2477
22	2424	49	2451	76	2478
23	2425	50	2452	77	2479
24	2426	51	2453	78	2480
25	2427	52	2454		

26	2428	53	2455	
----	------	----	------	--

2.2. Accessories of EUT

Description of Accessories	Manufacturer	Model number	Description	Remark
AC Adapter	Shenzhen JingQuanHua & Everrise Intelligent Electric Co., Ltd.	NSA60EU-2003000 (PD60W)	Input: 100-240V ~ 50/60 Hz 1.5A Output: 5.0V---3.0A, 9.0V---3.0A, 12.0V---3.0A, 15.0V---3.0A, 20.0V---3.0A	N/A

2.3. Assistant equipment used for test

Assistant equipment	Manufacturer	Model number	EMC Compliance	SN
/	/	/	/	/

2.4. Block diagram of EUT configuration for test

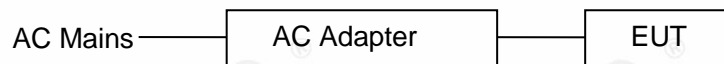

Test software: FCCTool.exe

The test software was used to control EUT work in Continuous Tx mode, and select test channel, wireless mode as below table.

Tested mode, channel, information			
Mode	Setting Tx Power	Channel	Frequency (MHz)
GFSK hopping on Tx mode	/	CH0 to CH78	2402 to 2480
$\pi/4$ -DQPSK hopping on Tx mode	/	CH0 to CH78	2402 to 2480
8DPSK hopping on Tx mode	/	CH0 to CH78	2402 to 2480
GFSK hopping off Tx mode	/	CH0	2402
	/	CH39	2441
	/	CH78	2480
$\pi/4$ -DQPSK hopping off Tx mode	/	CH0	2402
	/	CH39	2441
	/	CH78	2480
8DPSK hopping off Tx mode	/	CH0	2402
	/	CH39	2441
	/	CH78	2480

2.5. Deviations of test standard

No deviation.

2.6. Test environment conditions

During the measurement the environmental conditions were within the listed ranges:

Temperature range:	21-25 °C
Humidity range:	40-75%
Pressure range:	86-106 kPa

2.7. Test laboratory

Dongguan Dongdian Testing Service Co., Ltd.

Add.: No. 17, Zongbu Road 2, Songshan Lake Sci&Tech, Industry Park, Dongguan City, Guangdong Province, China, 523808.

Tel.: +86-0769-38826678, <http://www.dgddt.com>, Email: ddt@dgddt.com.

CNAS Accreditation No. L6451; A2LA Accreditation Number: 3870.01

FCC Designation Number: CN1182, Test Firm Registration Number: 540522

Innovation, Science and Economic Development Canada Site Registration Number: 10288A

Conformity Assessment Body identifier: CN0048

VCCI facility registration number: C-20087, T-20088, R-20123, G-20118

2.8. Measurement uncertainty

Test Item	Uncertainty
Bandwidth	1.1%
Peak Output Power (Conducted) (Spectrum analyzer)	0.86 dB (10 MHz ≤ f < 3.6 GHz);
	1.38 dB (3.6 GHz ≤ f < 8 GHz)
Peak Output Power (Conducted) (Power Sensor)	0.74 dB
Power Spectral Density	0.74 dB (10 MHz ≤ f < 3.6 GHz);
	1.38 dB (3.6 GHz ≤ f < 8 GHz)
Frequencies Stability	6.7 x 10 ⁻⁸ (Antenna couple method)
	5.5 x 10 ⁻⁸ (Conducted method)
Conducted spurious emissions	0.86 dB (10 MHz ≤ f < 3.6 GHz);
	1.40 dB (3.6 GHz ≤ f < 8 GHz)
	1.66 dB (8 GHz ≤ f < 22 GHz)
Uncertainty for radio frequency (RBW < 20 kHz)	3x10 ⁻⁸
Temperature	0.4 °C
Humidity	2 %
Uncertainty for Radiation Emission test (30 MHz - 1 GHz)	4.70 dB (Antenna Polarize: V)
	4.84 dB (Antenna Polarize: H)
Uncertainty for Radiation Emission test (1 GHz - 40 GHz)	4.10 dB (1 - 6 GHz)
	4.40 dB (6 GHz - 18 GHz)
	3.54 dB (18 GHz - 26 GHz)
	4.30 dB (26 GHz - 40 GHz)
Uncertainty for Power line conduction emission test	3.72dB (9KHz-150KHz)
	3.32 dB (150 kHz - 30 MHz)
Note: This uncertainty represents an expanded uncertainty expressed at approximately the 95% confidence level using a coverage factor of k=2.	

3. Equipment Used During Test

Equipment	Manufacturer	Model No.	Serial No.	Last Cal.	Cal. Interval
☑Radiation 3#chamber					
EMI Test Receiver	R&S	ESU	100472	Jun. 01, 2021 May 18, 2022	1 Year
Spectrum analyzer	Agilent	E4447A	MY50180031	Jun. 01, 2021 May 18, 2022	1 Year
Active Loop antenna	Schwarzbeck	FMZB-1519	1519-038	Sep. 19, 2021	1 Year
Trilog Broadband Antenna	Schwarzbeck	VULB 9163	01429	Aug. 07, 2021	1 Year
Double Ridged Horn Antenna	Schwarzbeck	BBHA9120	02108	Jul. 17, 2021	1 Year
Broad Band Horn Antenna	Schwarzbeck	BBHA 9170	790	May 08, 2021 May 06, 2022	1 Year
Pre-amplifier	COM-POWER	PAM-118A	18040084	Sep. 02, 2021	1 Year
Pre-amplifier	COM-POWER	PAM-840A	461369	Apr. 11, 2022	1 Year
Test software	Audix	E3	V 6.1.1.1	N/A	N/A
☑Power Line Conducted Emissions Test 1#					
Test Receiver	R&S	ESCI	100551	Sep. 02, 2021	1 Year
LISN 1	R&S	ENV216	101109	Sep. 02, 2021	1 Year
LISN 2	R&S	ESH2-Z5	100309	Sep. 02, 2021	1 Year
Pulse Limiter	R&S	ESH3-Z2	101242	Sep. 02, 2021	1 Year
CE Cable 1	HUBSER	N/A	W10.01	Sep. 02, 2021	1 Year
LISN 3	SCHWARZBECK	NSLK 8163	00017	Sep. 02, 2021	1 Year
Test software	Audix	E3	V 6.11111b	N/A	N/A

4. Radiated Emission

4.1. Block diagram of test setup

In 3 m Anechoic Chamber, test setup diagram for 9 kHz - 30 MHz:

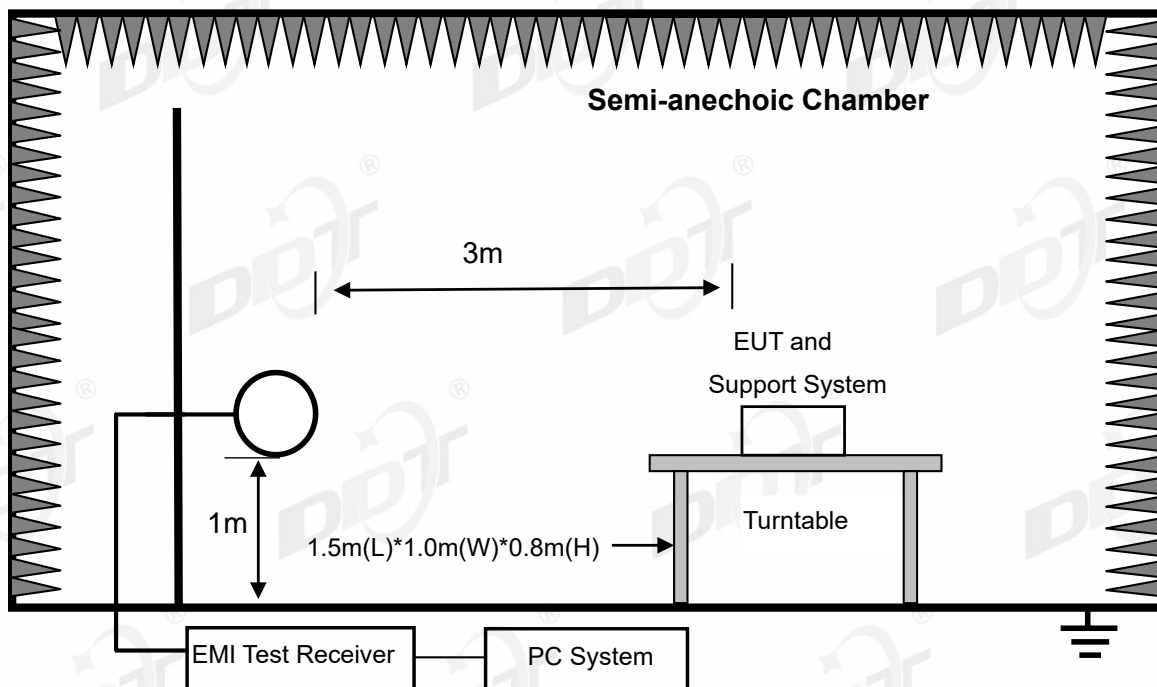

In 3 m Anechoic Chamber, test setup diagram for 30 MHz - 1 GHz:

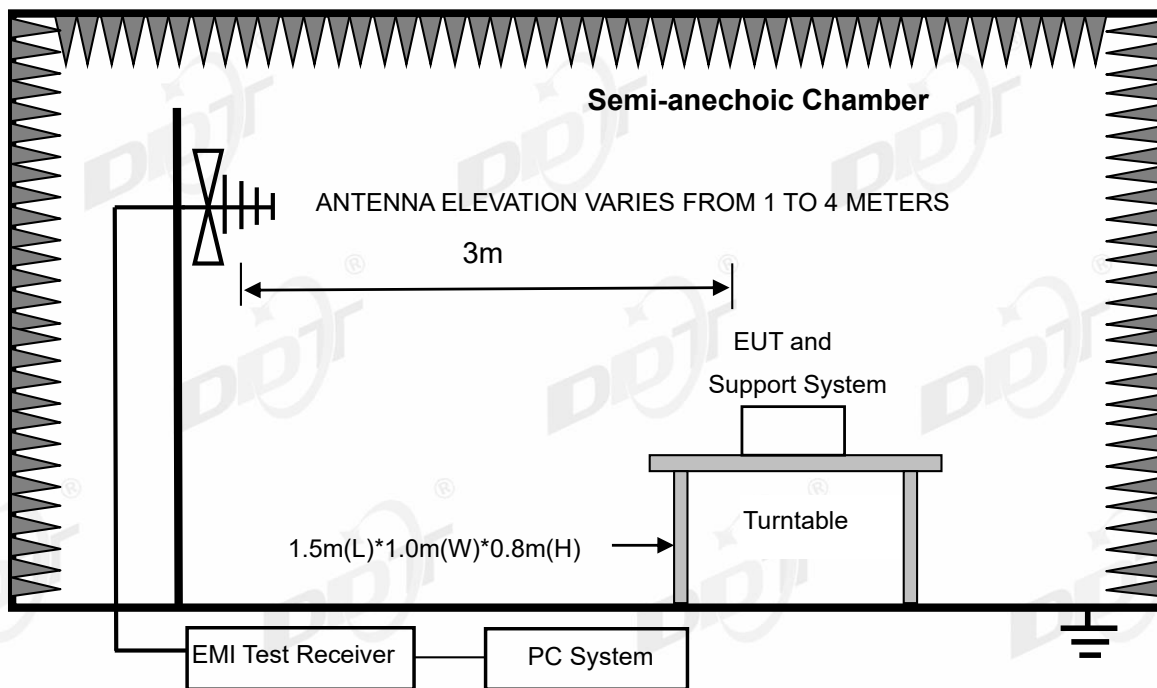

In 3 m Anechoic Chamber, test setup diagram for frequency above 1 GHz:

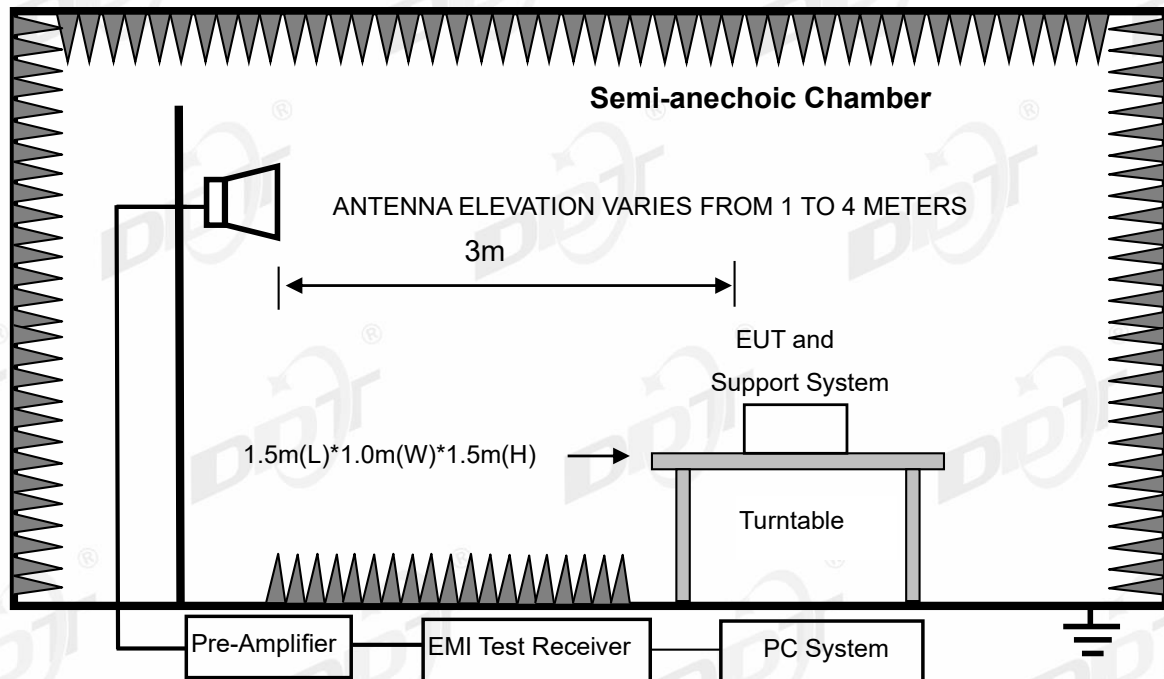

Note: For harmonic emissions test an appropriate high pass filter was inserted in the input port of AMP.

4.2. Limit

(1) FCC 15.205 Restricted frequency band

MHz	MHz	MHz	GHz
0.090-0.110	16.42-16.423	399.9-410	4.5-5.15
¹ 0.495-0.505	16.69475-16.69525	608-614	5.35-5.46
2.1735-2.1905	16.80425-16.80475	960-1240	7.25-7.75
4.125-4.128	25.5-25.67	1300-1427	8.025-8.5
4.1772&4.1775	37.5-38.25	1435-1626.5	9.0-9.2
4.2072&4.20775	73-74.6	1645.5-1646.5	9.3-9.5
6.215-6.218	74.8-75.2	1660-1710	10.6-12.7
6.26775-6.26825	108-121.94	1718.8-1722.2	13.25-13.4
6.31175-6.31225	123-138	2200-2300	14.47-14.5
8.291-8.294	149.9-150.05	2310-2390	15.35-16.2
8.362-8.366	156.52475-156.52525	2483.5-2500	17.7-21.4
8.37625-8.38675	156.7-156.9	2690-2900	22.01-23.12
8.41425-8.41475	162.0125-167.17	3260-3267	23.6-24.0
12.29-12.293	167.72-173.2	3332-3339	31.2-31.8
12.51975-12.52025	240-285	3345.8-3358	36.43-36.5
12.57675-12.57725	322-335.4	3600-4400	(²)
13.36-13.41			

¹Until February 1, 1999, this restricted band shall be 0.490-0.510 MHz.

²Above 38.6

RSS-Gen section 8.10 Restricted frequency bands*

MHz	MHz	MHz	GHz
0.090-0.110	12.51975-12.52025	240-285	3.5-4.4
0.495-0.505	12.57675-12.57725	322-335.4	4.5-5.15
2.1735-2.1905	13.36-13.41	399.9-410	5.35-5.46
3.020-3.026	16.42-16.423	608-614	7.25-7.75
4.125-4.128	16.69475-16.69525	960-1427	8.025-8.5
4.1772&4.17775	16.80425-16.80475	1435-1626.5	9.0-9.2
4.2072&4.20775	25.5-25.67	1645.5-1646.5	9.3-9.5
5.677-5.683	37.5-38.25	1660-1710	10.6-12.7
6.215-6.218	73-74.6	1718.8-1722.2	13.25-13.4
6.26775-6.26825	74.8-75.2	2200-2300	14.47-14.5
6.31175-6.31225	108-138	2310-2390	15.35-16.2
8.291-8.294	149.9-150.05	2483.5-2500	17.7-21.4
8.362-8.366	156.52475-156.52525	2655-2900	22.01-23.12
8.37625-8.38675	156.7-156.9	3260-3267	23.6-24.0
8.41425-8.41475	162.0125-167.17	3332-3339	31.2-31.8
12.29-12.293	167.72-173.2	3345.8-3358	36.43-36.5
			Above 38.6

* Certain frequency bands listed in table and in bands above 38.6 GHz are designated for licence-exempt applications. These frequency bands and the requirements that apply to related devices are set out in the 200 and 300 series of RSSs.

(2) FCC 15.209 Limit & RSS-Gen section 8.9 Limit

FREQUENCY MHz	DISTANCE Meters	FIELD STRENGTHS LIMIT	
		$\mu\text{V}/\text{m}$	$\text{dB}(\mu\text{V})/\text{m}$
0.009 ~ 0.490	300	2400/F(kHz)	67.6-20log(F)
0.490 ~ 1.705	30	24000/F(kHz)	87.6-20log(F)
1.705 ~ 30.0	30	30	29.54
30 ~ 88	3	100	40.0
88 ~ 216	3	150	43.5
216 ~ 960	3	200	46.0
960 ~ 1000	3	500	54.0
Above 1000	3	74.0 dB(μV)/m (Peak) 54.0 dB(μV)/m (Average)	

Note: (1) The emission limits shown in the above table are based on measurements employing a CISPR QP detector except for the frequency bands 9 - 90 kHz, 110 - 490 kHz and above 1000 MHz, radiated emissions limits in these three bands are based on measurements employing an average detector.

(2) At frequencies below 30 MHz, measurement may be performed at a distance closer than that specified, and the limit at closer measurement distance can be extrapolated by below formula:

$$\text{Limit}_{3\text{m}}(\text{dB}\mu\text{V}/\text{m}) = \text{Limit}_{30\text{m}}(\text{dB}\mu\text{V}/\text{m}) + 40\text{Log}(30\text{m}/3\text{m})$$

(3) Limit for this EUT

The emissions appearing within 15.205 restricted frequency bands shall not exceed the limits shown in 15.209, and the emissions appearing within RSS-Gen section 8.10 Restricted frequency

bands shall not exceed the limits shown in RSS-Gen section 8.9, all the other emissions shall be at least 20 dB below the fundamental emissions or comply with 15.209 limits and RSS-Gen section 8.9 limits.

4.3. Test Procedure

- (1) EUT was placed on a non-metallic table, 80 cm above the ground plane inside a semi-anechoic chamber for below 1G and 150 cm above the ground plane inside a fully-anechoic chamber for above 1G.
- (2) Test antenna was located 3 m from the EUT on an adjustable mast, and the antenna used as below table.

Test frequency range	Test antenna used	Test antenna distance
9 kHz - 30 MHz	Active Loop antenna	3 m
30 MHz - 1 GHz	Trilog Broadband Antenna	3 m
1 GHz - 18 GHz	Double Ridged Horn Antenna (1 GHz - 18 GHz)	3 m
18 GHz - 40 GHz	Horn Antenna (18 GHz - 40 GHz)	1 m

According to ANSI C63.10:2013 clause 6.4.4.2 and 6.5.3, for measurements below 30 MHz, the loop antenna was positioned with its plane vertical from the EUT and rotated about its vertical axis for maximum response at each azimuth position around the EUT. And the loop antenna also is positioned with its plane horizontal at the specified distance from the EUT. The center of the loop is 1 m above the ground. For measurement above 30 MHz, the trilog Broadband Antenna or Horn Antenna was located 3 m from EUT, Measurements were made with the antenna positioned in both the horizontal and vertical planes of Polarization, and the measurement antenna was varied from 1 m to 4 m. in height above the reference ground plane to obtain the maximum signal strength.

- (3) Below pre-scan procedure was first performed in order to find prominent frequency spectrum radiated emissions from 9 kHz to 25 GHz:

- (a) Scanning the peak frequency spectrum with the antenna specified in step (3), and the EUT was rotated 360 degree, the antenna height was varied from 1 m to 4 m (Except loop antenna, it's fixed 1 m above ground.)

- (b) Change work frequency or channel of device if practicable.

- (c) Change modulation type of device if practicable.

- (d) Change power supply range from 85% to 115% of the rated supply voltage

- (e) Rotated EUT through three orthogonal axes to determine the attitude of EUT arrangement produces highest emissions.

Spectrum frequency from 9 kHz to 25 GHz (tenth harmonic of fundamental frequency) was investigated, and no any obvious emission were detected from 18 GHz to 25 GHz, so below final test was performed with frequency range from 9 kHz to 18 GHz.

- (4) For final emissions measurements at each frequency of interest, the EUT was rotated and the antenna height was varied between 1 m and 4 m in order to maximize the emission. Measurements in both horizontal and vertical polarities were made and the data was recorded. In order to find the maximum emission, the relative positions of equipment and all of the interface cables were changed according to ANSI C63.10:2013 on Radiated Emission test.
- (5) The emissions from 9 kHz to 1 GHz were measured based on CISPR QP detector except for the frequency bands 9 - 90 kHz, 110 - 490 kHz, for emissions from 9 kHz - 90 kHz, 110 kHz - 490 kHz and above 1 GHz were measured based on average detector, for emissions above 1 GHz, peak emissions also be measured and need comply with Peak limit.
- (6) The emissions from 9 kHz to 1 GHz, QP or average values were measured with EMI receiver with below RBW.

Frequency band	RBW
9 kHz - 150 kHz	200 Hz
150 kHz - 30 MHz	9 kHz
30 MHz - 1 GHz	120 kHz

- (7) For emissions above 1GHz, both Peak and Average level were measured with Spectrum Analyzer, and the RBW is set at 1 MHz, VBW is set at 3 MHz for Peak measure; According ANSI C63.10:2013 clause 4.1.4.2.2 procedure for average measure.
- (8) X axis, Y axis, Z axis are tested, and worse setup X axis is reported.

4.4. Test result

Pass. (See below detailed test result)

All the emissions except fundamental emission from 9 kHz to 25 GHz were comply with 15.209 limits and RSS-Gen section 8.9 limits.

Note1: According exploratory test, the emission levels are 20 dB below the limit detected from 9 kHz to 30 MHz and 18 GHz to 25 GHz, so the final test was performed with frequency range from 30 MHz to 18 GHz and recorded in below.

Note2: For emissions below 1 GHz, according exploratory explorer test, when change Tx mode and channel, have no distinct influence on emissions level, so for emissions below 1 GHz, the final test was only performed with EUT working in GFSK, Tx 2402 MHz mode.

Radiated Emission test (below 1 GHz)

TR-4-E-009 Radiated Emission Test Result

Test Site : DDT 3m Chamber 3#

D:\E3 6.111\2022 Report Data\Q22042404-2E XTREME3N\FCC BELOW 1G.EM6

Test Date : 2022-05-13

Tested By : Kennys Zhang

EUT : Portable Bluetooth Speaker

Model Number : XTREME 3N

Power Supply : Battery

Test Mode : Tx mode

Condition : Temp:22.2°C,Humi:59.2%,Press:100.1kPa Antenna/Distance : 2021 VLUB 9163 3#/3m/VERTICAL

Memo : Scenario 1 (CR4-SINO GP CELL)

Data:

1

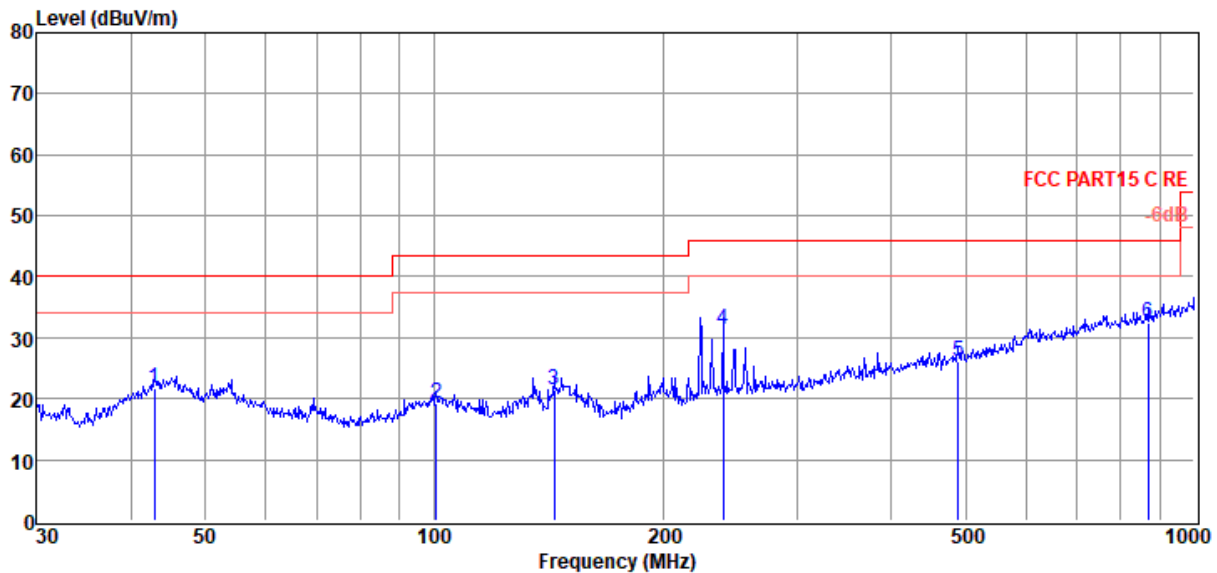

Item (Mark)	Freq. (MHz)	Read Level (dBμV)	Antenna Factor (dB/m)	Cable Loss (dB)	Result Level (dBUV/m)	Limit Line (dBμV/m)	Over Limit (dB)	Detector	Polarization
1	42.90	3.76	14.34	3.63	21.73	40.00	-18.27	QP	VERTICAL
2	100.58	3.60	11.56	3.98	19.14	43.50	-24.36	QP	VERTICAL
3	143.83	9.44	7.80	4.23	21.47	43.50	-22.03	QP	VERTICAL
4	239.99	14.27	12.50	4.62	31.39	46.00	-14.61	QP	VERTICAL
5	489.03	4.18	16.58	5.45	26.21	46.00	-19.79	QP	VERTICAL
6	869.13	4.68	21.48	6.39	32.55	46.00	-13.45	QP	VERTICAL

Note: 1. Result Level = Read Level + Antenna Factor + Cable loss.

2. If Peak Result complies with QP limit, QP Result is deemed to comply with QP limit.

3. Test setup: RBW: 120 kHz, VBW: 300 kHz, Sweep time: auto.

TR-4-E-009 Radiated Emission Test Result

Test Site : DDT 3m Chamber 3#

D:\E3 6.111\2022 Report Data\Q22042404-2E XTREME3N\FCC BELOW 1G.EM6

Test Date : 2022-05-13

Tested By : Kennys Zhang

EUT : Portable Bluetooth Speaker

Model Number : XTREME 3N

Power Supply : Battery

Test Mode : Tx mode

Condition : Temp:22.2°C,Humi:59.2%,Press:100.1kPa

Antenna/Distance : 2021 VLUB 9163 3#/3m/HORIZONTAL

Memo : Scenario 1 (CR4-SINO GP CELL)

Data:
2

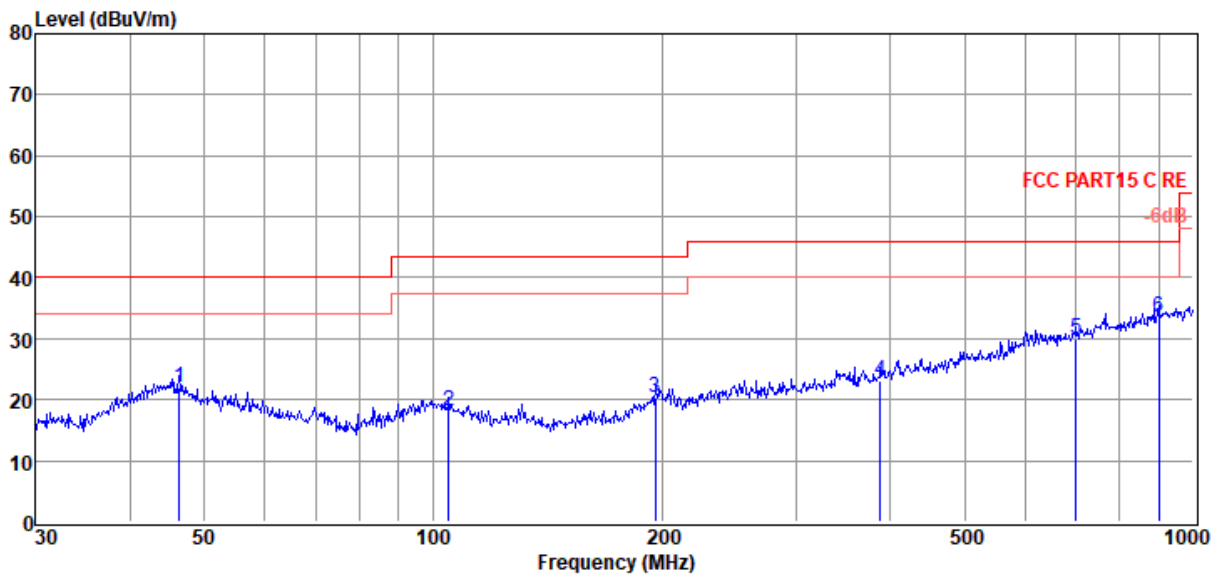

Item (Mark)	Freq. (MHz)	Read Level (dBµV)	Antenna Factor (dB/m)	Cable Loss (dB)	Result Level (dBµV/m)	Limit Line (dBµV/m)	Over Limit (dB)	Detector	Polarization
1	46.34	3.82	14.40	3.65	21.87	40.00	-18.13	QP	HORIZONTAL
2	104.90	3.13	11.12	4.01	18.26	43.50	-25.24	QP	HORIZONTAL
3	195.82	4.12	11.78	4.44	20.34	43.50	-23.16	QP	HORIZONTAL
4	387.99	2.87	15.22	5.12	23.21	46.00	-22.79	QP	HORIZONTAL
5	701.76	4.36	19.50	5.99	29.85	46.00	-16.15	QP	HORIZONTAL
6	900.15	4.99	22.10	6.48	33.57	46.00	-12.43	QP	HORIZONTAL

- Note: 1. Result Level = Read Level + Antenna Factor + Cable loss.
 2. If Peak Result complies with QP limit, QP Result is deemed to comply with QP limit.
 3. Test setup: RBW: 120 kHz, VBW: 300 kHz, Sweep time: auto.

TR-4-E-009 Radiated Emission Test Result

Test Site : DDT 3m Chamber 3#

D:\E3 6.111\2022 Report Data\Q22042404-2E XTREME3N NEW\FCC BELOW 1G.EM6

Test Date : 2022-05-23

Tested By : James Gan

EUT : Portable Bluetooth Speaker

Model Number : XTREME 3N

Power Supply : Battery

Test Mode : Tx mode

Condition : Temp:21.7°C,Humi:53.8%,Press:100.4kPa

Antenna/Distance : 2021 VLUB 9163 3#/3m/HORIZONTAL

Memo : Scenario 2 (CR4-TI GP CELL)

Data:
1

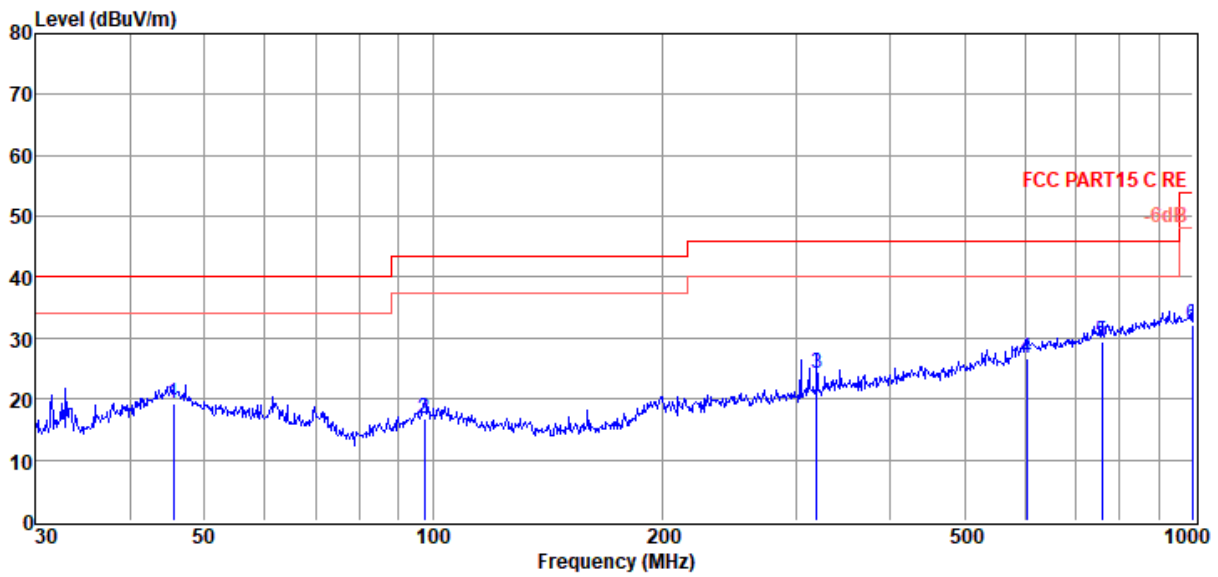

Item (Mark)	Freq. (MHz)	Read Level (dBµV)	Antenna Factor (dB/m)	Cable Loss (dB)	Result Level (dBµV/m)	Limit Line (dBµV/m)	Over Limit (dB)	Detector	Polarization
1	45.54	0.78	14.83	3.65	19.26	40.00	-20.74	QP	HORIZONTAL
2	97.46	1.34	11.45	3.97	16.76	43.50	-26.74	QP	HORIZONTAL
3	319.94	5.58	13.70	4.89	24.17	46.00	-21.83	QP	HORIZONTAL
4	603.54	1.80	19.17	5.75	26.72	46.00	-19.28	QP	HORIZONTAL
5	758.04	2.50	20.70	6.12	29.32	46.00	-16.68	QP	HORIZONTAL
6	996.50	2.96	22.43	6.82	32.21	54.00	-21.79	QP	HORIZONTAL

- Note: 1. Result Level = Read Level + Antenna Factor + Cable loss.
 2. If Peak Result complies with QP limit, QP Result is deemed to comply with QP limit.
 3. Test setup: RBW: 120 kHz, VBW: 300 kHz, Sweep time: auto.

TR-4-E-009 Radiated Emission Test Result

Test Site : DDT 3m Chamber 3#

D:\E3 6.111\2022 Report Data\Q22042404-2E XTREME3N NEW\FCC BELOW 1G.EM6

Test Date : 2022-05-23

Tested By : James Gan

EUT : Portable Bluetooth Speaker

Model Number : XTREME 3N

Power Supply : Battery

Test Mode : Tx mode

Condition : Temp:21.7°C,Humi:53.8%,Press:100.4kPa **Antenna/Distance** : 2021 VLUB 9163 3#/3m/VERTICAL

Memo : Scenario 2 (CR4-TI GP CELL)

Data:
2

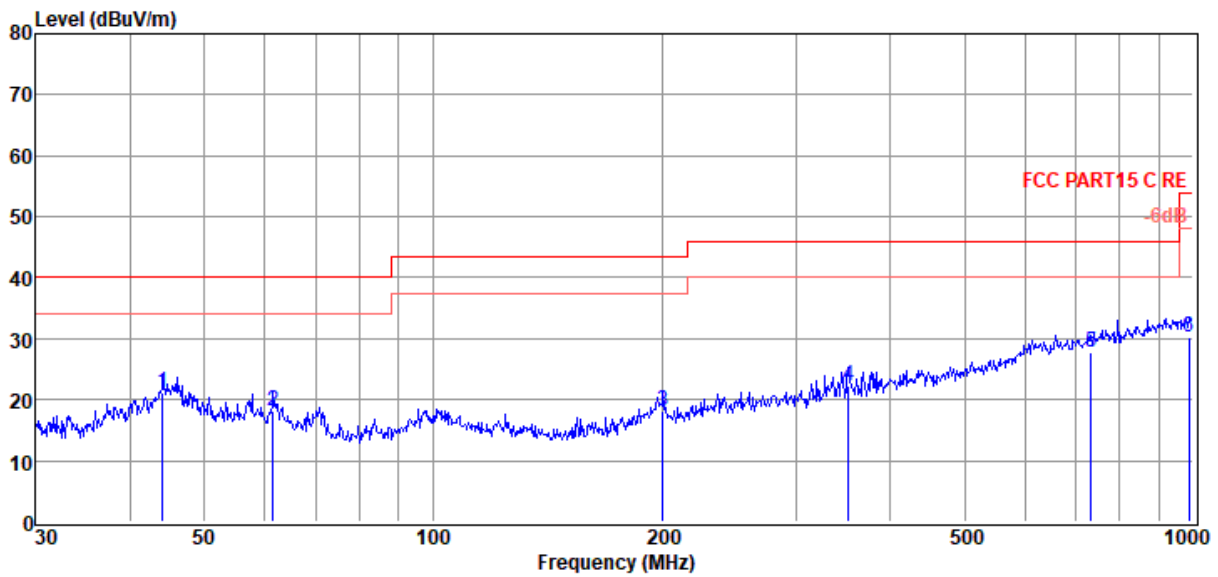

Item (Mark)	Freq. (MHz)	Read Level (dBμV)	Antenna Factor (dB/m)	Cable Loss (dB)	Result Level (dBμV/m)	Limit Line (dBμV/m)	Over Limit (dB)	Detector	Polarization
1	44.12	2.52	15.01	3.64	21.17	40.00	-18.83	QP	VERTICAL
2	61.56	4.20	10.28	3.76	18.24	40.00	-21.76	QP	VERTICAL
3	200.69	1.85	11.75	4.45	18.05	43.50	-25.45	QP	VERTICAL
4	351.71	2.33	15.07	5.00	22.40	46.00	-23.60	QP	VERTICAL
5	734.49	1.29	20.28	6.07	27.64	46.00	-18.36	QP	VERTICAL
6	986.07	1.17	22.40	6.77	30.34	54.00	-23.66	QP	VERTICAL

- Note: 1. Result Level = Read Level + Antenna Factor + Cable loss.
 2. If Peak Result complies with QP limit, QP Result is deemed to comply with QP limit.
 3. Test setup: RBW: 120 kHz, VBW: 300 kHz, Sweep time: auto.

TR-4-E-009 Radiated Emission Test Result

Test Site : DDT 3m Chamber 3# D:\E3 6.111\2022 Report Data\Q22042404-2E XTREME3N NEW\FCC BELOW 1G.EM6
Test Date : 2022-05-23 **Tested By** : James Gan
EUT : Portable Bluetooth Speaker **Model Number** : XTREME 3N
Power Supply : Battery **Test Mode** : Tx mode
Condition : Temp:21.7°C,Humi:53.8%,Press:100.4kPa **Antenna/Distance** : 2021 VLUB 9163 3#/3m/HORIZONTAL
Memo : Scenario 3 (CR2+CR3+SINO GP CELL)

Data:
1

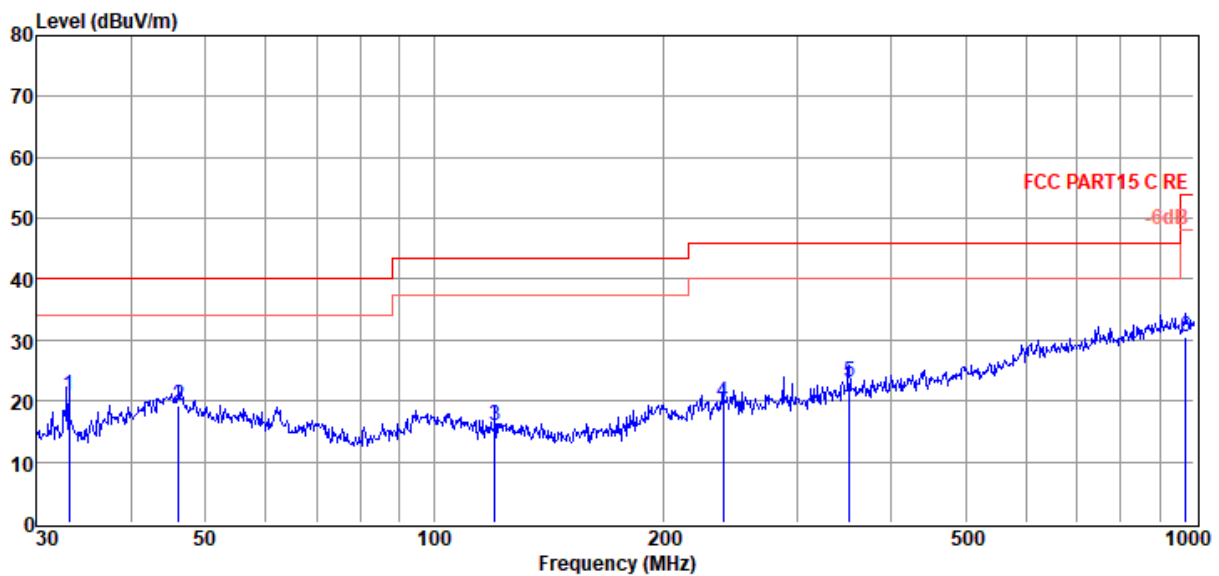

Item (Mark)	Freq. (MHz)	Read Level (dB μ V)	Antenna Factor (dB/m)	Cable Loss (dB)	Result Level (dB μ V/m)	Limit Line (dB μ V/m)	Over Limit (dB)	Detector	Polarization
1	33.10	8.49	8.89	3.57	20.95	40.00	-19.05	QP	HORIZONTAL
2	46.18	1.02	14.49	3.65	19.16	40.00	-20.84	QP	HORIZONTAL
3	120.28	2.75	9.10	4.11	15.96	43.50	-27.54	QP	HORIZONTAL
4	239.99	2.72	12.50	4.62	19.84	46.00	-26.16	QP	HORIZONTAL
5	351.71	2.89	15.07	5.00	22.96	46.00	-23.04	QP	HORIZONTAL
6	975.75	1.38	22.30	6.71	30.39	54.00	-23.61	QP	HORIZONTAL

Note: 1. Result Level = Read Level + Antenna Factor + Cable loss.

2. If Peak Result complies with QP limit, QP Result is deemed to comply with QP limit.

3. Test setup: RBW: 120 kHz, VBW: 300 kHz, Sweep time: auto.

TR-4-E-009 Radiated Emission Test Result

Test Site : DDT 3m Chamber 3#

D:\E3 6.111\2022 Report Data\Q22042404-2E XTREME3N
NEW\FCC BELOW 1G.EM6

Test Date : 2022-05-23

Tested By : James Gan

EUT : Portable Bluetooth Speaker

Model Number : XTREME 3N

Power Supply : Battery

Test Mode : Tx mode

Condition : Temp:21.7°C,Humi:53.8%,Press:100.4kPa **Antenna/Distance** : 2021 VLUB 9163 3#/3m/VERTICAL

Memo : Scenario 3 (CR2+CR3+SINO GP CELL)

Data:
2

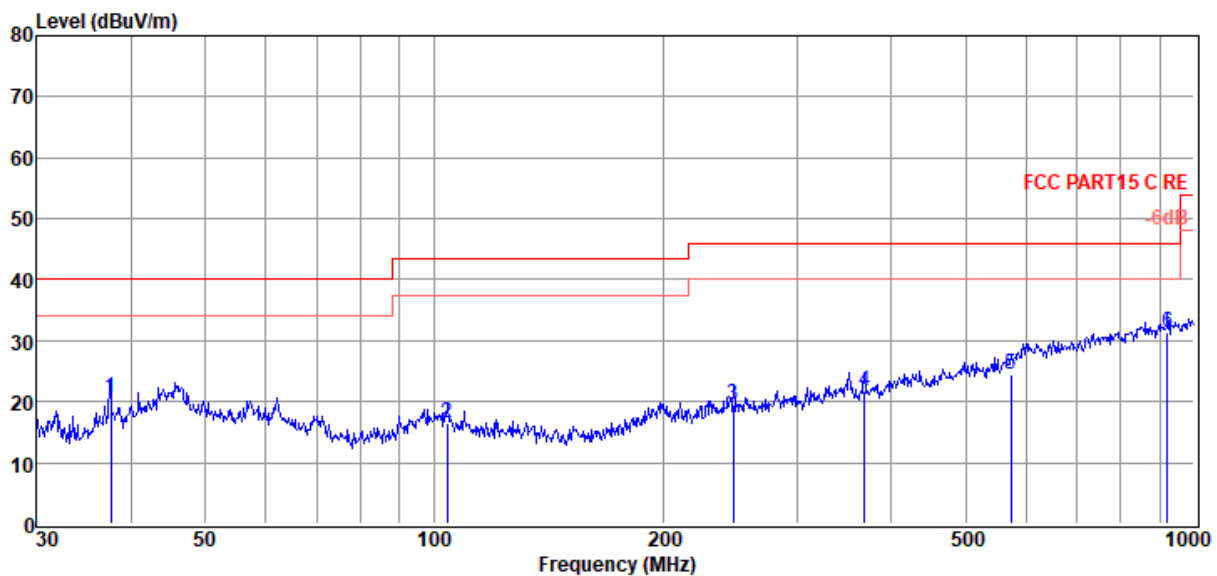

Item (Mark)	Freq. (MHz)	Read Level (dB μ V)	Antenna Factor (dB/m)	Cable Loss dB	Result Level (dB μ V/m)	Limit Line (dB μ V/m)	Over Limit (dB)	Detector	Polarization
1	37.55	6.37	10.74	3.60	20.71	40.00	-19.29	QP	VERTICAL
2	104.17	1.12	11.27	4.01	16.40	43.50	-27.10	QP	VERTICAL
3	247.68	2.29	12.50	4.65	19.44	46.00	-26.56	QP	VERTICAL
4	368.11	1.96	14.72	5.05	21.73	46.00	-24.27	QP	VERTICAL
5	574.63	0.81	18.09	5.66	24.56	46.00	-21.44	QP	VERTICAL
6	922.52	2.55	22.40	6.52	31.47	46.00	-14.53	QP	VERTICAL

Note: 1. Result Level = Read Level + Antenna Factor + Cable loss.

2. If Peak Result complies with QP limit, QP Result is deemed to comply with QP limit.

3. Test setup: RBW: 120 kHz, VBW: 300 kHz, Sweep time: auto.

TR-4-E-009 Radiated Emission Test Result

Test Site : DDT 3m Chamber 3#

D:\E3 6.111\2022 Report Data\Q22042404-2E XTREME3N
NEW\FCC BELOW 1G.EM6

Test Date : 2022-05-23

Tested By : James Gan

EUT : Portable Bluetooth Speaker

Model Number : XTREME 3N

Power Supply : Battery

Test Mode : Tx mode

Condition : Temp:21.7°C,Humi:53.8%,Press:100.4kPa **Antenna/Distance** : 2021 VLUB 9163 3#/3m/HORIZONTAL

Memo : Scenario 4 (CR2+CR3+TI GP CELL)

Data:

1

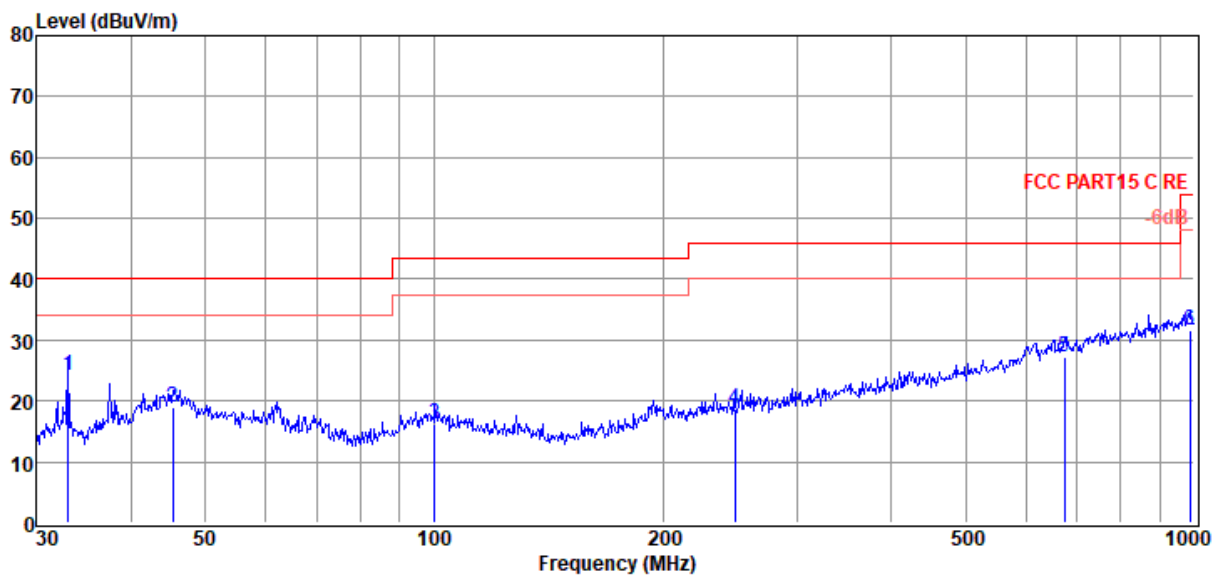

Item (Mark)	Freq. (MHz)	Read Level (dBμV)	Antenna Factor (dB/m)	Cable Loss dB	Result Level (dBUV/m)	Limit Line (dBUV/m)	Over Limit (dB)	Detector	Polarization
1	32.98	11.72	8.90	3.57	24.19	40.00	-15.81	QP	HORIZONTAL
2	45.38	0.28	14.91	3.65	18.84	40.00	-21.16	QP	HORIZONTAL
3	100.23	0.70	11.52	3.98	16.20	43.50	-27.30	QP	HORIZONTAL
4	248.55	1.66	12.50	4.65	18.81	46.00	-27.19	QP	HORIZONTAL
5	675.21	2.00	19.40	5.93	27.33	46.00	-18.67	QP	HORIZONTAL
6	986.07	2.51	22.40	6.77	31.68	54.00	-22.32	QP	HORIZONTAL

Note: 1. Result Level = Read Level + Antenna Factor + Cable loss.

2. If Peak Result complies with QP limit, QP Result is deemed to comply with QP limit.

3. Test setup: RBW: 120 kHz, VBW: 300 kHz, Sweep time: auto.

TR-4-E-009 Radiated Emission Test Result

Test Site : DDT 3m Chamber 3#

D:\E3 6.111\2022 Report Data\Q22042404-2E XTREME3N NEW\FCC BELOW 1G.EM6

Test Date : 2022-05-23

Tested By : James Gan

EUT : Portable Bluetooth Speaker

Model Number : XTREME 3N

Power Supply : Battery

Test Mode : Tx mode

Condition : Temp:21.7°C,Humi:53.8%,Press:100.4kPa **Antenna/Distance** : 2021 VLUB 9163 3#/3m/VERTICAL

Memo : Scenario 4 (CR2+CR3+TI GP CELL)

Data:
2

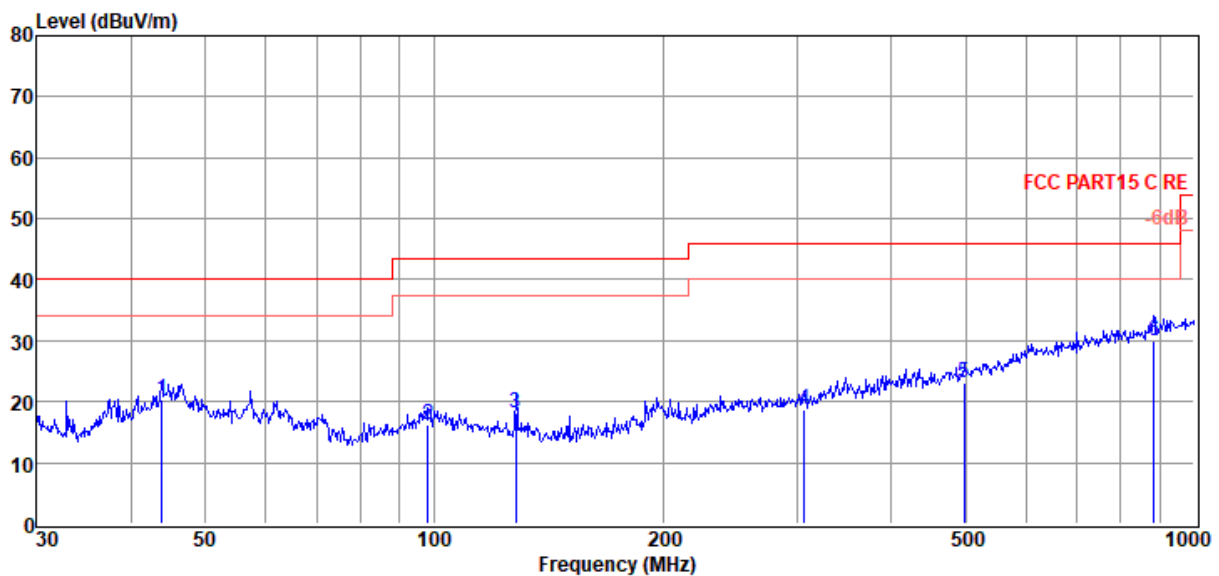

Item (Mark)	Freq. (MHz)	Read Level (dBμV)	Antenna Factor (dB/m)	Cable Loss (dB)	Result Level (dBμV/m)	Limit Line (dBμV/m)	Over Limit (dB)	Detector	Polarization
1	43.81	1.82	14.89	3.64	20.35	40.00	-19.65	QP	VERTICAL
2	98.14	0.61	11.50	3.97	16.08	43.50	-27.42	QP	VERTICAL
3	128.11	4.95	9.00	4.15	18.10	43.50	-25.40	QP	VERTICAL
4	306.75	0.50	13.34	4.85	18.69	46.00	-27.31	QP	VERTICAL
5	497.68	0.72	17.01	5.47	23.20	46.00	-22.80	QP	VERTICAL
6	884.50	1.87	21.79	6.44	30.10	46.00	-15.90	QP	VERTICAL

- Note: 1. Result Level = Read Level + Antenna Factor + Cable loss.
 2. If Peak Result complies with QP limit, QP Result is deemed to comply with QP limit.
 3. Test setup: RBW: 120 kHz, VBW: 300 kHz, Sweep time: auto.

5. Power Line Conducted Emission

5.1. Block diagram of test setup

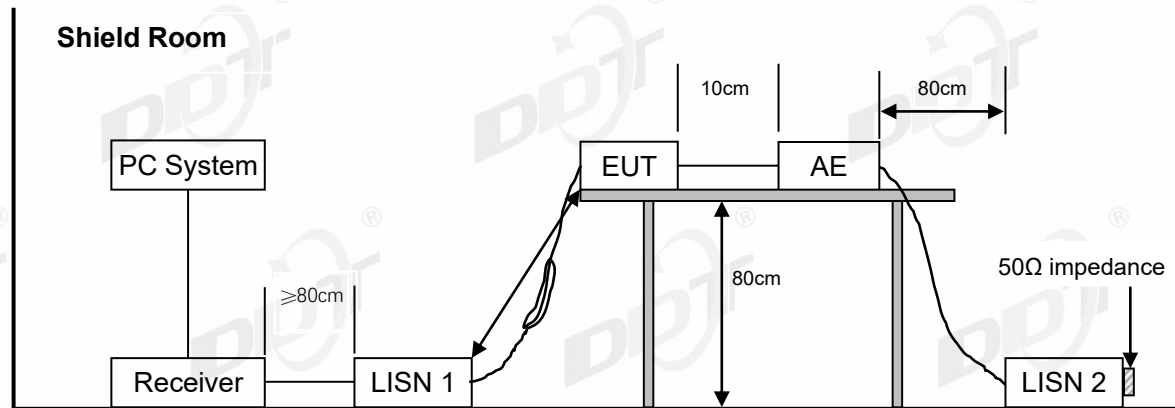

5.2. Power line conducted emission limits

Frequency	Quasi-Peak Level dB(μ V)	Average Level dB(μ V)
150 kHz ~ 500 kHz	66 ~ 56*	56 ~ 46*
500 kHz ~ 5 MHz	56	46
5 MHz ~ 30 MHz	60	50

Note 1: * Decreasing linearly with logarithm of frequency.

Note 2: The lower limit shall apply at the transition frequencies.

5.3. Test procedure

The EUT and Support equipment, if needed, were put placed on a non-metallic table, 80cm above the ground plane.

Configuration EUT to simulate typical usage as described in clause 2.4 and test equipment as described in clause 10.2 of this report.

All I/O cables were positioned to simulate typical actual usage as per ANSI C63.10.

All support equipment power received from a second LISN.

Emissions were measured on each current carrying line of the EUT using an EMI Test Receiver connected to the LISN powering the EUT.

The Receiver scanned from 150 kHz to 30 MHz for emissions in each of the test modes.

During the above scans, the emissions were maximized by cable manipulation.

The test mode(s) described in clause 2.4 were scanned during the preliminary test.

After the preliminary scan, we found the test mode producing the highest emission level.

The EUT configuration and worse cable configuration of the above highest emission levels were recorded for reference of the final test.

EUT and support equipment were set up on the test bench as per the configuration with highest

emission level in the preliminary test.

A scan was taken on both power lines, Neutral and Line, recording at least the six highest emissions.

Emission frequency and amplitude were recorded into a computer in which correction factors were used to calculate the emission level and compare reading to the applicable limit.

The test data of the worst-case condition(s) was recorded.

The bandwidth of test receiver is set at 9 kHz.

5.4. Test result

Pass. (See below detailed test result)

Note1: All emissions not reported below are too low against the prescribed limits.

Note2: "----" means Peak detection; "----" means Average detection.

Note3: Pre-test AC conducted emission at both voltage AC 120V/60Hz and AC 240V/50Hz, recorded worse case.

TR-4-E-010 Conducted Emission Test Result

Test Site : DDT 1# Shield Room D:\2022 CE report date\Q22042404-1\CE.EM6
Test Date : 2022-05-08 **Tested By** : Zhiyi Deng
EUT : Portable Bluetooth Speaker **Model Number** : XTREME 3N
Power Supply : AC 120V/60Hz **Test Mode** : Tx mode
Condition : TEMP:22.8°C, RH:53.6%, BP:101.4kPa **LISN** : 2021 1# ENV216/NEUTRAL
Memo : Scenario 1 (CR4-SINO GP CELL)

Data: 110

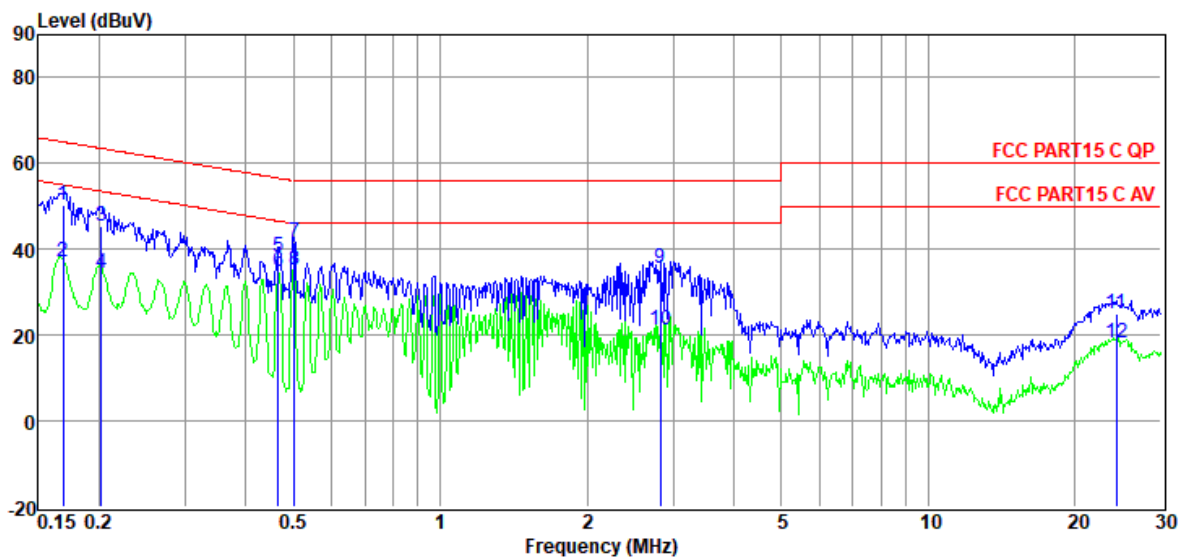

Item (Mark)	Freq. (MHz)	Read Level (dBμV)	LISN Factor (dB)	Cable Loss (dB)	Pulse Limiter Factor (dB)	Result Level (dBμV)	Limit Line (dBμV)	Over Limit (dB)	Detector	Phase
1	0.17	30.71	9.80	0.01	9.92	50.44	65.03	-14.59	QP	NEUTRAL
2	0.17	17.20	9.80	0.01	9.92	36.93	55.03	-18.10	Average	NEUTRAL
3	0.20	25.84	9.80	0.01	9.92	45.57	63.54	-17.97	QP	NEUTRAL
4	0.20	14.58	9.80	0.01	9.92	34.31	53.54	-19.23	Average	NEUTRAL
5	0.47	18.63	9.52	0.02	9.91	38.08	56.58	-18.50	QP	NEUTRAL
6	0.47	15.36	9.52	0.02	9.91	34.81	46.58	-11.77	Average	NEUTRAL
7	0.50	22.17	9.50	0.02	9.91	41.60	56.00	-14.40	QP	NEUTRAL
8	0.50	15.58	9.50	0.02	9.91	35.01	46.00	-10.99	Average	NEUTRAL
9	2.82	15.95	9.70	0.05	9.90	35.60	56.00	-20.40	QP	NEUTRAL
10	2.82	1.51	9.70	0.05	9.90	21.16	46.00	-24.84	Average	NEUTRAL
11	24.27	5.02	9.85	0.19	9.98	25.04	60.00	-34.96	QP	NEUTRAL
12	24.27	-1.96	9.85	0.19	9.98	18.06	50.00	-31.94	Average	NEUTRAL

Note:

1. Result Level = Read Level + LISN Factor + Pulse Limiter Factor + Cable loss.
2. If QP Result complies with AV limit, AV Result is deemed to comply with AV limit.
3. Test setup: RBW: 200 Hz (9 kHz—150 kHz), 9 kHz (150 kHz—30 MHz).
4. Step size: 80Hz (0.009MHz-0.15MHz), 4 kHz (0.15MHz-30MHz), Scan time: auto.

TR-4-E-010 Conducted Emission Test Result

Test Site : DDT 1# Shield Room D:\2022 CE report date\Q22042404-1\CE.EM6
Test Date : 2022-05-08 **Tested By** : Zhiyi Deng
EUT : Portable Bluetooth Speaker **Model Number** : XTREME 3N
Power Supply : AC 120V/60Hz **Test Mode** : Tx mode
Condition : TEMP:22.8°C, RH:53.6%, BP:101.4kPa **LISN** : 2021 1# ENV216/LINE
Memo : Scenario 1 (CR4-SINO GP CELL)

Data: 112

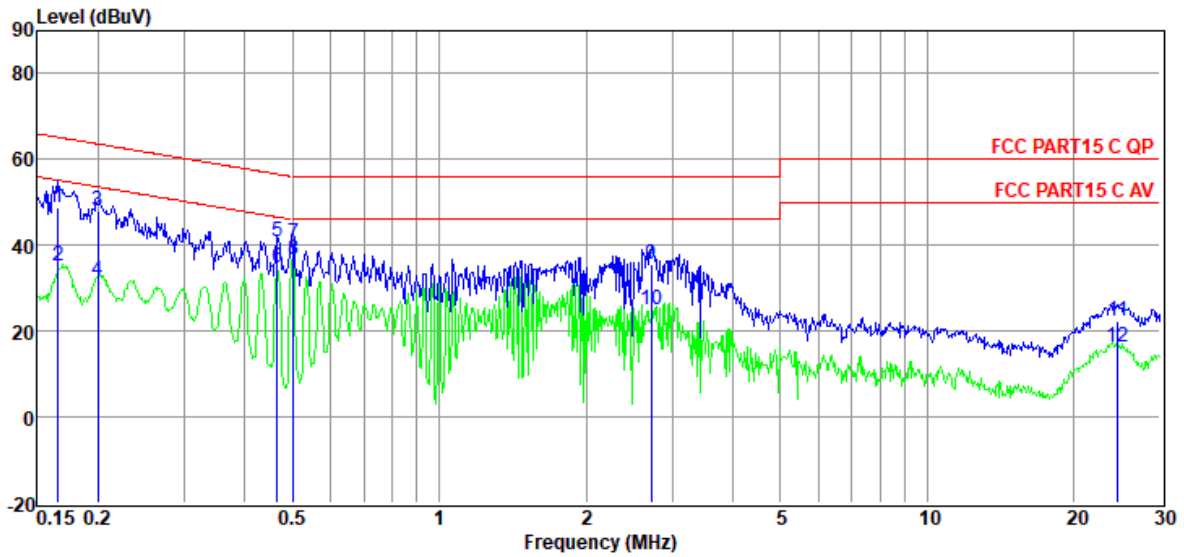

Item (Mark)	Freq. (MHz)	Read Level (dBuV)	LISN Factor (dB)	Cable Loss (dB)	Pulse Limiter Factor (dB)	Result Level (dBuV)	Limit Line (dBuV)	Over Limit (dB)	Detector	Phase
1	0.17	29.34	9.67	0.01	9.92	48.94	65.16	-16.22	QP	LINE
2	0.17	15.42	9.67	0.01	9.92	35.02	55.16	-20.14	Average	LINE
3	0.20	28.28	9.80	0.01	9.92	48.01	63.62	-15.61	QP	LINE
4	0.20	11.89	9.80	0.01	9.92	31.62	53.62	-22.00	Average	LINE
5	0.47	21.35	9.62	0.02	9.91	40.90	56.58	-15.68	QP	LINE
6	0.47	15.30	9.62	0.02	9.91	34.85	46.58	-11.73	Average	LINE
7	0.50	21.13	9.60	0.02	9.91	40.66	56.00	-15.34	QP	LINE
8	0.50	17.19	9.60	0.02	9.91	36.72	46.00	-9.28	Average	LINE
9	2.72	15.89	9.54	0.05	9.90	35.38	56.00	-20.62	QP	LINE
10	2.72	5.45	9.54	0.05	9.90	24.94	46.00	-21.06	Average	LINE
11	24.53	2.57	9.65	0.19	9.98	22.39	60.00	-37.61	QP	LINE
12	24.53	-3.39	9.65	0.19	9.98	16.43	50.00	-33.57	Average	LINE

Note:

1. Result Level = Read Level + LISN Factor + Pulse Limiter Factor + Cable loss.
2. If QP Result complies with AV limit, AV Result is deemed to comply with AV limit.
3. Test setup: RBW: 200 Hz (9 kHz—150 kHz), 9 kHz (150 kHz—30 MHz).
4. Step size: 80Hz (0.009MHz-0.15MHz), 4 kHz (0.15MHz-30MHz), Scan time: auto.

TR-4-E-010 Conducted Emission Test Result

Test Site : DDT 1# Shield Room D:\2022 CE report date\Q22042404-2E
XTREME3N\FCC.EM6
Test Date : 2022-05-24 **Tested By** : James Gan
EUT : Portable Bluetooth Speaker **Model Number** : XTREME 3N
Power Supply : AC 120V/60Hz **Test Mode** : Tx mode
Condition : TEMP:24.3°C, RH:53.0%, BP:101.0kPa **LISN** : 2021 1# ENV216/NEUTRAL
Memo : Scenario 2 (CR4-TI GP CELL)

Data: 2

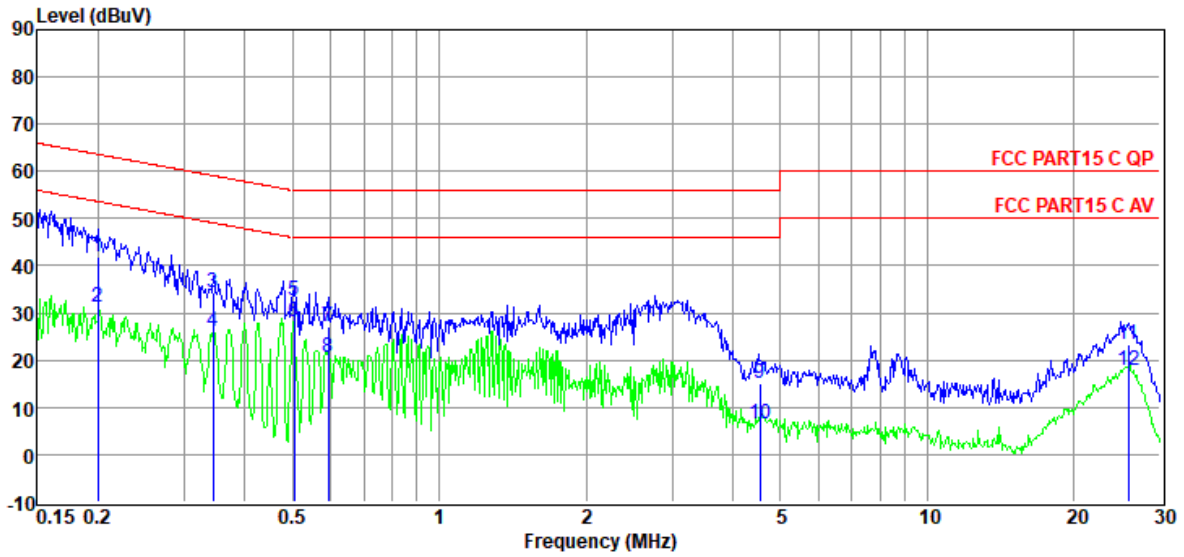

Item (Mark)	Freq. (MHz)	Read Level (dBμV)	LISN Factor (dB)	Cable Loss (dB)	Pulse Limiter Factor (dB)	Result Level (dBμV)	Limit Line (dBμV)	Over Limit (dB)	Detector	Phase
1	0.20	21.99	9.80	0.01	9.92	41.72	63.62	-21.90	QP	NEUTRAL
2	0.20	11.45	9.80	0.01	9.92	31.18	53.62	-22.44	Average	NEUTRAL
3	0.34	14.65	9.62	0.02	9.91	34.20	59.09	-24.89	QP	NEUTRAL
4	0.34	6.52	9.62	0.02	9.91	26.07	49.09	-23.02	Average	NEUTRAL
5	0.50	13.10	9.51	0.02	9.91	32.54	56.00	-23.46	QP	NEUTRAL
6	0.50	8.65	9.51	0.02	9.91	28.09	46.00	-17.91	Average	NEUTRAL
7	0.59	7.61	9.65	0.02	9.91	27.19	56.00	-28.81	QP	NEUTRAL
8	0.59	1.10	9.65	0.02	9.91	20.68	46.00	-25.32	Average	NEUTRAL
9	4.55	-4.82	9.75	0.06	9.92	14.91	56.00	-41.09	QP	NEUTRAL
10	4.55	-13.20	9.75	0.06	9.92	6.53	46.00	-39.47	Average	NEUTRAL
11	25.86	3.19	9.86	0.19	9.99	23.23	60.00	-36.77	QP	NEUTRAL
12	25.86	-2.09	9.86	0.19	9.99	17.95	50.00	-32.05	Average	NEUTRAL

Note:

1. Result Level = Read Level + LISN Factor + Pulse Limiter Factor + Cable loss.
2. If QP Result complies with AV limit, AV Result is deemed to comply with AV limit.
3. Test setup: RBW: 200 Hz (9 kHz—150 kHz), 9 kHz (150 kHz—30 MHz).
4. Step size: 80Hz (0.009MHz-0.15MHz), 4 kHz (0.15MHz-30MHz), Scan time: auto.

TR-4-E-010 Conducted Emission Test Result

Test Site : DDT 1# Shield Room
Test Date : 2022-05-24
EUT : Portable Bluetooth Speaker
Power Supply : AC 120V/60Hz
Condition : TEMP:24.3°C, RH:53.0%, BP:101.0kPa
Memo : Scenario 2 (CR4-TI GP CELL)

D:\2022 CE report date\Q22042404-2E XTREME3N\FCC.EM6
Tested By : James Gan
Model Number : XTREME 3N
Test Mode : Tx mode
LISN : 2021 1# ENV216/LINE

Data: 4

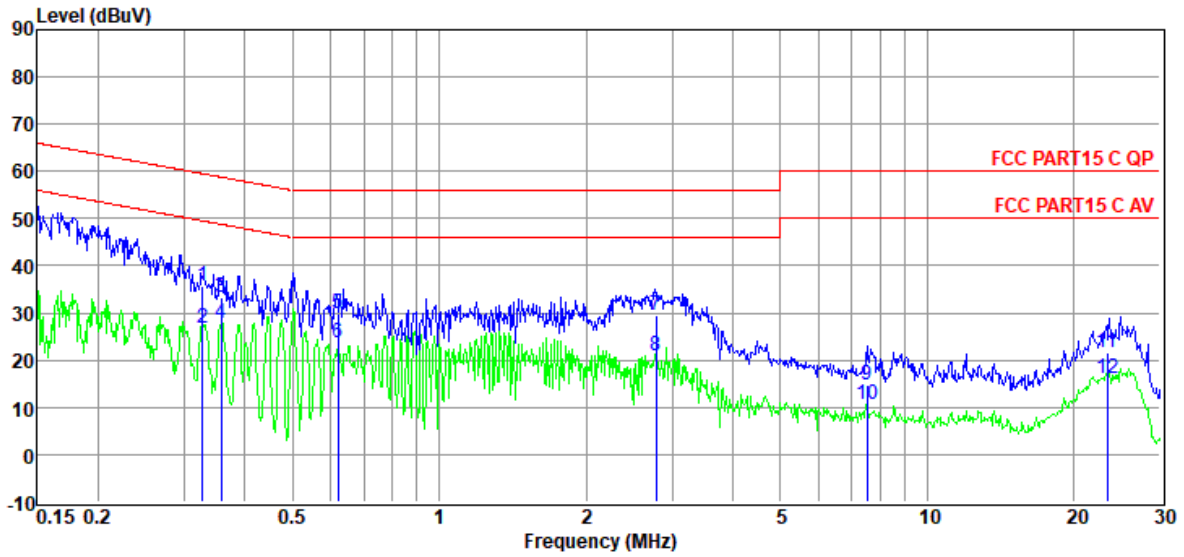

Item (Mark)	Freq. (MHz)	Read Level (dBuV)	LISN Factor (dB)	Cable Loss (dB)	Pulse Limiter Factor (dB)	Result Level (dBuV)	Limit Line (dBuV)	Over Limit (dB)	Detector	Phase
1	0.33	15.94	9.69	0.02	9.91	35.56	59.53	-23.97	QP	LINE
2	0.33	7.18	9.69	0.02	9.91	26.80	49.53	-22.73	Average	LINE
3	0.36	13.85	9.67	0.02	9.91	33.45	58.78	-25.33	QP	LINE
4	0.36	8.29	9.67	0.02	9.91	27.89	48.78	-20.89	Average	LINE
5	0.62	10.30	9.54	0.02	9.91	29.77	56.00	-26.23	QP	LINE
6	0.62	4.22	9.54	0.02	9.91	23.69	46.00	-22.31	Average	LINE
7	2.78	9.92	9.55	0.05	9.90	29.42	56.00	-26.58	QP	LINE
8	2.78	1.50	9.55	0.05	9.90	21.00	46.00	-25.00	Average	LINE
9	7.53	-4.80	9.50	0.09	9.94	14.73	60.00	-45.27	QP	LINE
10	7.53	-9.03	9.50	0.09	9.94	10.50	50.00	-39.50	Average	LINE
11	23.39	1.86	9.64	0.18	9.98	21.66	60.00	-38.34	QP	LINE
12	23.39	-3.84	9.64	0.18	9.98	15.96	50.00	-34.04	Average	LINE

Note:

1. Result Level = Read Level + LISN Factor + Pulse Limiter Factor + Cable loss.
2. If QP Result complies with AV limit, AV Result is deemed to comply with AV limit.
3. Test setup: RBW: 200 Hz (9 kHz—150 kHz), 9 kHz (150 kHz—30 MHz).
4. Step size: 80Hz (0.009MHz-0.15MHz), 4 kHz (0.15MHz-30MHz), Scan time: auto.

TR-4-E-010 Conducted Emission Test Result

Test Site : DDT 1# Shield Room D:\2022 CE report date\Q22042404-2E
XTREME3N\FCC.EM6
Test Date : 2022-05-24 **Tested By** : James Gan
EUT : Portable Bluetooth Speaker **Model Number** : XTREME 3N
Power Supply : AC 120V/60Hz **Test Mode** : Tx mode
Condition : TEMP:24.3°C, RH:53.0%, BP:101.0kPa **LISN** : 2021 1# ENV216/LINE
Memo : Scenario 3 (CR2+CR3+SINO GP CELL)

Data: 2

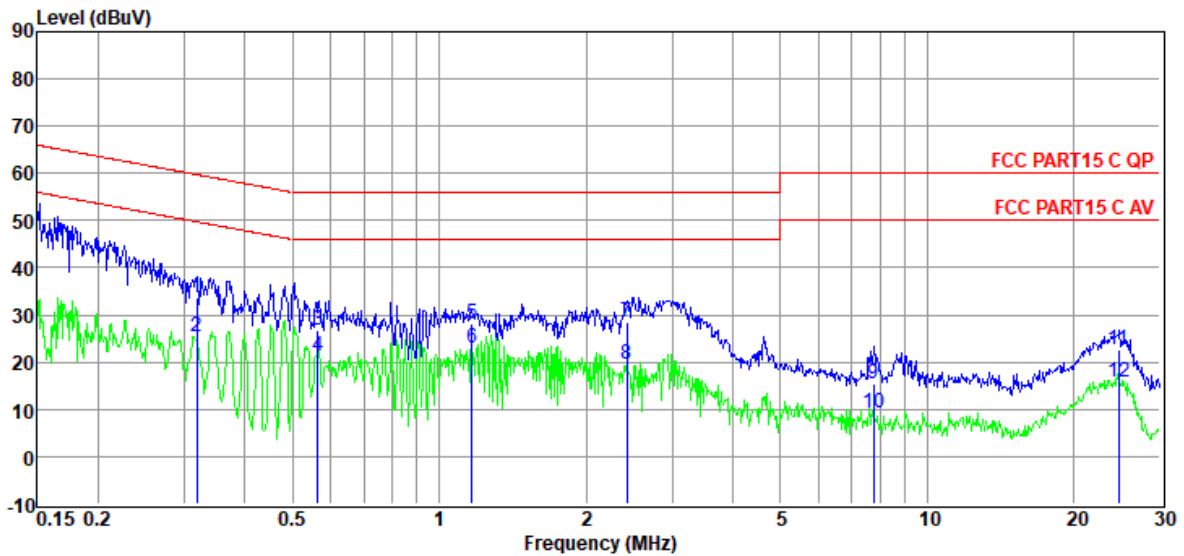

Item (Mark)	Freq. (MHz)	Read Level (dBμV)	LISN Factor (dB)	Cable Loss (dB)	Pulse Limiter Factor (dB)	Result Level (dBμV)	Limit Line (dBμV)	Over Limit (dB)	Detector	Phase
1	0.32	13.98	9.70	0.02	9.91	33.61	59.75	-26.14	QP	LINE
2	0.32	5.67	9.70	0.02	9.91	25.30	49.75	-24.45	Average	LINE
3	0.56	7.15	9.56	0.02	9.91	26.64	56.00	-29.36	QP	LINE
4	0.56	1.95	9.56	0.02	9.91	21.44	46.00	-24.56	Average	LINE
5	1.17	8.78	9.58	0.03	9.89	28.28	56.00	-27.72	QP	LINE
6	1.17	3.45	9.58	0.03	9.89	22.95	46.00	-23.05	Average	LINE
7	2.42	9.12	9.53	0.05	9.90	28.60	56.00	-27.40	QP	LINE
8	2.42	-0.02	9.53	0.05	9.90	19.46	46.00	-26.54	Average	LINE
9	7.77	-4.20	9.50	0.09	9.94	15.33	60.00	-44.67	QP	LINE
10	7.77	-10.39	9.50	0.09	9.94	9.14	50.00	-40.86	Average	LINE
11	24.66	2.72	9.65	0.19	9.98	22.54	60.00	-37.46	QP	LINE
12	24.66	-4.03	9.65	0.19	9.98	15.79	50.00	-34.21	Average	LINE

Note:

1. Result Level = Read Level + LISN Factor + Pulse Limiter Factor + Cable loss.
2. If QP Result complies with AV limit, AV Result is deemed to comply with AV limit.
3. Test setup: RBW: 200 Hz (9 kHz—150 kHz), 9 kHz (150 kHz—30 MHz).
4. Step size: 80Hz (0.009MHz-0.15MHz), 4 kHz (0.15MHz-30MHz), Scan time: auto.

TR-4-E-010 Conducted Emission Test Result

Test Site : DDT 1# Shield Room
Test Date : 2022-05-24
EUT : Portable Bluetooth Speaker
Power Supply : AC 120V/60Hz
Condition : TEMP:24.3°C, RH:53.0%, BP:101.0kPa
Memo : Scenario 3 (CR2+CR3+SINO GP CELL)

D:\2022 CE report date\Q22042404-2E XTREME3N\FCC.EM6
Tested By : James Gan
Model Number : XTREME 3N
Test Mode : Tx mode
LISN : 2021 1# ENV216/NEUTRAL

Data: 4

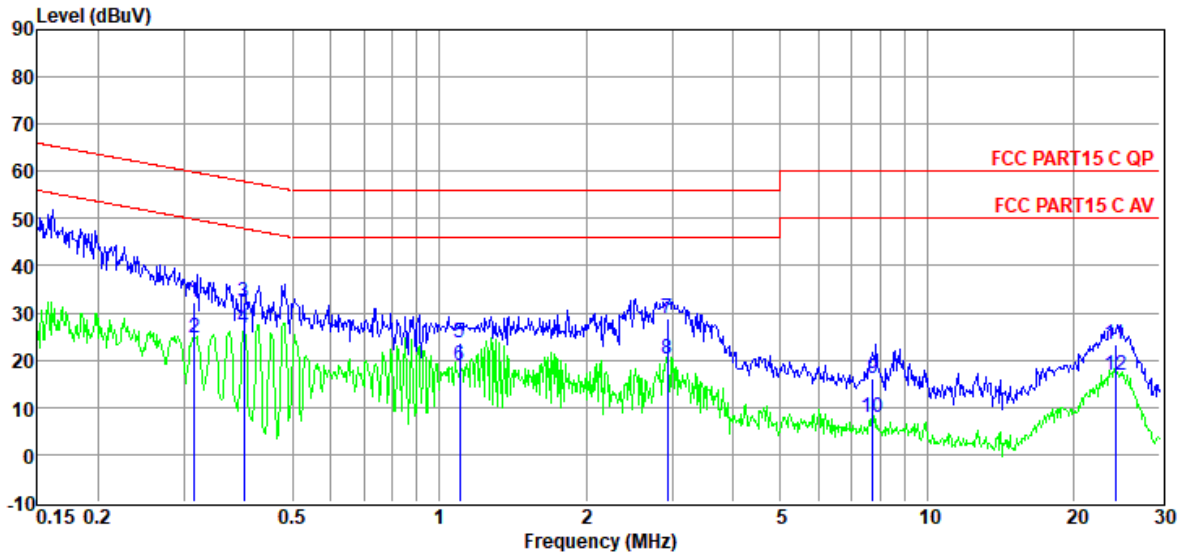

Item (Mark)	Freq. (MHz)	Read Level (dBμV)	LISN Factor (dB)	Cable Loss (dB)	Pulse Limiter Factor (dB)	Result Level (dBμV)	Limit Line (dBμV)	Over Limit (dB)	Detector	Phase
1	0.31	12.61	9.65	0.02	9.92	32.20	59.84	-27.64	QP	NEUTRAL
2	0.31	5.19	9.65	0.02	9.92	24.78	49.84	-25.06	Average	NEUTRAL
3	0.40	12.66	9.58	0.02	9.91	32.17	57.90	-25.73	QP	NEUTRAL
4	0.40	7.40	9.58	0.02	9.91	26.91	47.90	-20.99	Average	NEUTRAL
5	1.10	3.93	9.69	0.03	9.89	23.54	56.00	-32.46	QP	NEUTRAL
6	1.10	-0.85	9.69	0.03	9.89	18.76	46.00	-27.24	Average	NEUTRAL
7	2.93	9.17	9.71	0.05	9.91	28.84	56.00	-27.16	QP	NEUTRAL
8	2.93	0.65	9.71	0.05	9.91	20.32	46.00	-25.68	Average	NEUTRAL
9	7.73	-3.63	9.66	0.09	9.94	16.06	60.00	-43.94	QP	NEUTRAL
10	7.73	-11.90	9.66	0.09	9.94	7.79	50.00	-42.21	Average	NEUTRAL
11	24.27	3.34	9.85	0.19	9.98	23.36	60.00	-36.64	QP	NEUTRAL
12	24.27	-3.12	9.85	0.19	9.98	16.90	50.00	-33.10	Average	NEUTRAL

Note:

1. Result Level = Read Level + LISN Factor + Pulse Limiter Factor + Cable loss.
2. If QP Result complies with AV limit, AV Result is deemed to comply with AV limit.
3. Test setup: RBW: 200 Hz (9 kHz—150 kHz), 9 kHz (150 kHz—30 MHz).
4. Step size: 80Hz (0.009MHz-0.15MHz), 4 kHz (0.15MHz-30MHz), Scan time: auto.

TR-4-E-010 Conducted Emission Test Result

Test Site : DDT 1# Shield Room
Test Date : 2022-05-24
EUT : Portable Bluetooth Speaker
Power Supply : AC 120V/60Hz
Condition : TEMP:24.3°C, RH:53.0%, BP:101.0kPa
Memo : Scenario 4 (CR2+CR3+TI GP CELL)

D:\2022 CE report date\Q22042404-2E XTREME3N\FCC.EM6
Tested By : James Gan
Model Number : XTREME 3N
Test Mode : Tx mode
LISN : 2021 1# ENV216/LINE

Data: 2

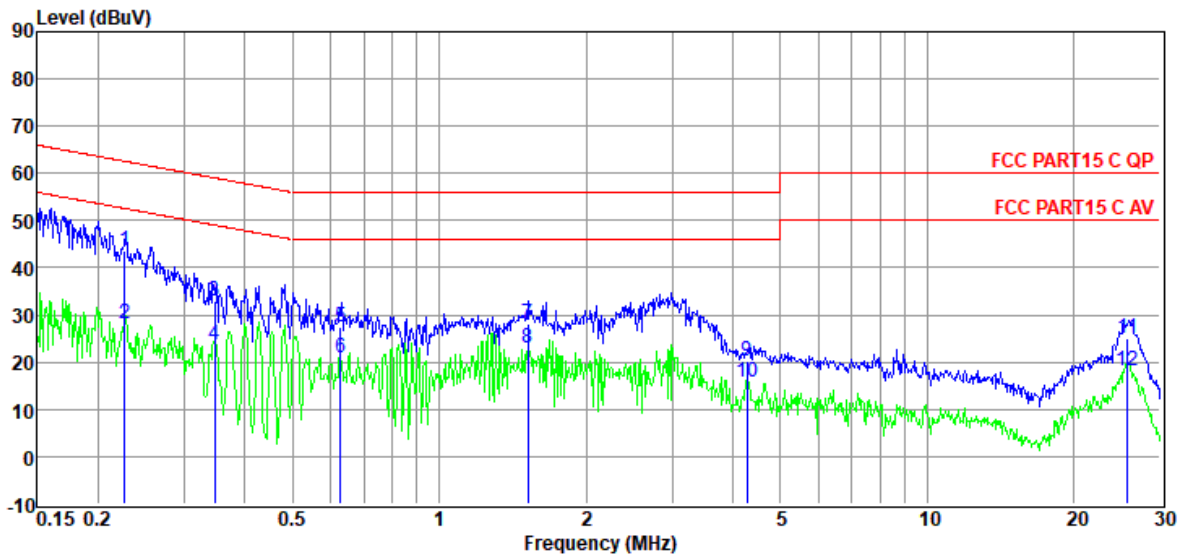

Item (Mark)	Freq. (MHz)	Read Level (dBµV)	LISN Factor (dB)	Cable Loss (dB)	Pulse Limiter Factor (dB)	Result Level (dBµV)	Limit Line (dBµV)	Over Limit (dB)	Detector	Phase
1	0.23	23.83	9.77	0.02	9.92	43.54	62.57	-19.03	QP	LINE
2	0.23	8.47	9.77	0.02	9.92	28.18	52.57	-24.39	Average	LINE
3	0.35	13.31	9.68	0.02	9.91	32.92	59.05	-26.13	QP	LINE
4	0.35	4.17	9.68	0.02	9.91	23.78	49.05	-25.27	Average	LINE
5	0.63	7.96	9.53	0.02	9.91	27.42	56.00	-28.58	QP	LINE
6	0.63	1.54	9.53	0.02	9.91	21.00	46.00	-25.00	Average	LINE
7	1.52	8.69	9.54	0.04	9.89	28.16	56.00	-27.84	QP	LINE
8	1.52	3.45	9.54	0.04	9.89	22.92	46.00	-23.08	Average	LINE
9	4.27	0.81	9.59	0.06	9.92	20.38	56.00	-35.62	QP	LINE
10	4.27	-3.65	9.59	0.06	9.92	15.92	46.00	-30.08	Average	LINE
11	25.73	5.17	9.66	0.19	9.98	25.00	60.00	-35.00	QP	LINE
12	25.73	-1.71	9.66	0.19	9.98	18.12	50.00	-31.88	Average	LINE

Note:

1. Result Level = Read Level + LISN Factor + Pulse Limiter Factor + Cable loss.
2. If QP Result complies with AV limit, AV Result is deemed to comply with AV limit.
3. Test setup: RBW: 200 Hz (9 kHz—150 kHz), 9 kHz (150 kHz—30 MHz).
4. Step size: 80Hz (0.009MHz-0.15MHz), 4 kHz (0.15MHz-30MHz), Scan time: auto.

TR-4-E-010 Conducted Emission Test Result

Test Site : DDT 1# Shield Room
Test Date : 2022-05-24
EUT : Portable Bluetooth Speaker
Power Supply : AC 120V/60Hz
Condition : TEMP:24.3°C, RH:53.0%, BP:101.0kPa
Memo : Scenario 4 (CR2+CR3+TI GP CELL)

D:\2022 CE report date\Q22042404-2E XTREME3N\FCC.EM6
Tested By : James Gan
Model Number : XTREME 3N
Test Mode : Tx mode
LISN : 2021 1# ENV216/NEUTRAL

Data: 4

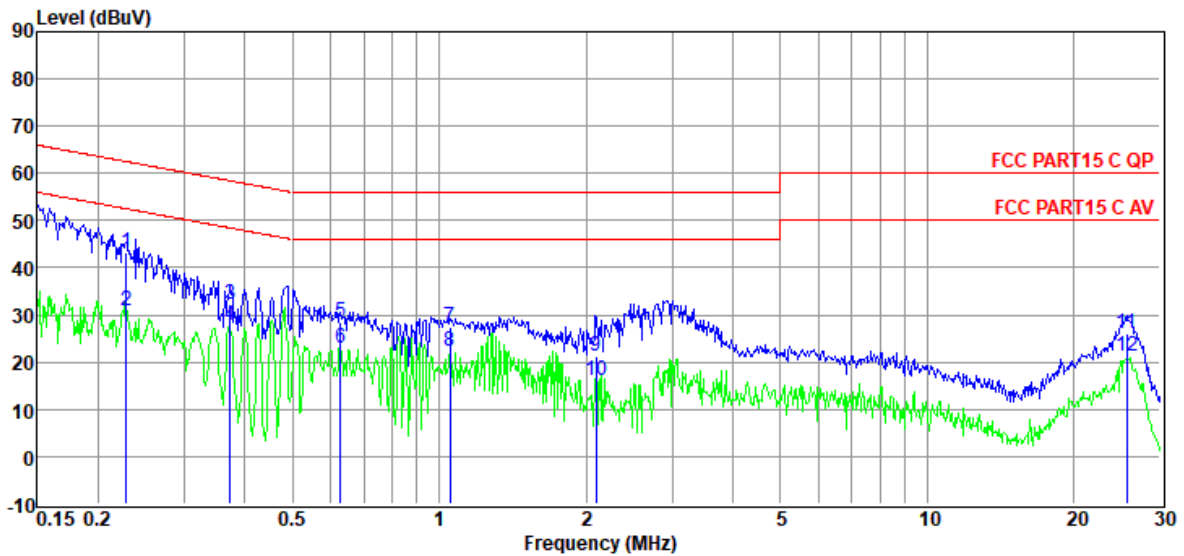

Item (Mark)	Freq. (MHz)	Read Level (dBμV)	LISN Factor (dB)	Cable Loss (dB)	Pulse Limiter Factor (dB)	Result Level (dBμV)	Limit Line (dBμV)	Over Limit (dB)	Detector	Phase
1	0.23	23.49	9.76	0.02	9.92	43.19	62.52	-19.33	QP	NEUTRAL
2	0.23	11.19	9.76	0.02	9.92	30.89	52.52	-21.63	Average	NEUTRAL
3	0.37	12.71	9.60	0.02	9.91	32.24	58.43	-26.19	QP	NEUTRAL
4	0.37	8.29	9.60	0.02	9.91	27.82	48.43	-20.61	Average	NEUTRAL
5	0.63	8.82	9.70	0.02	9.91	28.45	56.00	-27.55	QP	NEUTRAL
6	0.63	3.31	9.70	0.02	9.91	22.94	46.00	-23.06	Average	NEUTRAL
7	1.05	7.86	9.69	0.03	9.89	27.47	56.00	-28.53	QP	NEUTRAL
8	1.05	2.68	9.69	0.03	9.89	22.29	46.00	-23.71	Average	NEUTRAL
9	2.10	1.83	9.61	0.04	9.89	21.37	56.00	-34.63	QP	NEUTRAL
10	2.10	-3.40	9.61	0.04	9.89	16.14	46.00	-29.86	Average	NEUTRAL
11	25.59	5.92	9.86	0.19	9.98	25.95	60.00	-34.05	QP	NEUTRAL
12	25.59	1.08	9.86	0.19	9.98	21.11	50.00	-28.89	Average	NEUTRAL

Note:

1. Result Level = Read Level + LISN Factor + Pulse Limiter Factor + Cable loss.
2. If QP Result complies with AV limit, AV Result is deemed to comply with AV limit.
3. Test setup: RBW: 200 Hz (9 kHz—150 kHz), 9 kHz (150 kHz—30 MHz).
4. Step size: 80Hz (0.009MHz-0.15MHz), 4 kHz (0.15MHz-30MHz), Scan time: auto.