



Report No.: DDT-R22051721-2E01

Issued Date: Jun. 10, 2022

## FCC AND ISED CERTIFICATION TEST REPORT

### FOR

<b>Applicant</b>	:	Harman International Industries, Inc.
<b>Address</b>	:	8500 Balboa Boulevard, Northridge, CA 91329, UNITED STATES
<b>Equipment under Test</b>	:	Portable Bluetooth Speaker
<b>Model No.</b>	:	XTREME 2Q
<b>Trade Mark</b>	:	JBL
<b>FCC ID</b>	:	APIJBLXTREME2Q
<b>IC</b>	:	6132A-JBLXTREME2Q
<b>Manufacturer</b>	:	Harman International Industries, Inc.
<b>Address</b>	:	8500 Balboa Boulevard, Northridge, CA 91329, UNITED STATES

**Issued By: Dongguan Dongdian Testing Service Co., Ltd.**

**Add.:** No. 17, Zongbu Road 2, Songshan Lake Sci&Tech, Industry Park,  
Dongguan City, Guangdong Province, China, 523808

**Tel.:** +86-0769-38826678, **E-mail:** ddt@dgddt.com, <http://www.dgddt.com>

# REPORT

## Table of Contents

	Test report declares.....	3
1.	Summary of Test Results.....	5
2.	General Test Information .....	6
2.1.	Description of EUT .....	6
2.2.	Accessories of EUT.....	7
2.3.	Assistant equipment used for test.....	7
2.4.	Block diagram of EUT configuration for test .....	7
2.5.	Deviations of test standard.....	8
2.6.	Test environment conditions .....	8
2.7.	Test laboratory .....	8
2.8.	Measurement uncertainty.....	9
3.	Equipment Used During Test.....	10
4.	Radiated Emission .....	11
4.1.	Block diagram of test setup.....	11
4.2.	Limit .....	12
4.3.	Test procedure .....	14
4.4.	Test result.....	15
5.	Power Line Conducted Emission.....	20
5.1.	Block diagram of test setup.....	20
5.2.	Power line conducted emission limits .....	20
5.3.	Test procedure .....	20
5.4.	Test result.....	21
6.	Test Setup Photograph .....	26
7.	Photos of the EUT .....	28

## Test Report Declare

<b>Applicant</b>	:	Harman International Industries, Inc.
<b>Address</b>	:	8500 Balboa Boulevard, Northridge, CA 91329, UNITED STATES
<b>Equipment under Test</b>	:	Portable Bluetooth Speaker
<b>Model No.</b>	:	XTREME 2Q
<b>Trade mark</b>	:	JBL
<b>Manufacturer</b>	:	Harman International Industries, Inc.
<b>Address</b>	:	8500 Balboa Boulevard, Northridge, CA 91329, UNITED STATES

### Test Standard Used:

FCC Rules and Regulations Part 15 Subpart C, RSS-247 Issue 2 February 2017.

### Test procedure used:

ANSI C63.10:2013, RSS-Gen Issue 5, Apr. 2018, Amendment 2 (February 2021).

### We Declare:

The equipment described above is tested by Dongguan Dongdian Testing Service Co., Ltd. and in the configuration tested the equipment complied with the standards specified above. The test results are contained in this test report and Dongguan Dongdian Testing Service Co., Ltd. is assumed of full responsibility for the accuracy and completeness of these tests.

**After test and evaluation, our opinion is that the equipment provided for test compliance with the requirement of the above FCC&ISED standards.**

<b>Report No.:</b>	DDT-R22051721-2E01		
<b>Date of Receipt:</b>	May 19, 2022	<b>Date of Test:</b>	May 19, 2022 ~ Jun. 10, 2022

**Prepared By:**

*Jacky Huang*

**Jacky Huang/Engineer**

**Approved By:**



**Damon Hu/EMC Manager**

Note: This report applies to above tested sample only. This report shall not be reproduced in parts without written approval of Dongguan Dongdian Testing Service Co., Ltd.

### Revision History

Rev.	Revisions	Issue Date	Revised By
---	Initial issue	Jun. 10, 2022	

## 1. Summary of Test Results

Description of Test Item	Standard	Results
Radiated Emission	FCC Part 15: 15.209 FCC Part 15: 15.247(d) ANSI C63.10:2013 RSS-247 Issue 2 RSS-Gen Issue 5	Pass
Power Line Conducted Emissions	FCC Part 15: 15.207 ANSI C63.10:2013 RSS-Gen Issue 5	Pass

Note: This report add battery (model: IDA107GA) on the basis of the report DDT-R18093008-1E4, where the battery has two different protective IC (BQ28Z610DRZR&SH366003). This change doesn't influence the RF performance, so only power line conducted emissions and radiated emission (below 1 GHz) were tested and updated in this report.

## 2. General Test Information

### 2.1. Description of EUT

EUT* Name	: Portable Bluetooth Speaker
Model Number	: XTREME 2Q
EUT function description	: Please reference user manual of this device
Power supply	: DC 19V from external AC Adapter DC 7.2V 5000mAh Polymer Li-ion built-in battery
Radio Specification	: Bluetooth V4.2
Operation frequency	: 2402 MHz - 2480 MHz
Modulation	: GFSK, $\pi/4$ -DQPSK, 8DPSK
Data rate	: 1 Mbps, 2 Mbps, 3 Mbps
Antenna Type	: Dedicated FPC antenna, maximum PK gain: 2.27 dBi
Sample Number	: S22051721-20, S22051721-30

Note: EUT is the abbreviation of equipment under test.

Channel information					
Channel	Frequency (MHz)	Channel	Frequency (MHz)	Channel	Frequency (MHz)
0	2402	27	2429	54	2456
1	2403	28	2430	55	2457
2	2404	29	2431	56	2458
3	2405	30	2432	57	2459
4	2406	31	2433	58	2460
5	2407	32	2434	59	2461
6	2408	33	2435	60	2462
7	2409	34	2436	61	2463
8	2410	35	2437	62	2464
9	2411	36	2438	63	2465
10	2412	37	2439	64	2466
11	2413	38	2440	65	2467
12	2414	39	2441	66	2468
13	2415	40	2442	67	2469
14	2416	41	2443	68	2470
15	2417	42	2444	69	2471
16	2418	43	2445	70	2472
17	2419	44	2446	71	2473
18	2420	45	2447	72	2474
19	2421	46	2448	73	2475
20	2422	47	2449	74	2476
21	2423	48	2450	75	2477
22	2424	49	2451	76	2478
23	2425	50	2452	77	2479
24	2426	51	2453	78	2480
25	2427	52	2454		
26	2428	53	2455		

## 2.2. Accessories of EUT

Assistant equipment	Manufacturer	Model number	Parameter	Remark
AC cable	Harman	N/A	Length: 1.1m, unshielded	Standard Accessories
AC Adapter	Shenzhen Jingquanhua Electronics Co., Ltd.	NSA57ED-190300	Input: AC 100-240V -50/60Hz, 1.5A; Output: DC 19V, 3A	Alternative

New battery protective IC information:

Manufacturer	Model	Key name	Remark
TI	BQ28Z610DRZR	IC (U1)	N/A
SINO WEALTH	SH366003	IC (U1)	N/A

## 2.3. Assistant equipment used for test

Assistant equipment	Manufacturer	Model number	EMC Compliance	SN
NA	NA	NA	NA	NA

## 2.4. Block diagram of EUT configuration for test



Test software: BlueTest3.EXE

The test software was used to control EUT work in Continuous Tx mode, and select test channel, wireless mode as below table.

Tested mode, channel, information		
Mode	Channel	Frequency (MHz)
GFSK hopping on Tx mode	CH0 to CH78	2402 to 2480
$\pi/4$ -DQPSK hopping on Tx mode	CH0 to CH78	2402 to 2480
8DPSK hopping on Tx mode	CH0 to CH78	2402 to 2480
GFSK hopping off Tx mode	CH0	2402
	CH39	2441
	CH78	2480
$\pi/4$ -DQPSK hopping off Tx mode	CH0	2402
	CH39	2441
	CH78	2480
8DPSK hopping off Tx mode	CH0	2402
	CH39	2441
	CH78	2480

Note: For  $\pi/4$ -DQPSK its same modulation type with 8DPSK, and based exploratory test, there is no significant difference of that two types test result, so except output power, except the RF output power, all other items final test was only performed with the worst case 8DPSK and GFSK.

## 2.5. Deviations of test standard

No deviation.

## 2.6. Test environment conditions

During the measurement the environmental conditions were within the listed ranges:

Temperature range:	21-25 °C
Humidity range:	40-75%
Pressure range:	86-106 kPa

## 2.7. Test laboratory

Dongguan Dongdian Testing Service Co., Ltd.

Addr.: No. 17, Zongbu Road 2, Songshan Lake Sci&Tech, Industry Park, Dongguan City,  
Guangdong Province, China, 523808.

Tel.: +86-0769-38826678, <http://www.dgddt.com>, Email: [ddt@dgddt.com](mailto:ddt@dgddt.com).

CNAS Accreditation No. L6451; A2LA Accreditation Number: 3870.01

FCC Designation Number: CN1182, Test Firm Registration Number: 540522

Innovation, Science and Economic Development Canada Site Registration Number: 10288A

Conformity Assessment Body identifier: CN0048

VCCI facility registration number: C-20087, T-20088, R-20123, G-20118



## 2.8. Measurement uncertainty

Test Item	Uncertainty
Bandwidth	1.1%
Peak Output Power (Conducted) (Spectrum analyzer)	0.86 dB (10 MHz ≤ f < 3.6 GHz); 1.38 dB (3.6 GHz ≤ f < 8 GHz)
Peak Output Power (Conducted) (Power Sensor)	0.74 dB
Power Spectral Density	0.74 dB (10 MHz ≤ f < 3.6 GHz); 1.38 dB (3.6 GHz ≤ f < 8 GHz)
Frequencies Stability	6.7 × 10 <sup>-8</sup> (Antenna couple method) 5.5 × 10 <sup>-8</sup> (Conducted method)
Conducted spurious emissions	0.86 dB (10 MHz ≤ f < 3.6 GHz); 1.40 dB (3.6 GHz ≤ f < 8 GHz) 1.66 dB (8 GHz ≤ f < 22 GHz)
Uncertainty for radio frequency (RBW < 20 kHz)	3×10 <sup>-8</sup>
Temperature	0.4 °C
Humidity	2 %
Uncertainty for Radiation Emission test (30 MHz - 1 GHz)	4.70 dB (Antenna Polarize: V) 4.84 dB (Antenna Polarize: H)
Uncertainty for Radiation Emission test (1 GHz - 40 GHz)	4.10 dB (1-6 GHz) 4.40 dB (6 GHz - 18 GHz) 3.54dB (18 GHz - 26 GHz) 4.30 dB (26 GHz - 40 GHz)
Uncertainty for Power line conduction emission test	3.32 dB (150 kHz - 30 MHz)

Note: This uncertainty represents an expanded uncertainty expressed at approximately the 95% confidence level using a coverage factor of k=2.

### 3. Equipment Used During Test

Equipment	Manufacturer	Model No.	Serial No.	Last Cal.	Cal. Interval
<b>☑ Radiation 3#chamber</b>					
EMI Test Receiver	R&S	ESU	100472	May 18, 2022	1 Year
Spectrum analyzer	Agilent	E4447A	MY50180031	May 18, 2022	1 Year
Active Loop antenna	Schwarzbeck	FMZB-1519	1519-038	Sep. 19, 2021	1 Year
Trilog Broadband Antenna	Schwarzbeck	VULB 9163	01429	Aug. 07, 2021	1 Year
Double Ridged Horn Antenna	Schwarzbeck	BBHA9120	02468	Nov. 17, 2021	1 Year
Broad Band Horn Antenna	Schwarzbeck	BBHA 9170	790	May 06, 2022	1 Year
Pre-amplifier	COM-POWER	PAM-118A	18040084	Sep. 02, 2021	1 Year
Pre-amplifier	COM-POWER	PAM-840A	461369	Apr. 11, 2022	1 Year
Test software	Audix	E3	V 6.1.1.1	N/A	N/A
<b>☑ Power Line Conducted Emissions Test</b>					
Test Receiver	R&S	ESCI	100551	Sep. 02, 2021	1 Year
LISN 1	R&S	ENV216	101109	Sep. 07, 2021	1 Year
LISN 2	R&S	ESH2-Z5	100309	Sep. 07, 2021	1 Year
Pulse Limiter	R&S	ESH3-Z2	101242	Sep. 02, 2021	1 Year
CE Cable 1	HUBSER	N/A	W10.01	Sep. 02, 2021	1 Year
Test software	Audix	E3	V 6.11111b	N/A	N/A

### 4. Radiated Emission

#### 4.1. Block diagram of test setup

In 3 m Anechoic Chamber, test setup diagram for 9 kHz - 30 MHz

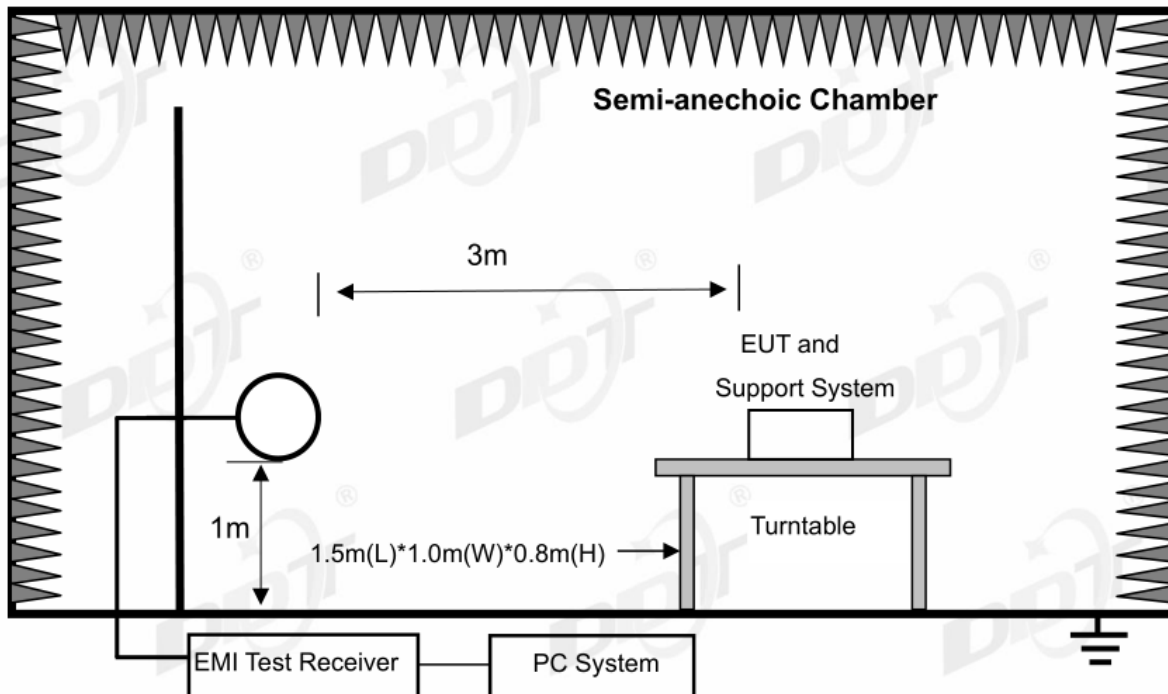

In 3 m Anechoic Chamber, test setup diagram for below 1 GHz

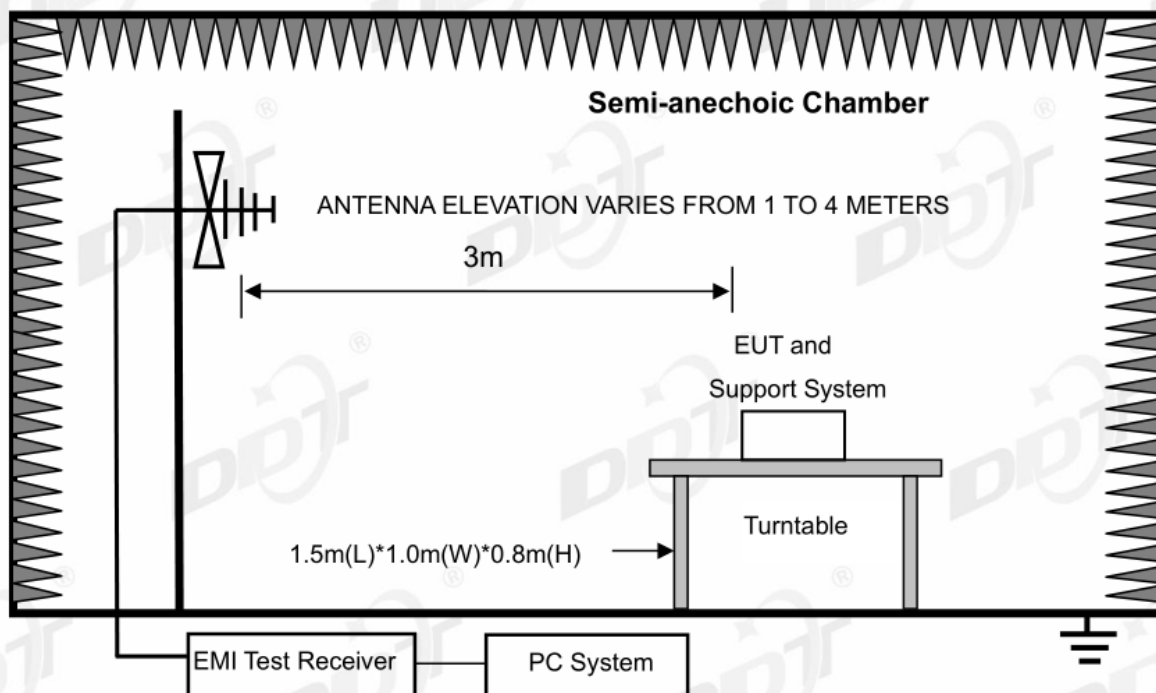

In 3 m Anechoic Chamber, test setup diagram for frequency above 1 GHz

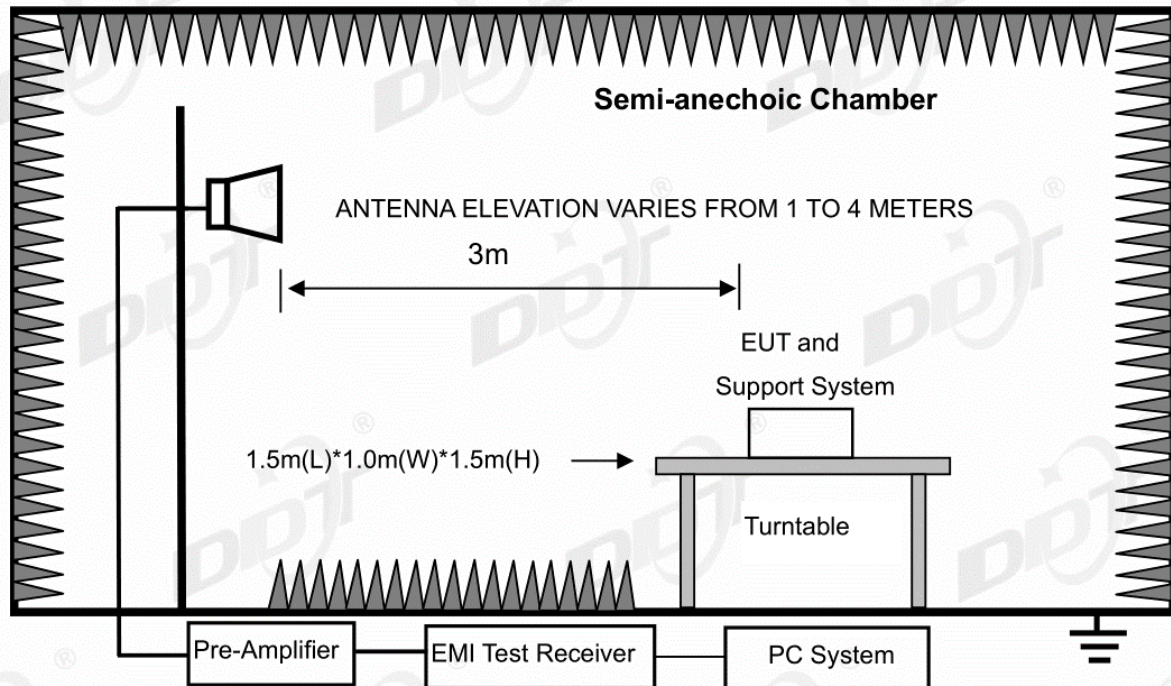

Note: For harmonic emissions test an appropriate high pass filter was inserted in the input port of AMP.

#### 4.2. Limit

(1) FCC 15.205 Restricted frequency band

MHz	MHz	MHz	GHz
0.090-0.110	16.42-16.423	399.9-410	4.5-5.15
10.495-0.505	16.69475-16.69525	608-614	5.35-5.46
2.1735-2.1905	16.80425-16.80475	960-1240	7.25-7.75
4.125-4.128	25.5-25.67	1300-1427	8.025-8.5
4.1772&4.17775	37.5-38.25	1435-1626.5	9.0-9.2
4.2072&4.20775	73-74.6	1645.5-1646.5	9.3-9.5
6.215-6.218	74.8-75.2	1660-1710	10.6-12.7
6.26775-6.26825	108-121.94	1718.8-1722.2	13.25-13.4
6.31175-6.31225	123-138	2200-2300	14.47-14.5
8.291-8.294	149.9-150.05	2310-2390	15.35-16.2
8.362-8.366	156.52475-156.52525	2483.5-2500	17.7-21.4
8.37625-8.38675	156.7-156.9	2690-2900	22.01-23.12
8.41425-8.41475	162.0125-167.17	3260-3267	23.6-24.0
12.29-12.293	167.72-173.2	3332-3339	31.2-31.8
12.51975-12.52025	240-285	3345.8-3358	36.43-36.5
12.57675-12.57725	322-335.4	3600-4400	( <sup>2</sup> )
13.36-13.41			

<sup>1</sup>Until February 1, 1999, this restricted band shall be 0.490-0.510 MHz.

<sup>2</sup>Above 38.6

## RSS-Gen section 8.10 Restricted frequency bands\*

MHz	MHz	MHz	GHz
0.090-0.110	12.51975-12.52025	240-285	3.5-4.4
0.495-0.505	12.57675-12.57725	322-335.4	4.5-5.15
2.1735-2.1905	13.36-13.41	399.9-410	5.35-5.46
3.020-3.026	16.42-16.423	608-614	7.25-7.75
4.125-4.128	16.69475-16.69525	960-1427	8.025-8.5
4.1772&4.17775	16.80425-16.80475	1435-1626.5	9.0-9.2
4.2072&4.20775	25.5-25.67	1645.5-1646.5	9.3-9.5
5.677-5.683	37.5-38.25	1660-1710	10.6-12.7
6.215-6.218	73-74.6	1718.8-1722.2	13.25-13.4
6.26775-6.26825	74.8-75.2	2200-2300	14.47-14.5
6.31175-6.31225	108-138	2310-2390	15.35-16.2
8.291-8.294	149.9-150.05	2483.5-2500	17.7-21.4
8.362-8.366	156.52475-156.52525	2655-2900	22.01-23.12
8.37625-8.38675	156.7-156.9	3260-3267	23.6-24.0
8.41425-8.41475	162.0125-167.17	3332-3339	31.2-31.8
12.29-12.293	167.72-173.2	3345.8-3358	36.43-36.5
			Above 38.6

\* Certain frequency bands listed in table 7 and in bands above 38.6 GHz are designated for licence-exempt applications. These frequency bands and the requirements that apply to related devices are set out in the 200 and 300 series of RSSs.

## (2) FCC 15.209 Limit.

FREQUENCY MHz	DISTANCE Meters	FIELD STRENGTHS LIMIT	
		$\mu\text{V}/\text{m}$	$\text{dB}(\mu\text{V})/\text{m}$
0.009 ~ 0.490	300	2400/F(kHz)	67.6-20log(F)
0.490 ~ 1.705	30	24000/F(kHz)	87.6-20log(F)
1.705 ~ 30.0	30	30	29.54
30 ~ 88	3	100	40.0
88 ~ 216	3	150	43.5
216 ~ 960	3	200	46.0
960 ~ 1000	3	500	54.0
Above 1000	3	74.0 dB( $\mu\text{V}$ )/m (Peak) 54.0 dB( $\mu\text{V}$ )/m (Average)	

Note: (1) The emission limits shown in the above table are based on measurements employing a CISPR QP detector except for the frequency bands 9-90 kHz, 110-490 kHz and above 1000 MHz, radiated emissions limits in these three bands are based on measurements employing an average detector.

(2) At frequencies below 30 MHz, measurement may be performed at a distance closer than that specified, and the limit at closer measurement distance can be extrapolated by below formula:

$$\text{Limit}_{3\text{m}}(\text{dB}\mu\text{V}/\text{m}) = \text{Limit}_{30\text{m}}(\text{dB}\mu\text{V}/\text{m}) + 40\text{Log}(30\text{m}/3\text{m})$$

## (3) Limit for this EUT

All the emissions appearing within 15.205 restricted frequency bands shall not exceed the limits shown in 15.209, all the other emissions shall be at least 20 dB below the fundamental emissions or comply with 15.209 limits.

**4.3. Test procedure**

- (1) EUT was placed on a non-metallic table, 80 cm above the ground plane inside a semi-anechoic chamber for below 1G and 150 cm above the ground plane inside a semi-anechoic chamber for above 1G.
- (2) Test antenna was located 3m from the EUT on an adjustable mast, and the antenna used as below table.

Test frequency range	Test antenna used	Test antenna distance
9 kHz - 30 MHz	Active Loop antenna	3 m
30 MHz - 1 GHz	Trilog Broadband Antenna	3 m
1 GHz - 18 GHz	Double Ridged Horn Antenna (1 GHz - 18 GHz)	3 m
18 GHz - 40 GHz	Horn Antenna (18 GHz - 40 GHz)	1 m

According ANSI C63.10:2013 clause 6.4.4.2 and 6.5.3, for measurements below 30 MHz, the loop antenna was positioned with its plane vertical from the EUT and rotated about its vertical axis for maximum response at each azimuth position around the EUT. And the loop antenna also is positioned with its plane horizontal at the specified distance from the EUT. The center of the loop is 1 m above the ground. For measurement above 30 MHz, the trilog Broadband Antenna or Horn Antenna was located 3 m from EUT, Measurements were made with the antenna positioned in both the horizontal and vertical planes of Polarization, and the measurement antenna was varied from 1 m to 4 m. in height above the reference ground plane to obtain the maximum signal strength.

(3) Below pre-scan procedure was first performed in order to find prominent frequency spectrum radiated emissions from 9 kHz to 25 GHz:

(a) Scanning the peak frequency spectrum with the antenna specified in step (3), and the EUT was rotated 360 degree, the antenna height was varied from 1 m to 4 m (Except loop antenna, it's fixed 1 m above ground.)

(b) Change work frequency or channel of device if practicable.

(c) Change modulation type of device if practicable.

(d) Change power supply range from 85% to 115% of the rated supply voltage

(e) Rotated EUT though three orthogonal axes to determine the attitude of EUT arrangement produces highest emissions.

Spectrum frequency from 9 kHz to 25 GHz (tenth harmonic of fundamental frequency) was investigated, and no any obvious emission were detected from 18 GHz to 25 GHz, so below

final test was performed with frequency range from 9 kHz to 18 GHz.

- (4) For final emissions measurements at each frequency of interest, the EUT was rotated and the antenna height was varied between 1 m and 4 m in order to maximize the emission.

Measurements in both horizontal and vertical polarities were made and the data was recorded.

In order to find the maximum emission, the relative positions of equipment and all of the interface cables were changed according to ANSI C63.10:2013 on Radiated Emission test.

- (5) The emissions from 9 kHz to 1 GHz were measured based on CISPR QP detector except for the frequency bands 9-90 kHz, 110-490 kHz, for emissions from 9 kHz - 90 kHz, 110 kHz -

490 kHz and above 1 GHz were measured based on average detector, for emissions above 1 GHz, peak emissions also be measured and need comply with Peak limit.

- (6) The emissions from 9 kHz to 1 GHz, QP or average values were measured with EMI receiver with below RBW.

Frequency band	RBW
9 kHz - 150 kHz	200 Hz
150 kHz - 30 MHz	9 kHz
30 MHz - 1 GHz	120 kHz

- (7) For emissions above 1 GHz, both Peak and Average level were measured with Spectrum Analyzer, and the RBW is set at 1 MHz, VBW is set at 3 MHz for Peak measure; RBW 1 MHz VBW 10 Hz for Average measure (according ANSI C63.10:2013 clause 4.1.4.2.2 procedure for average measure).

- (8) X axis, Y axis, Z axis are tested, and worse setup X axis is reported.

#### 4.4. Test result

##### Pass. (See below detailed test result)

All the emissions except fundamental emission from 9 kHz to 25 GHz were comply with 15.209 limits.

Note1: According exploratory test no any obvious emission was detected from 9 kHz to 30 MHz and 18 GHz to 25 GHz.

Note2: For emissions below 1GHz, according exploratory explorer test, when change Tx mode and channel, have no distinct influence on emissions level, so for emissions below 1 GHz, the final test was only performed with EUT working in 8DPSK, Tx 2480 MHz mode.

Note3: For emissions above 1GHz. If peak results comply with AV limit, AV Result is deemed to comply with AV limit.

## Radiated Emission test (below 1 GHz) TR-4-E-009 Radiated Emission Test Result

<b>Test Site</b> : DDT 3m Chamber 3# <b>Test Date</b> : 2022-05-23 <b>EUT</b> : Portable Bluetooth Speaker <b>Power Supply</b> : AC 120V/60Hz <b>Condition</b> : Temp:22.7°C,Humi:57..2%,Press:100.3kPa <b>Memo</b> : BT	D:\E3 6.11\2022 Report Data\Q22051721-2E XTREME2Q\配置 2\FCC BELOW 1G.EM6 <b>Tested By</b> : James Gan <b>Model Number</b> : XTREME 2Q (SH366003) <b>Test Mode</b> : Tx Mode <b>Antenna/Distance</b> : 2021 VLUB 9163 3#/3m/HORIZONTAL
---	---

Data:  
1

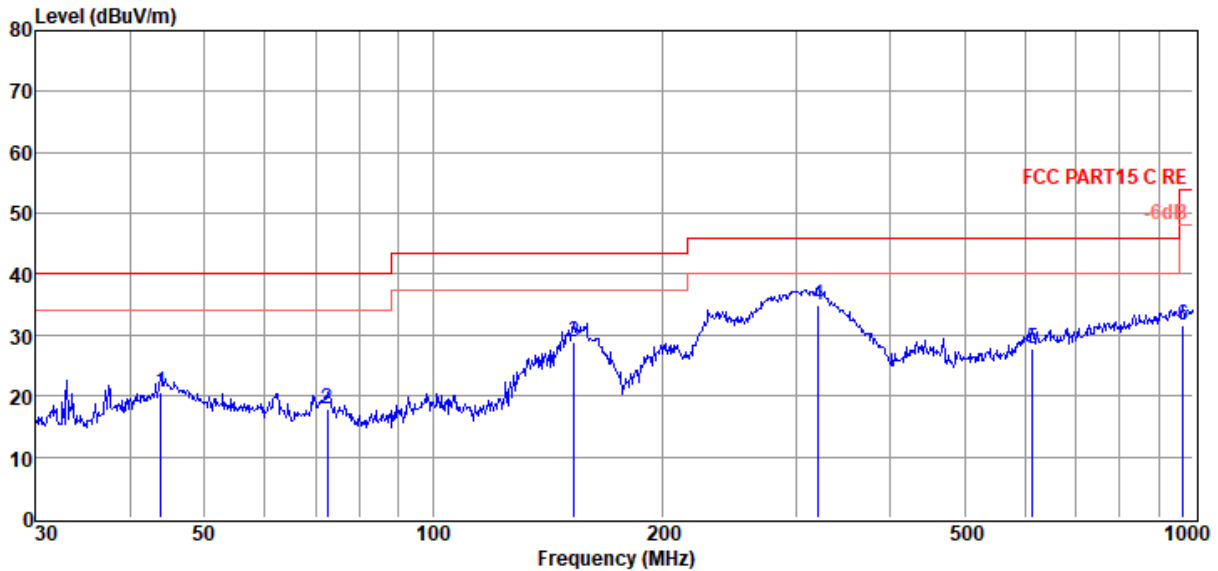

Item (Mark)	Freq. (MHz)	Read Level (dBμV)	Antenna Factor (dB/m)	Cable Loss dB	Result Level (dBμV/m)	Limit Line (dBμV/m)	Over Limit (dB)	Detector	Polarization
1	43.81	2.10	14.89	3.64	20.63	40.00	-19.37	QP	HORIZONTAL
2	72.59	5.05	8.84	3.84	17.73	40.00	-22.27	QP	HORIZONTAL
3	153.20	16.46	8.20	4.27	28.93	43.50	-14.57	QP	HORIZONTAL
4	321.06	16.23	13.74	4.90	34.87	46.00	-11.13	QP	HORIZONTAL
5	614.21	2.97	19.12	5.78	27.87	46.00	-18.13	QP	HORIZONTAL
6	968.93	2.66	22.18	6.67	31.51	54.00	-22.49	QP	HORIZONTAL

Note: 1. Result Level = Read Level + Antenna Factor + Cable loss.  
 2. If Peak Result complies with QP limit, QP Result is deemed to comply with QP limit.  
 3. Test setup: RBW: 120 kHz, VBW: 300 kHz, Sweep time: auto.



# TR-4-E-009 Radiated Emission Test Result

**Test Site** : DDT 3m Chamber 3#

D:\E3 6.11\2022 Report Data\Q22051721-2E XTREME2Q\配置 2\FCC BELOW 1G.EM6

**Test Date** : 2022-05-23

**Tested By** : James Gan

**EUT** : Portable Bluetooth Speaker

**Model Number** : XTREME 2Q (SH366003)

**Power Supply** : AC 120V/60Hz

**Test Mode** : Tx Mode

**Condition** : Temp:22.7°C,Humi:57.2%,Press:100.3kPa **Antenna/Distance** : 2021 VLUB 9163 3#/3m/VERTICAL

**Memo** : BT

Data:  
2

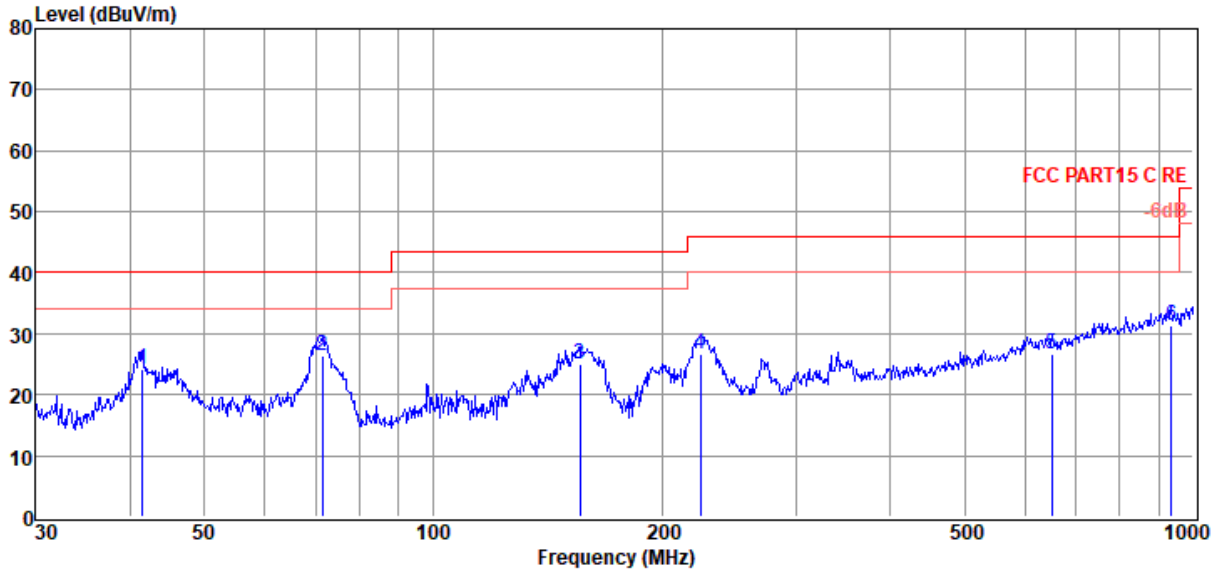

Item (Mark)	Freq. (MHz)	Read Level (dBμV)	Antenna Factor (dB/m)	Cable Loss (dB)	Result Level (dBμV/m)	Limit Line (dBμV/m)	Over Limit (dB)	Detector	Polarization
1	41.42	7.21	13.45	3.62	24.28	40.00	-15.72	QP	VERTICAL
2	71.58	13.80	8.90	3.83	26.53	40.00	-13.47	QP	VERTICAL
3	155.91	12.30	8.30	4.28	24.88	43.50	-18.62	QP	VERTICAL
4	224.52	10.44	11.76	4.56	26.76	46.00	-19.24	QP	VERTICAL
5	651.94	1.77	19.06	5.87	26.70	46.00	-19.30	QP	VERTICAL
6	935.55	2.40	22.29	6.54	31.23	46.00	-14.77	QP	VERTICAL

Note: 1. Result Level = Read Level + Antenna Factor + Cable loss.

2. If Peak Result complies with QP limit, QP Result is deemed to comply with QP limit.

3. Test setup: RBW: 120 kHz, VBW: 300 kHz, Sweep time: auto.

# TR-4-E-009 Radiated Emission Test Result

**Test Site** : DDT 3m Chamber 3#

D:\E3 6.11\2022 Report Data\Q22051721-2E  
XTREME2G\#1\FCC BELOW 1G.EM6

**Test Date** : 2022-06-09

**Tested By** : Kennys Zhang

**EUT** : Portable Bluetooth Speaker

**Model Number** : XTREME 2Q (BQ28Z610DRZR)

**Power Supply** : AC 120V/60Hz

**Test Mode** : Tx Mode

**Condition** : Temp:23.0°C,Humi:55.3%,Press:100.4kPa

**Antenna/Distance** : 2021 VLUB 9163 #3/3m/VERTICAL

**Memo** : BT

Data:  
1

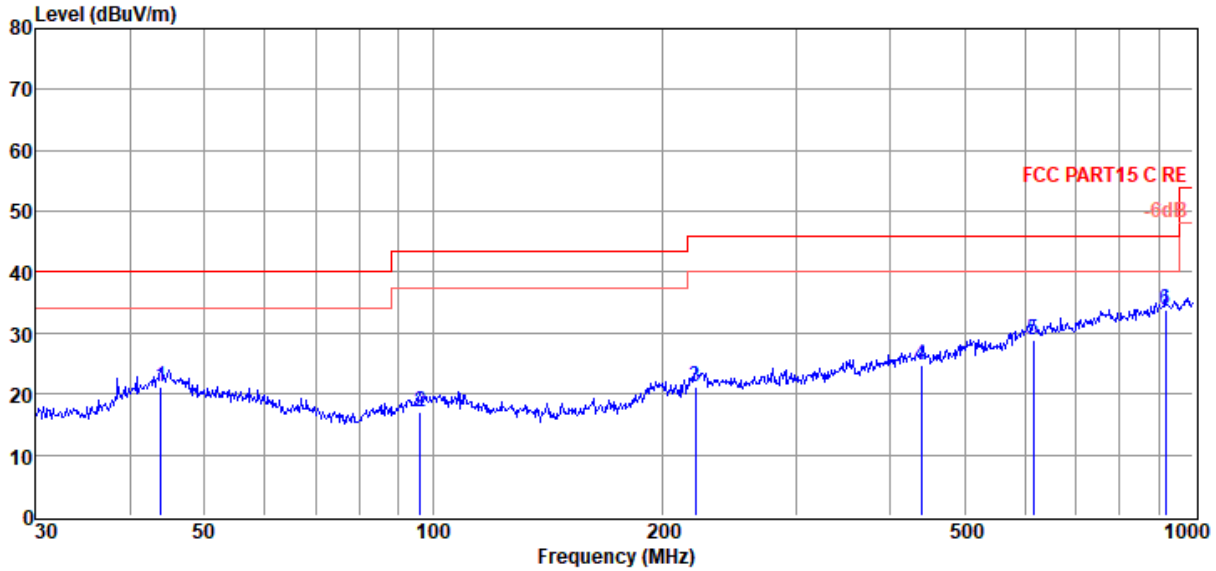

Item (Mark)	Freq. (MHz)	Read Level (dBµV)	Antenna Factor (dB/m)	Cable Loss (dB)	Result Level (dBµV/m)	Limit Line (dBµV/m)	Over Limit (dB)	Detector	Polarization
1	43.81	2.51	14.89	3.64	21.04	40.00	-18.96	QP	VERTICAL
2	96.10	1.88	11.22	3.96	17.06	43.50	-26.44	QP	VERTICAL
3	221.39	5.17	11.51	4.54	21.22	46.00	-24.78	QP	VERTICAL
4	438.66	3.31	16.13	5.29	24.73	46.00	-21.27	QP	VERTICAL
5	616.37	4.06	19.07	5.78	28.91	46.00	-17.09	QP	VERTICAL
6	919.29	4.84	22.40	6.52	33.76	46.00	-12.24	QP	VERTICAL

- Note: 1. Result Level = Read Level + Antenna Factor + Cable loss.  
 2. If Peak Result complies with QP limit, QP Result is deemed to comply with QP limit.  
 3. Test setup: RBW: 120 kHz, VBW: 300 kHz, Sweep time: auto.

# TR-4-E-009 Radiated Emission Test Result

**Test Site** : DDT 3m Chamber 3#

D:\E3 6.11\2022 Report Data\Q22051721-2E  
XTREME2G\#1\FCC BELOW 1G.EM6

**Test Date** : 2022-06-09

**Tested By** : Kennys Zhang

**EUT** : Portable Bluetooth Speaker

**Model Number** : XTREME 2Q (BQ28Z610DRZR)

**Power Supply** : AC 120V/60Hz

**Test Mode** : Tx Mode

**Condition** : Temp:23.0°C,Humi:55.3%,Press:100.4kPa

**Antenna/Distance** : 2021 VLUB 9163 #3/3m/HORIZONTAL

**Memo** : BT

Data:  
2

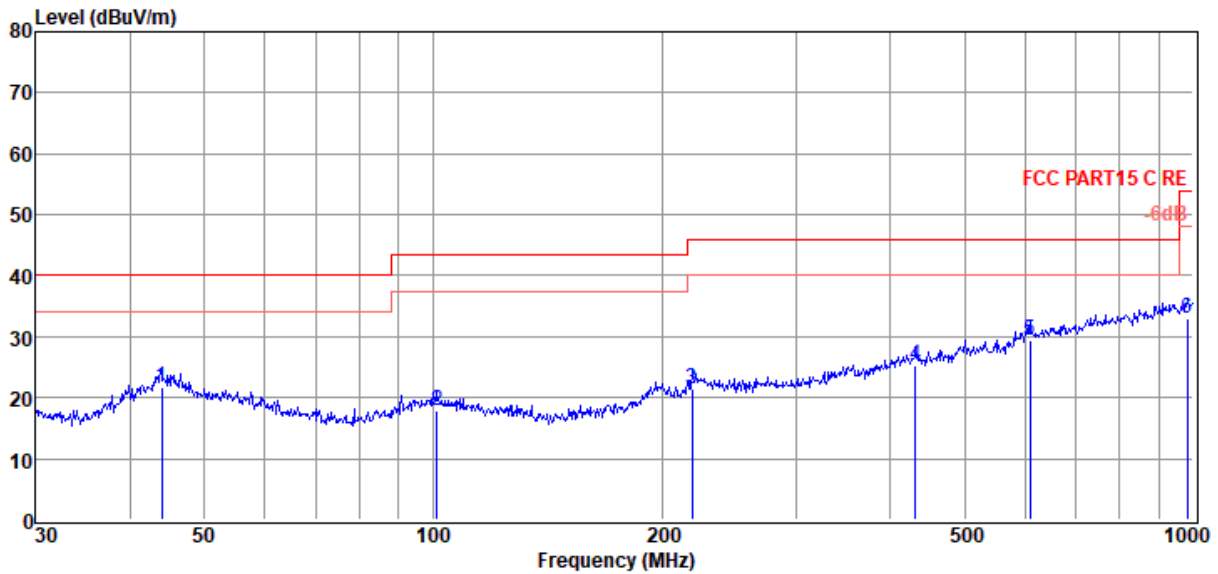

Item (Mark)	Freq. (MHz)	Read Level (dBμV)	Antenna Factor (dB/m)	Cable Loss (dB)	Result Level (dBμV/m)	Limit Line (dBμV/m)	Over Limit (dB)	Detector	Polarization
1	43.97	3.09	14.98	3.64	21.71	40.00	-18.29	QP	VERTICAL
2	101.29	2.28	11.60	3.99	17.87	43.50	-25.63	QP	VERTICAL
3	219.08	5.59	11.33	4.53	21.45	46.00	-24.55	QP	VERTICAL
4	431.03	3.84	16.12	5.26	25.22	46.00	-20.78	QP	VERTICAL
5	609.92	4.46	19.20	5.76	29.42	46.00	-16.58	QP	VERTICAL
6	982.62	4.02	22.35	6.75	33.12	54.00	-20.88	QP	VERTICAL

Note: 1. Result Level = Read Level + Antenna Factor + Cable loss.

2. If Peak Result complies with QP limit, QP Result is deemed to comply with QP limit.

3. Test setup: RBW: 120 kHz, VBW: 300 kHz, Sweep time: auto.

## 5. Power Line Conducted Emission

### 5.1. Block diagram of test setup

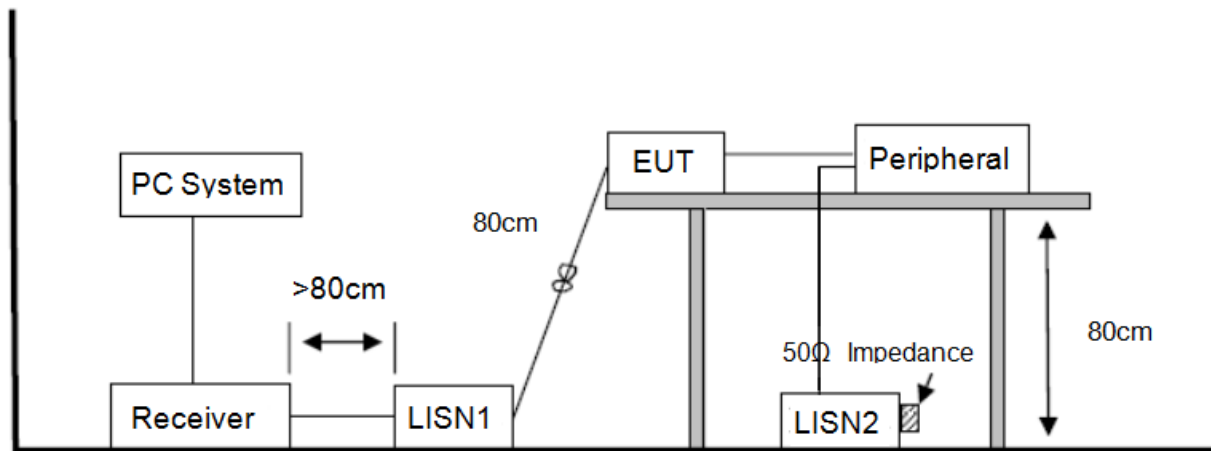

### 5.2. Power line conducted emission limits

Frequency	Quasi-Peak Level dB( $\mu$ V)	Average Level dB( $\mu$ V)
150 kHz ~ 500 kHz	66 ~ 56*	56 ~ 46*
500 kHz ~ 5 MHz	56	46
5 MHz ~ 30 MHz	60	50

Note 1: \* Decreasing linearly with logarithm of frequency.

Note 2: The lower limit shall apply at the transition frequencies.

### 5.3. Test procedure

The EUT and Support equipment, if needed, were put placed on a non-metallic table, 80cm above the ground plane.

Configuration EUT to simulate typical usage as described in clause 2.4 and test equipment as described in clause 10.2 of this report.

All I/O cables were positioned to simulate typical actual usage as per ANSI C63.10.

All support equipment power received from a second LISN.

Emissions were measured on each current carrying line of the EUT using an EMI Test Receiver connected to the LISN powering the EUT.

The Receiver scanned from 150 kHz to 30MHz for emissions in each of the test modes.

During the above scans, the emissions were maximized by cable manipulation.

The test mode(s) described in clause 2.4 were scanned during the preliminary test.

After the preliminary scan, we found the test mode producing the highest emission level.

The EUT configuration and worse cable configuration of the above highest emission levels were recorded for reference of the final test.

EUT and support equipment were set up on the test bench as per the configuration with highest emission level in the preliminary test.

A scan was taken on both power lines, Neutral and Line, recording at least the six highest emissions.

Emission frequency and amplitude were recorded into a computer in which correction factors were used to calculate the emission level and compare reading to the applicable limit.

The test data of the worst-case condition(s) was recorded.

The bandwidth of test receiver is set at 9 kHz.

#### 5.4. Test result

**Pass. (See below detailed test result)**

Note1: All emissions not reported below are too low against the prescribed limits.

Note2: "----" means Peak detection; "----" means Average detection.

Note3: Pre-test AC conducted emission at both voltage AC 120V/60Hz and AC 240V/60Hz, recorded worse case.

# TR-4-E-010 Conducted Emission Test Result

**Test Site** : DDT 1# Shield Room D:\2022 CE report date\Q22051721-2E\FCC.EM6  
**Test Date** : 2022-05-28 **Tested By** : James Gan  
**EUT** : Portable Bluetooth Speaker **Model Number** : XTREME 2Q (SH366003)  
**Power Supply** : AC 120V/60Hz **Test Mode** : TX Mode  
**Condition** : TEMP:22.1°C, RH:54.0%, BP:101.0kPa **LISN** : 2021 1# ENV216/LINE  
**Memo** : BT

Data: 6

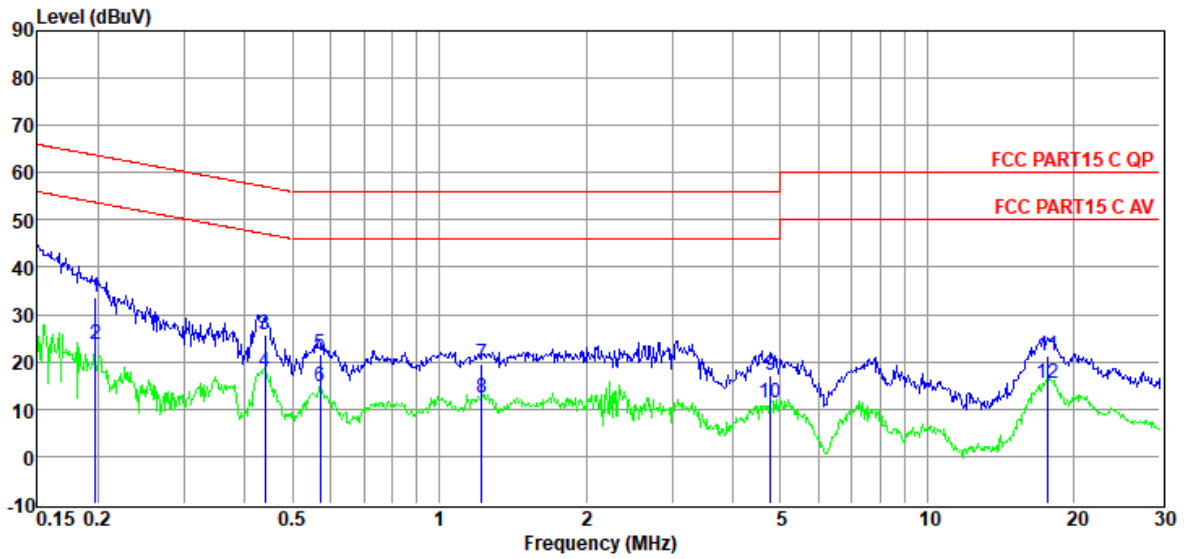

Item (Mark)	Freq. (MHz)	Read Level (dBuV)	LISN Factor (dB)	Cable Loss (dB)	Pulse Limiter Factor (dB)	Result Level (dBuV)	Limit Line (dBuV)	Over Limit (dB)	Detector	Phase
1	0.20	14.07	9.79	0.01	9.92	33.79	63.71	-29.92	QP	LINE
2	0.20	3.82	9.79	0.01	9.92	23.54	53.71	-30.17	Average	LINE
3	0.44	6.32	9.63	0.02	9.91	25.88	57.07	-31.19	QP	LINE
4	0.44	-1.64	9.63	0.02	9.91	17.92	47.07	-29.15	Average	LINE
5	0.57	2.03	9.56	0.02	9.91	21.52	56.00	-34.48	QP	LINE
6	0.57	-4.65	9.56	0.02	9.91	14.84	46.00	-31.16	Average	LINE
7	1.22	0.03	9.57	0.03	9.89	19.52	56.00	-36.48	QP	LINE
8	1.22	-7.07	9.57	0.03	9.89	12.42	46.00	-33.58	Average	LINE
9	4.77	-2.35	9.57	0.06	9.93	17.21	56.00	-38.79	QP	LINE
10	4.77	-8.13	9.57	0.06	9.93	11.43	46.00	-34.57	Average	LINE
11	17.66	1.59	9.69	0.16	9.95	21.39	60.00	-38.61	QP	LINE
12	17.66	-4.36	9.69	0.16	9.95	15.44	50.00	-34.56	Average	LINE

Note:

1. Result Level = Read Level + LISN Factor + Pulse Limiter Factor + Cable loss.
2. If QP Result complies with AV limit, AV Result is deemed to comply with AV limit.
3. Test setup: RBW: 200 Hz (9 kHz—150 kHz), 9 kHz (150 kHz—30 MHz).
4. Step size: 80Hz (0.009MHz-0.15MHz), 4 kHz (0.15MHz-30MHz), Scan time: auto.

# TR-4-E-010 Conducted Emission Test Result

**Test Site** : DDT 1# Shield Room D:\2022 CE report date\Q22051721-2E\FCC.EM6  
**Test Date** : 2022-05-28 **Tested By** : James Gan  
**EUT** : Portable Bluetooth Speaker **Model Number** : XTREME 2Q (SH366003)  
**Power Supply** : AC 120V/60Hz **Test Mode** : TX Mode  
**Condition** : TEMP:22.1°C, RH:54.0%, BP:101.0kPa **LISN** : 2021 1# ENV216/NEUTRAL  
**Memo** : BT

Data: 8

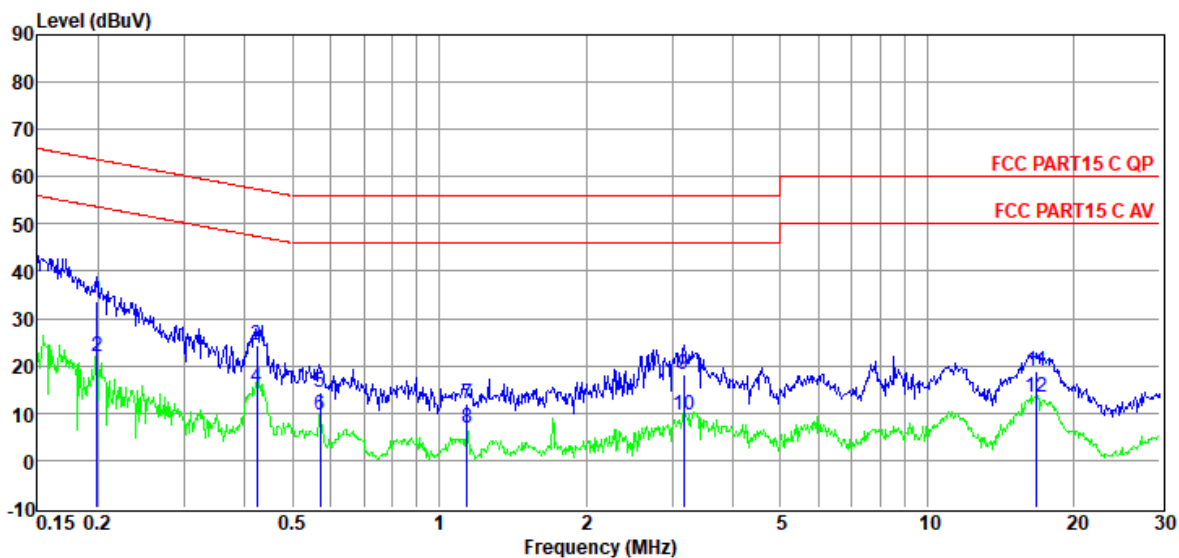

Item (Mark)	Freq. (MHz)	Read Level (dBuV)	LISN Factor (dB)	Cable Loss (dB)	Pulse Limiter Factor (dB)	Result Level (dBuV)	Limit Line (dBuV)	Over Limit (dB)	Detector	Phase
1	0.20	13.74	9.80	0.01	9.92	33.47	63.67	-30.20	QP	NEUTRAL
2	0.20	2.10	9.80	0.01	9.92	21.83	53.67	-31.84	Average	NEUTRAL
3	0.42	4.75	9.55	0.02	9.91	24.23	57.37	-33.14	QP	NEUTRAL
4	0.42	-4.17	9.55	0.02	9.91	15.31	47.37	-32.06	Average	NEUTRAL
5	0.57	-5.01	9.62	0.02	9.91	14.54	56.00	-41.46	QP	NEUTRAL
6	0.57	-9.97	9.62	0.02	9.91	9.58	46.00	-36.42	Average	NEUTRAL
7	1.14	-7.59	9.68	0.03	9.89	12.01	56.00	-43.99	QP	NEUTRAL
8	1.14	-12.69	9.68	0.03	9.89	6.91	46.00	-39.09	Average	NEUTRAL
9	3.17	-1.34	9.73	0.05	9.91	18.35	56.00	-37.65	QP	NEUTRAL
10	3.17	-10.22	9.73	0.05	9.91	9.47	46.00	-36.53	Average	NEUTRAL
11	16.75	-0.94	9.68	0.15	9.94	18.83	60.00	-41.17	QP	NEUTRAL
12	16.75	-6.37	9.68	0.15	9.94	13.40	50.00	-36.60	Average	NEUTRAL

Note:

1. Result Level = Read Level + LISN Factor + Pulse Limiter Factor + Cable loss.
2. If QP Result complies with AV limit, AV Result is deemed to comply with AV limit.
3. Test setup: RBW: 200 Hz (9 kHz—150 kHz), 9 kHz (150 kHz—30 MHz).
4. Step size: 80Hz (0.009MHz-0.15MHz), 4 kHz (0.15MHz-30MHz), Scan time: auto.

# TR-4-E-010 Conducted Emission Test Result

**Test Site** : DDT 1# Shield Room **D:\2022 CE report date\Q22051721-2E\FCC.EM6**  
**Test Date** : 2022-05-28 **Tested By** : James Gan  
**EUT** : Portable Bluetooth Speaker **Model Number** : XTREME 2Q (BQ28Z610DRZR)  
**Power Supply** : AC 120V/60Hz **Test Mode** : TX Mode  
**Condition** : TEMP:22.1°C, RH:54.0%, BP:101.0kPa **LISN** : 2021 1# ENV216/NEUTRAL  
**Memo** : BT

Data: 2

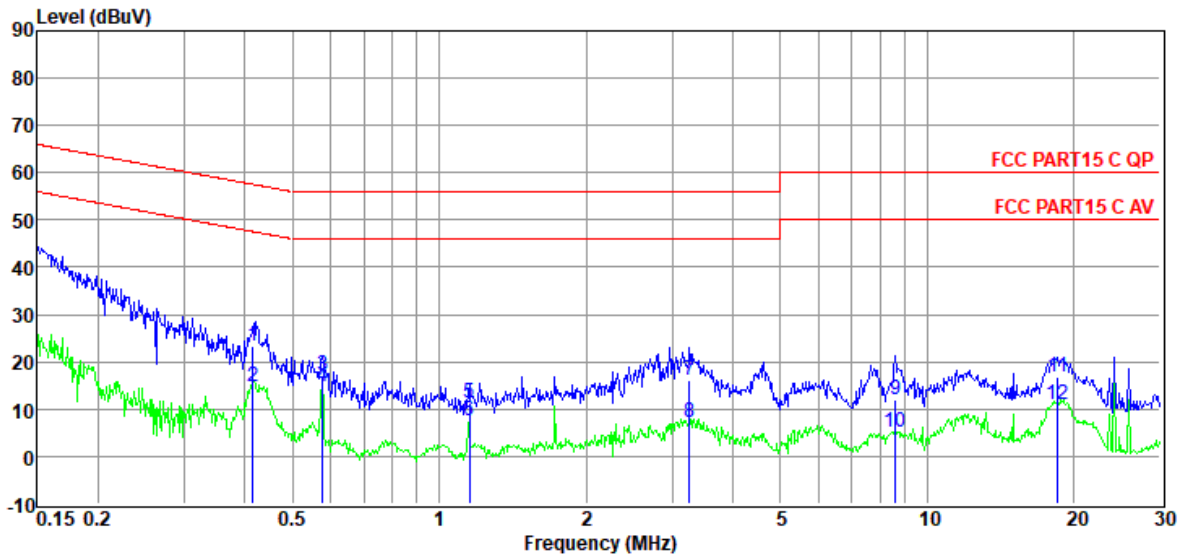

Item (Mark)	Freq. (MHz)	Read Level (dBμV)	LISN Factor (dB)	Cable Loss (dB)	Pulse Limiter Factor (dB)	Result Level (dBμV)	Limit Line (dBμV)	Over Limit (dB)	Detector	Phase
1	0.41	3.77	9.56	0.02	9.91	23.26	57.55	-34.29	QP	NEUTRAL
2	0.41	-4.66	9.56	0.02	9.91	14.83	47.55	-32.72	Average	NEUTRAL
3	0.58	-2.38	9.63	0.02	9.91	17.18	56.00	-38.82	QP	NEUTRAL
4	0.58	-4.91	9.63	0.02	9.91	14.65	46.00	-31.35	Average	NEUTRAL
5	1.15	-8.15	9.68	0.03	9.89	11.45	56.00	-44.55	QP	NEUTRAL
6	1.15	-11.95	9.68	0.03	9.89	7.65	46.00	-38.35	Average	NEUTRAL
7	3.26	-3.65	9.74	0.05	9.91	16.05	56.00	-39.95	QP	NEUTRAL
8	3.26	-12.42	9.74	0.05	9.91	7.28	46.00	-38.72	Average	NEUTRAL
9	8.59	-7.64	9.71	0.10	9.94	12.11	60.00	-47.89	QP	NEUTRAL
10	8.59	-14.64	9.71	0.10	9.94	5.11	50.00	-44.89	Average	NEUTRAL
11	18.52	-3.16	9.75	0.16	9.95	16.70	60.00	-43.30	QP	NEUTRAL
12	18.52	-8.81	9.75	0.16	9.95	11.05	50.00	-38.95	Average	NEUTRAL

Note:

1. Result Level = Read Level + LISN Factor + Pulse Limiter Factor + Cable loss.
2. If QP Result complies with AV limit, AV Result is deemed to comply with AV limit.
3. Test setup: RBW: 200 Hz (9 kHz—150 kHz), 9 kHz (150 kHz—30 MHz).
4. Step size: 80Hz (0.009MHz-0.15MHz), 4 kHz (0.15MHz-30MHz), Scan time: auto.



# TR-4-E-010 Conducted Emission Test Result

**Test Site** : DDT 1# Shield Room D:\2022 CE report date\Q22051721-2E\FCC.EM6  
**Test Date** : 2022-05-28 **Tested By** : James Gan  
**EUT** : Portable Bluetooth Speaker **Model Number** : XTREME 2Q (BQ28Z610DRZR)  
**Power Supply** : AC 120V/60Hz **Test Mode** : TX Mode  
**Condition** : TEMP:22.1°C, RH:54.0%, BP:101.0kPa **LISN** : 2021 1# ENV216/LINE  
**Memo** : BT

Data: 4

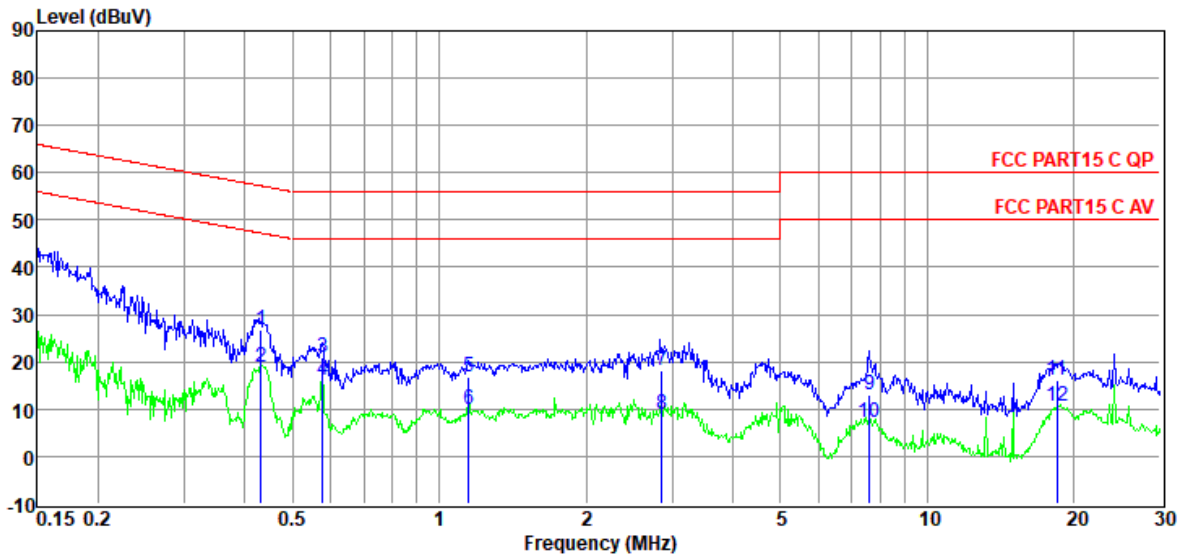

Item (Mark)	Freq. (MHz)	Read Level (dBuV)	LISN Factor (dB)	Cable Loss (dB)	Pulse Limiter Factor (dB)	Result Level (dBuV)	Limit Line (dBuV)	Over Limit (dB)	Detector	Phase
1	0.43	7.32	9.63	0.02	9.91	26.88	57.24	-30.36	QP	LINE
2	0.43	-0.63	9.63	0.02	9.91	18.93	47.24	-28.31	Average	LINE
3	0.58	1.40	9.56	0.02	9.91	20.89	56.00	-35.11	QP	LINE
4	0.58	-3.49	9.56	0.02	9.91	16.00	46.00	-30.00	Average	LINE
5	1.15	-2.78	9.58	0.03	9.89	16.72	56.00	-39.28	QP	LINE
6	1.15	-9.62	9.58	0.03	9.89	9.88	46.00	-36.12	Average	LINE
7	2.85	-1.39	9.55	0.05	9.91	18.12	56.00	-37.88	QP	LINE
8	2.85	-10.77	9.55	0.05	9.91	8.74	46.00	-37.26	Average	LINE
9	7.61	-6.36	9.50	0.09	9.94	13.17	60.00	-46.83	QP	LINE
10	7.61	-12.25	9.50	0.09	9.94	7.28	50.00	-42.72	Average	LINE
11	18.43	-3.67	9.66	0.16	9.95	16.10	60.00	-43.90	QP	LINE
12	18.43	-9.17	9.66	0.16	9.95	10.60	50.00	-39.40	Average	LINE

Note:

1. Result Level = Read Level + LISN Factor + Pulse Limiter Factor + Cable loss.
2. If QP Result complies with AV limit, AV Result is deemed to comply with AV limit.
3. Test setup: RBW: 200 Hz (9 kHz—150 kHz), 9 kHz (150 kHz—30 MHz).
4. Step size: 80Hz (0.009MHz-0.15MHz), 4 kHz (0.15MHz-30MHz), Scan time: auto.