

# FCC AND ISED CERTIFICATION TEST REPORT

## FOR

<b>Applicant</b>	:	Harman International Industries, Inc.
<b>Address</b>	:	8500 Balboa Boulevard, Northridge, CA 91329, UNITED STATES
<b>Equipment under Test</b>	:	3.1CH Soundbar with Virtual Dolby Atmos and Wireless Subwoofer
<b>FCC Model No.</b>	:	CINEMA SB580, CINEMA SB581, CINEMA SB582, CINEMA SB583, CINEMA SB584, CINEMA SB585, CINEMA SB586, CINEMA SB587, CINEMA SB588, CINEMA SB589, CINEMA SB590, CINEMA SB591, CINEMA SB592, CINEMA SB593, CINEMA SB594, CINEMA SB595, CINEMA SB596, CINEMA SB597, CINEMA SB598, CINEMA SB599
<b>IC Model No.</b>	:	CINEMA SB580
<b>Trade Mark</b>	:	JBL
<b>FCC ID</b>	:	APIJBLSB580SW
<b>IC</b>	:	6132A-JBLSB580SW
<b>HVIN</b>	:	JBLSB580SW
<b>Manufacturer</b>	:	Harman International Industries, Inc.
<b>Address</b>	:	8500 Balboa Boulevard, Northridge, CA 91329, UNITED STATES

**Issued By: Guangdong Dongdian Testing Service Co., Ltd.**

**Add.:** Unit 2, Building 1, No. 17, Zongbu 2nd Road, Songshan Lake Park,  
Dongguan, Guangdong, China, 523808

**Tel.:** +86-0769-38826678, **E-mail:** ddt@dgddt.com, <http://www.dgddt.com>

# REPORT

## Table of Contents

	Test report declares.....	3
1.	Summary of Test Results.....	6
2.	General Test Information .....	7
2.1.	Description of EUT .....	7
2.2.	Accessories of EUT.....	8
2.3.	Assistant equipment used for test.....	8
2.4.	Block diagram of EUT configuration for test .....	8
2.5.	Test environment conditions .....	8
2.6.	Deviations of test standard.....	8
2.7.	Test laboratory .....	9
2.8.	Measurement uncertainty.....	9
3.	Equipment Used During Test.....	10
4.	20 dB Bandwidth and 99% Bandwidth.....	11
4.1.	Block diagram of test setup.....	11
4.2.	Limits .....	11
4.3.	Test procedure .....	11
4.4.	Test result.....	11
4.5.	Original test data .....	12
5.	Duty cycle.....	14
5.1.	Block diagram of test setup.....	14
5.2.	Limit.....	14
5.3.	Test procedure .....	14
5.4.	Test result.....	14
5.5.	Test graphs .....	15
6.	Radiated Emission .....	16
6.1.	Block diagram of test setup.....	16
6.2.	Limit.....	17
6.3.	Test Procedure.....	19
6.4.	Test result.....	20
7.	Band Edge Compliance (Radiated Method) .....	30
7.1.	Block diagram of test setup.....	30
7.2.	Limit.....	30
7.3.	Test Procedure.....	30
7.4.	Test result.....	30
8.	Power Line Conducted Emission .....	35
8.1.	Block diagram of test setup.....	35
8.2.	Power line conducted emission limits .....	35

8.3. Test procedure ..... 35

8.4. Test result..... 36

9. Antenna Requirements ..... 39

9.1. Limit ..... 39

9.2. Result ..... 39

10. Test Setup Photograph ..... 40

11. Photos of the EUT ..... 42

## Test Report Declare

<b>Applicant</b>	:	Harman International Industries, Inc.
<b>Address</b>	:	8500 Balboa Boulevard, Northridge, CA 91329, UNITED STATES
<b>Equipment under Test</b>	:	3.1CH Soundbar with Virtual Dolby Atmos and Wireless Subwoofer
<b>FCC Model No.</b>	:	CINEMA SB580, CINEMA SB581, CINEMA SB582, CINEMA SB583, CINEMA SB584, CINEMA SB585, CINEMA SB586, CINEMA SB587, CINEMA SB588, CINEMA SB589, CINEMA SB590, CINEMA SB591, CINEMA SB592, CINEMA SB593, CINEMA SB594, CINEMA SB595, CINEMA SB596, CINEMA SB597, CINEMA SB598, CINEMA SB599
<b>IC Model No.</b>	:	CINEMA SB580
<b>Trade Mark</b>	:	JBL
<b>Manufacturer</b>	:	Harman International Industries, Inc.
<b>Address</b>	:	8500 Balboa Boulevard, Northridge, CA 91329, UNITED STATES

### Test Standard Used:

FCC Rules and Regulations Part 15 Subpart C, RSS-210 Issue 10 December 2019.

### Test procedure used:

ANSI C63.10:2013, RSS-Gen Issue 5, Apr. 2018.

### We Declare:

The equipment described above is tested by Guangdong Dongdian Testing Service Co., Ltd. and in the configuration tested the equipment complied with the standards specified above. The test results are contained in this test report and Guangdong Dongdian Testing Service Co., Ltd. is assumed of full responsibility for the accuracy and completeness of these tests.

**After test and evaluation, our opinion is that the equipment provided for test compliance with the requirement of the above FCC&ISED standards.**

<b>Report No:</b>	DDT-RE23071316-2E06		
<b>Date of Receipt:</b>	Jul. 25, 2023	<b>Date of Test:</b>	Jul. 25, 2023 ~ Oct. 21, 2023

**Prepared By:**

**Approved By:**

*Bobo Chen*

**Bobo Chen/Engineer**

*Damon Hu*

**Damon Hu/EMC Manager**

Note: This report applies to above tested sample only. This report shall not be reproduced in parts without written approval of Guangdong Dongdian Testing Service Co., Ltd.

## Revision History

Rev.	Revisions	Issue Date	Revised By
---	Initial issue	Nov. 20, 2023	

## 1. Summary of Test Results

The EUT have been tested according to the applicable standards as referenced below.		
Description of Test Item	Standard	Results
20dB Bandwidth and 99% Bandwidth	FCC Part 15: 15.215 ANSI C63.10:2013 RSS-210 Issue 10 RSS-Gen Issue 5	Pass
Radiated Emission	FCC Part 15: 15.205 FCC Part 15: 15.209 FCC Part 15: 15.249 ANSI C63.10:2013 RSS-210 Issue 10 RSS-Gen Issue 5	Pass
Band Edge Compliance	FCC Part 15: 15.205 FCC Part 15: 15.249 ANSI C63.10:2013 RSS-210 Issue 10 RSS-Gen Issue 5	Pass
Power Line Conducted Emission	FCC Part 15: 15.207 ANSI C63.10:2013 RSS-Gen Issue 5	Pass
Antenna requirement	FCC Part 15: 15.203 RSS-Gen Issue 5	Pass

## 2. General Test Information

### 2.1. Description of EUT

EUT Name	: 3.1CH Soundbar with Virtual Dolby Atmos and Wireless Subwoofer
FCC Model No.	: CINEMA SB580, CINEMA SB581, CINEMA SB582, CINEMA SB583, CINEMA SB584, CINEMA SB585, CINEMA SB586, CINEMA SB587, CINEMA SB588, CINEMA SB589, CINEMA SB590, CINEMA SB591, CINEMA SB592, CINEMA SB593, CINEMA SB594, CINEMA SB595, CINEMA SB596, CINEMA SB597, CINEMA SB598, CINEMA SB599
IC Model No.	: CINEMA SB580
Difference of models	: Above models are identical in schematic and structure, only the model number are different, therefore the test performed on the model CINEMA SB580.
EUT function description	: Please reference user manual of this device
Power supply	: AC 100-240V~ 50/60Hz 25W
Radio Specification	: 2.4G SRD
Operation frequency	: 2402 - 2481 MHz
Modulation	: GFSK
Antenna Gain	: 1.70 dBi
Sample Number	: S23071316-03

Note 1: EUT is the abbreviation of equipment under test.

Note 2: "☒" means to be chosen or applicable; "☐" means don't to be chosen or not applicable; This note applies to entire report.

Note 3: This report just for Subwoofer.

Channel information					
Channel	Frequency (MHz)	Channel	Frequency (MHz)	Channel	Frequency (MHz)
1	2402	15	2430	29	2458
2	2404	16	2432	30	2460
3	2406	17	2434	31	2462
4	2408	18	2436	32	2464
5	2410	19	2438	33	2466
6	2412	20	2440	34	2468
7	2414	21	2442	35	2470
8	2416	22	2444	36	2472
9	2418	23	2446	37	2474
10	2420	24	2448	38	2476
11	2422	25	2450	39	2478
12	2424	26	2452	40	2480
13	2426	27	2454	41	2481
14	2428	28	2456		

## 2.2. Accessories of EUT

Description of Accessories	Manufacturer	Model number	Serial No.	Other
AC cable	Harman	N/A	Length: 1.42m, Without magnetic ring	N/A
HDMI cable	Harman	N/A	Length: 1.14m, With two magnetic rings	N/A
Remote control	Harman	N/A	N/A	N/A

## 2.3. Assistant equipment used for test

Assistant equipment	Manufacturer	Model number	Serial No.	Other
N/A	N/A	N/A	N/A	N/A

## 2.4. Block diagram of EUT configuration for test

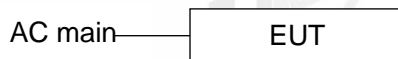

Test software: EMI\_Tool\_V26\_EverestekInc\_2023\_0202.exe

The test software was used to control EUT work in Continuous Tx mode, and select test channel, wireless mode as below table.

Tested mode, channel, information			
Mode	Setting Tx Power	Channel	Frequency (MHz)
GFSK Tx mode	Default	CH1	2402
	Default	CH20	2440
	Default	CH41	2481

## 2.5. Test environment conditions

During the measurement the environmental conditions were within the listed ranges:

Temperature range:	21-25 °C
Humidity range:	40-75%
Pressure range:	86-106 kPa

## 2.6. Deviations of test standard

No deviation.



## 2.7. Test laboratory

Guangdong Dongdian Testing Service Co., Ltd.

Add.: Unit 2, Building 1, No. 17, Zongbu 2nd Road, Songshan Lake Park, Dongguan, Guangdong, China, 523808

Tel.: +86-0769-38826678, <http://www.dgddt.com>, Email: [ddt@dgddt.com](mailto:ddt@dgddt.com).

CNAS Accreditation No. L6451; A2LA Accreditation Number: 3870.01

FCC Designation Number: CN1182, Test Firm Registration Number: 540522

Innovation, Science and Economic Development Canada Site Registration Number: 10288A

Conformity Assessment Body identifier: CN0048

VCCI facility registration number: C-20087, T-20088, R-20123, R-20155, G-20118

## 2.8. Measurement uncertainty

Test Item	Uncertainty
Bandwidth	1.1%
Peak Output Power (Conducted) (Spectrum Analyzer)	0.86 dB (10 MHz ≤ f < 3.6 GHz);
	1.38 dB (3.6 GHz ≤ f < 8 GHz)
Peak Output Power (Conducted) (Power Sensor)	0.74 dB
Power Spectral Density	0.74 dB (10 MHz ≤ f < 3.6 GHz);
	1.38 dB (3.6 GHz ≤ f < 8 GHz)
Frequencies Stability	6.7 × 10 <sup>-8</sup> (Antenna couple method)
	5.5 × 10 <sup>-8</sup> (Conducted method)
Conducted Spurious Emissions	0.86 dB (10 MHz ≤ f < 3.6 GHz);
	1.40 dB (3.6 GHz ≤ f < 8 GHz)
	1.66 dB (8 GHz ≤ f < 26.5 GHz)
Uncertainty for Radio Frequency (RBW < 20 kHz)	3×10 <sup>-8</sup>
Temperature	0.4 °C
Humidity	2 %
Uncertainty for Radiation Emission Test (9 kHz – 30 MHz)	3.44 dB
Uncertainty for Radiation Emission Test (30 MHz - 1 GHz)	4.70 dB (Antenna Polarize: V)
	4.84 dB (Antenna Polarize: H)
Uncertainty for Radiation Emission Test (1 GHz - 40 GHz)	4.10 dB (1 - 6 GHz)
	4.40 dB (6 GHz - 18 GHz)
	3.54 dB (18 GHz - 26 GHz)
	4.30 dB (26 GHz - 40 GHz)
Uncertainty for Power Line Conduction Emission Test	3.32 dB (150 kHz - 30 MHz)
Note: This uncertainty represents an expanded uncertainty expressed at approximately the 95% confidence level using a coverage factor of k=2.	

### 3. Equipment Used During Test

Equipment	Manufacturer	Model No.	Serial Number	Due Date
<input checked="" type="checkbox"/> RF Connected Test (RF Measurement System 3#)				
SIGNAL ANALYZER	R&S	FSV40	101407	2024/07/11
Wideband Radio Communication Tester	R&S	CMW500	117491	2024/04/26
EXG Analog Signal Generator	KEYSIGHT	N5173B	MY62153058	2024/07/11
MXG Vector Signal Generator	Agilent	N5182A	MY48180912	2024/04/22
RF Control Unit	Tonscend	JS0806-2	20C8060230	2024/04/26
TEMP&HUMI Programmable Chamber	ZHIXIANG	ZXGDJS-150L	ZX170110-A	2024/05/14
Test Software	Tonscend	JS1120-3	Ver.3.2.22	N/A
<input checked="" type="checkbox"/> Radiation 3#chamber				
EMI TEST RECEIVER	R&S	ESU26	100472	2024/04/22
PSA Series Spectrum Analyzer	Agilent	E4447A	MY50180031	2024/04/22
Active Loop Antenna	Schwarzbeck	FMZB-1519	1519-038	2024/09/10
Trilog Broadband Antenna	Schwarzbeck	VULB 9163	01429	2024/07/11
Double Ridged Horn Antenna	Schwarzbeck	BBHA 9120 D	02468	2024/09/17
Broad Band Horn Antenna	Schwarzbeck	BBHA 9170	790	2024/04/25
Pre-amplifier	COM-POWER	PAM-118A	18040084	2024/07/14
Pre-amplifier	COM-POWER	PAM-840A	461369	2024/04/26
RE Cable	N/A	W23.02 CP1-X2 + W23.09 AP1-X8+ JCT26S-NJ-NJ-1.5M	4.5M+8M+1.5M	2024/04/20
RF Cable	Yuhu	JCTB810-NJ-NJ-9M+ ZT26S-SMAJ-SMAJ-1M	21123964	2024/04/22
Band Reject Filter(2400-2500 MHz)	REBES	BRM50702	G555	N/A
Band Reject Filter(5150-5880 MHz)	REBES	BRM50716	G392	N/A
High Pass Filter(8000-25000 MHz)	XB	XBLBQ-GTA67	210820-2-3	N/A
Test Software	Tonscend	JS32-RE	V 5.0.0.1	N/A
<input checked="" type="checkbox"/> Power Line Conducted Emissions Test 2#				
Test Receiver	R&S	ESCI	101032	2024/04/22
LISN 1	R&S	ENV216	101170	2024/07/11
LISN 2	R&S	ENV216	101209	2024/07/11
Pulse Limiter	R&S	KH43101	431011801568-12#	2024/05/04
CE Cable 2	HUBSER	RG214-5	N/A	2024/04/26
Test software	Audix	E3	V 6.11111b	N/A

## 4. 20 dB Bandwidth and 99% Bandwidth

### 4.1. Block diagram of test setup

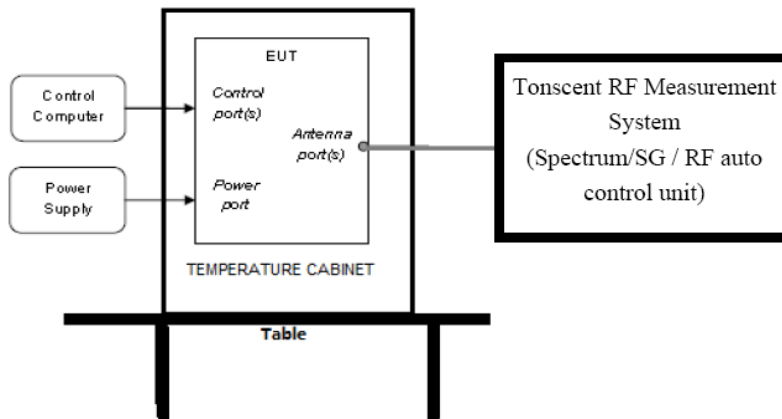

### 4.2. Limits

Intentional radiators operating under the alternative provisions to the general emission limits, as contained in § 15.217 through 15.257 and in Subpart E of this part, must be designed to ensure that the 20 dB bandwidth of the emission, or whatever bandwidth may otherwise be specified in the specific rule section under which the equipment operates, is contained within the frequency band designated in the rule section under which the equipment is operated.

### 4.3. Test procedure

(1) Connect EUT's antenna output to spectrum analyzer by RF cable.

(2) Set the spectrum analyzer as follows:

RBW:	1% to 5% of the OBW
VBW:	approximately three times RBW
Detector Mode:	Peak
Sweep time:	auto
Trace mode	Max hold

(3) Allow the trace to stabilize, measure the 20 dB bandwidth of signal and 99% bandwidth of signal.

### 4.4. Test result

Mode	Freq (MHz)	20 dB bandwidth Result (MHz)	99% bandwidth Result (MHz)	Limit (MHz)	Conclusion
GFSK	2402	1.101	0.987	/	Pass
	2440	1.107	0.979	/	Pass
	2481	1.101	0.979	/	Pass

4.5. Original test data

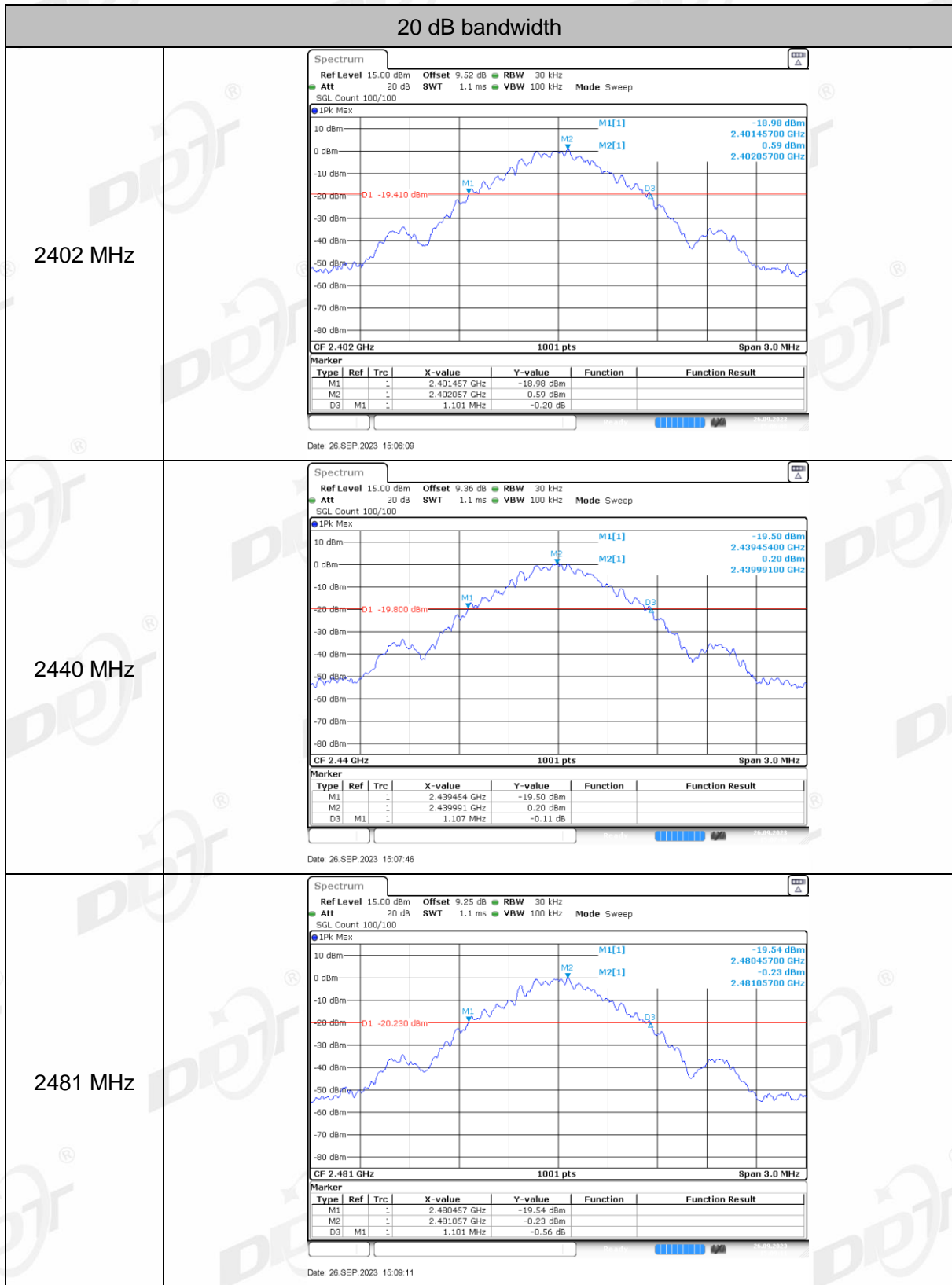

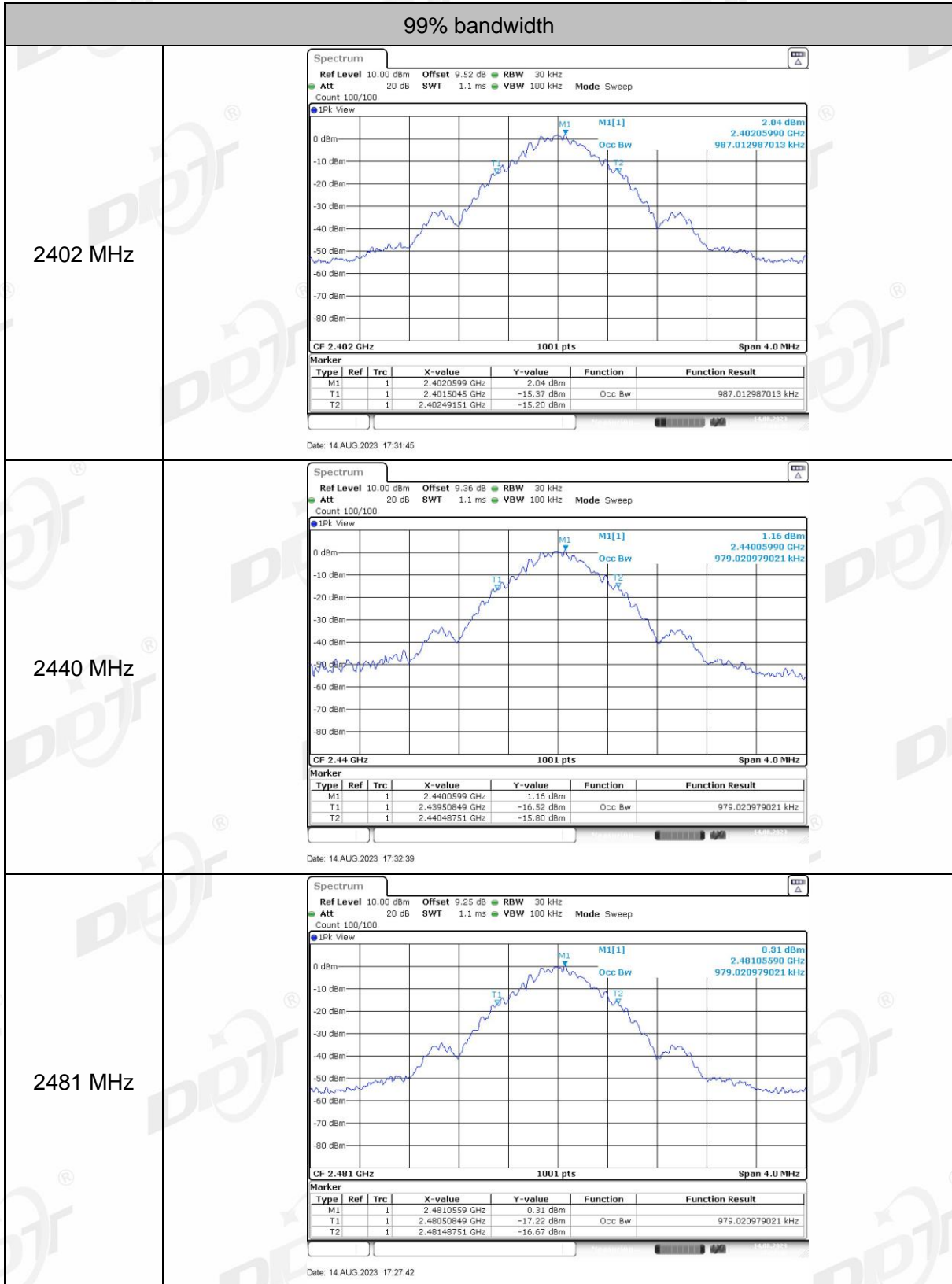

## 5. Duty cycle

### 5.1. Block diagram of test setup

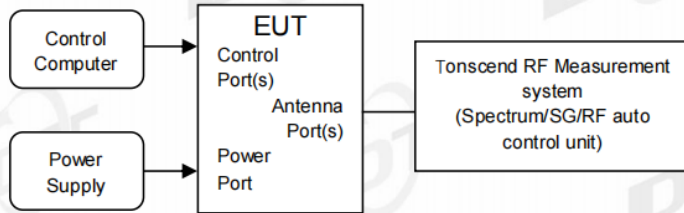

### 5.2. Limit

Just for Report.

### 5.3. Test procedure

- (1) Connected the EUT's antenna port to the Spectrum Analyzer by suitable attenuator, The cable loss and attenuator loss have been put into spectrum analyzer as amplitude offset.  
set the Spectrum Analyzer as below:

Centre Frequency: The centre frequency of the middle hopping channel.

Resolution BW: 10 MHz.

Video BW: 10 MHz.

Span: Zero span.

Detector: Peak.

Trace Mode: Clear Write.

Sweep: Video Trigger

- (2) When the trace is complete, measure the sending time of 1 burst and the duty cycle of 1 burst cycle.
- (3) Calculate dwell time follow below formula:  
Duty cycle= Pulse's on time / Burst cycle

### 5.4. Test result

Test Mode	Antenna	ON Time [ms]	Period [ms]	Duty Cycle [%]	Duty Cycle Factor[dB]
GFSK	Ant1	0.4058*2	100	0.812	20.91

5.5. Test graphs

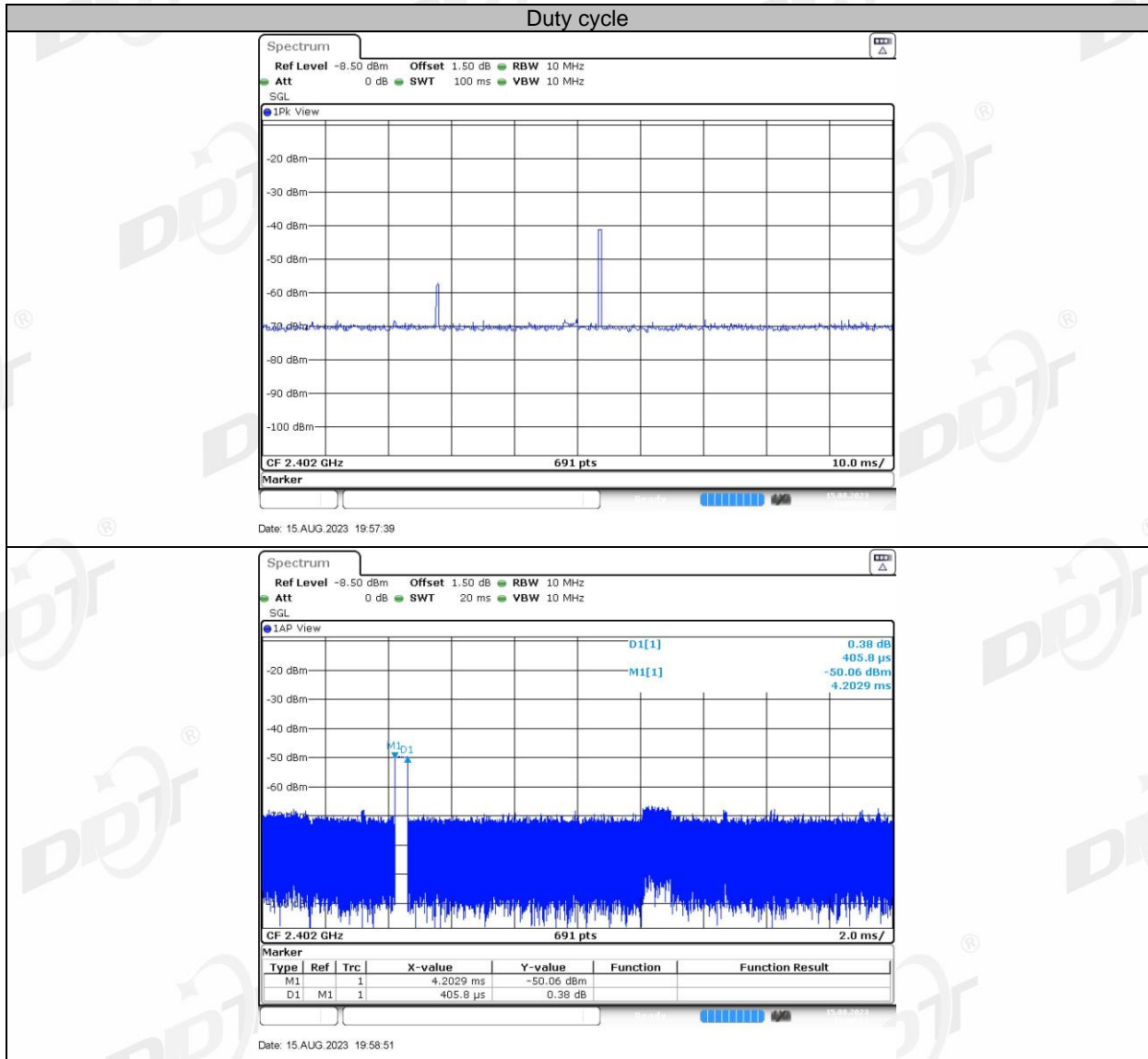

## 6. Radiated Emission

### 6.1. Block diagram of test setup

In 3 m Anechoic Chamber, test setup diagram for 9 kHz - 30 MHz:

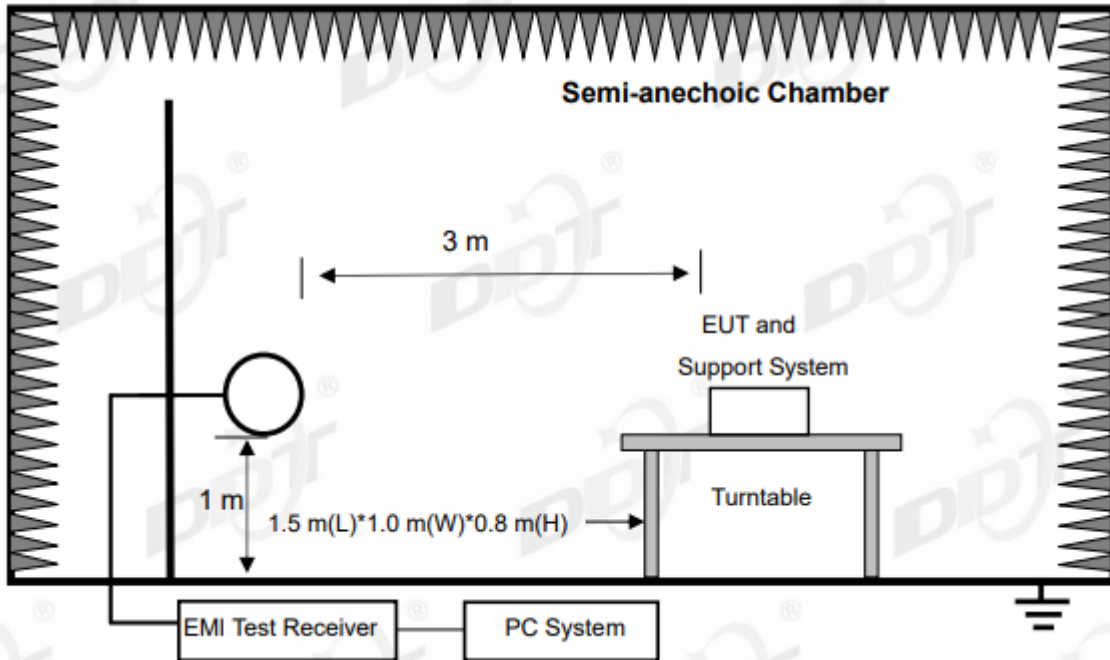

In 3 m Anechoic Chamber, test setup diagram for 30 MHz - 1 GHz:

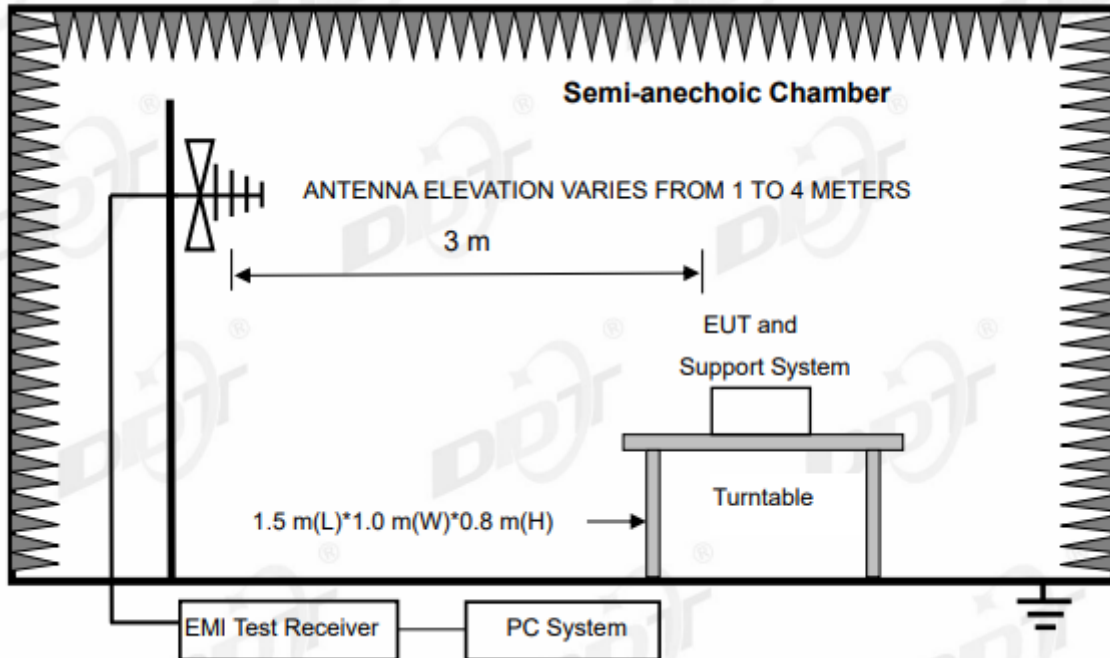



In 3 m Anechoic Chamber, test setup diagram for frequency above 1 GHz:

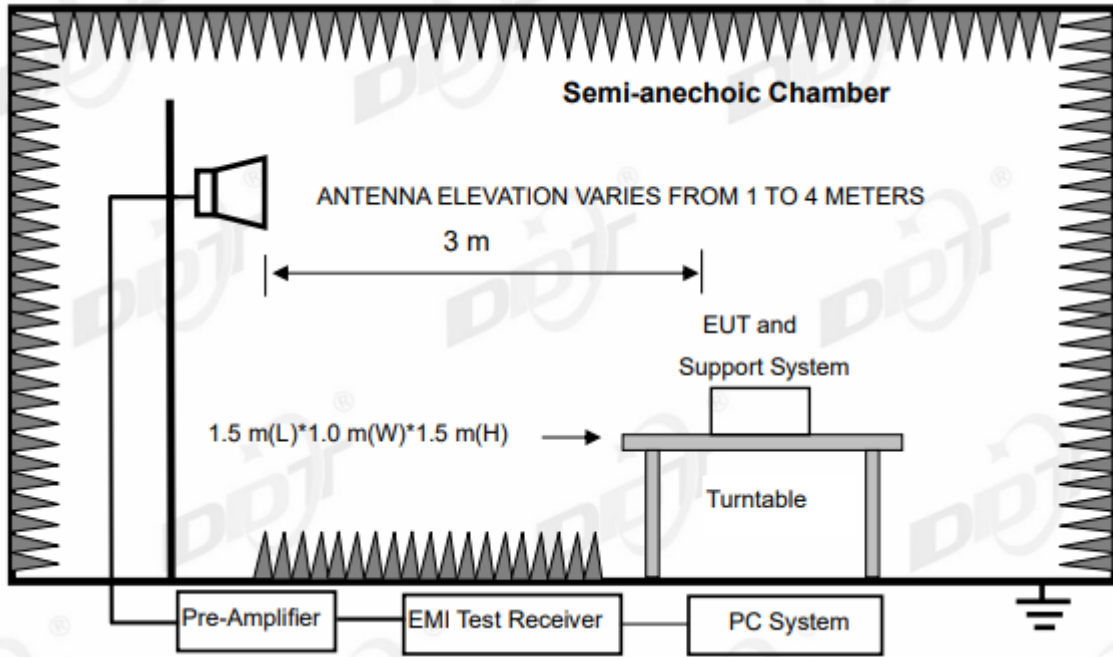

Note: For harmonic emissions test an appropriate high pass filter was inserted in the input port of AMP.

### 6.2. Limit

(1) FCC 15.205 Restricted frequency band

MHz	MHz	MHz	GHz
0.090-0.110	16.42-16.423	399.9-410	4.5-5.15
<sup>1</sup> 0.495-0.505	16.69475-16.69525	608-614	5.35-5.46
2.1735-2.1905	16.80425-16.80475	960-1240	7.25-7.75
4.125-4.128	25.5-25.67	1300-1427	8.025-8.5
4.1772&4.17775	37.5-38.25	1435-1626.5	9.0-9.2
4.2072&4.20775	73-74.6	1645.5-1646.5	9.3-9.5
6.215-6.218	74.8-75.2	1660-1710	10.6-12.7
6.26775-6.26825	108-121.94	1718.8-1722.2	13.25-13.4
6.31175-6.31225	123-138	2200-2300	14.47-14.5
8.291-8.294	149.9-150.05	2310-2390	15.35-16.2
8.362-8.366	156.52475-156.52525	2483.5-2500	17.7-21.4
8.37625-8.38675	156.7-156.9	2690-2900	22.01-23.12
8.41425-8.41475	162.0125-167.17	3260-3267	23.6-24.0
12.29-12.293	167.72-173.2	3332-3339	31.2-31.8
12.51975-12.52025	240-285	3345.8-3358	36.43-36.5
12.57675-12.57725	322-335.4	3600-4400	( <sup>2</sup> )
13.36-13.41			

<sup>1</sup>Until February 1, 1999, this restricted band shall be 0.490-0.510 MHz

<sup>2</sup>Above 38.6

## RSS-Gen section 8.10 Restricted frequency bands\*

MHz	MHz	MHz	GHz
0.090-0.110	12.51975-12.52025	240-285	3.5-4.4
0.495-0.505	12.57675-12.57725	322-335.4	4.5-5.15
2.1735-2.1905	13.36-13.41	399.9-410	5.35-5.46
3.020-3.026	16.42-16.423	608-614	7.25-7.75
4.125-4.128	16.69475-16.69525	960-1427	8.025-8.5
4.1772&4.17775	16.80425-16.80475	1435-1626.5	9.0-9.2
4.2072&4.20775	25.5-25.67	1645.5-1646.5	9.3-9.5
5.677-5.683	37.5-38.25	1660-1710	10.6-12.7
6.215-6.218	73-74.6	1718.8-1722.2	13.25-13.4
6.26775-6.26825	74.8-75.2	2200-2300	14.47-14.5
6.31175-6.31225	108-138	2310-2390	15.35-16.2
8.291-8.294	149.9-150.05	2483.5-2500	17.7-21.4
8.362-8.366	156.52475-156.52525	2655-2900	22.01-23.12
8.37625-8.38675	156.7-156.9	3260-3267	23.6-24.0
8.41425-8.41475	162.0125-167.17	3332-3339	31.2-31.8
12.29-12.293	167.72-173.2	3345.8-3358	36.43-36.5
			Above 38.6

\* Certain frequency bands listed in table and in bands above 38.6 GHz are designated for licence-exempt applications. These frequency bands and the requirements that apply to related devices are set out in the 200 and 300 series of RSSs.

## (2) FCC 15.209 Limit &amp; RSS-Gen section 8.9 Limit

FREQUENCY MHz	DISTANCE Meters	FIELD STRENGTHS LIMIT	
		$\mu\text{V}/\text{m}$	$\text{dB}(\mu\text{V})/\text{m}$
0.009 ~ 0.490	300	2400/F(kHz)	67.6-20log(F)
0.490 ~ 1.705	30	24000/F(kHz)	87.6-20log(F)
1.705 ~ 30.0	30	30	29.54
30 ~ 88	3	100	40.0
88 ~ 216	3	150	43.5
216 ~ 960	3	200	46.0
960 ~ 1000	3	500	54.0
Above 1000	3	74.0 dB( $\mu\text{V}$ )/m (Peak) 54.0 dB( $\mu\text{V}$ )/m (Average)	

Note: (1) The emission limits shown in the above table are based on measurements employing a CISPR QP detector except for the frequency bands 9 - 90 kHz, 110 - 490 kHz and above 1000 MHz, radiated emissions limits in these three bands are based on measurements employing an average detector.

(2) At frequencies below 30 MHz, measurement may be performed at a distance closer than that specified, and the limit at closer measurement distance can be extrapolated by below formula:

$$\text{Limit}_{3\text{m}}(\text{dBuV/m}) = \text{Limit}_{30\text{m}}(\text{dBuV/m}) + 40\text{Log}(30\text{m}/3\text{m})$$

(3) Limit for this EUT

The emissions appearing within 15.205 restricted frequency bands shall not exceed the limits shown in 15.209, and the emissions appearing within RSS-Gen section 8.10 Restricted frequency bands shall not exceed the limits shown in RSS-Gen section 8.9, all the other emissions shall be at least 20 dB below the fundamental emissions or comply with 15.209 limits and RSS-Gen section 8.9 limits.

### 6.3. Test Procedure

- (1) EUT was placed on a non-metallic table, 80 cm above the ground plane inside a semi-anechoic chamber for below 1G and 150 cm above the ground plane inside a fully-anechoic chamber for above 1G.
- (2) Test antenna was located 3 m from the EUT on an adjustable mast, and the antenna used as below table.

Test frequency range	Test antenna used	Test antenna distance
9 kHz - 30 MHz	Active Loop antenna	3 m
30 MHz - 1 GHz	Trilog Broadband Antenna	3 m
1 GHz - 18 GHz	Double Ridged Horn Antenna (1 GHz - 18 GHz)	3 m
18 GHz - 40 GHz	Horn Antenna (18 GHz - 40 GHz)	1 m

According ANSI C63.10:2013 clause 6.4.6 and 6.5.3, for measurements below 30 MHz, Antenna was located 3 m from EUT, the loop antenna was positioned in three antenna orientations (parallel, perpendicular, and round-parallel), for each measurement antenna alignment, the EUT shall be rotated through 0° to 360° on a turntable, and the lowest height of the magnetic antenna shall be 1 m above the ground. For measurement above 30MHz, the trilog Broadband Antenna or Horn Antenna was located 3m from EUT, Measurements were made with the antenna positioned in both the horizontal and vertical planes of Polarization, and the measurement antenna was varied from 1 m to 4 m. in height above the reference ground plane to obtain the maximum signal strength.

(3) Below pre-scan procedure was first performed in order to find prominent frequency spectrum radiated emissions from 9 kHz to 25 GHz:

- (a) Scanning the peak frequency spectrum with the antenna specified in step (3), and the EUT was rotated 360 degree, the antenna height was varied from 1 m to 4 m (Except loop antenna, it's fixed 1 m above ground.)
- (b) Change work frequency or channel of device if practicable.
- (c) Change modulation type of device if practicable.
- (d) Change power supply range from 85% to 115% of the rated supply voltage
- (e) Rotated EUT though three orthogonal axes to determine the attitude of EUT arrangement produces highest emissions.

Spectrum frequency from 9 kHz to 25 GHz (tenth harmonic of fundamental frequency) was investigated, and no any obvious emission were detected from 18 GHz to 25 GHz, so below final test was performed with frequency range from 9 kHz to 18 GHz.

- (4) For final emissions measurements at each frequency of interest, the EUT was rotated and the antenna height was varied between 1 m and 4 m in order to maximize the emission. Measurements in both horizontal and vertical polarities were made and the data was recorded. In order to find the maximum emission, the relative positions of equipment and all of the interface cables were changed according to ANSI C63.10:2013 on Radiated Emission test.
- (5) The emissions from 9 kHz to 1 GHz were measured based on CISPR QP detector except for the frequency bands 9 - 90 kHz, 110 - 490 kHz, for emissions from 9 kHz - 90 kHz, 110 kHz - 490 kHz and above 1 GHz were measured based on average detector, for emissions above 1 GHz, peak emissions also be measured and need comply with Peak limit.
- (6) The emissions from 9 kHz to 1 GHz, QP or average values were measured with EMI receiver with below RBW.

Frequency band	RBW
9 kHz - 150 kHz	200 Hz
150 kHz - 30 MHz	9 kHz
30 MHz - 1 GHz	120 kHz

- (7) For emissions above 1GHz, both Peak and Average level were measured with Spectrum Analyzer, and the RBW is set at 1 MHz, VBW is set at 3 MHz for Peak measure; According ANSI C63.10:2013 clause 4.1.4.2.2 procedure for average measure.

#### 6.4. Test result

Pass. (See below detailed test result)

All the emissions except fundamental emission from 9 kHz to 25 GHz were comply with 15.209 limits and RSS-Gen section 8.9 limits.

Note1: According exploratory test, the emission levels are 20 dB below the limit detected from 9 kHz to 30 MHz and 18 GHz to 25 GHz, so the final test was performed with frequency range from 30 MHz to 18 GHz and recorded in below.

Note2: For emissions below 1 GHz, according exploratory explorer test, when change Tx mode and channel, have no distinct influence on emissions level, so for emissions below 1 GHz, the final test was only performed with EUT working in GFSK, Tx 2480 MHz mode.

Note3: For emissions above 1 GHz. If peak results comply with AV limit, AV Result is deemed to comply with AV limit.

**Field Strength of the Fundamental Signal**

Mode	Freq. (MHz)	Reading [dB $\mu$ V/m]	Cable Loss (dB)	Antenna Factor (dB/m)	AMP (dB)	Result Level (dB $\mu$ V/m)	Limit (dB $\mu$ V/m)	Margin (dB)	Detector type	Polarization
GFSK	2402.00	106.85	3.88	27.50	-40.14	98.09	114.00	-15.91	Peak	HORIZONTAL
GFSK	2402.00	/				77.18	94.00	-16.82	Average	HORIZONTAL
GFSK	2402.00	111.77	3.88	27.50	-40.14	103.01	114.00	-10.99	Peak	VERTICAL
GFSK	2402.00	/				82.1	94.00	-11.90	Average	VERTICAL
GFSK	2440.00	102.80	3.90	27.58	-38.26	96.02	114.00	-17.98	Peak	HORIZONTAL
GFSK	2440.00	/				75.11	94.00	-18.89	Average	HORIZONTAL
GFSK	2440.00	106.71	3.90	27.58	-38.26	99.93	114.00	-14.07	Peak	VERTICAL
GFSK	2440.00	/				79.02	94.00	-14.98	Average	VERTICAL
GFSK	2481.00	105.29	3.94	27.72	-40.23	96.72	114.00	-17.28	Peak	HORIZONTAL
GFSK	2481.00	/				75.81	94.00	-18.19	Average	HORIZONTAL
GFSK	2481.00	109.56	3.94	27.72	-40.23	100.99	114.00	-13.01	Peak	VERTICAL
GFSK	2481.00	/				80.08	94.00	-13.92	Average	VERTICAL

Note: Peak Result Level = Read Level + Cable loss + Antenna Factor + AMP.

Average Result Level = Peak Result Level - Duty Cycle Factor

# Radiated Emission test (below 1 GHz)

## TR-4-E-009 Radiated Emission Test Result

**Test Date:** 2023-08-04      **Tested By:** Bairong  
**EUT:** 3.1CH Soundbar with Virtual Dolby Atmos and Wireless Subwoofer      **Model Number:** CINEMA SB580  
**Test Mode:** Tx mode      **Power Supply:** AC 120V/60Hz  
**Condition:** Temp:21.7°C;Humi:64.9%      **Test Site:** DDT 3# Chamber  
**File Path:** d:\ts\2023 report data\Q23071316-2E SB580\FCC BELOW 1G\20230804-010154\_H  
**Memo:**

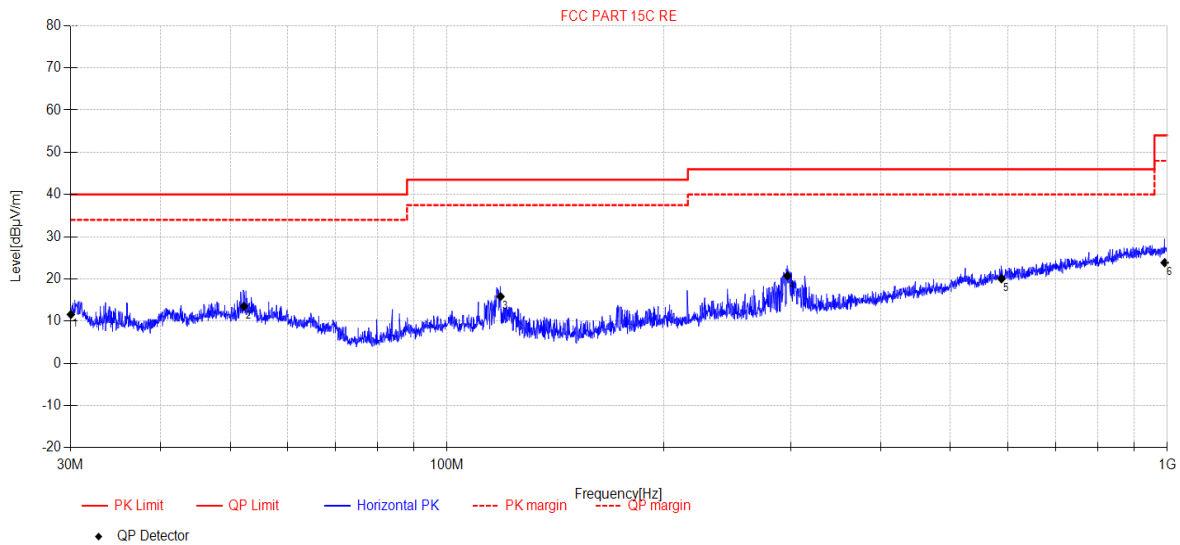

Final Data List										
NO.	Freq. [MHz]	Reading [dBµV/m]	Antenna Factor [dB]	Cable Loss [dB]	AMP [dB]	Result [dBµV/m]	Limit [dBµV/m]	Margin [dB]	Detector	Polarity
1	30.04	27.92	10.20	4.47	-31.00	11.59	40.00	28.41	QP	Horizontal
2	52.24	26.47	12.98	4.74	-30.69	13.50	40.00	26.50	QP	Horizontal
3	118.65	32.54	8.97	5.16	-30.84	15.83	43.50	27.67	QP	Horizontal
4	296.88	31.71	13.18	6.14	-30.31	20.72	46.00	25.28	QP	Horizontal
5	588.55	24.19	18.47	7.28	-29.90	20.04	46.00	25.96	QP	Horizontal
6	991.62	20.37	23.00	8.66	-28.18	23.85	54.00	30.15	QP	Horizontal

**Note:**

1. Result Level = Reading + Cable loss + Antenna Factor + AMP
2. If Peak Result complies with QP limit, QP Result is deemed to comply with QP limit.
3. Test setup: RBW: 120 kHz, VBW: 300 kHz, Sweep time: auto.

# TR-4-E-009 Radiated Emission Test Result

**Test Date:** 2023-08-04 **Tested By:** Bairong  
**EUT:** 3.1CH Soundbar with Virtual Dolby Atmos and Wireless Subwoofer **Model Number:** CINEMA SB580  
**Test Mode:** Tx mode **Power Supply:** AC 120V/60Hz  
**Condition:** Temp:21.7°C;Humi:64.9% **Test Site:** DDT 3# Chamber  
**File Path:** d:\ts\2023 report data\Q23071316-2E SB580\FCC BELOW 1G\20230804-010236\_V

**Memo:**

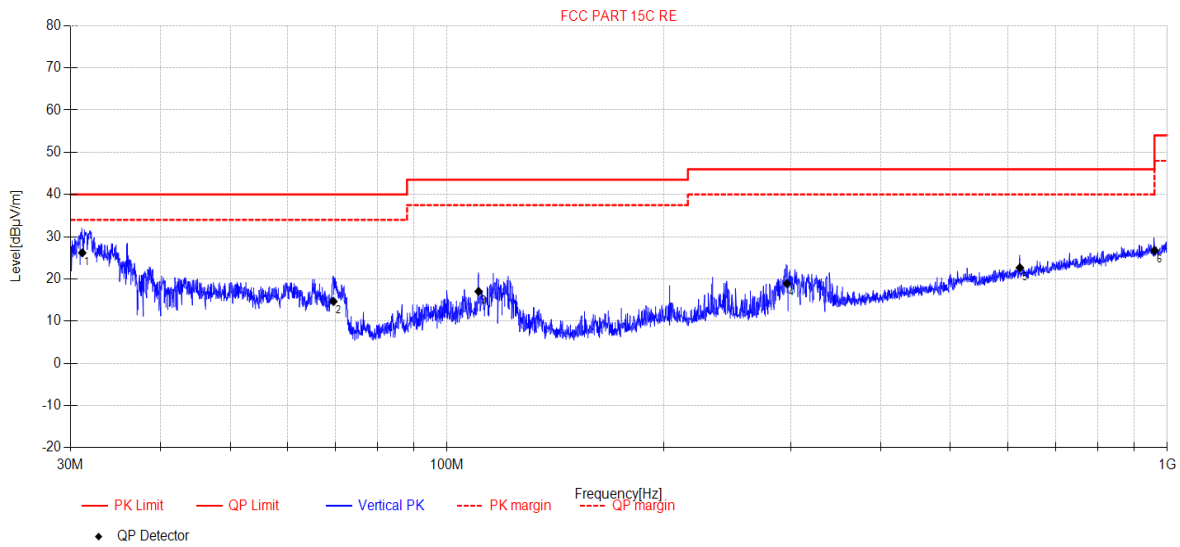

**Final Data List**

NO.	Freq. [MHz]	Reading [dBµV/m]	Antenna Factor [dB]	Cable Loss [dB]	AMP [dB]	Result [dBµV/m]	Limit [dBµV/m]	Margin [dB]	Detector	Polarity
1	31.16	42.35	10.32	4.49	-30.98	26.18	40.00	13.82	QP	Vertical
2	69.54	31.78	8.68	4.79	-30.57	14.68	40.00	25.32	QP	Vertical
3	110.62	32.4	10.38	5.12	-30.87	17.03	43.50	26.47	QP	Vertical
4	296.46	29.9	13.16	6.14	-30.31	18.89	46.00	27.11	QP	Vertical
5	624.26	26.12	18.99	7.43	-29.90	22.64	46.00	23.36	QP	Vertical
6	960.15	23.95	22.70	8.55	-28.46	26.74	54.00	27.26	QP	Vertical

**Note:**

1. Result Level = Reading + Cable loss + Antenna Factor + AMP
2. If Peak Result complies with QP limit, QP Result is deemed to comply with QP limit.
3. Test setup: RBW: 120 kHz, VBW: 300 kHz, Sweep time: auto.

# Radiated Emission test (above 1 GHz) TR-4-E-009 Radiated Emission Test Result

**Test Date:** 2023-08-04      **Tested By:** Bairong  
**EUT:** 3.1CH Soundbar with Virtual Dolby Atmos and Wireless Subwoofer      **Model Number:** CINEMA SB580  
**Test Mode:** Tx mode      **Power Supply:** AC 120V/60Hz  
**Condition:** Temp:21.7°C;Humi:64.9%      **Test Site:** DDT 3# Chamber  
**File Path:** d:\ts\2023 report data\Q23071316-2E SB580\FCC ABOVE 1G\33  
**Memo:** GFSK 2402MHz

## Test Graph

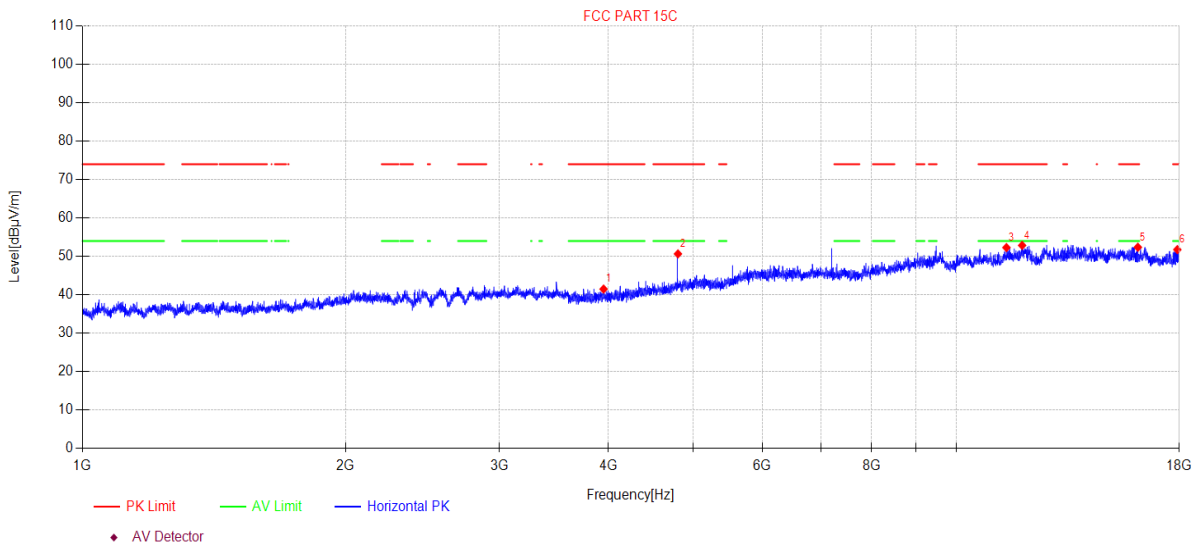

Suspected Data List										
N O.	Freq. [MHz]	Reading [dBµV/m]	Cable loss [dB]	Antenna Factor [dB]	AMP [dB]	Level [dBµV/m]	Limit [dBµV/m]	Margin [dB]	Detector	Polarity
1	3948.62	46.42	5.84	30.60	-41.37	41.49	74.00	32.51	PK	Horizontal
2	4803.36	52.03	7.47	32.31	-41.16	50.65	74.00	23.35	PK	Horizontal
3	11414.62	43.02	10.02	39.09	-39.84	52.29	74.00	21.71	PK	Horizontal
4	11896.25	42.67	10.45	38.80	-39.07	52.85	74.00	21.15	PK	Horizontal
5	16137.19	39.67	15.34	37.76	-40.39	52.38	74.00	21.62	PK	Horizontal
6	17906.60	38.16	13.02	41.24	-40.66	51.76	74.00	22.24	PK	Horizontal

**Note:**

- Level = Reading + Cable loss + Antenna Factor + AMP
- If Peak Result complies with AV limit, AV Result is deemed to comply with AV limit.
- Test setup: RBW: 1 MHz, VBW: 3 MHz, Sweep time: auto.



# TR-4-E-009 Radiated Emission Test Result

**Test Date:** 2023-08-04      **Tested By:** Bairong  
**EUT:** 3.1CH Soundbar with Virtual Dolby Atmos and Wireless Subwoofer      **Model Number:** CINEMA SB580  
**Test Mode:** Tx mode      **Power Supply:** AC 120V/60Hz  
**Condition:** Temp:21.7°C;Humi:64.9%      **Test Site:** DDT 3# Chamber  
**File Path:** d:\ts\2023 report data\Q23071316-2E SB580\FCC ABOVE 1G\34  
**Memo:** GFSK 2402MHz

## Test Graph

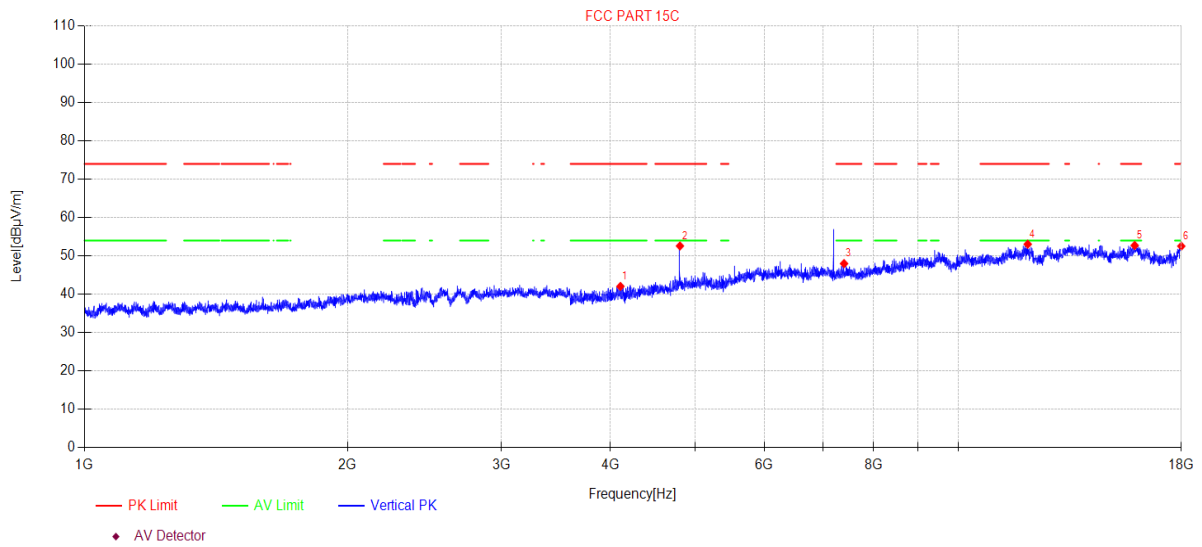

Suspected Data List										
N O.	Freq. [MHz]	Reading [dBµV/m]	Cable loss [dB]	Antenna Factor [dB]	AMP [dB]	Level [dBµV /m]	Limit [dBµV /m]	Margin [dB]	Detector	Polarity
1	4105.73	46.45	6.06	30.91	-41.37	42.05	74.00	31.95	PK	Vertical
2	4803.36	53.98	7.47	32.31	-41.16	52.60	74.00	21.40	PK	Vertical
3	7401.42	44.85	7.64	36.50	-41.00	47.99	74.00	26.01	PK	Vertical
4	12010.25	42.50	10.54	38.92	-38.91	53.05	74.00	20.95	PK	Vertical
5	15919.48	39.48	15.52	38.06	-40.34	52.72	74.00	21.28	PK	Vertical
6	18000.00	38.31	13.13	41.80	-40.70	52.54	74.00	21.46	PK	Vertical

**Note:**

- Level = Reading + Cable loss + Antenna Factor + AMP
- If Peak Result complies with AV limit, AV Result is deemed to comply with AV limit.
- Test setup: RBW: 1 MHz, VBW: 3 MHz, Sweep time: auto.

# TR-4-E-009 Radiated Emission Test Result

**Test Date:** 2023-08-04      **Tested By:** Bairong  
**EUT:** 3.1CH Soundbar with Virtual Dolby Atmos and Wireless Subwoofer      **Model Number:** CINEMA SB580  
**Test Mode:** Tx mode      **Power Supply:** AC 120V/60Hz  
**Condition:** Temp:21.7°C;Humi:64.9%      **Test Site:** DDT 3# Chamber  
**File Path:** d:\ts\2023 report data\Q23071316-2E SB580\FCC ABOVE 1G\35  
**Memo:** GFSK 2440MHz

## Test Graph

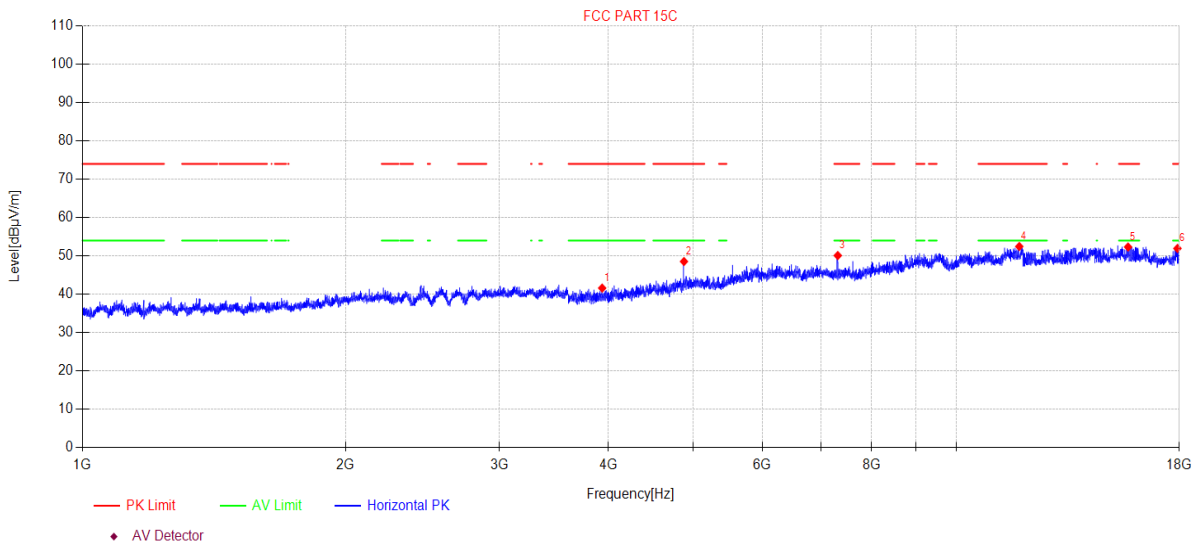

Suspected Data List										
N O.	Freq. [MHz]	Reading [dBµV/m]	Cable loss [dB]	Antenna Factor [dB]	AMP [dB]	Level [dBµV/m]	Limit [dBµV/m]	Margin [dB]	Detector	Polarity
1	3933.82	46.56	5.84	30.57	-41.36	41.61	74.00	32.39	PK	Horizontal
2	4880.32	49.49	7.63	32.56	-41.14	48.54	74.00	25.46	PK	Horizontal
3	7318.46	46.97	7.63	36.50	-41.00	50.10	74.00	23.90	PK	Horizontal
4	11807.19	42.50	10.37	38.80	-39.21	52.46	74.00	21.54	PK	Horizontal
5	15727.41	39.62	14.65	38.27	-40.21	52.33	74.00	21.67	PK	Horizontal
6	17911.78	38.32	13.02	41.27	-40.66	51.95	74.00	22.05	PK	Horizontal

**Note:**

- Level = Reading + Cable loss + Antenna Factor + AMP
- If Peak Result complies with AV limit, AV Result is deemed to comply with AV limit.
- Test setup: RBW: 1 MHz, VBW: 3 MHz, Sweep time: auto.

# TR-4-E-009 Radiated Emission Test Result

**Test Date:** 2023-08-04      **Tested By:** Bairong  
**EUT:** 3.1CH Soundbar with Virtual Dolby Atmos and Wireless Subwoofer      **Model Number:** CINEMA SB580  
**Test Mode:** Tx mode      **Power Supply:** AC 120V/60Hz  
**Condition:** Temp:21.7°C;Humi:64.9%      **Test Site:** DDT 3# Chamber  
**File Path:** d:\ts\2023 report data\Q23071316-2E SB580\FCC ABOVE 1G\36  
**Memo:** GFSK 2440MHz

## Test Graph

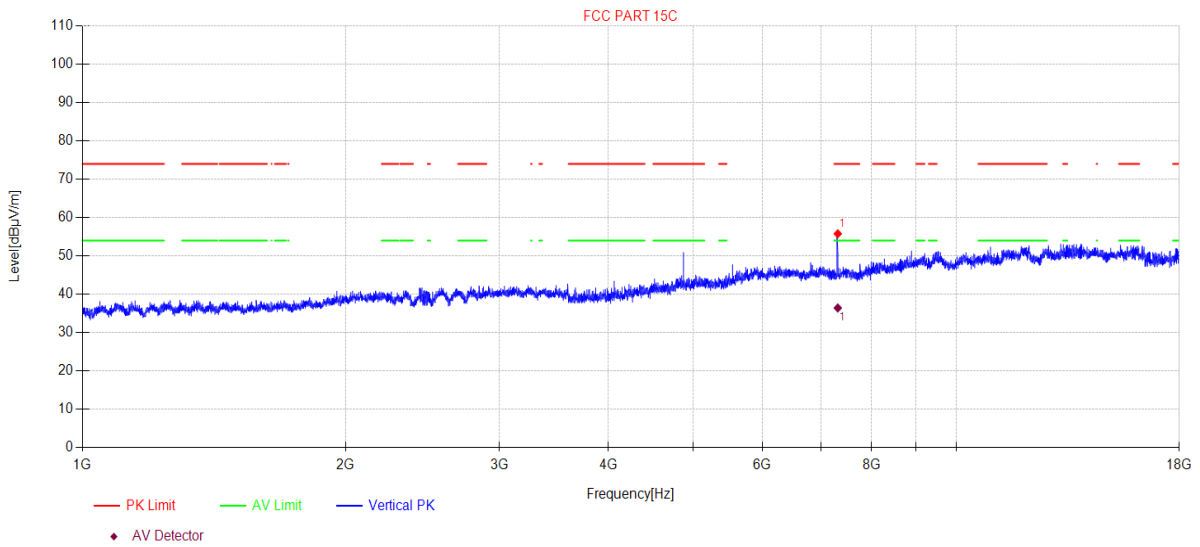

Suspected Data List										
N O.	Freq. [MHz]	Reading [dBµV/m]	Cable loss [dB]	Antenna Factor [dB]	AMP [dB]	Level [dBµV/m]	Limit [dBµV/m]	Margin [dB]	Detector	Polarity
1	7318.46	52.64	7.63	36.50	-41.00	55.77	74.00	18.23	PK	Vertical

Final Data List										
N O.	Freq. [MHz]	Reading [dBµV/m]	Cable loss [dB]	Antenna Factor [dB]	AMP [dB]	Level [dBµV/m]	Limit [dBµV/m]	Margin [dB]	Detector	Polarity
1	7318.46	33.31	7.63	36.50	-41.00	36.44	54.00	17.56	AV	Vertical

**Note:**

- Level = Reading + Cable loss + Antenna Factor + AMP
- If Peak Result complies with AV limit, AV Result is deemed to comply with AV limit.
- Test setup: RBW: 1 MHz, VBW: 3 MHz, Sweep time: auto.

# TR-4-E-009 Radiated Emission Test Result

**Test Date:** 2023-08-04      **Tested By:** Bairong  
**EUT:** 3.1CH Soundbar with Virtual Dolby Atmos and Wireless Subwoofer      **Model Number:** CINEMA SB580  
**Test Mode:** Tx mode      **Power Supply:** AC 120V/60Hz  
**Condition:** Temp:21.7°C;Humi:64.9%      **Test Site:** DDT 3# Chamber  
**File Path:** d:\ts\2023 report data\Q23071316-2E SB580\FCC ABOVE 1G\37  
**Memo:** GFSK 2481MHz

## Test Graph

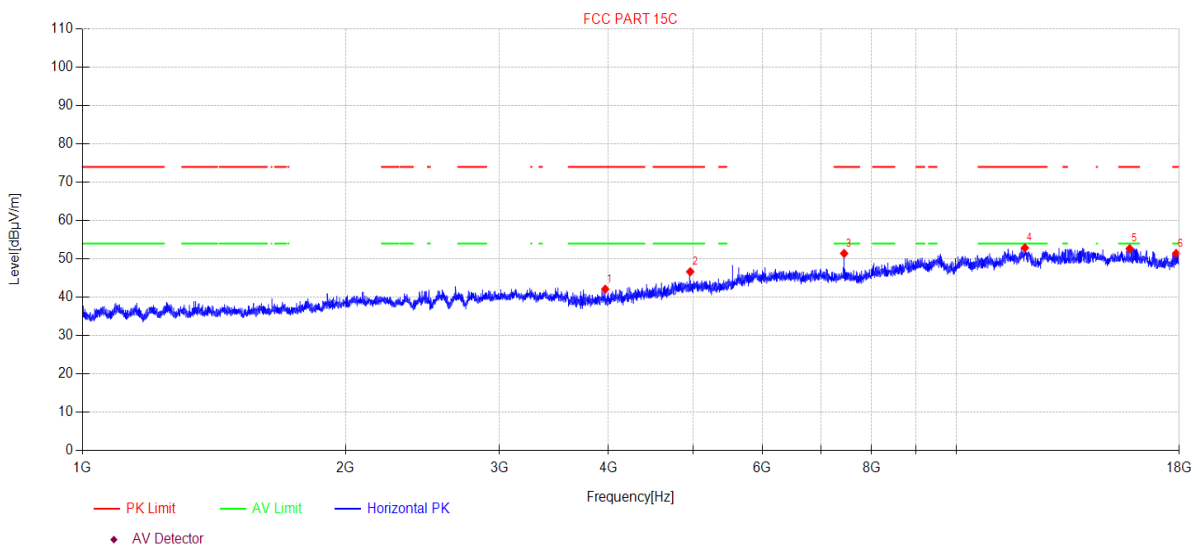

Suspected Data List										
N O.	Freq. [MHz]	Reading [dBµV/m]	Cable loss [dB]	Antenna Factor [dB]	AMP [dB]	Level [dBµV /m]	Limit [dBµV /m]	Margin [dB]	Detector	Polarity
1	3965.78	47.03	5.84	30.63	-41.38	42.12	74.00	31.88	PK	Horizontal
2	4961.38	47.18	7.79	32.80	-41.11	46.66	74.00	27.34	PK	Horizontal
3	7442.17	48.29	7.64	36.50	-41.00	51.43	74.00	22.57	PK	Horizontal
4	11982.51	42.40	10.52	38.88	-38.93	52.87	74.00	21.13	PK	Horizontal
5	15795.74	39.78	14.95	38.20	-40.26	52.67	74.00	21.33	PK	Horizontal
6	17849.77	38.28	12.95	40.85	-40.64	51.44	74.00	22.56	PK	Horizontal

**Note:**

1. Level = Reading + Cable loss + Antenna Factor + AMP
2. If Peak Result complies with AV limit, AV Result is deemed to comply with AV limit.
3. Test setup: RBW: 1 MHz, VBW: 3 MHz, Sweep time: auto.

# TR-4-E-009 Radiated Emission Test Result

**Test Date:** 2023-08-04      **Tested By:** Bairong  
**EUT:** 3.1CH Soundbar with Virtual Dolby Atmos and Wireless Subwoofer      **Model Number:** CINEMA SB580  
**Test Mode:** Tx mode      **Power Supply:** AC 120V/60Hz  
**Condition:** Temp:21.7°C;Humi:64.9%      **Test Site:** DDT 3# Chamber  
**File Path:** d:\ts\2023 report data\Q23071316-2E SB580\FCC ABOVE 1G\38  
**Memo:** GFSK 2481MHz

## Test Graph

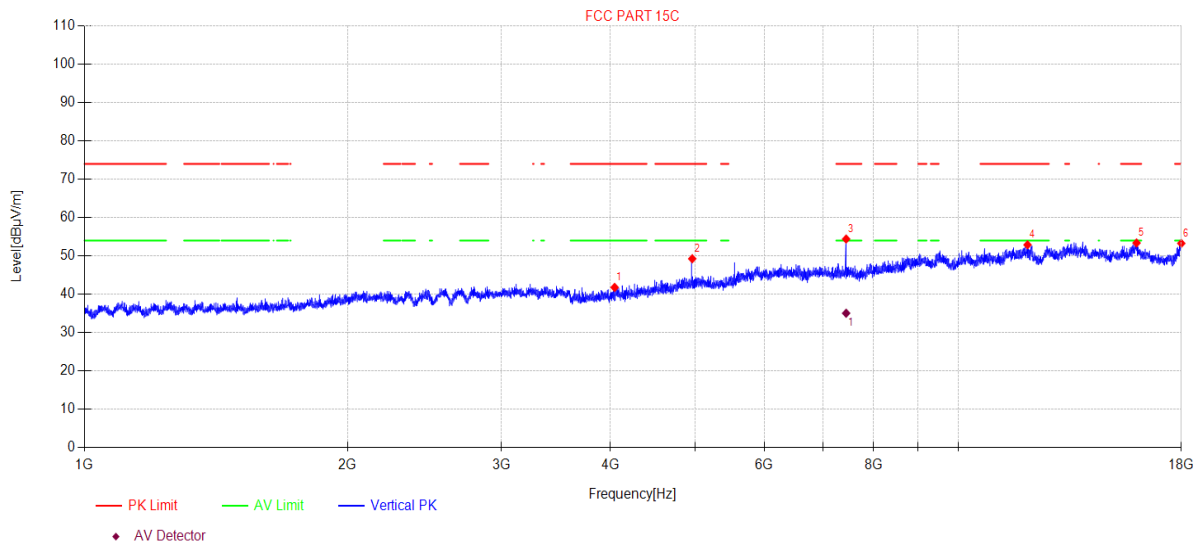

Suspected Data List										
N O.	Freq. [MHz]	Reading [dBµV/m]	Cable loss [dB]	Antenna Factor [dB]	AMP [dB]	Level [dBµV/m]	Limit [dBµV/m]	Margin [dB]	Detector	Polarity
1	4043.32	46.46	5.94	30.79	-41.39	41.80	74.00	32.20	PK	Vertical
2	4961.38	49.78	7.79	32.80	-41.11	49.26	74.00	24.74	PK	Vertical
3	7442.17	51.26	7.64	36.50	-41.00	54.40	74.00	19.60	PK	Vertical
4	12003.31	42.33	10.54	38.91	-38.90	52.88	74.00	21.12	PK	Vertical
5	15997.88	40.01	15.87	37.90	-40.40	53.38	74.00	20.62	PK	Vertical
6	18000.00	39.04	13.13	41.80	-40.70	53.27	74.00	20.73	PK	Vertical

Final Data List										
N O.	Freq. [MHz]	Reading [dBµV/m]	Cable loss [dB]	Antenna Factor [dB]	AMP [dB]	Level [dBµV/m]	Limit [dBµV/m]	Margin [dB]	Detector	Polarity
1	7442.17	31.93	7.64	36.50	-41.00	35.07	54.00	18.93	AV	Vertical

**Note:**

1. Level = Reading + Cable loss + Antenna Factor + AMP
2. If Peak Result complies with AV limit, AV Result is deemed to comply with AV limit.
3. Test setup: RBW: 1 MHz, VBW: 3 MHz, Sweep time: auto.

## 7. Band Edge Compliance (Radiated Method)

### 7.1. Block diagram of test setup

In 3 m Anechoic Chamber, test setup diagram for frequency above 1 GHz:

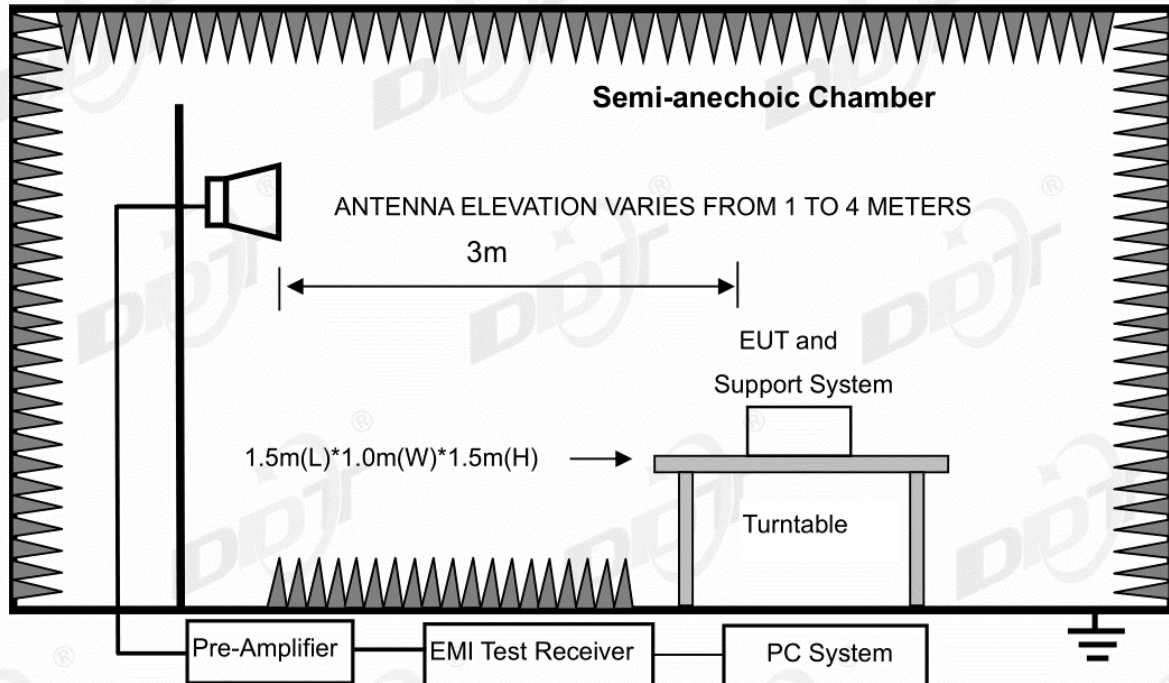

### 7.2. Limit

All restriction band should comply with 15.209 and RSS-Gen section 8.9 limits, other emission should be at least 20 dB below the fundamental.

### 7.3. Test Procedure

Same with Radiated Emission except change investigated frequency range from 2310 MHz to 2410 MHz and 2475 MHz to 2500 MHz.

Remark: All restriction band have been tested, and only the worst case is shown in report.

### 7.4. Test result

Pass. (See below detailed test result)

# TR-4-E-009 Radiated Emission Test Result

**Test Date:** 2023-08-04      **Tested By:** Bairong  
**EUT:** 3.1CH Soundbar with Virtual Dolby Atmos and Wireless Subwoofer      **Model Number:** CINEMA SB580  
**Test Mode:** Tx mode      **Power Supply:** AC 120V/60Hz  
**Condition:** Temp:21.7°C;Humi:64.9%      **Test Site:** DDT 3# Chamber  
**File Path:** d:\ts\2023 report data\Q23071316-2E SB580\FCC ABOVE 1G\39  
**Memo:** GFSK 2402MHz

## Test Graph

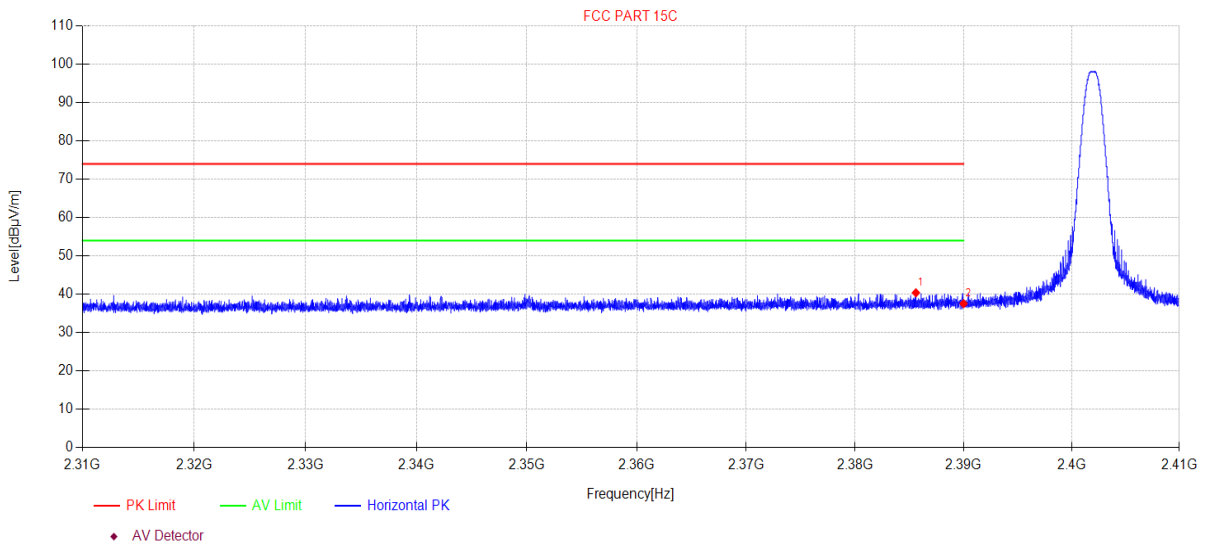

Suspected Data List										
NO	Freq. [MHz]	Reading [dBµV/m]	Cable loss [dB]	Antenna Factor [dB]	AMP [dB]	Level [dBµV/m]	Limit [dBµV/m]	Margin [dB]	Detector	Polarity
1	2385.60	49.18	3.86	27.47	-40.12	40.39	74.00	33.61	PK	Horizontal
2	2390.00	46.34	3.87	27.48	-40.13	37.56	74.00	36.44	PK	Horizontal

**Note:**

1. Level = Reading + Cable loss + Antenna Factor + AMP
2. If Peak Result complies with AV limit, AV Result is deemed to comply with AV limit.
3. Test setup: RBW: 1 MHz, VBW: 3 MHz, Sweep time: auto.

# TR-4-E-009 Radiated Emission Test Result

**Test Date:** 2023-08-04      **Tested By:** Bairong  
**EUT:** 3.1CH Soundbar with Virtual Dolby Atmos and Wireless Subwoofer      **Model Number:** CINEMA SB580  
**Test Mode:** Tx mode      **Power Supply:** AC 120V/60Hz  
**Condition:** Temp:21.7°C;Humi:64.9%      **Test Site:** DDT 3# Chamber  
**File Path:** d:\ts\2023 report data\Q23071316-2E SB580\FCC ABOVE 1G\40  
**Memo:** GFSK 2402MHz

## Test Graph

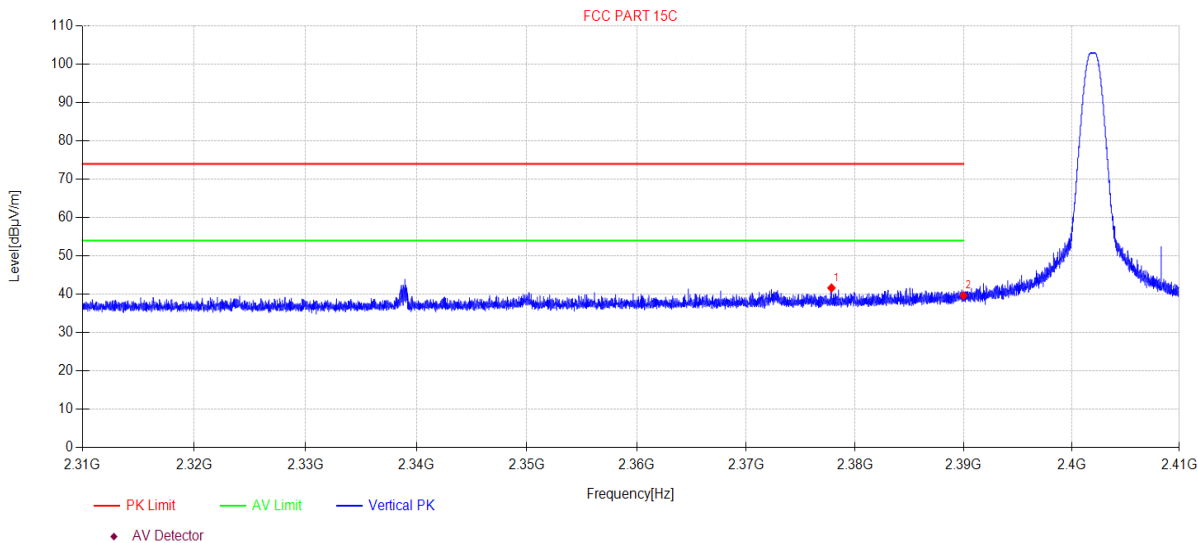

Suspected Data List										
NO	Freq. [MHz]	Reading [dBµV/m]	Cable loss [dB]	Antenna Factor [dB]	AMP [dB]	Level [dBµV/m]	Limit [dBµV/m]	Margin [dB]	Detector	Polarity
1	2377.83	50.45	3.86	27.46	-40.12	41.65	74.00	32.35	PK	Vertical
2	2390.00	48.44	3.87	27.48	-40.13	39.66	74.00	34.34	PK	Vertical

**Note:**

- Level = Reading + Cable loss + Antenna Factor + AMP
- If Peak Result complies with AV limit, AV Result is deemed to comply with AV limit.
- Test setup: RBW: 1 MHz, VBW: 3 MHz, Sweep time: auto.



# TR-4-E-009 Radiated Emission Test Result

**Test Date:** 2023-08-04      **Tested By:** Bairong  
**EUT:** 3.1CH Soundbar with Virtual Dolby Atmos and Wireless Subwoofer      **Model Number:** CINEMA SB580  
**Test Mode:** Tx mode      **Power Supply:** AC 120V/60Hz  
**Condition:** Temp:21.7°C;Humi:64.9%      **Test Site:** DDT 3# Chamber  
**File Path:** d:\ts\2023 report data\Q23071316-2E SB580\FCC ABOVE 1G\41  
**Memo:** GFSK 2481MHz

## Test Graph

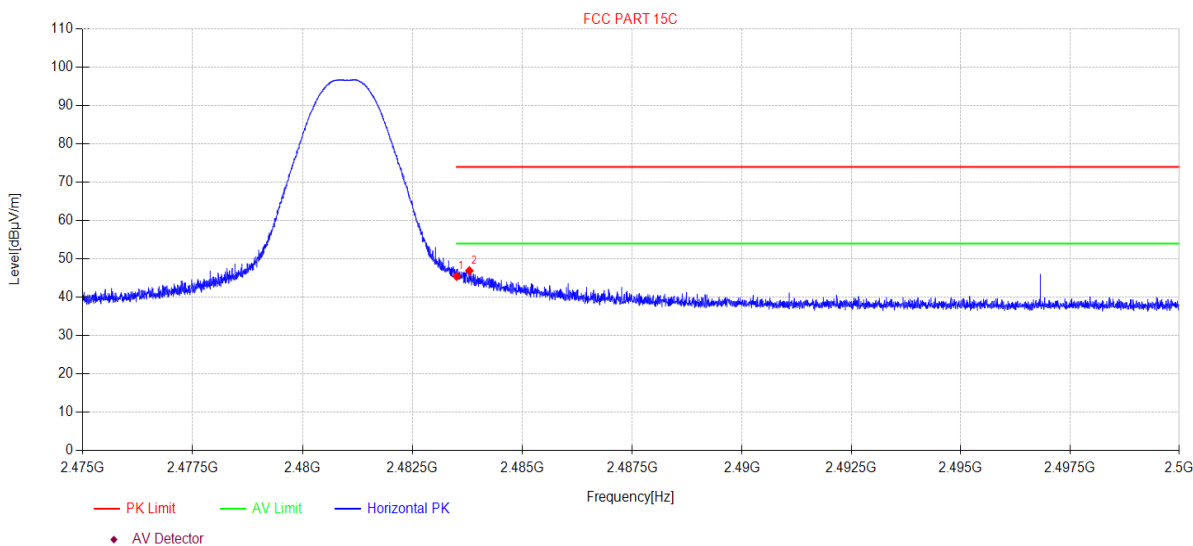

Suspected Data List										
NO	Freq. [MHz]	Reading [dBµV/m]	Cable loss [dB]	Antenna Factor [dB]	AMP [dB]	Level [dBµV/m]	Limit [dBµV/m]	Margin [dB]	Detector	Polarity
1	2483.50	54.01	3.94	27.73	-40.23	45.45	74.00	28.55	PK	Horizontal
2	2483.79	55.49	3.94	27.74	-40.23	46.94	74.00	27.06	PK	Horizontal

**Note:**

1. Level = Reading + Cable loss + Antenna Factor + AMP
2. If Peak Result complies with AV limit, AV Result is deemed to comply with AV limit.
3. Test setup: RBW: 1 MHz, VBW: 3 MHz, Sweep time: auto.

# TR-4-E-009 Radiated Emission Test Result

**Test Date:** 2023-08-04      **Tested By:** Bairong  
**EUT:** 3.1CH Soundbar with Virtual Dolby Atmos and Wireless Subwoofer      **Model Number:** CINEMA SB580  
**Test Mode:** Tx mode      **Power Supply:** AC 120V/60Hz  
**Condition:** Temp:21.7°C;Humi:64.9%      **Test Site:** DDT 3# Chamber  
**File Path:** d:\ts\2023 report data\Q23071316-2E SB580\FCC ABOVE 1G\42  
**Memo:** GFSK 2481MHz

## Test Graph

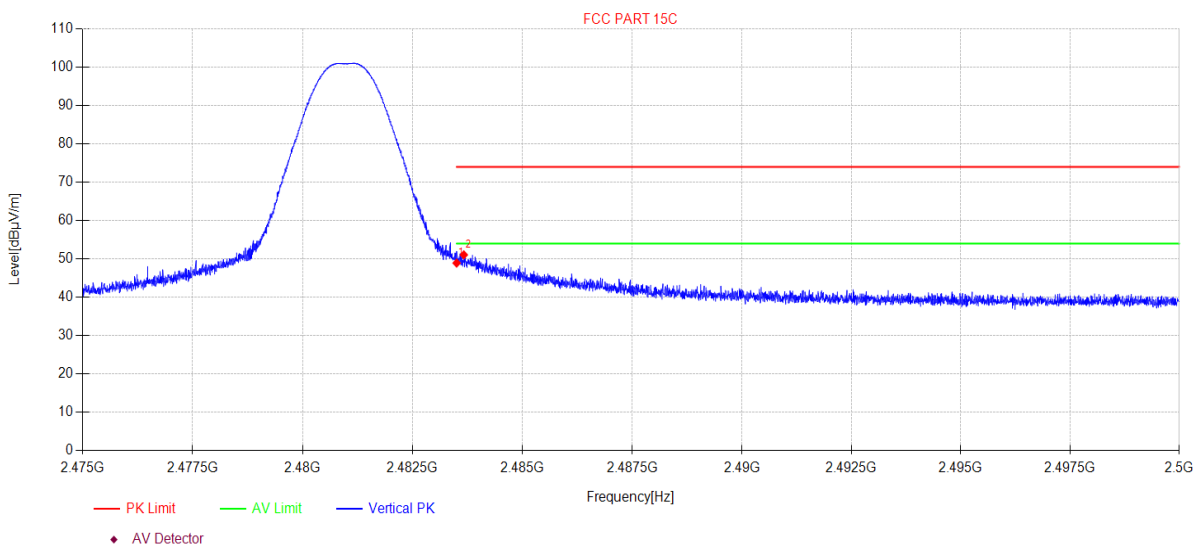

Suspected Data List										
NO	Freq. [MHz]	Reading [dBµV/m]	Cable loss [dB]	Antenna Factor [dB]	AMP [dB]	Level [dBµV/m]	Limit [dBµV/m]	Margin [dB]	Detector	Polarity
1	2483.50	57.48	3.94	27.73	-40.23	48.92	74.00	25.08	PK	Vertical
2	2483.67	59.62	3.94	27.73	-40.23	51.06	74.00	22.94	PK	Vertical

**Note:**

- Level = Reading + Cable loss + Antenna Factor + AMP
- If Peak Result complies with AV limit, AV Result is deemed to comply with AV limit.
- Test setup: RBW: 1 MHz, VBW: 3 MHz, Sweep time: auto.

## 8. Power Line Conducted Emission

### 8.1. Block diagram of test setup

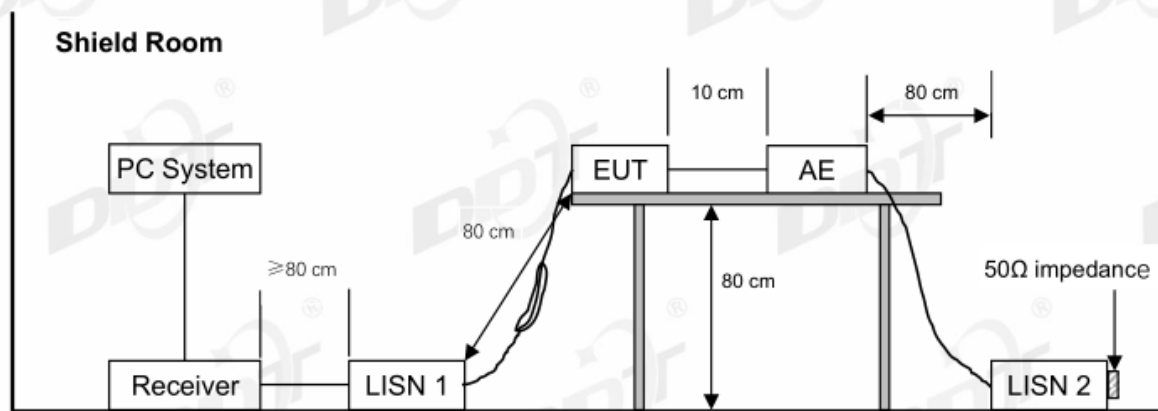

### 8.2. Power line conducted emission limits

Frequency	Quasi-Peak Level dB( $\mu$ V)	Average Level dB( $\mu$ V)
150 kHz ~ 500 kHz	66 ~ 56*	56 ~ 46*
500 kHz ~ 5 MHz	56	46
5 MHz ~ 30 MHz	60	50

Note 1: \* Decreasing linearly with logarithm of frequency.

Note 2: The lower limit shall apply at the transition frequencies.

### 8.3. Test procedure

The EUT and Support equipment, if needed, were put placed on a non-metallic table, 80cm above the ground plane.

All support equipment power received from a second LISN.

Emissions were measured on each current carrying line of the EUT using an EMI Test Receiver connected to the LISN powering the EUT.

The Receiver scanned from 150 kHz to 30 MHz for emissions in each of the test modes.

During the above scans, the emissions were maximized by cable manipulation.

The test mode(s) described in clause 2.4 were scanned during the preliminary test.

After the preliminary scan, we found the test mode producing the highest emission level.

The EUT configuration and worse cable configuration of the above highest emission levels were recorded for reference of the final test.

EUT and support equipment were set up on the test bench as per the configuration with highest emission level in the preliminary test.

A scan was taken on both power lines, Neutral and Line, recording at least the six highest emissions.

Emission frequency and amplitude were recorded into a computer in which correction factors were used to calculate the emission level and compare reading to the applicable limit.

The test data of the worst-case condition(s) was recorded.

The bandwidth of test receiver is set at 9 kHz.

#### **8.4. Test result**

**Pass. (See below detailed test result)**

Note1: All emissions not reported below are too low against the prescribed limits.

Note2: “----” means Peak detection; “-----” means Average detection.

Note3: Pre-test AC conducted emission at both voltage AC 120V/60Hz and AC 240V/50Hz, recorded the worst case.

# TR-4-E-010 Conducted Emission Test Result

**Test Site** : DDT 5# Shield Room D:\2023 report data\Q23071316-2E\FCC CE.EM6  
**Test Date** : 2023-08-02 **Tested By** : Junchang Du  
**EUT** : 3.1CH Soundbar with Virtual Dolby Atmos and Wireless Subwoofer **Model Number** : CINEMA SB580  
**Power Supply** : AC 120V/60Hz **Test Mode** : Tx mode  
**Condition** : Temp:21.6°C,Humi:58.6% **LISN** : 2022 ENV216 2#/LINE

**Memo** :

Data: 2

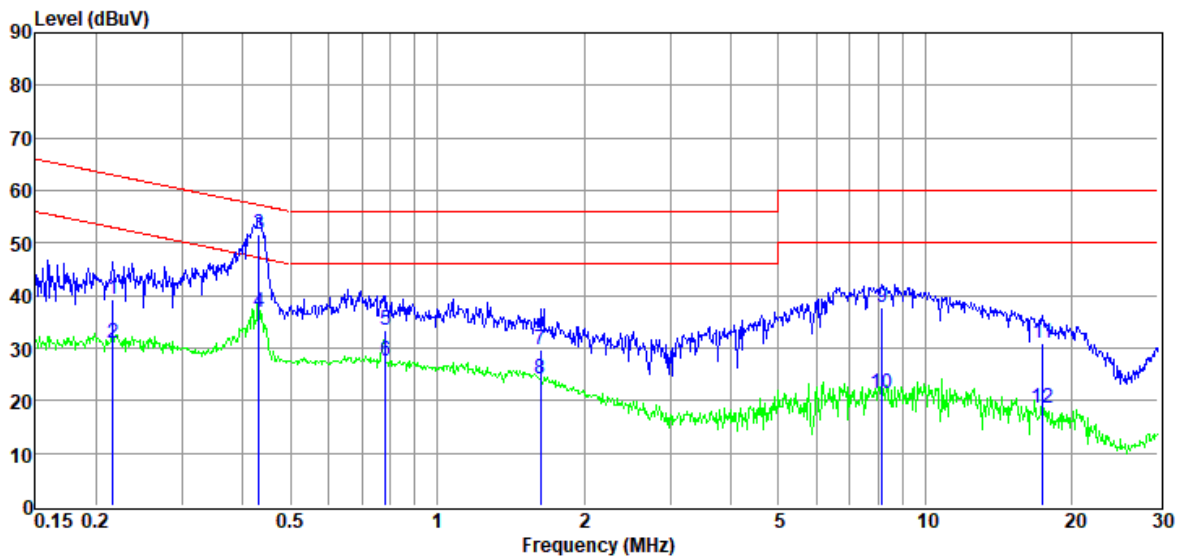

Item (Mark)	Freq. (MHz)	Read Level (dB $\mu$ V)	LISN Factor (dB)	Cable Loss (dB)	Pulse Limiter Factor (dB)	Result Level (dB $\mu$ V)	Limit Line (dB $\mu$ V)	Over Limit (dB)	Detector	Phase
1	0.22	19.26	9.80	0.20	10.14	39.40	62.96	-23.56	QP	LINE
2	0.22	10.87	9.80	0.20	10.14	31.01	52.96	-21.95	Average	LINE
3	0.43	31.48	9.80	0.25	10.07	51.60	57.24	-5.64	QP	LINE
4	0.43	16.77	9.80	0.25	10.07	36.89	47.24	-10.35	Average	LINE
5	0.78	13.30	9.77	0.29	9.94	33.30	56.00	-22.70	QP	LINE
6	0.78	7.57	9.77	0.29	9.94	27.57	46.00	-18.43	Average	LINE
7	1.63	10.09	9.49	0.35	9.77	29.70	56.00	-26.30	QP	LINE
8	1.63	4.41	9.49	0.35	9.77	24.02	46.00	-21.98	Average	LINE
9	8.15	17.60	9.61	0.38	10.11	37.70	60.00	-22.30	QP	LINE
10	8.15	1.38	9.61	0.38	10.11	21.48	50.00	-28.52	Average	LINE
11	17.38	10.76	9.60	0.40	10.08	30.84	60.00	-29.16	QP	LINE
12	17.38	-1.50	9.60	0.40	10.08	18.58	50.00	-31.42	Average	LINE

- Note: 1. Result Level = Read Level + LISN Factor + Pulse Limiter Factor + Cable loss.  
 2. If QP Result complies with AV limit, AV Result is deemed to comply with AV limit.  
 3. Test setup: RBW: 200 Hz (9 kHz—150 kHz), 9 kHz (150 kHz—30 MHz).  
 4. Step size: 80Hz (0.009MHz-0.15MHz), 4 kHz (0.15MHz-30MHz), Scan time: auto.

# TR-4-E-010 Conducted Emission Test Result

**Test Site** : DDT 5# Shield Room D:\2023 report data\Q23071316-2E\FCC CE.EM6  
**Test Date** : 2023-08-02 **Tested By** : Junchang Du  
**EUT** : 3.1CH Soundbar with Virtual Dolby Atmos **Model Number** : CINEMA SB580  
and Wireless Subwoofer  
**Power Supply** : AC 120V/60Hz **Test Mode** : Tx mode  
**Condition** : Temp:21.6°C,Humi:58.6% **LISN** : 2022 ENV216 2#/NEUTRAL  
**Memo** : 2.4G SRD 低音炮

Data: 4

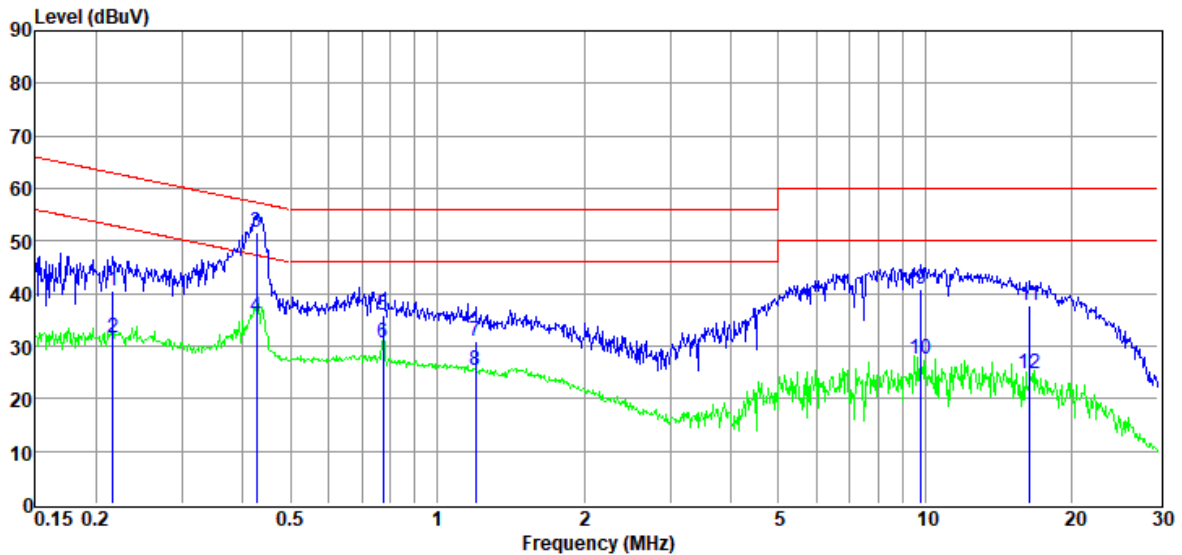

Item (Mark)	Freq. (MHz)	Read Level (dBuV)	LISN Factor (dB)	Cable Loss (dB)	Pulse Limiter Factor (dB)	Result Level (dBuV)	Limit Line (dBuV)	Over Limit (dB)	Detector	Phase
1	0.22	20.45	9.80	0.20	10.14	40.59	62.96	-22.37	QP	NEUTRAL
2	0.22	11.41	9.80	0.20	10.14	31.55	52.96	-21.41	Average	NEUTRAL
3	0.43	31.66	9.80	0.25	10.07	51.78	57.33	-5.55	QP	NEUTRAL
4	0.43	15.38	9.80	0.25	10.07	35.50	47.33	-11.83	Average	NEUTRAL
5	0.78	15.77	9.83	0.28	9.94	35.82	56.00	-20.18	QP	NEUTRAL
6	0.78	10.61	9.83	0.28	9.94	30.66	46.00	-15.34	Average	NEUTRAL
7	1.20	10.78	9.87	0.34	9.84	30.83	56.00	-25.17	QP	NEUTRAL
8	1.20	5.35	9.87	0.34	9.84	25.40	46.00	-20.60	Average	NEUTRAL
9	9.81	20.63	9.78	0.38	10.16	40.95	60.00	-19.05	QP	NEUTRAL
10	9.81	7.33	9.78	0.38	10.16	27.65	50.00	-22.35	Average	NEUTRAL
11	16.40	17.67	9.56	0.40	10.09	37.72	60.00	-22.28	QP	NEUTRAL
12	16.40	4.69	9.56	0.40	10.09	24.74	50.00	-25.26	Average	NEUTRAL

- Note: 1. Result Level = Read Level +LISN Factor + Pulse Limiter Factor + Cable loss.  
 2. If QP Result complies with AV limit, AV Result is deemed to comply with AV limit.  
 3. Test setup: RBW: 200 Hz (9 kHz—150 kHz), 9 kHz (150 kHz—30 MHz).  
 4. Step size: 80Hz(0.009MHz-0.15MHz), 4 kHz (0.15MHz-30MHz), Scan time: auto.

## 9. Antenna Requirements

### 9.1. Limit

For intentional device, according to FCC 47 CFR Section 15.203, an intentional radiator shall be designed to ensure that no antenna other than that furnished by the responsible party shall be used with the device.

For intentional device, according to RSS-Gen issue 5 section 6.8.

The applicant for equipment certification shall provide a list of all antenna types that may be used with the transmitter, where applicable (i.e. for transmitters with detachable antenna), indicating the maximum permissible antenna gain (in dBi) and the required impedance for each antenna. The test report shall demonstrate the compliance of the transmitter with the limit for maximum equivalent isotropically radiated power (e.i.r.p.) specified in the applicable RSS, when the transmitter is equipped with any antenna type, selected from this list.

### 9.2. Result

The antenna used for this product is PCB antenna and that no antenna other than that furnished by the responsible party shall be used with the device, the maximum peak gain of the transmit antenna is 1.70 dBi.

## 11. Photos of the EUT

Please refer to appendix I.

**END OF REPORT**