

DH5 Ant1 2480 30~1000

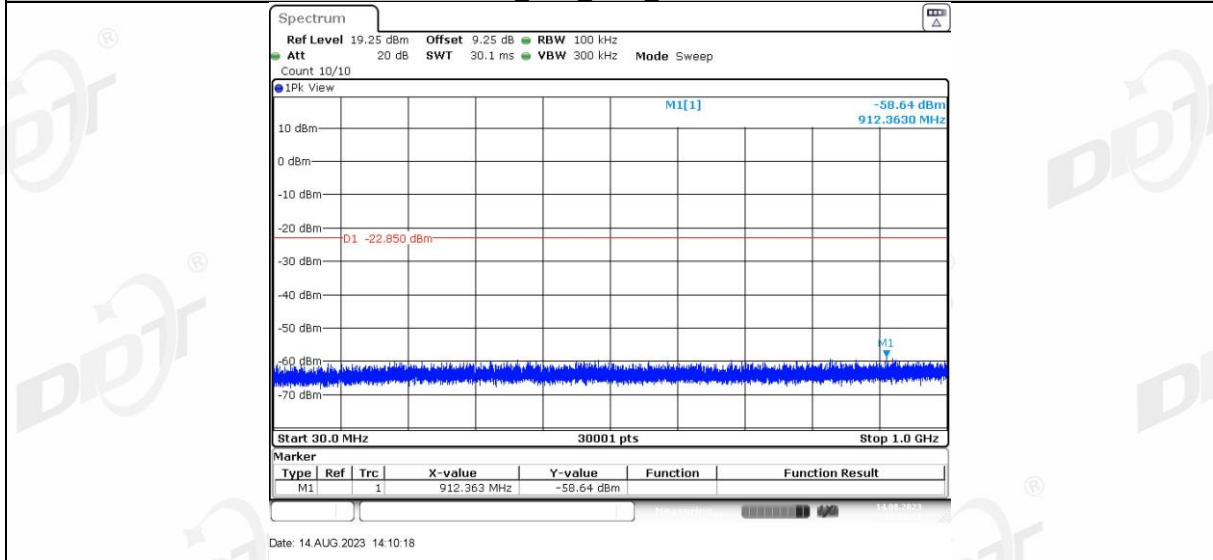

DH5 Ant1 2480 1000~26500

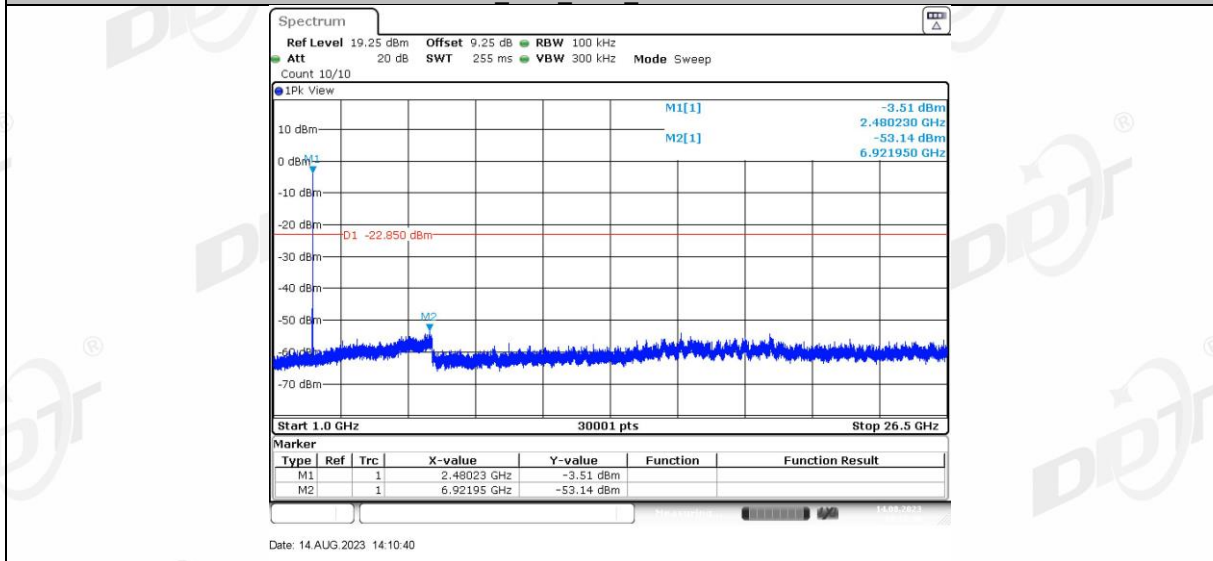

2DH5 Ant1 2402 0~Reference

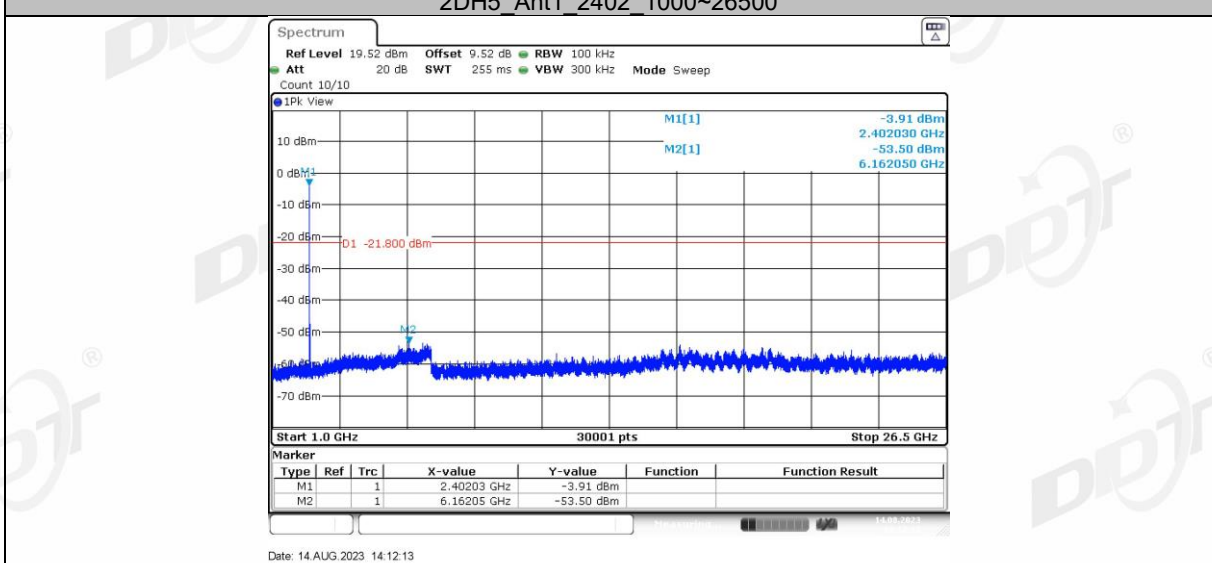
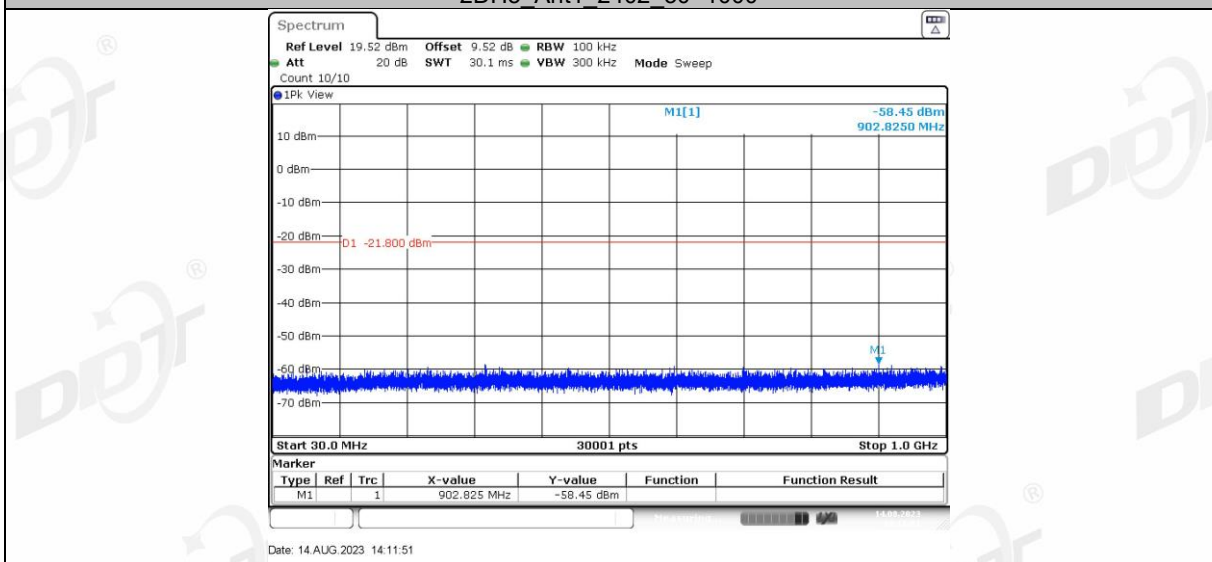
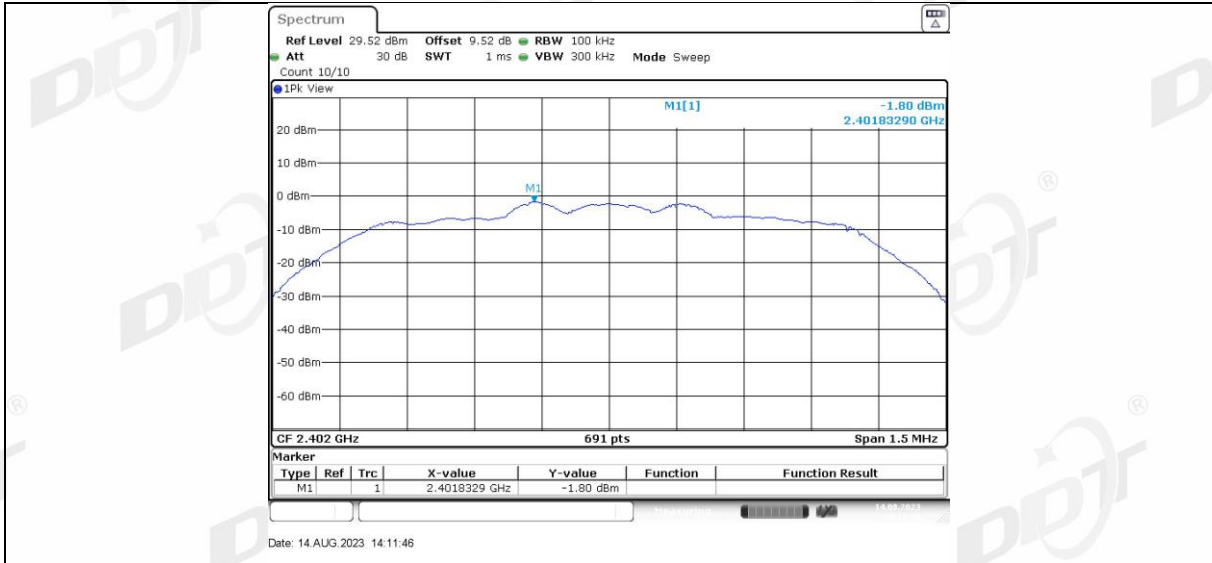

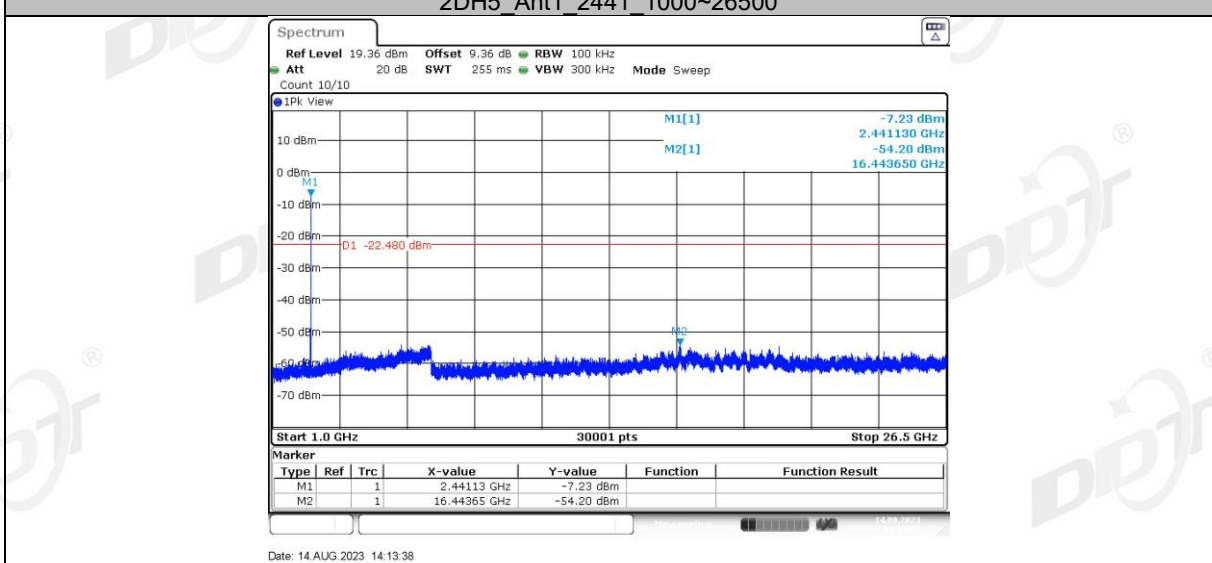
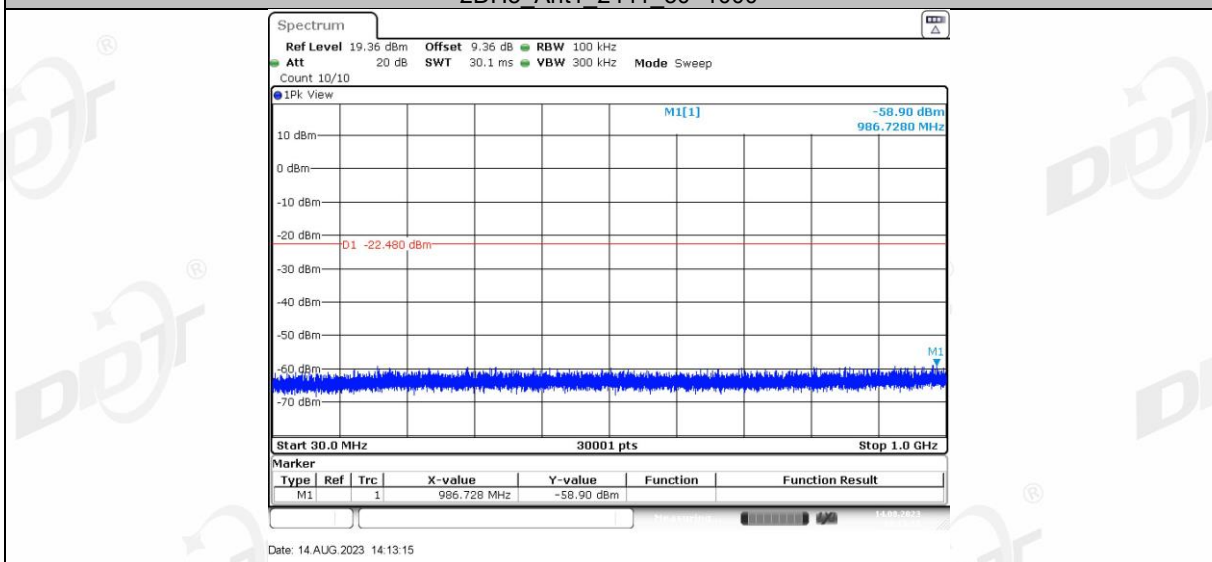
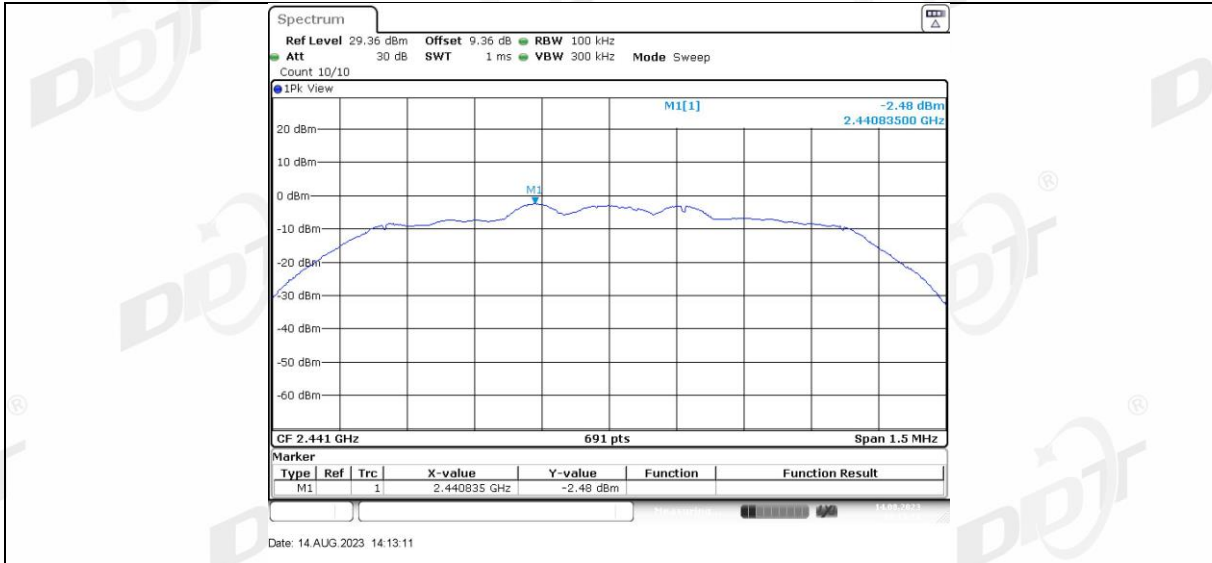

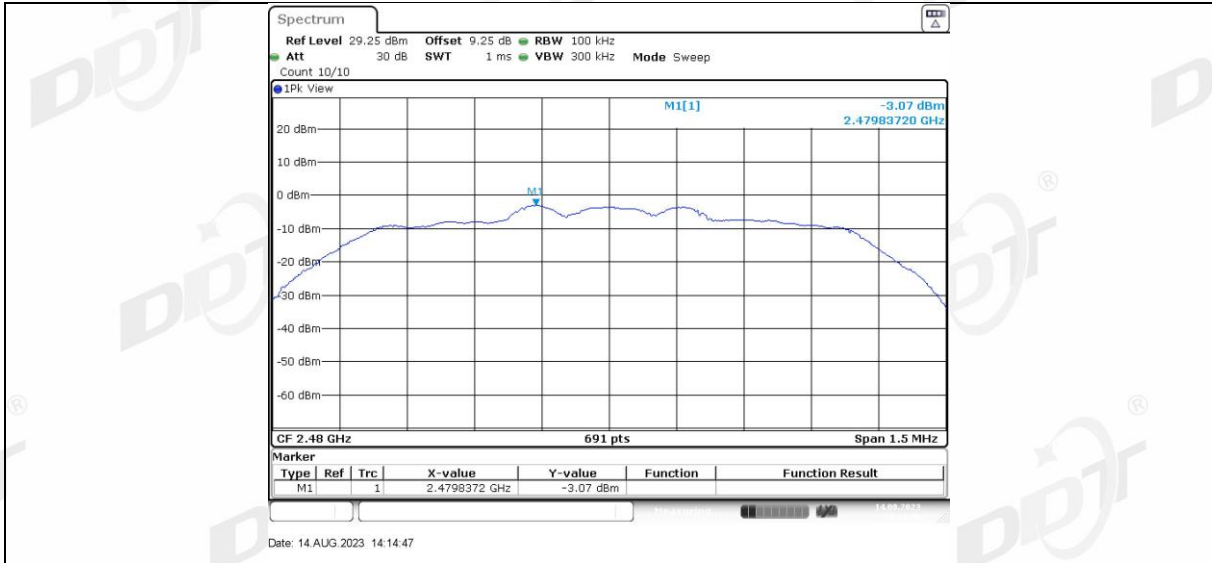

2DH5_Ant1_2480_30~1000

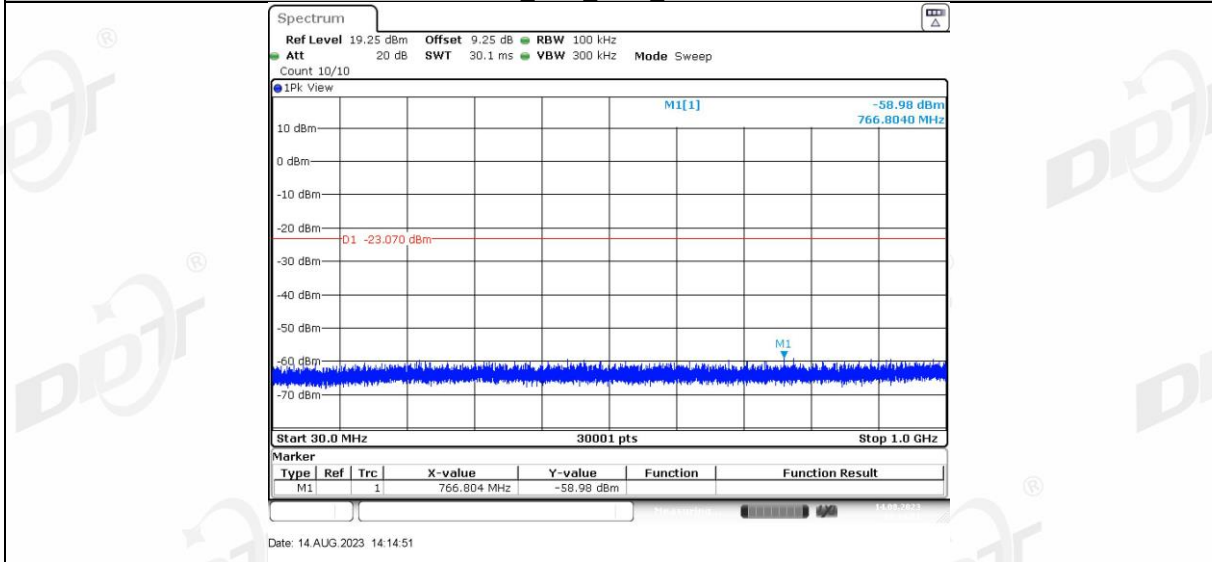

2DH5_Ant1_2480_1000~26500

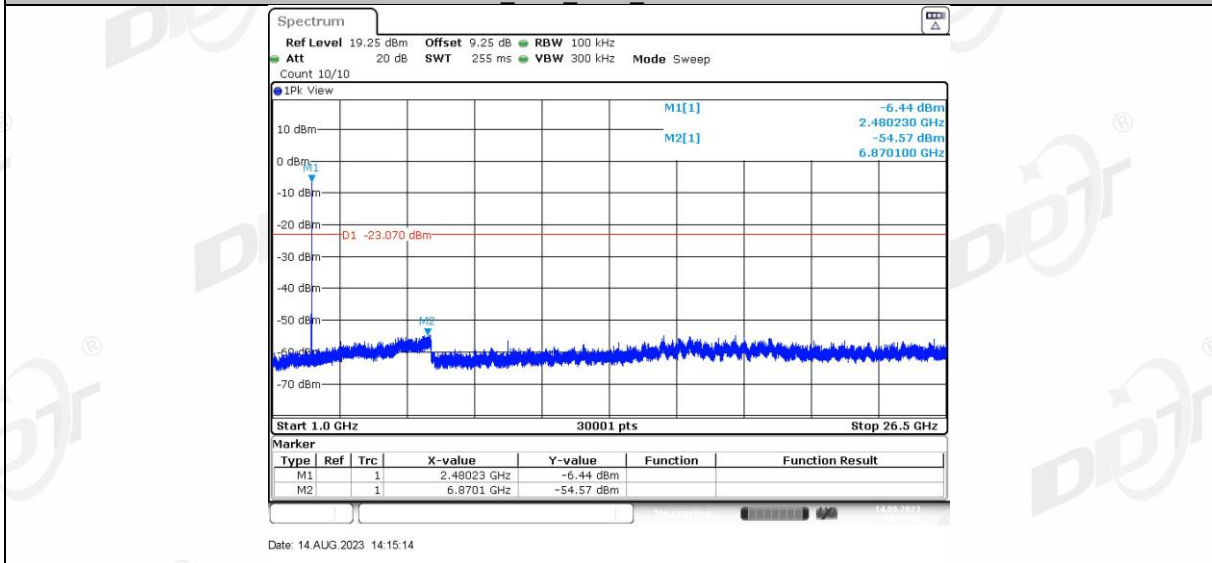

3DH5_Ant1_2402_0~Reference

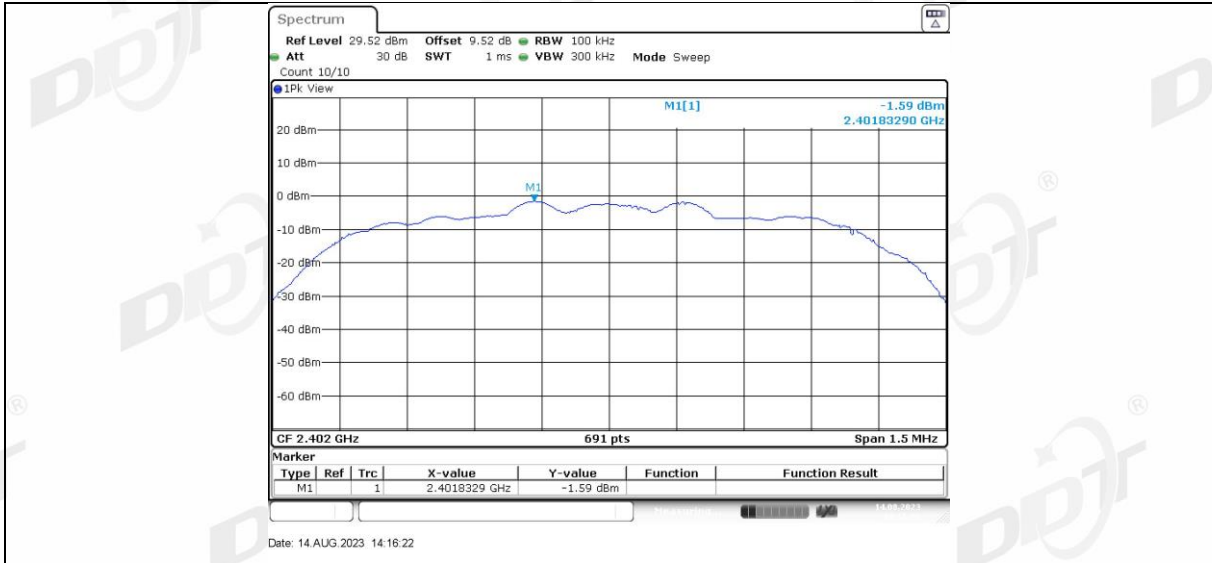

3DH5_Ant1_2402_30~1000

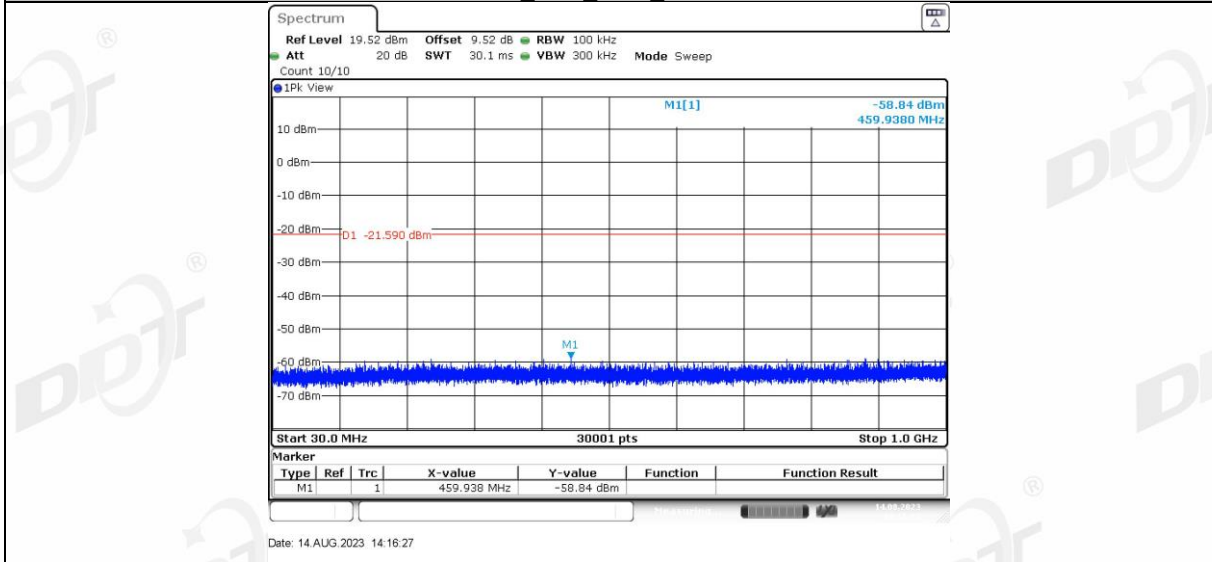

3DH5_Ant1_2402_1000~26500

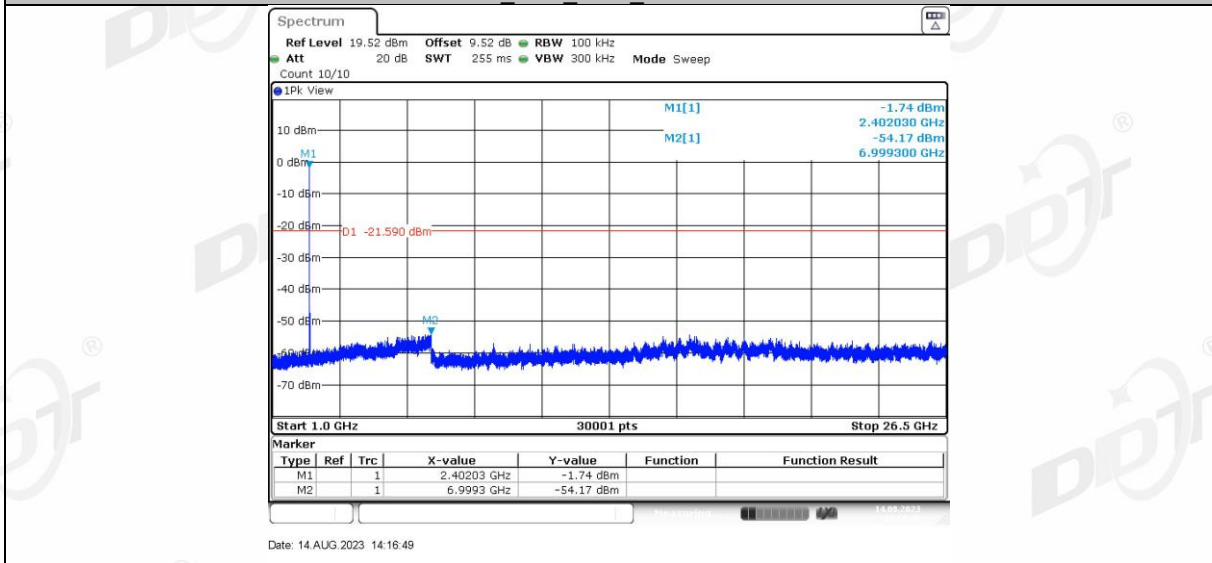

3DH5_Ant1_2441_0~Reference

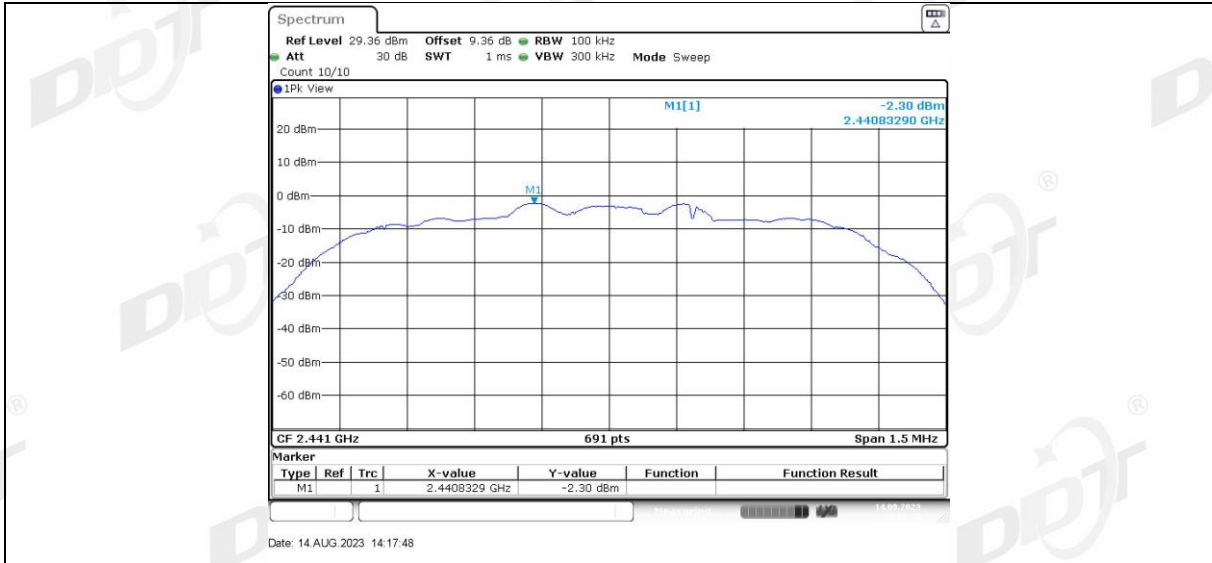

3DH5_Ant1_2441_30~1000

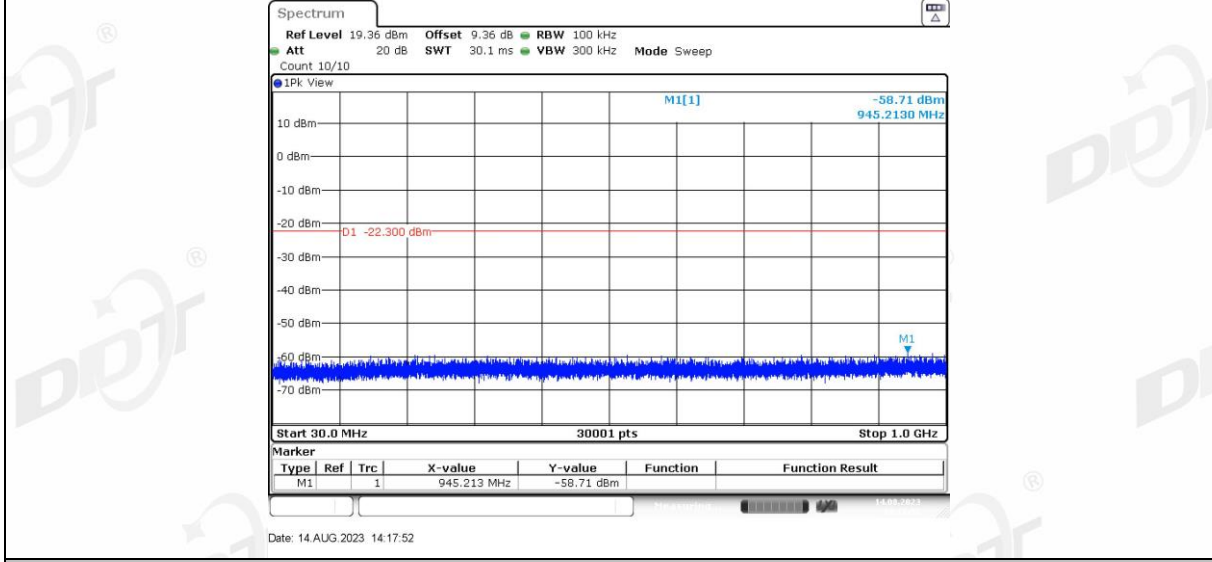

3DH5_Ant1_2441_1000~26500

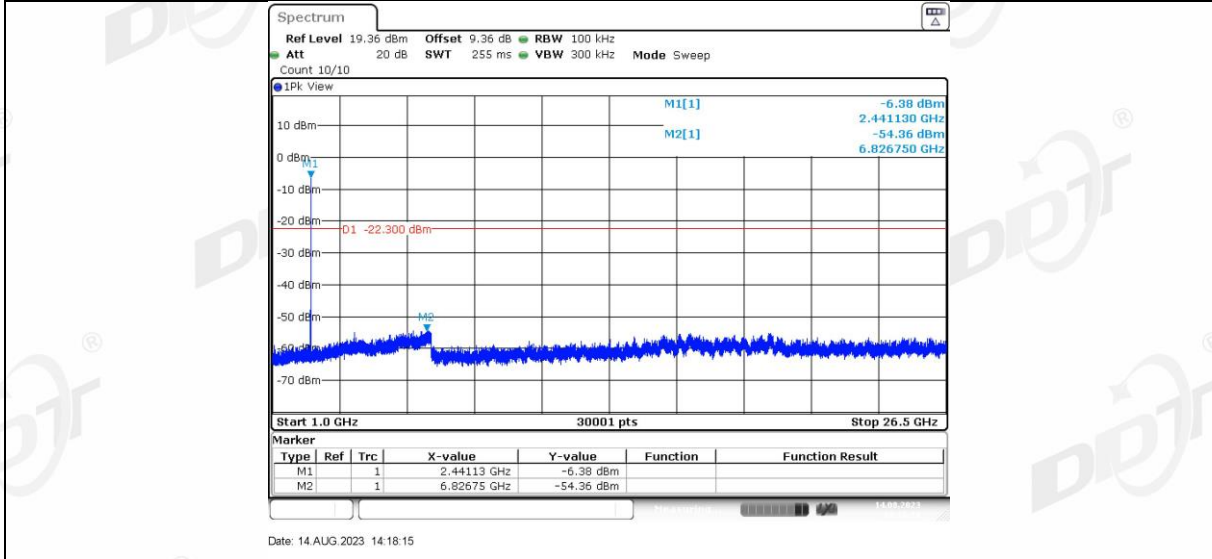

3DH5_Ant1_2480_0~Reference

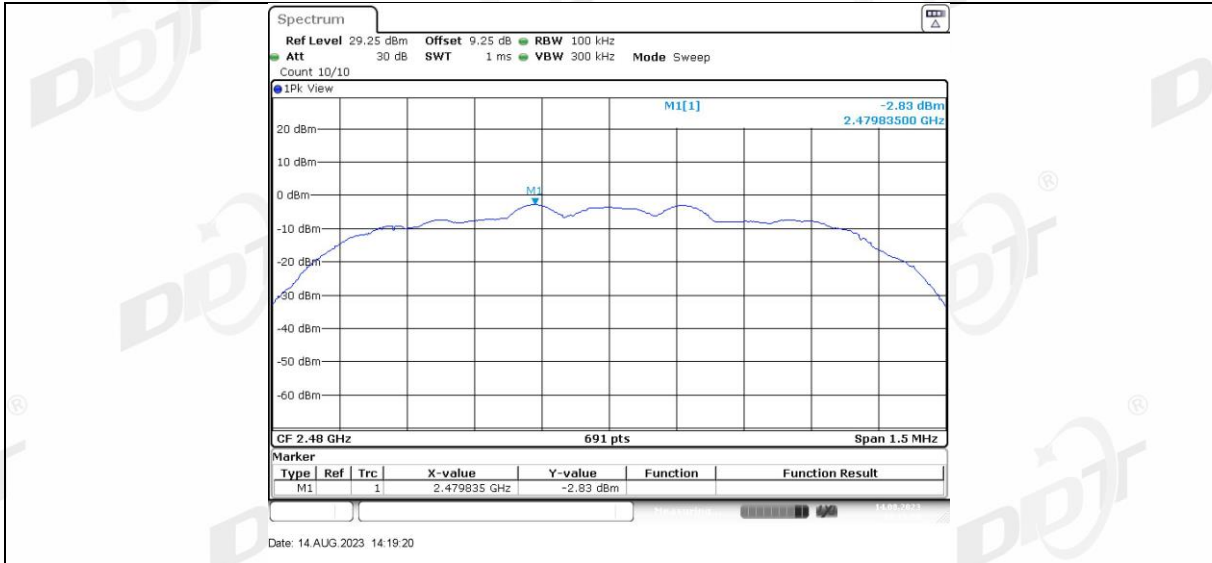

3DH5_Ant1_2480_30~1000

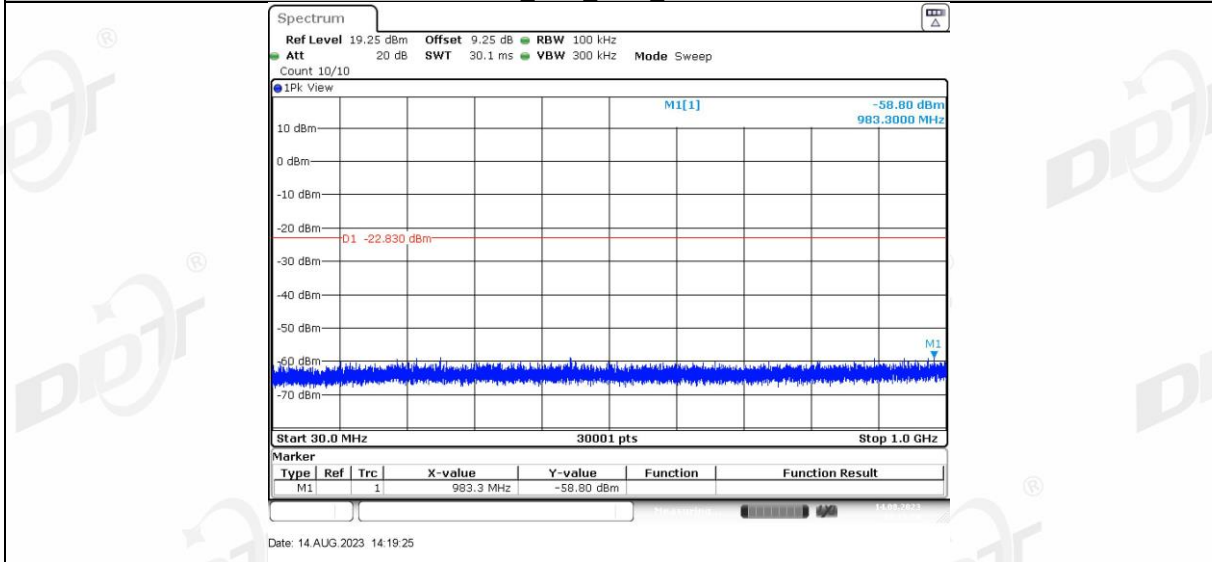

3DH5_Ant1_2480_1000~26500

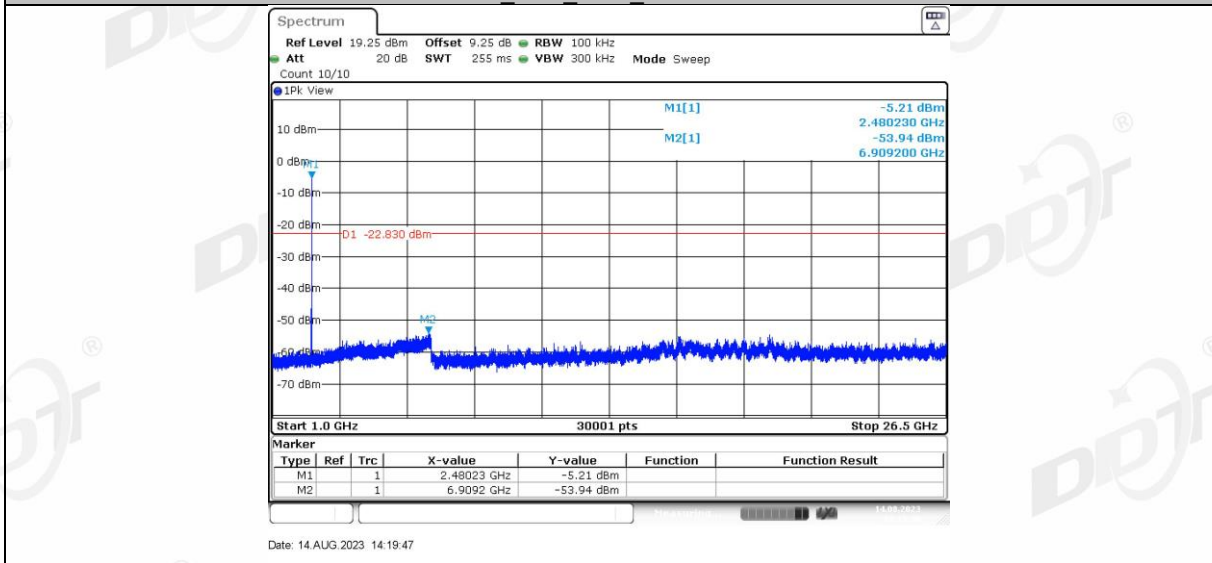

12. Duty cycle

12.1. Block diagram of test setup

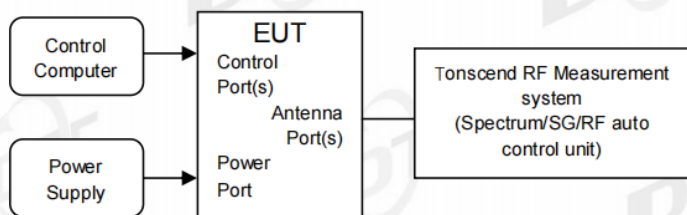

12.2. Limit

Just for Report.

12.3. Test procedure

- Connected the EUT’s antenna port to the Spectrum Analyzer by suitable attenuator, The cable loss and attenuator loss have been put into spectrum analyzer as amplitude offset.
set the Spectrum Analyzer as below:

Centre Frequency: The centre frequency of the middle hopping channel.

Resolution BW: 10 MHz.

Video BW: 10 MHz.

Span: Zero span.

Detector: Peak.

Trace Mode: Clear Write.

Sweep: Video Trigger

- When the trace is complete, measure the sending time of 1 burst and the duty cycle of 1 burst cycle.
- Calculate dwell time follow below formula:
Duty cycle= Pulse’s on time / Burst cycle

12.4. Test result

Test Mode	Antenna	Frequency [MHz]	ON Time [ms]	Period [ms]	Duty Cycle [%]	Duty Cycle Factor[dB]
DH5	Ant1	2402	2.87	3.75	76.53	1.16
		2441	2.87	3.75	76.53	1.16
		2480	2.87	3.75	76.53	1.16
2DH5	Ant1	2402	2.89	3.76	76.86	1.14
		2441	2.89	3.76	76.86	1.14
		2480	2.88	3.75	76.80	1.15
3DH5	Ant1	2402	2.89	3.76	76.86	1.14
		2441	2.89	3.75	77.07	1.13
		2480	2.89	3.76	76.86	1.14

12.5. Test graphs

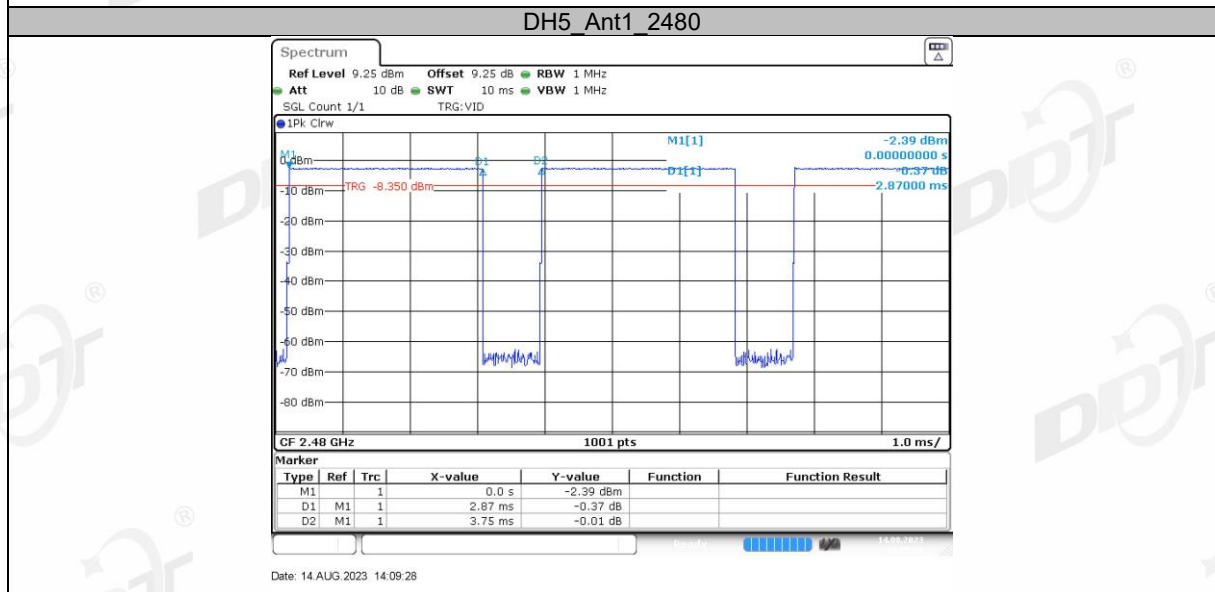
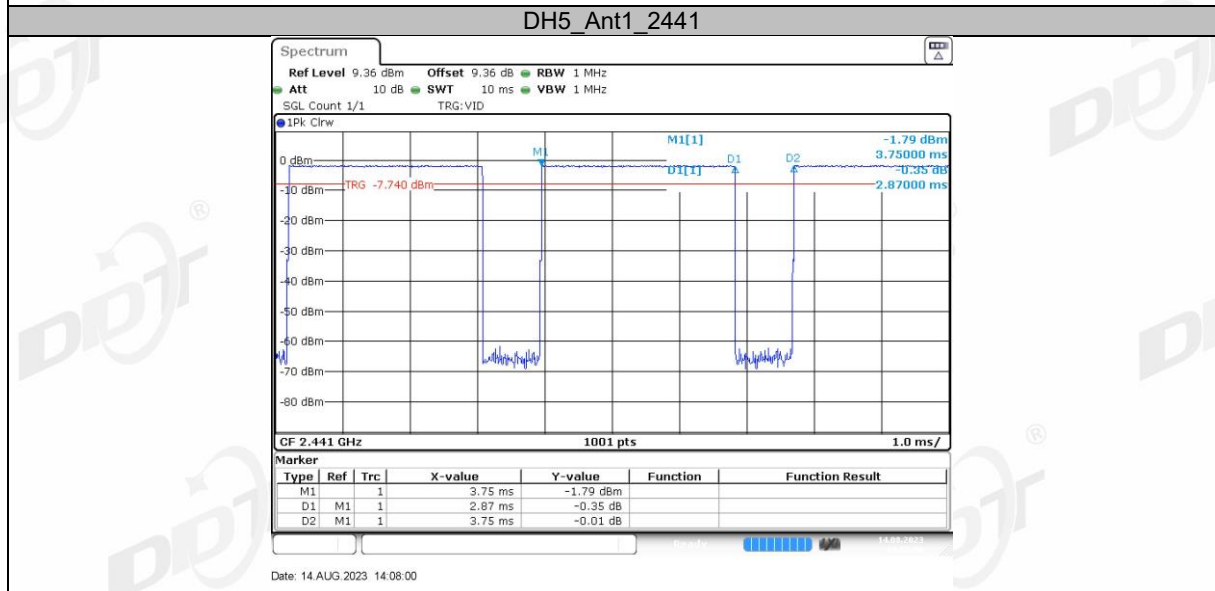
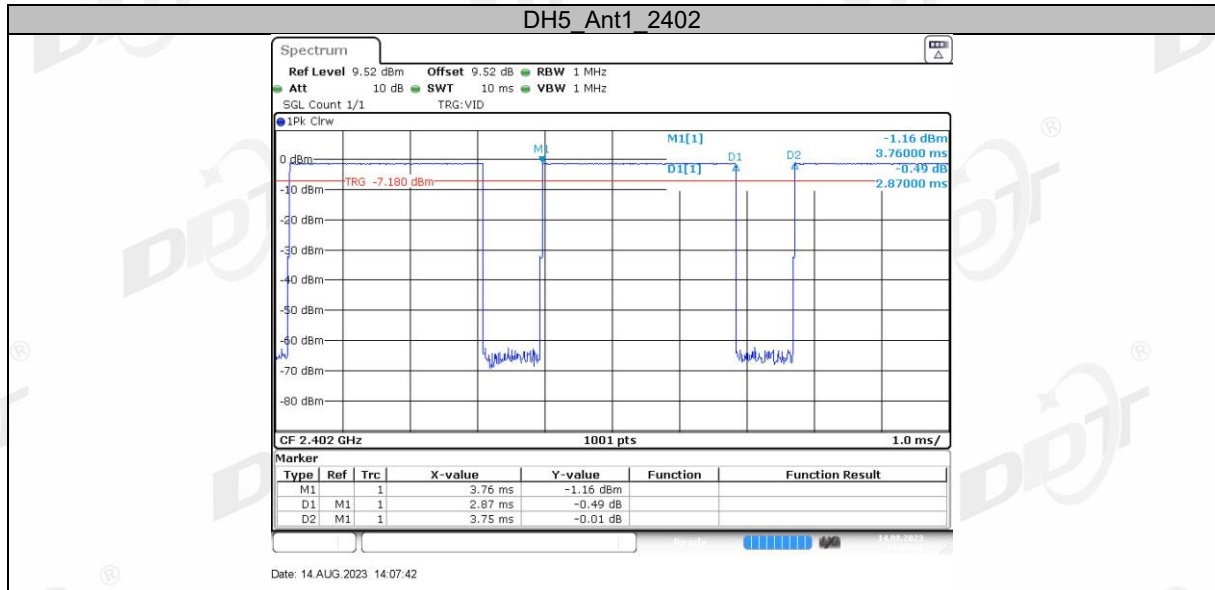

2DH5_Ant1_2402

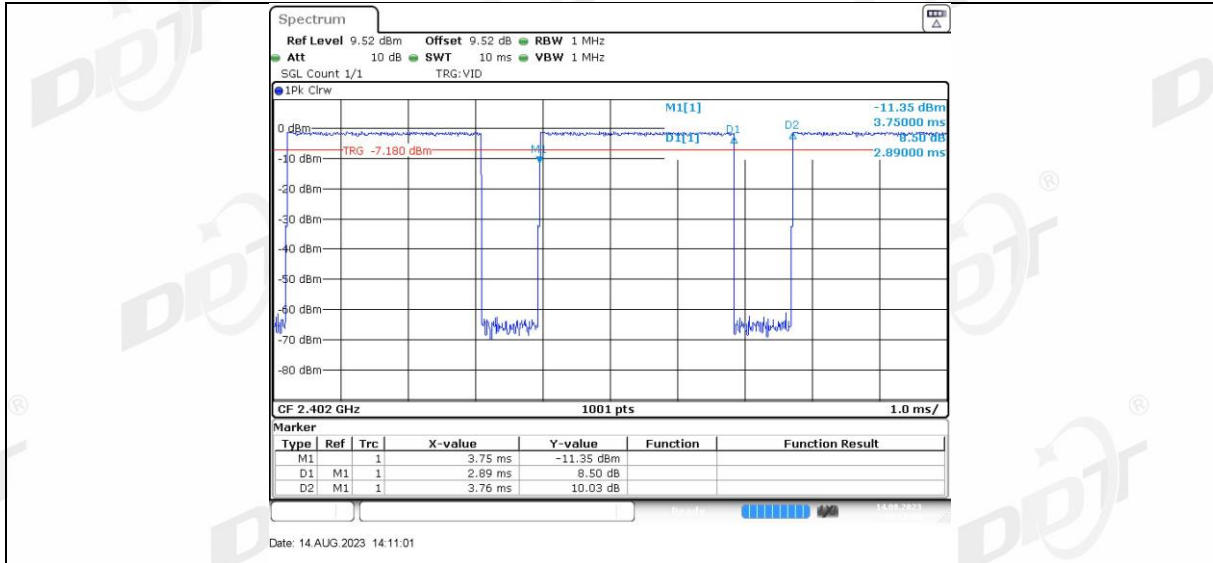

2DH5_Ant1_2441

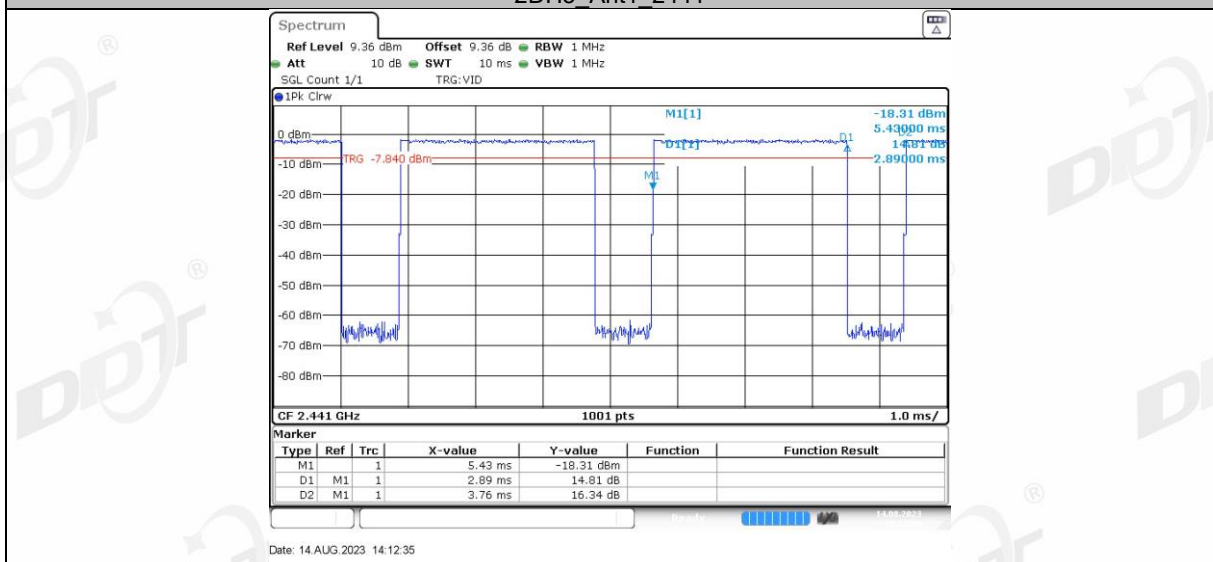

2DH5_Ant1_2480

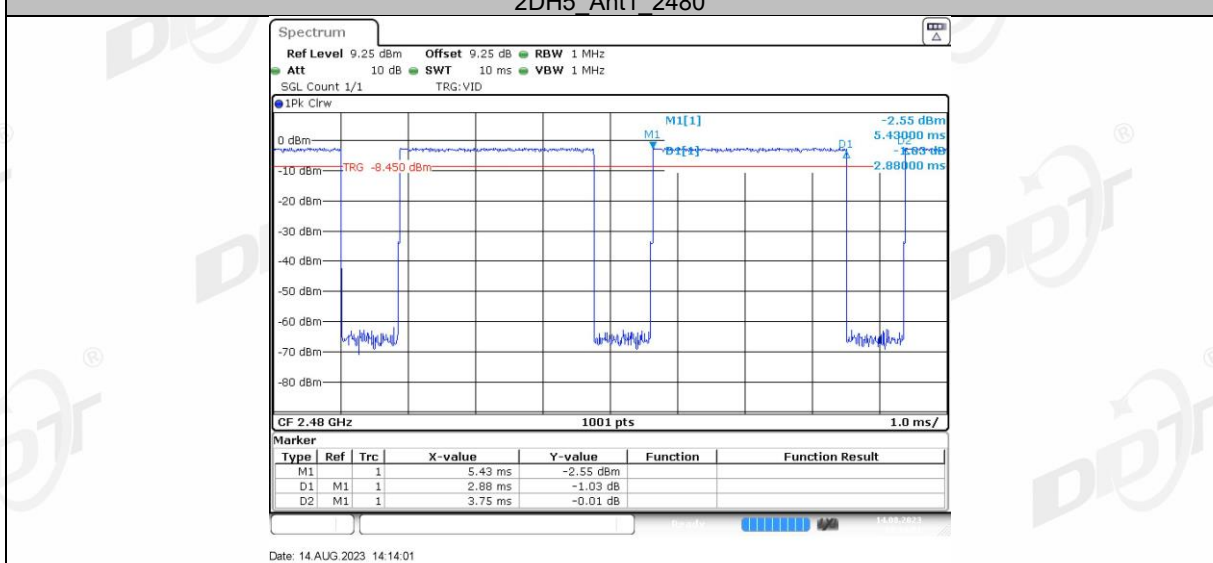

3DH5_Ant1_2402

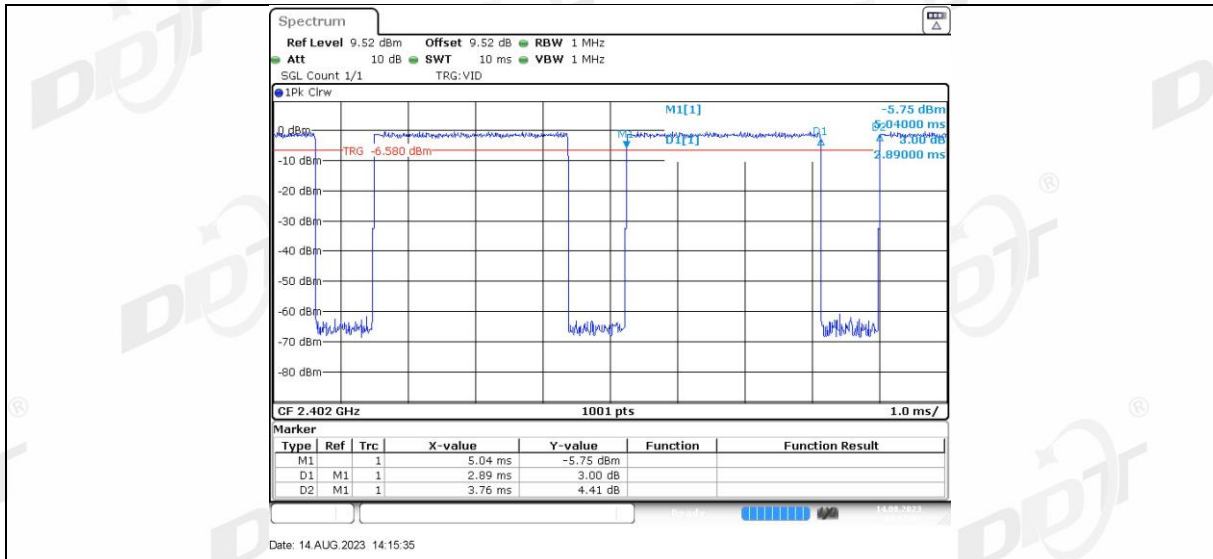

3DH5 Ant1_2441

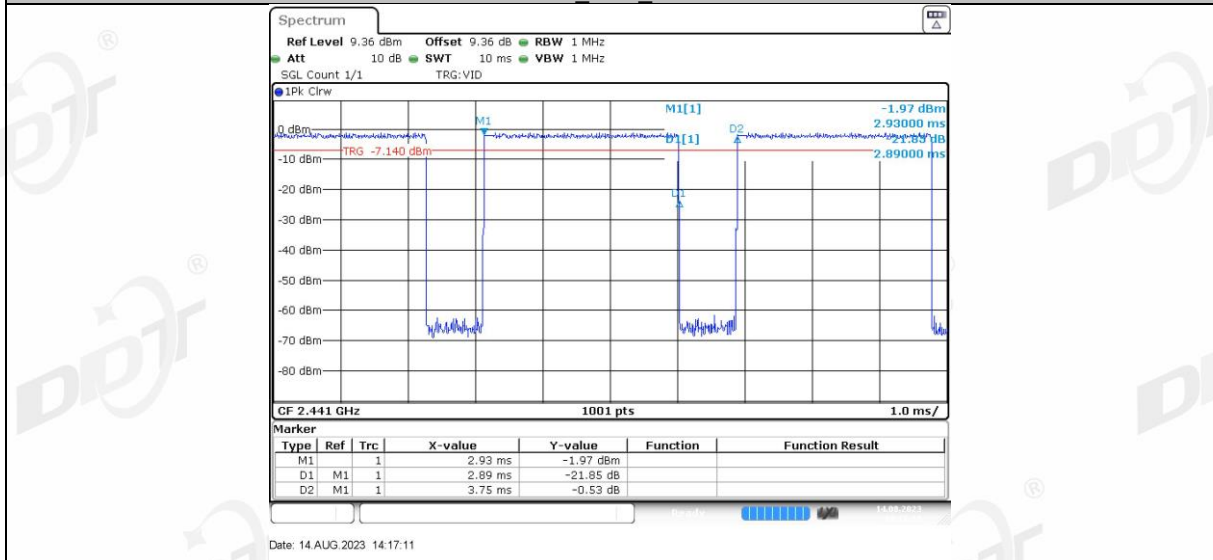

3DH5 Ant1_2480

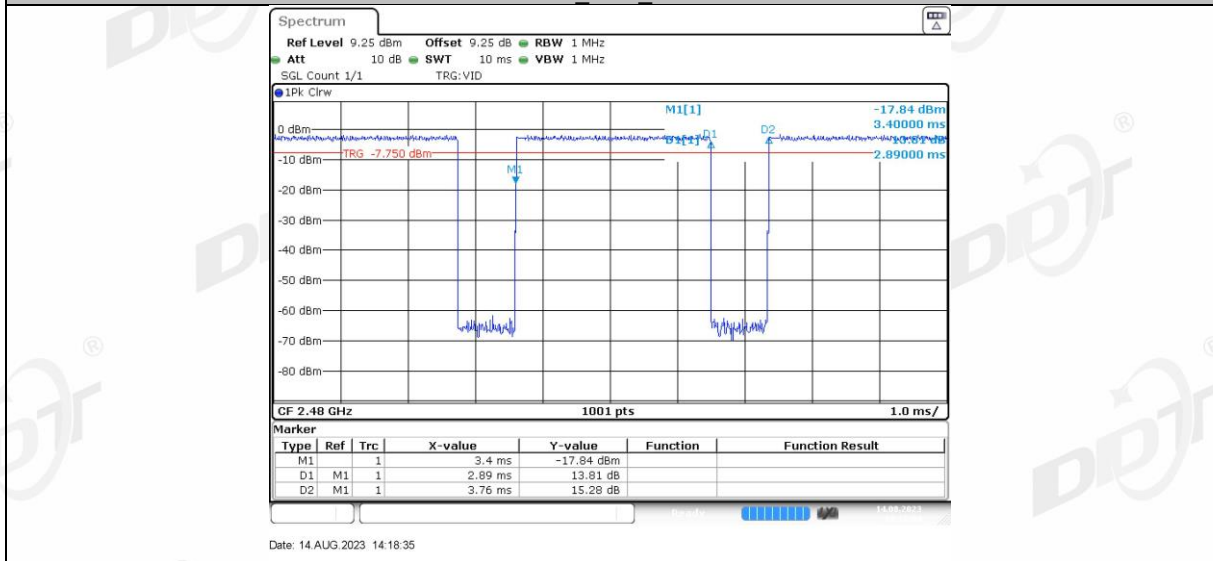

13. Radiated Emission

13.1. Block diagram of test setup

In 3 m Anechoic Chamber, test setup diagram for 9 kHz - 30 MHz:

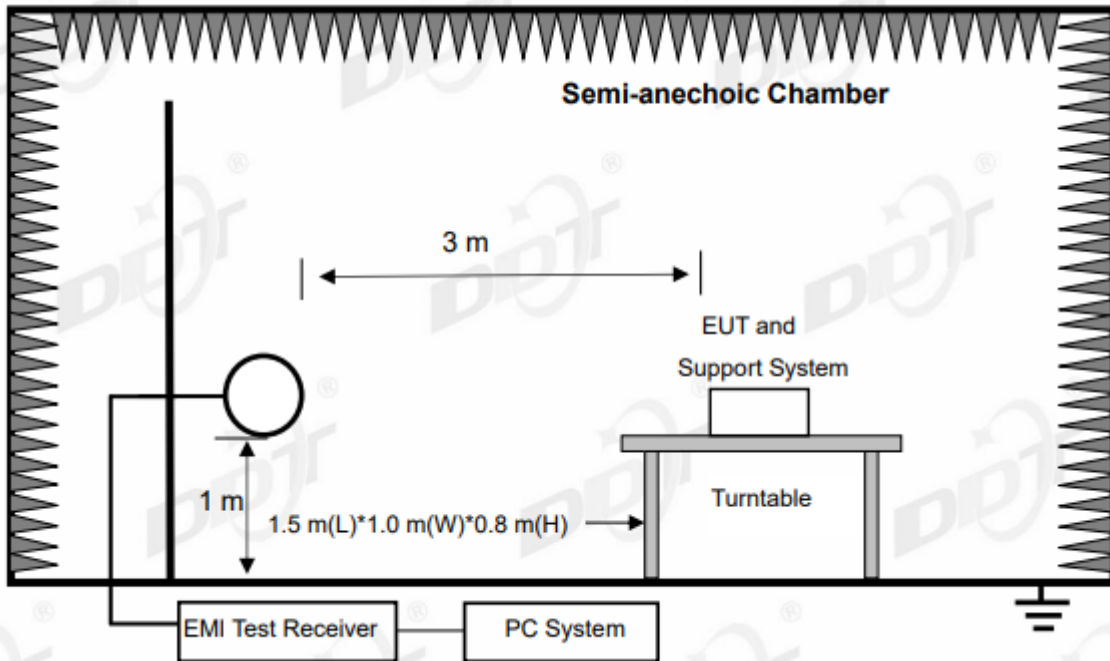

In 3 m Anechoic Chamber, test setup diagram for 30 MHz - 1 GHz:

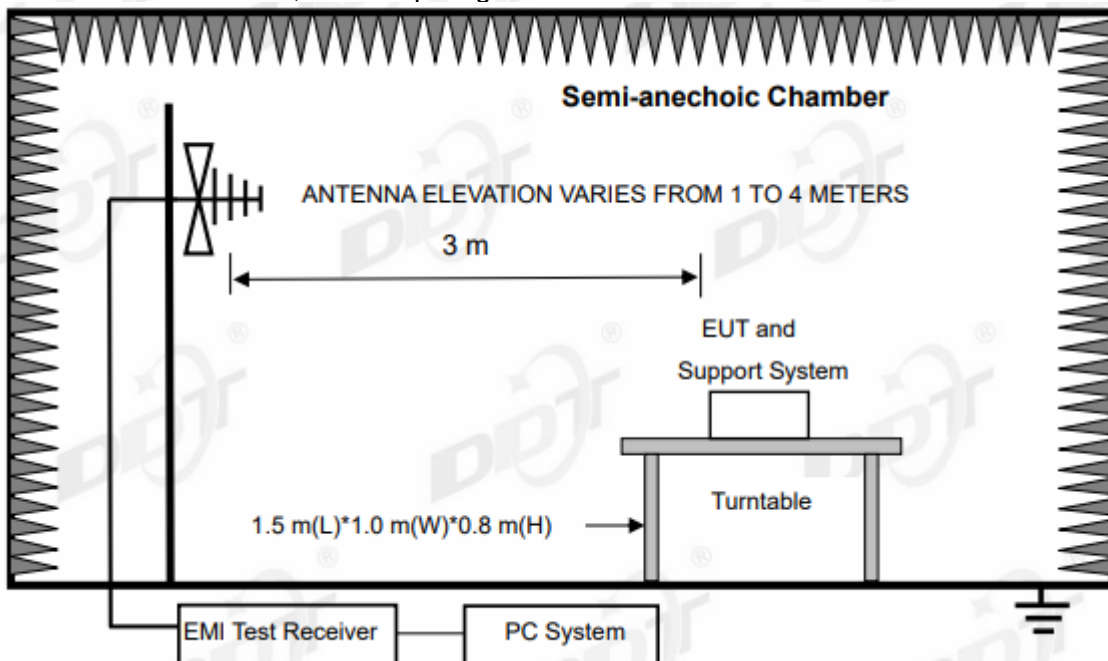

In 3 m Anechoic Chamber, test setup diagram for frequency above 1 GHz:

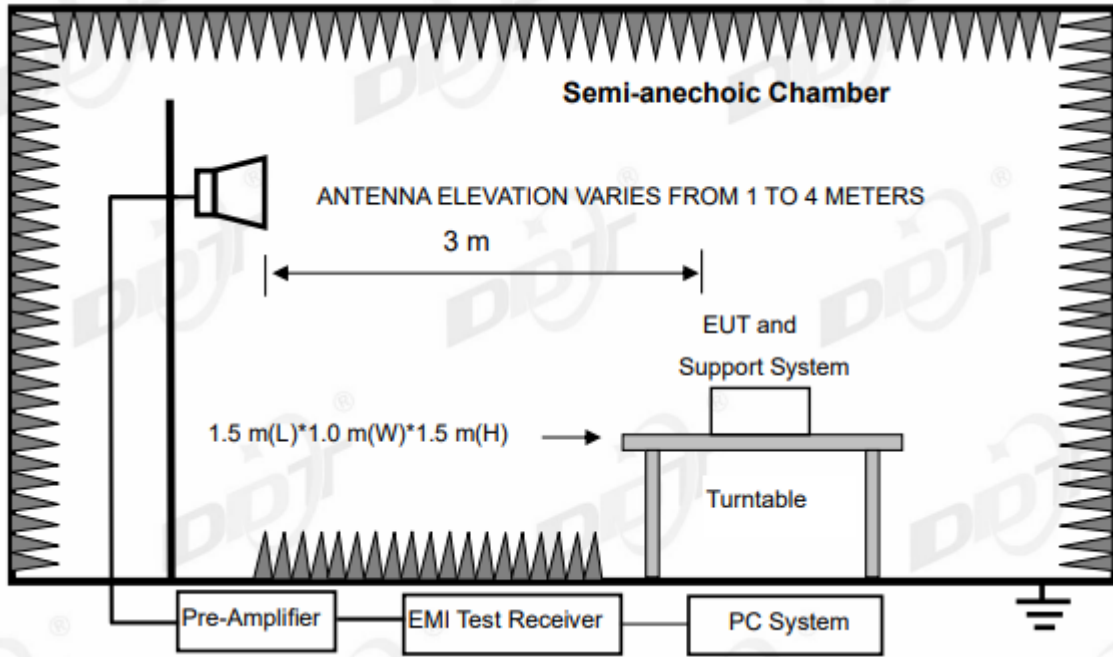

Note: For harmonic emissions test an appropriate high pass filter was inserted in the input port of AMP.

13.2. Limit

(1) FCC 15.205 Restricted frequency band

MHz	MHz	MHz	GHz
0.090-0.110	16.42-16.423	399.9-410	4.5-5.15
¹ 0.495-0.505	16.69475-16.69525	608-614	5.35-5.46
2.1735-2.1905	16.80425-16.80475	960-1240	7.25-7.75
4.125-4.128	25.5-25.67	1300-1427	8.025-8.5
4.1772&4.17775	37.5-38.25	1435-1626.5	9.0-9.2
4.2072&4.20775	73-74.6	1645.5-1646.5	9.3-9.5
6.215-6.218	74.8-75.2	1660-1710	10.6-12.7
6.26775-6.26825	108-121.94	1718.8-1722.2	13.25-13.4
6.31175-6.31225	123-138	2200-2300	14.47-14.5
8.291-8.294	149.9-150.05	2310-2390	15.35-16.2
8.362-8.366	156.52475-156.52525	2483.5-2500	17.7-21.4
8.37625-8.38675	156.7-156.9	2690-2900	22.01-23.12
8.41425-8.41475	162.0125-167.17	3260-3267	23.6-24.0
12.29-12.293	167.72-173.2	3332-3339	31.2-31.8
12.51975-12.52025	240-285	3345.8-3358	36.43-36.5
12.57675-12.57725	322-335.4	3600-4400	(²)
13.36-13.41			

¹Until February 1, 1999, this restricted band shall be 0.490-0.510 MHz

²Above 38.6

RSS-Gen section 8.10 Restricted frequency bands*

MHz	MHz	MHz	GHz
0.090-0.110	12.51975-12.52025	240-285	3.5-4.4
0.495-0.505	12.57675-12.57725	322-335.4	4.5-5.15
2.1735-2.1905	13.36-13.41	399.9-410	5.35-5.46
3.020-3.026	16.42-16.423	608-614	7.25-7.75
4.125-4.128	16.69475-16.69525	960-1427	8.025-8.5
4.1772&4.17775	16.80425-16.80475	1435-1626.5	9.0-9.2
4.2072&4.20775	25.5-25.67	1645.5-1646.5	9.3-9.5
5.677-5.683	37.5-38.25	1660-1710	10.6-12.7
6.215-6.218	73-74.6	1718.8-1722.2	13.25-13.4
6.26775-6.26825	74.8-75.2	2200-2300	14.47-14.5
6.31175-6.31225	108-138	2310-2390	15.35-16.2
8.291-8.294	149.9-150.05	2483.5-2500	17.7-21.4
8.362-8.366	156.52475-156.52525	2655-2900	22.01-23.12
8.37625-8.38675	156.7-156.9	3260-3267	23.6-24.0
8.41425-8.41475	162.0125-167.17	3332-3339	31.2-31.8
12.29-12.293	167.72-173.2	3345.8-3358	36.43-36.5
			Above 38.6

* Certain frequency bands listed in table and in bands above 38.6 GHz are designated for licence-exempt applications. These frequency bands and the requirements that apply to related devices are set out in the 200 and 300 series of RSSs.

(2) FCC 15.209 Limit & RSS-Gen section 8.9 Limit

FREQUENCY MHz	DISTANCE Meters	FIELD STRENGTHS LIMIT	
		$\mu\text{V}/\text{m}$	$\text{dB}(\mu\text{V})/\text{m}$
0.009 ~ 0.490	300	2400/F(kHz)	67.6-20log(F)
0.490 ~ 1.705	30	24000/F(kHz)	87.6-20log(F)
1.705 ~ 30.0	30	30	29.54
30 ~ 88	3	100	40.0
88 ~ 216	3	150	43.5
216 ~ 960	3	200	46.0
960 ~ 1000	3	500	54.0
Above 1000	3	74.0 dB(μV)/m (Peak) 54.0 dB(μV)/m (Average)	

Note: (1) The emission limits shown in the above table are based on measurements employing a CISPR QP detector except for the frequency bands 9 - 90 kHz, 110 - 490 kHz and above 1000 MHz, radiated emissions limits in these three bands are based on measurements employing an average detector.

(2) At frequencies below 30 MHz, measurement may be performed at a distance closer than that specified, and the limit at closer measurement distance can be extrapolated by below formula:

$$\text{Limit}_{3\text{m}}(\text{dB}\mu\text{V}/\text{m}) = \text{Limit}_{30\text{m}}(\text{dB}\mu\text{V}/\text{m}) + 40\text{Log}(30\text{m}/3\text{m})$$

(3) Limit for this EUT

The emissions appearing within 15.205 restricted frequency bands shall not exceed the limits shown in 15.209, and the emissions appearing within RSS-Gen section 8.10 Restricted frequency bands shall not exceed the limits shown in RSS-Gen section 8.9, all the other emissions shall be at least 20 dB below the fundamental emissions or comply with 15.209 limits and RSS-Gen section 8.9 limits.

13.3. Test Procedure

- (1) EUT was placed on a non-metallic table, 80 cm above the ground plane inside a semi-anechoic chamber for below 1G and 150 cm above the ground plane inside a fully-anechoic chamber for above 1G.
- (2) Test antenna was located 3 m from the EUT on an adjustable mast, and the antenna used as below table.

Test frequency range	Test antenna used	Test antenna distance
9 kHz - 30 MHz	Active Loop antenna	3 m
30 MHz - 1 GHz	Trilog Broadband Antenna	3 m
1 GHz - 18 GHz	Double Ridged Horn Antenna (1 GHz - 18 GHz)	3 m
18 GHz - 40 GHz	Horn Antenna (18 GHz - 40 GHz)	1 m

According to ANSI C63.10:2013 clause 6.4.6 and 6.5.3, for measurements below 30 MHz, Antenna was located 3 m from EUT, the loop antenna was positioned in three antenna orientations (parallel, perpendicular, and round-parallel), for each measurement antenna alignment, the EUT shall be rotated through 0° to 360° on a turntable, and the lowest height of the magnetic antenna shall be 1 m above the ground. For measurement above 30MHz, the trilog Broadband Antenna or Horn Antenna was located 3m from EUT, Measurements were made with the antenna positioned in both the horizontal and vertical planes of Polarization, and the measurement antenna was varied from 1 m to 4 m. in height above the reference ground plane to obtain the maximum signal strength.

(3) Below pre-scan procedure was first performed in order to find prominent frequency spectrum radiated emissions from 9 kHz to 25 GHz:

(a) Scanning the peak frequency spectrum with the antenna specified in step (3), and the EUT was rotated 360 degree, the antenna height was varied from 1 m to 4 m (Except loop antenna, it's fixed 1 m above ground.)

(b) Change work frequency or channel of device if practicable.

(c) Change modulation type of device if practicable.

(d) Change power supply range from 85% to 115% of the rated supply voltage

(e) Rotated EUT though three orthogonal axes to determine the attitude of EUT arrangement produces highest emissions.

Spectrum frequency from 9 kHz to 25 GHz (tenth harmonic of fundamental frequency) was

investigated, and no any obvious emission were detected from 18 GHz to 25 GHz, so below final test was performed with frequency range from 9 kHz to 18 GHz.

- (4) For final emissions measurements at each frequency of interest, the EUT was rotated and the antenna height was varied between 1 m and 4 m in order to maximize the emission. Measurements in both horizontal and vertical polarities were made and the data was recorded. In order to find the maximum emission, the relative positions of equipment and all of the interface cables were changed according to ANSI C63.10:2013 on Radiated Emission test.
- (5) The emissions from 9 kHz to 1 GHz were measured based on CISPR QP detector except for the frequency bands 9 - 90 kHz, 110 - 490 kHz, for emissions from 9 kHz - 90 kHz, 110 kHz - 490 kHz and above 1 GHz were measured based on average detector, for emissions above 1 GHz, peak emissions also be measured and need comply with Peak limit.
- (6) The emissions from 9 kHz to 1 GHz, QP or average values were measured with EMI receiver with below RBW.

Frequency band	RBW
9 kHz - 150 kHz	200 Hz
150 kHz - 30 MHz	9 kHz
30 MHz - 1 GHz	120 kHz

- (7) For emissions above 1GHz, both Peak and Average level were measured with Spectrum Analyzer, and the RBW is set at 1 MHz, VBW is set at 3 MHz for Peak measure; According ANSI C63.10:2013 clause 4.1.4.2.2 procedure for average measure.

13.4. Test result

Pass. (See below detailed test result)

All the emissions except fundamental emission from 9 kHz to 25 GHz were comply with 15.209 limits and RSS-Gen section 8.9 limits.

Note1: According exploratory test, the emission levels are 20 dB below the limit detected from 9 kHz to 30 MHz and 18 GHz to 25 GHz, so the final test was performed with frequency range from 30 MHz to 18 GHz and recorded in below.

Note2: 30 MHz ~ 25 GHz: (Scan with GFSK, $\pi/4$ -DQPSK and 8DPSK, the worst case is 8DPSK Mode)

Note3: For emissions below 1 GHz, according exploratory explorer test, when change Tx mode and channel, have no distinct influence on emissions level, so for emissions below 1 GHz, the final test was only performed with EUT working in 8DPSK, Tx 2402 MHz mode.

Note4: For emissions above 1 GHz. If peak results comply with AV limit, AV Result is deemed to comply with AV limit.

Radiated Emission test (below 1 GHz)

TR-4-E-009 Radiated Emission Test Result

Test Date: 2023-07-29 **Tested By:** Bairong
EUT: 3.1CH Soundbar with Virtual Dolby Atmos and Wireless Subwoofer **Model Number:** CINEMA SB580
Test Mode: Tx mode **Power Supply:** AC 120V/60Hz
Condition: Temp:21.7°C;Humi:64.9% **Test Site:** DDT 3# Chamber
File Path: d:\ts\2023 report data\Q23071316-2E SB580\FCC BELOW 1G\20230729-223458_H
Memo:

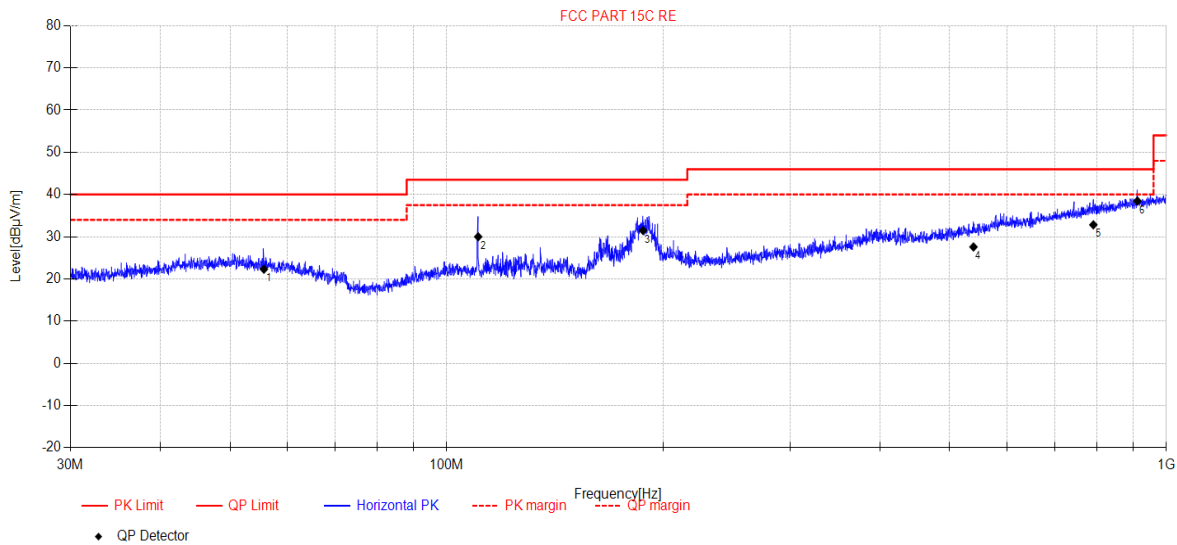

Final Data List										
NO.	Freq. [MHz]	Reading [dBµV/m]	Antenna Factor [dB]	Cable Loss [dB]	AMP [dB]	Result [dBµV/m]	Limit [dBµV/m]	Margin [dB]	Detector	Polarity
1	55.72	5	12.56	4.75	0.00	22.31	40.00	17.69	QP	Horizontal
2	110.62	14.49	10.38	5.12	0.00	29.99	43.50	13.51	QP	Horizontal
3	187.42	15.89	9.94	5.63	0.00	31.46	43.50	12.04	QP	Horizontal
4	539.54	2.9	17.59	7.09	0.00	27.58	46.00	18.42	QP	Horizontal
5	791.77	3.72	21.14	7.96	0.00	32.82	46.00	13.18	QP	Horizontal
6	911.60	7.57	22.50	8.38	0.00	38.45	46.00	7.55	QP	Horizontal

Note:

1. Result Level = Reading + Cable loss + Antenna Factor + AMP
2. If Peak Result complies with QP limit, QP Result is deemed to comply with QP limit.
3. Test setup: RBW: 120 kHz, VBW: 300 kHz, Sweep time: auto.

TR-4-E-009 Radiated Emission Test Result

Test Date: 2023-07-29 **Tested By:** Bairong
EUT: 3.1CH Soundbar with Virtual Dolby Atmos and Wireless Subwoofer **Model Number:** CINEMA SB580
Test Mode: Tx mode **Power Supply:** AC 120V/60Hz
Condition: Temp:21.7°C;Humi:64.9% **Test Site:** DDT 3# Chamber
File Path: d:\ts\2023 report data\Q23071316-2E SB580\FCC BELOW 1G\20230729-223545_V

Memo:

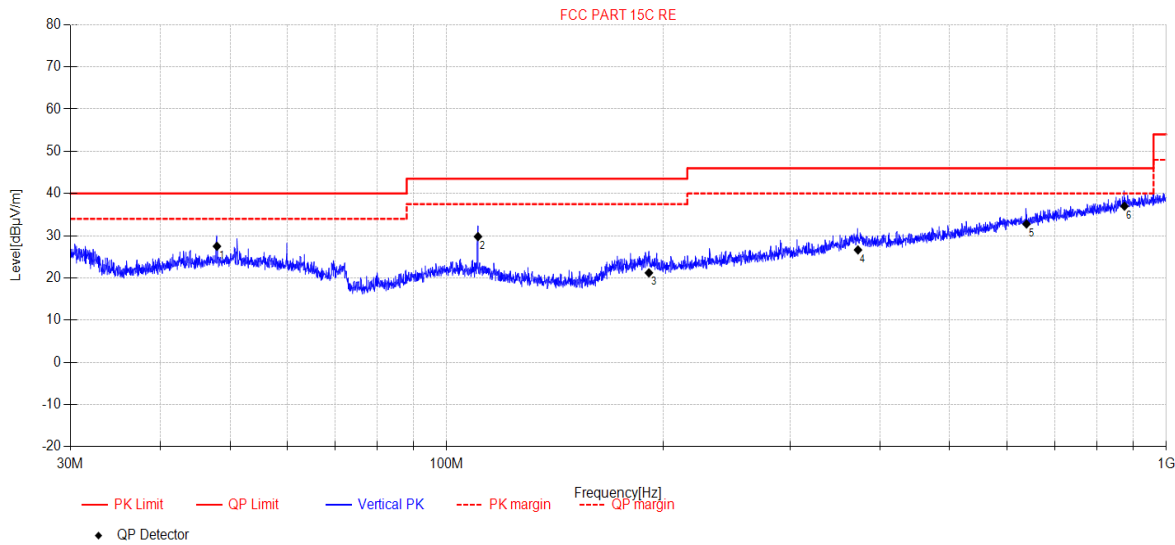

Final Data List										
NO.	Freq. [MHz]	Reading [dBµV/m]	Antenna Factor [dB]	Cable Loss [dB]	AMP [dB]	Result [dBµV/m]	Limit [dBµV/m]	Margin [dB]	Detector	Polarity
1	47.96	9.6	13.20	4.70	0.00	27.50	40.00	12.50	QP	Vertical
2	110.54	14.28	10.39	5.12	0.00	29.79	43.50	13.71	QP	Vertical
3	191.00	5.24	10.30	5.66	0.00	21.20	43.50	22.30	QP	Vertical
4	372.86	5.12	14.96	6.55	0.00	26.63	46.00	19.37	QP	Vertical
5	639.32	6.17	19.10	7.50	0.00	32.77	46.00	13.23	QP	Vertical
6	874.66	6.46	22.29	8.25	0.00	37.00	46.00	9.00	QP	Vertical

Note:

1. Result Level = Reading + Cable loss + Antenna Factor + AMP
2. If Peak Result complies with QP limit, QP Result is deemed to comply with QP limit.
3. Test setup: RBW: 120 kHz, VBW: 300 kHz, Sweep time: auto.

Radiated Emission test (above 1 GHz)

TR-4-E-009 Radiated Emission Test Result

Test Date: 2023-07-29 **Tested By:** Bairong
EUT: 3.1CH Soundbar with Virtual Dolby Atmos and Wireless Subwoofer **Model Number:** CINEMA SB580
Test Mode: Tx mode **Power Supply:** AC 120V/60Hz
Condition: Temp:21.7°C;Humi:64.9% **Test Site:** DDT 3# Chamber
File Path: d:\ts\2023 report data\Q23071316-2E SB580\FCC ABOVE 1G\1
Memo: DH5 2402

Test Graph

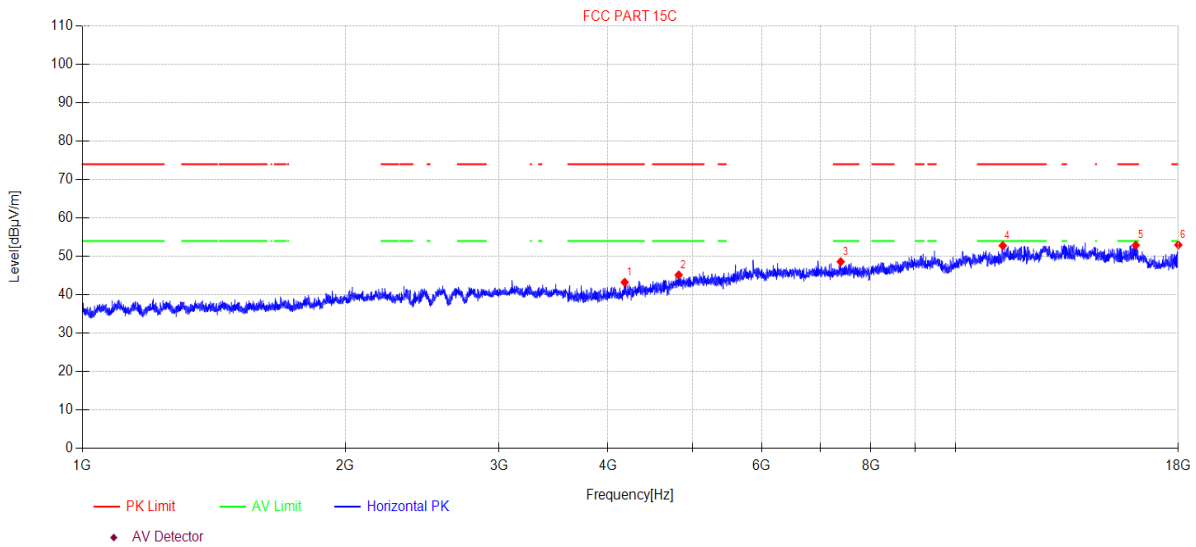

Suspected Data List											
N O.	Freq. [MHz]	Reading [dBµV/m]	Cable loss [dB]	Antenna Factor [dB]	AMP [dB]	Level [dBµV/m]	Limit [dBµV/m]	Margin [dB]	Detector	Polarity	
1	4179.96	47.33	6.21	31.06	-41.35	43.25	74.00	30.75	PK	Horizontal	
2	4820.04	46.42	7.51	32.38	-41.15	45.16	74.00	28.84	PK	Horizontal	
3	7388.59	45.46	7.64	36.50	-41.00	48.60	74.00	25.40	PK	Horizontal	
4	11329.17	43.72	9.94	39.10	-39.97	52.79	74.00	21.21	PK	Horizontal	
5	16085.97	39.93	15.54	37.81	-40.39	52.89	74.00	21.11	PK	Horizontal	
6	18000.00	38.75	13.13	41.80	-40.70	52.98	74.00	21.02	PK	Horizontal	

Note:

1. Level = Reading + Cable loss + Antenna Factor + AMP
2. If Peak Result complies with AV limit, AV Result is deemed to comply with AV limit.
3. Test setup: RBW: 1 MHz, VBW: 3 MHz, Sweep time: auto.

TR-4-E-009 Radiated Emission Test Result

Test Date: 2023-07-29 **Tested By:** Bairong
EUT: 3.1CH Soundbar with Virtual Dolby Atmos and Wireless Subwoofer **Model Number:** CINEMA SB580
Test Mode: Tx mode **Power Supply:** AC 120V/60Hz
Condition: Temp:21.7°C;Humi:64.9% **Test Site:** DDT 3# Chamber
File Path: d:\ts\2023 report data\Q23071316-2E SB580\FCC ABOVE 1G\2
Memo: DH5 2402

Test Graph

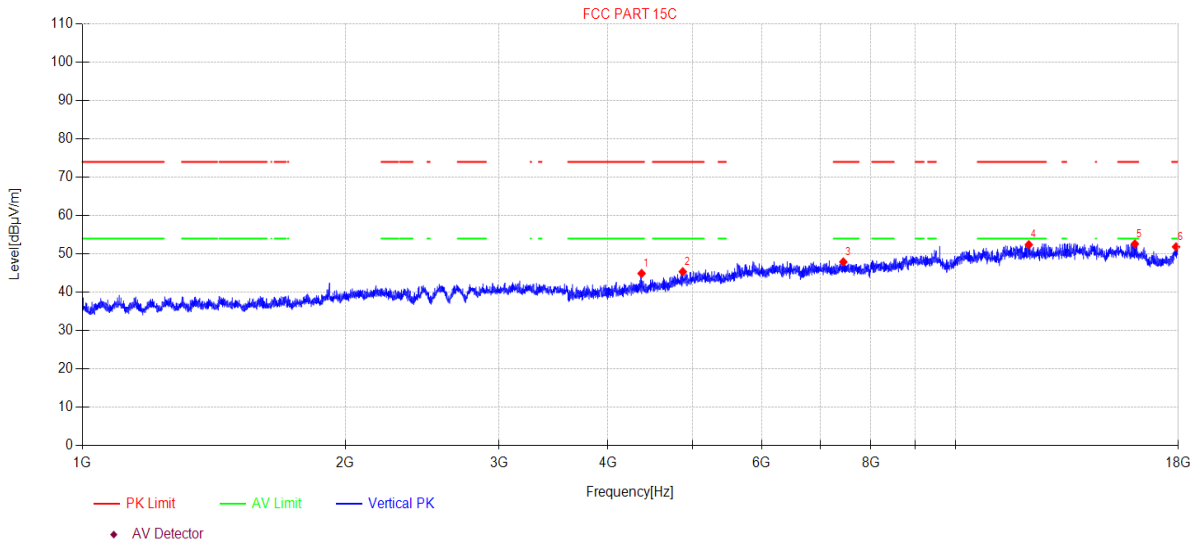

Suspected Data List										
N O.	Freq. [MHz]	Reading [dBµV/m]	Cable loss [dB]	Antenna Factor [dB]	AMP [dB]	Level [dBµV/m]	Limit [dBµV/m]	Margin [dB]	Detector	Polarity
1	4370.20	48.15	6.60	31.44	-41.29	44.90	74.00	29.10	PK	Vertical
2	4871.86	46.35	7.61	32.54	-41.14	45.36	74.00	28.64	PK	Vertical
3	7440.02	44.76	7.64	36.50	-41.00	47.90	74.00	26.10	PK	Vertical
4	12135.86	41.81	10.54	39.10	-39.04	52.41	74.00	21.59	PK	Vertical
5	16048.82	39.47	15.69	37.85	-40.40	52.61	74.00	21.39	PK	Vertical
6	17891.09	38.36	13.00	41.14	-40.66	51.84	74.00	22.16	PK	Vertical

Note:

- Level = Reading + Cable loss + Antenna Factor + AMP
- If Peak Result complies with AV limit, AV Result is deemed to comply with AV limit.
- Test setup: RBW: 1 MHz, VBW: 3 MHz, Sweep time: auto.

TR-4-E-009 Radiated Emission Test Result

Test Date: 2023-07-29 **Tested By:** Bairong
EUT: 3.1CH Soundbar with Virtual Dolby Atmos and Wireless Subwoofer **Model Number:** CINEMA SB580
Test Mode: Tx mode **Power Supply:** AC 120V/60Hz
Condition: Temp:21.7°C;Humi:64.9% **Test Site:** DDT 3# Chamber
File Path: d:\ts\2023 report data\Q23071316-2E SB580\FCC ABOVE 1G\3
Memo: DH5 2441

Test Graph

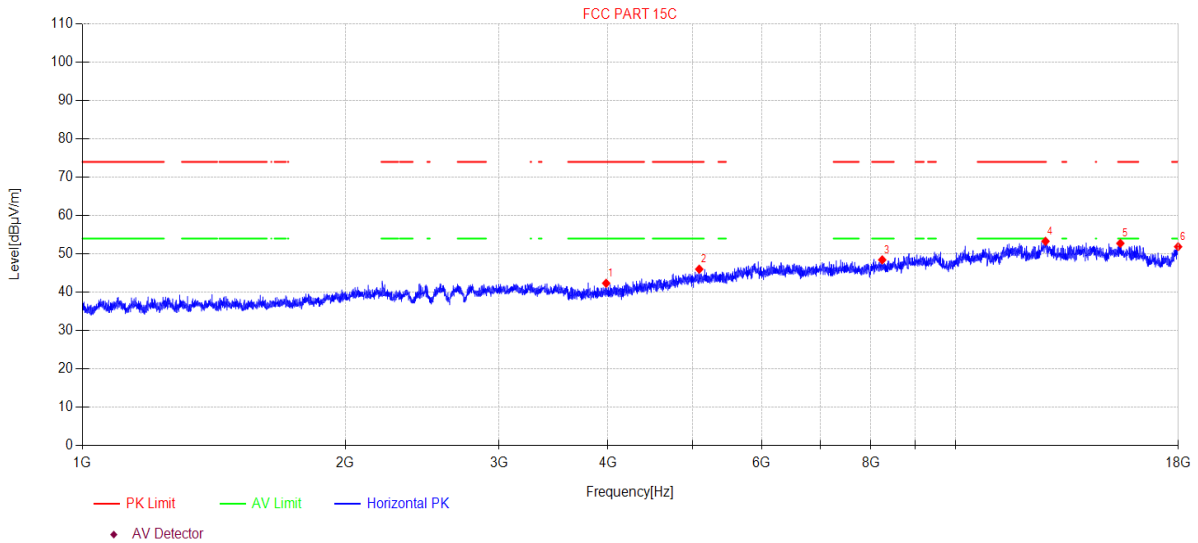

Suspected Data List										
N O.	Freq. [MHz]	Reading [dBµV/m]	Cable loss [dB]	Antenna Factor [dB]	AMP [dB]	Level [dBµV/m]	Limit [dBµV/m]	Margin [dB]	Detector	Polarity
1	3980.71	47.23	5.85	30.66	-41.39	42.35	74.00	31.65	PK	Horizontal
2	5087.71	46.19	7.99	32.90	-41.06	46.02	74.00	27.98	PK	Horizontal
3	8243.88	44.01	7.94	37.10	-40.61	48.44	74.00	25.56	PK	Horizontal
4	12680.86	42.97	10.54	39.36	-39.58	53.29	74.00	20.71	PK	Horizontal
5	15448.11	40.73	13.38	38.65	-40.01	52.75	74.00	21.25	PK	Horizontal
6	17989.60	37.72	13.12	41.74	-40.70	51.88	74.00	22.12	PK	Horizontal

Note:

1. Level = Reading + Cable loss + Antenna Factor + AMP
2. If Peak Result complies with AV limit, AV Result is deemed to comply with AV limit.
3. Test setup: RBW: 1 MHz, VBW: 3 MHz, Sweep time: auto.

TR-4-E-009 Radiated Emission Test Result

Test Date: 2023-07-29 **Tested By:** Bairong
EUT: 3.1CH Soundbar with Virtual Dolby Atmos and Wireless Subwoofer **Model Number:** CINEMA SB580
Test Mode: Tx mode **Power Supply:** AC 120V/60Hz
Condition: Temp:21.7°C;Humi:64.9% **Test Site:** DDT 3# Chamber
File Path: d:\ts\2023 report data\Q23071316-2E SB580\FCC ABOVE 1G\4
Memo: DH5 2441

Test Graph

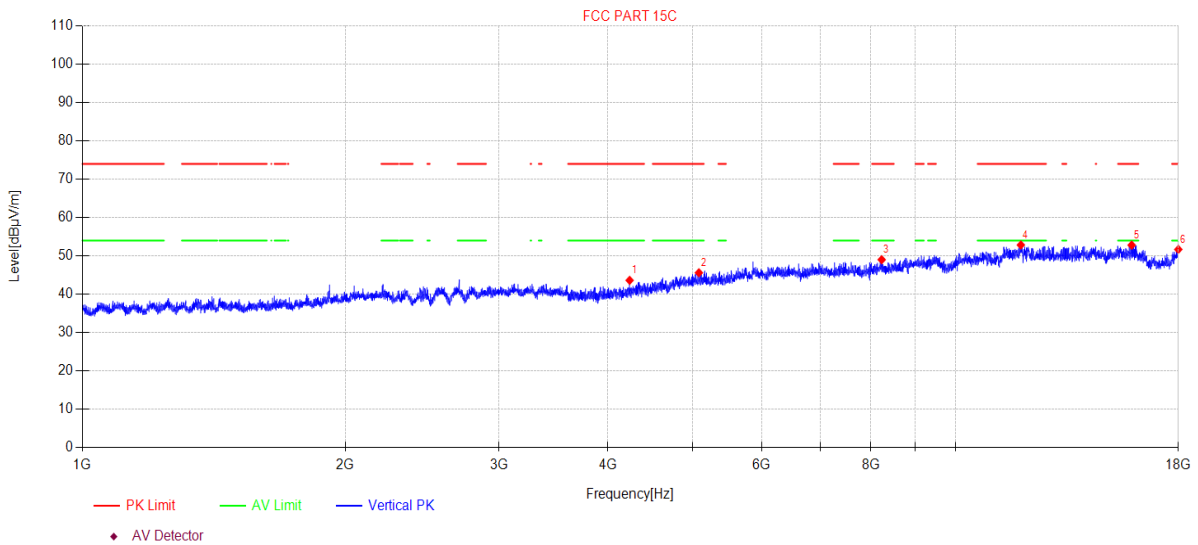

Suspected Data List										
N O.	Freq. [MHz]	Reading [dBµV/m]	Cable loss [dB]	Antenna Factor [dB]	AMP [dB]	Level [dBµV/m]	Limit [dBµV/m]	Margin [dB]	Detector	Polarity
1	4234.68	47.48	6.32	31.17	-41.33	43.64	74.00	30.36	PK	Vertical
2	5083.30	45.80	7.99	32.90	-41.07	45.62	74.00	28.38	PK	Vertical
3	8231.98	44.63	7.92	37.10	-40.63	49.02	74.00	24.98	PK	Vertical
4	11882.50	42.70	10.44	38.80	-39.09	52.85	74.00	21.15	PK	Vertical
5	15914.88	39.60	15.49	38.07	-40.34	52.82	74.00	21.18	PK	Vertical
6	18000.00	37.46	13.13	41.80	-40.70	51.69	74.00	22.31	PK	Vertical

Note:

1. Level = Reading + Cable loss + Antenna Factor + AMP
2. If Peak Result complies with AV limit, AV Result is deemed to comply with AV limit.
3. Test setup: RBW: 1 MHz, VBW: 3 MHz, Sweep time: auto.

TR-4-E-009 Radiated Emission Test Result

Test Date: 2023-07-29 **Tested By:** Bairong
EUT: 3.1CH Soundbar with Virtual Dolby Atmos and Wireless Subwoofer **Model Number:** CINEMA SB580
Test Mode: Tx mode **Power Supply:** AC 120V/60Hz
Condition: Temp:21.7°C;Humi:64.9% **Test Site:** DDT 3# Chamber
File Path: d:\ts\2023 report data\Q23071316-2E SB580\FCC ABOVE 1G\5
Memo: DH5 2480

Test Graph

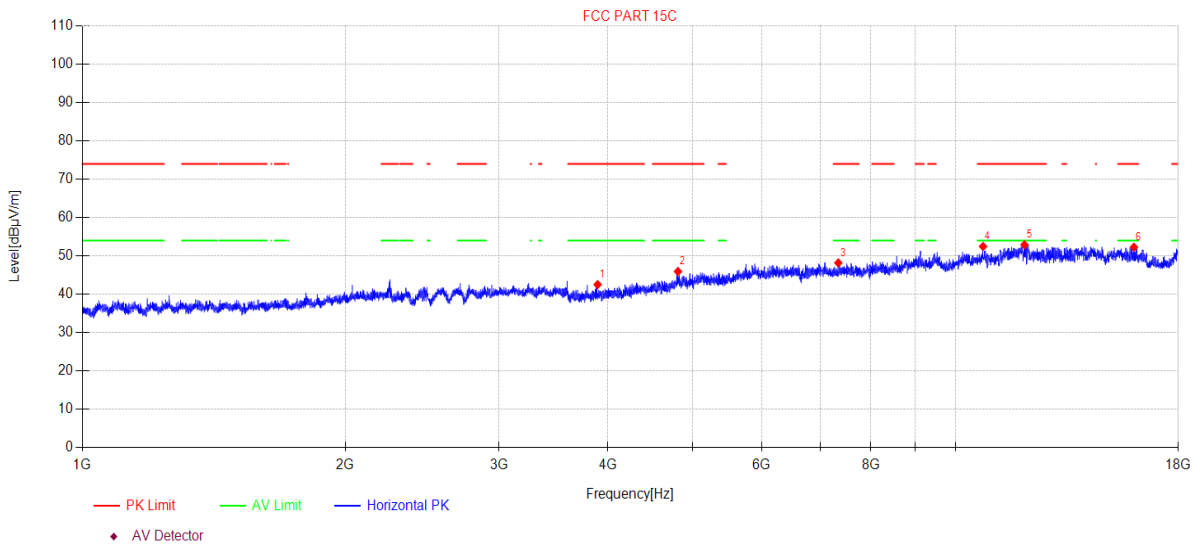

Suspected Data List										
N O.	Freq. [MHz]	Reading [dBµV/m]	Cable loss [dB]	Antenna Factor [dB]	AMP [dB]	Level [dBµV/m]	Limit [dBµV/m]	Margin [dB]	Detector	Polarity
1	3891.98	47.56	5.83	30.48	-41.34	42.53	74.00	31.47	PK	Horizontal
2	4810.30	47.27	7.49	32.34	-41.16	45.94	74.00	28.06	PK	Horizontal
3	7341.76	45.06	7.63	36.50	-41.00	48.19	74.00	25.81	PK	Horizontal
4	10754.87	44.41	9.48	39.10	-40.52	52.47	74.00	21.53	PK	Horizontal
5	11996.37	42.36	10.54	38.90	-38.91	52.89	74.00	21.11	PK	Horizontal
6	16011.76	38.97	15.83	37.89	-40.40	52.29	74.00	21.71	PK	Horizontal

Note:

1. Level = Reading + Cable loss + Antenna Factor + AMP
2. If Peak Result complies with AV limit, AV Result is deemed to comply with AV limit.
3. Test setup: RBW: 1 MHz, VBW: 3 MHz, Sweep time: auto.

TR-4-E-009 Radiated Emission Test Result

Test Date: 2023-07-29 **Tested By:** Bairong
EUT: 3.1CH Soundbar with Virtual Dolby Atmos and Wireless Subwoofer **Model Number:** CINEMA SB580
Test Mode: Tx mode **Power Supply:** AC 120V/60Hz
Condition: Temp:21.7°C;Humi:64.9% **Test Site:** DDT 3# Chamber
File Path: d:\ts\2023 report data\Q23071316-2E SB580\FCC ABOVE 1G\6
Memo: DH5 2480

Test Graph

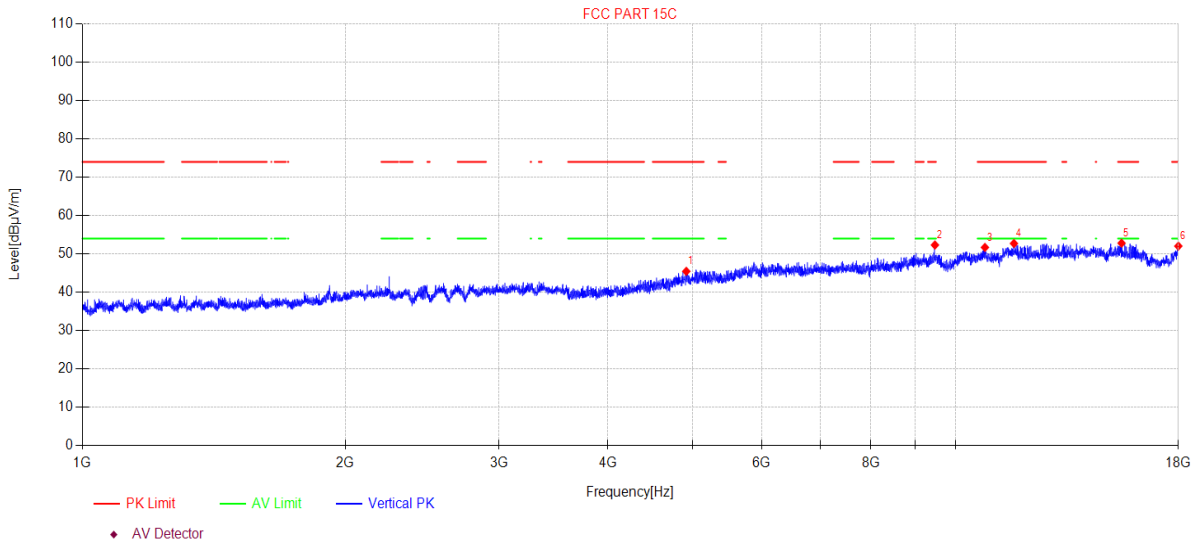

Suspected Data List										
N O.	Freq. [MHz]	Reading [dBµV/m]	Cable loss [dB]	Antenna Factor [dB]	AMP [dB]	Level [dBµV/m]	Limit [dBµV/m]	Margin [dB]	Detector	Polarity
1	4917.13	46.21	7.70	32.67	-41.12	45.46	74.00	28.54	PK	Vertical
2	9473.37	45.06	8.83	38.40	-39.97	52.32	74.00	21.68	PK	Vertical
3	10807.84	43.60	9.51	39.10	-40.52	51.69	74.00	22.31	PK	Vertical
4	11668.11	43.08	10.24	38.83	-39.43	52.72	74.00	21.28	PK	Vertical
5	15497.29	40.65	13.60	38.60	-40.05	52.80	74.00	21.20	PK	Vertical
6	18000.00	37.81	13.13	41.80	-40.70	52.04	74.00	21.96	PK	Vertical

Note:

1. Level = Reading + Cable loss + Antenna Factor + AMP
2. If Peak Result complies with AV limit, AV Result is deemed to comply with AV limit.
3. Test setup: RBW: 1 MHz, VBW: 3 MHz, Sweep time: auto.

14. Band Edge Compliance (Radiated Method)

14.1. Block diagram of test setup

In 3 m Anechoic Chamber, test setup diagram for frequency above 1 GHz:

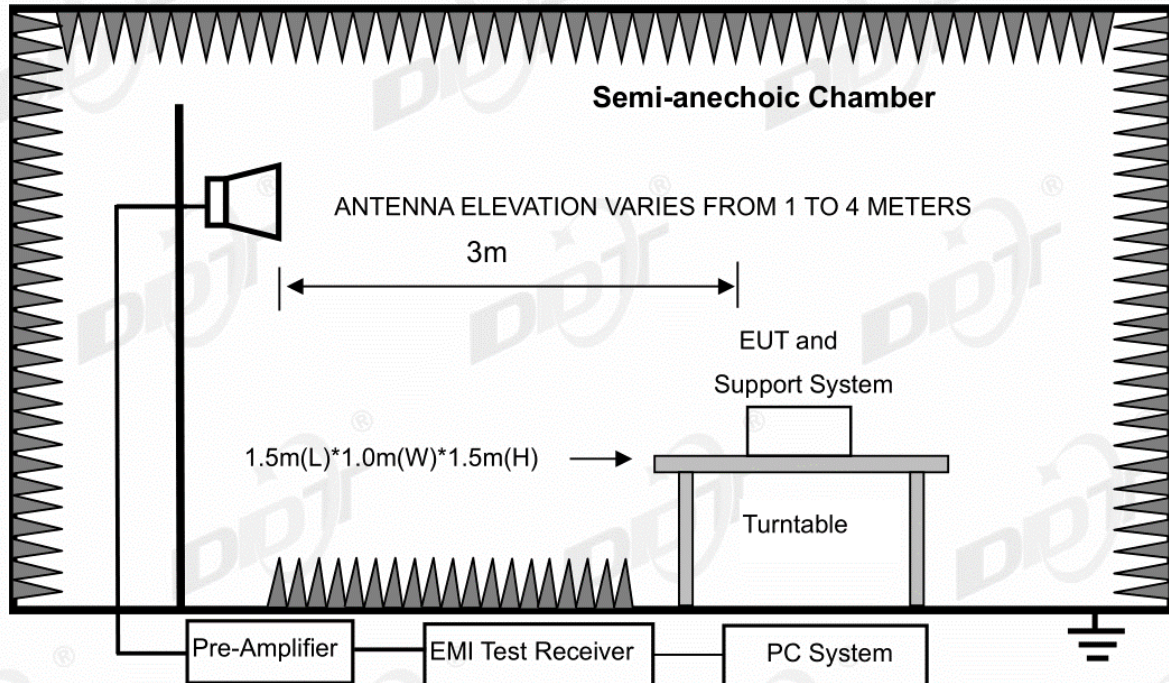

14.2. Limit

All restriction band should comply with 15.209 and RSS-Gen section 8.9 limits, other emission should be at least 20 dB below the fundamental.

14.3. Test Procedure

Same with Radiated Emission except change investigated frequency range from 2310 MHz to 2410 MHz and 2475 MHz to 2500 MHz.

Remark: All restriction band have been tested, and only the worst case is shown in report.

14.4. Test result

Pass. (See below detailed test result)

Remark: hopping on and hopping off mode all have been test, hopping off mode is worse and reported only. Scan with all mode, the worst case is recorded in this report.

TR-4-E-009 Radiated Emission Test Result

Test Date: 2023-07-29 **Tested By:** Bairong
EUT: 3.1CH Soundbar with Virtual Dolby Atmos and Wireless Subwoofer **Model Number:** CINEMA SB580
Test Mode: Tx mode **Power Supply:** AC 120V/60Hz
Condition: Temp:21.7°C;Humi:64.9% **Test Site:** DDT 3# Chamber
File Path: d:\ts\2023 report data\Q23071316-2E SB580\FCC ABOVE 1G\11
Memo: DH5 2402

Test Graph

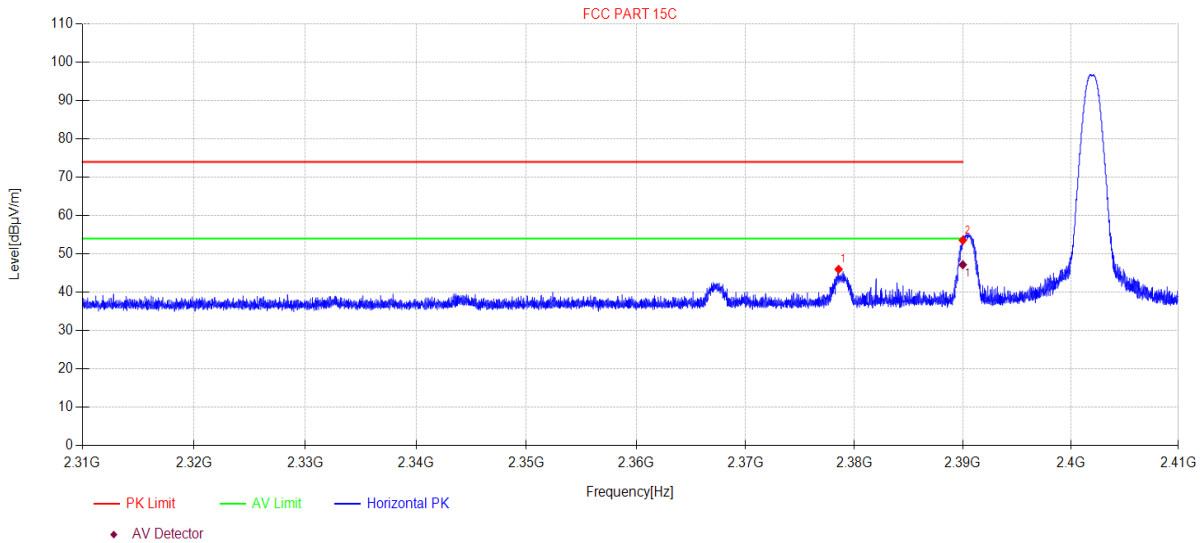

Suspected Data List										
NO	Freq. [MHz]	Reading [dBµV/m]	Cable loss [dB]	Antenna Factor [dB]	AMP [dB]	Level [dBµV/m]	Limit [dBµV/m]	Margin [dB]	Detector	Polarity
1	2378.55	54.79	3.86	27.46	-40.12	45.99	74.00	28.01	PK	Horizontal
2	2390.00	62.33	3.87	27.48	-40.13	53.55	74.00	20.45	PK	Horizontal

Final Data List										
NO	Freq. [MHz]	Reading [dBµV/m]	Cable loss [dB]	Antenna Factor [dB]	AMP [dB]	Level [dBµV/m]	Limit [dBµV/m]	Margin [dB]	Detector	Polarity
1	2390.00	55.96	3.87	27.48	-40.13	47.18	54.00	6.82	AV	Horizontal

Note:

1. Level = Reading + Cable loss + Antenna Factor + AMP
2. If Peak Result complies with AV limit, AV Result is deemed to comply with AV limit.
3. Test setup: RBW: 1 MHz, VBW: 3 MHz, Sweep time: auto.

TR-4-E-009 Radiated Emission Test Result

Test Date: 2023-07-29 **Tested By:** Bairong
EUT: 3.1CH Soundbar with Virtual Dolby Atmos and Wireless Subwoofer **Model Number:** CINEMA SB580
Test Mode: Tx mode **Power Supply:** AC 120V/60Hz
Condition: Temp:21.7°C;Humi:64.9% **Test Site:** DDT 3# Chamber
File Path: d:\ts\2023 report data\Q23071316-2E SB580\FCC ABOVE 1G\12
Memo: DH5 2402

Test Graph

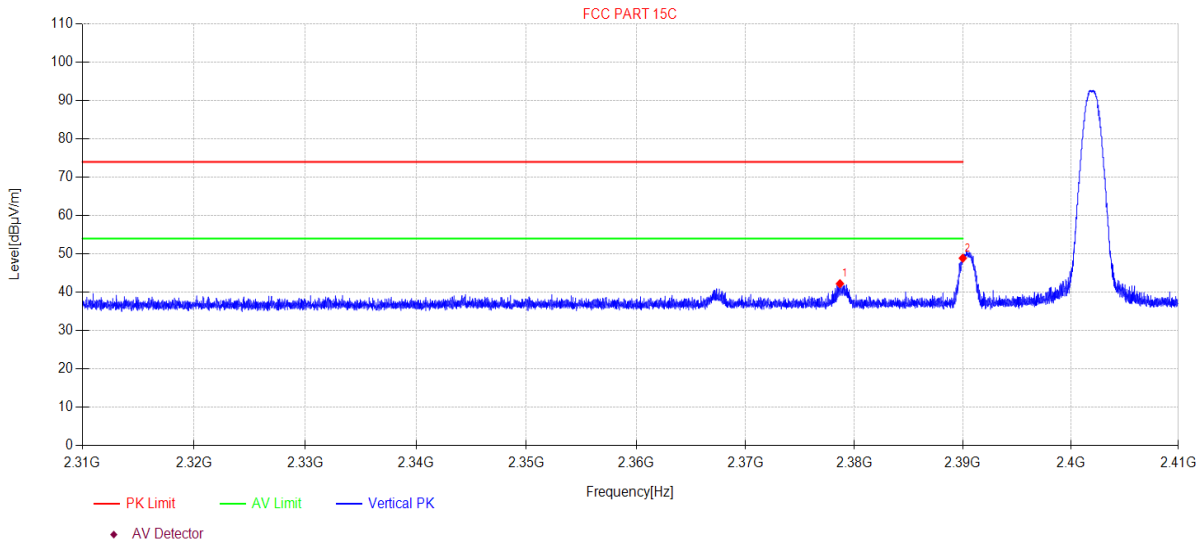

Suspected Data List										
NO	Freq. [MHz]	Reading [dBµV/m]	Cable loss [dB]	Antenna Factor [dB]	AMP [dB]	Level [dBµV/m]	Limit [dBµV/m]	Margin [dB]	Detector	Polarity
1	2378.67	51.04	3.86	27.46	-40.12	42.24	74.00	31.76	PK	Vertical
2	2390.00	57.68	3.87	27.48	-40.13	48.90	74.00	25.10	PK	Vertical

Note:

- Level = Reading + Cable loss + Antenna Factor + AMP
- If Peak Result complies with AV limit, AV Result is deemed to comply with AV limit.
- Test setup: RBW: 1 MHz, VBW: 3 MHz, Sweep time: auto.

TR-4-E-009 Radiated Emission Test Result

Test Date: 2023-07-29 **Tested By:** Bairong
EUT: 3.1CH Soundbar with Virtual Dolby Atmos and Wireless Subwoofer **Model Number:** CINEMA SB580
Test Mode: Tx mode **Power Supply:** AC 120V/60Hz
Condition: Temp:21.7°C;Humi:64.9% **Test Site:** DDT 3# Chamber
File Path: d:\ts\2023 report data\Q23071316-2E SB580\FCC ABOVE 1G\17
Memo: DH5 2480

Test Graph

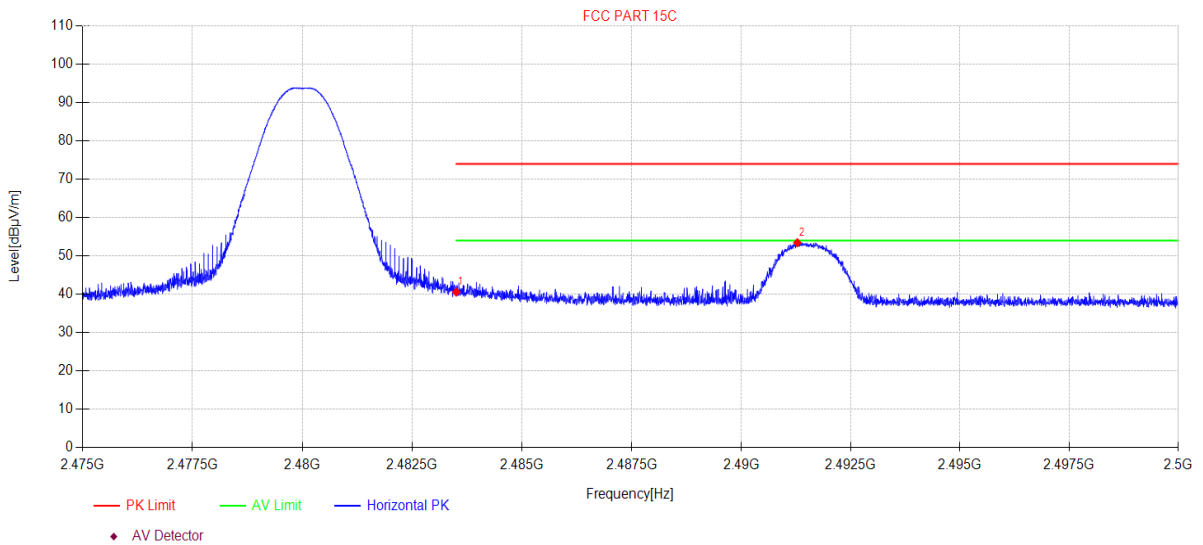

Suspected Data List										
NO	Freq. [MHz]	Reading [dBμV/m]	Cable loss [dB]	Antenna Factor [dB]	AMP [dB]	Level [dBμV/m]	Limit [dBμV/m]	Margin [dB]	Detector	Polarity
1	2483.50	49.14	3.94	27.73	-40.23	40.58	74.00	33.42	PK	Horizontal
2	2491.28	61.98	3.94	27.77	-40.24	53.45	74.00	20.55	PK	Horizontal

Note:

- Level = Reading + Cable loss + Antenna Factor + AMP
- If Peak Result complies with AV limit, AV Result is deemed to comply with AV limit.
- Test setup: RBW: 1 MHz, VBW: 3 MHz, Sweep time: auto.

TR-4-E-009 Radiated Emission Test Result

Test Date: 2023-07-29 **Tested By:** Bairong
EUT: 3.1CH Soundbar with Virtual Dolby Atmos and Wireless Subwoofer **Model Number:** CINEMA SB580
Test Mode: Tx mode **Power Supply:** AC 120V/60Hz
Condition: Temp:21.7°C;Humi:64.9% **Test Site:** DDT 3# Chamber
File Path: d:\ts\2023 report data\Q23071316-2E SB580\FCC ABOVE 1G\18
Memo: DH5 2480

Test Graph

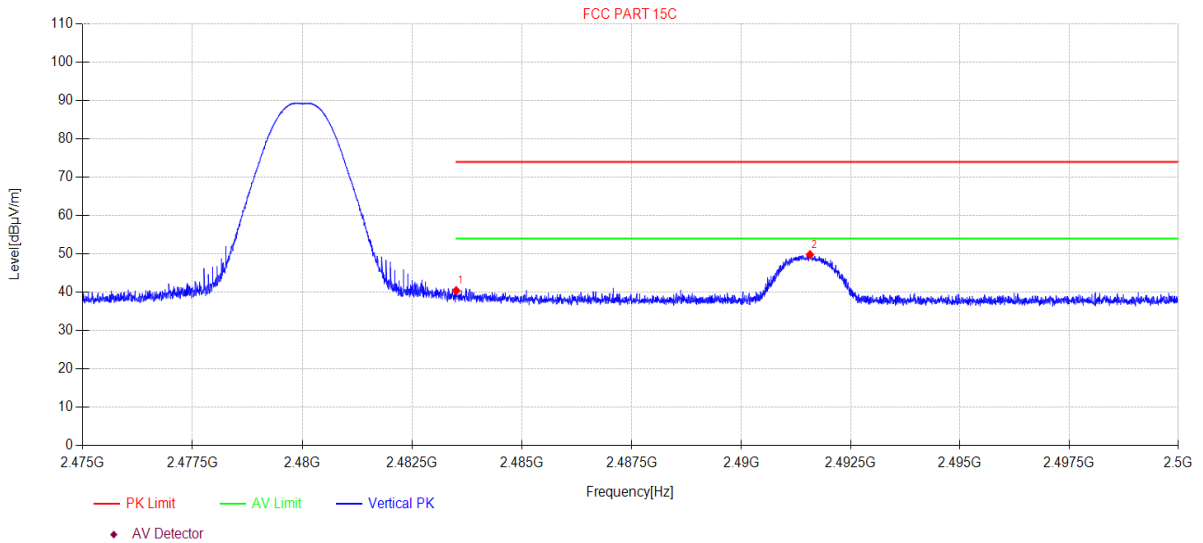

Suspected Data List										
NO	Freq. [MHz]	Reading [dBµV/m]	Cable loss [dB]	Antenna Factor [dB]	AMP [dB]	Level [dBµV/m]	Limit [dBµV/m]	Margin [dB]	Detector	Polarity
1	2483.50	48.99	3.94	27.73	-40.23	40.43	74.00	33.57	PK	Vertical
2	2491.57	58.35	3.94	27.77	-40.24	49.82	74.00	24.18	PK	Vertical

Note:

1. Level = Reading + Cable loss + Antenna Factor + AMP
2. If Peak Result complies with AV limit, AV Result is deemed to comply with AV limit.
3. Test setup: RBW: 1 MHz, VBW: 3 MHz, Sweep time: auto.

TR-4-E-009 Radiated Emission Test Result

Test Date: 2023-07-29 **Tested By:** Bairong
EUT: 3.1CH Soundbar with Virtual Dolby Atmos and Wireless Subwoofer **Model Number:** CINEMA SB580
Test Mode: Tx mode **Power Supply:** AC 120V/60Hz
Condition: Temp:21.7°C;Humi:64.9% **Test Site:** DDT 3# Chamber
File Path: d:\ts\2023 report data\Q23071316-2E SB580\FCC ABOVE 1G\13
Memo: 2DH5 2402

Test Graph

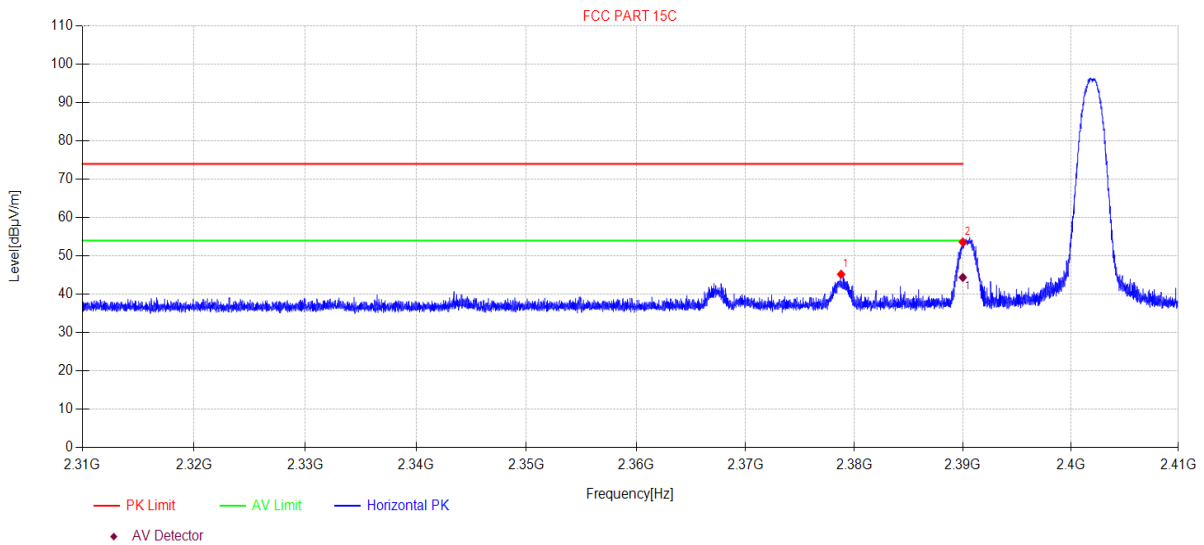

Suspected Data List										
NO	Freq. [MHz]	Reading [dBµV/m]	Cable loss [dB]	Antenna Factor [dB]	AMP [dB]	Level [dBµV/m]	Limit [dBµV/m]	Margin [dB]	Detector	Polarity
1	2378.78	54.02	3.86	27.46	-40.12	45.22	74.00	28.78	PK	Horizontal
2	2390.00	62.39	3.87	27.48	-40.13	53.61	74.00	20.39	PK	Horizontal

Final Data List										
NO	Freq. [MHz]	Reading [dBµV/m]	Cable loss [dB]	Antenna Factor [dB]	AMP [dB]	Level [dBµV/m]	Limit [dBµV/m]	Margin [dB]	Detector	Polarity
1	2390.00	53.18	3.87	27.48	-40.13	44.40	54.00	9.60	AV	Horizontal

Note:

1. Level = Reading + Cable loss + Antenna Factor + AMP
2. If Peak Result complies with AV limit, AV Result is deemed to comply with AV limit.
3. Test setup: RBW: 1 MHz, VBW: 3 MHz, Sweep time: auto.

TR-4-E-009 Radiated Emission Test Result

Test Date: 2023-07-29 **Tested By:** Bairong
EUT: 3.1CH Soundbar with Virtual Dolby Atmos and Wireless Subwoofer **Model Number:** CINEMA SB580
Test Mode: Tx mode **Power Supply:** AC 120V/60Hz
Condition: Temp:21.7°C;Humi:64.9% **Test Site:** DDT 3# Chamber
File Path: d:\ts\2023 report data\Q23071316-2E SB580\FCC ABOVE 1G\14
Memo: 2DH5 2402

Test Graph

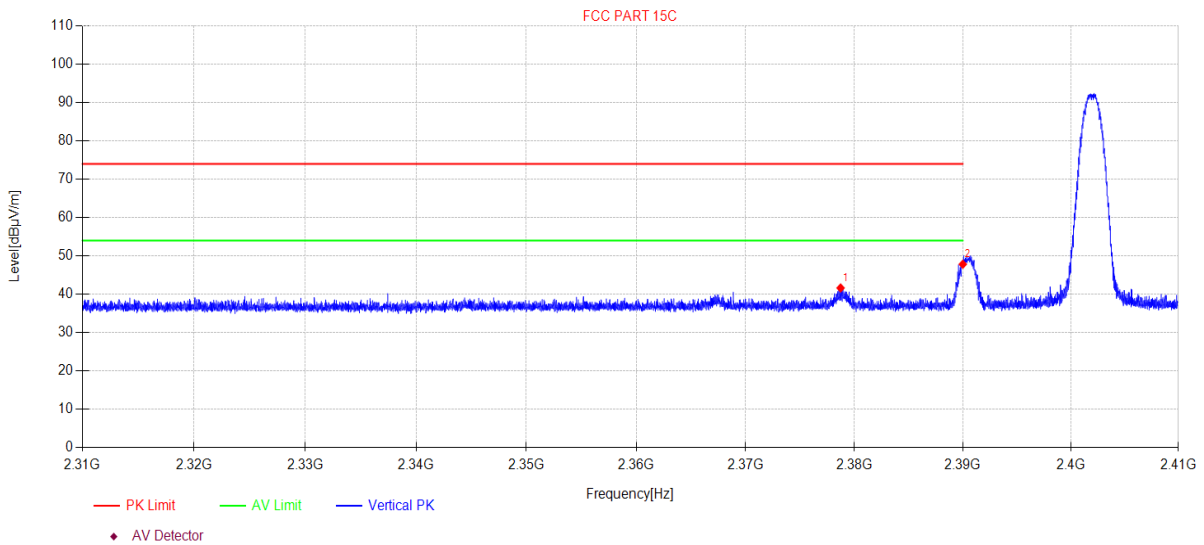

Suspected Data List										
NO	Freq. [MHz]	Reading [dBµV/m]	Cable loss [dB]	Antenna Factor [dB]	AMP [dB]	Level [dBµV/m]	Limit [dBµV/m]	Margin [dB]	Detector	Polarity
1	2378.73	50.45	3.86	27.46	-40.12	41.65	74.00	32.35	PK	Vertical
2	2390.00	56.62	3.87	27.48	-40.13	47.84	74.00	26.16	PK	Vertical

Note:

1. Level = Reading + Cable loss + Antenna Factor + AMP
2. If Peak Result complies with AV limit, AV Result is deemed to comply with AV limit.
3. Test setup: RBW: 1 MHz, VBW: 3 MHz, Sweep time: auto.

TR-4-E-009 Radiated Emission Test Result

Test Date: 2023-07-29 **Tested By:** Bairong
EUT: 3.1CH Soundbar with Virtual Dolby Atmos and Wireless Subwoofer **Model Number:** CINEMA SB580
Test Mode: Tx mode **Power Supply:** AC 120V/60Hz
Condition: Temp:21.7°C;Humi:64.9% **Test Site:** DDT 3# Chamber
File Path: d:\ts\2023 report data\Q23071316-2E SB580\FCC ABOVE 1G\19
Memo: 2DH5 2480

Test Graph

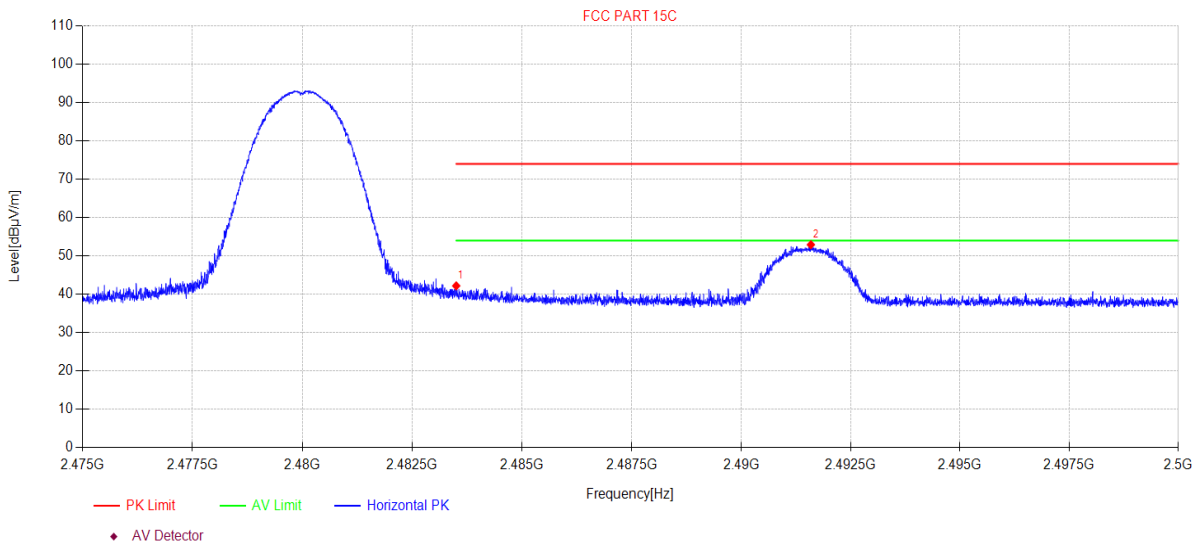

Suspected Data List										
NO	Freq. [MHz]	Reading [dBµV/m]	Cable loss [dB]	Antenna Factor [dB]	AMP [dB]	Level [dBµV/m]	Limit [dBµV/m]	Margin [dB]	Detector	Polarity
1	2483.50	50.76	3.94	27.73	-40.23	42.20	74.00	31.80	PK	Horizontal
2	2491.59	61.45	3.94	27.77	-40.24	52.92	74.00	21.08	PK	Horizontal

Note:

- Level = Reading + Cable loss + Antenna Factor + AMP
- If Peak Result complies with AV limit, AV Result is deemed to comply with AV limit.
- Test setup: RBW: 1 MHz, VBW: 3 MHz, Sweep time: auto.

TR-4-E-009 Radiated Emission Test Result

Test Date: 2023-07-29 **Tested By:** Bairong
EUT: 3.1CH Soundbar with Virtual Dolby Atmos and Wireless Subwoofer **Model Number:** CINEMA SB580
Test Mode: Tx mode **Power Supply:** AC 120V/60Hz
Condition: Temp:21.7°C;Humi:64.9% **Test Site:** DDT 3# Chamber
File Path: d:\ts\2023 report data\Q23071316-2E SB580\FCC ABOVE 1G\20
Memo: 2DH5 2480

Test Graph

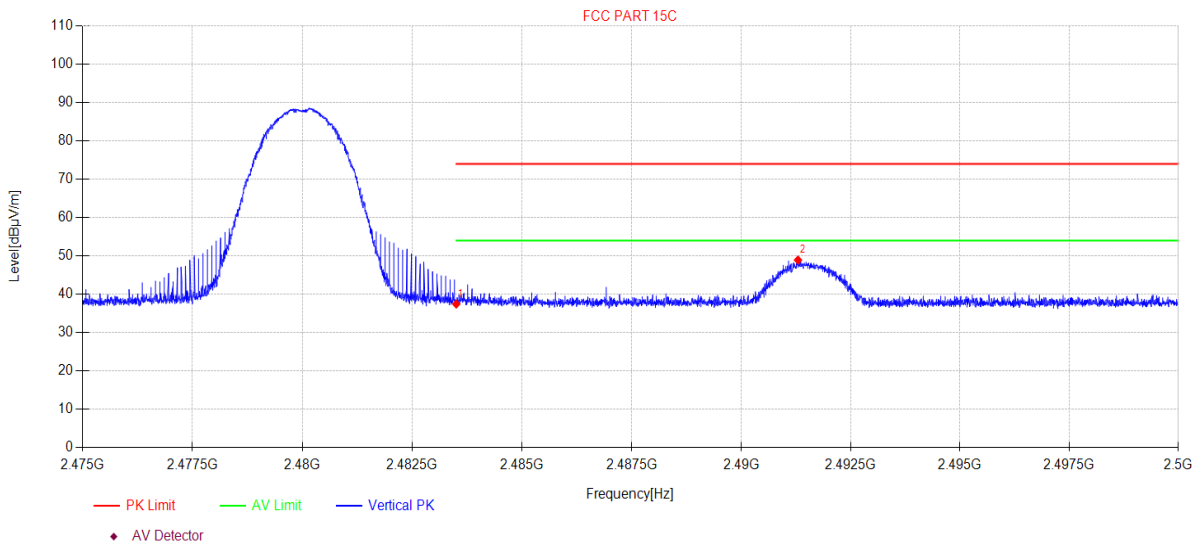

Suspected Data List										
NO	Freq. [MHz]	Reading [dBµV/m]	Cable loss [dB]	Antenna Factor [dB]	AMP [dB]	Level [dBµV/m]	Limit [dBµV/m]	Margin [dB]	Detector	Polarity
1	2483.50	46.02	3.94	27.73	-40.23	37.46	74.00	36.54	PK	Vertical
2	2491.30	57.46	3.94	27.77	-40.24	48.93	74.00	25.07	PK	Vertical

Note:

- Level = Reading + Cable loss + Antenna Factor + AMP
- If Peak Result complies with AV limit, AV Result is deemed to comply with AV limit.
- Test setup: RBW: 1 MHz, VBW: 3 MHz, Sweep time: auto.

TR-4-E-009 Radiated Emission Test Result

Test Date: 2023-07-29 **Tested By:** Bairong
EUT: 3.1CH Soundbar with Virtual Dolby Atmos and Wireless Subwoofer **Model Number:** CINEMA SB580
Test Mode: Tx mode **Power Supply:** AC 120V/60Hz
Condition: Temp:21.7°C;Humi:64.9% **Test Site:** DDT 3# Chamber
File Path: d:\ts\2023 report data\Q23071316-2E SB580\FCC ABOVE 1G\15
Memo: 3DH5 2402

Test Graph

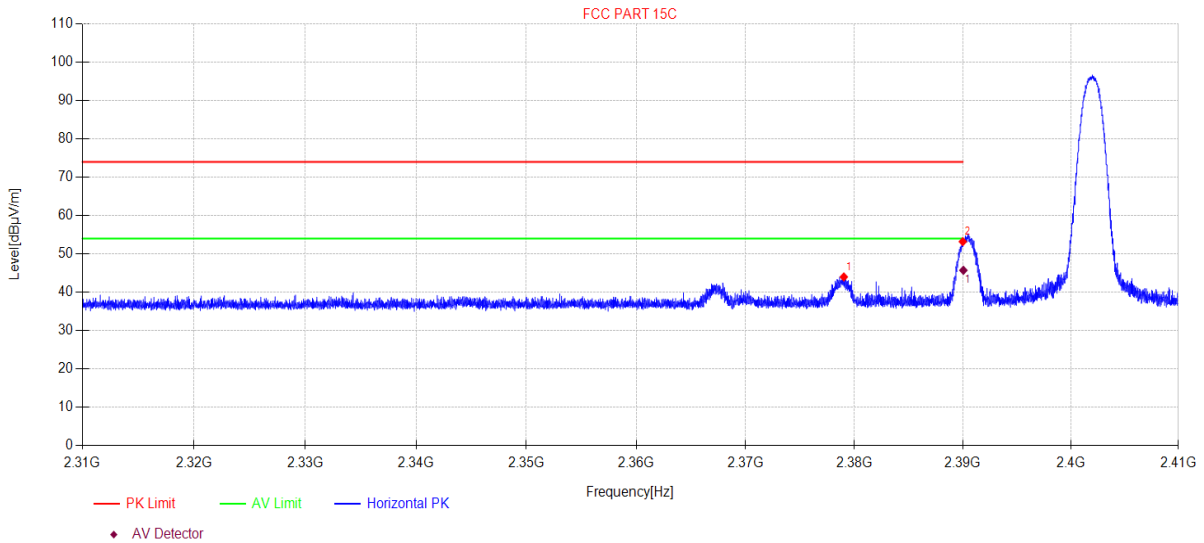

Suspected Data List										
NO	Freq. [MHz]	Reading [dBµV/m]	Cable loss [dB]	Antenna Factor [dB]	AMP [dB]	Level [dBµV/m]	Limit [dBµV/m]	Margin [dB]	Detector	Polarity
1	2379.03	52.80	3.86	27.46	-40.12	44.00	74.00	30.00	PK	Horizontal
2	2390.00	61.99	3.87	27.48	-40.13	53.21	74.00	20.79	PK	Horizontal

Final Data List										
NO	Freq. [MHz]	Reading [dBµV/m]	Cable loss [dB]	Antenna Factor [dB]	AMP [dB]	Level [dBµV/m]	Limit [dBµV/m]	Margin [dB]	Detector	Polarity
1	2390.05	52.48	5.90	27.48	-40.13	45.73	51.97	6.24	AV	Horizontal

Note:

1. Level = Reading + Cable loss + Antenna Factor + AMP
2. If Peak Result complies with AV limit, AV Result is deemed to comply with AV limit.
3. Test setup: RBW: 1 MHz, VBW: 3 MHz, Sweep time: auto.

TR-4-E-009 Radiated Emission Test Result

Test Date: 2023-07-29 **Tested By:** Bairong
EUT: 3.1CH Soundbar with Virtual Dolby Atmos and Wireless Subwoofer **Model Number:** CINEMA SB580
Test Mode: Tx mode **Power Supply:** AC 120V/60Hz
Condition: Temp:21.7°C;Humi:64.9% **Test Site:** DDT 3# Chamber
File Path: d:\ts\2023 report data\Q23071316-2E SB580\FCC ABOVE 1G\16
Memo: 3DH5 2402

Test Graph

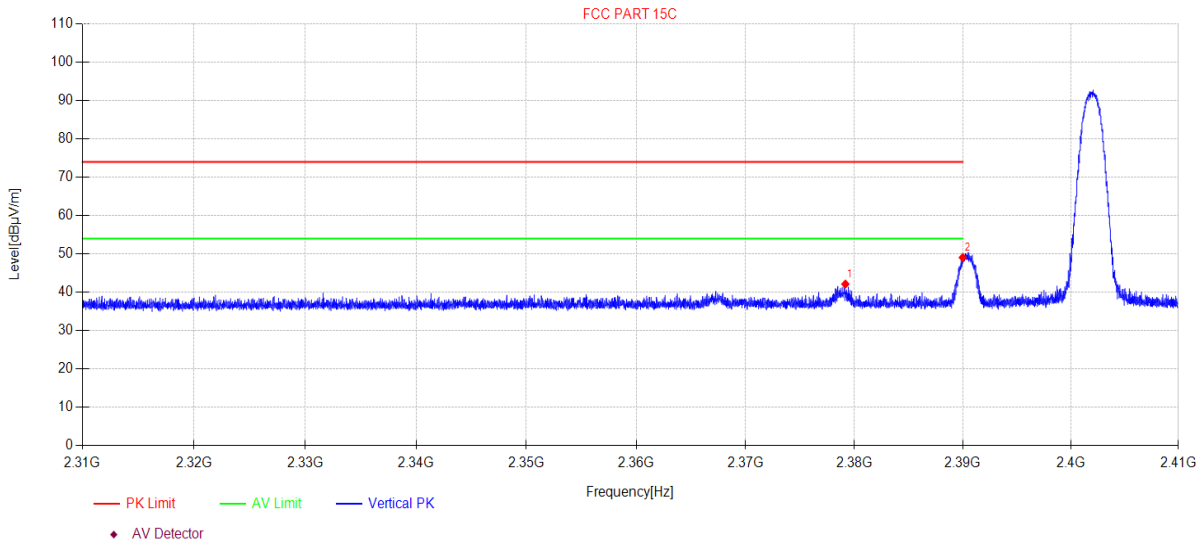

Suspected Data List										
NO	Freq. [MHz]	Reading [dBµV/m]	Cable loss [dB]	Antenna Factor [dB]	AMP [dB]	Level [dBµV/m]	Limit [dBµV/m]	Margin [dB]	Detector	Polarity
1	2379.17	50.94	3.86	27.46	-40.12	42.14	74.00	31.86	PK	Vertical
2	2390.00	57.84	3.87	27.48	-40.13	49.06	74.00	24.94	PK	Vertical

Note:

1. Level = Reading + Cable loss + Antenna Factor + AMP
2. If Peak Result complies with AV limit, AV Result is deemed to comply with AV limit.
3. Test setup: RBW: 1 MHz, VBW: 3 MHz, Sweep time: auto.

TR-4-E-009 Radiated Emission Test Result

Test Date: 2023-07-29 **Tested By:** Bairong
EUT: 3.1CH Soundbar with Virtual Dolby Atmos and Wireless Subwoofer **Model Number:** CINEMA SB580
Test Mode: Tx mode **Power Supply:** AC 120V/60Hz
Condition: Temp:21.7°C;Humi:64.9% **Test Site:** DDT 3# Chamber
File Path: d:\ts\2023 report data\Q23071316-2E SB580\FCC ABOVE 1G\21
Memo: 3DH5 2480

Test Graph

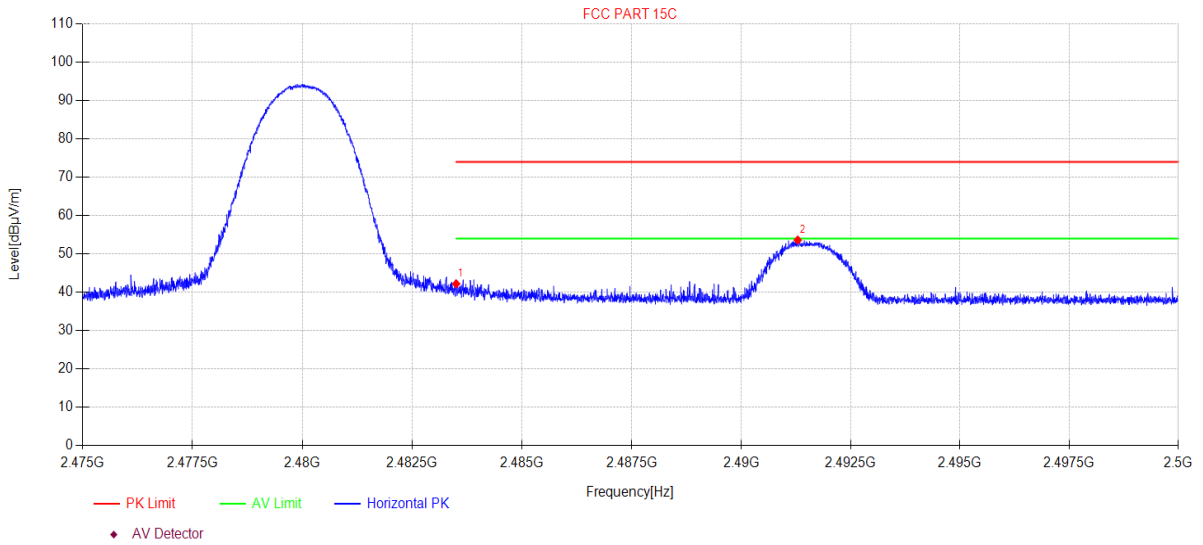

Suspected Data List										
NO	Freq. [MHz]	Reading [dBµV/m]	Cable loss [dB]	Antenna Factor [dB]	AMP [dB]	Level [dBµV/m]	Limit [dBµV/m]	Margin [dB]	Detector	Polarity
1	2483.50	50.76	3.94	27.73	-40.23	42.20	74.00	31.80	PK	Horizontal
2	2491.29	62.15	3.94	27.77	-40.24	53.62	74.00	20.38	PK	Horizontal

Note:

1. Level = Reading + Cable loss + Antenna Factor + AMP
2. If Peak Result complies with AV limit, AV Result is deemed to comply with AV limit.
3. Test setup: RBW: 1 MHz, VBW: 3 MHz, Sweep time: auto.

TR-4-E-009 Radiated Emission Test Result

Test Date: 2023-07-29 **Tested By:** Bairong
EUT: 3.1CH Soundbar with Virtual Dolby Atmos and Wireless Subwoofer **Model Number:** CINEMA SB580
Test Mode: Tx mode **Power Supply:** AC 120V/60Hz
Condition: Temp:21.7°C;Humi:64.9% **Test Site:** DDT 3# Chamber
File Path: d:\ts\2023 report data\Q23071316-2E SB580\FCC ABOVE 1G\22
Memo: 3DH5 2480

Test Graph

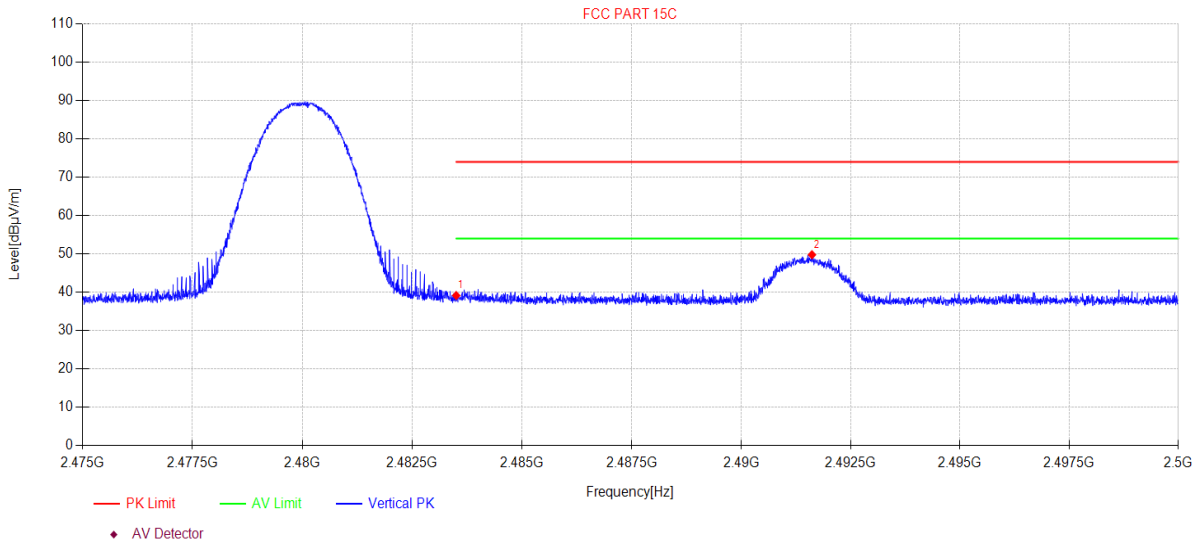

Suspected Data List										
NO	Freq. [MHz]	Reading [dBμV/m]	Cable loss [dB]	Antenna Factor [dB]	AMP [dB]	Level [dBμV/m]	Limit [dBμV/m]	Margin [dB]	Detector	Polarity
1	2483.50	47.72	3.94	27.73	-40.23	39.16	74.00	34.84	PK	Vertical
2	2491.62	58.32	3.94	27.77	-40.24	49.79	74.00	24.21	PK	Vertical

Note:

1. Level = Reading + Cable loss + Antenna Factor + AMP
2. If Peak Result complies with AV limit, AV Result is deemed to comply with AV limit.
3. Test setup: RBW: 1 MHz, VBW: 3 MHz, Sweep time: auto.

15. Power Line Conducted Emission

15.1. Block diagram of test setup

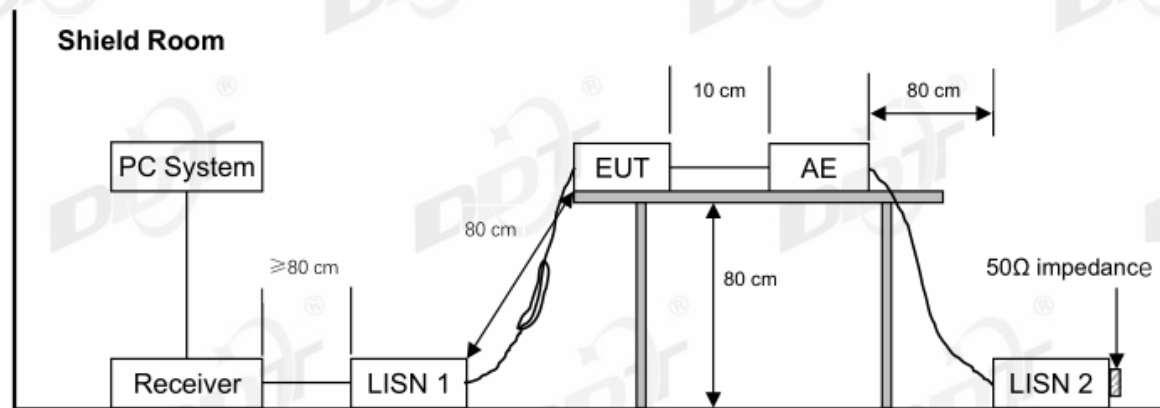

15.2. Power line conducted emission limits

Frequency	Quasi-Peak Level dB(μ V)	Average Level dB(μ V)
150 kHz ~ 500 kHz	66 ~ 56*	56 ~ 46*
500 kHz ~ 5 MHz	56	46
5 MHz ~ 30 MHz	60	50

Note 1: * Decreasing linearly with logarithm of frequency.

Note 2: The lower limit shall apply at the transition frequencies.

15.3. Test procedure

The EUT and Support equipment, if needed, were put placed on a non-metallic table, 80cm above the ground plane.

All support equipment power received from a second LISN.

Emissions were measured on each current carrying line of the EUT using an EMI Test Receiver connected to the LISN powering the EUT.

The Receiver scanned from 150 kHz to 30 MHz for emissions in each of the test modes.

During the above scans, the emissions were maximized by cable manipulation.

The test mode(s) described in clause 2.4 were scanned during the preliminary test.

After the preliminary scan, we found the test mode producing the highest emission level.

The EUT configuration and worse cable configuration of the above highest emission levels were recorded for reference of the final test.

EUT and support equipment were set up on the test bench as per the configuration with highest emission level in the preliminary test.

A scan was taken on both power lines, Neutral and Line, recording at least the six highest

emissions.

Emission frequency and amplitude were recorded into a computer in which correction factors were used to calculate the emission level and compare reading to the applicable limit.

The test data of the worst-case condition(s) was recorded.

The bandwidth of test receiver is set at 9 kHz.

15.4. Test result

Pass. (See below detailed test result)

Note1: All emissions not reported below are too low against the prescribed limits.

Note2: “----” means Peak detection; “- - - -” means Average detection.

Note3: Pre-test AC conducted emission at both voltage AC 120V/60Hz and AC 240V/50Hz, recorded the worst case.

TR-4-E-010 Conducted Emission Test Result

Test Site : DDT 5# Shield Room D:\2023 report data\Q23071316-2E\FCC CE.EM6
Test Date : 2023-08-02 **Tested By** : Junchang Du
EUT : 3.1CH Soundbar with Virtual Dolby Atmos and Wireless Subwoofer **Model Number** : CINEMA SB580
Power Supply : AC 120V/60Hz **Test Mode** : Tx mode
Condition : Temp:21.6°C,Humi:58.6% **LISN** : 2022 ENV216 2#/NEUTRAL

Memo :

Data: 6

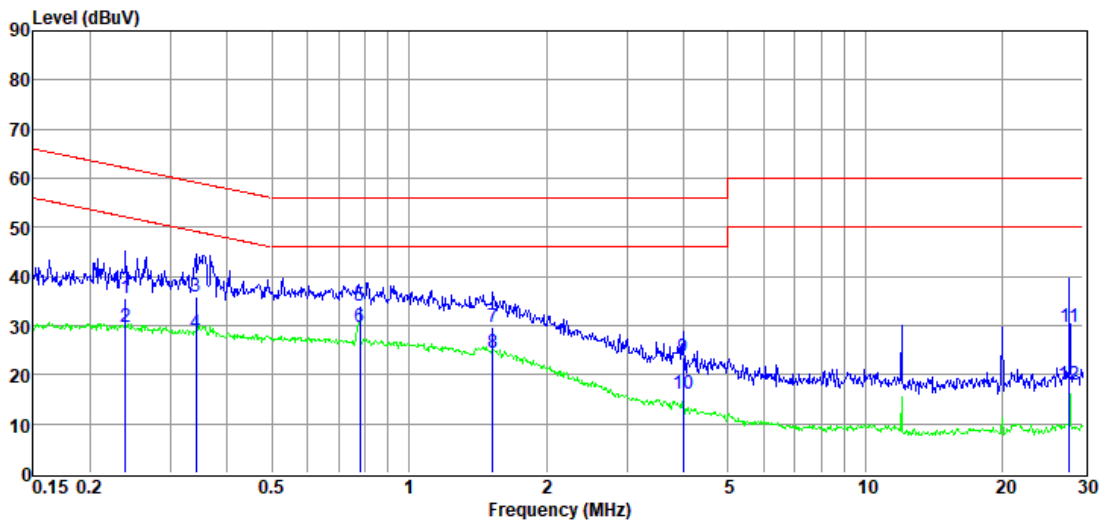

Item (Mark)	Freq. (MHz)	Read Level (dBuV)	LISN Factor (dB)	Cable Loss (dB)	Pulse Limiter Factor (dB)	Result Level (dBuV)	Limit Line (dBuV)	Over Limit (dB)	Detector	Phase
1	0.24	15.57	9.80	0.21	10.13	35.71	62.13	-26.42	QP	NEUTRAL
2	0.24	9.46	9.80	0.21	10.13	29.60	52.13	-22.53	Average	NEUTRAL
3	0.34	15.62	9.80	0.24	10.09	35.75	59.18	-23.43	QP	NEUTRAL
4	0.34	8.18	9.80	0.24	10.09	28.31	49.18	-20.87	Average	NEUTRAL
5	0.78	14.12	9.83	0.28	9.94	34.17	56.00	-21.83	QP	NEUTRAL
6	0.78	9.70	9.83	0.28	9.94	29.75	46.00	-16.25	Average	NEUTRAL
7	1.53	9.72	9.84	0.35	9.79	29.70	56.00	-26.30	QP	NEUTRAL
8	1.53	4.53	9.84	0.35	9.79	24.51	46.00	-21.49	Average	NEUTRAL
9	3.99	3.48	9.80	0.36	9.93	23.57	56.00	-32.43	QP	NEUTRAL
10	3.99	-4.11	9.80	0.36	9.93	15.98	46.00	-30.02	Average	NEUTRAL
11	28.00	9.30	9.95	0.42	9.95	29.62	60.00	-30.38	QP	NEUTRAL
12	28.00	-2.35	9.95	0.42	9.95	17.97	50.00	-32.03	Average	NEUTRAL

- Note: 1. Result Level = Read Level + LISN Factor + Pulse Limiter Factor + Cable loss.
 2. If QP Result complies with AV limit, AV Result is deemed to comply with AV limit.
 3. Test setup: RBW: 200 Hz (9 kHz—150 kHz), 9 kHz (150 kHz—30 MHz).
 4. Step size: 80Hz (0.009MHz-0.15MHz), 4 kHz (0.15MHz-30MHz), Scan time: auto.

TR-4-E-010 Conducted Emission Test Result

Test Site : DDT 5# Shield Room D:\2023 report data\Q23071316-2E\FCC CE.EM6
Test Date : 2023-08-02 **Tested By** : Junchang Du
EUT : 3.1CH Soundbar with Virtual Dolby Atmos and Wireless Subwoofer **Model Number** : CINEMA SB580
Power Supply : AC 120V/60Hz **Test Mode** : Tx mode
Condition : Temp:21.6°C,Humi:58.6% **LISN** : 2022 ENV216 2#/LINE

Memo :

Data: 8

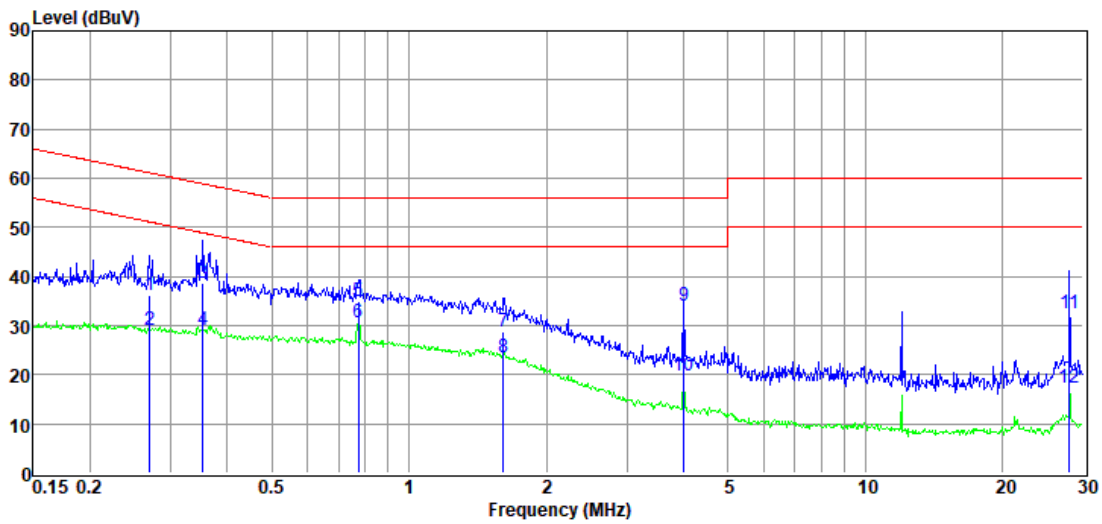

Item (Mark)	Freq. (MHz)	Read Level (dBuV)	LISN Factor (dB)	Cable Loss (dB)	Pulse Limiter Factor (dB)	Result Level (dBuV)	Limit Line (dBuV)	Over Limit (dB)	Detector	Phase
1	0.27	15.94	9.80	0.23	10.12	36.09	61.12	-25.03	QP	LINE
2	0.27	8.85	9.80	0.23	10.12	29.00	51.12	-22.12	Average	LINE
3	0.35	18.43	9.80	0.24	10.09	38.56	58.87	-20.31	QP	LINE
4	0.35	8.87	9.80	0.24	10.09	29.00	48.87	-19.87	Average	LINE
5	0.78	14.96	9.77	0.28	9.94	34.95	56.00	-21.05	QP	LINE
6	0.78	10.55	9.77	0.28	9.94	30.54	46.00	-15.46	Average	LINE
7	1.61	9.28	9.49	0.35	9.78	28.90	56.00	-27.10	QP	LINE
8	1.61	3.89	9.49	0.35	9.78	23.51	46.00	-22.49	Average	LINE
9	4.01	14.29	9.30	0.36	9.93	33.88	56.00	-22.12	QP	LINE
10	4.01	0.33	9.30	0.36	9.93	19.92	46.00	-26.08	Average	LINE
11	28.00	12.51	9.67	0.42	9.95	32.55	60.00	-27.45	QP	LINE
12	28.00	-2.78	9.67	0.42	9.95	17.26	50.00	-32.74	Average	LINE

- Note:
1. Result Level = Read Level + LISN Factor + Pulse Limiter Factor + Cable loss.
 2. If QP Result complies with AV limit, AV Result is deemed to comply with AV limit.
 3. Test setup: RBW: 200 Hz (9 kHz—150 kHz), 9 kHz (150 kHz—30 MHz).
 4. Step size: 80Hz (0.009MHz-0.15MHz), 4 kHz (0.15MHz-30MHz), Scan time: auto.

16. Antenna Requirements

16.1. Limit

For intentional device, according to FCC 47 CFR Section 15.203, an intentional radiator shall be designed to ensure that no antenna other than that furnished by the responsible party shall be used with the device. And according to FCC 47 CFR Section 15.247 (b), if transmitting antennas of directional gain greater than 6 dBi are used, the power shall be reduced by the amount in dB that the directional gain of the antenna exceeds 6 dBi.

For intentional device, according to RSS-Gen issue 5 section 6.8.

The applicant for equipment certification shall provide a list of all antenna types that may be used with the transmitter, where applicable (i.e. for transmitters with detachable antenna), indicating the maximum permissible antenna gain (in dBi) and the required impedance for each antenna. The test report shall demonstrate the compliance of the transmitter with the limit for maximum equivalent isotropically radiated power (e.i.r.p.) specified in the applicable RSS, when the transmitter is equipped with any antenna type, selected from this list.

16.2. Result

The antenna used for this product is FPC antenna and that no antenna other than that furnished by the responsible party shall be used with the device, the maximum peak gain of the transmit antenna is 2.34 dBi.

18. Photos of the EUT

Please refer to appendix I.

END OF REPORT