

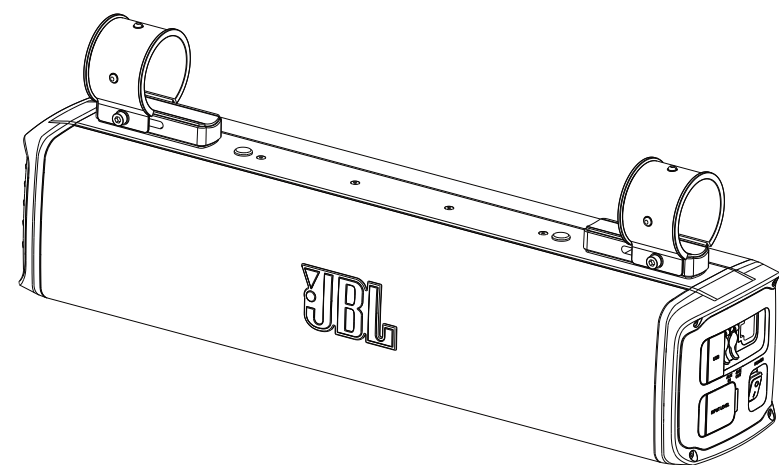

JBL RALLYBAR S/RALLYBAR/ RALLYBAR XL



Quick Start Guide

Guide de démarrage rapide

Guía de inicio rápido

EN

FR

ES



www.jbl.com

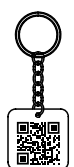

OWNER'S
MANUAL

EN Before using this product, read the safety sheet carefully.

FR Avant d'utiliser ce produit, lisez attentivement la fiche de sécurité.

DA Læs sikkerhedsarket omhyggeligt, før du bruger dette produkt.

DE Lies vor der Verwendung dieses Produkts das Sicherheitsdatenblatt sorgfältig durch.

ES Antes de usar este producto, lee la hoja de seguridad atentamente.

FI Lue käyttöohje ja turvallisuustiedote huolellisesti ennen tuotteen käyttöä.

IT Prima di utilizzare questo prodotto, leggere attentamente la scheda di sicurezza.

NL Lees eerst het veiligheidsblad voordat je dit product gebruikt.

NO Les sikkerhetsarket nøye før du bruker dette produktet.

PT-BR Antes de usar este produto, leia cuidadosamente a ficha de segurança.

SV Läs alltid noga igenom säkerhetsdatabladet innan du använder den här produkten.

ZH-CN 使用本产品前，请仔细阅读安全说明书。

ID Sebelum menggunakan produk ini, bacalah lembar panduan keselamatan dengan cermat.

1. WHAT'S IN THE BOX / CONTENU DE LA BOÎTE / CONTENIDO DE LA CAJA

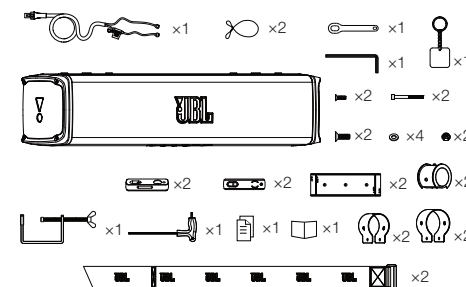

2. DIMENSIONS / DIMENSIONS / DIMENSIONES

RALLYBAR / RALLYBAR S

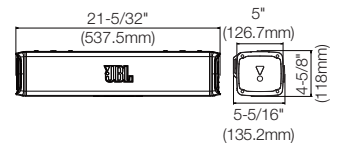

RALLYBAR XL

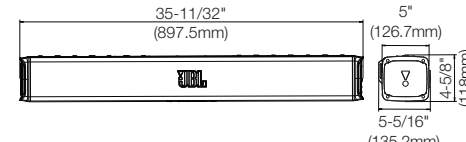

3. MOUNTING / MONTAGE / MONTAJE

1) Top mount view / Vue de dessus / Vista de montaje superior

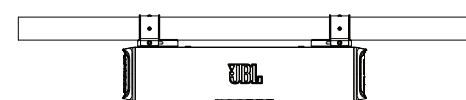

2) Back mount view / Vue du montage arrière / Vista de montaje posterior

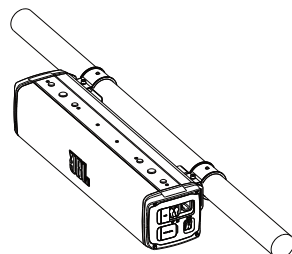

Step 1-Choose Cleat Mount options on soundbar. / Étape 1 - Choisissez les options de montage des taquets sur la barre de son. / Paso 1: Elige las opciones de montaje de tacos en la barra de sonido.

Note: There are 4 (RALLYBAR & RALLYBAR S), or 8 (RALLYBAR XL) mounting positions for left cleat and right cleat;

Remarque : Il y a 4 (RALLYBAR & RALLYBAR S), ou 8 (RALLYBAR XL) positions de montage des taquets gauche et droit.

Nota: Hay 4 (RALLYBAR & RALLYBAR S) o 8 (RALLYBAR XL) posiciones de montaje para los tacos izquierdo y derecho;

RALLYBAR&RALLYBAR S

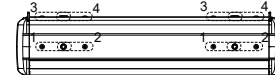

RALLYBAR XL

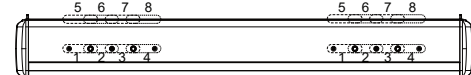

Step 2-Put cleat on soundbar / Étape 2 - Montez les taquets sur la barre de son. / Paso 2: Coloca tacos en la barra de sonido

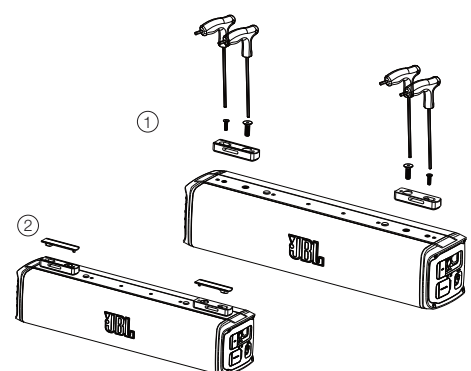

Step 3-Choose C-Clamp Size and Rubber. / Étape 3 - Choisissez la taille de la pince et le caoutchouc. / Paso 3: Elige el tamaño de la abrazadera en C y la goma.

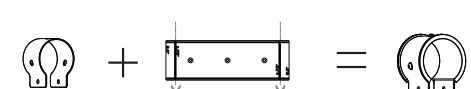
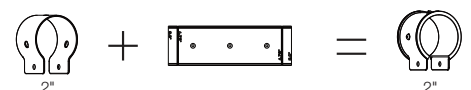

Step 4 -Mount soundbar on the pole. / Étape 4 - Montez la barre de son sur le tube. / Paso 4: Monta la barra de sonido en el mástil.

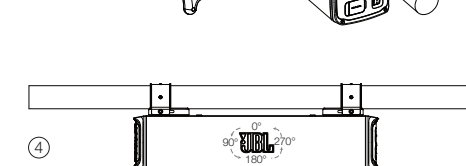
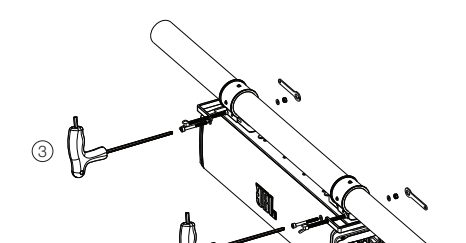
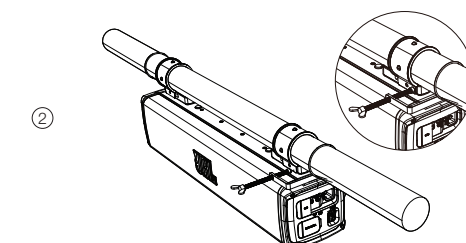
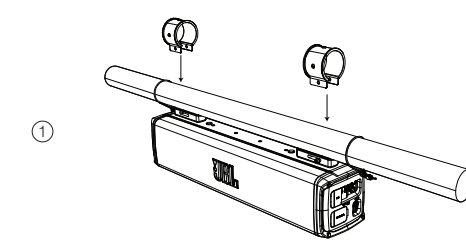

Note: JBL Logo badge is rotatable.

Remarque : Le badge du logo JBL peut tourner.

Nota: La insignia con el logotipo de JBL se puede girar.

Step 5-Safety Cable / Étape 5 - Câble de sécurité / Paso 5: Cable de seguridad

Loose the safety cable screws.
Desserrer les vis du câble de sécurité.
Afloja los tornillos del cable de seguridad

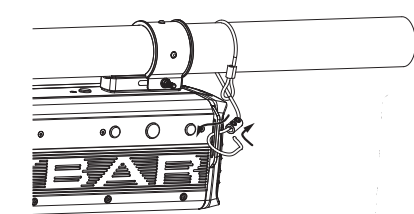

Tight the safety cable screws.
Serrer les vis du câble de sécurité.
Aprieta los tornillos del cable de seguridad.

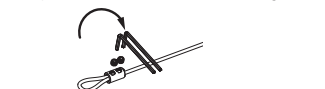

Note: Before using the hex wrench to tighten the cable, please make sure the distance is over 2\"/>

Remarque : Avant de serrer le câble avec la clé hexagonale, vérifiez que la distance depuis l'extrémité du câble est supérieure à 50 mm (2\"/>

Nota: Antes de usar la llave hexagonal para apretar el cable, asegúrate de que la distancia sea superior a 50 mm desde el extremo del cable.

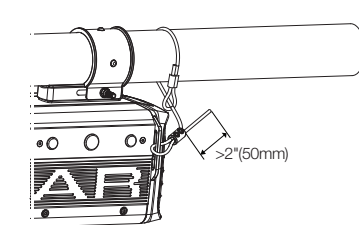

4. WIRING AND POWERING ON / CÂBLAGE ET MISE SOUS TENSION / CABLEADO Y ENCENDIDO

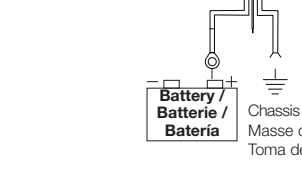
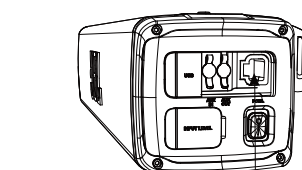

Battery / Batterie / Bateria
Chassis ground (-) /
Masse du châssis (-) /
Toma de tierra del chasis (-)

Main power switch / Commutateur d'alimentation / Conmutador principal de alimentación

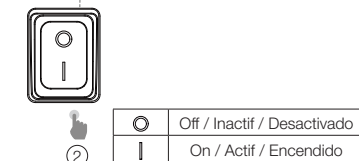

Power button / Bouton d'alimentation / Botón de encendido/apagado

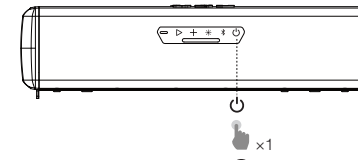

● Off / Inactif / Desactivado	Main power switch is off / Le commutateur d'alimentation est sur arrêt (off) / El conmutador principal de alimentación está desactivado
☀ White (Flashing) / Blanc (clignotant) / Blanco (parpadeante)	Main power switch is on / Le commutateur d'alimentation est sur marche (on) / El conmutador principal de alimentación está activado
○ White (Constant) / Blanc (fixe) / Blanco (constante)	Operation mode on / En fonctionnement / Modo de funcionamiento activado

5. BLUETOOTH CONNECTION / CONNEXION BLUETOOTH / CONEXIÓN BLUETOOTH

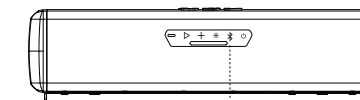

6. USB DISK CONNECTION / CONNEXION D'UNE CLÉ USB / CONEXIÓN DE DISCO USB

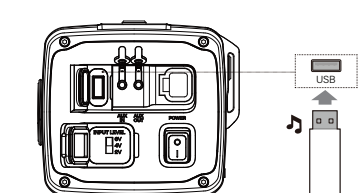

7. AUX-IN & AUX OUT CONNECTION / CONNEXIONS AUX-IN ET AUX OUT / CONEXIÓN AUX-IN Y AUX OUT

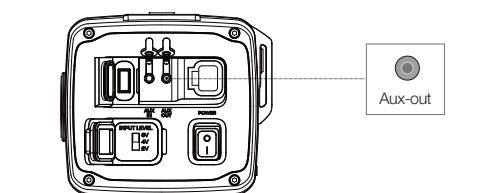
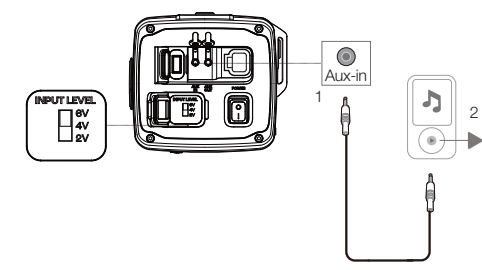

8. MUSIC CONTROL / COMMANDES DE LA MUSIQUE / CONTROL DE LA MÚSICA

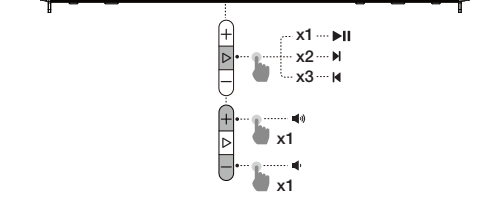
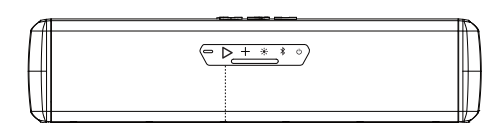

9. MAP LIGHT / LAMPE DE LECTURE / LUZ DE LECTURA

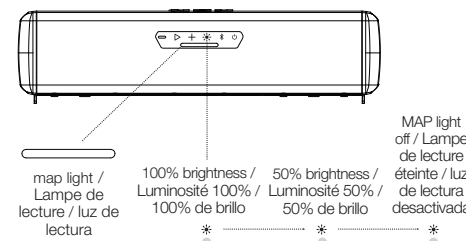

10. RGB LIGHT / ÉCLAIRAGE RVB / LUZ RGB

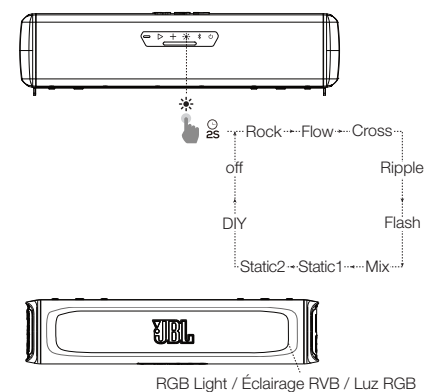

NOTE: Find out more detailed information about RGB Light Brightness Setting Mode and RGB Light DIY Setting Mode on Owner's manual.

REMARQUE : Le mode d'emploi contient des informations plus détaillées sur les réglage de la luminosité de l'éclairage RVB et la personnalisation de l'éclairage RVB.

NOTA: Para obtener información más detallada acerca del modo de ajuste del brillo de la luz RGB y el modo de ajuste manual de la luz RGB, consulte el manual del propietario.

Button / Bouton / Botón	Press / Appuyer / Pulsar	Behaviors / Comportements / Comportamientos
		9 Patterns Change: / Choix de 9 motifs: / Cambio de 9 patrones: Rock, Flow, Cross, Ripple, Flash, Mix, Static1, Static2, DIY, Off.
		Turn off RGB light Extinction de l'éclairage RVB Desactivar la luz RGB
		RGB Light DIY Setting Mode Personnalisation de l'éclairage RVB Modo de ajuste manual de la luz RGB
		RGB Light Brightness Setting Mode Réglage de la luminosité de l'éclairage RVB Modo de ajuste del brillo de la luz RGB

11. BROADCAST MODE / MODE DIFFUSION / MODO TRANSMISIÓN

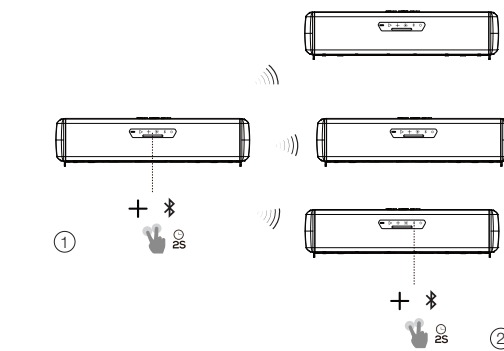

12. PARTY MODE / MODE FÊTE / MODO FIESTA

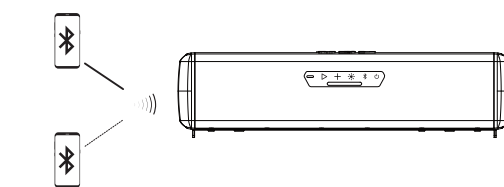

13. SPECIFICATION

	RALLYBAR	RALLYBAR S	RALLYBAR XL
Transducers:	4 x 2.75" (70mm) woofers; 2 x 1" (25mm) Tweeters; 2 x 7.2" (182.8mm) x 3" (76.2mm) Racetrack Passive Radiators	4 x 2.75" (70mm) woofers; 2 x 1" (25mm) Tweeters; 2 x 7.2" (182.8mm) x 3" (76.2mm) Racetrack Passive Radiators	8 x 2.75" (70mm) woofers; 2 x 1" (25mm) Tweeters; 4 x 7.2" (182.8mm) x 3" (76.2mm) Racetrack Passive Radiators
Output Power:	150WRMS; 300W PEAK (IEC60268)	300WRMS; 300W PEAK (IEC60268)	300WRMS; 600W PEAK (IEC60268)
THD at Rated RMS Power:	<1%	<1%	<1%
Voltage Range:	9 - 16VDC	9 - 16VDC	9 - 16VDC
Quiescent Current Draw:	<0.9A	<0.9A	<1.7A
Maximum Current Draw:	25A	25A	40A
Frequency response:	45Hz-40kHz	45Hz-40kHz	45Hz-40kHz
Signal-to-noise Ratio:	> 80 dB	> 80 dB	> 80 dB
Cable type:	12AWG.	12AWG.	10 AWG.
Cable length:	12 Feet (3.66m)	12 Feet (3.66m)	12 Feet (3.66m)
Bluetooth® Version:	5.3	5.3	5.3
Bluetooth® profile:	A2DP V1.3, AVRCP V1.6	A2DP V1.3, AVRCP V1.6	A2DP V1.3, AVRCP V1.6
Bluetooth® transmitter frequency range:	2400 MHz – 2483.5 MHz	2400 MHz – 2483.5 MHz	2400 MHz – 2483.5 MHz
Bluetooth® transmitter power:	≤ 15 dBm (EIRP)	≤ 15 dBm (EIRP)	≤ 15 dBm (EIRP)
Aux-In:	2Vrms (0.37Vrms - 2Vrms); 4Vrms (0.74Vrms - 4Vrms); 6Vrms (1.11Vrms - 6Vrms); (3.5 mm connector)	2Vrms (0.37Vrms - 2Vrms); 4Vrms (0.74Vrms - 4Vrms); 6Vrms (1.11Vrms - 6Vrms); (3.5 mm connector)	2Vrms (0.37Vrms - 2Vrms); 4Vrms (0.74Vrms - 4Vrms); 6Vrms (1.11Vrms - 6Vrms); (3.5 mm connector)
Aux-Out:	2 Vrms (3.5 mm connector)	2 Vrms (3.5 mm connector)	2 Vrms (3.5 mm connector)
USB Drive File System:	FAT32	FAT32	FAT32
USB Drive Maximum Capacity:	64GB	64GB	64GB
Soundbar Dimension (L x W x H):	21-5/32" x 4-5/8" x 5-5/16" (537.5 x 118 x 135.2mm)	21-5/32" x 4-5/8" x 5-5/16" (537.5 x 118 x 135.2mm)	35-11/32" x 4-5/8" x 5-5/16" (897.5 x 118 x 135.2mm)
Soundbar Weight:	11.57 lbs (5.25 kg)	11.46 lbs (5.2 kg)	20.83 lbs (9.45 kg)
Packaging dimensions (W x H x D):	24" x 7.6" x 9" (611 x 193 x 229mm)	24" x 7.6" x 9" (611 x 193 x 229mm)	38.2" x 7.6" x 9" (971 x 193 x 229mm)
Gross weight:	17.14 lbs (7.79 kg)	17 lbs (7.74 kg)	27.5 lbs (12.52 kg)
Maximum operation temperature	45 °C	45 °C	45 °C

13. SPÉCIFICATIONS

	RALLYBAR	RALLYBAR S	RALLYBAR XL
Transducteurs :	4 woofers de 70 mm (2,75"), 2 tweeters de 25 mm (1"), 2 radiateurs passifs oblongs de 182,8 mm (7,2") x 76,2 mm (3")	4 woofers de 70 mm (2,75"), 2 tweeters de 25 mm (1"), 2 radiateurs passifs oblongs de 182,8 mm (7,2") x 76,2 mm (3")	8 woofers de 70 mm (2,75"), 2 tweeters de 25 mm (1"), 4 radiateurs passifs oblongs de 182,8 mm (7,2") x 76,2 mm (3")
Puissance de sortie :	150 WRMS, 300 W CRÊTE (IEC60268)	150 WRMS, 300 W CRÊTE (IEC60268)	300 WRMS, 600 W CRÊTE (IEC60268)
DHT à la puissance RMS nominale :	< 1%	< 1%	< 1%
Plage de tension :	9-16 VCC	9-16 VCC	9-16 VCC
Intensité consommée au repos :	< 0,9 A	< 0,9 A	< 1,7 A
Intensité consommée maximale :	25 A	25 A	40 A
Réponse en fréquence :	45 Hz - 40 kHz	45 Hz - 40 kHz	45 Hz - 40 kHz
Rapport signal sur bruit :	> 80 dB	> 80 dB	> 80 dB
Type de câble :	12 AWG.	12 AWG.	10 AWG.
Longueur du câble :	3,66 m (12 pieds)	3,66 m (12 pieds)	3,66 m (12 pieds)
Version du Bluetooth® :	5.3	5.3	5.3
Profil Bluetooth® :	A2DP V1.3, AVRCP V1.6	A2DP V1.3, AVRCP V1.6	A2DP V1.3, AVRCP V1.6
Bande de fréquences de l'émetteur Bluetooth® :	2400 MHz – 2483,5 MHz	2400 MHz – 2483,5 MHz	2400 MHz – 2483,5 MHz

	RALLYBAR	RALLYBAR S	RALLYBAR XL
Puissance de l'émetteur Bluetooth® :	≤ 15 dBm (PIRE)	≤ 15 dBm (PIRE)	≤ 15 dBm (PIRE)
Entrée Aux :	2 Vrms (0,37 Vrms - 2 Vrms) ; 4 Vrms (0,74 Vrms - 4 Vrms) ; 6 Vrms (1,11 Vrms - 6 Vrms) ; (connecteur de 3,5 mm)	2 Vrms (0,37 Vrms - 2 Vrms) ; 4 Vrms (0,74 Vrms - 4 Vrms) ; 6 Vrms (1,11 Vrms - 6 Vrms) ; (connecteur de 3,5 mm)	2 Vrms (0,37 Vrms - 2 Vrms) ; 4 Vrms (0,74 Vrms - 4 Vrms) ; 6 Vrms (1,11 Vrms - 6 Vrms) ; (connecteur de 3,5 mm)
Aux-Out :	2 Vrms (connecteur de 3,5 mm)	2 Vrms (connecteur de 3,5 mm)	2 Vrms (connecteur de 3,5 mm)
Système de fichiers de clé USB :	FAT32	FAT32	FAT32
Capacité maximale de clé USB :	64 Go	64 Go	64 Go
Dimensions de la barre de son (L x l x H) :	21-5/32" x 4-5/8" x 5-5/16" (537,5 x 118 x 135,2mm)	21-5/32" x 4-5/8" x 5-5/16" (537,5 x 118 x 135,2mm)	35-11/32" x 4-5/8" x 5-5/16" (897,5 x 118 x 135,2mm)
Poids de la barre de son :	11,57 lbs (5,25 kg)	11,46 lbs (5,2 kg)	20,83 lbs (9,45 kg)
Dimensions de l'emballage (L x H x P) :	24" x 7,6" x 9" (611 x 193 x 229mm)	24" x 7,6" x 9" (611 x 193 x 229mm)	38,2" x 7,6" x 9" (971 x 193 x 229mm)
Poids brut :	17,14 lbs (7,79 kg)	17 lbs (7,74 kg)	27,5 lbs (12,52 kg)
Température de fonctionnement maximale	45°C	45°C	45°C

13. ESPECIFICACIÓN

	RALLYBAR	RALLYBAR S	RALLYBAR XL
Transductores:	4 altavoces de graves de 70 mm; 2 altavoces de agudos de 25 mm; 2 radiadores pasivos de tipo racetrack de 182,8 mm x 76,2 mm	4 altavoces de graves de 70 mm; 2 altavoces de agudos de 25 mm; 2 radiadores pasivos de tipo racetrack de 182,8 mm x 76,2 mm	8 altavoces de graves de 70 mm; 2 altavoces de agudos de 25 mm; 4 radiadores pasivos de tipo racetrack de 182,8 mm x 76,2 mm
Potencia de salida:	150 WRMS; 300 W MÁX. (IEC60268)	150 WRMS; 300 W MÁX. (IEC60268)	300 WRMS; 600 W MÁX. (IEC60268)
THD a potencia nominal de RMS:	<1%	<1%	<1%
Intervalo de tensión:	9-16 V CC	9-16 V CC	9-16 V CC
Consumo de corriente mínimo:	<0,9 A	<0,9 A	<1,7 A
Consumo de corriente máximo:	25 A	25 A	40 A
Respuesta de frecuencias:	45 Hz-40 kHz	45 Hz-40 kHz	45 Hz-40 kHz
Relación señal-ruido:	>80 dB	>80 dB	>80 dB
Tipo de cable:	12 AWG.	12 AWG.	10 AWG.
Longitud del cable:	3,66 m	3,66 m	3,66 m
Versión de Bluetooth®:	5.3	5.3	5.3
Perfil de Bluetooth®:	A2DP V1.3, AVRCP V1.6	A2DP V1.3, AVRCP V1.6	A2DP V1.3, AVRCP V1.6
Intervalo de frecuencias del transmisor Bluetooth®:	2400 MHz – 2483,5 MHz	2400 MHz – 2483,5 MHz	2400 MHz – 2483,5 MHz
Potencia del transmisor Bluetooth®:	≤15 dBm (EIRP)	≤15 dBm (EIRP)	≤15 dBm (EIRP)
Aux-In:	2 Vrms (0,37 Vrms-2 Vrms); 4 Vrms (0,74 Vrms - 4 Vrms); 6 Vrms (1,11 Vrms-6 Vrms); (conector de 3,5 mm)	2 Vrms (0,37 Vrms-2 Vrms); 4 Vrms (0,74 Vrms - 4 Vrms); 6 Vrms (1,11 Vrms-6 Vrms); (conector de 3,5 mm)	2 Vrms (0,37 Vrms-2 Vrms); 4 Vrms (0,74 Vrms - 4 Vrms); 6 Vrms (1,11 Vrms-6 Vrms); (conector de 3,5 mm)
Aux-Out:	2 Vrms (conector de 3,5 mm)	2 Vrms (conector de 3,5 mm)	2 Vrms (conector de 3,5 mm)
Sistema de archivos de la unidad USB:	FAT32	FAT32	FAT32
Capacidad máxima de la unidad USB:	64 GB	64 GB	64 GB
Dimensiones de la barra de sonido (L x An. x Al.):	537,5 x 118 x 135,2mm	537,5 x 118 x 135,2mm	897,5 x 118 x 135,2mm
Peso de la barra de sonido:	5,25 kg	5,2 kg	9,45 kg
Dimensiones del paquete (An. x Al. x Prof.):	611 x 193 x 229mm	611 x 193 x 229mm	971 x 193 x 229mm
Peso bruto:	7,79 kg	7,74 kg	12,52 kg
Temperatura máxima de funcionamiento	45°C	45°C	45°C



The Bluetooth® word mark and logos are registered trademarks owned by Bluetooth SIG, Inc. and any use of such marks by HARMAN International Industries, Incorporated is under license. Other trademarks and trade names are those of their respective owners.



* Rally bar S/Rally bar/Rally bar XL
** Rally bar XL

